

**CTI 2556 SIXTEEN CHANNEL
ISOLATED THERMOCOUPLE INPUT MODULE
INSTALLATION AND OPERATION GUIDE**

Version 2.6

CTI Part #062-00178-026



**Copyright © 2005 Control Technology Inc.
All rights reserved.**

This manual is published by Control Technology Inc., 5734 Middlebrook Pike, Knoxville, TN 37921. This manual contains references to brand and product names which are tradenames, trademarks, and/or registered trademarks of Control Technology Inc. Siemens® and SIMATIC® are registered trademarks of Siemens AG. Other references to brand and product names are tradenames, trademarks, and/or registered trademarks of their respective holders.

DOCUMENT DISCLAIMER STATEMENT

Every effort has been made to ensure the accuracy of this document; however, errors do occasionally occur. CTI provides this document on an "as is" basis and assumes no responsibility for direct or consequential damages resulting from the use of this document. This document is provided without express or implied warranty of any kind, including but not limited to the warranties of merchantability or fitness for a particular purpose. This document and the products it references are subject to change without notice. If you have a comment or discover an error, please call us toll-free at 1-800-537-8398.

PREFACE

This *Installation and Operation Guide* provides installation and operation instructions for the CTI 2556 Sixteen Channel Isolated Thermocouple Input Module for SIMATIC® 505 programmable controllers. We assume you are familiar with the operation of SIMATIC® Series 505 programmable controllers. Refer to the appropriate SIMATIC® user documentation for specific information on the SIMATIC® 505 programmable controllers and I/O modules.

This *Installation and Operation Guide* is organized as follows:

Chapter 1 provides a description of the module.

Chapter 2 covers installation and wiring.

Chapter 3 is a guide to troubleshooting.

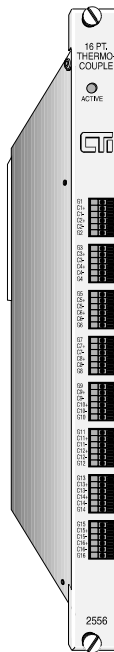

Figure 1 2556 16-Channel Isolated Thermocouple Input Module

USAGE CONVENTIONS

NOTE:

Notes alert the user to special features or procedures.

CAUTION:

Cautions alert the user to procedures which could damage equipment.

WARNING:

Warnings alert the user to procedures which could damage equipment and endanger the user.

TABLE OF CONTENTS

PREFACE	iii
USAGE CONVENTIONS	v
TABLE OF FIGURES	ix
CHAPTER 1. DESCRIPTION	1
1.1 Front Panel Description	1
1.1.1 Active LED	2
1.1.2 Input Terminals for Channels 1-16	2
1.2 Asynchronous Operation	2
1.2.1 Immediate I/O Compatibility	2
1.3 J, K, R, S, T, E, or L Thermocouples	2
1.4 Digital Word Map	2
1.5 Thermocouple Input to Digital Conversion	3
1.5.1 Engineering Units	3
1.5.2 Scale Units	3
1.6 Effect of Out-of-Range Input Signals	3
1.7 Resolution	6
1.8 Analog-toDigital Converter Filter	6
CHAPTER 2. INSTALLATION	7
2.1 Planning the Installation	7
2.2 Calculating the I/O Base Power Budget	7
2.3 Unpacking the Module	7
2.4 Configuring the Module	8
2.4.1 Selecting Thermocouple or Millivolt Measurement via DIP Switch	8
2.4.2 Selecting Thermocouple Type Input via Hardware Jumpers	9
2.4.3 Selecting PLC Login Mode	9
2.4.4 Selecting Data Format	9
2.4.5 Selecting Digital Filtering	9
2.4.6 Select Degrees Celsius or Fahrenheit	10
2.5 Inserting the Module Into the I/O Base	11
2.6 Wiring the Input Connectors	12
2.6.1 Connecting the Shield Wiring	14
2.7 Checking Module Operation	15
CHAPTER 3. TROUBLESHOOTING	17

SPECIFICATIONS	19
JUMPER SETTINGS LOG SHEET	23
THERMOCOUPLE WIRE GUIDE	25
LIMITED PRODUCT WARRANTY	29
REPAIR POLICY	31

TABLE OF FIGURES

Figure 1	<i>2556 16-Channel Isolated Thermocouple Input Module</i>	iii
Figure 2	<i>2556 Front Panel Description</i>	1
Figure 3	<i>Word Input to the PLC from the Module</i>	2
Figure 4	<i>Example Change in Input Level</i>	3
Figure 5	<i>Effect of Voltage Input on Type J Thermocouple</i>	4
Figure 6	<i>Effect of Voltage Input on Type K Thermocouple</i>	4
Figure 7	<i>Effect of Voltage Input on Type R Thermocouple</i>	4
Figure 8	<i>Effect of Voltage Input on Type S Thermocouple</i>	4
Figure 9	<i>Effect of Voltage Input on Type T Thermocouple</i>	5
Figure 10	<i>Effect of Voltage Input on Type E Thermocouple</i>	5
Figure 11	<i>Effect of Voltage Input on Type L Thermocouple</i>	5
Figure 12	<i>Effect of Voltage Input on Millivolt Range</i>	5
Figure 13	<i>Input Resolution</i>	6
Figure 14	<i>Factory Configuration Jumper Settings</i>	10
Figure 15	<i>Configuration Jumper Location</i>	11
Figure 16	<i>Input Connector Wiring</i>	12
Figure 17	<i>Thermocouple Wiring Application</i>	13
Figure 18	<i>Millivolt Wiring Application</i>	13
Figure 19	<i>Cable Grounding</i>	14
Figure 20	<i>Example I/O Configuration Chart</i>	15
Figure 21	<i>Troubleshooting Matrix</i>	17
Figure 22	<i>Factory Configuration Jumper Settings</i>	23

CHAPTER 1. DESCRIPTION

The Sixteen Channel Thermocouple Input Module is a member of Control Technology's family of I/O modules compatible with the SIMATIC® 505 Series programmable controllers. The Model 2556 is designed to translate a J, K, R, S, T, E, and L (DIN J) thermocouple or millivolt input signal into an equivalent digital word which is then sent to the programmable controller (PLC).

The 2556 Thermocouple Input Module features built-in independent internal cold junction compensation and linearization for each thermocouple input for Types J, K, E, R, S, L, and T. No external cold junction compensation is required.

1.1 Front Panel Description

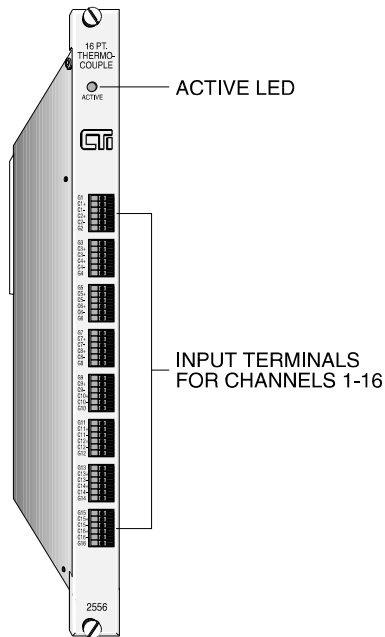

Figure 2 2556 Front Panel Description

1.1.1 Active LED

The Active LED will be illuminated when the module is functioning normally. If the Active LED is not lit, refer to Chapter 3 for troubleshooting.

1.1.2 Input Terminals for Channels 1-16

The Model 2556 uses a fixed wire press in connector to minimize the effects of the connector metallurgy on the accuracy of the measurement. This connector provides wiring terminals for channels 1-16.

1.2 Asynchronous Operation

The module operates asynchronously with respect to the PLC; a scan of the PLC and input sampling of the module do not occur at the same time. Instead, the module will translate all inputs in one module update (24 milliseconds maximum) and store the translated words in a buffer memory. The PLC retrieves the stored words from the module buffer memory at the start of the I/O scan.

1.2.1 Immediate I/O Compatibility

The Model 2556 has been tested and is compatible with the Immediate Read function of the SIMATIC® 545 and 555 PLC. The Model 2556 is compatible with 545 and 555 PLCs. It is compatible with the 525 PLCs in 16WX mode only.

1.3 J, K, R, S, T, E, or L Thermocouples

Each of the module's sixteen channels may be configured to receive either J, K, R, S, T, E, or L thermocouple input signals or a DC voltage signal ranging from -55 to +55 millivolts. Selection of thermocouple type or millivolts are made via internal DIP switch settings and hardware jumpers (see Sections 2.4.1 and 2.4.2).

1.4 Digital Word Map

Thermocouple and/or millivolt signals are translated into a 14-bit digital word. Since the PLC requires a 16-bit input word, the 14-bit value from the converter is placed into a 16-bit word for transmittal to the PLC. As shown in the following figure, of the two bits not used for the digital word, one is used to show the sign of the word, while the other is used to note values which are "overrange."

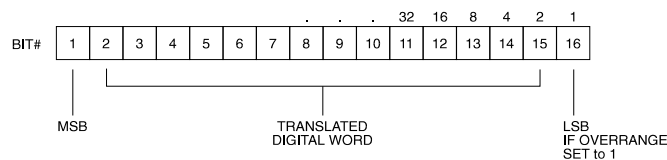

Figure 3 Word Input to the PLC from the Module

1.5 Thermocouple Input to Digital Conversion

1.5.1 Engineering Units

The following equations may be used to calculate the digital word in decimal format which will result from a particular thermocouple input:

Thermocouple Mode, Digital Word (WX) = Degrees X10

Millivolt Mode, Digital Word (WX) = Millivolts X100

As an example, the following figure illustrates the effects of a change in input level going from 0° to 102.4°F in the Thermocouple Input Mode.

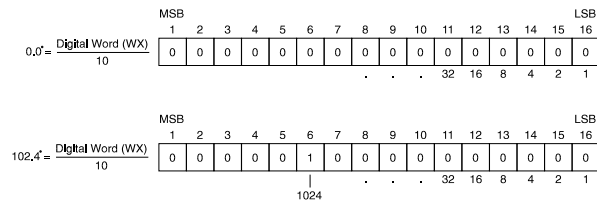

Figure 4 Example Change in Input Level

1.5.2 Scale Units

When data format is selected as SCALE the full temperature range of the thermocouple is scaled as an unsigned integer from 0-32000. The following formula may be used to calculate the scaled integer value.

Scaled Integer = (measured temp - min temp) ÷ (max temp - min temp) x 32000

For example the scaled integer offset at 0°C for a Type J thermocouple is:

Scaled integer = 0 - (-210) ÷ (760 - (-210)) x 32000 = 6928

1.6 Effect of Out-of-Range Input Signals

Thermocouple inputs exceeding the ANSI standard of 760 degrees C for Type J, or 1768 degrees C for Type R and S, and 1000 degrees C for Type E will cause the overrange bit to be set and the maximum temperature for that thermocouple type to be returned. Open thermocouples report temperatures that are out of the allowable range. This condition may occur due to failure of the thermocouple or due to the thermocouple wire being cut or disconnected. The Model 2556 will report an open thermocouple condition within 200 milliseconds.

NOTE:

The Model 2556 uses the least significant bit (16) to indicate an open thermocouple. The value of this bit is set to 1 when this condition occurs. An open thermocouple condition will report within 200 milliseconds.

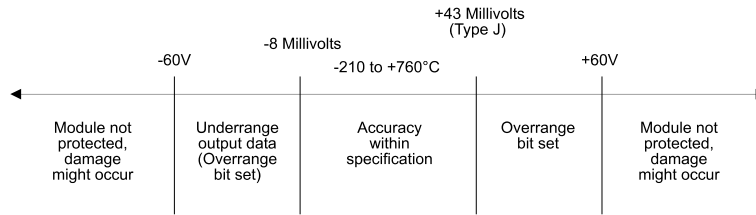

Figure 5 *Effect of Voltage Input on Type J Thermocouple*

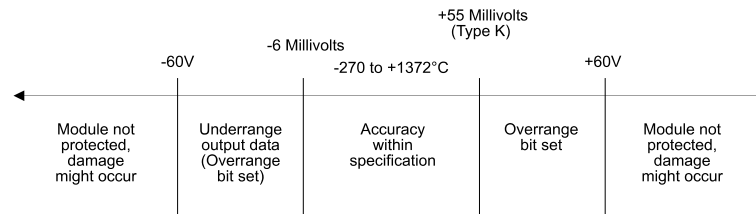

Figure 6 *Effect of Voltage Input on Type K Thermocouple*

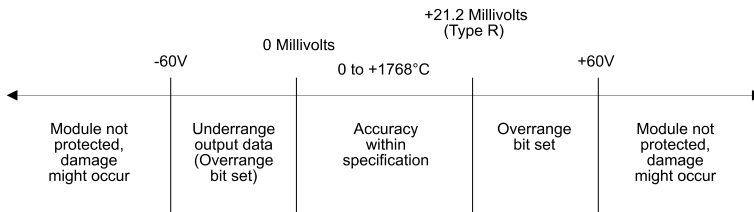

Figure 7 *Effect of Voltage Input on Type R Thermocouple*

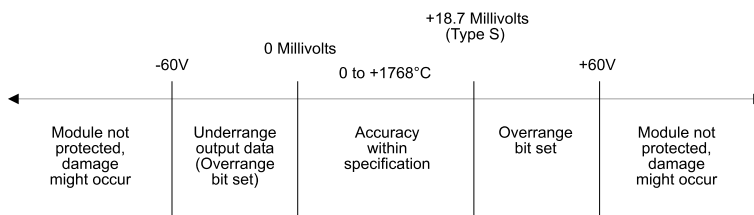

Figure 8 *Effect of Voltage Input on Type S Thermocouple*

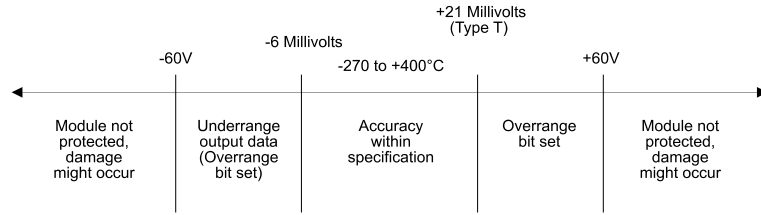

Figure 9 *Effect of Voltage Input on Type T Thermocouple*

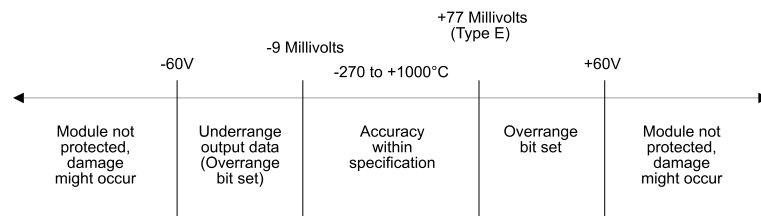

Figure 10 *Effect of Voltage Input on Type E Thermocouple*

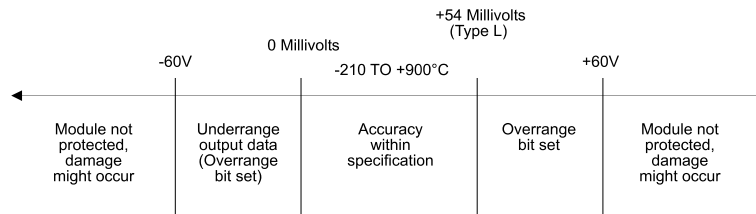

Figure 11 *Effect of Voltage Input on Type L Thermocouple*

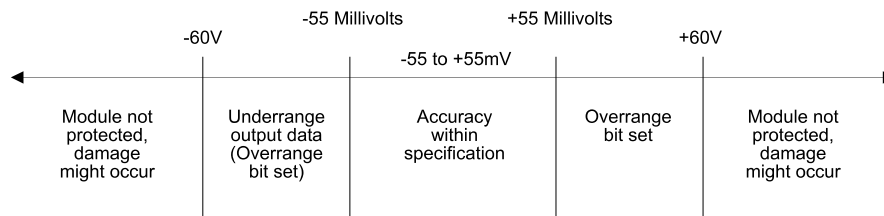

Figure 12 *Effect of Voltage Input on Millivolt Range*

1.7 Resolution

The module has a resolution of approximately 0.1°C, 0.2°F or exactly 0.01 millivolts.

The chart below shows the corresponding input resolution per step for each of the input configuration modes:

UNITS	DIGITAL COUNTS/STEP	INPUT RESOLUTION PER STEP
Temp Degrees C	2	~ 0.1°C
Temp Degrees F	2	~ 0.2°F
Millivolts	2	0.01 Millivolts

Figure 13 *Input Resolution*

1.8 Analog-to-Digital Converter Filter

The Model 2556 features a configurable notch filter on the analog-to-digital converters. This filter is very effective at removing power-line frequency input noise from the analog-to-digital conversion process. The filter frequency is configurable at jumper location CN10 on the printed circuit board. With no jumper at CN10, the filter frequency is 60 Hz. By placing the 3-pin jumper (included in an envelope packed with the Model 2556) at location CN10, the filter frequency is changed to 50 Hz.

CHAPTER 2. INSTALLATION

The installation of the Sixteen Channel Thermocouple Input Module involves the following steps:

1. Planning the installation
2. Configuring the module
3. Inserting the module into the I/O base
4. Wiring the module input connector
5. Checking module operation

The steps listed above are explained in detail in the following pages.

2.1 Planning the Installation

Planning is the first step in the installation of the module. This involves calculating the I/O base power budget and routing the input signal wiring to minimize noise. The following sections discuss these important considerations.

2.2 Calculating the I/O Base Power Budget

The Model 2556 requires 5 watts of +5 VDC power from the I/O base. Use these values to verify that the base power supply capacity is not exceeded.

2.3 Unpacking the Module

CAUTION:

HANDLING STATIC SENSITIVE DEVICES

The components on the 2556 module printed circuit card can be damaged by static electricity discharge. To prevent this damage, the module is shipped in a special anti-static bag. Take the following precautions before removing the module from the bag, when opening the module, and when handling the printed circuit card during configuration.

Discharge any static potential by holding the module in its anti-static bag and touch the metal chassis of the PLC. During the configuration step, hold the printed circuit card only by its edges. Do not touch the circuit card pin connectors, or solder connections.

Open the shipping carton and remove the special anti-static bag which contains the module. After discharging any static build-up, remove the module from the static bag. Do not discard the static

bag. You will need it for the following configuration procedure.

2.4 Configuring the Module

The Model 2556 must be configured for type J, K, R, S, T, E thermocouples or millivolt range and digital filtering/no filtering mode before wiring the input connectors and inserting the module into the

NOTE:
As shipped, all input channels are configured for Type J thermocouples (degrees Celsius) and digital filtering enabled, 16 WX mode and engineering units.

I/O base.

Changing the module input channel configuration involves the following steps:

1. Selecting thermocouple type or millivolt measurement via DIP switch
2. Selecting thermocouple type or millivolt input for each channel via hardware jumpers
3. Selecting digital filtering or no filtering for the module
4. Selecting standard login mode (16WX) or Advanced Operating Mode
5. Selecting degrees Celsius or Fahrenheit
6. Selecting Engr units or SCALE units for module
7. Logging the configuration jumper settings for future reference

Each of these steps is described in the following sections.

2.4.1 Selecting Thermocouple or Millivolt Measurement via DIP Switch

NOTE:
The ON position is selected by pushing the switch toward the center of the printed circuit board.

DIP switches 1-4 on the inside edge of the printed circuit board are used to inform the micro computer of changes in setup in the hardware selection jumpers (see Figure 13). Each channel has 3 switches to represent the thermocouple type or millivolt measurement that is performed.

Switch Position	BCD Value	Measurement Selected
OFF OFF OFF	0	Millivolt
OFF OFF ON	1	E
OFF ON OFF	2	J
OFF ON ON	3	K
ON OFF OFF	4	L
ON OFF ON	5	R
ON ON OFF	6	S
ON ON ON	7	T

2.4.2 Selecting Thermocouple Type Input via Hardware Jumpers

Locate the hardware Thermocouple Compensation Jumpers corresponding to input channels 1 through 16. These jumpers are located adjacent to the input terminal strip (see Figure 13). For each input channel, select either millivolt input or thermocouple type by placing the jumper in the correct position.

2.4.3 Selecting PLC Login Mode

Locate JP68 on the printed circuit board to select PLC Login Mode (see Figure 13). Standard login is 16WX registers in the PLC. Advanced Operating Mode logs in as 16X, 16Y, 32WX and 32WY registers. Consult the CTI 255x Sixteen Channel Advanced Function Programming Reference Manual, part #62-177, if the advanced operating mode is to be selected.

2.4.4 Selecting Data Format

Locate SCALE jumper JP69 on the printed circuit board. (See Figure 13.) Select Engr to present data to the PLC as temperature X10 or Millivolt X100. Select SCALE to scale and present data as an unsigned integer from 0-32000.

2.4.5 Selecting Digital Filtering

Locate the Digital Filtering Jumper JP67 (see Figure 13). To enable digital filtering, set the jumper in the "ENABLED" position. Since many analog input signals contain noise, CTI recommends using digital filtering unless maximum response time is required. Digital filtering applies to both thermocouple or millivolt inputs.

The time step for digital filtering is .080 seconds. The filtering technique used provides that the full range of a voltage change reported to the PLC will be accomplished in 5 time steps or .40 seconds. The voltage change will be reported as a continuous exponential function over this time period with values at each time step as indicated

- at .08 seconds, the value is 63% of full range
- at .16 seconds, the value is 86% of full range
- at .24 seconds, the value is 95% of full range, and
- at .40 seconds, the value is 99% of full range.

2.4.6 Select Degrees Celsius or Fahrenheit

Locate the temperature scaling jumper JP66 on the right hand side of the module (see Figure 13) and select either degrees Celsius or Fahrenheit by positioning the jumper in the "DEG C" or "DEG F"

CHANNEL NUMBER	HARDWARE SELECTION	DIP SWITCH SELECTION	
1	E, J/ K, / mV / L / R, S, T	010	OFF / ON / OFF
2	E, J/ K, / mV / L / R, S, T	010	OFF / ON / OFF
3	E, J/ K, / mV / L / R, S, T	010	OFF / ON / OFF
4	E, J/ K, / mV / L / R, S, T	010	OFF / ON / OFF
5	E, J/ K, / mV / L / R, S, T	010	OFF / ON / OFF
6	E, J/ K, / mV / L / R, S, T	010	OFF / ON / OFF
7	E, J/ K, / mV / L / R, S, T	010	OFF / ON / OFF
8	E, J/ K, / mV / L / R, S, T	010	OFF / ON / OFF
9	E, J/ K, / mV / L / R, S, T	010	OFF / ON / OFF
10	E, J/ K, / mV / L / R, S, T	010	OFF / ON / OFF
11	E, J/ K, / mV / L / R, S, T	010	OFF / ON / OFF
12	E, J/ K, / mV / L / R, S, T	010	OFF / ON / OFF
13	E, J/ K, / mV / L / R, S, T	010	OFF / ON / OFF
14	E, J/ K, / mV / L / R, S, T	010	OFF / ON / OFF
15	E, J/ K, / mV / L / R, S, T	010	OFF / ON / OFF
16	E, J/ K, / mV / L / R, S, T	010	OFF / ON / OFF

ALL CHANNELS	FAHRENHEIT / CENTIGRADE SELECT JP66	DIGITAL FILTERING JP67	LOGIN MODE JP68	DATA FORMAT JP69
1-16	Left - Degrees C Right - Degrees F	Left - Disabled Right - Enabled	Left - Standard 16WX Right - Advanced	Left - Engr (Temp X10) Right - Scale (0-32,000)

Figure 14 Factory Configuration Jumper Settings

position.

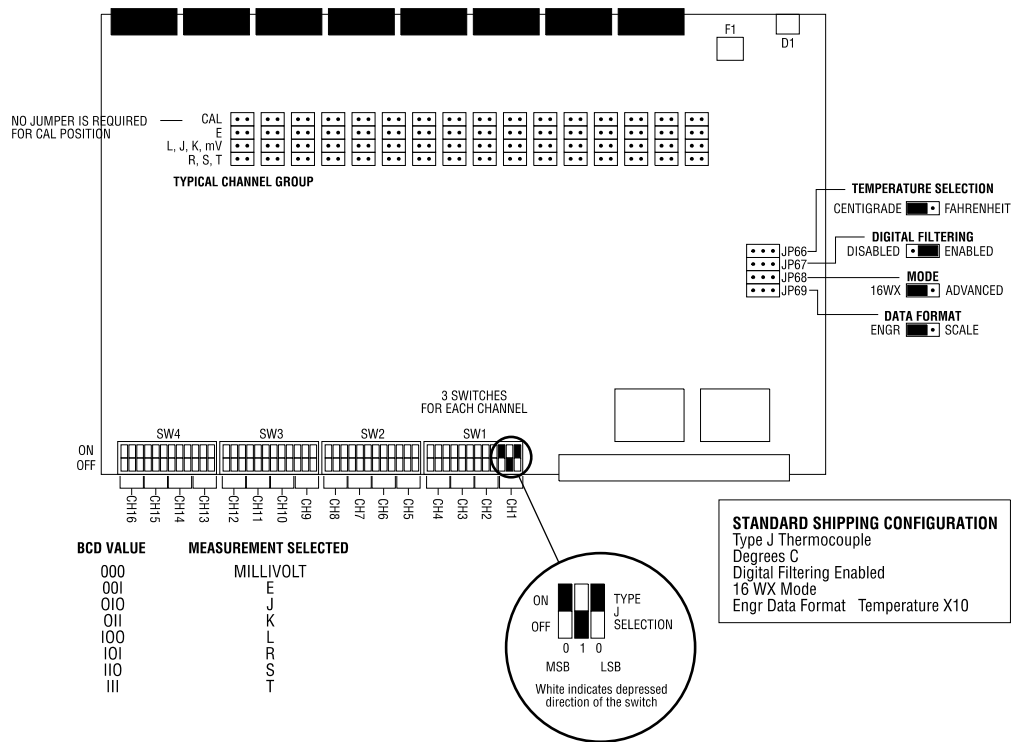

Figure 15 Configuration Jumper Location

WARNING:
Remove power from the I/O base before inserting or removing a module.

2.5 Inserting the Module Into the I/O Base

Insert the module into the I/O base by carefully pushing the module into the slot. When the module is fully seated in the slot, tighten the captive screws at the top and bottom to hold the module in place. To remove the module from the I/O base, loosen the captive screws, then remove the module from the I/O base. Be careful not to damage the connector card at the back of the module when inserting or removing the module.

2.6 Wiring the Input Connectors

Thermocouple input signals are accepted through a fixed wire press in connector block located on the front of the module. Consult the thermocouple manufacturer's recommendations for selecting the input wire type and size. The front connector accepts wire from 18 to 30 AWG.

The Model 2556 uses a fixed connector to terminate field wiring. This is used because the chemistry of a removable connector may have an adverse effect on the accuracy of the measurement. CTI has carefully selected a connector that minimizes this effect.

To assign an input to a specific channel, locate the appropriate channel position on the connector as shown in the following figure. Wires must be inserted by pressing the wire into the connector receptacle. To remove the wire use a small screwdriver to depress the connector lever. Then remove the thermocouple wire.

On each channel input the positive lead for the thermocouple is attached to the Cn+ terminal and the negative lead is attached to the Cn- terminal. If a shield is used it is attached at the Gn terminal. The

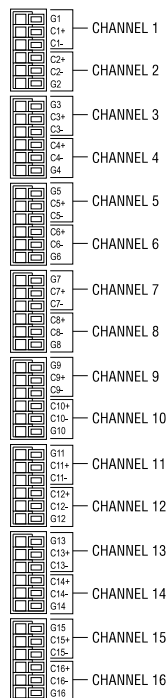

Figure 16 *Input Connector Wiring*

"red" lead is always the negative lead for thermocouples.

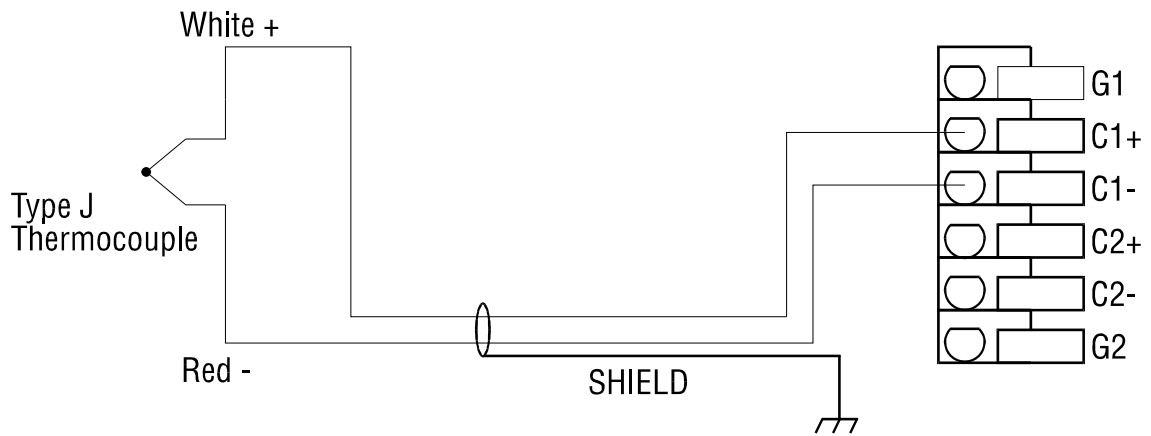

Figure 17 *Thermocouple Wiring Application*

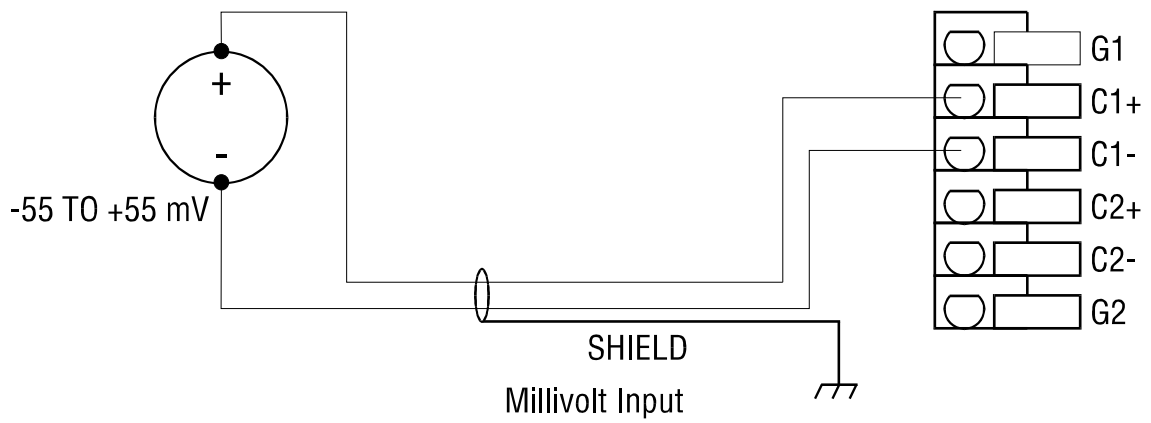

Figure 18 *Millivolt Wiring Application*

2.6.1 Connecting the Shield Wiring

ControlTechnology Inc. recommends that all signal wires be shielded twisted-pair with foil wrap shield and a separate drain wire and that they be installed in a metallic conduit. Use Belden cable 8761 or equivalent which contains a foil wrap shield and a separate drain wire. The shield and the foil wrap should be twisted together and should be terminated at only one end. The other end should be left in an open circuit condition. CTI recommends that the shield be terminated at the PLC end of signal wire. Special components are installed on the module to aid in the rejection of noise.

When entering the industrial cabinet the shield wires should be routed from the main terminal strip all the way to the PLC. Signal leads that do not maintain a shield from the terminal strip to the PLC act as antennas and are susceptible to radiated and conducted emissions in the cabinet. Unprotected cables may introduce measurement errors in the module.

The front connector on the module contains a G terminal which may be used for the shield wire if the installation is in a noise free environment. If the installation is in an extremely noisy environment CTI strongly recommends that the shield wires be terminated to the PLC chassis ground.

CTI has exhaustively tested this product to maximize its ability to reject noise from inductive sources as well as showering arcs, fast transients and other high frequency generators and has determined that the best performance results from connecting all shield wires together at the PLC module and terminating this single wire to the chassis ground with a large current capacity conductor. The PLC chassis should then be wired to earth ground with a large current capacity conductor. CTI recommends

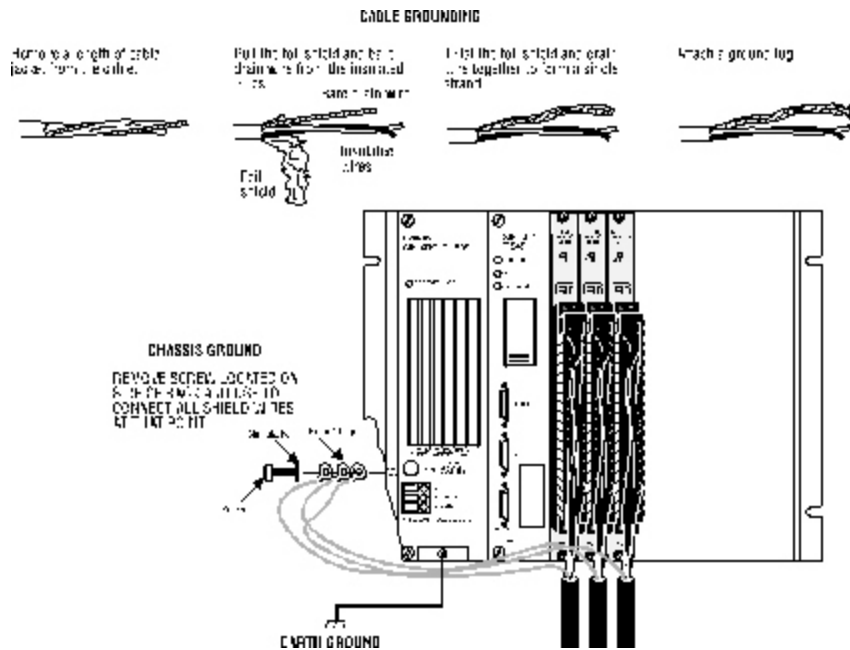

Figure 19 Cable Grounding

using a #8 gauge wire from the PLC chassis to the earth ground connection.

2.7 Checking Module Operation

First, turn on the base supply power. If the module diagnostics detect no problems, the status indicator on the front of the module will light. If the status indicator does not light (or goes out during operation), the module has detected a failure. For information on viewing failed module status, refer to your SIMATIC® TISOFT user manual. To diagnose and correct a module failure, refer to the next section on troubleshooting.

You must also check that the module is configured in the memory of the PLC. This is important because the module will appear to be functioning regardless of whether it is communicating with the PLC. To view the PLC memory configuration chart listing all slots on the base and the inputs or outputs associated with each slot, refer to your SIMATIC® TISOFT Programming Manual. An

NOTE:
If thermocouples are not available for testing, the module will report ambient temperature by simply jumpering the (Cn+) and (Cn-) terminals with a short wire 26-18 gauge. This will verify that all channels are operating and that the module is logged into the PLC.

example chart is shown in the Figure 17.

In this example, the Model 2556 Module is inserted in slot 1 in I/O base 0. Data for channel 1 appears in word location WX1, data for channel 2 appears in word location WX2, etc. For your particular module, look in the chart for the number corresponding to the slot occupied by the module. If word

I/O MODULE DEFINITION FOR CHANNEL 1					BASE 00	
I/O SLOT	ADDRESS	X	Y	WX	WY	SPECIAL FUNCTION
01	0001	00	00	16	00	NO
02	0000	00	00	00	00	NO
.
.
15	0000	00	00	00	00	NO
16	0000	00	00	00	00	NO

Figure 20 Example I/O Configuration Chart

memory locations appear on this line, then the module is registered in the PLC memory and the module is ready for operation.

If the line is blank or erroneous, re-check the module to ensure that it is firmly seated in the slots. Generate the PLC I/O configuration chart again. If the line is still incorrect, contact your local distributor or CTI at 1-800-537-8398 for further assistance.

NOTE:

In Advanced Operating Mode the module logs in to the PLC as 16X, 16Y, 32WX, and 32WY.

NOTE:

Refer to Hewlett-Packard Applications Note 290 or Omega Temperature Handbook, Volume 26, Section T, for "practical thermocouple measurement" applications.

CAUTION:

For proper operation, ensure that the Model 2556 and the thermocouple wires are not subjected to large temperature gradients during operation.

NOTE:

*In the event a CTI analog detects an onboard module failure, the module will assert the module fail line and report the module failure in the I/O Status Word, which is reported to the PLC CPU. CTI strongly recommends the user application monitor the **I/O Module Status Words** which are Status Words 11-26 and apply to SIMATIC® Controllers /545, /555, /560 & 565 and the /575. The I/O Module Status Word can be used to report a module failure for an I/O Module in any of the 505 I/O slots. Please refer to Siemens® SIMATIC® 505 Programming Reference Manual for more information. If a module failure is reported by the status word, the module should be replaced with a working unit and the failed module sent infor repair.*

CHAPTER 3. TROUBLESHOOTING

If the module provides improper readings or the status indicator is not on, use the following chart to determine the appropriate corrective action.

When it is inconvenient to visually check the status indicator, use the TISOFT "Display Failed I/O" or "Show PLC Diagnostics" support functions.

If after consulting the chart above, you are unable to diagnose or solve the problem, contact your local distributor or CTI at 1-800-537-8398 for further assistance.

SYMPTOM	PROBABLE CAUSE	CORRECTIVE ACTION
Indicator is not lit	Base or PLC power is off	Turn base or PLC on
	Wrong connections	Trace wiring to check connections
	Blown fuse	Measure F1 for continuity Short all inputs and verify ambient temperature measurement
Indicator is blinking	No calibration data	Return to CTI for calibration
Incorrect inputs	Wrong addresses for word input	Check program for correct word input addresses
	Not logged-in	Read I/O configuration
	Incorrectly calibrated	Return the module to CTI for calibration. DO NOT CALIBRATE.
	Blown fuse	Measure F1 for continuity Short all inputs and verify ambient temperature measurement
Input does not work with PID loop or analog alarm block	Value is not reported as integer 0-32000	Select SCALE format with JP69
Value is too large	Temperature is reported to PLC as value X10	Divide value by 10 in PLC
Incorrect values to PLC Values off by 10-15 degrees	Compensation jumpers in wrong position or DIP switch not set	Verify position of cold junction compensation jumpers for each channel and corresponding DIP switch for microcomputer

Figure 21 *Troubleshooting Matrix*

SPECIFICATIONS

Input Channels:	16 isolated thermocouple or millivolt inputs
Thermocouple Types:	J, K, R, S, T, E, and L (DIN J) (C and N by Special Product Quotation)
Millivolt Input Range:	-55 to +55 mV
Millivolt Input Impedance:	>10K Ω @ 50/60 Hz >100M Ω @ DC
Absolute Millivolt Accuracy:	\pm 0.1% full scale or \pm 500 μ V
Input Overrange Protection:	30 VDC or VAC continuous
Measurement Ranges:	J -210°C to +760°C (-350°F to +1400°F) K -270°C to +1372°C (-450°F to +2500°F) R, S 0°C to +1768°C (0°F to +3214°F) T -270°C to +400°C (-450°F to +752°F) E -270°C to +1000°C (-450°F to +1832°F) L -210°C to +900°C (-350°F to +1652°F)
ADC Resolution:	16 bits
Data Presentation:	Measurement returned in 0.2 degree resolution as temperature X10 or as a scaled integer (0-32000). (16WX mode.) Data word includes sign bit and overrange/underrange bit. Millivolts returned as millivolts X100. (16WX mode.) 0.1 degree in Advanced Mode
Measurement Units:	Selectable for the entire module in 16WX mode Degrees C or F Scaled signed integer (0-32000) Selectable by channel in Advanced Mode
Digital Filtering Time Constant:	80 mSec (16WX mode), 80-32000 mSec (Advanced Mode)
Update Time (all 16 channels):	18 mSec no filtering 20 mSec digital filtering enabled 48 mSec advanced functions enabled

Repeatability:	$\pm 0.2^{\circ}\text{C}$ or $^{\circ}\text{F}$ all thermocouple types (16WX mode) $\pm 0.1^{\circ}\text{C}$ or $^{\circ}\text{F}$ all thermocouple types (advanced mode) $\pm 50\ \mu\text{V}$ (millivolt inputs)
Accuracy:	at a fixed ambient temperature between 0°C to 60°C and a reported temperature above 0°C for types J, K, T, L, E or above 500°C for types R and S
Types J, K, E, T, L	$\pm 1^{\circ}\text{C}$ ($\pm 2^{\circ}\text{F}$) from 0°C to 60°C 0°C (32°F) to full scale Reduced accuracy for measurements below 0°C (32°F)
Types R, S	for measurement range $500\text{-}1768^{\circ}\text{C}$ $\pm 2^{\circ}\text{C}$ ($\pm 4^{\circ}\text{F}$) from 0°C to 60°C Reduced accuracy for measurements below 500°C
Millivolt	$\pm 50\ \mu\text{V}$ from 0°C to 60°C
Common Rejection Mode:	$>130\ \text{dB @ } 50/60\ \text{Hz}$
Normal Rejection Mode:	$>180\ \text{dB @ } 60\ \text{Hz}$ $>80\ \text{db @ } 50\ \text{Hz}$
Connector:	48 position fixed, wire press in
Wire Gauge:	18 to 30 AWG
Module Size:	Single wide
Backplane Power Consumption:	9 Watts

NOTE:
*For 50 Hz operation contact CTI for firmware change to improve
normal mode rejection to 180 db @ 50 Hz.*

Environmental

Isolation:	1500 VDC channel-to-channel 1500 VDC channel-to backplane
Operating Temperature:	0°C to 60°C (32°F to 140°F)
Storage Temperature:	-40°C to 85°C (-40°F to 185°F)
Humidity, Relative:	5% to 95% (non-condensing)
Agency Approvals:	UL, UL for Canada FM (Class I, Div 2), CE
Shipping Weight:	1.5 lbs. (0.68 kg)

Specifications subject to change without notice.

JUMPER SETTINGS LOG SHEET

Record the configuration jumper settings on this log for future reference. Make additional copies if necessary.

CHANNEL NUMBER	HARDWARE SELECTION	DIP SWITCH SELECTION		
1				
2				
3				
4				
5				
6				
7				
8				
9				
10				
11				
12				
13				
14				
15				
16				

ALL CHANNELS	FAHRENHEIT / CENTIGRADE SELECT JP66	DIGITAL FILTERING JP67	LOGIN MODE JP68	DATA FORMAT JP69
1-16	Left - Degrees C Right - Degrees F	Left - Disabled Right - Enabled	Left - Standard 16WX Right - Advanced	Left - Engr (Temp X10) Right - Scale (0 to 32,000)

Figure 22 *Factory Configuration Jumper Settings*

NOTE:

The Model 2556 Thermocouple Input Module is calibrated at the factory. No further calibration is required. All calibration parameters are sorted in non-volatile memory. There are no user adjustments on this product. As shipped there is no jumper required on the CAL input.

THERMOCOUPLE WIRE GUIDE

ANSI Code	Color Code		Lead Material		Magnetic Lead	Maximum Useful Temperature Range	EMF (mV) Over Useful Temperature Range
	Thermocouple Grade	Extension Grade	+ Lead	- Lead			
J			IRON Fe	CONSTANTAN COPPER-NICKEL Cu-Ni	IRON (+)	32 to 1382°F 0 to 750°C Thermocouple Grade 32 to 392°F 0 to 200°C Extension Grade	0 to 42.283
K			CHROMEL NICKEL-CHROMIUM Ni-Cr	ALUMEL NICKEL-ALUMEL Ni-Al	ALUMEL (-)	-328 to 2282°F -200 to 1250°C Thermocouple Grade 32 to 392°F 0 to 200°C Extension Grade	-5.973 TO 50.633
T			COPPER Cu	CONSTANTAN COPPER-NICKEL Cu-Ni	NONE	-328 to 662°F -200 to 350°C Thermocouple Grade -76 to 212°F -60 to 100°C Extension Grade	-5.602 to 17.816
E			CHROMEL NICKEL-CHROMIUM Ni-Cr	CONSTANTAN COPPER-NICKEL Cu-Ni	NONE	-328 to 1652°F -200 to 900°C Thermocouple Grade 32 to 392°F 0 to 200°C Extension Grade	-8.824 to 68.783
N			OMEGA-P™ NICROSIL Ni-Cr-Si	OMEGA-N™ NISIL Ni-Si-Mg	NONE	-450 to 2372°F -270 to 1300°C Thermocouple Grade 32 to 392°F 0 to 200°C Extension Grade	-4.345 to 47.502
R	NONE ESTABLISHED		PLATINUM- 13% RHODIUM Pt-13% Rh	PLATINUM Pt	NONE	-32 to 2642°F 0 to 1450°C Thermocouple Grade 32 to 300°F 0 to 150°C Extension Grade	0 to 16.741
S	NONE ESTABLISHED		PLATINUM- 10% RHODIUM Pt-10% Rh	PLATINUM Pt	NONE	-32 to 2642°F 0 to 1450°C Thermocouple Grade 32 to 300°F 0 to 150°C Extension Grade	0 to 14.973
B	NONE ESTABLISHED		PLATINUM- 30% RHODIUM Pt-30% Rh	PLATINUM- 6% RHODIUM Pt-6% Rh	NONE	32 to 3092°F 0 to 1700°C Thermocouple Grade 32 to 212°F 0 to 100°C Extension Grade	0 to 12.426
G	NONE ESTABLISHED		TUNGSTEN W	TUNGSTEN- 26% RHENIUM W-26% Re	NONE	-32 to 4208°F 0 to 2320°C Thermocouple Grade 32 to 500°F 0 to 260°C Extension Grade	0 to 38.564
C	NONE ESTABLISHED		TUNGSTEN- 5% RHENIUM W-5% Re	TUNGSTEN- 26% RHENIUM W-26% Re	NONE	32 to 4208°F 0 to 2320°C Thermocouple Grade 32 to 1800°F 0 to 870°C Extension Grade	0 to 37.066
D	NONE ESTABLISHED		TUNGSTEN- 3% RHENIUM W-3% Re	TUNGSTEN- 25% RHENIUM W-25% Re	NONE	32 to 4208°F 0 to 2320°C Thermocouple Grade 32 to 500°F 0 to 260°C Extension Grade	0 to 39.506

USER NOTES

LIMITED PRODUCT WARRANTY

CTI warrants that this CTI Industrial Product shall be free from defects in material and workmanship for a period of one (1) year after purchase from CTI or from an authorized CTI Industrial Distributor. This CTI Industrial Product will be newly manufactured from new and/or serviceable used parts which are equal to new in the Product.

Should this CTI Industrial Product fail to be free from defects in material and workmanship at any time during this one (1) year warranty period, CTI will repair or replace (at its option) parts or Products found to be defective and shipped prepaid by the customer to a designated CTI service location along with proof of purchase date and associated serial number. Repair parts and replacement Product furnished under this warranty will be on an exchange basis and will be either reconditioned or new. All exchanged parts or Products become the property of CTI. Should any Product or part returned to CTI hereunder be found by CTI to be without defect, CTI will return such Product or part to the customer.

This warranty does not include repair of damage to a part or the Product resulting from: failure to provide a suitable environment as specified in applicable Product specifications, or damage caused by an accident, disaster, acts of God, neglect, abuse, misuse, transportation, alterations, attachments, accessories, supplies, non-CTI parts, non-CTI repairs or activities, or to any damage whose proximate cause was utilities or utility like services, or faulty installation or maintenance done by someone other than CTI.

Control Technology Inc. reserves the right to make changes to the Product in order to improve reliability, function, or design in the pursuit of providing the best possible Product. CTI assumes no responsibility for indirect or consequential damages resulting from the use or application of this equipment.

THE WARRANTY SET FORTH ABOVE IN THIS ARTICLE IS THE ONLY WARRANTY CTI GRANTS AND IT IS IN LIEU OF ANY OTHER IMPLIED OR EXPRESSED GUARANTY OR WARRANTY ON CTI PRODUCTS, INCLUDING WITHOUT LIMITATION, ANY WARRANTY OF MERCHANTABILITY OR OF FITNESS FOR A PARTICULAR PURPOSE AND IS IN LIEU OF ALL OBLIGATIONS OR LIABILITY OF CTI FOR DAMAGES IN CONNECTION WITH LOSS, DELIVERY, USE OR PERFORMANCE OF CTI PRODUCTS OR INTERRUPTION OF BUSINESS, LOSS OF USE, REVENUE OR PROFIT. IN NO EVENT WILL CTI BE LIABLE FOR SPECIAL, INCIDENTAL, OR CONSEQUENTIAL DAMAGES.

SOME STATES DO NOT ALLOW THE EXCLUSION OR LIMITATION OF INCIDENTAL OR CONSEQUENTIAL DAMAGES FOR CONSUMER PRODUCTS, SO THE ABOVE LIMITATIONS OR EXCLUSIONS MAY NOT APPLY TO YOU.

THIS WARRANTY GIVES YOU SPECIFIC LEGAL RIGHTS, AND YOU MAY ALSO HAVE OTHER RIGHTS WHICH MAY VARY FROM STATE TO STATE.

REPAIR POLICY

In the event that the Product should fail during or after the warranty period, a Return Material Authorization (RMA) number can be requested verbally or in writing from CTI main offices. Whether this equipment is in or out of warranty, a Purchase Order number provided to CTI when requesting the RMA number will aid in expediting the repair process. The RMA number that is issued and your Purchase Order number should be referenced on the returning equipment's shipping documentation. Additionally, if under warranty, proof of purchase date and serial number must accompany the returned equipment. The current repair and/or exchange rates can be obtained by contacting CTI's main office at 1-800-537-8398.

When returning any module to CTI, follow proper static control precautions. Keep the module away from polyethylene products, polystyrene products and all other static producing materials. Packing the module in its original conductive bag is the preferred way to control static problems during shipment. **Failure to observe static control precautions may void the warranty.** For additional information on static control precautions, contact CTI's main office at 1-800-537-8398.