

RD3 and RCQ020

Electronic low-voltage residual current devices
for miniature and moulded-case circuit-breakers

2CSC444001B0201



ABB

RD3 and RCQ020

A unique and complete range for residual current protection

ABB offers a complete range of electronic residual current devices, in accordance with the international Standard IEC60947-2, Annex M. The perfect combination of RD3 and RCQ020 range with miniature circuit-breakers of S200 family and Tmax moulded-case circuit-breakers ensures residual current protection up to 1250A. RCQ020 can be also be combined with Emax X1.





RD3 and RCQ020 residual current devices are combined with a wide range of toroids with diameter from 29mm to 230mm (for cables and busbars), which provides the maximum application flexibility for an effective protection in every point of the system.



RD3 and RCQ020

A complete range of residual current devices for industrial applications

With the residual current devices with separate toroid, either in modular version (range RD3) or controlled from the switchboard front (range RCQ020), ABB provides the right solution for residual current protection for all levels of low-voltage installations, from low-voltage lines to power distribution, up to terminal distribution. These high-performance products provide:

The benefits

- Reduction of unwanted tripping
- Protection and control
- Total selectivity of the system
- Power supply from auxiliary network
- Flexibility of installation
- High accuracy of measurement
- Frequency filtering



Reduction of unwanted tripping

RD3M, RD3P and RCQ020 residual current devices perform leakage current measurement through a frequency filtering that allows an increased immunity against high-frequency currents not hazardous to man that are typically generated by inverters and the main cause of unwanted tripping of residual current devices. Moreover, some of the models of RD3 range and RCQ020 switchboard device feature a pre-alarm threshold adjustment that signals, through an output contact, when a given residual leakage current is reached. This function indicates that the installation insulation level is decreasing and therefore allows appropriate planning of the required maintenance operations. By removing most of the unwanted tripping of residual current devices, a high degree of safety on the systems can be reached, along with a high level of service continuity.

Protection and control in every point of the system

Due to the wide current adjustment range (from 30mA to 30A) and to the large number of toroids available (openable and closed for cables or busbars), RD3 and RCQ020 residual current devices ensure effective protection in every point of the system.

Total selectivity of the installation

By combining the wide time-adjustment options and the countless release features of ABB low-voltage circuit-breakers, different levels of selectivity can be obtained ensuring total selectivity in case of an insulation fault in the system.

Power supply from auxiliary network

The power supply of RCQ020 residual current devices from an auxiliary network provides great flexibility to the user.

Flexibility of installation

As the devices are available either with miniature design (RD3 range – 3 modules) or as switchboard devices (96mm x 96mm), the new range allows the installation of any type of switchboard.

High accuracy of measurement

Both RD3 range and RCQ020 devices perform the RMS measure of earth leakage current. This means that the residual current devices measure any type of signal, calculating the actual RMS value, averaged according to the frequency filtering.

Frequency filtering

The measurement of leakage current provides an attenuation of high-frequency components, which are especially due to the presence of inverters in the circuit and are the main cause of unwanted tripping of residual current devices. This ensures a high degree of safety in the systems and a high level of service continuity.

RD3

Functions and features

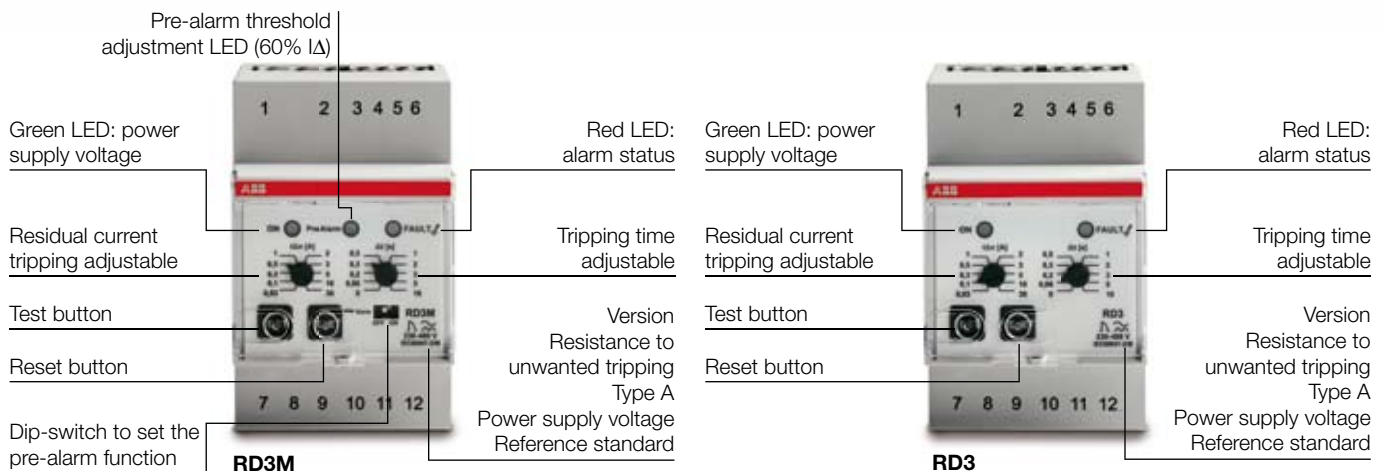
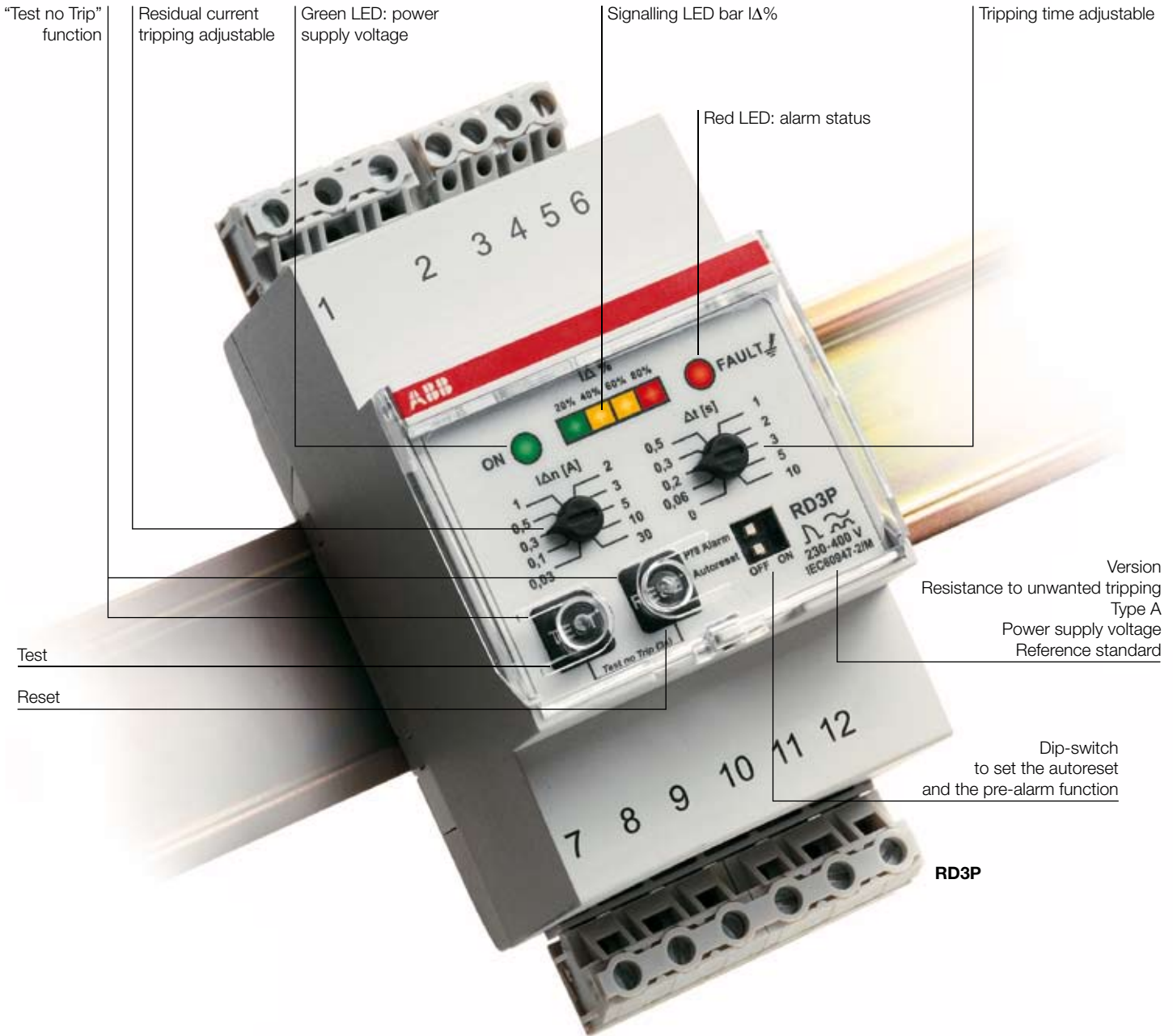



Functions

Pre-alarm - RD3P, RD3M

When the dip-switch is set to ON, the pre-alarm function is activated: the output contact marked by the 7 8 9 terminals will switch in case of a fault detected by the device exceeding 60% I_{Δ} .

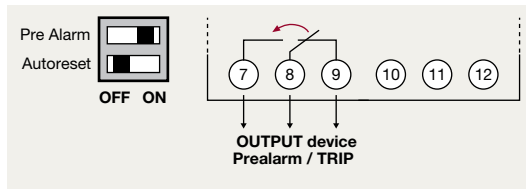

Autoreset - RD3P

When the dip-switch is set to ON, the automatic Reset function is activated: the output device contact will return to stand-by when the fault condition has been resolved.

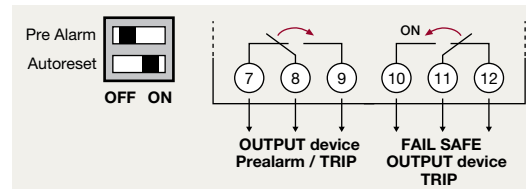

Fail-safe - RD3, RD3M, RD3P

Integrated in the device (positive safety). In case of power supply voltage failure of RD3 device, the output contacts numbered 10 11 12 will switch as shown below.

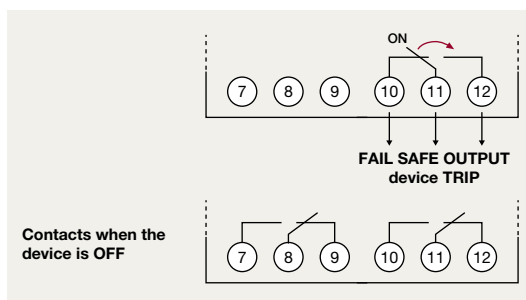

Test No Trip

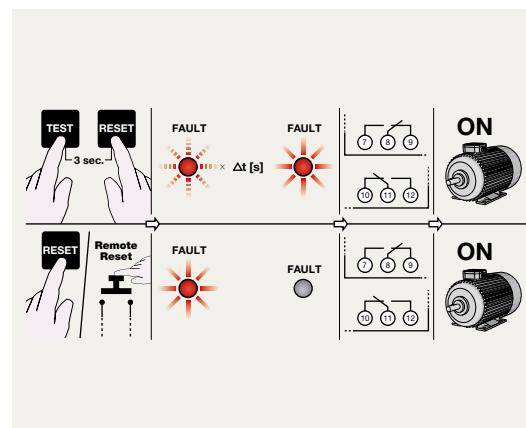

Technical data	RD3 RD3-48	RD3M RD3M-48	RD3P RD3P-48
Power supply voltage	230-400Vac +10% / -15% 12-48Vac/dc +10% / -15%	230-400Vac +10% / -15% 12-48Vac/dc +10% / -15%	230-400Vac +10% / -15% 12-48Vac/dc +10% / -15%
Operating frequency	45-66Hz	45-66Hz	45-66Hz
Frequency filtering	-	45...150 Hz $f_t=400$ Hz	45...150 Hz $f_t=400$ Hz
Type	A (up to $I_{\Delta n}=5A$)	A (up to $I_{\Delta n}=5A$)	A (up to $I_{\Delta n}=5A$)
Operating temperature	-25°C...+70°C	-25°C...+70°C	-25°C...+70°C
Max power consumption	< 3,6W (RD3) < 600mW (RD3-48)	< 3,6W (RD3M) < 600mW (RD3M-48)	< 3,6W (RD3P) < 600mW (RD3P-48)
Tripping threshold adjustment $I_{\Delta n}$	0,03-0,1-0,3-0,5-1-2-3-5-10-30	0,03-0,1-0,3-0,5-1-2-3-5-10-30	0,03-0,1-0,3-0,5-1-2-3-5-10-30
Tripping threshold adjustment Δt	0-0,06-0,2-0,3-0,5-1-2-3-5-10	0-0,06-0,2-0,3-0,5-1-2-3-5-10	0-0,06-0,2-0,3-0,5-1-2-3-5-10
Pre-alarm threshold adjustment	-	60% $I_{\Delta n}$	60% $I_{\Delta n}$
Toroid-device resistance	3 Ω	3 Ω	3 Ω
Max length of remote button-reset connection	15 m	15 m	15 m
Output contacts rating	8A 250Vac	8A 250Vac	8A 250Vac
Max terminal cable section	2,5 mm ²	2,5 mm ²	2,5 mm ²
Modules	3	3	3
Dimensions (LxHxD)	52,8x85x64,7 mm	52,8x85x64,7 mm	52,8x85x64,7 mm
Protection degree	IP 20	IP 20	IP 20
Reference standard	IEC 60947-2 annex.M (up to 630A)	IEC 60947-2 annex.M (up to 630A)	IEC 60947-2 annex.M (up to 630A)

Toroid selection table		TRM	TR1	TR2	TR3	TR4	TR5	TR160	TR160/A	TR4/A	TR5/A
Toroid diameter	mm	29	35	60	80	110	210	160	160	110	210
Max cable sect. (4x)	mm ²	25	35	50	95	240	480	400	400	240	480
Maximum monitored current (1x)	A	65	75	85	160	400	630	250	250	400	630

RCQ020

Functions and features



RCQ020 switchboard residual current device can be combined with the circuit-breakers of Tmax and Emax X1 family up to 1250A. With power supply derived from auxiliary network and with the wide range of settings available (current threshold from 30mA to 30A, and tripping time adjustable from instantaneous to 5s), RCQ020 can be used in systems with particularly restrictive installation requirements.

RCQ020 residual current device is of the type with indirect action and acts on the circuit-breaker release mechanism by means of the shunt opening release or undervoltage release of the circuit-breaker itself.

RCQ020 must be combined with one of its dedicated toroids.

The range of toroids includes closed-type toroids up to a maximum diameter of 185mm.

RCQ020 main functions:

- Protection threshold from 30mA to 30A
- Tripping time adjustable from instantaneous to 5 seconds
- Connection to the circuit-breaker through shunt opening release or undervoltage release
- Combination with closed toroids (maximum diameter 185mm)
- Type A residual current device
- Device status LED
- Pre-alarm/alarm/trip electrical signalling
- **Positive safety** function available
- The opening command to circuit-breaker can be temporarily inhibited (**Trip Delay**)
- The circuit-breaker can be **opened remotely**

Use of closed toroids		
Toroid	Max I _n	Range of use
ø 60	250A	0,03...30A
ø 110	400A	0,03...30A
ø 185	800A	0,1...30A

Technical data RCQ020	
Power supply voltage	115...415Vac
Operating frequency	45÷66Hz
Power consumption in service	2VA / 2W
Tripping threshold adjustment Δn	0,03-0,05-0,1-0,3-0,5-1-3-5-10-30A
Tripping time adjustment	Instantaneous 0,1-0,2-0,3-0,5-0,7-1-2-3-5 s
Pre-alarm threshold adjustment	25% x Δn
Powered device visual signalling	■
Malfunctioning visual signalling	■
Residual current protection tripping visual signalling	■
Pre-alarm/alarm electrical signalling	■
Tripping electrical signalling	■
Remote opening command	■
Remote reset command	■
Dimensions (LxHxD)	96x96x77mm
Protection degree - front	IP41
Protection degree - back	IP30
Reference standard	IEC 60947-2 annex.M



RD3

Tripping signalling, fault situations and order details

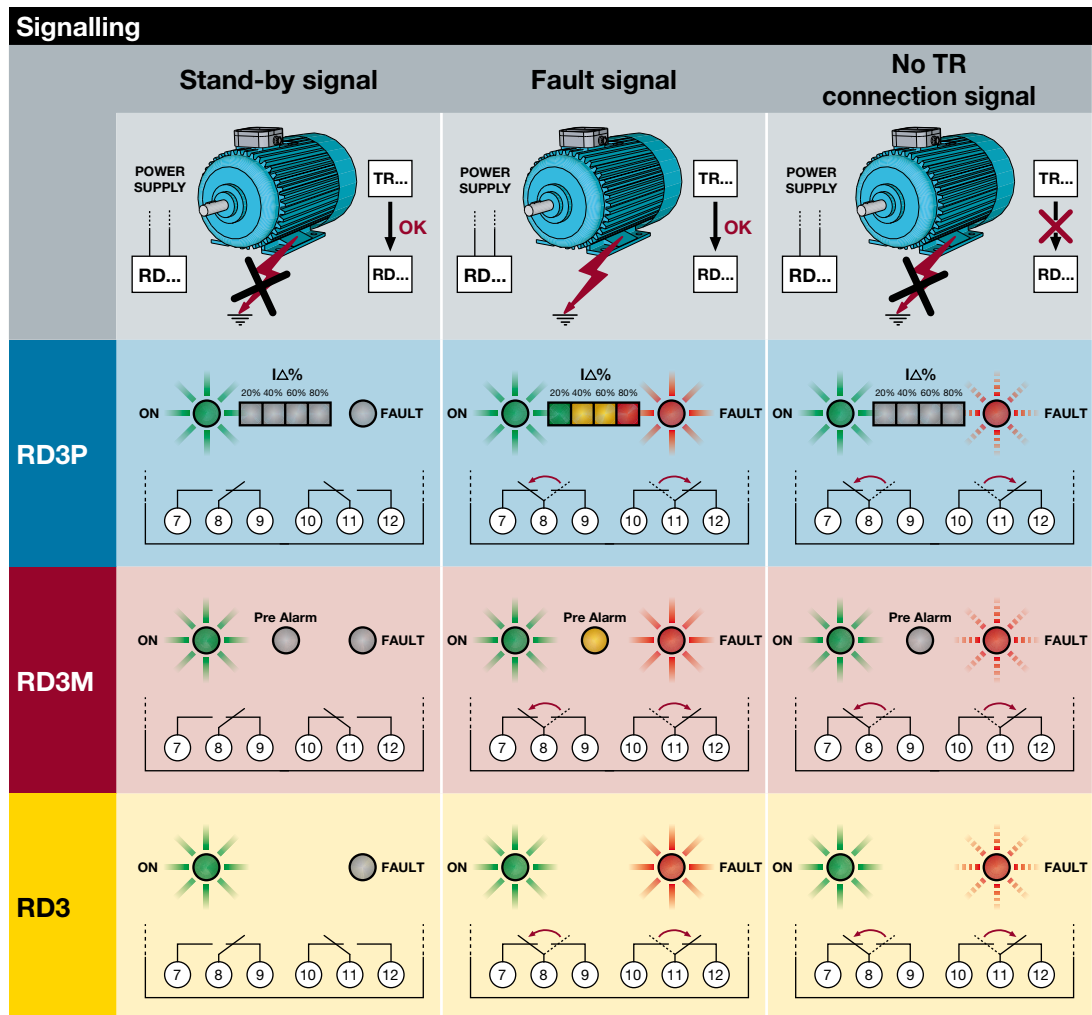

Fault status

When the value of the residual current detected by the toroid exceeds the $I\Delta n$ threshold, RD3 device opens the circuit-breaker to which it is connected through a release coil. The device can be restored by pressing the reset button on the front panel or, remotely, by connecting the specific terminals as shown below.

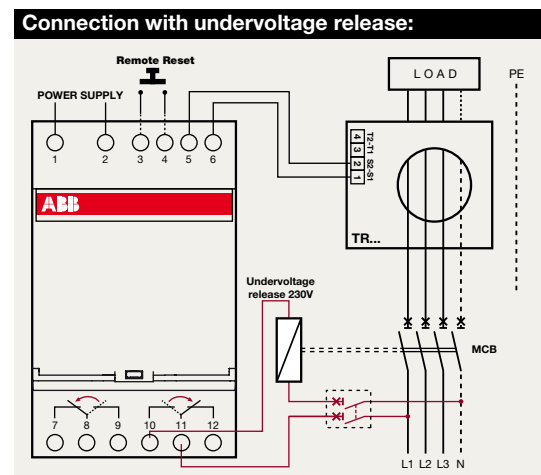
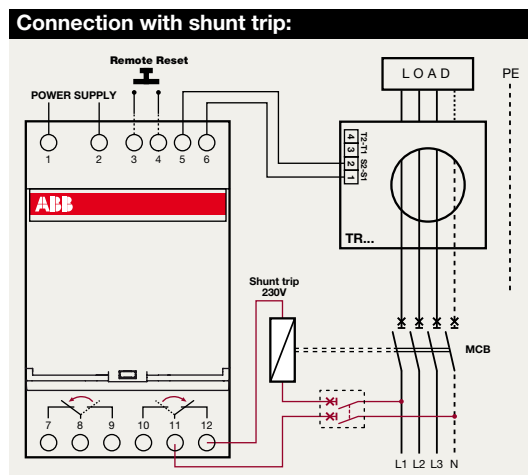

Order details

RD3 Residual current devices					
Type code	Operating voltage	Modules	ABB code	EAN code	
RD3-48	12...48Vac/dc	3	2CSJ201001R0001	748236	
RD3	230...400Vac	3	2CSJ201001R0002	734833	
RD3M-48	12...48Vac/dc	3	2CSJ202001R0001	733935	
RD3M	230...400Vac	3	2CSJ202001R0002	747031	
RD3P-48	12...48Vac/dc	3	2CSJ203001R0001	734734	
RD3P	230...400Vac	3	2CSJ203001R0002	733836	

Toroid					
Type code	Version	Ø [mm]	Weight [kg]	ABB code	EAN code
TRM	closed	39	0,170	2CSM029000R1211	020707
TR1	closed	35	0,212	2CSG035100R1211	020301
TR2	closed	60	0,274	2CSG060100R1211	020400
TR3	closed	80	0,454	2CSG080100R1211	020509
TR4	closed	110	0,530	2CSG110100R1211	020608
TR160	closed	160	0,600	2CSG160100R1211	743507
TR5	closed	210	1,350	2CSG210100R1211	024804
TR4/A	openable	110	1,600	2CSG110100R1211	743408
TR160/A	openable	160	1,534	2CSG160200R1211	743606
TR5/A	openable	210	1,856	2CSG210200R1211	065708



RCQ020

Wiring diagrams and order details



Connection with the shunt opening release

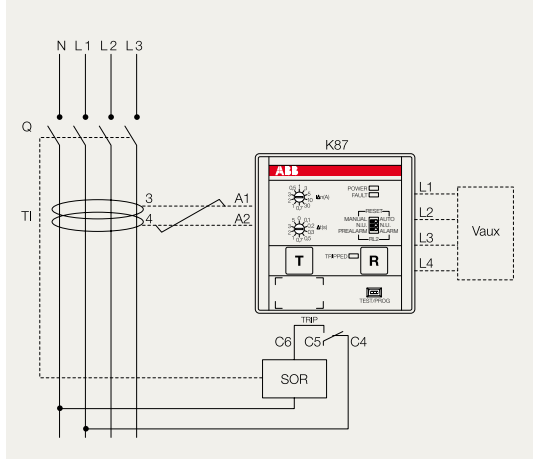

Connection with the undervoltage release

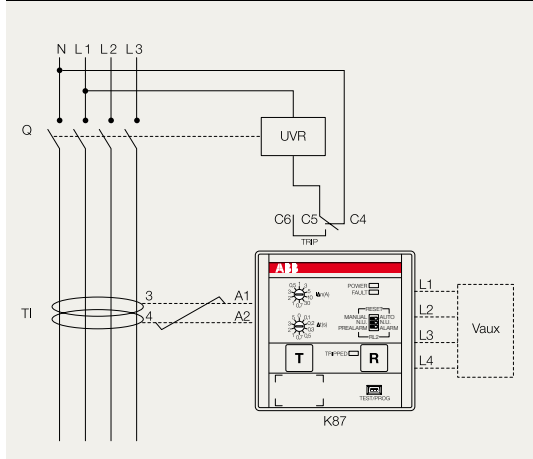

Order details

RCQ020 Residual current devices

Type	Operating voltage	Order code
RCQ020/A	115V-230Vca	065979
RCQ020/A	415Vca	065980

Toroids

Type	Version	Ø [mm]	Order code
ø 60 mm	closed	60	037394
ø 110 mm	closed	110	037395
ø 185 mm	closed	185	050543

RD3 and RCQ020

Overall dimensions

RD3

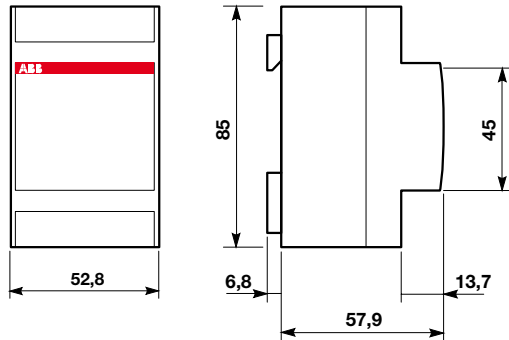

Toroids for RD3

TRM

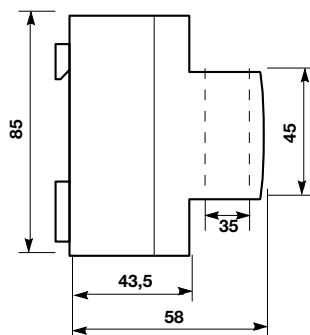
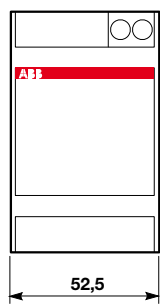

TR1, TR2, TR3, TR4, TR4A, TR160, TR160A, TR5, TR5A

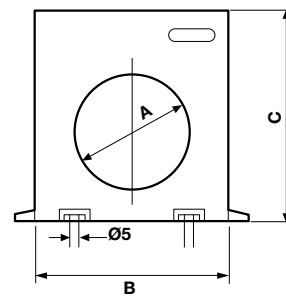
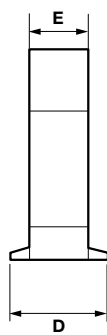

Type	A	B	C	D	E
TR1	35	100	110	50	30
TR2	60	100	110	50	30
TR3	80	150	160	50	30
TR4	110	150	160	50	30
TR4A	110	145	150	45	25
TR160	160	220	236	64	34
TR160A	160	220	236	64	34
TR5	210	310	290	260	36
TR5A	210	310	290	260	36

RCQ020

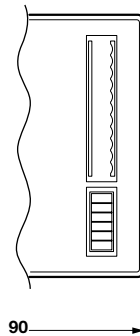
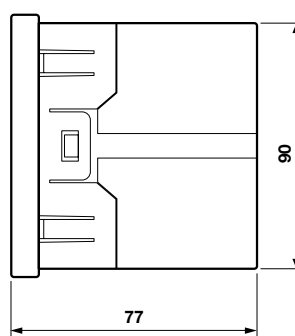
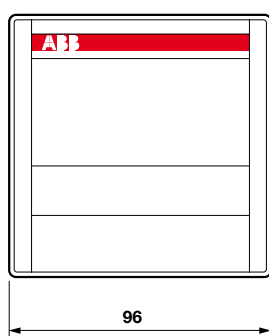

Toroids for RCQ020

Toroid Ø 60 mm

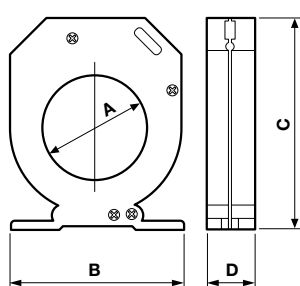

Toroid Ø 110 mm

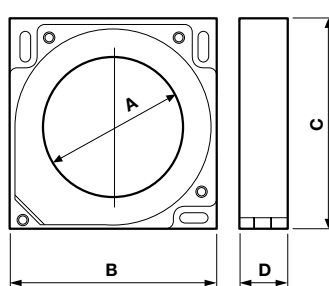

Toroid Ø 185 mm

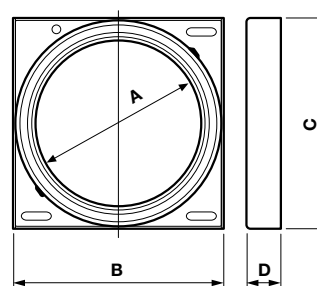

Diameter	A	B	C	D
60	60	94	118	25
110	110	160	165	40
185	185	236	236	38

Dimensions in mm



Due to possible developments of standards as well as of materials, the characteristics and dimensions specified in the present document may only be considered binding after confirmation by ABB SACE.

2CSC444001B0201 - 10/2008
Printed in Italy
3.000 - CAL

ABB SACE

A division of ABB S.p.A.

L.V. Breakers

Via Baioni, 35

24123 Bergamo - Italy

Tel.: +39 035.395.111 - Telefax: +39 035.395.306-433

Line Protection Devices

Viale dell'Industria, 18

20010 Vittuone (MI) - Italy

Tel.: +39 02.9034.1 - Telefax: +39 02.9034.7609

<http://www.abb.com>