



Technical catalog

Retrofitting kits for Low Voltage Air Circuit-Breakers and Moulded Case Circuit-Breakers

ABB SACE Service is more than service,
it is a whole factory at your disposal.
A team of experts are always ready to
support you.

ABB SACE Service offers a wide range of solutions from the delivery of the single original spare part to a complete predictive maintenance (LEAP). Personalized maintenance programs ensure an efficient plant and ensuring service continuity.

ABB SACE Service is more than a service:
It is a global factory at your full disposal.

ABB SACE history

SACE (Società Anonima Costruzioni Elettromeccaniche) was founded in 1918. Today ABB SACE, after the merger with international groups BBC in 1970 and ABB in 1988, is a modern global company, leader in low voltage circuit-breaker all over the world.

The successful products of ABB SACE:

- 1952: birth of the first low voltage moulded case circuit-breaker, Z2
- 1956: Z150 and Fusol family
- 1961: Otomax air circuit-breakers
- 1975: Modul moulded case circuit-breakers
- 1979: Novomax G2 air circuit-breakers
- 1980: Limitor moulded case circuit-breakers
- 1990: Megamax air circuit-breakers
- 1993: Isomax moulded case circuit-breakers
- 1996: Emax air circuit-breakers
- 2000: Tmax moulded case circuit-breakers
- 2004: New Emax, air circuit-breakers
- 2007: birth of the smallest air circuit-breaker in ABB history, X1
- 2009: the most recent family of MCCBs Tmax XT characterized by small sizes but high performance levels.



SACE

ABB SACE

ABB
ABB SACE

Product Life Cycle Management (LCM)

For each circuit-breaker family ABB SACE defines the Product Life Cycle Management (LCM) from the development to after-sales services.

LCM represents the company's capability to effectively and efficiently manage and innovate its products and the related services during their whole life.

Every company has the responsibility to manage all the information about the LCM products and to promptly communicate it both to customers and suppliers.

LCM 2012 for ACBs

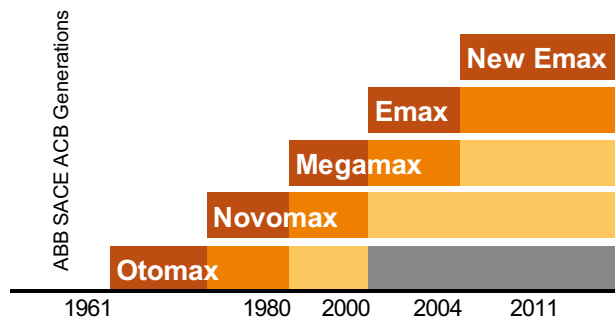

LCM 2012 for MCCBs

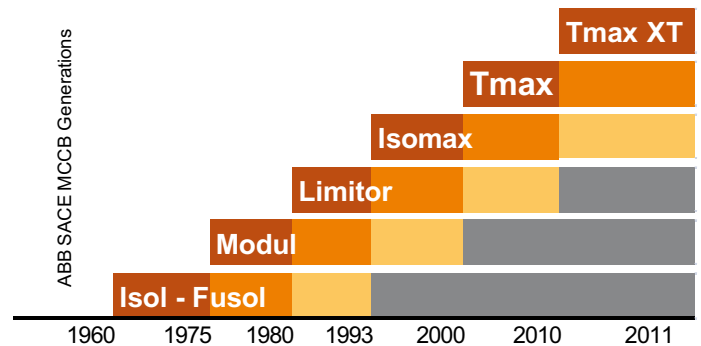

- Active** = standard development, production and sale.
- Classic** = maintenance phase of the product: availability is guaranteed for replacing in existing plants.
- Limited** = spare parts are available. The production of the CB's whole range is not guaranteed and the technical support is limited.
- Obsolete** = technical support is no more guaranteed. The production of the CB's whole range has ended but spare parts might be available. Retrofit solutions are available.

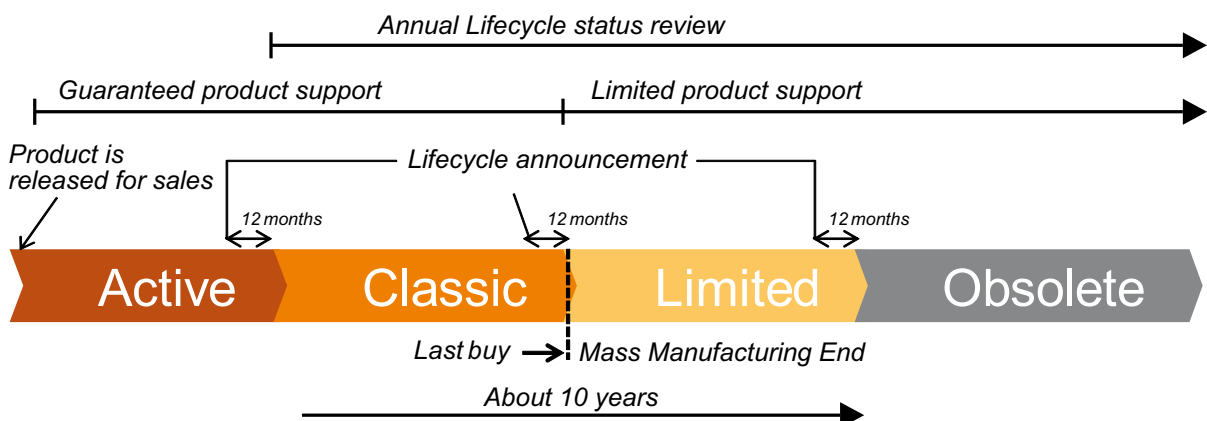

Why retrofitting?

With a few and cost-effective modifications, the retrofit kits are in most cases the ideal solution to upgrade low-voltage switchboards.

Through the wide range of the ABB SACE retrofitting kits, ABB customers can increase safety and ensure continuity of service without the need of expensive spare parts and reducing maintenance costs.

In addition, ABB SACE new Emax and Tmax XT series ensure high mechanical and electrical reliability with great flexibility, thanks to new high-technology electronic protections.

The retrofitting kit offer covers the entire range of possible needs of customers, from individual components to complete systems.



Why choosing ABB solutions?

Not all the circuit-breakers put in service several years ago meet the requirements of reliability and safety demanded today, and, although they continue to operate properly, upgrades and replacements should be planned. Routine maintenance may be insufficient to satisfy customer needs, such as improving the electrical and mechanical performances, extending the life of the system or complying with prescriptions and regulations. Functionality, safety and coordination may be key factors in the decision of replacing obsolete or inadequate products. ABB SACE Service offers its competence through consulting (identification of inadequate and / or obsolete equipment, planning interventions) and efficient service. The retrofitting kits, realised by the experience and expertise of the same designers who develop the circuit-breakers, are guaranteed by ABB only after testing both under standard and critical conditions (short circuit currents). ABB retrofit kits undergo the same tests and are certified as the whole range of ABB circuit-breakers in the ABB SpA Laboratory - ABB SACE Division. This test laboratory is recognised by the main international certification bodies such as ACAE / LOVAG, ANCE, ASTA,

ETL SEMKO, UL, CSA and Naval Registers. This laboratory offers the qualified services to perform certification tests for devices and electrical equipment for low and medium voltage, in accordance with the product standards. The Laboratory is also accredited by ACCREDIA, the agency that verifies that the tests and the documentation are performed and prepared in compliance with the accreditation's bodies.

Below the list of tests performed by ABB SACE on each retrofitting kits are detailed:

- Operational performance capability test without current for withdrawable or plug-in circuit-breakers
- Mechanical operation test of racking in and out of the moving part
- Checking of interlocks
- Protection degree
- Impulse withstand voltage test and checking of creepages
- Checking of dielectric withstand
- Checking of temperature-rise on main circuits.

ABB

To whom it may concern

LB 07LAAG 027 000 April 27, 2009

We hereby confirm that following retrofitting kit and associated circuit-breakers:

Retrofitting kit parts #	Associated CB	Replaced CB
180A98879R1	Telex KTD S 128 EXHP L50 3P	MOUL S/N 100 128 3P
180A98879R1	Telex KTD S 128 EXHP L50 4P	MOUL S/N 100 128 4P

complies with IEC 60847-2 standard requirements up to following ratings:

in	100A - 100kA
230-415Vac	45kA
500/230Vac	42kA
690Vac	35kA

ABB reference to technical file 100L000000001 rev 01

ABB S.p.A.
ABB SACE Division

ABB

To whom it may concern

LB 07 006 110 Bergamo, November 17, 2011

We hereby confirm that following retrofitting kit and associated circuit-breakers:

Retrofitting kit parts #	Associated CB	Replaced CB
180A98879R1	Telex KTD S 128 EXHP L50 3P	MOUL S/N 100 128 3P
180A98879R1	Telex KTD S 128 EXHP L50 4P	MOUL S/N 100 128 4P

complies with IEC 60847-2 standard requirements up to following ratings:

in	100A - 125A
230-240Vac	50kA
380-415Vac	30kA
440Vac	20kA
500Vac	10kA upper supply only
690Vac	10kA upper supply only

ABB reference to technical file 100L001119001 rev 01

ABB S.p.A.
ABB SACE Division

ABB

To whom it may concern

LB 07LAAG 040 000 L 017 Bergamo, June 20, 2009

We hereby confirm that following retrofitting kit and associated circuit-breakers:

Retrofitting kit parts #	Associated CB	Replaced CB
180A98879R1	Emax E18 1200 3P	MOLANAX F18 1200 3P
180A98879R1	Emax E18 1200 4P	MOLANAX F18 1200 4P

complies with IEC 60847-2 standard requirements up to following ratings:

in	1200A
230Vac	40kA
415Vac	40kA
440Vac	40kA
500/230Vac	40kA
690Vac	30kA

ABB reference to technical file 17 100L001049001 rev 01

ABB S.p.A.
ABB SACE Division

Retrofitting kits

Any replacement of obsolete equipment can be made using retrofit kits, specifically designed by ABB SACE to preserve the existing frameworks and to minimize downtime.

The use of the retrofitting kits provides several advantages:

- restoring the status of the life cycle of the switchboard;
 - maintaining the original configuration of the switchboard equipment and installation;
 - improvement of safety and reliability
 - ease of maintenance and functionality of the system;
 - low investment costs compared to those required for the installation of a new switchboard;
- planned scheduling and implementation with minimum downtime;
 - cost reduction of maintenance and repairing;
 - protection of investments;
 - full interconnectivity with the existing distribution systems;
 - easy and safe replacement;
 - no structural changes;
 - adaptations to auxiliary circuits;
 - greater control of plants with new electronic protections;
 - upgrading of the switchboard with new technology implies economic benefits as regards maintenance and spare part costs.

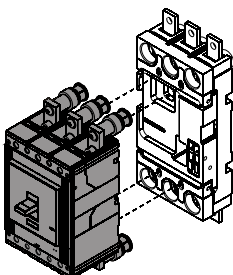
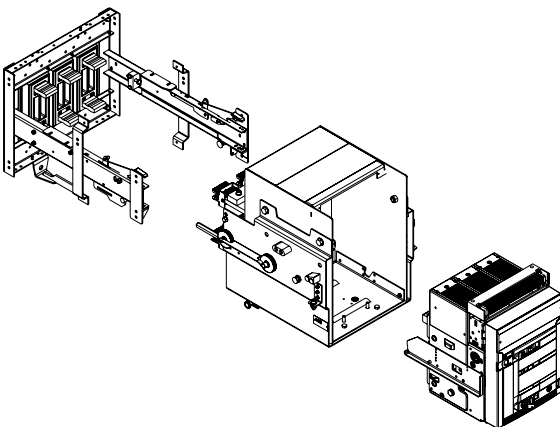
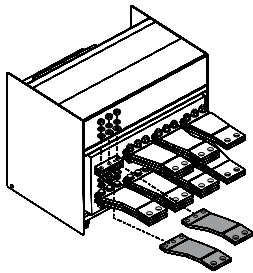

Retrofitting kit solutions

To cover all the customer demands ABB has developed different retrofitting kits:

Hard Bus Retrofill (RF): the obsolete circuit-breaker is totally removed and replaced with the new circuit-breaker. The kit contains special designed and preconfigured busbars and covers to adapt the new circuit-breaker to the existing busbars. It is necessary to order both the Fixed part and the Moving part of the New circuit-breaker.

Cradle in Cradle (CiC): the fixed part of the new circuit-breaker is suitably adapted and tested in ABB. This solution allows the new fixed part be fast fitted inside the existing fixed part.

Direct Replacement (RD): this is the fastest solution for the customer: the moving part of the old circuit-breaker is removed and the moving part of the new circuit-breaker is suitably modified and tested in ABB to be fitted into the existing fixed part. This implies very short plant shutdown of the single user. It is necessary to order the circuit-breaker in the fixed version. The kit, pre-mounted by ABB SACE, changes the fixed circuit-breaker into a proper moving part to be fitted into the existing fixed part.

Retrofitting kits

ABB SACE Service provides the following solutions:

- Spare parts
- Circuit-breakers of the same type if still available (Replacement)
- Refurbishment
- Circuit-breakers repairing at ABB site
- Corrective maintenance

- Preventive maintenance program at customer's site
- Predictive maintenance program at customer's site
- New generation of circuit-breakers to replace old circuit-breakers with retrofit kits
- Retrofitting solutions for competitors circuit-breakers (ask ABB)

ABB SACE Service's portfolio for low voltage circuit breakers:

For ACBs:

Otomax

LCM: Obsolete

- 1) Spare parts
- 2) Refurbishment
- 3) Repairing at ABB site
- 4) Retrofitting solutions:
 - Hard Bus Retrofill: Otomax - Emax
 - Cradle in Cradle: Otomax - Emax (from mid 2012)

Novomax

LCM: Limited

- 1) Spare Parts
- 2) Replacement:
 - Novomax - Novomax (only with S2 Trip unit)
- 3) Refurbishment
- 4) Repairing at ABB site
- 5) Retrofitting solutions:
 - Hard Bus Retrofill: Novomax - Emax
 - Direct Replacement: Novomax G30 - X1
 - Direct Replacement: Novomax - Megamax

Megamax

LCM: Limited

- 1) Spare Parts
- 2) Replacement: Megamax - Megamax
- 3) Refurbishment
- 4) Repairing at ABB site
- 5) Retrofitting solutions:
 - Hard Bus Retrofill: Megamax - Emax
 - Direct Replacement: Megamax - Emax (end 2012)

Emax (PR111/PR112/PR113)

LCM: Classic

- 1) Spare Parts
- 2) Replacement: Emax - Emax

For MCCBs:

Isol

LCM: Obsolete

- 1) Spare parts
- 2) Refurbishment
- 3) Repairing at ABB site
- 4) Retrofitting solutions:
 - Cradle in Cradle Isol - Isomax

Fusol

LCM: Obsolete

- 1) Spare parts
- 2) Refurbishment
- 3) Repairing at ABB site
- 4) Retrofitting solutions:
 - Cradle in Cradle: Fusol - Tmax

Modul

LCM: Obsolete

- 1) Spare parts
- 2) Refurbishment
- 3) Repairing at ABB site
- 4) Retrofitting solutions:
 - Direct Replacement:
 - Modul - Isomax/ Tmax/ Tmax XT

Limitor

LCM: Classic

- 1) Spare parts
- 2) Replacement: Limitor - Limitor
- 3) Repairing at ABB site

Isomax

LCM: Classic

- 1) Spare parts
- 2) Replacement: Isomax - Isomax
- 3) Repairing at ABB site

Retrofitting kits for ACB Solutions

It is possible to replace the previous series of Otomax, Novomax and Megamax air circuit-breakers with the new series New Emax/X1

Otomax – Emax

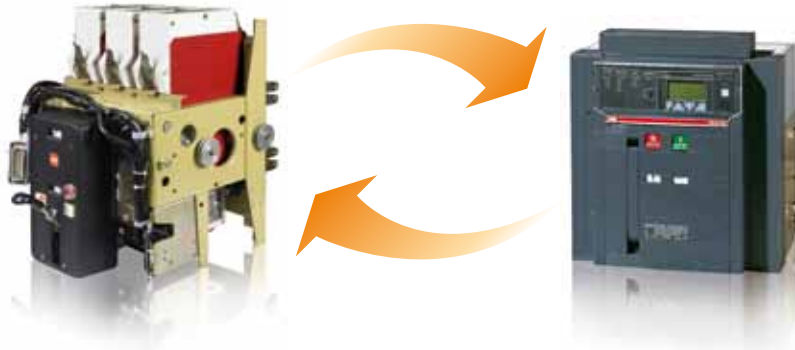

		E1	E2	E3	E4	E6
Otomax	P1A 800	3p*	3p*	3p*	3p*	3p*
	P1B 800	RF	CiC			
	P2A 800		CiC/RF			
	P1B 1000	RF	CiC			
	P1C 1000		CiC			
	P2B 1000		CiC/RF			
	P2C 1000		CiC/RF			
	P1A 1250		CiC/RF			
	P1C 1250	RF	CiC			
	P2A 1250		CiC/RF			
	P2C 1250		RF/ CiC			
	P1A 1600		RF		CiC/RF	
	P1B 1600		CiC/RF			
	P1C 1600		CiC/RF			
	P2A 1600		RF		CiC	
	P2B 1600		CiC/RF			
	P2C 1600		RF/CiC			
	P3A 1600				CiC/RF	
	P1A 2000				RF/CiC	
	P1B 2000			RF	CiC	
	P1C 2000				CiC	
	P2A 2000				CiC/RF	
	P2B 2000			RF	CiC	
	P2C 2000			RF	CiC	
	P3A 2000				RF	
	P3B 2000				CiC/RF	
	P3C 2000				CiC/RF	
	P1B 2500				CiC/RF	
	P1C 2500				CiC	
	P2B 2500				CiC/RF	
	P2C 2500				CiC/RF	
	P3B 2500				CiC/RF	
	P3C 2500				CiC/RF	
	P2A 3000					CiC
	P2B 3000					CiC
	P3A 3000					CiC/RF
	P3B 3000					CiC/RF
	P2C 3200					CiC/RF
	P3C 3200					CiC/RF
	P2A 4000					
P2B 4000						RF
P2C 4000						RF
P3B 4000						RF
P3C 4000						RF

*Ask ABB SACE for 4p

RF= Hard Bus Retrofit; CiC= Cradle in Cradle

Retrofitting kits for ACB Solutions

Novomax – Emax



		X1	E1	E2	E3
		3p/4p	3p/4p	3p/4p	3p/4p
Novomax	G30 800	DR	RF		
	G30 1250	DR	RF		
	G30 1600	DR	RF		
	G2 1250			RF	
	G2 1600			RF	
	G2 2000			RF	
	G2 2500			RF	
	G3 2000				RF
	G3 2500				RF
	G4 3200				RF

RF= Hard Bus Retrofill
DR= Direct Replacement

Retrofitting kits for ACB Solutions

Novomax – Megamax



		F1	F2	F3	F4	F5
		3p/4p	3p/4p	3p/4p	3p/4p	3p/4p
Novomax	G2 1250	DR				
	G2 1600	DR				
	G2 2000	DR				
	G2 2500		DR			
	G2 3000		DR			
	G3 2000			DR		
	G3 2500			DR		
	G3 3000			DR		
	G4 3200				DR	
	G4 3600				DR	
	G5 3200				DR	
	G5 4000				DR	
	G5 5000				DR	
	G6 6300					DR
	LG 1250	DR				
	LG 1600	DR				
	LG 2000		DR			
LG 2500		DR				

DR= Direct Replacement

Retrofitting kits for ACB Solutions

Megamax – Emax

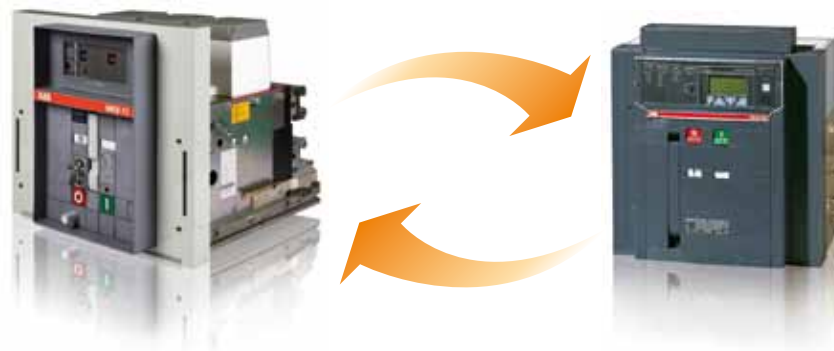

		E1	E2	E3
		3p/4p	3p/4p	3p/4p
Megamax	F1B 1250A	RF		
	F1B 1600A		RF	
	F1B 2000A		RF	
	F1N 1250A		RF	
	F1N 1600A		RF	
	F1N 2000A		RF	
	F1H 1250A		RF	
	F1H 1600A		RF	
	F1S 1250A		RF	
	F1S 1600A		RF	
	F1S 2000A		RF	
	F2S 2500A			RF
	F2H 2000A			RF
	F2H 2500A			RF
	F2L 2000A			RF
	F2L 2500A			RF
	F2V 2000A			RF
	F2V 2500A			RF
	F3S 2000A			RF
	F3S 2500A			RF
F4S 3200A			RF	

RF= Hard Bus Retrofill

Retrofitting kits for MCCB Solutions

It is possible to replace the previous series of Isol, Fusol and Modul moulded case circuit-breakers with the new series Isomax, Tmax and Tmax XT.

Isol – Isomax

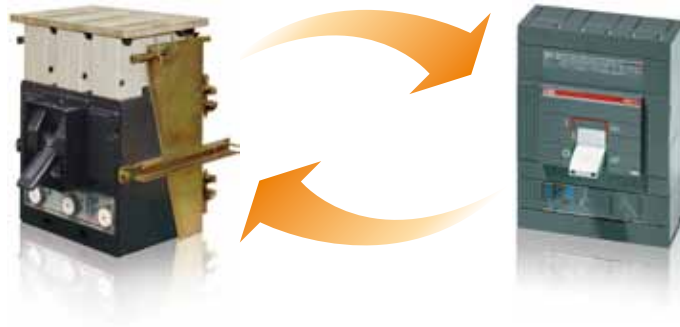

		S4	S5	S6
		3p	3p	3p
Isol	Z320	CiC	CiC	
	Z500		CiC	
	Z630			CiC
	Z800			CiC

CiC= Cradle in Cradle

Fusol – Tmax



		T6
		3p
Fusol	FZ630	CiC

CiC= Cradle in Cradle

Retrofitting kits for MCCB Solutions

Modul – Isomax/ Tmax/ Tmax XT

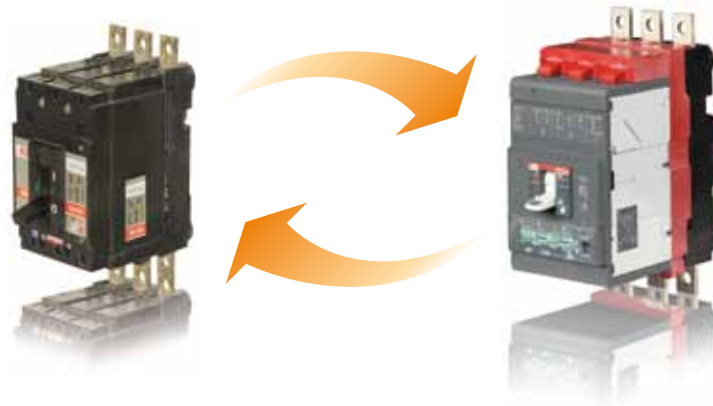

		XT2	XT4	T5	T6	S7
		3p/4p	3p/4p	3p/4p	3p/4p	3p/4p
Modul	SN100	DR				
	SH100		DR			
	SN125	DR				
	SH125		DR			
	SN160		DR			
	SH160		DR			
	SN250		DR			
	SH250		DR			
	SN400			DR		
	SH400			DR		
	SN630				DR*	
	SH630				DR*	
	SN800				DR*	
	SH800				DR*	
	SN1250					DR
	SN1600					DR

DR= Direct Replacement; * available in 2012

Retrofitting kits for ACB Otomax - Ordering codes

Circuit-breaker installed - 3 pole

New Circuit-breaker

Circuit-breaker	Version	Retrofitting kit solution	New Circuit-breaker	Version to order		3p*
Otomax P1A 800A	W (HR)	RETROFILL	E1B 800A	MP+FP (HR)	+	1SDA050748R1
Otomax P1A 1250A	W (HR)	RETROFILL	E2N 1250A	MP+FP (HR)	+	1SDA050750R1
Otomax P1A 1600A	W (HR)	RETROFILL	E2B 1600A	MP+FP (HR)	+	1SDA050751R1
Otomax P1A 2000A	W (HR)	RETROFILL	E3N 2000A	MP+FP (HR)	+	1SDA050753R1
Otomax P1B 800A	W (HR)	RETROFILL	E1B 800A	MP+FP (HR)	+	1SDA050748R1
Otomax P1B 1000A	W (HR)	RETROFILL	E1B 1250A	MP+FP (HR)	+	1SDA050748R1
Otomax P1B 1600A	W (HR)	RETROFILL	E2B 1600A	MP+FP (HR)	+	1SDA050750R1
Otomax P1B 2000A	W (HR)	RETROFILL	E2B 2000A	MP+FP (HR)	+	1SDA050751R1
Otomax P1B 2500A	W (HR)	RETROFILL	E3N 2500A	MP+FP (HR)	+	1SDA050753R1
Otomax P1C 1250A	W (HR)	RETROFILL	E1B 1250A	MP+FP (HR)	+	1SDA050748R1
Otomax P1C 1600A	W (HR)	RETROFILL	E2B 1600A	MP+FP (HR)	+	1SDA050750R1
Otomax P2A 800A	W (HR)	RETROFILL	E2N 1250A	MP+FP (HR)	+	1SDA050749R1
Otomax P2A 1250A	W (HR)	RETROFILL	E2N 1250A	MP+FP (HR)	+	1SDA050750R1
Otomax P2A 1600A	W (HR)	RETROFILL	E2N 1600A	MP+FP (HR)	+	1SDA050751R1
Otomax P2A 2000A	W (HR)	RETROFILL	E3N 2000A	MP+FP (HR)	+	1SDA050753R1
Otomax P2A 4000A	W (HR)	RETROFILL	E6H 4000A	MP+FP (HR)	+	1SDA068798R1
Otomax P2B 1000A	W (HR)	RETROFILL	E2N 1250A	MP+FP (HR)	+	1SDA050749R1
Otomax P2B 1600A	W (HR)	RETROFILL	E2N 1600A	MP+FP (HR)	+	1SDA050750R1
Otomax P2B 2000A	W (HR)	RETROFILL	E2N 2000A	MP+FP (HR)	+	1SDA050751R1
Otomax P2B 2500A	W (HR)	RETROFILL	E3N 2500A	MP+FP (HR)	+	1SDA050753R1
Otomax P2B 4000A	W (HR)	RETROFILL	E6H 4000A	MP+FP (HR)	+	1SDA068798R1
Otomax P2C 1000A	W (HR)	RETROFILL	E2N 1250A	MP+FP (HR)	+	1SDA050749R1
Otomax P2C 1250A	W (HR)	RETROFILL	E2N 1250A	MP+FP (HR)	+	1SDA050749R1
Otomax P2C 1600A	W (HR)	RETROFILL	E2N 1600A	MP+FP (HR)	+	1SDA050750R1
Otomax P2C 2000A	W (HR)	RETROFILL	E2N 2000A	MP+FP (HR)	+	1SDA050751R1
Otomax P2C 2500A	W (HR)	RETROFILL	E3N 2500A	MP+FP (HR)	+	1SDA050753R1
Otomax P2C 3200A	W (HR)	RETROFILL	E4H 3200A	MP+FP (HR)	+	1SDA050755R1
Otomax P2C 4000A	W (HR)	RETROFILL	E6H 4000A	MP+FP (HR)	+	1SDA068798R1
Otomax P3A 1600A	W (HR)	RETROFILL	E3S 1600A	MP+FP (HR)	+	1SDA050752R1
Otomax P3A 2000A	W (HR)	RETROFILL	E3S 2000A	MP+FP (HR)	+	1SDA050753R1
Otomax P3A 3000A	W (HR)	RETROFILL	E4H 3200A	MP+FP (HR)	+	1SDA050755R1
Otomax P3A 4000A	W (HR)	RETROFILL	E6H 4000A	MP+FP (HR)	+	1SDA068798R1
Otomax P3B 2000A	W (HR)	RETROFILL	E3S 2000A	MP+FP (HR)	+	1SDA050752R1
Otomax P3B 2500A	W (HR)	RETROFILL	E3S 2500A	MP+FP (HR)	+	1SDA050753R1
Otomax P3B 3000A	W (HR)	RETROFILL	E4H 3200A	MP+FP (HR)	+	1SDA050755R1
Otomax P3B 4000A	W (HR)	RETROFILL	E6H 4000A	MP+FP (HR)	+	1SDA068798R1
Otomax P3C 2000A	W (HR)	RETROFILL	E3S 2000A	MP+FP (HR)	+	1SDA050752R1
Otomax P3C 2500A	W (HR)	RETROFILL	E3S 2500A	MP+FP (HR)	+	1SDA050753R1
Otomax P3C 3200A	W (HR)	RETROFILL	E4H 3200A	MP+FP (HR)	+	1SDA050755R1
Otomax P3C 4000A	W (HR)	RETROFILL	E6H 4000A	MP+FP (HR)	+	1SDA068798R1

* For 4 pole version ask ABB SACE

W (HR) = withdrawable version with horizontal rear terminals; MP = moving part; FP (HR) = fixed part with horizontal rear terminals

Retrofitting kits for ACB Otomax - Ordering codes

Circuit-breaker installed - 3 pole

New Circuit-breaker

Circuit-breaker	Version	Retrofitting kit solution	New Circuit-breaker	Version to order		3p*
Otomax P1A 800 A	W	CRADLE in CRADLE	E2S 800	W MP	+	1SDA070222R1
Otomax P1B 800 A	W	CRADLE in CRADLE	E2S 800	W MP	+	1SDA070222R1
Otomax P2A 800 A	W	CRADLE in CRADLE	E2S 800	W MP	+	1SDA070222R1
Otomax P1B 1000 A	W	CRADLE in CRADLE	E2N 1000	W MP	+	1SDA070223R1
Otomax P1C 1000 A	W	CRADLE in CRADLE	E2N 1000	W MP	+	1SDA070223R1
Otomax P2B 1000 A	W	CRADLE in CRADLE	E2N 1000	W MP	+	1SDA070223R1
Otomax P2C 1000 A	W	CRADLE in CRADLE	E2N 1000	W MP	+	1SDA070223R1
Otomax P1A 1250 A	W	CRADLE in CRADLE	E2N 1250	W MP	+	1SDA070224R1
Otomax P1C 1250 A	W	CRADLE in CRADLE	E2N 1250	W MP	+	1SDA070223R1
Otomax P2A 1250 A	W	CRADLE in CRADLE	E2N 1250	W MP	+	1SDA070224R1
Otomax P2C 1250A	W	CRADLE in CRADLE	E2N 1250	W MP	+	1SDA070224R1
Otomax P1B 1600 A	W	CRADLE in CRADLE	E2N 1600	W MP	+	1SDA070224R1
Otomax P1C 1600 A	W	CRADLE in CRADLE	E2N 1600	W MP	+	1SDA070224R1
Otomax P2B 1600 A	W	CRADLE in CRADLE	E2N 1600	W MP	+	1SDA070224R1
Otomax P2C 1600 A	W	CRADLE in CRADLE	E2N 1600	W MP	+	1SDA070224R1
Otomax P1A 1600 A	W	CRADLE in CRADLE	E3S 1600	W MP	+	1SDA070225R1
Otomax P2A 1600 A	W	CRADLE in CRADLE	E3S 1600	W MP	+	1SDA070225R1
Otomax P3A 1600A	W	CRADLE in CRADLE	E3S 1600	W MP	+	1SDA070225R1
Otomax P1A 2000 A	W	CRADLE in CRADLE	E3S 2000	W MP	+	1SDA070226R1
Otomax P1B 2000 A	W	CRADLE in CRADLE	E3S 2000	W MP	+	1SDA070225R1
Otomax P1C 2000 A	W	CRADLE in CRADLE	E3S 2000	W MP	+	1SDA070225R1
Otomax P2A 2000A	W	CRADLE in CRADLE	E3S 2000	W MP	+	1SDA070226R1
Otomax P2B 2000 A	W	CRADLE in CRADLE	E3S 2000	W MP	+	1SDA070225R1
Otomax P2C 2000 A	W	CRADLE in CRADLE	E3S 2000	W MP	+	1SDA070225R1
Otomax P3B 2000A	W	CRADLE in CRADLE	E3S 2000	W MP	+	1SDA070225R1
Otomax P3C 2000A	W	CRADLE in CRADLE	E3S 2000	W MP	+	1SDA070225R1
Otomax P1B 2500A	W	CRADLE in CRADLE	E3N 2500	W MP	+	1SDA070231R1
Otomax P1C 2500A	W	CRADLE in CRADLE	E3N 2500	W MP	+	1SDA070231R1
Otomax P2B 2500A	W	CRADLE in CRADLE	E3N 2500	W MP	+	1SDA070231R1
Otomax P2C 2500A	W	CRADLE in CRADLE	E3N 2500	W MP	+	1SDA070231R1
Otomax P3B 2500A	W	CRADLE in CRADLE	E3S 2500	W MP	+	1SDA070226R1
Otomax P3C 2500A	W	CRADLE in CRADLE	E3S 2500	W MP	+	1SDA070226R1
Otomax P2A 3000A	W	CRADLE in CRADLE	E4H 3200	W MP	+	1SDA070232R1
Otomax P2B 3000A	W	CRADLE in CRADLE	E4H 3200	W MP	+	1SDA070232R1
Otomax P3A 3000A	W	CRADLE in CRADLE	E4H 3200	W MP	+	1SDA070232R1
Otomax P3B 3000A	W	CRADLE in CRADLE	E4H 3200	W MP	+	1SDA070232R1
Otomax P2C 3200A	W	CRADLE in CRADLE	E4H 3200	W MP	+	1SDA070232R1
Otomax P3C 3200A	W	CRADLE in CRADLE	E4H 3200	W MP	+	1SDA070232R1

* For 4 pole version ask ABB SACE

W = withdrawable version; MP = moving part

Retrofitting kits for ACB

Novomax and Megamax - Ordering codes

Novomax

Circuit-breaker	Version	Retrofitting kit solution	New Circuit-breaker	Version to order		3p	4p
Novomax G30 800A	W (HR)	REPLACEMENT	X1N 800A*	F (HR)	+	1SDA067137R1	1SDA067138R1
Novomax G30 1250A	W (HR)	REPLACEMENT	X1N 1250A*	F (HR)	+	1SDA067137R1	1SDA067138R1
Novomax G30 1600A	W (HR)	REPLACEMENT	X1N 1600A*	F (HR)	+	1SDA067133R1	1SDA067136R1
Novomax G30 800A	W (HR)	RETROFILL	E1N 800A	MP+FP (HR)	+	1SDA050758R1	1SDA050760R1
Novomax G30 1250A	W (HR)	RETROFILL	E1N 1250A	MP+FP (HR)	+	1SDA050758R1	1SDA050760R1
Novomax G30 1600A	W (HR)	RETROFILL	E2N 1600A	MP+FP (HR)	+	1SDA050757R1	1SDA050759R1
Novomax G2 1250A	W (HR)	RETROFILL	E2N 1250A	MP+FP (HR)	+	1SDA063819R1	1SDA063821R1
Novomax G2 1600A	W (HR)	RETROFILL	E2N 1600A	MP+FP (HR)	+	1SDA066014R1	1SDA066015R1
Novomax G2 2000A	W (HR)	RETROFILL	E2N 2000A ¹⁾	MP+FP (HR)	+	1SDA063820R1	1SDA063822R1
Novomax G2 2500A	W (HR)	RETROFILL	E3N 2500A	MP+FP (HR)	+	1SDA069046R1	1SDA069047R1
Novomax G3 2000A	W (HR)	RETROFILL	E3S 2000A	MP+FP (HR)	+	1SDA069048R1	1SDA069049R1
Novomax G3 2500A	W (HR)	RETROFILL	E3S 2500A	MP+FP (HR)	+	1SDA069048R1	1SDA069049R1
Novomax G4 3200A	W (HR)	RETROFILL	E3S 3200A ²⁾	MP+FP (HR)	+	1SDA069050R1	1SDA069051R1

F = fixed version of CB; MP = moving part; FP = Fixed part; HR = horizontal terminals; * G30-X1 kits are preassembled in ABB SACE; ¹⁾ In max = 1800A; ²⁾ In max = 2450A

Circuit-breaker	Version	Retrofitting kit solution	New Circuit-breaker	Version to order		Retrofitting kit code*	
						3p	4p
Novomax G2 1250A	W - MP	DIRECT REPLACEMENT	F1S	MP	+	UXAB269399201	UXAB269399201
Novomax G2 1600A	W - MP	DIRECT REPLACEMENT	F1S	MP	+	UXAB269399202	UXAB269399202
Novomax G2 2000A	W - MP	DIRECT REPLACEMENT	F1S	MP	+	UXAB269399203	UXAB269399203
Novomax G2 2500A	W - MP	DIRECT REPLACEMENT	F2S	MP	+	UXAB269499201	UXAB269499201
Novomax G2 3000A	W - MP	DIRECT REPLACEMENT	F2S	MP	+	UXAB269499202	UXAB269499202
Novomax G3 2000A	W - MP	DIRECT REPLACEMENT	F3S	MP	+	UXAB269599201	UXAB269599201
Novomax G3 2500A	W - MP	DIRECT REPLACEMENT	F3S	MP	+	UXAB269599201	UXAB269599201
Novomax G3 3000A	W - MP	DIRECT REPLACEMENT	F3S	MP	+	UXAB269599201	UXAB269599201
Novomax G4 3200A	W - MP	DIRECT REPLACEMENT	F4S	MP	+	UXAB269699201	UXAB269699201
Novomax G4 3600A	W - MP	DIRECT REPLACEMENT	F4S	MP	+	UXAB269699201	UXAB269699201
Novomax G5 3200A	W - MP	DIRECT REPLACEMENT	F5S	MP	+	UXAB269799201	UXAB269799201
Novomax G5 4000A	W - MP	DIRECT REPLACEMENT	F5S	MP	+	UXAB269799202	UXAB269799202
Novomax G5 5000A	W - MP	DIRECT REPLACEMENT	F5S	MP	+	UXAB269799202	UXAB269799202
Novomax G6 6300A	W - MP	DIRECT REPLACEMENT	F6S	MP	+	UXAB269899201	UXAB269899201
Novomax LG 1250A	W - MP	DIRECT REPLACEMENT	F1L	MP	+	UXAB249499201	UXAB249499201
Novomax LG 1600A	W - MP	DIRECT REPLACEMENT	F1L	MP	+	UXAB249499202	UXAB249499202
Novomax LG 2000A	W - MP	DIRECT REPLACEMENT	F2L	MP	+	UXAB249499203	UXAB249499203
Novomax LG 2500A	W - MP	DIRECT REPLACEMENT	F2L	MP	+	UXAB249499204	UXAB249499204

W - MP = Moving part; * All the Novomax-Megamax retrofitting kits are preassembled in ABB SACE.

Megamax

Circuit-breaker	Version	Retrofitting kit solution	New Circuit-breaker	Version to order		3p	4p
Megamax F1B 1250A	W (HR)	RETROFILL	E1B 1250A	MP+FP (HR)*	+	1SDA063802R1	1SDA063812R1
Megamax F1B 1600A	W (HR)	RETROFILL	E2B 1600A	MP+FP (HR)*	+	1SDA063807R1	1SDA063814R1
Megamax F1B 2000A	W (HR)	RETROFILL	E2B 2000A ¹⁾	MP+FP (HR)*	+	1SDA063809R1	1SDA063816R1
Megamax F1N 1250A	W (HR)	RETROFILL	E1N 1250A	MP+FP (HR)*	+	1SDA063802R1	1SDA063812R1
Megamax F1N 1600A	W (HR)	RETROFILL	E2N 1600A	MP+FP (HR)*	+	1SDA063807R1	1SDA063814R1
Megamax F1N 2000A	W (HR)	RETROFILL	E2N 2000A ¹⁾	MP+FP (HR)*	+	1SDA063809R1	1SDA063816R1
Megamax F1H 1250A	W (HR)	RETROFILL	E2S 1250A	MP+FP (HR)*	+	1SDA068799R1	1SDA068800R1
Megamax F1H 1600A	W (HR)	RETROFILL	E2S 1600A	MP+FP (HR)*	+	1SDA063810R1	1SDA063817R1
Megamax F1S 1250A	W (HR)	RETROFILL	E2N 1250A	MP+FP (HR)*	+	1SDA068799R1	1SDA068800R1
Megamax F1S 1600A	W (HR)	RETROFILL	E2N 1600A	MP+FP (HR)*	+	1SDA063807R1	1SDA063814R1
Megamax F1S 2000A	W (HR)	RETROFILL	E2N 2000A ¹⁾	MP+FP (HR)*	+	1SDA063809R1	1SDA063816R1
Megamax F2S 2500A	W (HR)	RETROFILL	E3N 2500A	MP+FP (HR)*	+	1SDA063826R1	1SDA063833R1
Megamax F2H 2000A	W (HR)	RETROFILL	E2S 2000A ¹⁾	MP+FP (HR)*	+	1SDA063823R1	1SDA063827R1
Megamax F2H 2500A	W (HR)	RETROFILL	E3H 2500A	MP+FP (HR)*	+	1SDA063824R1	1SDA063829R1
Megamax F2L 2000A	W (HR)	RETROFILL	E3L 2000A	MP+FP (HR)*	+	1SDA063825R1	1SDA063832R1
Megamax F2L 2500A	W (HR)	RETROFILL	E3L 2500A	MP+FP (HR)*	+	1SDA063825R1	1SDA063832R1
Megamax F2V 2000A	W (HR)	RETROFILL	E3V 2000A	MP+FP (HR)*	+	1SDA063825R1	1SDA063832R1
Megamax F2V 2500A	W (HR)	RETROFILL	E3V 2500A	MP+FP (HR)*	+	1SDA063825R1	1SDA063832R1
Megamax F3S 2000A	W (HR)	RETROFILL	E3S 2000A	MP+FP (HR)*	+	1SDA063836R1	1SDA063838R1
Megamax F3S 2500A	W (HR)	RETROFILL	E3S 2500A	MP+FP (HR)*	+	1SDA063836R1	1SDA063838R1
Megamax F4S 3200A	W (HR)	RETROFILL	E3S 3200A ²⁾	MP+FP (HR)*	+	1SDA063840R1	1SDA063841R1

* The minimum cubicle dimension shall be verified with the one indicated in the Emax catalog

MP = moving part; FP (HR) = fixed part with horizontal rear terminals; W (HR) = withdrawable version with horizontal rear terminals; ¹⁾ In max = 1800A; ²⁾ In max = 2450A

For spares parts see catalog: 1SDC001007D0202.

For Megamax circuit-breakers see its catalog.

Retrofitting kits for MCCB

Isol and Modul - Ordering codes

Isol

Circuit-breaker 3p	Version	Retrofitting kit solution	New Circuit-breaker	Version to order		3p	
Isol Z320 250A	W	CRADLE in CRADLE	S4N 250A	MP	+	UXAB129599101	-
Isol Z320 320A	W	CRADLE in CRADLE	S5N 630A	MP*+FP (VR)	+	UXAB129699101	+ UXAB129699102
Isol Z500 500A	W	CRADLE in CRADLE	S5N 630A	MP+FP (VR)	+	UXAB129699101	+ UXAB129699102
Isol Z630 400A	W	CRADLE in CRADLE	S6S 630A	MP+FP (VR)	+	UXAB129799101	-
Isol Z630 500A	W	CRADLE in CRADLE	S6S 630A	MP+FP (VR)	+	UXAB129799101	-
Isol Z630 630A	W	CRADLE in CRADLE	S6S 630A	MP+FP (VR)	+	UXAB129799101	-
Isol Z800 800A	W	CRADLE in CRADLE	S6S 800A	MP+FP (HR)	+	UXAB129899101	-
Fusol FZ630 400A	W	CRADLE in CRADLE	T6V 630A	MP+FP (VR)	+	UXAB139599101	-
Fusol FZ630 500A	W	CRADLE in CRADLE	T6V 630A	MP+FP (VR)	+	UXAB139599101	-
Fusol FZ630 630A	W	CRADLE in CRADLE	T6V 630A	MP+FP (VR)	+	UXAB139599101	-

* Choose the moving part of S5N to be inserted into the fixed part of S5 630A (see Isomax catalog at page 7/37).

W= Withdrawable; MP= Moving part; FP (VR)= Fixed part with vertical terminals; FP (HR) = Fixed part with horizontal terminals; all the Isol/Fusol fixed part are pre-assembled in ABB SACE.

For spare parts see the catalog 1SDC001007D0202.

Remember to order all the accessories for the application.

Verify the compatibility between the new accessories and the switchboard.

Modul

Circuit-breaker	Version	Retrofitting kit solution	New Circuit-breaker	Version to order		3p	4p
Modul SN 100	P	REPLACEMENT	XT2S 160A	F F	+	1SDA069678R1	1SDA069679R1
Modul SN 125	P	REPLACEMENT	XT2S 160A	F F	+	1SDA069678R1	1SDA069679R1
Modul SN 160	P	REPLACEMENT	XT4S 250A	F F	+	1SDA069459R1	1SDA069460R1
Modul SN 250	P	REPLACEMENT	XT4S 250A	F F	+	1SDA069459R1	1SDA069460R1
Modul SN 400	P	REPLACEMENT	T5S 400A	F F	+	1SDA069463R1	1SDA069464R1
Modul SH 100	P	REPLACEMENT	XT4H 250A	F F	+	1SDA069457R1	1SDA069458R1
Modul SH 125	P	REPLACEMENT	XT4H 250A	F F	+	1SDA069457R1	1SDA069458R1
Modul SH 160	P	REPLACEMENT	XT4H 250A	F F	+	1SDA069461R1	1SDA069462R1
Modul SH 250	P	REPLACEMENT	XT4H 250A	F F	+	1SDA069461R1	1SDA069462R1
Modul SH 400	P	REPLACEMENT	T5H 400A	F F	+	1SDA069465R1	1SDA069466R1
Modul SN 630 ES**	P	REPLACEMENT	T6S 630A 3p	F F	+	1SDA070218R1	1SDA070219R1
Modul SN 630 SEZ**	W	REPLACEMENT	T6S 630A 3p	F F	+	1SDA070252R1	1SDA070253R1
Modul SH 630 ES**	P	REPLACEMENT	T6H 630A 3p	F F	+	1SDA070218R1	1SDA070219R1
Modul SH 630 SEZ**	W	REPLACEMENT	T6H 630A 3p	F F	+	1SDA070252R1	1SDA070253R1
Modul SN 800 SEZ**	W	REPLACEMENT	T6S 800A 3p	F F	+	1SDA070220R1	1SDA070221R1
Modul SH 800 SEZ**	W	REPLACEMENT	T6H 800A 3p	F F	+	1SDA070220R1	1SDA070221R1
Modul SN1250	P	REPLACEMENT	S7S 1250A	F F*	+	UXAB149199101	UXAB149199102
Modul SN1600	P	REPLACEMENT	S7S 1600A	F F*	+	UXAB149199103	UXAB149199104
Modul SH1250	P	REPLACEMENT	S7L 1250A	F F*	+	UXAB149199101	UXAB149199102
Modul SH1600	P	REPLACEMENT	S7L 1600A	F F*	+	UXAB149199103	UXAB149199104

* Order with high upper terminal covers and frontal lever; ** Available from mid 2012.

P= Plug-in; -F F = Fixed circuit-breaker with front terminals; all the circuit-breakers are pre-assembled in ABB SACE.

For spare parts see the catalog 1SDC001007D0202.

Remember to order all the accessories for the application.

Verify the compatibility between the new accessories and the switchboard.

Order examples

1) Direct Replacement → G30-X1

i.e.: Breaker to replace: G30 1600A 3 poles withdrawable:

Circuit-breaker	Version	Retrofitting kit solution	New Circuit-breaker	Version to order		3p	4p
Novomax G30 800A	W (HR)	REPLACEMENT	X1N 800A*	F (HR)	+	1SDA067137R1	1SDA067138R1
Novomax G30 1250A	W (HR)	REPLACEMENT	X1N 1250A*	F (HR)	+	1SDA067137R1	1SDA067138R1
Novomax G30 1600A	W (HR)	REPLACEMENT	X1N 1600A*	F (HR)	+	1SDA067133R1	1SDA067136R1

A
B
C

Choose the trip unit for the circuit-breaker X1N 1600A in fixed version among the ones available: PR331/P, PR332/P and PR333/P and all the required accessories: i.e. PR332/P LSI:

POS 1: 1SDA062609R1 → X1N 16000 (A) PR332/P LSI Fixed (B) 3p (C) (+ accessories to specify)

1SDA062609R1 → Horizontal rear terminals (HR) (B) (+ accessories to specify)

POS 2: 1SDA063122R1 → Retrofitting kit

The X1 is pre-assembled in a ABB SACE

2) Retrofill → Otomax – Emax

i.e.: Breaker to replace: Otomax P1A 800A 3 poles with horizontal rear terminals:

Circuit-breaker	Version	Retrofitting kit solution	New Circuit-breaker	Version to order		3p*
Otomax P1A 800A	W (HR)	RETROFILL	E1B 800A	MP+FP (HR)	+	1SDA050748R1

A
B
C

Choose the trip unit for New Emax: PR121/P, PR122/P and PR123/P and all the required accessories:

i.e. PR121/P LI:

POS 1: 1SDA055616R1 → Moving part (B) of E1B 800A (A) PR121/LI 3p (+ accessories to specify)

POS 2: 1SDA059666R1 → Fixed part with horizontal rear terminals for E1 (C) (+ accessories to specify)

POS 3: 1SDA063122R1 → Retrofitting kit

3) Cradle in Cradle: Otomax – Emax

i.e.: Breaker to replace: Otomax P2A 2000A 3 poles withdrawable

Circuit-breaker	Version	Retrofitting kit solution	New Circuit-breaker	Version to order		3p*
Otomax P2A 2000A	W	CRADLE/CRADLE	E3S 2000A	W MP	+	1SDA070226R1

A
B

Choose the trip unit for New Emax among the ones available: PR121/P, PR122/P and PR123/P and all the required accessories: i.e. PR121/P LI:

POS 1: 1SDA056260R1 → Moving part (B) of E3S 2000A (A) PR122/LSI 3p (+ accessories to specify)

POS 2: 1SDA070226R1 → Retrofitting kit (the kit includes the Fixed part with horizontal rear terminals (+ accessories to specify)).

4) Direct Replacement: Modul-Tmax XT

i.e.: Breaker to replace: Modul SN 250 3 poles Plug in

Circuit-breaker	Version	Retrofitting kit solution	New Circuit-breaker	Version to order		3p	4p
Modul SN 100	P	REPLACEMENT	XT2S 160A	F F	+	1SDA069678R1	1SDA069679R1
Modul SN 125	P	REPLACEMENT	XT2S 160A	F F	+	1SDA069678R1	1SDA069679R1
Modul SN 160	P	REPLACEMENT	XT4S 250A	F F	+	1SDA069459R1	1SDA069460R1
Modul SN 250	P	REPLACEMENT	XT4S 250A	F F	+	1SDA069459R1	1SDA069460R1

A
B
C

Choose the electronic trip unit for the circuit-breaker Tmax XT4 3p in fixed version: Ekip I or Ekip LSI. i.e. Ekip LSI:

POS 1: 1SDA068485R1 → Tmax XT XT4S 250A (A) with Ekip LSI 3p in fixed version (B) and with Front terminals (C) (+ accessories to specify).

POS 2: 1SDA069459R1 → Kit di Retrofitting. T4 is pre-assembled in a ABB SACE and ready to be mounted.

ABB SACE Services

ABB Low Voltage Service

Contact us
www.abb.com/service

Publisher Editor:

Benelux (Belgium, Nederland, Luxemburg)
Hotline: +311 0407 8539

France
Hotline: 0 810 020 000
Tel.: +33 01 34 40 25 81

Switzerland
Hotline: +41 844 845 845

Austria
Hotline: +43 662 850150-6535

Germany
Hotline: +49 (0)6221-701-1411

Turkey
Tel.: +902165282357
Tel.: +905339206951

Norway
Tel.: +47 35 58 25 95
Hotline: +47 95 70 86 77

Finland
Tel.: +358 10 22 21999

Denmark
Tel.: +45 79 24 78 20
Hotline: +45 44 50 44 50

Thailand
Tel.: +66-81-830-6246
Tel.: +66-2-665-1000

India
Tel.: +91 80 2294 8928

China
Hotline: 400-820-9696

Brazil
Tel.: +55 11 3688 9781
Hotline: 0800 014 91 11
Hotline: 0800 012 25 00

Argentina
Tel.: +54 11 4229-5823

Australia
Hotline: +61 1300 660 299

UK
Tel.: +44 (0)2476 368 500

Spain
Tel.: +34 93 700 1515

Colombia
Hotline: +01 8000 522 226
Tel.: +57-1-417 8000

Peru
Hotline: + 51 1 415 5100 ext 1737

Saudi Arabia
Hotline: +966 5 4675 9885

Malaysia
Tel.: +60356284468
Tel.: +60356284888

United Arab Emirates
Hotline: +971 4 3147500

Chile
Tel.: +56 2 6514745

Singapore
Hotline: +65 6222 7778

Italy
Tel. (orario di ufficio): +39 035 6952900
Hotline: +39 02 24159980

Mexico
Tel.: +52 5536019700

USA
Tel.: +1 8883851221

Egypt
Tel.: +2 0226251380

Sweden
Tel.: +46 313392146

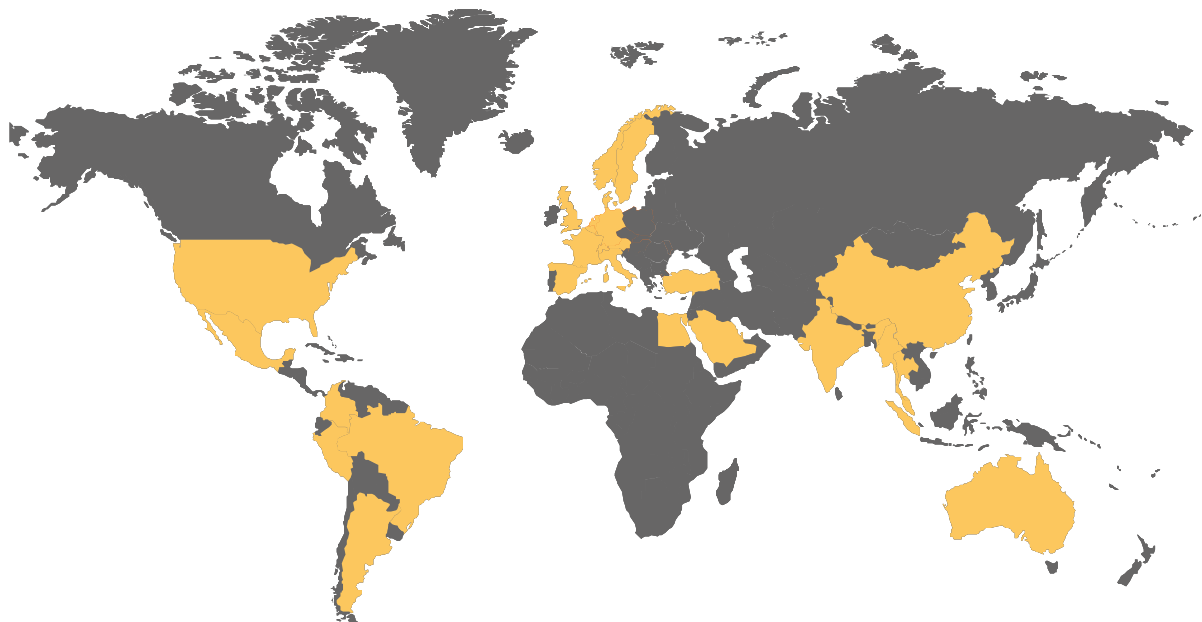

Contacts

ABB SACE

A division of ABB S.p.A.

Low Voltage Service

24044 Dalmine (BG) - Italy

Via Friuli, 4

www.abb.com

www.abb.com/service

The data and illustrations are not binding.
We reserve the right to make changes in the
course of technical development of the product.

Copyright 2012 ABB.
All rights reserved.

1SDC001008D0202 - 2012.02