

Softstarters

Type PST/PSTB

Fieldbus communication

Modbus for PST sw CU 05.05.00

1SFC132056M0201,
August 2009

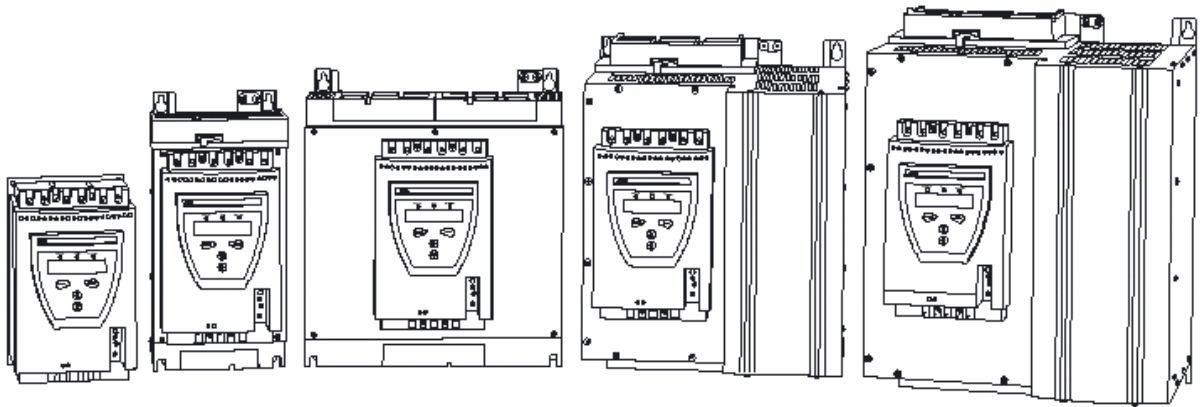

ABB

Modbus

The Modbus protocol are fieldbus protocols that provides full control and status information of the softstarter as well as writing of parameters. Through the fieldbus it is possible to start and stop the motor, perform jog, sequence start, read out currents and frequency, achieve information about protections, warnings, faults and much more. See chapter “Setting and configuration” in the installation manual for programming of the inputs / outputs.

Before the Modbus fieldbus can be taken in operation following parameters must be set in the softstarter:

- Parameter *Fieldbus Ctrl* set to Yes
- Parameter *Fieldbus Type* set to other
- Parameter *Fieldbus Addr* set to a free communication address.

For technical data and descriptions of the Modbus fieldbus plug, see document 2CDC194001D0201 available at www.abb.com/lowvoltage .

Note that the set-up varies depending on used softstarter version and this document describes the softstarter software version CU 05.04.04 which can be checked in the softstarter display Menu -> STATUS INFORMATION - > SW Ver CU xx.xx.xx.. Please check the actual softstarter version you have in your case!



Caution!

The motor may start unexpectedly if there is a start signal present when doing any of the actions listed below.

- *Switching from one type of control to another (fieldbus control / hardwire control)*
- *Re-programming of the programmable inputs*
- *Reset all Settings (programmable input set to Enable)*

Binary input telegram
To PLC from Softstarter.

Word in input data area	Binary input byte	Bit	Data	Description	
0	0	0	K4 relay output	Status of K4	
		1	K5 relay output	Status of K5	
		2	K6 relay output	Status of K6	
		3	V7 Programmable software output	Status of V7	
		4	Start Input	Status of Start Input	
		5	Stop Input	Status of Stop Input	
		6	In0 Input	Status of In0	
	1	7	7	In1 Input	Status of In1
			8 (0)	Run	Run Status
			9 (1)	Top Of Ramp	Top Of Ramp Status
			10 (2)	Line or Inside Delta connection	0 = Line, 1 = Delta
			11 (3)	Phase sequence	0 = L1,L2,L3 1=L1,L3,L2
			12 (4)	Prot Motor OL	Event Status
			13 (5)	Prot Locked Rot	Event Status
			14 (6)	Prot Underload	Event Status
1	2	15 (7)	Prot Phase Imb	Event Status	
		0	Prot High I	Event Status	
		1	Prot Phase Rev	Event Status	
		2	Prot PTC	Event Status	
		3	Dummy		
		4	Prot SCR OL	Event Status	
		5	Warn OL	Event Status	
	3	6	6	Warn SCR OL	Event Status
			7	Warn I=High	Event Status
			8 (0)	Warn I=Low	Event Status
			9 (1)	Fault (general signal)	Event Status, general for all faults
			10 (2)	Fault Phase Loss	Event Status
			11 (3)	Fault SC SCR	Event Status
			12 (4)	Fault Open SCR	Event Status
			13 (5)	Fault Wrong Freq	Event Status
2	4	14 (6)	Fault Connection	Event Status	
		15 (7)	Fault Internal	Event Status	
		0	Fault FB Timeout	Event Status	
		1	Fault HS Temp	Event Status	
		2	Fault Line side	Event Status	
		3	Fault BP closed	Event Status	
		4	Fault BP open	Event Status	
	5	5	5	Dummy	
			6	Shunt Fault	Event Status
			7	Fault Line/Delta	Event Status
			8 (0)	Local Control	0 = Other control, 1 = Key-pad control
			9 (1)	OK to start	0 = A start will probably cause a fault, 1 = A start will probably not cause a fault
			10 (2)	Spare (Value = 0)	
			11 (3)	Spare (Value = 0)	
			12 (4)	Spare (Value = 0)	
		13 (5)	Spare (Value = 0)		
		14 (6)	Spare (Value = 0)		
		15 (7)	Spare (Value = 0)		

Analogue input telegram

To PLC from Softstarter.

All analogue data will be represented as 16 bit values.

Word in input data area	Analogue input word	Data	Representation
3	0	Phase current L1 *)	Value =1000 ⇒ 1000A
4	1	Phase current L2 *)	Value =1000 ⇒ 1000A
5	2	Phase current L3 *)	Value =1000 ⇒ 1000A
6	3	Max phase current *)	Value =1000 ⇒ 1000A
7	4	Measured frequency	Value =100 ⇒ 100Hz
8	5	Output voltage	Value =100 ⇒ 100%
9	6	Calc. Motor temp.	Value =100 ⇒ 100%
10	7	Counted no of Starts	Value =100 ⇒ 10000 times
11	8	Run Time	Value =100 ⇒ 1000 hours

*) Phase current L1, L2 and L3 indicates the current through the softstarter while the Max phase current always is the line current.

Diagnostic inputs

There are 3 channels available for fieldbus related diagnostic messages. Each channel consists of two bytes with an error code and the parameter number that caused the error. The latest error is stored in channel 1, the second latest in channel 2 and the third latest in channel 3. The binary output bit “reset active diagnostics” is used to clear the diagnostic area.

Error Codes: 1 = Parameter Value out of range
 2 = Invalid parameter No
 3 = Write of parameter when fieldbus control isn't enabled

Word in input data area	Diagnostic input word	Error Code	Parameter No.
12	0	Diagn. Channel 1, Error Code	Diagn. Channel 1, Parameter No
13	1	Diagn. Channel 2, Error Code	Diagn. Channel 2, Parameter No
14	2	Diagn. Channel 3, Error Code	Diagn. Channel 3, Parameter No

Binary output telegram

From PLC to Softstarter.

Word in output data area	Binary output byte	Bit	Data	Description
0	0	0	Start (1 st par set if Seq.start)	Commence a start when signal is set. Start1 if sequence start.
		1	Stop	Commence a stop when signal is negated.
		2	Reset Events	Reset signal for possible events.
		3	Enable	Enable, this bit must be set for running the motor
		4	Jog	Perform Jog when signal is set.
		5	DOL start	Perform DOL start when signal is set.
		6	Start2 (2 nd par set Seq.start)	Start2 if sequence start.
		7	Start3 (3 rd par set Seq.start)	Start3 if sequence start.
	1	8 (0)	Time synchronisation	Time synchronisation signal that is used to synchronise the local real time clock with the time given as an analogue input telegram to the softstarter. If the signal is "1" and there is a difference between the times the local real time clock is synchronised.
		9 (1)	Reset active diagnostics	When set to "1" this will reset the fieldbus diagnostic area
		10 (2)	Spare	
		11 (3)	Spare	
		12 (4)	Spare	
		13 (5)	Spare	
		14 (6)	Spare	
		15 (7)	Spare	

Analogue output telegram

From PLC to Softstarter.

All analogue data will be represented as 16 bit values.

Word in output data area	Analogue output word	Data	Representation
1	0	Year	Value = 2003 ⇒ Year 2003
2	1	Month	Value = 12 ⇒ December
3	2	Day	Value = 31 ⇒ 31 st
4	3	Hour	Value = 23 ⇒ 23 h
5	4	Minutes	Value = 59 ⇒ 59 min
6	5	Seconds	Value = 59 ⇒ 59 sec

The output data is used to synchronize the softstarter real time clock with a possible system clock, it is used together with the binary output time synchronisation signal, if this signal is set to “1” and there is a difference between the clocks the local softstarter clock will be synchronised with the analogue outputs.

Input address map

	15	14	13	12	11	10	9	8	7	6	5	4	3	2	1	0
0	Binary In, Byte 1								Binary In, Byte 0							
1	Binary In, Byte 3								Binary In, Byte 2							
2	Binary In, Byte 5								Binary In, Byte 4							
3	Analogue In, Word 0															
4	Analogue In, Word 1															
5	Analogue In, Word 2															
6	Analogue In, Word 3															
7	Analogue In, Word 4															
8	Analogue In, Word 5															
9	Analogue In, Word 6															
10	Analogue In, Word 7															
11	Analogue In, Word 8															
12	Diagn. Channel 1, Error Code								Diagn. Channel 1, Parameter No							
13	Diagn. Channel 2, Error Code								Diagn. Channel 2, Parameter No							
14	Diagn. Channel 3, Error Code								Diagn. Channel 3, Parameter No							

Output address map

	15	14	13	12	11	10	9	8	7	6	5	4	3	2	1	0
0	Binary Out, Byte 1								Binary Out, Byte 0							
1	Analogue Out, Word 0															
2	Analogue Out, Word 1															
3	Analogue Out, Word 2															
4	Analogue Out, Word 3															
5	Analogue Out, Word 4															
6	Analogue Out, Word 5															

Parameters –

For this implementation all parameter values (both binary and analogue) are represented as 16 bits.

When programming, high bytes shall come before low bytes.

Parameters where it is said Type Read, can not be written from the PLC (Not possible with Modbus). Not all of the parameters in the PST(B) softstarter are visible through the Fieldbus. These are listed here but are marked hidden.

Param. No	Word No	Type	Parameter	Description	Range	Unit	Default
1	0	Write	Setting Ie	Setting current	0 – 3000 (*)	Amp	Individual
2	1	Write	Start Ramp	Time for start ramp	1 – 120	Sec	10
3	2	Write	Stop Ramp	Time for stop ramp	0 – 120	Sec	0
4	3	Write	Init Volt	Initial voltage for start ramp	30 – 70	%	30
5	4	Write	End Volt	End voltage for stop ramp	30 – 70	%	30
6	5	Write	Step Down	Voltage value to which the softstarter shall step down at stop and where it shall commence the stop ramp.	30 – 100	%	100
7	6	Write	Current Lim	Level of the current limit.	15 – 70 = 1,5 – 7,0	xIe	40
8	7	Write	Kick Start	Selection of Kick start	0=No, 1=Yes		0
9	8	Write	Kick Level	Level of Kick start if selected	50 – 100	%	50
10	9	Write	Kick Time	Time for Kick start if selected	10 – 150 = 0,1 – 1,5	Sec	20
11	10	Write	Start Range	Selectable range for start ramp	0=1-30, 1=1-120	Sec	0
12	11	Write	Stop Range	Selectable range for stop ramp	0=1-30, 1=1-120	Sec	0
13	12	Write	Overload	Overload protection	0=No, 1=Normal, 2=Dual		1
14	13	Write	OL Class	Overload Class	0=10A, 1=10, 2= 20, 3= 30		2
15	14	Write	OL Class S	Overload Class, Dual type, Start Class	0=10A, 1=10, 2= 20, 3= 30, 4=No		2
16	15	Write	OL Class R	Overload Class, Dual type, Run Class	0=10A, 1=10, 2= 20, 3= 30, 4=No		2
17	16	Write	OL Op	Type of operation for overload protection	0=Stop-M, 1=Stop-A, 2= Ind		0
18	17	Write	Locked Rotor	Locked rotor protection	0=No, 1=Yes		0
19	18	Write	Lock R Lev	Trip level for locked rotor protection	5 – 80 = 0,5 – 8,0	xIe	40
20	19	Write	Lock R Time	Trip time for locked rotor protection	20 – 100 = 0,2 – 10,0	Sec	10
21	20	Write	Lock R Op	Type of operation for locked rotor protection	0=Stop-M, 1=Stop-A, 2= Ind		0
22	21	Write	Underload	Underload protection	0 = No, 1 = Yes		0
23	22	Write	Underl Lev	Trip level for Underload protection	4 - 8 = 0,4 – 0,8	xIe	5
24	23	Write	Underl Time	Trip time for Underload protection	1 – 30	Sec	10
25	24	Write	Underl Op	Type of operation for Underload protection	0=Stop-M, 1=Stop-A, 2= Ind		0
26	25	Write	Phase Imb	Phase imbalance protection	0 = No, 1 = Yes		0
27	26	Write	Ph Imb Lev	Trip level for phase imbalance protection	10 – 80	%	80
28	27	Write	Ph Imb Op	Type of operation for phase imbalance protection	0=Stop-M, 1=Stop-A, 2= Ind		0
29	28	Write	High I	High current protection	0 = No, 1 = Yes		0
30	29	Write	High I Op	Type of operation for high current protection	0=Stop-M, 1=Stop-A, 2= Ind		0
31	30	Write	Phase Rev	Phase reversal protection	0 = No, 1 = Yes		0
32	31	Write	Ph Rev Op	Type of operation for phase reversal protection	0=Stop-M, 1=Stop-A, 2= Ind		0
33	32	Write	PTC	PTC protection	0 = No, 1 = Yes		0
34	33	Write	PTC Op	Type of operation for PTC protection	0=Stop-M, 1=Stop-A, 2= Ind		0
35	34	Write	Ext ByPass	External By-pass contactor is used	0=No, 1=Yes		0
36	-	Read	Dummy 36	Hidden (Not used)	0		0
37	35	Write	Warn I=High	High current warning	0=No, 1=Yes		0

Param. No	Word No	Type	Parameter	Description	Range	Unit	Default
38	36	Write	Wa I=H Lev	Trip level for high current warning	5 – 80 = 0,5 – 8,0	xIe	12
39	37	Write	Warn I=Low	Low current warning	0=No, 1=Yes		0
40	38	Write	Wa I=L Lev	Trip level for low current warning	4 – 10 = 0,4 – 1,0	xIe	8
41	39	Write	Warn OL	Overload warning	0=No, 1=Yes		0
42	40	Write	Wa OL Lev	Trip level for overload warning	40 – 99	%	90
43	41	Write	Warn SCR OL	Thyristor overload warning	0=No, 1=Yes		0
44	42	Write	Ph Loss Op	Type of operation for phase loss fault	0=Stop-M, 1=Stop-A		0
45	43	Write	FB Fault Op	Type of operation for fieldbus fault	0=Stop-M, 1=Stop-A		0
46	44	Write	Freq F Op.	Type of operation for frequency fault	0=Stop-M, 1=Stop-A		0
47	45	Write	HS Temp Op	Type of operation for heat sink over temperature fault	0=Stop-M, 1=Stop-A		0
48	46	Write	SCR SC Op	Type of operation for thyristor short circuit fault	0=Stop-M, 1=Stop-A		0
49	47	Read	In0	Function of programmable input In0	0=None, 1=Reset, 2=Enable, 3=Jog, 4=DOL-on, 5=Start2, 6=FB-Dis		1
50	48	Read	In1	Function of programmable input In1	0=None, 1=Reset, 2=Enable, 3=Jog, 4=DOL-on, 5=Start2, 6=FB-Dis		1
51	49	Write	Relay K4	Function of programmable relay output K4	0=Run, 1=TOR, 2=Event		0
52	50	Write	Relay K5	Function of programmable relay output K5	0=Run, 1=TOR, 2=Event		1
53	51	Write	Relay K6	Function of programmable relay output K6	0=Run, 1=TOR, 2=Event		2
54	52	Write	SW Outp V7	Function of programmable software output V7	0=Run, 1=TOR, 2=Event		2
55	53	Write	Event K4	Different events to include for signalling with K4 if “Event” is selected	0 – 65535, Bit mask see separate description.		0
56	54	Write	Event K5	Different events to include for signalling with K5 if “Event” is selected	0 – 65535, Bit mask see separate description.		0
57	55	Write	Event K6	Different events to include for signalling with K6 if “Event” is selected	0 – 65535, Bit mask see separate description.		7
58	56	Write	Event V7	Different events to include for signalling with V7 if “Event” is selected	0 – 65535, Bit mask see separate description.		7
59	57	Read	Fieldb Ctrl	Control of the softstarter with fieldbus	0=No, 1=Yes		0
60	58	Read	Fieldb Type	Type of fieldbus	0=AS-Int, 1=Other		1
61	59	Read	Fieldb Addr	Fieldbus address	0 – 1000		0
62	60	Write	No of Seq	Number of sequences for sequence start.	1=No, 2=2, 3=3		1
63	61	Write	Start Ramp1	1 st sequence, time for start ramp	1 – 120	Sec	10
64	62	Write	Init Volt1	1 st sequence, initial voltage for start ramp	30 – 70	%	30
65	63	Write	Curr Lim1	1 st sequence, current limit	15 – 70 = 1,5 – 7,0	xIe	4
66	64	Write	1st Set Ie	1 st sequence, motor rated current	0 – 3000 (*)	Amp	Individual
67	65	Write	Start Ramp2	2 nd sequence, time for start ramp	1 – 120	Sec	10
68	66	Write	Init Volt2	2 nd sequence, initial voltage for start ramp	30 – 70	%	30
69	67	Write	Curr Lim2	2 nd sequence, current limit	15 – 70 = 1,5 – 7,0	xIe	40
70	68	Write	2nd Set Ie	2 nd sequence, motor rated current	0 – 3000 (*)	Amp	Individual
71	69	Write	Start Ramp3	3 rd sequence, time for start ramp	1 – 120	Sec	10
72	70	Write	Init Volt3	3 rd sequence, initial voltage for start ramp	30 – 70	%	30
73	71	Write	Curr Lim3	3 rd sequence, current limit	15 – 70 = 1,5 – 7,0	xIe	40
74	72	Write	3rd Set Ie	3 rd sequence, motor rated current	0 – 3000 (*)	Amp	Individual
75	73	Read	Language	Language to use on display	1=US/UK, 2=FI, 3=SE, 4=PT, 5=NL, 6=IT, 7=FR, 8=ES, 9=DE, 10=CN,		Individual

Param. No	Word No	Type	Parameter	Description	Range	Unit	Default
					11=RU, 12=TR, 13=PL, 14=CZ		
76	-	Read	Dummy 76	Hidden (Not used)	0		0
77	-	Read	LCD Auto Off	Hidden (Time for display automatic turn off)	1 – 255	Minutes	15
78	-	Read	Password	Hidden (Password for display)	0=No, 1 – 255=1- 255		0
79	74	Read	Date Type	Type of date presentation	0=ISO , 1=CE , 2=US		0
80	75	Read	Date Year	Year	1901 – 2038		Individual
81	76	Read	Date Month	Month	1 – 12		Individual
82	77	Read	Date Day	Day	1 – 31		Individual
83	78	Read	Time Hour	Hour	0 – 23		Individual
84	79	Read	Time Min	Minutes	0 – 59		Individual
85	-	Read	S Port Ctrl	Hidden (Serial port control)	0=No, 1=Yes		0
86	-	Read	S Port Addr1	Hidden (Address of service port 1 st group)	0 – 255		192
87	-	Read	S Port Addr2	Hidden (Address of service port 2 nd group)	0 – 255		168
88	-	Read	S Port Addr3	Hidden (Address of service port 3 rd group)	0 – 255		0
89	-	Read	S Port Addr4	Hidden (Address of service port 4 th group)	0 – 255		2
90	-	Read	CT Ratio Ir	Hidden (Ratio of current transformers)	1 – 2500		Individual
							0 for all PST 1 for all PSTB
91	-	Read	Int ByPass	Hidden (Built in by-pass contactor)	0=No, 1=Yes		
92	-	Read	ByPass AC3	Hidden (AC3 value of built in by-pass contactor)	0 – 2500	Amp	Individual
93	-	Read	SOP1	Hidden (Thyristor Parameter 1)	70 – 120 = 0,7 – 1,2		Individual
94	-	Read	SOP2	Hidden (Thyristor Parameter 2)	5 – 2000 = 0,05 – 20,00		Individual
95	-	Read	SOP3	Hidden (Thyristor Parameter 3)	11 – 1200 = 0,011 – 1,200		Individual
96	-	Read	SOP4	Hidden (Thyristor Parameter 4)	10 – 150 = 1,0 – 15,0		Individual
97	80	Write	BP Closed Op	Type of operation for by-pass doesn't open	0=Stop-M, 1=Stop-A		0
98	81	Write	BP Open Op	Type of operation for by-pass doesn't close	0=Stop-M, 1=Stop-A		0
99	-	Read	Dummy 99	Hidden (Not used)	0		0
100	-	Read	FCODE1	Hidden (Factory code 1)	0-10		0
101	-	Read	FCODE2	Hidden (Factory code 2)	0-10		0
102	-	Read	FCODE3	Hidden (Factory code 3)	0-10		0
103	-	Read	FCODE4	Hidden (Factory code 4)	0-10		0
104	-	Read	FCODE5	Hidden (Factory code 5)	0-100		0
105	-	Read	FCODE6	Hidden (Factory code 6)	0-100		0
106	82	Read	PST(B)	PST(B) size	1-2500	Amp	Individual
107	-	Read	FCODE7	Hidden (Factory code 7)	0=No, 1=Yes		1
108	-	Read	FCODE8	Hidden (Factory code 8)	0=No, 1=Yes		1
109	-	Read	FCODE9	Hidden (Factory code 9)	0=No, 1=Yes		1
110	-	Read	FCODE10	Hidden (Factory code 10)	0-25		14
111	83	Write	C Lim Y Time	Time for dual current limit	0-120	Sec	0
112	84	Write	C Lim Y Lev	Level for dual current limit	15 -70 = 1,5-7,0	xIe	40
113	85	Write	FB Auto Dis	Fieldbus autodisable	0=No, 1=Yes		0
114	86	Write	Start Mode	Start mode	0=Volt, 1=Torque		0
115	87	Write	Stop Mode	Stop mode	0=Volt, 1=Torque		0
116	88	Write	Torque Limit	Torque limit	20-200	%	150
117	89	Write	Tune T-Ctrl	Tune Torque control	30-300	%	100
118	-	Read	FCODE11	Hidden (Factory code 11)	1-1000 = 0,01-10,00		40
119	-	Read	FCODE12	Hidden (Factory code 12)	1-10000 = 0,001-10,000		40

Param. No	Word No	Type	Parameter	Description	Range	Unit	Default
120	-	Read	FCODE13	Hidden (Factory code 13)	1-1000 = 0,001-1,000		10
121	-	Read	FCODE14	Hidden (Factory code 14)	1-1000 = 0,001-1,000		20
122	-	Read	FCODE15	Hidden (Factory code 15)	1 – 10000 = 0,001-10,000		20
123	90	Write	Analogue Out	Enable Analogue output	0=No, 1=Yes		0
124	91	Write	Anl Ref	Analogue output, reference	0=0-20mA, 1=4-20mA, 2=0-10V		1
125	92	Write	Anl Type	Analogue output, type of value	0=I Amp, 1=U Volt, 2=P kW, 3=P hp, Q 4=kVAr, 5=S kVA, 6=TmpMot, 7=TmpSCR, 8=cosPhi		0
126	93	Write	I Range Max	Analogue output, current range max	1-20000	A	Individual
127	94	Write	U Range Max	Analogue output, voltage range max	10-1000	V	600
128	95	Write	kW Range Max	Analogue output, active power range max kW	1-3000	kW	Individual
129	96	Write	hp Range Max	Analogue output, active power range max hp	1-3000	hp	Individual
130	97	Write	Q Range Max	Analogue output, reactive power range max	1-3000	kVAr	Individual
131	98	Write	S Range Max	Analogue output, apparent power range max	1-3000	kVA	Individual
132	99	Read	Imitate SW	Imitate Software version	0=010000, 1=010100, 2=020001, 3=030302, 4=030401, 5=030500, 6=040002, 7=050202, 8=050404, 9=050500		9
133	100	Write	Connection	Connetion	Auto, Line, DeltaUI, DeltaU		Auto

*) For the purpose of having one common data for the whole range of softstarters “Setting Ie”, “1st Set Ie”, “2nd Set Ie” and “3rd Set Ie” have the range 0 – 3000 Amp. The softstarter in itself will have a much more narrow range defined by its rated current and only values within the softstarters range will be accepted, other values will be skipped. The valid range per type is shown in the softstarter catalogue or on the softstarter front label (marking plate).

16 Bit Mask for Events on Relay outputs	
Bit 0	Overload
Bit 1	Fault
Bit 2	High I
Bit 3	SCR OL
Bit 4	Locked Rotor
Bit 5	Underload
Bit 6	Phase Imb
Bit 7	PTC
Bit 8	Phase Rev
Bit 9	Warn OL
Bit 10	Warn SCR OL
Bit 11	Warn I=High
Bit 12	Warn I=Low
Bit 13	Shunt Fault
Bit 14	Spare
Bit 15	Spare

Example for a set-up.

Softstarter PST Modbus RTU communication.

This document describes an application example between a Modbus RTU master (PLC CPU, PC, etc.) and the ABB softstarter PST equipped with a Modbus field bus plug. In this example the softstarter address is 47 and it is valid for FielBusPlug MRP21 revision “e” and newer.

Please always use the actual softstarter and FBP manuals.

In this particular example following documents has been used:

Modbus RTU FBP FielBusPlug MRP21. FBP technical description 2CDC194001D0202.

Softstarters PST installation and commissioning manual 1 SFC132003M0201, June 2007

Softstarter firmware version: **SW Ver CU 05.05.00**

For other versions of software RED marked figures in this example might change

Settings

1. Set the softstarter address and field bus communication.

Change the default address 248 of the softstarter with the keypad to 47 (Fieldb Addr) and enable the fieldbus communication (Fieldb Ctrl=Yes).

2. Set the communication parameters.

The communication parameters are: 1 Start bit, 8 Data bits, the Parity will be adapted to the master. The baud rate is mapped to the slave address, e.g.the baud rate to the slave 47 is 19200. Therefore the master and the slave will have the communication parameters:

1 start bit, 1 stop bit, 8 data bit, even parity, 19200 baud

A configuration telegram is not necessary, so please do not send it.

Now the master can send different Modbus telegrams in order to exchange data with the Softstarter. After receiving the first valid request from the Modbus master the LED H2 on the FieldBusPlug MRP21 will stop blinking confirming that the exchange has started.

Read binary input telegram

Read binary input values

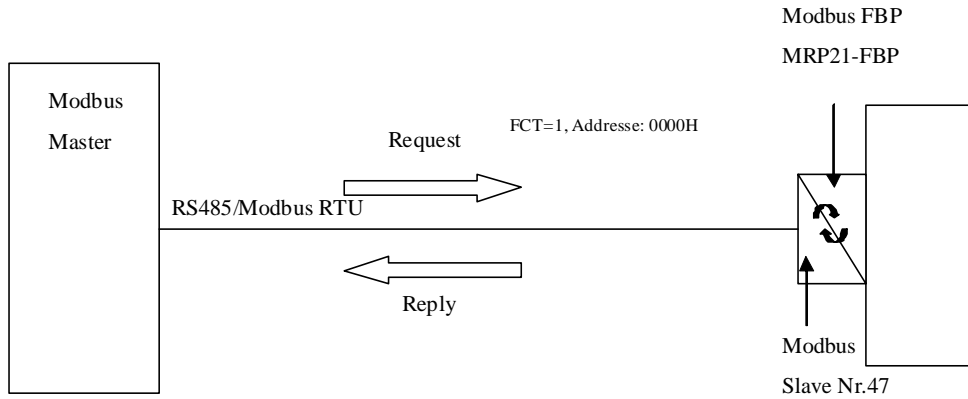

read 48 bit starting at the address 0000

```

request
2F 01 00 00 00 30 3A 50
  |  |  |  |  |  |  |
  |  |  |  |  |  |  |
Slave 47  FCT=01  Address 48 bit  CRC
  |
reply
2F 01 06 00 00 00 00 00 75 0D
  |  |  |  |  |  |  |  |  |
Slave 47  FCT=15  6 Byte  Byte 0  Byte 1  Byte 2  Byte 3  Byte 4  Byte 5  CRC
  
```

Write binary output telegram

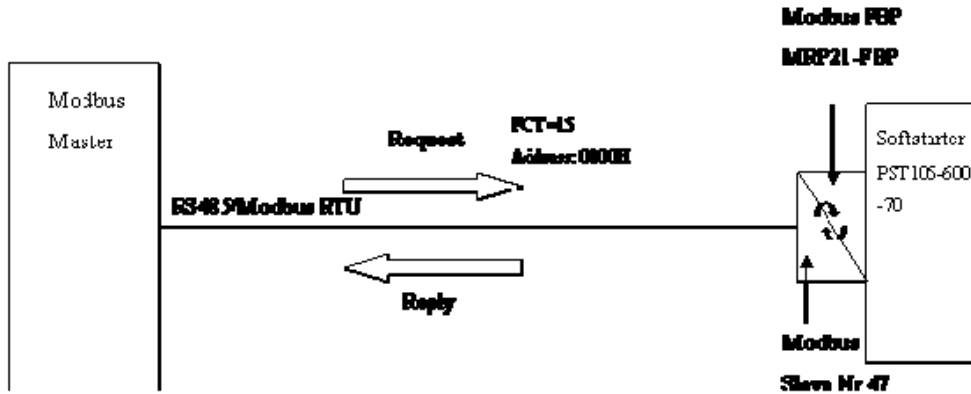

e.g.: write 16 bit starting at the address 0100

```

request
2F 0F 01 00 00 :0 02 00 0C 27 41
  |  |  |  |  |  |  |  |  |
Slave 47  FCT=15  Address 16 bit  2 Bytes  Output  CRC
  |
reply
2F 0F 01 00 00 :0 53 B5
  |  |  |  |  |  |  |
Slave 47  FCT=15  Address 16 bit  CRC
  
```

Read analogue input telegram

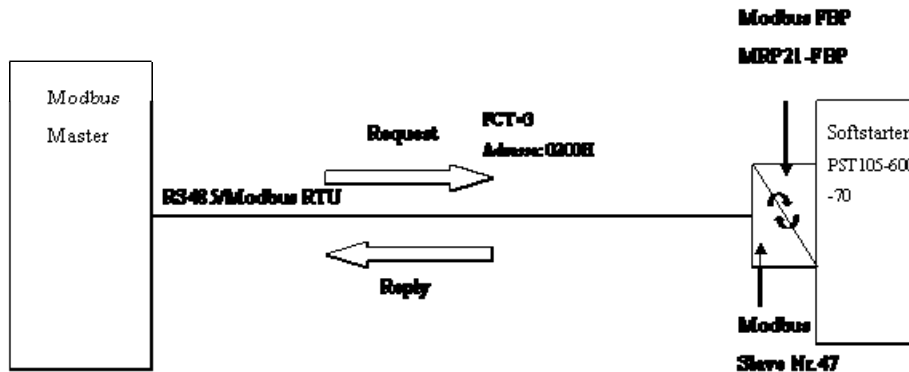

e.g.: read 9 words starting at the address 0200H

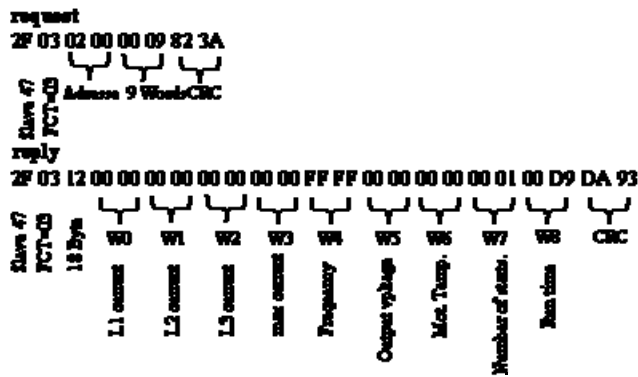

Read diagnostic inputs

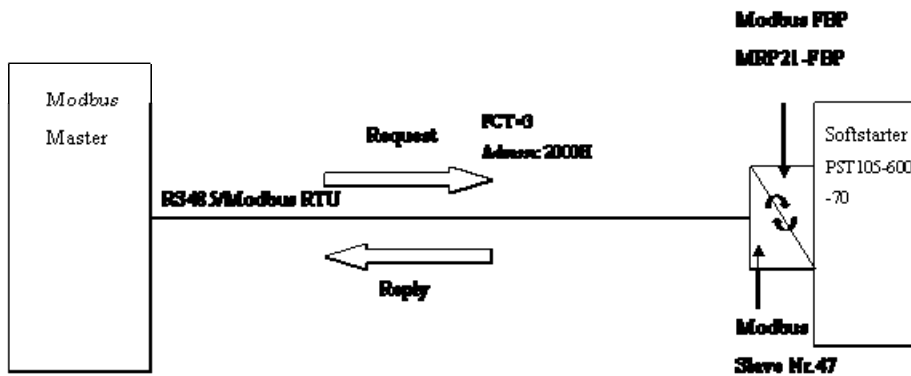

e.g.: read 3 diagnostic words starting at the address 2000H

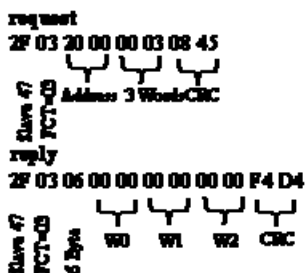

W0 : diagnose channel I error code / Parameter-number

W1 : diagnose channel I error code / Parameter-number

W2 : diagnose channel I error code / Parameter-number



ABB AB, Cewe-Control
S-721 61 Västerås, SWEDEN
Telephone +46 21 32 07 00
TELEFAX +46 21 12 60 01