

Short form user's manual ACS310 drives



Table of contents



Safety



Mechanical installation



Electrical installation



Start-up and control with I/O



List of related manuals

Drive hardware manuals and guides

ACS310 short form user's manual

ACS310 user's manual

Code (English)

[3AUA0000044200](#)

[3AUA0000044201](#)

Option manuals and guides

MFDT-01 FlashDrop user's manual

[3AFE68591074](#)

MREL-01 relay output extension module user's manual for ACS310/ACS350

[3AUA0000035974](#)

MUL1-R1 installation instructions for ACS150, ACS310, ACS350 and ACS355

[3AFE68642868](#)

MUL1-R3 installation instructions for ACS310, ACS350 and ACS355

[3AFE68643147](#)

MUL1-R4 installation instructions for ACS310 and ACS350

[3AUA0000025916](#)

SREA-01 Ethernet adapter module quick start-up guide

[3AUA0000042902](#)

SREA-01 Ethernet adapter module user's manual

[3AUA0000042896](#)

Option manuals and guides

Guide for capacitor reforming in ACS50, ACS55, ACS150, ACS310, ACS350, ACS355, ACS550 and ACH550

[3AFE68735190](#)

You can find manuals and other product documents in PDF format on the Internet. See section [Document library on the Internet](#) on the inside of the back cover. For manuals not available in the Document library, contact your local ABB representative.

Purpose of the manual

This short form user's manual provides the basic information needed for installing and commissioning the drive.

For information on planning the electrical installation, operation with the control panel, program features, fieldbus, all accessible actual signals and parameters, fault tracing, maintenance, additional technical data and dimension drawings, refer to *ACS310 user's manual* (3AUA0000044201 [English]). To access it on the Internet, go to www.abb.com/drives, select *Document Library*, enter the code in the search field and click OK.

Applicability

The manual is applicable to the ACS310 drive firmware version 4.00E or later. See parameter 3301 FIRMWARE in chapter *Actual signals and parameters* in *ACS310 user's manual* (3AUA0000044201 [English]).

Table of contents

List of related manuals	2
Purpose of the manual	2
Applicability	2
1. Safety	
Safety in installation and maintenance	5
Safe start-up and operation	6
2. Hardware description	
Power connections and control interfaces	7
Type designation key	8
3. Mechanical installation	
Installing	9
4. Electrical installation	
Checking the compatibility with IT (ungrounded) and corner-grounded TN systems	13
Connecting the power cables	14
Connecting the control cables	16
Installation checklist	18
5. Start-up and control with I/O	
How to start up the drive	19
How to control the drive through the I/O interface	26
6. Actual signals and parameters in the short view	
Terms and abbreviations	27
Fieldbus equivalent	27
Default values with different macros	28
Actual signals in the short parameter view	29
Parameters in the short parameter view	29
7. Technical data	
Ratings	35
Power cable sizes and fuses	37
UL checklist	38
Declaration of incorporation	39
Product and service inquiries	41
Product training	41
Providing feedback on ABB Drives manuals	41
Document library on the Internet	41



4 *Table of contents*



1. Safety

Safety in installation and maintenance

These warnings are intended for all who work on the drive, motor cable or motor.

■ Electrical safety



WARNING! Ignoring the following instructions can cause physical injury or death, or damage to the equipment.

Only qualified electricians are allowed to install and maintain the drive!

- Never work on the drive, motor cable or motor when input power is applied. After disconnecting the input power, always wait for 5 minutes to let the intermediate circuit capacitors discharge before you start working on the drive, motor or motor cable.

Always ensure by measuring with a multimeter (impedance at least 1 Mohm) that there is no voltage between the drive input phases U1, V1 and W1 and the ground.

- Do not work on the control cables when power is applied to the drive or to the external control circuits. Externally supplied control circuits may carry dangerous voltage even when the input power of the drive is switched off.
- Do not make any insulation or voltage withstand tests on the drive.
- Disconnect the internal EMC filter when installing the drive on an IT system (an ungrounded power system or a high-resistance-grounded [over 30 ohms] power system), otherwise the system will be connected to ground potential through the EMC filter capacitors. This may cause danger or damage the drive. See page [13](#). **Note:** When the internal EMC filter is disconnected, the drive is not EMC compatible.
- Disconnect the internal EMC filter when installing the drive on a corner-grounded TN system, otherwise the drive will be damaged. See page [13](#). **Note:** When the internal EMC filter is disconnected, the drive is not EMC compatible.
- All ELV (extra low voltage) circuits connected to the drive must be used within a zone of equipotential bonding, ie within a zone where all simultaneously accessible conductive parts are electrically connected to prevent hazardous voltages appearing between them. This is accomplished by a proper factory grounding.

Note:

- Even when the motor is stopped, dangerous voltage is present at the power circuit terminals U1, V1, W1 and U2, V2, W2.
-
-



■ General safety



WARNING! Ignoring the following instructions can cause physical injury or death, or damage to the equipment.

- The drive is not field repairable. Never attempt to repair a malfunctioning drive; contact your local ABB representative or Authorized Service Center for replacement.
 - Make sure that dust from drilling does not enter the drive during the installation. Electrically conductive dust inside the drive may cause damage or lead to malfunction.
 - Ensure sufficient cooling.
-



Safe start-up and operation

These warnings are intended for all who plan the operation, start up or operate the drive.



■ General safety



WARNING! Ignoring the following instructions can cause physical injury or death, or damage to the equipment.

- Before adjusting the drive and putting it into service, make sure that the motor and all driven equipment are suitable for operation throughout the speed range provided by the drive. The drive can be adjusted to operate the motor at speeds above and below the speed provided by connecting the motor directly to the power line.
- Do not activate automatic fault reset functions if dangerous situations can occur. When activated, these functions will reset the drive and resume operation after a fault.
- Do not control the motor with an AC contactor or disconnecting device (disconnecting means); use instead the control panel start and stop keys  and  or external commands (I/O or fieldbus). The maximum allowed number of charging cycles of the DC capacitors (ie power-ups by applying power) is two per minute and the maximum total number of chargings is 15 000.

Note:

- If an external source for start command is selected and it is ON, the drive will start immediately after an input voltage break or fault reset unless the drive is configured for 3-wire (a pulse) start/stop.
 - When the control location is not set to local (LOC not shown on the display), the stop key on the control panel will not stop the drive. To stop the drive using the control panel, press the LOC/REM key  and then the stop key .
-

2. Hardware description

Power connections and control interfaces

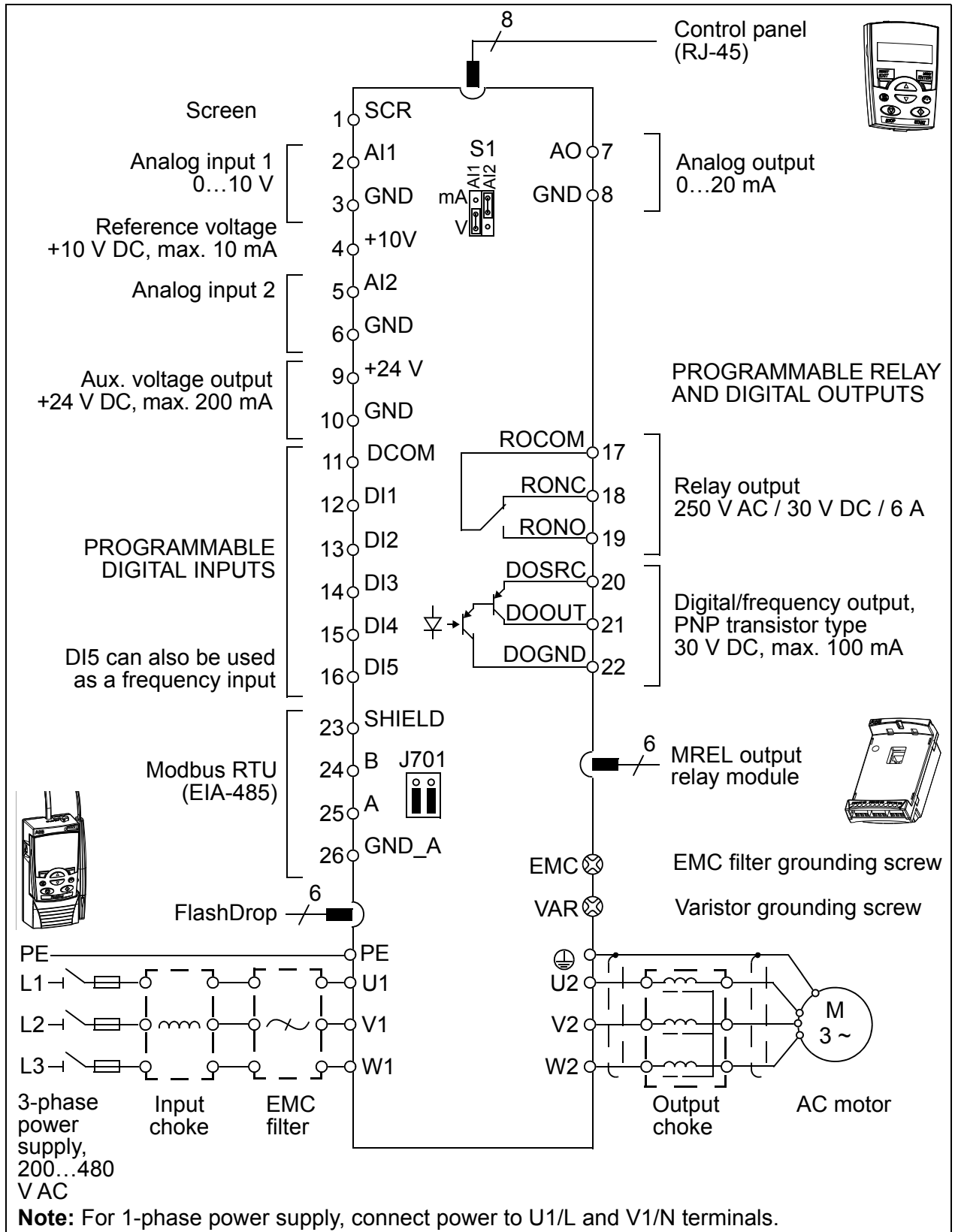

Type designation key

The type designation contains information on the specifications and configuration of the drive. You find the type designation on the type designation label attached to the drive. The first digits from the left express the basic configuration, for example ACS310-03E-09A7-4. The optional selections are given after that, separated by + signs, for example +J404. The explanations of the type designation selections are described below.

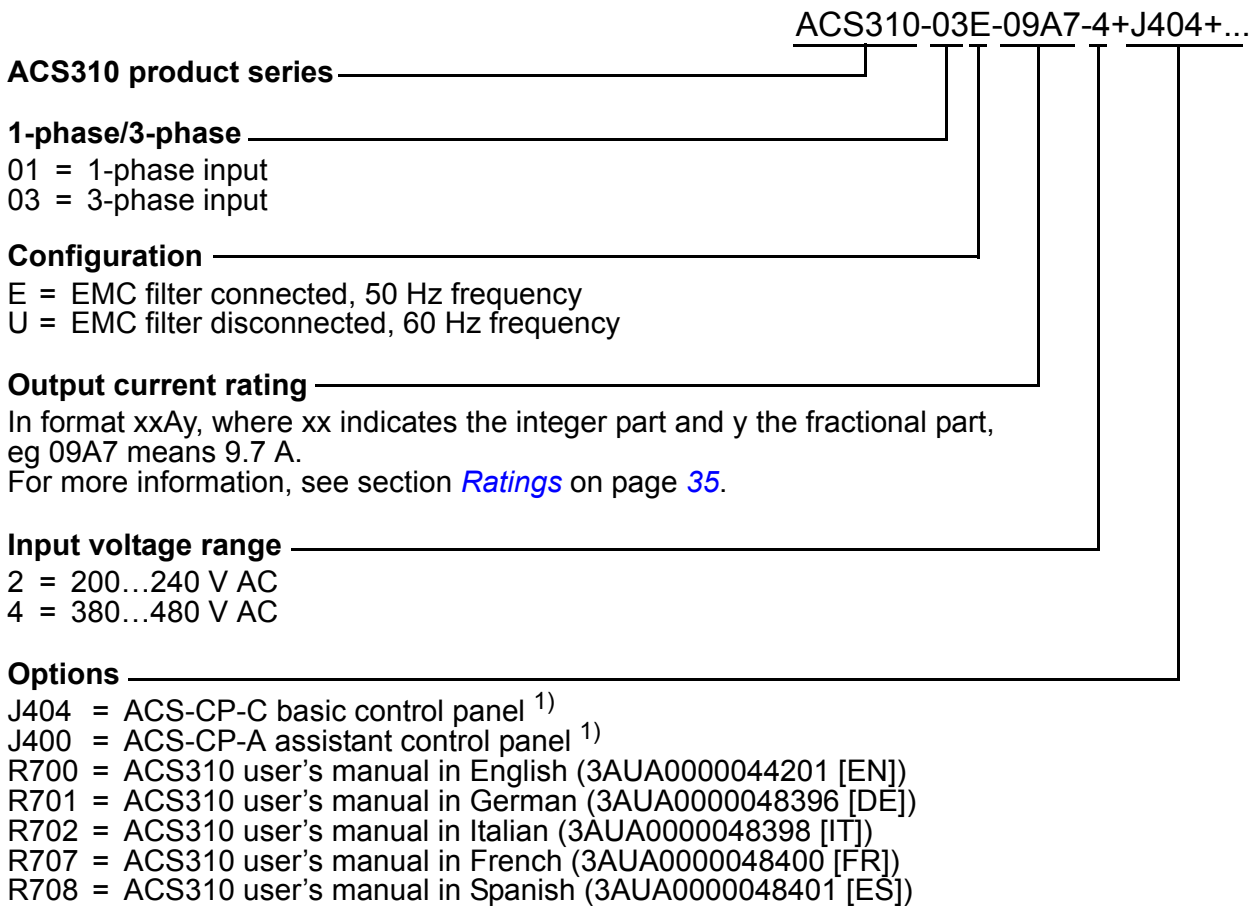

¹⁾ The ACS310 is compatible with panels that have the following panel revisions and panel firmware versions. To find out the revision and firmware version of your panel, see chapter *Control panels*, section *Applicability* in *ACS310 user's manual* (3AUA0000044201 [English]).

Panel type	Type code	Panel revision	Panel firmware version
Basic control panel	ACS-CP-C	M or later	1.13 or later
Assistant control panel	ACS-CP-A	E or later	2.04 or later
Assistant control panel (Asia)	ACS-CP-D	P or later	2.04 or later

Note that unlike the other panels, the ACS-CP-D is ordered with a separate material code.

3. Mechanical installation

Installing

The instructions in this manual cover drives with the IP20 degree of protection. To comply with NEMA 1, use the MUL1-R1, MUL1-R3 or MUL1-R4 option kit, which is delivered with multilingual installation instructions (3AFE68642868, 3AFE68643147 or 3AUA0000025916, respectively).

■ Install the drive

Install the drive with screws or on a DIN rail as appropriate.

The required free space for cooling above and below the drive is 75 mm (3 in). No free space is required on the sides, so drives can be mounted immediately next to each other.

Note: Make sure that dust from drilling does not enter the drive during the installation.

With screws

1. Mark the hole locations using for example the mounting template cut out from the package. The locations of the holes are also shown in the drawings in chapter *Dimension drawings* in *ACS310 user's manual* (3AUA0000044201 [English]). The number and location of the holes used depend on how the drive is installed:
 - a) back mounting (frame sizes R0...R4): four holes
 - b) side mounting (frame sizes R0...R2): three holes; one of the bottom holes is located in the clamping plate.
2. Fix the screws or bolts to the marked locations.

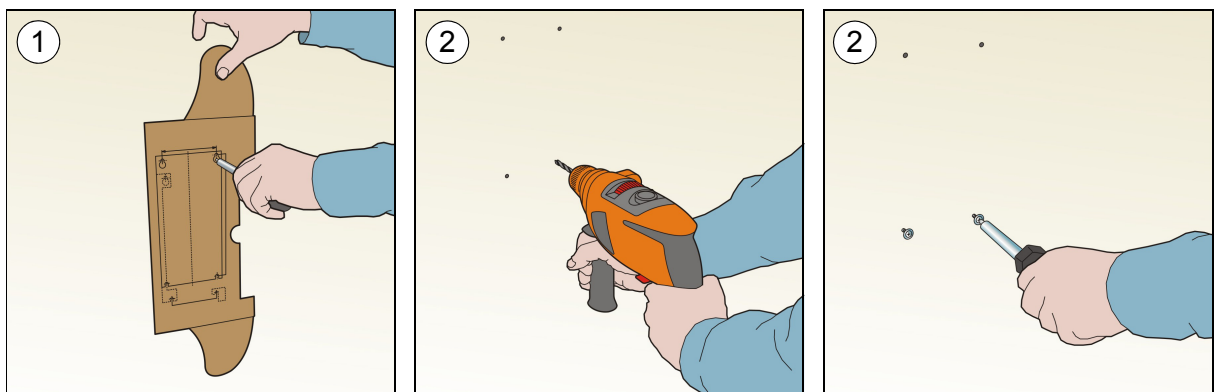

10 Mechanical installation

3. Position the drive onto the screws on the wall.
4. Tighten the screws in the wall securely.

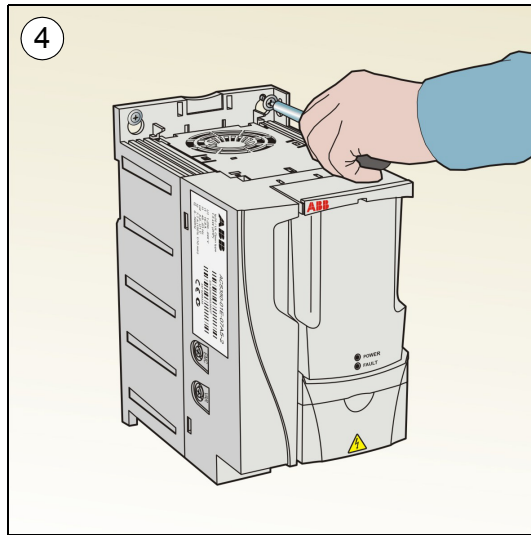
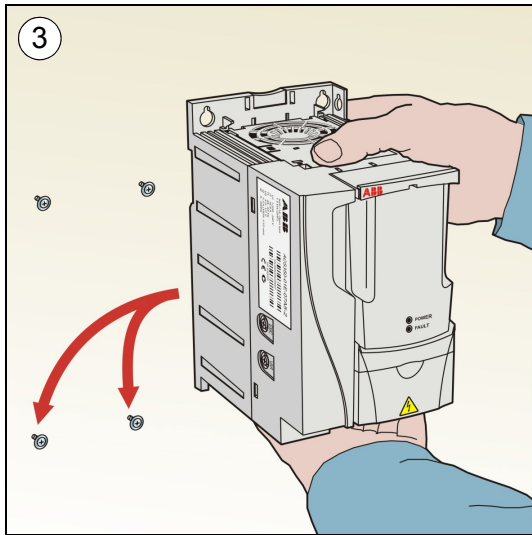

On DIN rail

1. Click the drive to the rail.
To detach the drive, press the release lever on top of the drive (1b).

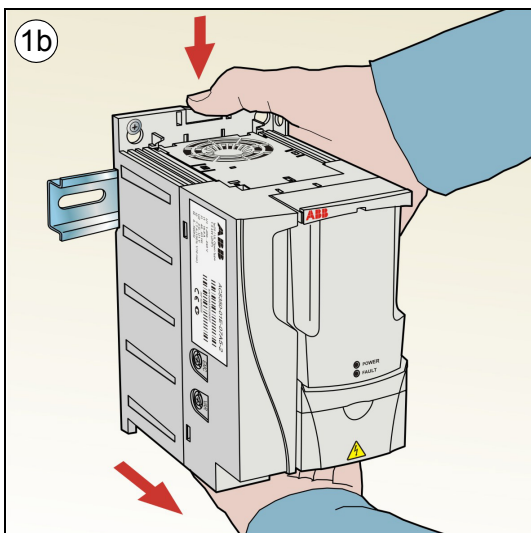
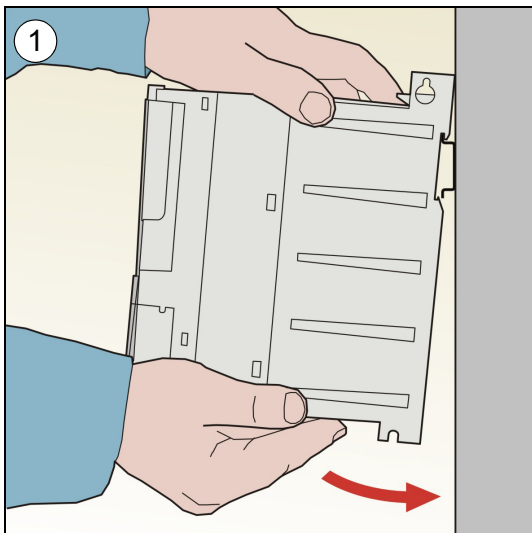

■ Fasten clamping plates

1. Fasten the clamping plate to the plate at the bottom of the drive with the provided screws.
2. For frame sizes R0...R2, fasten the I/O clamping plate to the clamping plate with the provided screws.

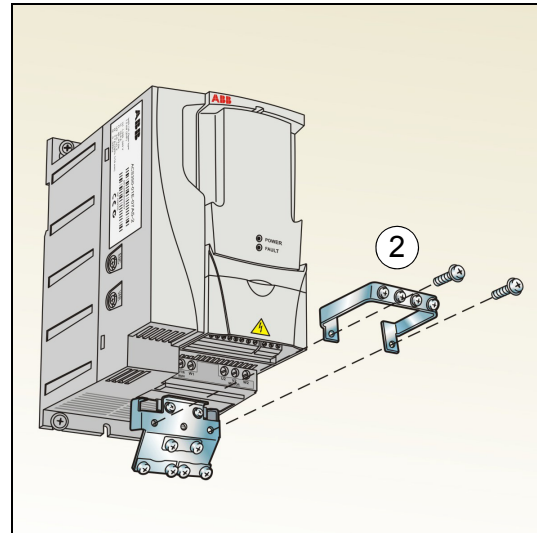
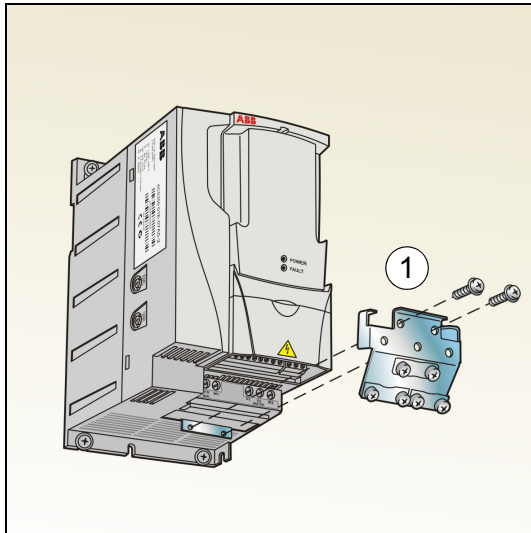

12 Mechanical installation



4. Electrical installation



WARNING! The work described in this chapter may only be carried out by a qualified electrician. Follow the instructions in chapter [Safety](#) on page 5. Ignoring the safety instructions can cause injury or death.

Make sure that the drive is disconnected from the input power during installation. If the drive is already connected to the input power, wait for 5 minutes after disconnecting the input power.

Checking the compatibility with IT (ungrounded) and corner-grounded TN systems



WARNING! Disconnect the internal EMC filter when installing the drive on an IT system (an ungrounded power system or a high-resistance-grounded [over 30 ohms] power system), otherwise the system will be connected to ground potential through the EMC filter capacitors. This may cause danger or damage the drive.

Disconnect the internal EMC filter when installing the drive on a corner-grounded TN system, otherwise the drive will be damaged.

1. If you have an IT (ungrounded) or corner-grounded TN system, disconnect the internal EMC filter by removing the EMC screw. For 3-phase U-type drives (with type designation ACS310-03U-), the EMC screw is already removed at the factory and replaced by a plastic one.

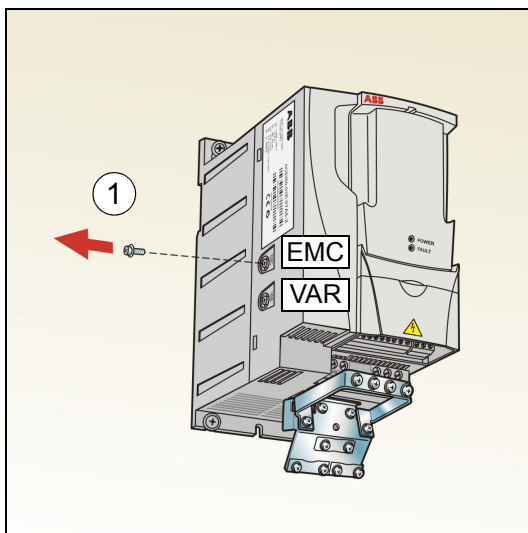

Note: In frame size R4 the EMC screw is located to the right of terminal W2.



Connecting the power cables

■ Connection diagram

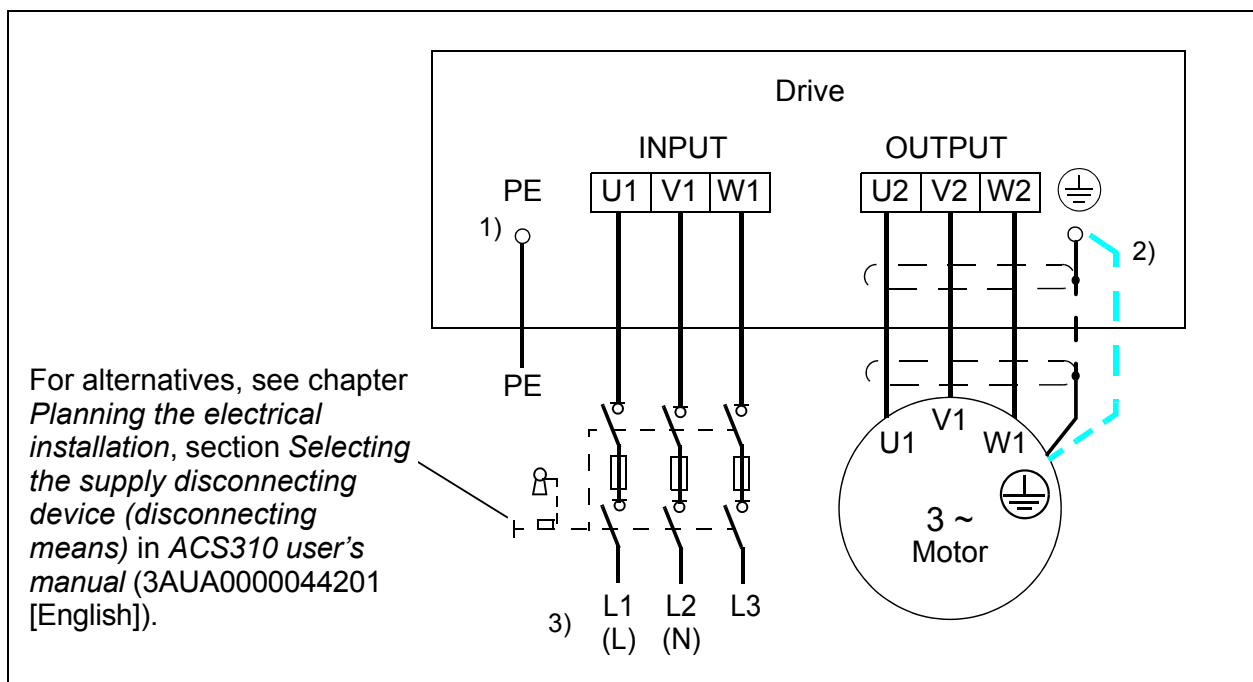

- 1) Ground the other end of the PE conductor at the distribution board.
- 2) Use a separate grounding cable if the conductivity of the cable shield is insufficient (smaller than the conductivity of the phase conductor) and there is no symmetrically constructed grounding conductor in the cable. See chapter *Planning the electrical installation*, section *Selecting the power cables* in ACS310 user's manual (3AUA0000044201 [English]).
- 3) L and N are connection markings for 1-phase supply.

Note:

Do not use an asymmetrically constructed motor cable.

If there is a symmetrically constructed grounding conductor in the motor cable in addition to the conductive shield, connect the grounding conductor to the grounding terminal at the drive and motor ends.

For the 1-phase supply, connect power to U1 (L) and V1 (N) terminals.

Route the motor cable, input power cable and control cables separately. For more information, see chapter *Planning the electrical installation*, section *Routing the cables* in ACS310 user's manual (3AUA0000044201 [English]).

Grounding of the motor cable shield at the motor end

For minimum radio frequency interference:

- ground the cable by twisting the shield as follows:
flattened width $\geq 1/5 \cdot$ length
- or ground the cable shield 360 degrees at the lead-through of the motor terminal box.

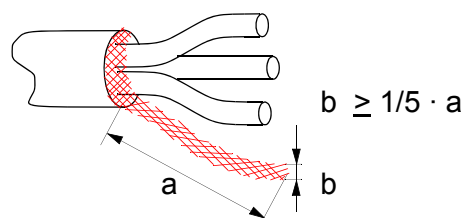

■ Connection procedure

1. Fasten the grounding conductor (PE) of the input power cable under the grounding clamp. Connect the phase conductors to the U1, V1 and W1 terminals. Use a tightening torque of 0.8 N·m (7 lbf·in) for frame sizes R0...R2, 1.7 N·m (15 lbf·in) for R3, and 2.5 N·m (22 lbf·in) for R4.
2. Strip the motor cable and twist the shield to form as short a pigtail as possible. Fasten the twisted shield under the grounding clamp. Connect the phase conductors to the U2, V2 and W2 terminals. Use a tightening torque of 0.8 N·m (7 lbf·in) for frame sizes R0...R2, 1.7 N·m (15 lbf·in) for R3, and 2.5 N·m (22 lbf·in) for R4.
3. Secure the cables outside the drive mechanically.

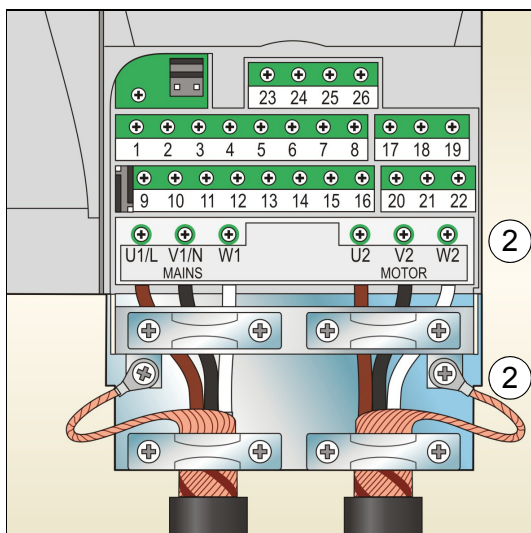
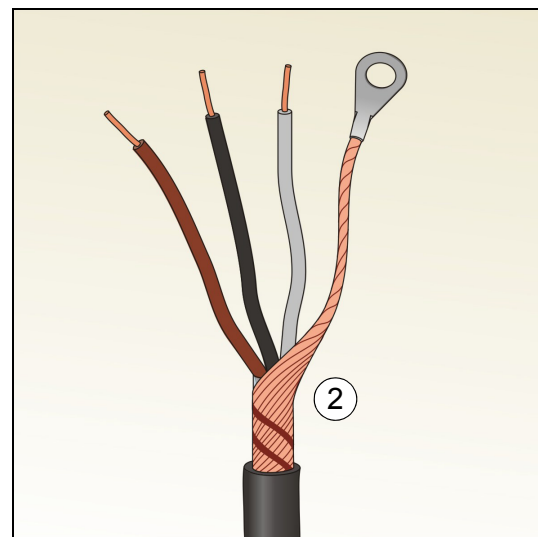
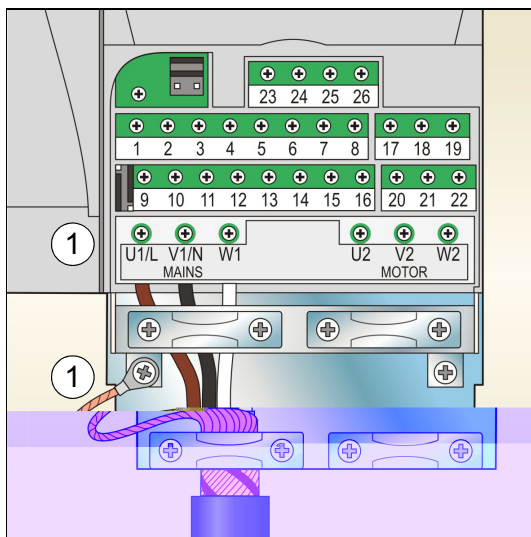

Connecting the control cables

■ Default I/O connection diagram

The default connection of the control signals depends on the application macro in use, which is selected with parameter [9902 APPLIC MACRO](#) (see page [32](#)).

The default macro is the ABB standard macro. It provides a general purpose I/O configuration with three constant speeds. Parameter values are the default values given in chapter *Actual signals and parameters* in *ACS310 user's manual* (3AUA0000044201 [English]). For other macros, see I/O connections in chapter *Application macros* in the same manual, and default values on page [28](#) in this manual.

The default I/O connections for the ABB standard macro are given in the figure below.

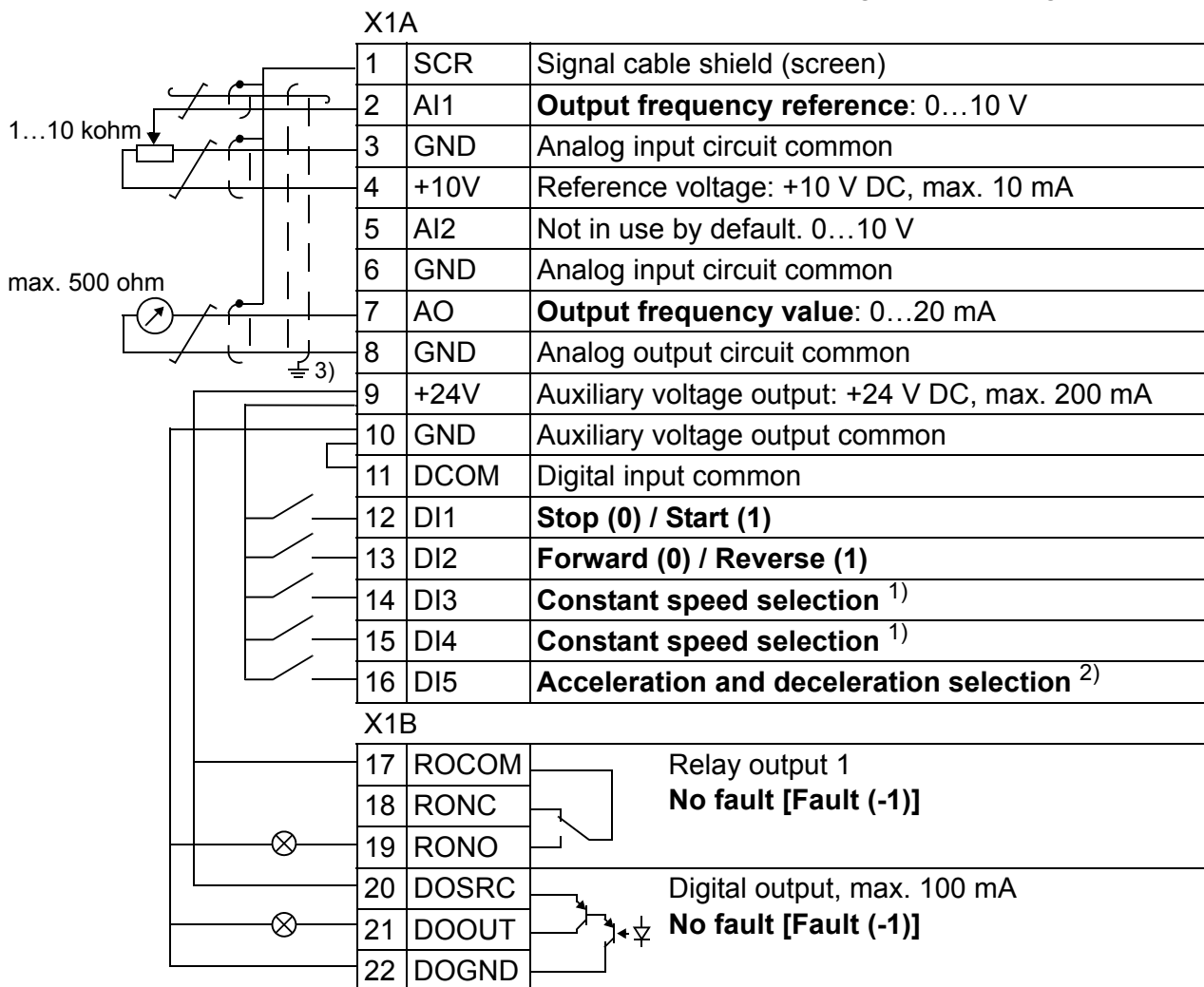

¹⁾ See parameter group [12 CONSTANT SPEEDS](#):

DI3	DI4	Operation (parameter)
0	0	Set speed through AI1
1	0	Speed 1 (1202)
0	1	Speed 2 (1203)
1	1	Speed 3 (1204)

²⁾ 0 = ramp times according to parameters [2202](#) and [2203](#).

1 = ramp times according to parameters [2205](#) and [2206](#).

³⁾ 360 degree grounding under a clamp.

Tightening torque = 0.4 N·m (3.5 lbf·in).

■ Connection procedure

1. Remove the terminal cover by simultaneously pushing the recess and sliding the cover off the frame.
2. *Digital signals:* Strip the outer insulation of the digital signal cable 360 degrees and ground the bare shield under the clamp.
3. Connect the conductors of the cable to the appropriate terminals. Use a tightening torque of 0.4 N·m (3.5 lbf·in).
4. For double-shielded cables, twist also the grounding conductors of each pair in the cable together and connect the bundle to the SCR terminal (terminal 1).

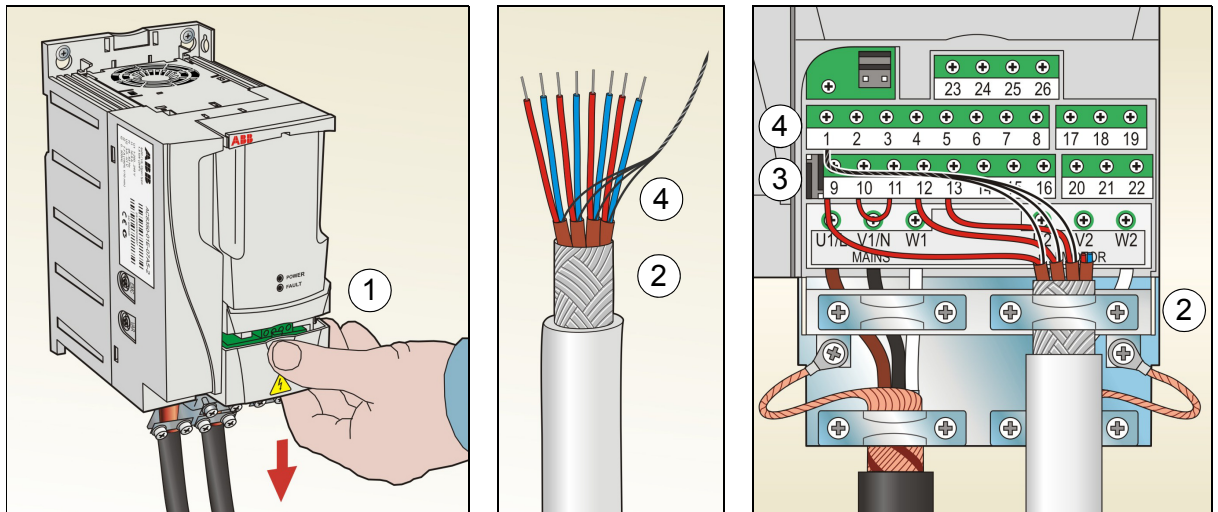

5. *Analog signals:* Strip the outer insulation of the analog signal cable 360 degrees and ground the bare shield under the clamp.
6. Connect the conductors to the appropriate terminals. Use a tightening torque of 0.4 N·m (3.5 lbf·in).
7. Twist the grounding conductors of each pair in the analog signal cable together and connect the bundle to the SCR terminal (terminal 1).
8. Secure all cables outside the drive mechanically.
9. Slide the terminal cover back in place.

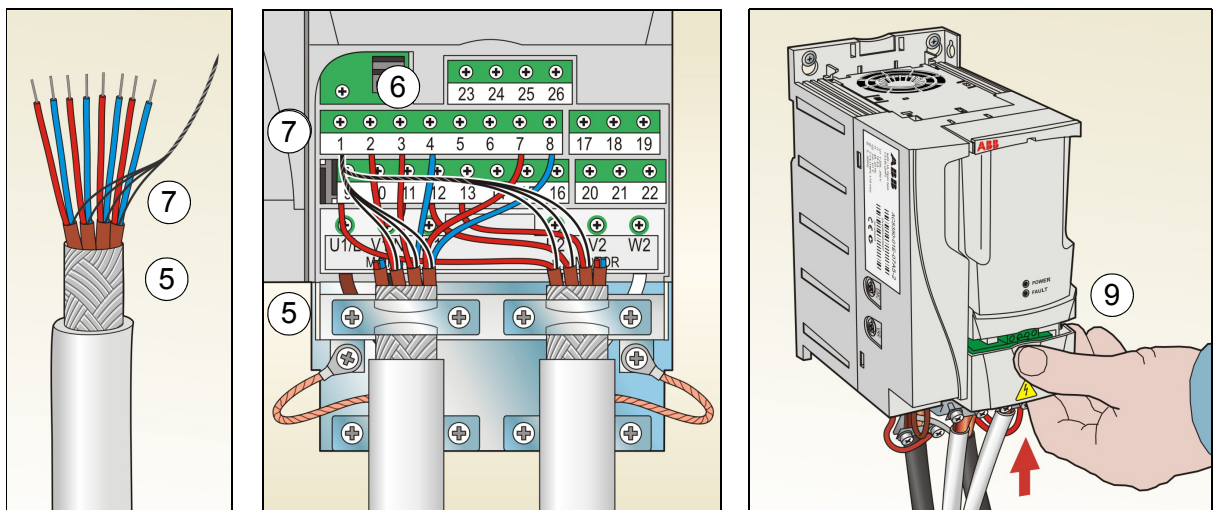

Installation checklist

Check the mechanical and electrical installation of the drive before start-up. Go through the checklist below together with another person. Read chapter [Safety](#) on page [5](#) before you work on the drive.

Check
MECHANICAL INSTALLATION
<ul style="list-style-type: none"> <input type="checkbox"/> The ambient operating conditions are within allowed limits. (See <i>Technical data: Losses, cooling data and noise</i> and <i>Ambient conditions</i> in <i>ACS310 user's manual</i> (3AUA0000044201 [English]).) <input type="checkbox"/> The drive is fixed properly on an even vertical non-flammable wall. (See Mechanical installation on page 9 and <i>Mechanical installation</i> in <i>ACS310 user's manual</i> (3AUA0000044201 [English]).) <input type="checkbox"/> The cooling air flows freely. (See Mechanical installation: Install the drive on page 9.) <input type="checkbox"/> The motor and the driven equipment are ready for start. (See <i>Planning the electrical installation: Checking the compatibility of the motor and drive</i> as well as <i>Technical data: Motor connection data</i> in <i>ACS310 user's manual</i> (3AUA0000044201 [English]).)
ELECTRICAL INSTALLATION (See Electrical installation on page 13 and <i>Planning the electrical installation</i> in <i>ACS310 user's manual</i> (3AUA0000044201 [English]).)
<ul style="list-style-type: none"> <input type="checkbox"/> For ungrounded and corner-grounded systems: The internal EMC filter is disconnected (EMC screw removed). <input type="checkbox"/> The capacitors are reformed if the drive has been stored over a year. <input type="checkbox"/> The drive is grounded properly. <input type="checkbox"/> The input power voltage matches the drive nominal input voltage. <input type="checkbox"/> The input power connections at U1, V1 and W1 are OK and tightened with the correct torque. <input type="checkbox"/> Appropriate input power fuses and disconnectors are installed. <input type="checkbox"/> The motor connections at U2, V2 and W2 are OK and tightened with the correct torque. <input type="checkbox"/> The motor cable, input power cable and control cables are routed separately. <input type="checkbox"/> The external control (I/O) connections are OK. <input type="checkbox"/> The input power voltage cannot be applied to the output of the drive (with a bypass connection). <input type="checkbox"/> Terminal cover and, for NEMA 1, hood and connection box, are in place.



5. Start-up and control with I/O

How to start up the drive



WARNING! The start-up may only be carried out by a qualified electrician.

The safety instructions given in chapter [Safety](#) on page 5 must be followed during the start-up procedure.

The drive will start up automatically at power up if the external run command is on and the drive is in the remote control mode.

Check that the starting of the motor does not cause any danger. **De-couple the driven machine** if there is a risk of damage in case of incorrect direction of rotation.

Note: By default, parameter [1611 PARAMETER VIEW](#) is set to 2 ([SHORT VIEW](#)), and you cannot see all actual signals and parameters. To be able to view them, set parameter [1611 PARAMETER VIEW](#) to 3 ([LONG VIEW](#)).

- Check the installation. See the checklist in section [Installation checklist](#) on page 18.

How you start up the drive depends on the control panel you have.

- **If you have a Basic control panel**, follow the instructions given in section [How to perform a manual start-up](#) on page 20.
- **If you have an Assistant control panel**, you can either run the Start-up assistant (see section [How to perform a guided start-up](#) on page 23) or perform a manual start-up (see section [How to perform a manual start-up](#) on page 20).

The Start-up assistant, which is included in the Assistant control panel only, guides you through all essential settings to be done. In the manual start-up, the drive gives no guidance; you go through the very basic settings by following the instructions given in section [How to perform a manual start-up](#) on page 20.



How to perform a manual start-up

For the manual start-up, you can use the Basic control panel or the Assistant control panel. The instructions below are valid for both control panels, but the displays shown are the Basic control panel displays, unless the instruction applies to the Assistant control panel only.

Before you start, ensure that you have the motor nameplate data on hand.

POWER-UP

Apply input power.

The Basic control panel powers up into the Output mode.

The Assistant control panel asks if you want to run the Start-up assistant. If you press , the Start-up assistant is not run, and you can continue with manual start-up in a similar manner as described below for the Basic control panel.

REM 0.0 Hz

OUTPUT FWD

REM CHOICE

Do you want to use the start-up assistant?

Yes

No

EXIT | 00:00 | OK

MANUAL ENTRY OF START-UP DATA (parameter group 99)

If you have an Assistant control panel, select the language (the Basic control panel does not support languages). See parameter [9901](#) for the values of the available language alternatives.

For instructions on how to set parameters with the Assistant control panel, see chapter *Control panels*, section *Assistant control panel* in *ACS310 user's manual* (3AUA0000044201 [English]).

Enter the motor data from the motor nameplate:

REM PAR EDIT

9901 LANGUAGE

ENGLISH

[0]

CANCEL | 00:00 | SAVE

Note: Set the motor data to exactly the same value as on the motor nameplate. For example, if the nominal motor speed is 1470 rpm on the nameplate, setting the value of parameter [9908 MOTOR NOM SPEED](#) to 1500 rpm results in the wrong operation of the drive.

















ABB Motors 							
3 ~ motor		M2AA 200 MLA 4					
IEC 200 M/L 55				↔			
No							
Ins.cl. F				IP 55			
V	Hz	kW	r/min	A	cos φ	IA/IN	tE/s
690 Y	50	30	1475	32.5	0.83		
400 D	50	30	1475	56	0.83		
660 Y	50	30	1470	34	0.83		
380 D	50	30	1470	59	0.83		
415 D	50	30	1475	54	0.83		
440 D	60	35	1770	59	0.83		
Cat. no 3GAA 202 001 - ADA							
6312/C3				6210/C3		180 kg	
IEC 34-1							

380 V supply voltage

- nominal motor voltage (parameter [9905](#))

Setting of parameter [9905](#) is shown below as an example of parameter setting with the Basic control panel. You find more detailed instructions in chapter *Control panels*, section *Basic control panel* in *ACS310 user's manual* (3AUA0000044201 [English]).

1. To go to the Main menu, press  if the bottom line shows OUTPUT; otherwise press  repeatedly until you see MENU at the bottom.
2. Press keys /  until you see "PAR", and press .
3. Find the appropriate parameter group with keys /  and press .
4. Find the appropriate parameter in the group with keys / .
5. Press and hold  for about two seconds until the parameter value is shown with **SET** under the value.
6. Change the value with keys / . The value changes faster while you keep the key pressed down.
7. Save the parameter value by pressing .

Enter the rest of the motor data:

- nominal motor current (parameter [9906](#))
Allowed range: $0.2 \dots 2.0 \cdot I_{2N}$ A
- nominal motor frequency (parameter [9907](#))
- nominal motor speed (parameter [9908](#))
- nominal motor power (parameter [9909](#))

- Select the application macro (parameter [9902](#)) according to how the control cables are connected. The default value 1 (**ABB STANDARD**) is suitable in most cases.

REM 9905
PAR FWD

REM rEF
MENU FWD

REM -01-
PAR FWD

REM 9901
PAR FWD

REM 9905
PAR FWD

REM 400^V
PAR **SET** FWD

REM 380^V
PAR **SET** FWD

REM 9905
PAR FWD

REM 9906
PAR FWD

REM 9907
PAR FWD









REM 9908
PAR FWD

REM 9909
PAR FWD

REM 9902
PAR FWD



DIRECTION OF THE MOTOR ROTATION

- Check the direction of the motor rotation.
 - If the drive is in remote control (REM shown on the left), switch to local control by pressing .
 - To go to the Main menu, press  if the bottom line shows OUTPUT; otherwise press  repeatedly until you see MENU at the bottom.
 - Press keys /  until you see “rEF” and press .
 - Increase the frequency reference from zero to a small value with key .
 - Press  to start the motor.
 - Check that the actual direction of the motor is the same as indicated on the display (FWD means forward and REV reverse).
 - Press  to stop the motor.

To change the direction of the motor rotation:

 - If parameter 9914 PHASE INVERSION is not visible, first set parameter **1611 PARAMETER VIEW** to 3 (**LONG VIEW**).
 - Invert the phases by changing the value of parameter 9914 to the opposite, ie from 0 (NO) to 1 (YES), or vice versa.
 - Verify your work by applying input power and repeating the check as described above. Set parameter **1611** back to 2 (**SHORT VIEW**).

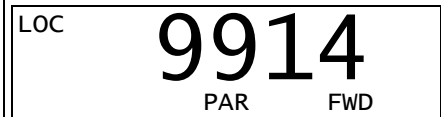

FINAL CHECK

- Check that the drive state is OK.

Basic control panel: Check that there are no faults or alarms shown on the display. If you want to check the LEDs on the front of the drive, switch first to remote control (otherwise a fault is generated) before removing the panel and verifying that the red LED is not lit and the green LED is lit but not blinking.

Assistant control panel: Check that there are no faults or alarms shown on the display and that the panel LED is green and does not blink.













The drive is now ready for use.



■ How to perform a guided start-up

To be able to perform the guided start-up, you need the Assistant control panel.





Before you start, ensure that you have the motor nameplate data on hand.

POWER-UP	
<p><input type="checkbox"/> Apply input power. The control panel first asks if you want to use the Start-up assistant.</p> <ul style="list-style-type: none"> • Press  (when Yes is highlighted) to run the Start-up assistant. • Press  if you do not want to run the Start-up assistant. • Press key  to highlight No and then press  if you want to make the panel ask (or not ask) the question about running the Start-up assistant again the next time you switch on the power to the drive. 	<div style="border: 1px solid black; padding: 5px; margin-bottom: 10px;"> <p>REM ↻ CHOICE</p> <p>Do you want to use the start-up assistant?</p> <p>Yes</p> <p>No</p> <p>EXIT 00:00 OK</p> </div> <div style="border: 1px solid black; padding: 5px;"> <p>REM ↻ CHOICE</p> <p>Show start-up assistant on next boot?</p> <p>Yes</p> <p>No</p> <p>EXIT 00:00 OK</p> </div>
SELECTING THE LANGUAGE	
<p><input type="checkbox"/> If you decided to run the Start-up assistant, the display then asks you to select the language. Scroll to the desired language with keys / and press  to accept.</p> <p>If you press , the Start-up assistant is stopped.</p>	<div style="border: 1px solid black; padding: 5px;"> <p>REM ↻ PAR EDIT</p> <p>9901 LANGUAGE</p> <p>ENGLISH</p> <p>[0]</p> <p>EXIT 00:00 SAVE</p> </div>
STARTING THE GUIDED SET-UP	
<p><input type="checkbox"/> The Start-up assistant now guides you through the set-up tasks, starting with the motor set-up. Set the motor data to exactly the same value as on the motor nameplate.</p> <p>Scroll to the desired parameter value with keys / and press  to accept and continue with the Start-up assistant.</p> <p>Note: At any time, if you press , the Start-up assistant is stopped and the display goes to the Output mode.</p>	<div style="border: 1px solid black; padding: 5px; margin-bottom: 10px;"> <p>REM ↻ PAR EDIT</p> <p>9905 MOTOR NOM VOLT</p> <p>220 V</p> <p>EXIT 00:00 SAVE</p> </div>
<p><input type="checkbox"/> The basic start-up is now completed. However, it might be useful at this stage to set the parameters required by your application and continue with the application set-up as suggested by the Start-up assistant.</p>	<div style="border: 1px solid black; padding: 5px;"> <p>REM ↻ CHOICE</p> <p>Do you want to continue with application setup?</p> <p>Continue</p> <p>Skip</p> <p>EXIT 00:00 OK</p> </div>







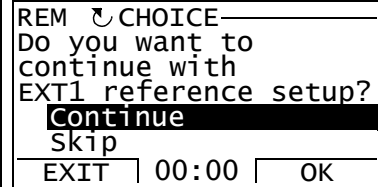
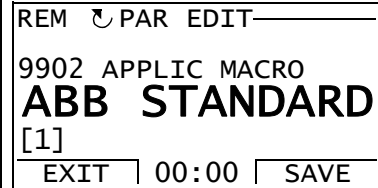

- Select the application macro according to which the control cables are connected.

Continue with the application set-up. After completing a set-up task, the Start-up assistant suggests the next one.

- Press  (when **Continue** is highlighted) to continue with the suggested task.
- Press key  to highlight **Skip** and then press  to move to the following task without doing the suggested task.
- Press  to stop the Start-up assistant.



DIRECTION OF THE MOTOR ROTATION

- Check the direction of the motor rotation.
 - If the drive is in remote control (REM shown on the status line), switch to local control by pressing .
 - If you are not in the Output mode, press  repeatedly until you get there.
 - Increase the frequency reference from zero to a small value with key .
 - Press  to start the motor.
 - Check that the actual direction of the motor is the same as indicated on the display ( means forward and  reverse).
 - Press  to stop the motor.

To change the direction of the motor rotation:

- If parameter 9914 PHASE INVERSION is not visible, first set parameter **1611 PARAMETER VIEW** to 3 (**LONG VIEW**).
- Invert the phases by changing the value of parameter 9914 to the opposite, ie from 0 (NO) to 1 (YES), or vice versa.
- Verify your work by applying input power and repeating the check as described above.
- Set parameter **1611** back to 2 (**SHORT VIEW**).

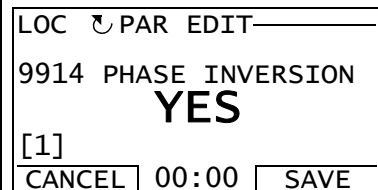
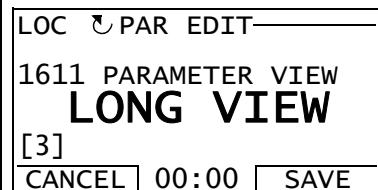
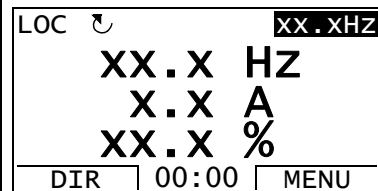

FINAL CHECK

- | | |
|--------------------------|---|
| <input type="checkbox"/> | After the whole set-up is completed, check that there are no faults or alarms shown on the display and the panel LED is green and does not blink. |
|--------------------------|---|

The drive is now ready for use.



How to control the drive through the I/O interface

The table below instructs how to operate the drive through the digital and analog inputs when:

- the motor start-up is performed, and
- the default (standard) parameter settings are valid.

Displays of the Basic control panel are shown as an example.

PRELIMINARY SETTINGS	
<p>If you need to change the direction of rotation, check that parameter 1003 DIRECTION is set to 3 (REQUEST).</p> <p>Ensure that the control connections are wired according to the connection diagram given for the ABB standard macro.</p> <p>Ensure that the drive is in remote control. Press key  to switch between remote and local control.</p>	<p>See section Default I/O connection diagram on page 16.</p> <p>In remote control, the panel display shows text REM.</p>
STARTING AND CONTROLLING THE SPEED OF THE MOTOR	
<p>Start by switching digital input DI1 on.</p> <p><u>Basic control panel:</u> Text FWD starts flashing fast and stops after the setpoint is reached</p> <p><u>Assistant control panel:</u> The arrow starts rotating. It is dotted until the setpoint is reached.</p> <p>Regulate the drive output frequency (motor speed) by adjusting the voltage of analog input AI1.</p>	<div style="border: 1px solid black; padding: 5px; margin-bottom: 10px;"> <p>REM 0.0 Hz</p> <p>OUTPUT FWD</p> </div> <div style="border: 1px solid black; padding: 5px;"> <p>REM 50.0 Hz</p> <p>OUTPUT FWD</p> </div>
CHANGING THE DIRECTION OF ROTATION OF THE MOTOR	
<p>Reverse direction: Switch digital input DI2 on.</p> <p>Forward direction: Switch digital input DI2 off.</p>	<div style="border: 1px solid black; padding: 5px; margin-bottom: 10px;"> <p>REM 50.0 Hz</p> <p>OUTPUT REV</p> </div> <div style="border: 1px solid black; padding: 5px;"> <p>REM 50.0 Hz</p> <p>OUTPUT FWD</p> </div>
STOPPING THE MOTOR	
<p>Switch digital input DI1 off. The motor stops.</p> <p><u>Basic control panel:</u> Text FWD starts flashing slowly.</p> <p><u>Assistant control panel:</u> The arrow stops rotating.</p>	<div style="border: 1px solid black; padding: 5px;"> <p>REM 0.0 Hz</p> <p>OUTPUT FWD</p> </div>



6. Actual signals and parameters in the short view

Note: When the control panel is in the short parameter view, ie when parameter [1611 PARAMETER VIEW](#) is set to 2 (*SHORT VIEW*), the control panel only shows a subset of all signals and parameters. These signals and parameters are described in this chapter.

To be able to view all actual signals and parameters, set parameter [1611 PARAMETER VIEW](#) to 3 (*LONG VIEW*). For the description of all actual signals and parameters, refer to chapter *Actual signals and parameters* in *ACS310 user's manual* (3AUA0000044201 [English]).

Terms and abbreviations

Term	Definition
Actual signal	Signal measured or calculated by the drive. Can be monitored by the user. No user setting possible. Groups 01...04 contain actual signals.
Def	Parameter default value
Parameter	A user-adjustable operation instruction of the drive. Groups 10...99 contain parameters. Note: Parameter selections are shown on the Basic control panel as integer values. Eg parameter 1001 EXT1 COMMANDS selection COMM is shown as value 10 (which is equal to the fieldbus equivalent FbEq).
FbEq	Fieldbus equivalent: The scaling between the value and the integer used in serial communication.
E	Refers to types 03E- with European parametrization
U	Refers to types 03U- with US parametrization

Fieldbus equivalent

Example: If [2008 MAXIMUM FREQ](#) (see page [31](#)) is set from an external control system, an integer value of 1 corresponds to 0.1 Hz. All the read and sent values are limited to 16 bits (-32768...32767).

Default values with different macros

When application macro is changed ([9902 APPLIC MACRO](#)), the software updates the parameter values to their default values. The table below shows the parameter default values for different macros. For other parameters, the default values are the same for all macros. See the parameter list starting on page [29](#) in this manual and chapter *Actual signals and parameters* in *ACS310 user's manual (3AUA0000044201 [English])*. For information on the different macros, see chapter *Application macros* in the same manual.

Index	Name/Selection	ABB STANDARD	3-WIRE	ALTERNATE	MOTOR POT	HAND/AUTO	PID CONTROL	PFC CONTROL	SPFC CONTROL
9902	APPLIC MACRO	1 = ABB STANDARD	2 = 3-WIRE	3 = ALTERNATE	4 = MOTOR POT	5 = HAND/AUTO	6 = PID CONTROL	7 = PFC CONTROL	15 = SPFC CONTROL
1001	EXT1 COMMANDS	DI1,2	DI1P,2P,3	DI1F,2R	DI1,2	DI1,2	DI1	DI1	DI1
1002	EXT2 COMMANDS	NOT SEL	NOT SEL	NOT SEL	NOT SEL	DI5,4	DI5	DI5	DI5
1003	DIRECTION	REQUEST	REQUEST	REQUEST	REQUEST	REQUEST	FORWARD	FORWARD	FORWARD
1102	EXT1/EXT2 SEL	EXT1	EXT1	EXT1	EXT1	DI3	DI2	DI2	DI2
1103	REF1 SELECT	AI1	AI1	AI1	DI3U, 4D(NC)	AI1	AI1	AI1	AI1
1106	REF2 SELECT	AI2	AI2	AI2	AI2	AI2	PID1OUT	PID1OUT	PID1OUT
1201	CONST SPEED SEL	DI3,4	DI4,5	DI3,4	DI5	NOT SEL	DI3	NOT SEL	NOT SEL
1304	MINIMUM AI2	1.0%	1.0%	1.0%	1.0%	20.0%	20.0%	20.0%	20.0%
1401	RELAY OUTPUT 1	FAULT(-1)	FAULT(-1)	FAULT(-1)	FAULT(-1)	FAULT(-1)	FAULT(-1)	PFC	PFC
1601	RUN ENABLE	NOT SEL	NOT SEL	NOT SEL	NOT SEL	NOT SEL	DI4	NOT SEL	NOT SEL
1805	DO SIGNAL	FAULT(-1)	FAULT(-1)	FAULT(-1)	FAULT(-1)	FAULT(-1)	FAULT(-1)	FAULT(-1)	PFC
2008	MAXIMUM FREQ	50.0 Hz	50.0 Hz	50.0 Hz	50.0 Hz	50.0 Hz	50.0 Hz	52.0 Hz	52.0 Hz
2201	ACC/DEC 1/2 SEL	DI5	NOT SEL	DI5	NOT SEL	NOT SEL	NOT SEL	NOT SEL	NOT SEL
2202	ACCELER TIME 1	5.0 s	5.0 s	5.0 s	5.0 s	5.0 s	5.0 s	5.0 s	30.0 s
2203	DECELER TIME 1	5.0 s	5.0 s	5.0 s	5.0 s	5.0 s	5.0 s	5.0 s	30.0 s
3019	COMMFAULT TIME	3.0 s	3.0 s	3.0 s	3.0 s	3.0 s	3.0 s	3.0 s	10.0 s
4001	GAIN	1.0	1.0	1.0	1.0	1.0	1.0	2.5	2.5
4002	INTEGRATION TIME	60.0 s	60.0 s	60.0 s	60.0 s	60.0 s	60.0 s	3.0 s	3.0 s
4101	GAIN	1.0	1.0	1.0	1.0	1.0	1.0	2.5	2.5
4102	INTEGRATION TIME	60.0 s	60.0 s	60.0 s	60.0 s	60.0 s	60.0 s	3.0 s	3.0 s
8116	AUX MOT STOP D	3.0 s	3.0 s	3.0 s	3.0 s	3.0 s	3.0 s	3.0 s	20.0 s
8118	AUTOCHNG INTERV	NOT SEL	NOT SEL	NOT SEL	NOT SEL	NOT SEL	NOT SEL	NOT SEL	0.1 h
8123	PFC ENABLE	NOT SEL	NOT SEL	NOT SEL	NOT SEL	NOT SEL	NOT SEL	ACTIVE	SPFC ACTIVE

Actual signals in the short parameter view

Actual signals in the short parameter view			
No.	Name/Value	Description	FbEq
04 FAULT HISTORY		Fault history (read-only)	
0401	LAST FAULT	Code of the latest fault. See chapter <i>Fault tracing</i> in <i>ACS310 user's manual</i> (3AUA0000044201 [English]) for the codes. 0 = Fault history is clear (on panel display = NO RECORD).	1 = 1

Parameters in the short parameter view

Parameters in the short parameter view																		
No.	Name/Value	Description	Def/FbEq															
11 REFERENCE SELECT		Panel reference type, external control location selection and external reference sources and limits																
1105	REF1 MAX	Defines the maximum value for external reference REF1. Corresponds to the maximum setting of the used source signal.	E: 50.0 Hz U: 60.0 Hz															
	0.0...500.0 Hz	Maximum value in Hz. See the example for parameter 1104 REF1 MIN in <i>ACS310 user's manual</i> (3AUA0000044201 [English]).	1 = 0.1 Hz															
12 CONSTANT SPEEDS		Constant speed (drive output frequency) selection and values. By default constant speed selection is made through digital inputs DI3 and DI4. 1 = DI active, 0 = DI inactive.																
		<table border="1"> <thead> <tr> <th>DI3</th> <th>DI4</th> <th>Operation</th> </tr> </thead> <tbody> <tr> <td>0</td> <td>0</td> <td>No constant speed</td> </tr> <tr> <td>1</td> <td>0</td> <td>Speed defined by parameter 1202 CONST SPEED 1</td> </tr> <tr> <td>0</td> <td>1</td> <td>Speed defined by parameter 1203 CONST SPEED 2</td> </tr> <tr> <td>1</td> <td>1</td> <td>Speed defined by parameter 1204 CONST SPEED 3</td> </tr> </tbody> </table>	DI3	DI4	Operation	0	0	No constant speed	1	0	Speed defined by parameter 1202 CONST SPEED 1	0	1	Speed defined by parameter 1203 CONST SPEED 2	1	1	Speed defined by parameter 1204 CONST SPEED 3	
DI3	DI4	Operation																
0	0	No constant speed																
1	0	Speed defined by parameter 1202 CONST SPEED 1																
0	1	Speed defined by parameter 1203 CONST SPEED 2																
1	1	Speed defined by parameter 1204 CONST SPEED 3																
		For more information, see chapter <i>Program features</i> , section <i>Constant speeds</i> in <i>ACS310 user's manual</i> (3AUA0000044201 [English]).																
1202	CONST SPEED 1	Defines constant drive output frequency 1.	E: 5.0 Hz U: 6.0 Hz															
	0.0...500.0 Hz	Output frequency in Hz.	1 = 0.1 Hz															
1203	CONST SPEED 2	Defines constant drive output frequency 2.	E: 10.0 Hz U: 12.0 Hz															
	0.0...500.0 Hz	Output frequency in Hz.	1 = 0.1 Hz															
1204	CONST SPEED 3	Defines constant drive output frequency 3.	E: 15.0 Hz U: 18.0 Hz															
	0.0...500.0 Hz	Output frequency in Hz.	1 = 0.1 Hz															

Parameters in the short parameter view			
No.	Name/Value	Description	Def/FbEq
13 ANALOG INPUTS Analog input signal processing			
1301	MINIMUM AI1	<p>Defines the minimum %-value that corresponds to minimum mA/(V) signal for analog input AI1. When used as a reference, the value corresponds to the reference minimum setting.</p> <p>0...20 mA $\hat{=}$ 0...100% 4...20 mA $\hat{=}$ 20...100% -10...10 mA $\hat{=}$ -50...50%</p> <p>Example: If AI1 is selected as the source for external reference REF1, this value corresponds to the value of parameter 1104 REF1 MIN.</p> <p>Note: <i>MINIMUM AI1</i> value must not exceed MAXIMUM AI value.</p>	1.0%
	-100.0... 100.0%	<p>Value in percent of the full signal range.</p> <p>Example: If the minimum value for analog input is 4 mA, the percent value for 0...20 mA range is: (4 mA / 20 mA) · 100% = 20%</p>	1 = 0.1%
14 RELAY OUTPUTS Status information indicated through relay output, and relay operating delays. For more information, see chapter <i>Actual signals and parameters</i> in <i>ACS310 user's manual</i> (3AUA0000044201 [English]).			
1401	RELAY OUTPUT 1	Selects a drive status indicated through relay output RO 1. The relay energizes when the status meets the setting.	<i>FAULT(-1)</i>
	NOT SEL	Not used	0
	READY	Ready to function: Run enable signal on, no fault, supply voltage within acceptable range and emergency stop signal off.	1
	RUN	Running: Start signal on, Run enable signal on, no active fault.	2
	FAULT(-1)	Inverted fault. Relay is de-energized on a fault trip.	3
	PFC	Start/stop motor in PFC control. See parameter group 81 PFC CONTROL in <i>ACS310 user's manual</i> (3AUA0000044201 [English]). Use this option only when PFC control is used. Selection activated/deactivated when the drive is not running.	31
16 SYSTEM CONTROLS Parameter view, Run enable, parameter lock etc.			
1611	PARAMETER VIEW	Selects the parameter view, ie which parameters are shown on the control panel.	<i>SHORT VIEW</i>
	FLASHDROP	<p>Shows the FlashDrop parameter list. Does not include the short parameter list. Parameters which are hidden by the FlashDrop device are not visible.</p> <p>FlashDrop parameter values are activated by setting parameter <i>9902 APPLIC MACRO</i> to 31 (<i>LOAD FD SET</i>).</p>	1
	SHORT VIEW	Shows only those signals and parameters that are listed in this table and the table in section <i>Actual signals in the short parameter view</i> on page 29.	2
	LONG VIEW	Shows all signals and parameters. See chapter <i>Actual signals and parameters</i> in <i>ACS310 user's manual</i> (3AUA0000044201 [English]).	3

Parameters in the short parameter view			
No.	Name/Value	Description	Def/FbEq
20 LIMITS		Drive operation limits	
2008	MAXIMUM FREQ	Defines the maximum limit for the drive output frequency.	E: 50.0 Hz U: 60.0 Hz
	0.0...500.0 Hz	Maximum frequency	1 = 0.1 Hz
21 START/STOP		Start and stop modes of the motor	
2102	STOP FUNCTION	Selects the motor stop function.	COAST
	COAST	Stop by cutting off the motor power supply. The motor coasts to stop.	1
	RAMP	Stop along a ramp. See parameter group 22 ACCEL/DECEL .	2
22 ACCEL/DECEL		Acceleration and deceleration times	
2202	ACCELER TIME 1	Defines the acceleration time 1, ie the time required for the speed to change from zero to the speed defined by parameter 2008 MAXIMUM FREQ . <ul style="list-style-type: none"> If the speed reference increases faster than the set acceleration rate, the motor speed will follow the acceleration rate. If the speed reference increases slower than the set acceleration rate, the motor speed will follow the reference signal. If the acceleration time is set too short, the drive will automatically prolong the acceleration in order not to exceed the drive operating limits. Actual acceleration time depends on parameter 2204 RAMP SHAPE 1 setting.	5.0 s
	0.0...1800.0 s	Time	1 = 0.1 s
2203	DECELER TIME 1	Defines the deceleration time 1, ie the time required for the speed to change from the value defined by parameter 2008 MAXIMUM FREQ to zero. <ul style="list-style-type: none"> If the speed reference decreases slower than the set deceleration rate, the motor speed will follow the reference signal. If the reference changes faster than the set deceleration rate, the motor speed will follow the deceleration rate. If the deceleration time is set too short, the drive will automatically prolong the deceleration in order not to exceed drive operating limits. If a short deceleration time is needed for a high inertia application, note that the ACS310 cannot be equipped with a brake resistor. Actual deceleration time depends on parameter 2204 RAMP SHAPE 1 setting.	5.0 s
	0.0...1800.0 s	Time	1 = 0.1 s
99 START-UP DATA		Language selection. Definition of motor set-up data.	
9901	LANGUAGE	Selects the display language used on the Assistant control panel. Note: With the ACS-CP-D Assistant control panel, the following languages are available: English (0), Chinese (1), Korean (2) and Japanese (3).	ENGLISH

Parameters in the short parameter view			
No.	Name/Value	Description	Def/FbEq
	ENGLISH	British English	0
	ENGLISH (AM)	American English	1
	DEUTSCH	German	2
	ITALIANO	Italian	3
	ESPAÑOL	Spanish	4
	PORTUGUES	Portuguese	5
	NEDERLANDS	Dutch	6
	FRANÇAIS	French	7
	DANSK	Danish	8
	SUOMI	Finnish	9
	SVENSKA	Swedish	10
	RUSSKI	Russian	11
	POLSKI	Polish	12
	TÜRKÇE	Turkish	13
	CZECH	Czech	14
	MAGYAR	Hungarian	15
	ELLINIKA	Greek	16
9902	APPLIC MACRO	Selects the application macro. See chapter <i>Application macros</i> in <i>ACS310 user's manual</i> (3AUA0000044201 [English]).	ABB STANDA RD
	ABB STANDARD	Standard macro for constant speed applications	1
	3-WIRE	3-wire macro for constant speed applications	2
	ALTERNATE	Alternate macro for start forward and start reverse applications	3
	MOTOR POT	Motor potentiometer macro for digital signal speed control applications	4
	HAND/AUTO	Hand/Auto macro to be used when two control devices are connected to the drive: <ul style="list-style-type: none"> • Device 1 communicates through the interface defined by external control location EXT1. • Device 2 communicates through the interface defined by external control location EXT2. EXT1 or EXT2 is active at a time. Switching between EXT1/2 through a digital input.	5
	PID CONTROL	PID control. For applications in which the drive controls a process value, eg pressure control by the drive running the pressure boost pump. Measured pressure and the pressure reference are connected to the drive.	6
	PFC CONTROL	PFC (Pump and fan control) macro for pump alternation applications	7
	SPFC CONTROL	SPFC (Soft pump and fan control) macro for pump alternation applications where lower pressure peaks are desirable when a new auxiliary motor is started.	15

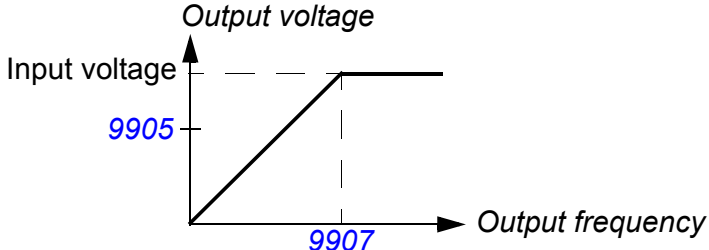
Parameters in the short parameter view			
No.	Name/Value	Description	Def/FbEq
	LOAD FD SET	FlashDrop parameter values as defined by the FlashDrop file. Parameter view is selected by parameter 1611 PARAMETER VIEW . FlashDrop is an optional device for fast copying of parameters to unpowered drives. FlashDrop allows easy customization of the parameter list, eg selected parameters can be hidden. For more information, see <i>MFDT-01 FlashDrop user's manual</i> (3AFE68591074 [English]).	31
	USER S1 LOAD	User 1 macro loaded into use. Before loading, check that the saved parameter settings and the motor model are suitable for the application.	0
	USER S1 SAVE	Save User 1 macro. Stores the current parameter settings and the motor model.	-1
	USER S2 LOAD	User 2 macro loaded into use. Before loading, check that the saved parameter settings and the motor model are suitable for the application.	-2
	USER S2 SAVE	Save User 2 macro. Stores the current parameter settings and the motor model.	-3
9905	MOTOR NOM VOLT	<p>Defines the nominal motor voltage. Must be equal to the value on the motor rating plate. The drive cannot supply the motor with a voltage greater than the input power voltage. Note that the output voltage is not limited by the nominal motor voltage but increased linearly up to the value of the input voltage.</p>  <p style="text-align: center;">WARNING! Never connect a motor to a drive which is connected to power line with voltage level higher than the rated motor voltage.</p>	200 V units: 230 V 400 V E units: 400 V 400 V U units: 460 V
	200 V units: 115...345 V 400 V E units: 200...600 V 400 V U units: 230...690 V	Voltage. Note: The stress on the motor insulations is always dependent on the drive supply voltage. This also applies to the case where the motor voltage rating is lower than the rating of the drive and the supply of the drive.	1 = 1 V
9906	MOTOR NOM CURR	Defines the nominal motor current. Must be equal to the value on the motor rating plate.	I_{2N}
	0.2...2.0 · I_{2N}	Current	1 = 0.1 A
9907	MOTOR NOM FREQ	Defines the nominal motor frequency, ie the frequency at which the output voltage equals the nominal motor voltage: Field weakening point = Nom. frequency · Supply voltage / Motor nom. voltage	E: 50.0 Hz U: 60.0 Hz
	10.0...500.0 Hz	Frequency	1 = 0.1 Hz

34 Actual signals and parameters in the short view

Parameters in the short parameter view			
No.	Name/Value	Description	Def/FbEq
9908	MOTOR NOM SPEED	Defines the nominal motor speed. Must be equal to the value on the motor rating plate.	Type dependent
	50...18000 rpm	Speed	1 = 1 rpm
9909	MOTOR NOM POWER	Defines the nominal motor power. Must equal the value on the motor rating plate.	P_N
	0.2...3.0 · P_N kW	Power	1 = 0.1 kW / 0.1 hp

7. Technical data

Ratings

Type	Input	Output					Frame size
		I_{LD}	I_{2N}	I_{2max}	P_N		
		A	A	A	kW	hp	
1-phase $U_N = 200...240$ V (200, 208, 220, 230, 240 V)							
01x-02A4-2	6.1	2.3	2.4	4.0	0.37	0.5	R0
01x-04A7-2	11.4	4.5	4.7	7.9	0.75	1	R1
01x-06A7-2	16.1	6.5	6.7	11.4	1.1	1.5	R1
01x-07A5-2	16.8	7.2	7.5	12.6	1.5	2	R2
01x-09A8-2	21.0	9.4	9.8	16.5	2.2	3	R2
3-phase $U_N = 200...240$ V (200, 208, 220, 230, 240 V)							
03x-02A6-2	4.7	2.4	2.6	4.2	0.37	0.5	R0
03x-03A9-2	6.7	3.5	3.9	6.1	0.55	0.75	R0
03x-05A2-2	8.4	4.7	5.2	8.2	0.75	1	R1
03x-07A4-2	13.0	6.7	7.4	11.7	1.1	1.5	R1
03x-08A3-2	13.2	7.5	8.3	13.1	1.5	2	R1
03x-10A8-2	15.7	9.8	10.8	17.2	2.2	3	R2
03x-14A6-2	23.9	13.3	14.6	23.3	3	3	R2
03x-19A4-2	27.3	17.6	19.4	30.8	4	5	R2
03x-26A8-2	45	24.4	26.8	42.7	5.5	7.5	R3
03x-34A1-2	55	31.0	34.1	54.3	7.5	10	R4
03x-50A8-2	76	46.2	50.8	80.9	11.0	15	R4
3-phase $U_N = 380...480$ V (380, 400, 415, 440, 460, 480 V)							
03x-01A3-4	2.4	1.2	1.3	2.1	0.37	0.5	R0
03x-02A1-4	4.0	1.9	2.1	3.3	0.55	0.75	R0
03x-02A6-4	4.5	2.4	2.6	4.2	0.75	1	R1
03x-03A6-4	6.6	3.3	3.6	5.8	1.1	1.5	R1
03x-04A5-4	7.6	4.1	4.5	7.2	1.5	2	R1
03x-06A2-4	10.6	5.6	6.2	9.8	2.2	3	R1
03x-08A0-4	12.8	7.3	8.0	12.8	3	3	R1
03x-09A7-4	15.0	8.8	9.7	15.4	4	5	R1
03x-13A8-4	20.7	12.5	13.8	21.9	5.5	7.5	R3
03x-17A2-4	24.3	15.6	17.2	27.3	7.5	10	R3
03x-25A4-4	34.0	23.1	25.4	40.4	11	15	R3
03x-34A1-4	57	31	34.1	54.3	15	20	R4
03x-41A8-4	67	38	41.8	66.5	18.5	25	R4
03x-48A4-4	74	44	48.4	77.0	22.0	30	R4

¹⁾ E = EMC filter connected (metal EMC filter screw installed),
 U = EMC filter disconnected (plastic EMC filter screw installed), US
 parametrization

■ Definitions

I_{1N}	continuous rms input current (for dimensioning cables and fuses) at ambient temperature of +40 °C
I_{LD}	continuous output current at max ambient temperature of +50 °C. 10% overloadability for one minute every ten minutes.
I_{2N}	maximum continuous output current at ambient temperature of +40 °C. No overloadability, derating 1% for every additional 1 °C up to 50 °C.
I_{2max}	maximum instantaneous output current. Available for two seconds every ten minutes at start-up, or as long as allowed by the drive temperature.
P_N	typical motor power. The kilowatt ratings apply to most IEC 4-pole motors. The horsepower ratings apply to most NEMA 4-pole motors.
R0...R4	ACS310 is manufactured in frame sizes R0...R4. Some instructions and other information that only concern certain frame sizes are marked with the symbol of the frame size (R0...R4)

■ Sizing

Drive sizing is based on the rated motor current and power. To achieve the rated motor power given in the table, the rated current of the drive must be higher than or equal to the rated motor current. Also the rated power of the drive must be higher than or equal to compared to the rated motor power. The power ratings are the same regardless of the supply voltage within one voltage range.

Note 1: The maximum allowed motor shaft power is limited to $1.5 \cdot P_N$. If the limit is exceeded, motor torque and current are automatically restricted. The function protects the input bridge of the drive against overload.

Note 2: The ratings apply at ambient temperature of 40 °C (104 °F) for I_{2N} and 50 °C (122 °F) for I_{LD} .

In multimotor systems, the output current of the drive must be equal to or greater than the calculated sum of the input currents of all motors.

■ Derating

For information on derating, see chapter *Technical data*, section *Derating* in *ACS310 user's manual* (3AUA0000044201 [English]).

Power cable sizes and fuses

Note: Do not use larger fuses when the input power cable is selected according to this table.

Type	Fuses		Size of copper conductor in cabling					
	gG	UL Class T (600 V)	Supply (U1, V1, W1)		Motor (U2, V2, W2)		PE	
			mm ²	AWG	mm ²	AWG	mm ²	AWG
x = E/U	A	A						
1-phase $U_N = 200...240$ V (200, 208, 220, 230, 240 V)								
01x-02A4-2	10	10	2.5	14	0.75	18	2.5	14
01x-04A7-2	16	20	2.5	14	0.75	18	2.5	14
01x-06A7-2	16/20 ¹⁾	25	2.5	10	1.5	14	2.5	10
01x-07A5-2	20/25 ¹⁾	30	2.5	10	1.5	14	2.5	10
01x-09A8-2	25/35 ¹⁾	35	6	10	2.5	12	6	10
3-phase $U_N = 200...240$ V (200, 208, 220, 230, 240 V)								
03x-02A6-2	10	10	2.5	14	1.5	14	2.5	14
03x-03A9-2	10	10	2.5	14	1.5	14	2.5	14
03x-05A2-2	10	15	2.5	14	1.5	14	2.5	14
03x-07A4-2	16	15	2.5	12	1.5	14	2.5	12
03x-08A3-2	16	15	2.5	12	1.5	14	2.5	12
03x-10A8-2	16	20	2.5	12	2.5	12	2.5	12
03x-14A6-2	25	30	6.0	10	6	10	6.0	10
03x-19A4-2	25	35	6.0	10	6	10	6.0	10
03x-26A8-2	63	60	10.0	8	10	8	10.0	8
03x-34A1-2	80	80	16.0	6	16	6	16.0	6
03x-50A8-2	100	100	25.0	2	25	2	16.0	4
3-phase $U_N = 380...480$ V (380, 400, 415, 440, 460, 480 V)								
03x-01A3-4	10	10	2.5	14	1.5	14	2.5	14
03x-02A1-4	10	10	2.5	14	1.5	14	2.5	14
03x-02A6-4	10	10	2.5	14	1.5	14	2.5	14
03x-03A6-4	10	10	2.5	12	1.5	14	2.5	12
03x-04A5-4	16	15	2.5	12	1.5	14	2.5	12
03x-06A2-4	16	15	2.5	12	1.5	14	2.5	12
03x-08A0-4	16	20	2.5	12	1.5	14	2.5	12
03x-09A7-4	20	25	2.5	12	2.5	12	2.5	12
03x-13A8-4	25	30	6.0	10	6	10	6.0	10
03x-17A2-4	35	35	6.0	8	6	8	6.0	8
03x-25A4-4	50	50	10.0	8	10	8	10.0	8
03x-34A1-4	80	80	16.0	6	16	6	16.0	6
03x-41A8-4	100	100	25.0	4	16	4	16.0	4
03x-48A4-4	100	100	25.0	4	25	4	16.0	4

¹⁾ If 50% overload capacity is needed, use the larger fuse alternative.

UL checklist

The UL mark is attached to the drive to verify that it meets UL requirements.

See the instructions for electrical installation in the sections in this manual or in the *ACS310 user's manual* (3AUA0000044201 [English]) specified below.

Input power connection – See *ACS310 user's manual*, chapter *Technical data*, section *Electric power network specification*.

Disconnecting device (disconnecting means) – See *ACS310 user's manual*, chapter *Planning the electrical installation*, section *Selecting the supply disconnecting device (disconnecting means)*.

Ambient conditions – The drives are to be used in a heated indoor controlled environment. See *ACS310 user's manual*, chapter *Technical data*, section *Ambient conditions* for specific limits.

Input cable fuses – For installation in the United States, branch circuit protection must be provided in accordance with the National Electrical Code (NEC) and any applicable local codes. To fulfil this requirement, use the UL classified fuses given in section [Power cable sizes and fuses](#) on page 37.

For installation in Canada, branch circuit protection must be provided in accordance with Canadian Electrical Code and any applicable provincial codes. To fulfil this requirement, use the UL classified fuses given in section [Power cable sizes and fuses](#) on page 37.

Power cable selection – See *ACS310 user's manual*, chapter *Planning the electrical installation*, section *Selecting the power cables*.

Power cable connections – For the connection diagram and tightening torques, see section [Connecting the power cables](#) on page 14.

Overload protection – The drive provides overload protection in accordance with the National Electrical Code (US).

Declaration of incorporation



Declaration of Incorporation

(According to Machinery Directive 2006/42/EC)

Manufacturer: ABB Oy
Address: P.O Box 184, FIN-00381 Helsinki, Finland. Street address: Hiomotie 13,

herewith declare under our sole responsibility that the frequency converters with type markings:

ACS310-...

are intended to be incorporated into machinery or to be assembled with other machinery to constitute machinery covered by Machinery Directive 2006/42/EC and relevant essential health and safety requirements of the Directive and its Annex I have been complied with.

The technical documentation is compiled in accordance with part B of Annex VII, the assembly instructions are prepared according Annex VI and the following harmonised European standard has been applied:

EN 60204-1:2006 + A1:2009
Safety of machinery - Electrical equipment of machines- Part 1: general requirements

and that the following technical standard have been used:

EN 60529 (1991 + corrigendum May 1993 + amendment A1:2000)
Degrees of protection provided by enclosures (IP codes)

The person authorized to compile the technical documentation:

Name: Jukka Päre
Address: P.O Box 184, FIN-00381 Helsinki

The products referred in this Declaration of Incorporation are in conformity with Low voltage directive 2006/95/EC and EMC directive 2004/108/EC. The Declaration of Conformity according to these directives is available from the manufacturer.

ABB Oy furthermore declares that it is not allowed to put the equipment into service until the machinery into which it is to be incorporated or of which it is to be a component has been found and declared to be in conformity with the provisions of the Directive 2006/42/EC and with national implementing legislation, i.e. as a whole, including the equipment referred to in this Declaration.

ABB Oy gives an undertaking to the national authorities to transmit, in response to a reasoned request by the national authorities, relevant information on the partly completed machinery. The method of transmission can be either electrical or paper format and it shall be agreed with the national authority when the information is asked. This transmission of information shall be without prejudice to the intellectual property rights of the manufacturer.

Helsinki, 29.12.2009

Panu Virolainen

Vice President
ABB Oy, BAU Drives

Further information

Product and service inquiries

Address any inquiries about the product to your local ABB representative, quoting the type designation and serial number of the unit in question. A listing of ABB sales, support and service contacts can be found by navigating to www.abb.com/drives and selecting *Sales, Support and Service network*.

Product training

For information on ABB product training, navigate to www.abb.com/drives and select *Training courses*.

Providing feedback on ABB Drives manuals

Your comments on our manuals are welcome. Go to www.abb.com/drives and select *Document Library – Manuals feedback form (LV AC drives)*.

Document library on the Internet

You can find manuals and other product documents in PDF format on the Internet. Go to www.abb.com/drives and select *Document Library*. You can browse the library or enter selection criteria, for example a document code, in the search field.

Contact us

ABB Oy

Drives
P.O. Box 184
FI-00381 HELSINKI
FINLAND
Telephone +358 10 22 11
Fax +358 10 22 22681
www.abb.com/drives

ABB Inc.

Automation Technologies
Drives & Motors
16250 West Glendale Drive
New Berlin, WI 53151
USA
Telephone 262 785-3200
1-800-HELP-365
Fax 262 780-5135
www.abb.com/drives

ABB Beijing Drive Systems Co. Ltd.

No. 1, Block D, A-10 Jiuxianqiao Beilu
Chaoyang District
Beijing, P.R. China, 100015
Telephone +86 10 5821 7788
Fax +86 10 5821 7618
www.abb.com/drives



3AJA0000044200 Rev C (EN) EFFECTIVE: 2011-05-25