

User's Manual

ACS550-CC Packaged Drive with Bypass
Supplement for ACS550-01/U1 Drives User's Manual



ABB

ACS550 Drive Manuals

GENERAL MANUALS

ACS550-01/U1 Drives User's Manual (1...550 HP)

- Safety
- Installation
- Start-Up
- Embedded Fieldbus
- Fieldbus Adapter
- Diagnostics
- Maintenance
- Technical Data

ACS550-PC/PD Drive with Disconnect

Supplement to ACS550-01/U1 User's Manual

- Safety
- Installation
- Start-Up
- Technical Data

ACS550-CC Packaged Drive with Bypass

Supplement for ACS550-01/U1 User's Manual

- Safety
- Installation
- Start-Up
- Maintenance
- Technical Data

Safety



WARNING! The ACS550 adjustable speed AC drive with Bypass should **ONLY** be installed by a qualified electrician.



WARNING! Even when the motor is stopped, dangerous voltage is present at the Power Circuit terminals U1, V1, W1 and U2, V2, W2 and, depending on the frame size, UDC+ and UDC-, or BRK+ and BRK-.



WARNING! Dangerous voltage is present when input power is connected. After disconnecting the supply, wait at least 5 minutes (to let the intermediate circuit capacitors discharge) before removing the cover.



WARNING! Even when power is removed from the input terminals of the ACS550, there may be dangerous voltage (from external sources) on the terminals of the relay outputs.



WARNING! When the control terminals of two or more drive units are connected in parallel, the auxiliary voltage for these control connections must be taken from a single source which can either be one of the units or an external supply.



WARNING! The ACS550 will start up automatically after an input voltage interruption if the external run command is on.



WARNING! When the ACS550 with Bypass is connected to the line power, the Motor Terminals T1, T2, and T3 are live even if the motor is not running. Do not make any connections when the ACS550 with Bypass is connected to the line. Disconnect and lock out power to the drive before servicing the drive. Failure to disconnect power may cause serious injury or death.

Note! For more technical information, contact the factory or your local ABB sales representative.

Use of Warnings and Notes

There are two types of safety instructions throughout this manual:

- Notes draw attention to a particular condition or fact, or give information on a subject.
- Warnings caution you about conditions which can result in serious injury or death and/or damage to the equipment. They also tell you how to avoid the danger. The warning symbols are used as follows:



Dangerous voltage warning warns of high voltage which can cause physical injury and/or damage to the equipment.



General warning warns about conditions, other than those caused by electricity, which can result in physical injury and/or damage to the equipment.

Table of Contents

Safety

Use of Warnings and Notes	2
---------------------------------	---

Table of Contents

Installation

Application	4
Bypass Features and Functions	4
Installation Flow Chart	6
Preparing for Installation (Supplement to ACS550-01/U1 User's Manual)	7
Preparing for Installation (Supplement to ACS550-01/U1 User's Manual)	8
Installing the Drive (Supplement to ACS550-01/U1 User's Manual)	9
Installing the Wiring (Supplement to ACS550-01/U1 User's Manual)	10

Maintenance

Maintenance Interval	17
----------------------------	----

Technical Data

Ratings (Supplement to ACS550-01/U1 User's Manual)	18
Input Power Connections (Supplement to ACS550-01/U1 User's Manual) ...	18
Motor Connections (Supplement to ACS550-01/U1 User's Manual)	25
Motor Connection Specifications – R7/R8	26
Cooling – R7/R8	26
Dimensions and Weights (Supplement to ACS550-01/U1 User's Manual) ...	27
Applicable Standards	32

Index

Installation

Study these installation instructions carefully before proceeding. **Failure to observe the warnings and instructions may cause a malfunction or personal hazard.**



WARNING! Before you begin read "Safety" on page 1.



WARNING! When the ACS550 with Bypass is connected to the line power, the Motor Terminals T1, T2, and T3 are live even if the motor is not running. Do not make any connections when the ACS550 with Bypass is connected to the line. Disconnect and lock out power to the drive before servicing the drive. Failure to disconnect power may cause serious injury or death.

Application

This manual is a supplement to the ACS550-01/U1 User's Manual and documents Bypass configurations.

Bypass Features and Functions

The ACS550 with Bypass is an ACS550 AC adjustable frequency drive in an integrated UL Type/NEMA 1, UL Type/NEMA 12, or UL Type/NEMA 3R package with a bypass function configured entirely of standard industrial control components. The ACS550 with Bypass provides:

- Main circuit breaker with door mounted control lever. The lever can be padlocked in the OFF position (padlock not supplied).
- Electrically interlocked Bypass and drive output contactors
- Class 20 motor overload protection.
- ACS-CP-A drive control panel
 - Cover mounted - UL Type/NEMA 1 and 12 enclosures
 - Drive mounted - UL Type/NEMA 3R enclosures
- Bypass cover mounted control
 - Drive-Off-Bypass selector switch
- Provisions for external control connections.
- Optional drive service switch (drive input disconnect), the functional equivalent of a three-contactor bypass arrangement.

The following shows the front view of a typical ACS550 Bypass wall mount configuration, and identifies the major components.

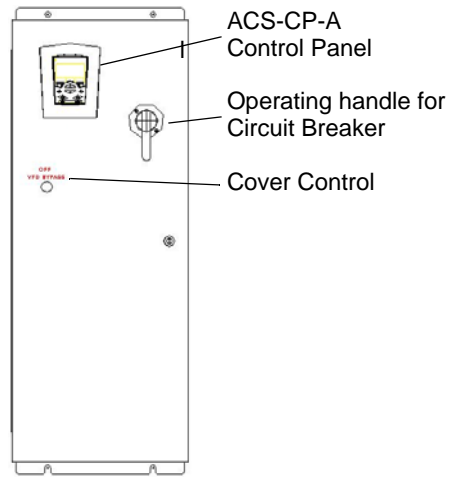

The following shows the front view of a typical ACS550 Bypass floor mount configuration, and identifies the major components.

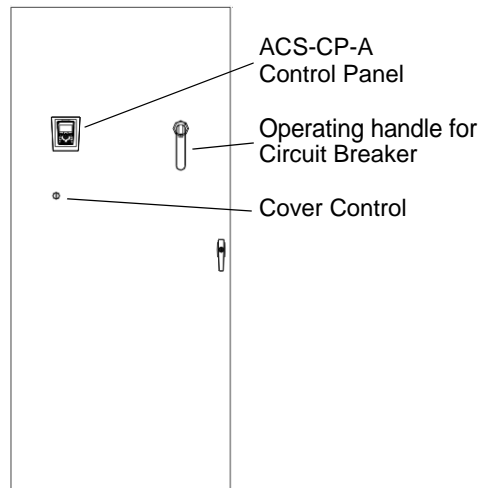

The following is a typical power diagram.

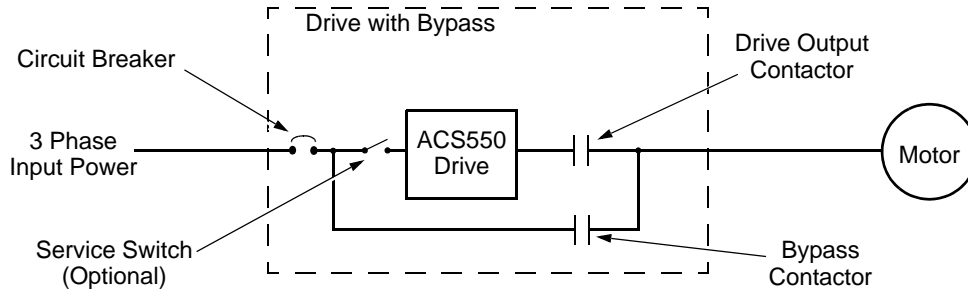

Installation Flow Chart

The installation of Bypass Configurations for ACS550 drives follows the outline below. The steps must be carried out in the order shown. At the right of each step are references to the detailed information needed for the correct installation of the unit.

Task	Reference in ACS550-01/U1 User's Manual "Installation" section	Reference in this Manual
PREPARE for installation	"Preparing for Installation"	Floor Mounted: "Lifting the Drive" on Page 7 "Drive Identification" on Page 8 "Suitable Mounting Location" on page 8
PREPARE the Mounting Location	"Prepare the Mounting Location"	Prepare the Mounting Location - Floor Mounted Enclosures" on page 9 "Dimensions and weights" on page 27
REMOVE the front cover	"Remove Front Cover"	--
MOUNT the drive	"Mount the Drive"	--
INSTALL wiring	"Wiring Overview" and "Install the Wiring"	Installing the Wiring starting on page 10
CHECK installation	"Check Installation"	--
RE-INSTALL the cover	"Re-install Cover"	--
APPLY power	"Apply Power"	--
START-UP	"Start-Up"	--

Preparing for Installation

Lifting the Drive

Floor Mounting



Warning! Handle and ship floor mounted enclosures only in the upright position. These units are not designed to be laid on their backs.

1. Use a pallet truck to move the package/enclosure to the installation site.
2. Remove any bolts that secure the cabinet to the shipping pallet.



PC00005



Warning! Use the lifting lugs/bars at the top of the unit to lift floor mounted drives.

3. Use a hoist to lift the drive. (Do not place drive in final position until mounting site is prepared.)



PC00003

Preparing for Installation

Drive Identification

To identify the type of device you are installing, refer to the type code number on the device identification label.

- Wall mounting base drives – label attached on the side surface of the heat sink.
- Packaged drive with screw cover – label attached to outside surface on the left side of the enclosure.
- Enclosure with hinged cover/door – label on inside surface of the cover/door.

Type Code Number

Use the following to interpret the type code found on the identification label.

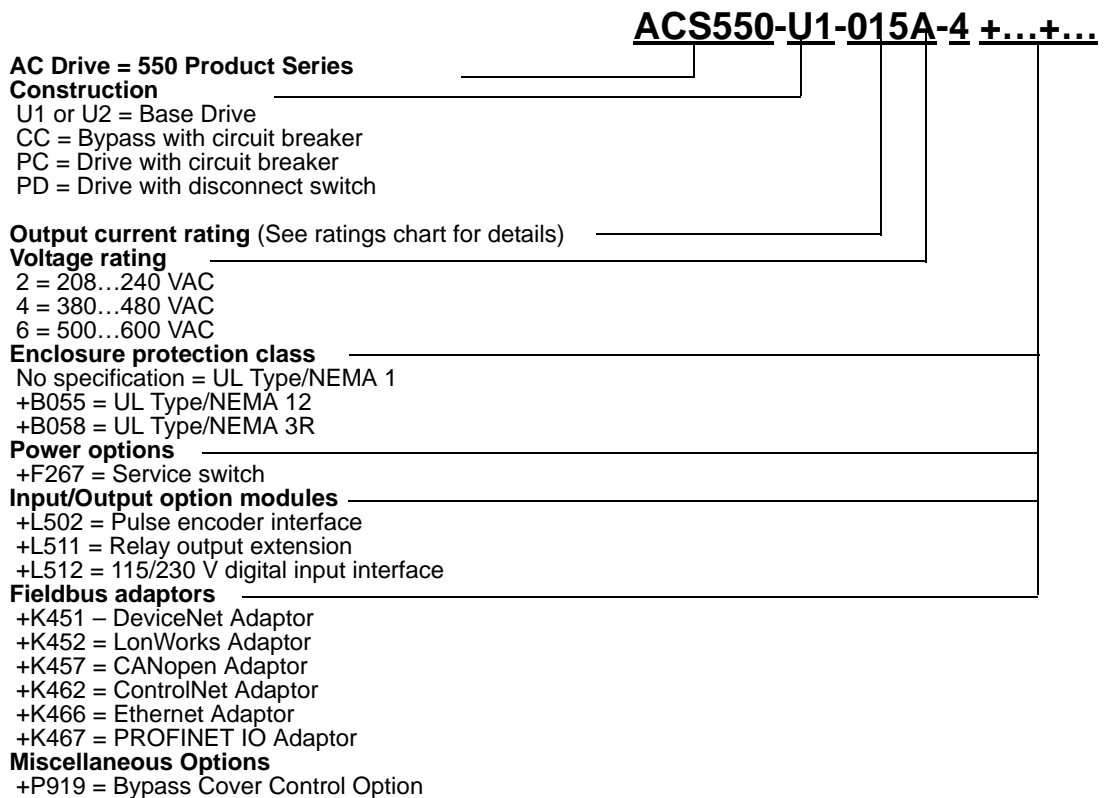

Suitable Mounting Location (Supplement to ACS550-01/U1 User's Manual)

For selecting a suitable mounting location for Drive with Bypass units, refer to:

- Preparing for installation in the ACS550-01/U1 User's Manual, and
- The Technical Data section of this manual for information on dimensions and weights

Installing the Drive



Warning! Metal shavings or debris in the enclosure can damage electrical equipment and create a hazardous condition. Where parts, such as conduit plates require cutting or drilling, first remove the part. If that is not practical, cover nearby electrical components to protect them from all shavings or debris.

Prepare the Mounting Location – Floor Mounted Enclosures

The ACS550 should only be mounted where all of the requirements defined in “Preparing for Installation” are met.

Installing the Wiring



WARNING!

- **Metal shavings or debris in the enclosure can damage electrical equipment and create a hazardous condition. Where parts, such as conduit plates require cutting or drilling, first remove the part. If that is not practical, cover nearby electrical components to protect them from all shavings or debris.**
 - **Do not connect or disconnect input or output power wiring, or control wires, when power is applied.**
 - **Never connect line voltage to drive output Terminals T1, T2, and T3.**
 - **Do not make any voltage tolerance tests (Hi Pot or Megger) on any part of the unit. Disconnect motor wires before taking any measurements in the motor or motor wires.**
 - **Make sure that power factor correction capacitors are not connected between the drive and the motor.**
-

Wiring Requirements

Refer to the “Wiring Requirements” Section in the ACS550-01/U1 User’s Manual. The requirements apply to all ACS550 drives. In particular:

- Use separate, metal conduit runs for the following different classes of wiring:
 - Input power wiring.
 - Motor wiring.
 - Control/communications wiring.
- Properly and individually ground the drive, the motor and cable shields.

Wiring Overview

Connection Diagrams –

ACS550-CC units are configured for wiring access from the top or the bottom. The following figures show the wiring connection points. Refer to the ACS550-01/U1 User's Manual for control connections to the drive.

Typical Wall Mount

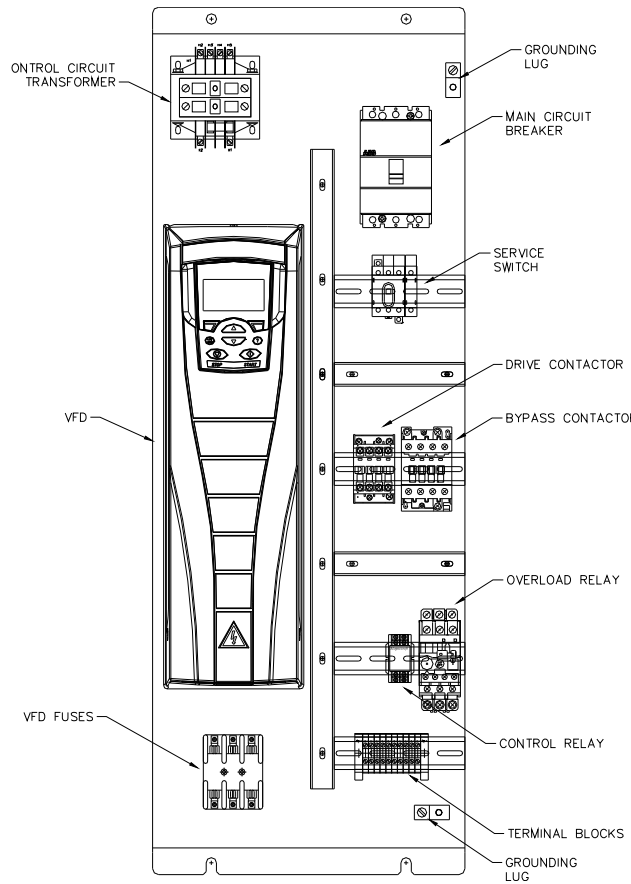

Typical Floor Mount

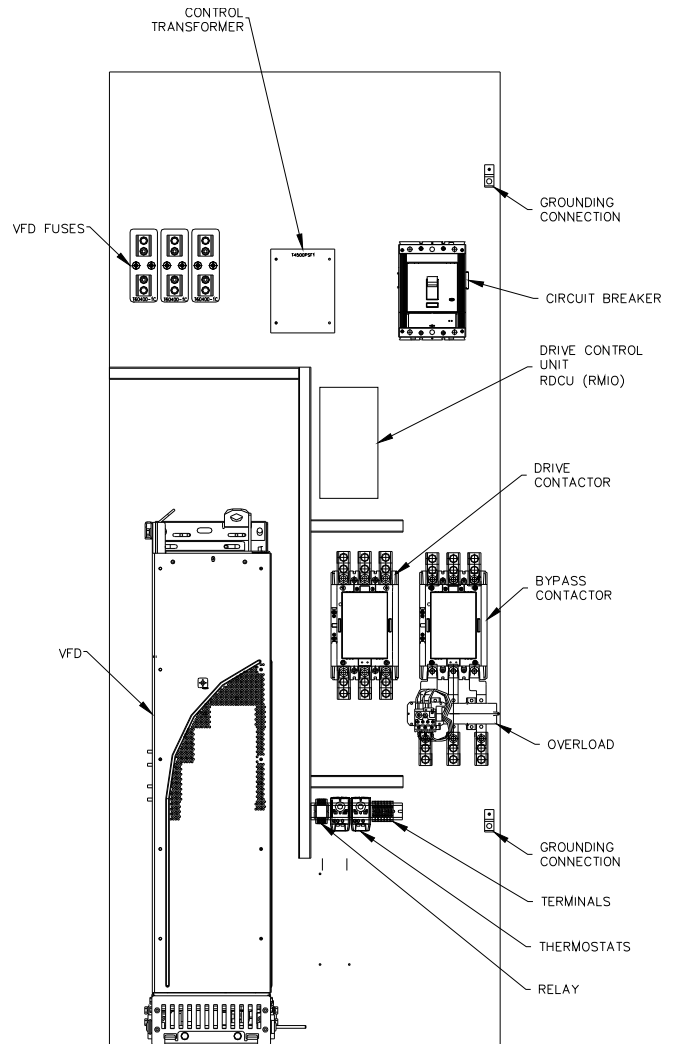

Install the Line Input Wiring

Line Input Connections – Bypass Configurations

Connect input power to the terminals of the circuit breaker. Connect the equipment grounding conductor to the ground lug at the top of the enclosure. The figures below show the connection points for typical configurations. Units are configured for wiring access from the top or the bottom.

Typical Wall mount

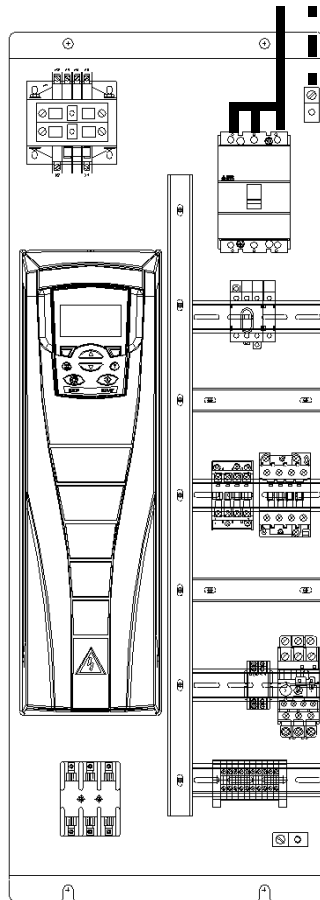

Typical Floor mount

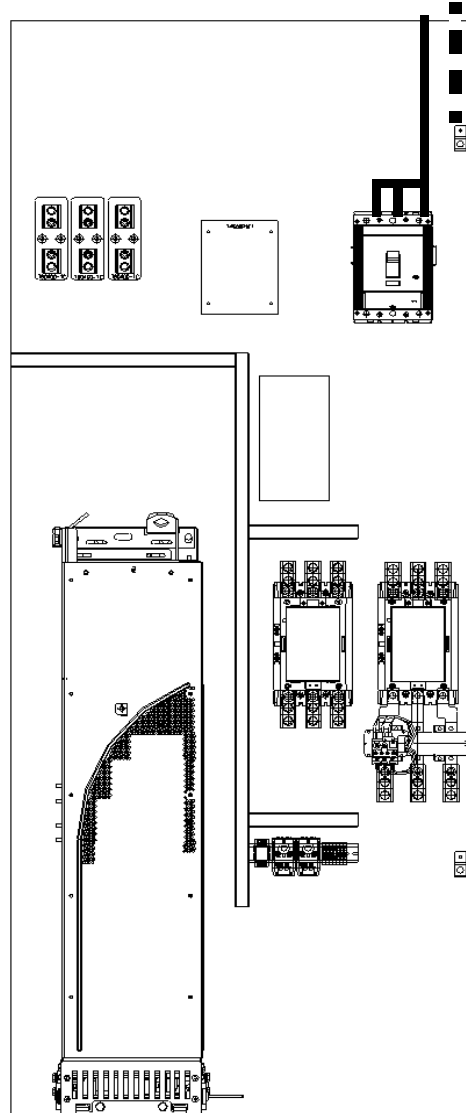

WARNING! Check the motor and motor wiring insulation before connecting the ACS550 to line power. Follow the procedure in the ACS550-01/U1 User's Manual. Before proceeding with the insulation resistance measurements, check that the ACS550 is disconnected from incoming line power. Failure to disconnect line power could result in death or serious injury.

Install the Motor Wiring

Motor Connections – Bypass Configurations

Connect the motor cables to the motor overload relay output terminals; see the figures below. The motor grounding conductor can be connected to the ground lug near the motor overload relay.

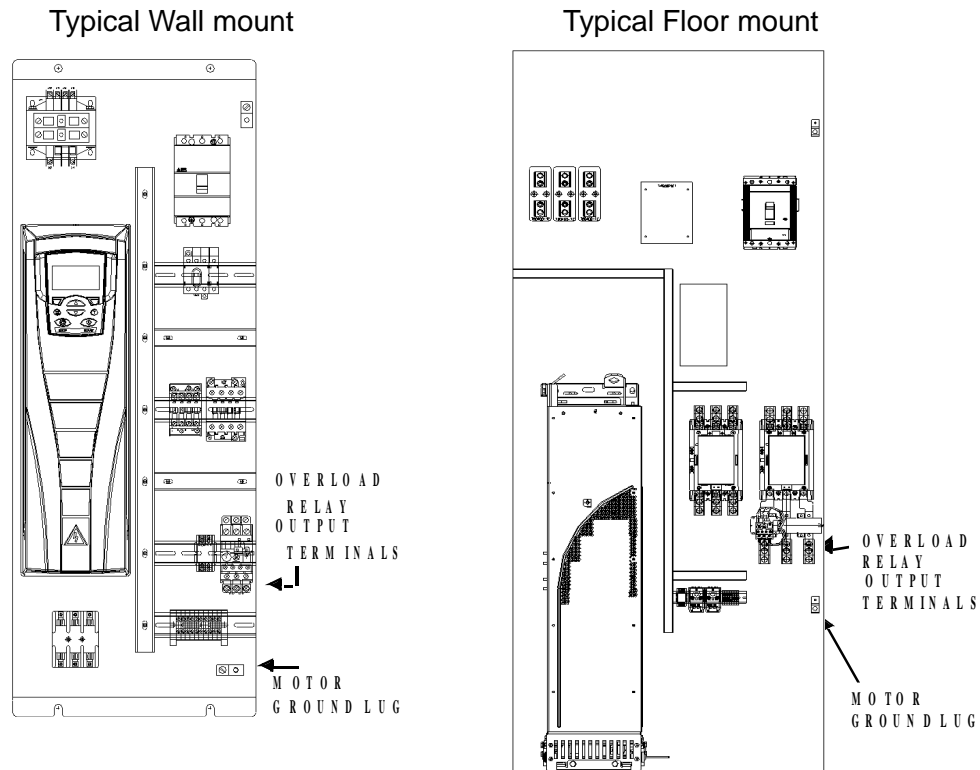

Install the Control Wiring (Supplement to ACS550-01/U1 User's Manual)

Connect control wiring to the terminal block 1TB located on the back panel toward the bottom of the enclosure and terminal block x1 inside the drive.

Control Wiring

The control wiring includes connections to an analog speed command signal and start/stop relay contact for controlling the drive in the AUTO mode. There may also be connections to external run enable interlock contacts and a connection from the Motor Run contact to an external status indicating circuit.

Wiring Practices

The external control wiring must not be run in the same conduit or raceway with any high power wiring. The external speed reference signal must be wired using a shielded, twisted pair cable. The shield connection must be terminated at the ground terminal provided (x1:3). The other end of the shield should be cut and taped back at the signal source.

Terminal Block 1TB

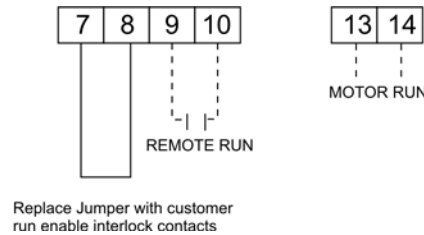

Connection Points

Basic control connections are made to 1TB, which is a din-rail terminal block on the back panel at the bottom of the enclosure. 1TB includes screw clamp terminals rated for #22-10 AWG stranded or solid wire. Recommended tightening torque is 4.4 - 7.1 in-lbs.

Terminals 1TB:7 and 1TB:8 are 120 VAC control circuit terminals connected to 120 VAC control power supplied by the control circuit transformer provided. Terminals 1TB:9 and 1TB:10 are powered at 24VDC to accept an external contact closure to start the drive. Terminals 1TB:13 and 1TB:14 are connected to un-powered relay contacts provided for use with externally powered customer control circuits.

Additional Connections

The low voltage speed reference signal input, analog outputs, additional relay outputs, and additional digital input connections are available on Terminal Block X1 inside the ACS550. Note that the Bypass control circuitry uses inputs and outputs DI1, DI4 and RO2. These inputs are not available for any other purpose and must not be reconfigured. Output RO2 is wired to the terminal block, 1TB. AI1, AI2, DI3, DI5, DI6, RO1, and RO3 are available for use. Refer to the *ACS550-01/U1 User's Manual* for information about control connections on Terminal Block X1. When making connections to Terminal Block X1, be careful not to disturb the factory installed wiring between X1 and the Bypass control circuitry.

Analog Input

The external "Auto" speed reference is to be connected to ACS550 analog input AI1. The analog input can accept a voltage signal (0 – 10 VDC) or a current signal (0 – 20 mA). Jumper J1, located on the Control Board in the ACS550, determines the signal type. J1 can be set in either the voltage or current position according to the type of external signal that will be connected. *Refer to the ACS550-01/U1 User's Manual.*

Run Enable Interlocks

Run Enable interlocks are normally closed un-powered contacts connected in series between 1TB:7 and 1TB:8. When any of these contacts opens, the motor will stop, whether in DRIVE or BYPASS. The unit is shipped with a jumper installed from 1TB:7 to 1TB:8. This jumper must be removed before connecting external contacts.

Auto Start Contact

To start the ACS550 by means of an external un-powered contact (maintained), connect the contact to 1TB:9 and 1TB:10. Closing this contact will start the motor when the drive is in the AUTO mode.

Relay Contact Output

A “Motor Running” relay contact output is provided at terminals 1TB:13 and 1TB:14 for external indication of the motor status. The output consists of a normally open auxiliary contact on the bypass contactor and a normally open “Drive Running” contact from the ACS550. The two contacts are connected in parallel so that a contact closure is provided whenever the motor is running.

Refer to “Control Connections” in the *ACS550-01/U1 User’s Manual* Technical Data where relay contacts are used to control inductive loads.

Motor Overload Relay

The ACS550 with Bypass includes a motor overload relay to provide thermal motor protection. It is connected in both drive and bypass modes of operation. For motor full load currents up to 80 amperes, the Motor Overload Relay is an adjustable trip, bimetallic overload relay with a class 20 trip characteristic. Above 80 amperes, the Motor Overload Relay is an adjustable trip, electronic overload relay with selectable class 10, 20 or 30 trip characteristic.

Suggested Settings

Current

Set the current adjustment to the value of the full load current shown on the motor nameplate.

Auto/Man

It is recommended the overload relay be set to the Manual Reset mode of operation. In the Auto Reset mode, the Overload Relay contacts re-close automatically when the bi-metals of bi-metallic versions cool or when the timer function within the electronic versions times out. If power is applied and the switches and contacts in the control circuit are commanding the motor to run, the motor will start as soon as the overload relay resets.

Class

The class 20 setting on the electronic overload relays would be the appropriate choice for the majority of the motors used in North America.

Resetting the Overload Relay

In the event an overload relay set in the Manual Reset mode trips, it is necessary to open the door of the enclosure and push the Reset button on the front of the overload relay to reset it.



WARNING: If power is applied and the switches and contacts in the control circuit are commanding the motor to run, the motor will start as soon as the overload relay resets. Use caution when manually resetting the overload relay to make sure it is safe to start the motor.

Maintenance

Maintenance Interval

If installed in an appropriate environment, the drive requires very little maintenance. The table lists the routine maintenance intervals recommended by ABB. The information shown below is supplemental and in addition to that shown in the ACS550-01/U1 User's Manual.

Maintenance	Application	Interval
Check/replace enclosure inlet air filter	UL Type/NEMA 12 and 3R enclosures	Check every 3 months. Replace as needed
Check/replace enclosure exhaust air filter	UL Type/NEMA 12 and 3R enclosures	Check every 6 months. Replace as needed.
Replace enclosure vent fan(s).	UL Type/NEMA 12 and 3R enclosures	Every three years
Replace enclosure air circulation fan	Frames R4 through R6 in UL Type/NEMA 1 enclosures	Every three years

Technical Data

Ratings

Note! The ratings listed below are additions to the ratings listed in the ACS550-01/U1 User's Manual.

Ratings, 380...480 Volt Drives

Type Code	Valid up to 40°C (104 °F)				Frame Size
	Normal Use		Heavy-Duty Use		
	I_{2N} A	P_N HP	I_{2hd} A	P_{hd} HP	
-245A-4	245	200	192	150	R7
-316A-4	316	250	240	200	R8
-368A-4	368	300	302	250	R8
-414A-4	414	350	368	300	R8
-486A-4	486	400	414	350	R8

Input Power Connections

Branch Circuit Protection

Input power is connected to the ACS550 with Bypass through a circuit breaker that provides the branch circuit short circuit and ground fault protection for the motor operating in the bypass mode.

Fuses

Drive input fuses are provided to disconnect the drive from power in the event that a component fails in the drive's input power circuitry. The drive's electronic protection circuitry is designed to clear drive output short circuits and ground faults without blowing the drive input fuses. Drive input fuses are shown in the following tables.

NOTE! Although fuses listed are similar in functional characteristics to fuses listed in the ACS550-01/U1 User's Manual, physical characteristics may differ. Fuses from other manufacturers can be used if they meet the functional characteristics of those shown in the tables.

208...240 Volt Fuses

208... 240 Volt		Frame Size	Drive Input Fuse Ratings	
HP	Identification		Amps (600V)	Bussmann Type
1	ACS550-CC-04A6-2	R1	15	KTK-R-15
1.5	ACS550-CC-06A6-2	R1	15	KTK-R-15
2	ACS550-CC-07A5-2	R1	15	KTK-R-15
3	ACS550-CC-012A-2	R1	15	KTK-R-15
5	ACS550-CC-017A-2	R1	30	KTK-R-30
7.5	ACS550-CC-024A-2	R2	30	KTK-R-30
10	ACS550-CC-031A-2	R2	50	JJS-50
15	ACS550-CC-046A-2	R3	80	JJS-80
20	ACS550-CC-059A-2	R3	80	JJS-80
25	ACS550-CC-075A-2	R4	100	JJS-100
30	ACS550-CC-088A-2	R4	110	JJS-110
40	ACS550-CC-114A-2	R4	150	JJS-150
50	ACS550-CC-143A-2	R6	200	JJS-200
60	ACS550-CC-178A-2	R6	250	JJS-250
75	ACS550-CC-221A-2	R6	300	JJS-300
100	ACS550-CC-248A-2	R6	350	JJS-350

380...480 Volt Fuses

380... 480 Volt		Frame Size	Drive Input Fuse Ratings	
HP	Identification		Amps (600V)	Bussmann Type
1/1.5	ACS550-CC-03A3-4	R1	15	KTK-R-15
2	ACS550-CC-04A1-4	R1	15	KTK-R-15
3	ACS550-CC-06A9-4	R1	15	KTK-R-15
5	ACS550-CC-08A8-4	R1	15	KTK-R-15
7.5	ACS550-CC-012A-4	R1	15	KTK-R-15
10	ACS550-CC-015A-4	R2	30	KTK-R-30
15	ACS550-CC-023A-4	R2	30	KTK-R-30
20	ACS550-CC-031A-4	R3	50	JJS-50
25	ACS550-CC-038A-4	R3	50	JJS-50
30	ACS550-CC-045A-4	R3	100	JJS-100
30	ACS550-CC-044A-4	R4	100	JJS-100
40	ACS550-CC-059A-4	R4	100	JJS-100
50	ACS550-CC-072A-4	R4	100	JJS-100
60	ACS550-CC-078A-4	R4	100	JJS-100
75	ACS550-CC-097A-4	R4	125	JJS-125
75	ACS550-CC-096A-4	R5	125	JJS-125
100	ACS550-CC-125A-4	R5	175	JJS-175
100	ACS550-CC-124A-4	R6	175	JJS-175
125	ACS550-CC-157A-4	R6	200	JJS-200
150	ACS550-CC-180A-4	R6	250	JJS-250
200	ACS550-CC-246A-4	R6	400	JJS-400
200	ACS550-CC-245A-4	R7	400	JJS-400
250	ACS550-CC-316A-4	R8	400	JJS-400
300	ACS550-CC-368A-4	R8	400	JJS-400
350	ACS550-CC-414A-4	R8	600	JJS-600
400	ACS550-CC-486A-4	R8	600	JJS-600

Fuses, 500...600 Volt, Fuses

500...600 Volt		Frame Size	Drive Input Fuse Ratings	
HP	Identification		Amps (600V)	Bussmann Type
2	ACS550-CC-02A7-6	R2	15	KTK-R-15
3	ACS550-CC-03A9-6	R2	15	KTK-R-15
5	ACS550-CC-06A1-6	R2	15	KTK-R-15
7.5	ACS550-CC-09A0-6	R2	15	KTK-R-15
10	ACS550-CC-011A-6	R2	30	KTK-R-30
15	ACS550-CC-017A-6	R2	30	KTK-R-30
20	ACS550-CC-022A-6	R3	50	JJS-50
25	ACS550-CC-027A-6	R3	50	JJS-50
30	ACS550-CC-032A-6	R4	100	JJS-100
40	ACS550-CC-041A-6	R4	100	JJS-100
50	ACS550-CC-052A-6	R4	100	JJS-100
60	ACS550-CC-062A-6	R4	100	JJS-100
75	ACS550-CC-077A-6	R6	100	JJS-100
100	ACS550-CC-099A-6	R6	150	JJS-150
125	ACS550-CC-125A-6	R6	175	JJS-175
150	ACS550-CC-144A-6	R6	200	JJS-200

Power Connection Terminals

The following tables show maximum wire size and required tightening torque for incoming power and motor terminals, and grounding terminal lug information.

208...240 Volt, Terminals

208...240 Volt, Power Connection Terminal Data					
208...240 Volt		Base Drive Frame Size	Power Wiring Size		
HP	Type Code		Circuit Breaker	Overload Relay	Ground Lugs
1	ACS550-CC-04A6-2	R1	#10 35 in-lbs	#10 13 in-lbs	#2 15 in-lbs (#14 - #12) 40 in-lbs (#10 - #6) 50 in-lbs (#4 - #2)
1.5	ACS550-CC-06A6-2	R1			
2	ACS550-CC-07A5-2	R1			
3	ACS550-CC-012A-2	R1			
5	ACS550-CC-017A-2	R1			
7.5	ACS550-CC-024A-2	R2	#6 45 in-lbs	#8 21 in-lbs	
10	ACS550-CC-031A-2	R2			
15	ACS550-CC-046A-2	R3	#3 50 in-lbs	#3 36 in-lbs	
20	ACS550-CC-059A-2	R3			
25	ACS550-CC-075A-2	R4	#1 50 in-lbs	#2 36 in-lbs	
30	ACS550-CC-088A-2	R4			
40	ACS550-CC-114A-2	R4	#2/0 274 in-lbs	#2/0 300 in-lbs	
50	ACS550-CC-143A-2	R6			
60	ACS550-CC-178A-2	R6	300 MCM 274 in-lbs	250 MCM 300 in-lbs	#2/0 275 in-lbs (#6 - #2) 375 in-lbs (#1 - #2/0)
75	ACS550-CC-221A-2	R6			
100	ACS550-CC-248A-2	R6	2 x 250 MCM 275 in-lbs	2 x 250 MCM 375 in-lbs	350 MCM 100 in-lbs

380...480 Volt, Terminals

380...480 Volt, Power Connection Terminal Data					
380...480 Volt		Base Drive Frame Size	Power Wiring Size		
HP	Type Code		Circuit Breaker	Overload Relay	Ground Lugs
1/1.5	ACS550-CC-03A3-4	R1	#10 35 in-lbs	#10 13 in-lbs	#2 15 in-lbs (#14 - #12) 40 in-lbs (#10 - #6) 50 in-lbs (#4 - #2)
2	ACS550-CC-04A1-4	R1			
3	ACS550-CC-06A9-4	R1			
5	ACS550-CC-08A8-4	R1			
7.5	ACS550-CC-012A-4	R1			
10	ACS550-CC-015A-4	R2	#6 45 in-lbs		
15	ACS550-CC-023A-4	R2			
20	ACS550-CC-031A-4	R3	#3 50 in-lbs	#8 21 in-lbs	
25	ACS550-CC-038A-4	R3		#3 36 in-lbs	
30	ACS550-CC-045A-4	R3			
30	ACS550-CC-044A-4	R4			
40	ACS550-CC-059A-4	R4	#1 50 in-lbs	#2 36 in-lbs	
50	ACS550-CC-072A-4	R4			
60	ACS550-CC-078A-4	R4			
75	ACS550-CC-097A-4	R4			
75	ACS550-CC-096A-4	R5			
100	ACS550-CC-125A-4	R5			
100	ACS550-CC-124A-4	R6	300 MCM 274 in-lbs	250 MCM 300 in-lbs	
125	ACS550-CC-157A-4	R6			
150	ACS550-CC-180A-4	R6			
200	ACS550-CC-246A-4	R6	2 x 250 MCM 275 in-lbs	2 x 250 MCM 375 in-lbs	350MCM 100 in-lbs
200	ACS550-CC-245A-4	R7			
250	ACS550-CC-316A-4	R8			
300	ACS550-CC-368A-4	R8	2 x 500 MCM 275 in-lbs	2 x 500MCM 375 in-lbs	
350	ACS550-CC-414A-4	R8			
400	ACS550-CC-486A-4	R8			

500...600 Volt, Terminals

500...600 Volt, Power Connection Terminal Data					
500...600 Volt		Base Drive Frame Size	Power Wiring Size		
HP	Type Code		Circuit Breaker	Overload Relay	Ground Lugs
2	ACS550-CC-02A7-6	R2	#6 62 in-lbs	#10 13 in-lbs	#2 15 in-lbs (#14 - #12) 40 in-lbs (#10 - #6) 50 in-lbs (#4 - #2)
3	ACS550-CC-03A9-6	R2			
5	ACS550-CC-06A1-6	R2			
7.5	ACS550-CC-09A0-6	R2			
10	ACS550-CC-011A-6	R2			
15	ACS550-CC-017A-6	R2			
20	ACS550-CC-022A-6	R3	#3 62 in-lbs	#8 21 in-lbs	
25	ACS550-CC-027A-6	R3			
30	ACS550-CC-032A-6	R4	#1 62 in-lbs	#2 36 in-lbs	
40	ACS550-CC-041A-6	R4			
50	ACS550-CC-052A-6	R4			
60	ACS550-CC-062A-6	R4			
75	ACS550-CC-077A-6	R6	300 MCM 200 in-lbs	250 MCM 300 in-lbs	#2/0 275 in-lbs (#6 - #2) 375 in-lbs (#1 - #2/0)
100	ACS550-CC-099A-6	R6			
125	ACS550-CC-125A-6	R6			
150	ACS550-CC-144A-6	R6			

Motor Connections

Motor Terminals

See preceding “Power Connection Terminal Data” tables.

Bypass Contactors

The bypass circuit in the ACS550 Bypass includes two contactors. One contactor is the bypass contactor (2M) that can be used to connect the motor directly to the incoming power line in the event that the ACS550 is out of service. The other contactor is the ACS550 output contactor (1M) that disconnects the ACS550 from the motor when the motor is operating in the Bypass mode. The drive output contactor and the bypass contactor are electrically interlocked to prevent “back feeding,” applying line voltage to the ACS550 output terminals.

Motor Overload Protection

The ACS550 with Bypass includes a motor overload relay to provide thermal motor protection. It is connected in both drive and bypass modes of operation. For motor full load currents through 80 amperes, the Motor Overload Relay is an adjustable trip, bimetallic overload relay with a class 20 trip characteristic. Above 80 amperes, the Motor Overload Relay is an adjustable trip, electronic overload relay with selectable class 10, 20 or 30 trip characteristic. The class 20 setting on the electronic overload relays is the appropriate choice for the majority of the motors used in North America.



WARNING: If power is applied and the switches and contacts in the control circuit are commanding the motor to run, the motor will start as soon as the overload relay is reset.

Use caution when resetting the overload relay to make sure it is safe to start the motor.

Motor Connection Specifications – R7/R8

Motor Connection Specifications			
Maximum Motor Cable Length	Frame Size	Max. Motor Cable Length*	
		$f_{sw} = 1 \text{ or } 4 \text{ kHz}$	$f_{sw} = 8 \text{ kHz or } 12 \text{ kHz}$
	R7...R8	300 m	980 ft



* Warning! Using a motor cable longer than specified in the chart above may cause permanent damage to the drive.

Cooling – R7/R8

Cooling Specifications	
Method	Internal fan, flow direction from bottom to top.
Requirement	Allow 4 to 6 inches at the sides of enclosure for venting.

Air Flow, 380...480 Volt Drives – R7/R8

The following table lists heat loss and air flow data for 380...480 Volt drives.

Drive		Heat Loss		Air Flow	
ACS550-xx-	Frame Size	W	BTU/Hr	m ³ /h	ft ³ /min
-245A-4	R7	3850	13000	300	540
-316A-4	R8	5300	18000	700	1220
-368A-4	R8	6850	23000	700	1220
-414A-4	R8	7000	24000	700	1220
-486A-4	R8	7600	26000	700	1220

Dimensions and Weights

Dimensional References

The following tables contain dimensional references that will be needed to identify the dimensional information applying to a given device type code.

208/230V Bypass Packages

HP	Type Code	Amp	Frame	UL Type (NEMA) 1 Dim. Ref. Page 29	UL Type (NEMA) 12 Dim. Ref. Page 30	UL Type (NEMA) 3R Dim. Ref. Page 31
1	ACS550-CC-04A6-2	4.6	R1	CX1-1	CX12-1	CX3R-1
1.5	ACS550-CC-06A6-2	6.6	R1	CX1-1	CX12-1	CX3R-1
2	ACS550-CC-07A5-2	7.5	R1	CX1-1	CX12-1	CX3R-1
3	ACS550-CC-012A-2	12	R1	CX1-1	CX12-1	CX3R-1
5	ACS550-CC-017A-2	17	R1	CX1-1	CX12-1	CX3R-1
7.5	ACS550-CC-024A-2	24	R2	CX1-3	CX12-3	CX3R-3
10	ACS550-CC-031A-2	31	R2	CX1-3	Cx12-3	CX3R-3
15	ACS550-CC-046A-2	46	R3	CX1-4	CX12-5	CX3R-5
20	ACS550-CC-059A-2	59	R3	CX1-4	CX12-5	CX3R-5
25	ACS550-CC-075A-2	75	R4	CX1-6	CX12-6	CX3R-6
30	ACS550-CC-088A-2	88	R4	CX1-9	CX12-7	CX3R-7
40	ACS550-CC-114A-2	114	R4	CX1-9	CX12-7	CX3R-7
50	ACS550-CC-143A-2	143	R6	CX1-10	CX12-10	CX3R-10
60	ACS550-CC-178A-2	178	R6	CX1-10	CX12-10	CX3R-10
75	ACS550-CC-221A-2	221	R6	CX1-11	CX12-10	CX3R-10
100	ACS550-CC-248A-2	248	R6	CX1-11	CX12-10	CX3R-10

480V Bypass Packages

HP	Type Coxe	Amp	Frame	UL Type (NEMA) 1 Dim. Ref. Page 29	UL Type (NEMA) 12 Dim. Ref. Page 30	UL Type (NEMA) 3R Dim. Ref. Page 31
1	ACS550-CC-03A3-4	3.3	R1	CX1-1	CX12-1	CX3R-1
1.5	ACS550-CC-03A3-4	3.3	R1	CX1-1	CX12-1	CX3R-1
2	ACS550-CC-04A1-4	4.1	R1	CX1-1	CX12-1	CX3R-1
3	ACS550-CC-06A9-4	6.9	R1	CX1-1	CX12-1	CX3R-1
5	ACS550-CC-08A8-4	8.8	R1	CX1-1	CX12-1	CX3R-1
7.5	ACS550-CC-012A-4	12	R1	CX1-1	CX12-1	CX3R-1
10	ACS550-CC-015A-4	15	R2	CX1-2	CX12-2	CX3R-2
15	ACS550-CC-023A-4	23	R2	CX1-2	CX12-2	CX3R-2
20	ACS550-CC-031A-4	31	R3	CX1-4	CX12-4	CX3R-4
25	ACS550-CC-038A-4	38	R3	CX1-4	CX12-4	CX3R-4
30	ACS550-CC-045A-4	44	R3	CX1-4	CX12-5	CX3R-5
40	ACS550-CC-059A-4	59	R4	CX1-5	CX12-6	CX3R-6
50	ACS550-CC-072A-4	72	R4	CX1-5	CX12-6	CX3R-6
60	ACS550-CC-078A-4	78	R4	CX1-5	CX12-6	CX3R-6
75	ACS550-CC-097A-4	96	R4	CX1-6	CX12-7	CX3R-7
100	ACS550-CC-125A-4	124	R5	CX1-7	CX12-8	CX3R-8
125	ACS550-CC-157A-4	157	R6	CX1-10	CX12-9	CX3R-9
150	ACS550-CC-180A-4	180	R6	CX1-10	CX12-9	CX3R-9
200	ACS550-CC-246A-4	245	R6	CX1-11	CX12-10	CX3R-10
250	ACS550-CC-316A-4	316	R8	CX1-12	CX12-11	Consult Factory
300	ACS550-CC-368A-4	368	R8	CX1-13	CX12-12	
350	ACS550-CC-414A-4	414	R8	CX1-13	CX12-12	
400	ACS550-CC-486A-4	486	R8	CX1-13	CX12-12	

600V Bypass Packages

HP	Type Code	Amp	Frame	UL Type (NEMA) 1 Dim. Ref. Page 29	UL Type (NEMA) 12 Dim. Ref. Page 30	UL Type (NEMA) 3R Dim. Ref. Page 31
2	ACS550-CC-02A7-6	2.7	R2	CX1-2	CX12-2	CX3R-2
3	ACS550-CC-03A9-6	3.9	R2	CX1-2	CX12-2	CX3R-2
5	ACS550-CC-06A1-6	6.1	R2	CX1-2	CX12-2	CX3R-2
7.5	ACS550-CC-09A0-6	9	R2	CX1-2	CX12-2	CX3R-2
10	ACS550-CC-011A-6	11	R2	CX1-2	CX12-2	CX3R-2
15	ACS550-CC-017A-6	17	R2	CX1-2	CX12-2	CX3R-2
20	ACS550-CC-022A-6	22	R3	CX1-4	CX12-4	CX3R-4
25	ACS550-CC-027A-6	27	R3	CX1-4	CX12-4	CX3R-4
30	ACS550-CC-032A-6	32	R4	CX1-5	CX12-6	CX3R-6
40	ACS550-CC-041A-6	41	R4	CX1-5	CX12-6	CX3R-6
50	ACS550-CC-052A-6	52	R4	CX1-5	CX12-6	CX3R-6
60	ACS550-CC-062A-6	62	R4	CX1-5	CX12-6	CX3R-6
75	ACS550-CC-077A-6	77	R6	CX1-8	CX12-9	CX3R-9
100	ACS550-CC-099A-6	99	R6	CX1-8	CX12-9	CX3R-9
125	ACS550-CC-125A-6	125	R6	CX1-10	CX12-9	CX3R-9
150	ACS550-CC-144A-6	144	R6	CX1-10	CX12-9	CX3R-9

Dimensions: ACS550-CC NEMA 1 R1 through R8 Frame Size

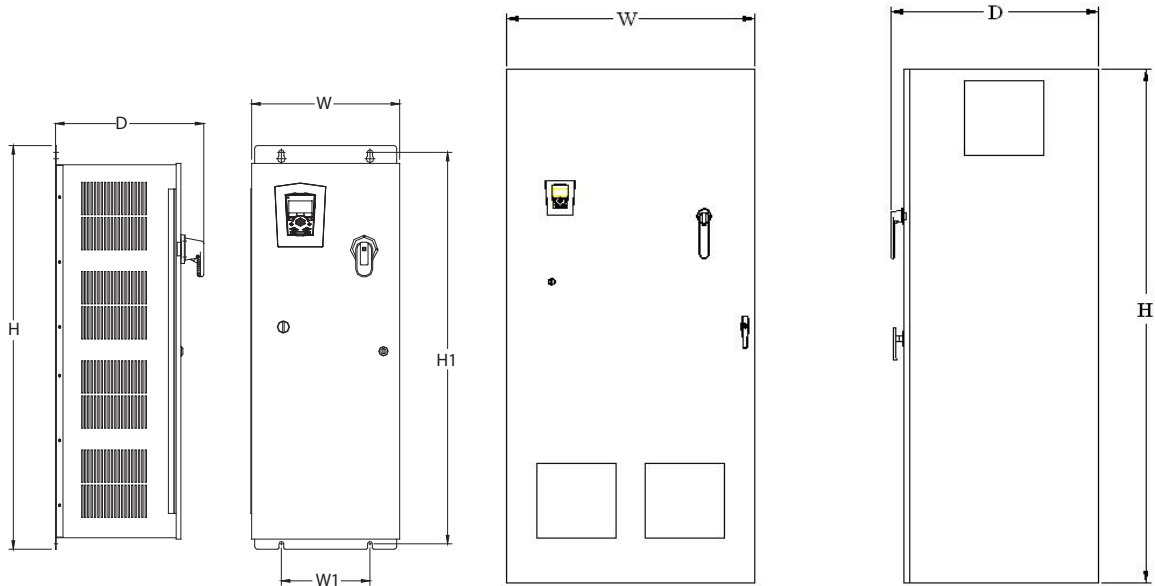

CX1-1 to CX1-11 Wall Mounted

CX1-12 to CX1-13 Free Standing

	H1	W1	Height (H)	Width (W)	Depth (D)	Weight
CX1-1	920 [36.2]	208 [8.2]	948 [37.3]	348 [13.7]	349 [13.7]	35 [76]
CX1-2	920 [36.2]	208 [8.2]	948 [37.3]	348 [13.7]	349 [13.7]	37 [82]
CX1-3	1352 [53.2]	254 [10]	1380 [54.3]	414 [16.3]	371 [14.6]	49 [107]
CX1-4	1352 [53.2]	254 [10]	1380 [54.3]	414 [16.3]	371 [14.6]	61 [135]
CX1-5	1352 [53.2]	254 [10]	1380 [54.3]	414 [16.3]	371 [14.6]	76 [168]
CX1-6	1568 [61.7]	330 [13]	1596 [62.8]	491 [19.3]	489 [19.2]	90 [198]
CX1-7	1568 [61.7]	330 [13]	1596 [62.8]	491 [19.3]	489 [19.2]	119 [262]
CX1-8	1568 [61.7]	330 [13]	1596 [62.8]	491 [19.3]	489 [19.2]	154 [339]
CX1-9	Free Standing	Free Standing	1883 [74.1]	889 [35]	527 [20.7]	126 [277]
CX1-10	Free Standing	Free Standing	1883 [74.1]	889 [35]	527 [20.7]	190 [418]
CX1-11	Free Standing	Free Standing	1829 [72]	914 [36]	584 [23]	247 [543]
CX1-12	Free Standing	Free Standing	2134 [84]	914 [36]	847 [33.4]	579 [1273]
CX1-13	Free Standing	Free Standing	2134 [84]	1524 [60]	847 [33.4]	662 [1456]

CX1-9 through CX1-11 are a wall mount configuration with 12 inch high mounting feet. Feet are removable. Allow 4-6 inches between enclosures for venting.

Dimensions: ACS550-CC NEMA 12 R1 through R8 Frame Size

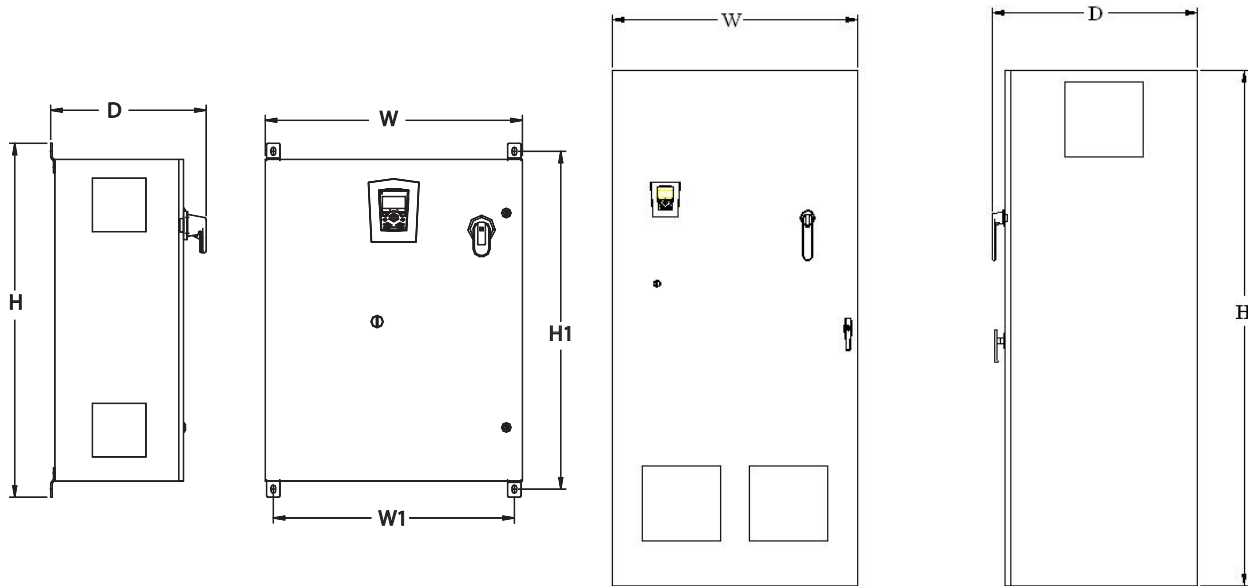

CX12-1

	H1	W1	Height (H)	Width (W)	Depth (D)	Weight
CX12-1	648 [25.5]	419 [16.5]	686 [27]	457 [18]	369 [14.5]	36 [78]
CX12-2	648 [25.5]	419 [16.5]	686 [27]	457 [18]	369 [14.5]	38 [84]
CX12-3	800 [31.5]	572 [22.5]	838 [33]	610 [24]	369 [14.3]	51 [113]
CX12-4	800 [31.5]	572 [22.5]	838 [33]	610 [24]	369 [14.3]	64 [141]
CX12-5	953 [37.5]	724 [28.5]	991 [39]	762 [30]	369 [14.3]	78 [172]
CX12-6	953 [37.5]	724 [28.5]	991 [39]	762 [30]	369 [14.3]	93 [205]
CX12-7	1257 [49.5]	724 [28.5]	1304 [51.4]	914 [36]	572 [22.5]	118 [259]
CX12-8	1257 [49.5]	724 [28.5]	1304 [51.4]	914 [36]	572 [22.5]	147 [323]
CX12-9	1257 [49.5]	724 [28.5]	1304 [51.4]	914 [36]	572 [22.5]	182 [400]
CX12-10	Free Standing	Free Standing	1829 [72]	914 [36]	584 [23]	247 [543]
CX12-11	Free Standing	Free Standing	2134 [84]	914 [36]	847 [33.4]	579 [1273]
CX12-12	Free Standing	Free Standing	2134 [84]	1524 [60]	847 [33.4]	662 [1456]

standing

CX3R-10 is a wall mount configuration with 12 inch high mounting feet.

Feet are removable.

CX3R-12 enclosure is double door construction.

Allow 4-6 inches between enclosures for venting.

Dimensions: ACS550-CC NEMA 3R R1 through R6 Frame Size

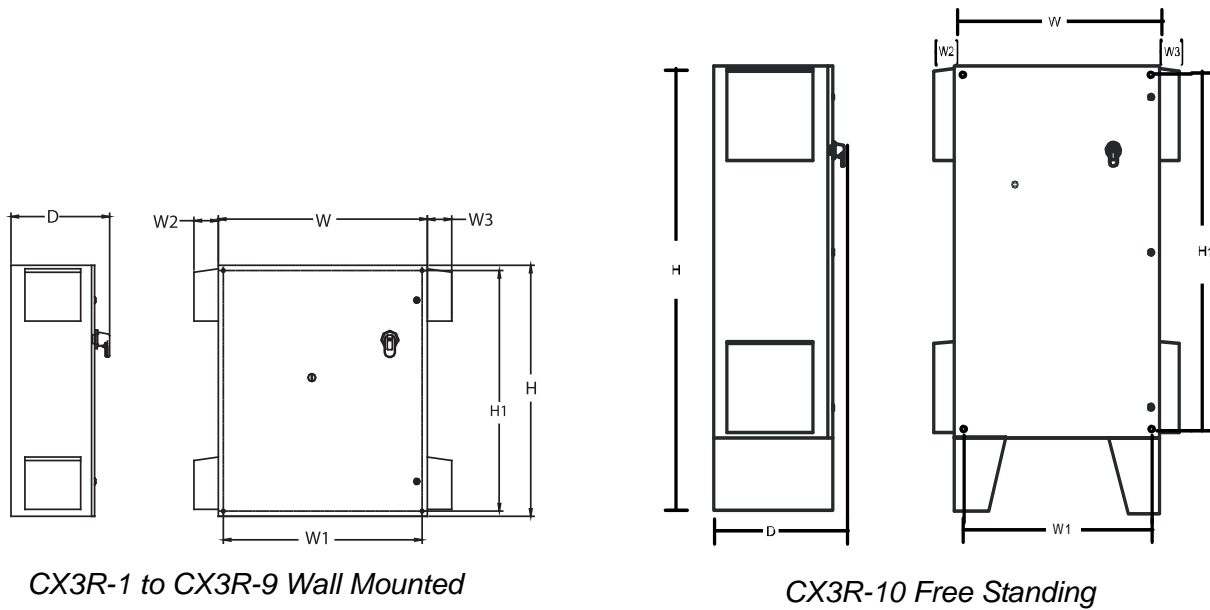



	H1	W1	Height (H)	Width (W)	Width (W2)	Width (W3)	Depth (D)	Weight
CX3R-1	572 [22.5]	419 [16.5]	610 [24]	457 [18]	89 [3.5]	N/A N/A	359 [14.1]	37 [82]
CX3R-2	572 [22.5]	419 [16.5]	610 [24]	457 [18]	89 [3.5]	N/A N/A	359 [14.1]	40 [88]
CX3R-3	724 [28.5]	572 [22.5]	762 [30]	610 [24]	89 [3.5]	N/A N/A	359 [14.1]	53 [117]
CX3R-4	724 [28.5]	572 [22.5]	762 [30]	610 [24]	89 [3.5]	N/A N/A	359 [14.1]	66 [145]
CX3R-5	876 [34.5]	725 [28.5]	914 [36]	762 [30]	89 [3.5]	89 [3.5]	359 [14.1]	82 [180]
CX3R-6	876 [34.5]	725 [28.5]	914 [36]	762 [30]	89 [3.5]	89 [3.5]	359 [14.1]	97 [213]
CX3R-7	1181 [46.5]	876 [34.5]	1219 [48]	914 [36]	89 [3.5]	89 [3.5]	562 [22.1]	121 [267]
CX3R-8	1181 [46.5]	876 [34.5]	1219 [48]	914 [36]	89 [3.5]	89 [3.5]	562 [22.1]	151 [331]
CX3R-9	1181 [46.5]	876 [34.5]	1219 [48]	914 [36]	89 [3.5]	89 [3.5]	562 [22.1]	186 [408]
CX3R-10	Free Standing	Free Standing	1829 [72]	914 [36]	89 [3.5]	89 [3.5]	584 [23]	251 [553]

CX3R-10 is a wall mount configuration with 12 inch high mounting feet.
Feet are removable.

Applicable Standards

Drive compliance with the following standards is identified by the standards “marks” on the type code label.

Mark	Applicable Standards	
	UL 508C and C22.2 No. 14	UL Standard for Safety, Power Conversion Equipment, and CSA Standard for Industrial Control Equipment
	UL 508A	UL Standard for Safety, Industrial Control Panels
	C22.2 No. 14	CSA Standard for Industrial Control Equipment

Compliance is valid with the following provisions:

- The motor and control cables are chosen as specified in this manual.
- The installation rules of this manual are followed.

Index

Numerics			
208/230V bypass packages	27		
480V bypass packages	28		
600V bypass packages	28		
A			
Air flow	26		
Analog inputs	14		
Auto start contact	15		
Automatic start-up warning	1		
Auto/Man setting	16		
Auto/Man setting, overload relay	16		
B			
Branch circuit protection	19		
Bypass			
contactors, description	25		
diagram	6		
features and functions	4		
C			
Cable requirements, input power	18		
Class setting, overload relay	16		
Connection points	14		
Contactor bypass, description	25		
Contacts, auto start	15		
Control wiring	13		
Cooling	26		
Current settings	16		
D			
Dangerous voltage warning	1		
Dimensional references	27–28		
208/230V bypass packages	27		
480V bypass packages	28		
600V bypass packages	28		
Dimensions			
NEMA 1 R1-R8 frame size	27		
NEMA 12 R1-R8 frame size	27		
NEMA 3R R1- R6 frame size	27		
Drive			
identification	8		
proper lifting	7		
standards, compliance to	32		
E			
Enclosure protection class code	8		
		F	
		Floor mount	
		installing the line input wiring	12
		typical configuration, front view	5
		wiring overview	11
		Fuses, drive	
		208 to 240 volt drives	22
		380 to 480 volt drives	23
		500 to 600 volt drives	20
		G	
		Grounding requirements	10
		H	
		Heat loss	26
		I	
		Identifying the drive type	8
		Input power	
		branch circuit protection	19
		cable/wire requirements	18
		Installation	
		control wiring	13
		flow chart	6
		line input wiring	12
		motor wiring	13
		preparation	7, 8
		wiring requirements	10
		Installer warning	1
		Interlocks, run enable	15
		L	
		Line connection warning	1
		Location, mounting	8
		M	
		Maintenance schedule	17
		Manuals for ACS550 drive	ii
		Metal conduit runs	10
		Motor	16
		cable, maximum length	26
		connection specifications	26
		connections	25
		protection, overload relay	25
		running, relay contact output	15
		wiring	13
		Mounting locations	8
		Mounting locations, preparing	9

N		T	
NEMA 1		Technical data	18–32
code	8	Terminal block 1TB	14
R1-R8 frame size dimensions	27	Terminals, power, wire sizes	22
NEMA 12		W	
code	8	Wall mount	
R1-R8 frame size dimensions	27	installing the line input wiring	12
NEMA 3R		installing the motor wiring	13
code	8	typical configuration, front view	5
R1- R6 frame size dimensions	27	wiring overview	11
O		Warning	
Overload relay		automatic start-up	1
motor protection	25	dangerous voltages	1
resetting	16	parallel control connections	1
P		qualified installer	1
Parallel control connections warning	1	Wire requirements, input power	18
Power connection terminals	22	Wiring	
Protection		conduits	13
branch circuit	19	control	13
motor overload	25	line input	12
Q		motor	13
Qualified installer requirement	1	requirements	10
R		shielded cable	13
R7/R8		wall and floor mount overviews	11
cooling	26		
motor connection specifications	26		
Relay			
motor running contact output	15		
overload	16		
Requirements			
grounding	10		
input power cables	18		
metal conduit runs	10		
wiring	10		
wiring, input power	18		
Resetting the overload relay	16		
Run enable interlocks	15		
Running, relay contact output	15		
S			
Safety warnings	1		
Specifications			
208 to 240 volt power connection	22		
380 to 480 volt power connection	23		
500 to 600 volt power connection	24		
cooling	26		
input power connections	19		
motor connections	26		
power connection terminals	22		
Standards	32		
C22.2 No. 14	32		
UL 508C	32		



3AJA0000014758 REV B / EN
EFFECTIVE: 08/01/2008
SUPERCEDES: 03/01/2007

ABB Inc.

Automation Products

Low Voltage Drives

16250 West Glendale Drive

New Berlin, WI 53151

Telephone 262 785-3200

Fax 262 780-5135

Internet www.abb.us/drives

www.abb-drives.com