

User's Manual

ACS550-PC/PD Packaged Drive with Disconnect
Supplement to ACS550-01/U1 User's Manual



ACS550 Drive Manuals

GENERAL MANUALS

ACS550-01/U1 User's Manual (1...200 HP)

- Safety
- Installation
- Start-Up
- Embedded Fieldbus
- Fieldbus Adapter
- Diagnostics
- Maintenance
- Technical Data

ACS550 Technical Reference Manual (available in electronic format only)

- Detailed Product Description
- Practical Engineering Guides







ACS550-PC/PD Packaged Drive with Disconnect Supplement for ACS550-01/U1 User's Manual

- Safety
- Installation
- Start-Up
- Maintenance
- Technical Data

ACS550- CC Packaged Drive with Bypass Supplement for ACS550-01/U1 User's Manual

- Safety
- Installation
- Start-Up
- Maintenance
- Technical Data

Safety

-  **WARNING!** The ACS550 adjustable speed AC drive with Input Disconnect should **ONLY** be installed by a qualified electrician.
-  **WARNING!** Even when the motor is stopped, dangerous voltage is present at the Power Circuit terminals U1, V1, W1 and U2, V2, W2 and, depending on the frame size, UDC+ and UDC-, or BRK+ and BRK-.
-  **WARNING!** Dangerous voltage is present when input power is connected. After disconnecting the supply, wait at least 5 minutes (to let the intermediate circuit capacitors discharge) before removing the cover.
-  **WARNING!** Even when power is removed from the input terminals of the ACS550, there may be dangerous voltage (from external sources) on the terminals of the relay outputs.
-  **WARNING!** When the control terminals of two or more drive units are connected in parallel, the auxiliary voltage for these control connections must be taken from a single source which can either be one of the units or an external supply.
-  **WARNING!** The ACS550 will start up automatically after an input voltage interruption if the external run command is on.
-  **WARNING!** When the ACS550 with Input Disconnect is connected to the line power, the Motor Terminals T1, T2, and T3 are live even if the motor is not running. Do not make any connections when the ACS550 with Input Disconnect is connected to the line. Disconnect and lock out power to the drive before servicing the drive. Failure to disconnect power may cause serious injury or death.
-

Note! For more technical information, contact the factory or your local ABB sales representative.

Use of Warnings and Notes

There are two types of safety instructions throughout this manual:

- Notes draw attention to a particular condition or fact, or give information on a subject.
- Warnings caution you about conditions which can result in serious injury or death and/or damage to the equipment. They also tell you how to avoid the danger. The warning symbols are used as follows:

-  **Dangerous voltage warning warns of high voltage which can cause physical injury and/or damage to the equipment.**
-



General warning warns about conditions, other than those caused by electricity, which can result in physical injury and/or damage to the equipment.

Table of Contents

Safety

Use of Warnings and Notes	1
---------------------------------	---

Table of Contents

Installation

Application	4
Input Disconnect Features and Functions	4
Installation Flow Chart	6
Preparing for Installation (Supplement to ACS550-01/U1 User's Manual)	7
Preparing for Installation (Supplement to ACS550-01/U1 User's Manual)	8
Installing the Drive (Supplement to ACS550-01/U1 User's Manual)	9
Installing the Wiring (Supplement to ACS550-01/U1 User's Manual)	12

Maintenance

Maintenance Intervals	17
Drive Module Fan Replacement	17
Enclosure Fan Replacement – UL Type / NEMA 12 Floor Mount Enclosures ..	18
Enclosure Air Filter Replacement – UL Type / NEMA 12 Hinged Door	
Wall Mount Enclosures	19
Floor Mount - UL Type / NEMA 12 Filter Material	19

Technical Data

Ratings (Supplement to ACS550-01/U1 User's Manual)	23
Input Power Connections (Supplement to ACS550-01/U1 User's Manual) ...	24
Drive's Power Connection Terminals (Supplement to ACS550-01/U1 User's Manual)	27
Motor Connections	30
Cooling – R7/R8	30
Dimensional References	31
Dimensions and Weights (Supplement to ACS550-01/U1 User's Manual) ...	34
Applicable Standards	37

Index

Installation

Study these installation instructions carefully before proceeding. **Failure to observe the warnings and instructions may cause a malfunction or personal hazard.**



WARNING! Before you begin read “Safety” on page 1.



WARNING! When the ACS550 with Input Disconnect is connected to the line power, the Motor Terminals T1, T2, and T3 are live even if the motor is not running. Do not make any connections when the ACS550 with Input Disconnect is connected to the line. Disconnect and lock out power to the drive before servicing the drive. Failure to disconnect power may cause serious injury or death.

Application

This manual contains supplemental information that is unique to ACS550 input disconnect configurations (PC or PD). Refer to the base manual, AC550-01/U1 User's Manual, for all other information.

Input Disconnect Features and Functions

The ACS550 with Input Disconnect is an ACS550 AC adjustable frequency drive packaged with an input disconnect switch or circuit breaker, and with a door mounted, external operating handle. The operating handle can be padlocked in the OFF position (padlock not supplied). Enclosure options are UL Type 1, UL Type 12, and UL Type 3R (NEMA 1, NEMA 12, and NEMA 3R).

The following is a typical power diagram.

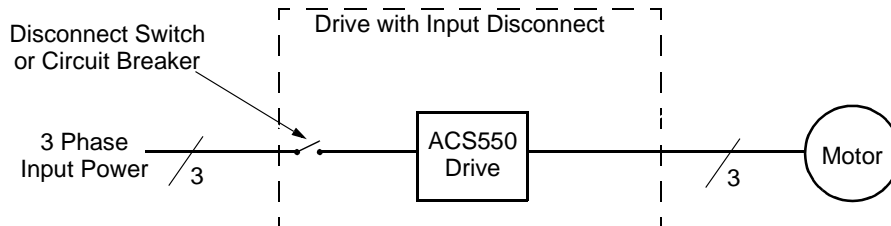

The following figures show the front view of the ACS550 Drive with Input Disconnect standard configurations, and identify the major components.

UL Type / NEMA 1 & 12
Vertical Construction
Enclosures

UL Type / NEMA 1 & 12
Hinged Door Wall Mount
Enclosures

UL Type / NEMA 1 & 12
Floor Mount
Enclosures

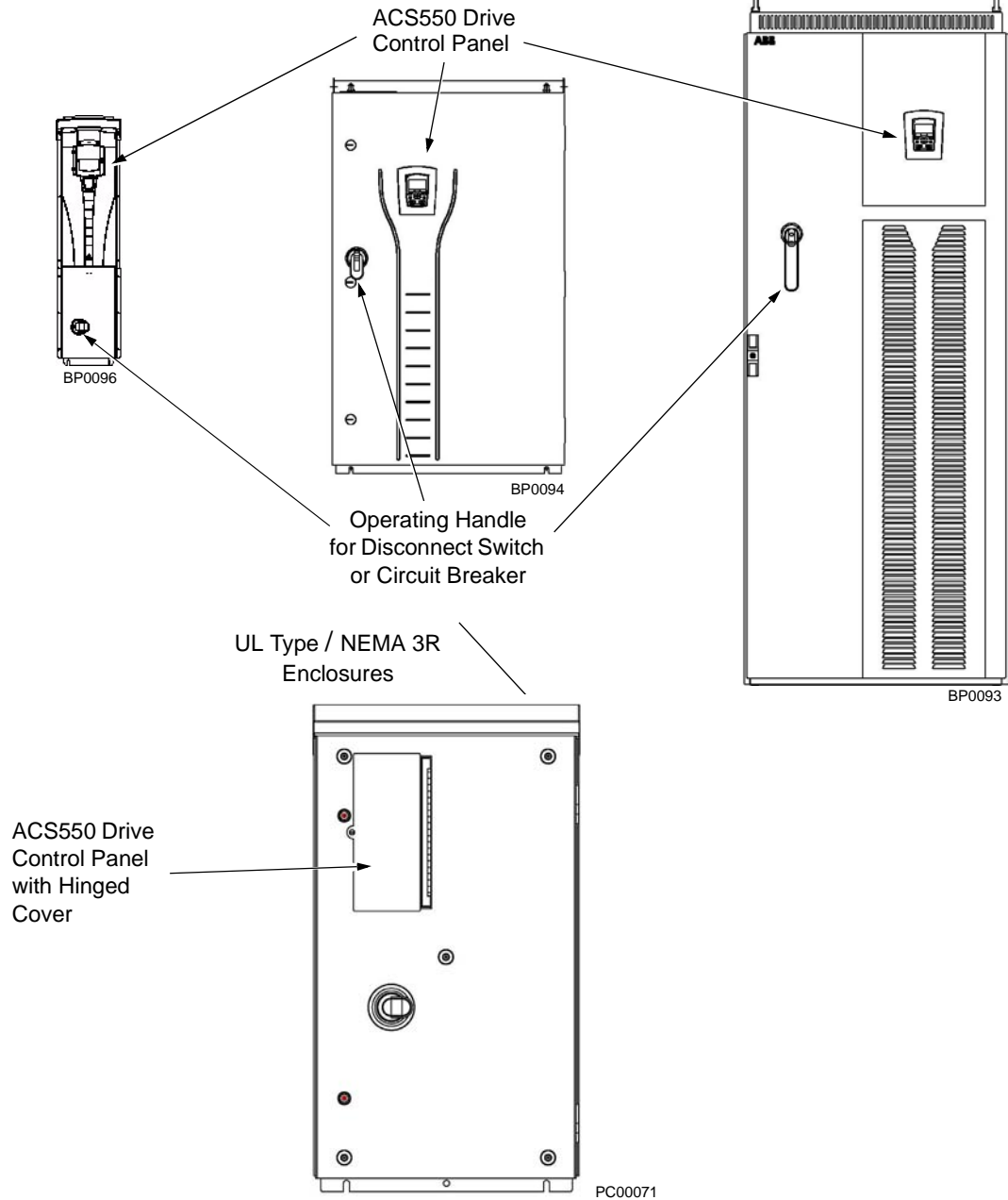

Note! UL Type 3R, PX3R-1, PX3R-2, PX3R-3 & PX3R-4 enclosures are designed to be mounted on a wall. Mounting these 3R enclosures on an open rack system requires the use of the supplied 3R enclosure back plates to maintain 3R integrity. See section "Prepare the UL Type 3R ACS550 PX3R-1, PX3R-2, PX3R-3, PX3R-4 for UNISTRUT® mounting" for more details.

Installation Flow Chart

The installation of Input Disconnect configurations for ACS550 drives follows the outline below. The steps must be carried out in the order shown. At the right of each step are references to the detailed information needed for the correct installation of the unit.

Note! References in the middle column below are to the ACS550-01/U1 User's Manual. References in the third column below are to this manual.

Task	Refer to the ACS550-01/U1 User's Manual "Installation" section	Additional Reference in this Manual
PREPARE for installation	"Preparing for Installation"	<ul style="list-style-type: none"> R7/R8: "Lifting the Drive" on page 7. "Drive Identification" on page 8. "Suitable Mounting Location" on page 9.
PREPARE the Mounting Location	"Prepare the Mounting Location"	<ul style="list-style-type: none"> R7/R8: "Prepare the Mounting Location – R7 and R8" on page 9. "Dimensions and Weights (Supplement to ACS550-01/U1 User's Manual)" on page 34.
REMOVE the front cover	"Remove Front Cover"	R7/R8: "Remove Side Panel- R7 and R8 UL Type/NEMA 1 & 12 Enclosures" on page 10.
MOUNT the drive	"Mount the Drive"	R7/R8: "Mount the Drive" on page 10.
INSTALL wiring	"Wiring Overview" and "Install the Wiring"	"Installing the Wiring (Supplement to ACS550-01/U1 User's Manual)" starting on page 12.
CHECK installation	"Check Installation"	--
RE-INSTALL the cover	"Re-install Cover"	--
APPLY power	"Apply Power"	--
START-UP	"Start-Up"	--

Preparing for Installation (Supplement to ACS550-01/U1 User's Manual)

Lifting the Drive

R7...R8



Warning! Handle and ship floor mounted enclosures only in the upright position. These units are not designed to be laid on their backs.

1. Use a pallet truck to move the package/enclosure to the installation site.
2. Remove the cabinet side panels from UL Type/NEMA 1 and 12 enclosures for access to the cabinet/pallet mounting bolts. (6 torx screws hold each cabinet side panel in place. Leave the side panels off until later.)
3. Remove the 4 bolts that secure the cabinet to the shipping pallet.



PC00005

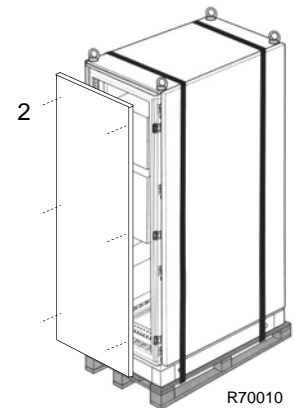

R70010



Warning! Use the lifting lugs/bars at the top of the unit to lift R7/R8 drives.

4. Use a hoist to lift the drive. (Do not place drive in final position until mounting site is prepared.)



PC00003

Preparing for Installation (Supplement to ACS550-01/U1 User’s Manual)

Drive Identification

To identify the type of device you are installing, refer to the type code number on the device identification label.

- Wall mounting base drives – label attached on the side surface of the heat sink.
- Packaged drive with screw cover – label attached to outside surface on the left side of the enclosure.
- Enclosure with hinged cover/door – label on inside surface of the cover/door.

Type Code Number

Use the following to interpret the type code found on the identification label.

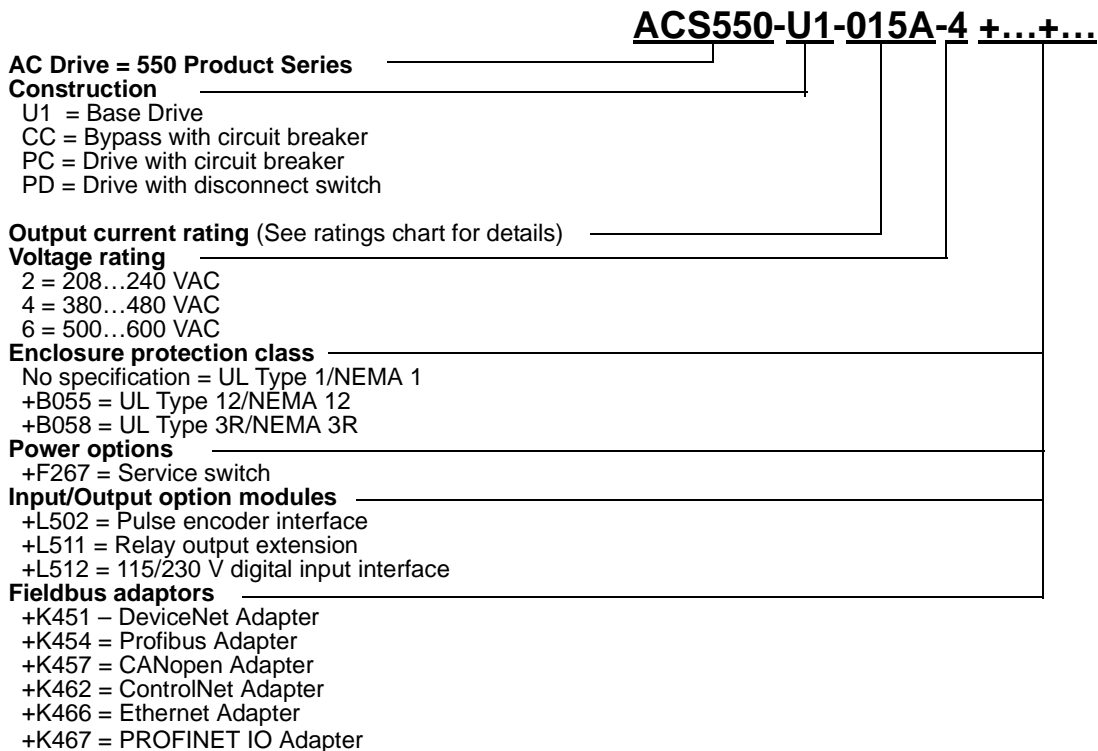

Ratings and Frame Size

Charts in the “Ratings” sections of the ACS550-01/U1 User’s Manual and this manual list technical specifications, and identify the drive’s frame size.

Note! Some instructions in this document vary, depending on the drive’s frame size. To read the Ratings table, you need the “Output current rating” entry from the type code (see above).

Suitable Mounting Location

For selecting a suitable mounting location for PC/PD configurations, refer to:

- Preparing for installation in the ACS550-01/U1 User's Manual, and
- The Technical Data section of this manual for information on dimensions and weights.

Installing the Drive (Supplement to ACS550-01/U1 User's Manual)



Warning! Metal shavings or debris in the enclosure can damage electrical equipment and create a hazardous condition. Where parts, such as conduit plates require cutting or drilling, first remove the part. If that is not practical, cover nearby electrical components to protect them from all shavings or debris.

Prepare the Mounting Location – R7 and R8

The ACS550 should only be mounted where all of the requirements defined in "Preparing for Installation" are met.

Frame sizes R7 and R8 have mounting holes inside the enclosure base. See "UL Type/NEMA 1&12, Floor Mount Enclosure Mounting Dimensions" on page 37.

Where it is not possible to use either mounting hole at the back of the base, use an L-bracket at the top of the enclosure to secure the cabinet to a wall or to the back of another enclosure. Bolt the L-bracket to the enclosure using the lifting lug bolt hole on the top of the enclosure.

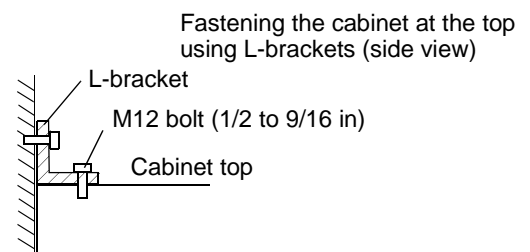
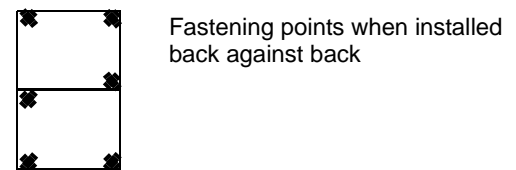
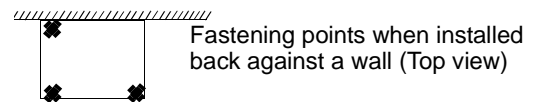
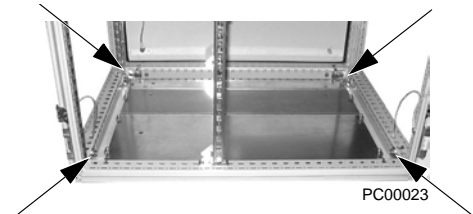

Remove Side Panels – R7 and R8 UL Type/NEMA 1 & 12 Enclosures

Cabinet Door

1. To open the cabinet door, loosen the quarter-turn screws that hold the cabinet door closed.
2. Installation access is easier if these panels are kept off throughout the installation.

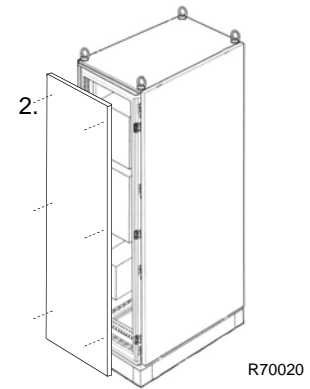

Mount the Drive

R7...R8

1. Use a hoist to move the cabinet into position.

Note! If the cabinet location does not provide access to the cabinet sides, be sure to re-mount side panels before positioning cabinet.

2. Install and tighten mounting bolts.



Prepare the UL Type 3R ACS550 PX3R-1, PX3R-2, PX3R-3, PX3R-4 for UNISTRUT® mounting

The ACS550 UL Type 3R cabinet frame sizes PX3R-1, PX3R-2, PX3R-3, PX3R-4, PX3R-5, PX3R-6 are designed to be mounted on a solid vertical surface or using UNISTRUT. On frame sizes PX3R-1, PX3R-2, PX3R-3, PX3R-4, the design requires the use of a back plate that is provided with each UL Type 3R PX3R-1, PX3R-2, PX3R-3, PX3R-4 shipment.

As delivered, UL Type 3R ACS550 drives PX3R-1, PX3R-2, PX3R-3, PX3R-4 frame sizes are supplied such that mounting the cabinet on an open back allows rain/snow to enter the pre-cut vent. To meet UL Type 3R requirements, install back plate provided with the drive.



ACx550 UL Type 3R Back Plate Instructions

1. Install back plate.

Note! If cabinet is mounted on a solid surface, back plate shipped with cabinet is not required but may still be installed.



2. Install 2 bolts on top and bottom with back plate installed behind cabinet.

Note! If cabinet is mounted on a solid surface, back plate shipped with cabinet is not required, but may still be installed.

Installing the Wiring (Supplement to ACS550-01/U1 User's Manual)



WARNING!

- **Metal shavings or debris in the enclosure can damage electrical equipment and create a hazardous condition. Where parts, such as conduit plates require cutting or drilling, first remove the part. If that is not practical, cover nearby electrical components to protect them from all shavings or debris.**
 - **Do not connect or disconnect input or output power wiring, or control wires, when power is applied.**
 - **Never connect line voltage to drive output Terminals T1, T2, and T3.**
 - **Do not make any voltage tolerance tests (Hi Pot or Megger) on any part of the unit. Disconnect motor wires before taking any measurements in the motor or motor wires.**
 - **Make sure that power factor correction capacitors are not connected between the drive and the motor.**
-

Wiring Requirements

Refer to the “Wiring Requirements” Section in the ACS550-01/U1 User's Manual. The requirements apply to all ACS550 drives. In particular:

- Use separate, metal conduit runs for the following different classes of wiring:
 - Input power wiring.
 - Motor wiring.
 - Control/communications wiring.
- Properly and individually ground the drive, the motor and cable shields.

Wiring Overview

Power Connection – Standard Drive with Input Disconnect (Wall Mounted)

The following figures show the Standard Drive with Input Disconnect (wall mounted) wiring connection points. Refer to the ACS550-01/U1 User's Manual for control connections to the drive.

UL Type / NEMA 1 & 12
Vertical Construction
Enclosures

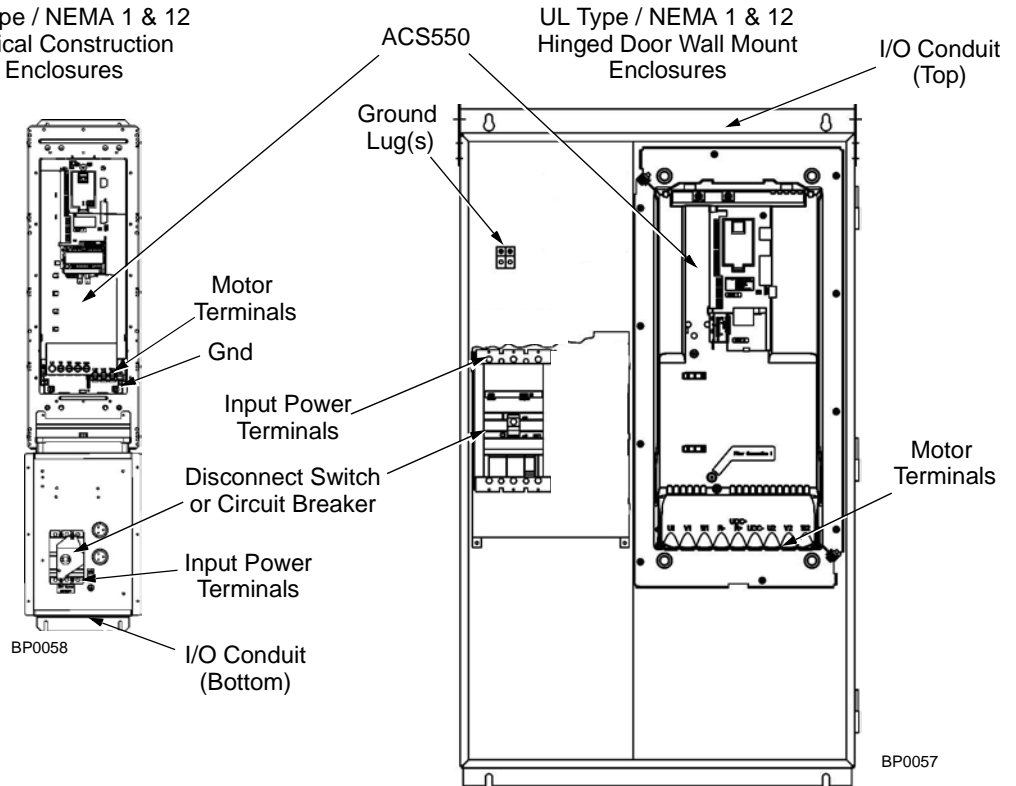

UL Type / NEMA 3R
Enclosures

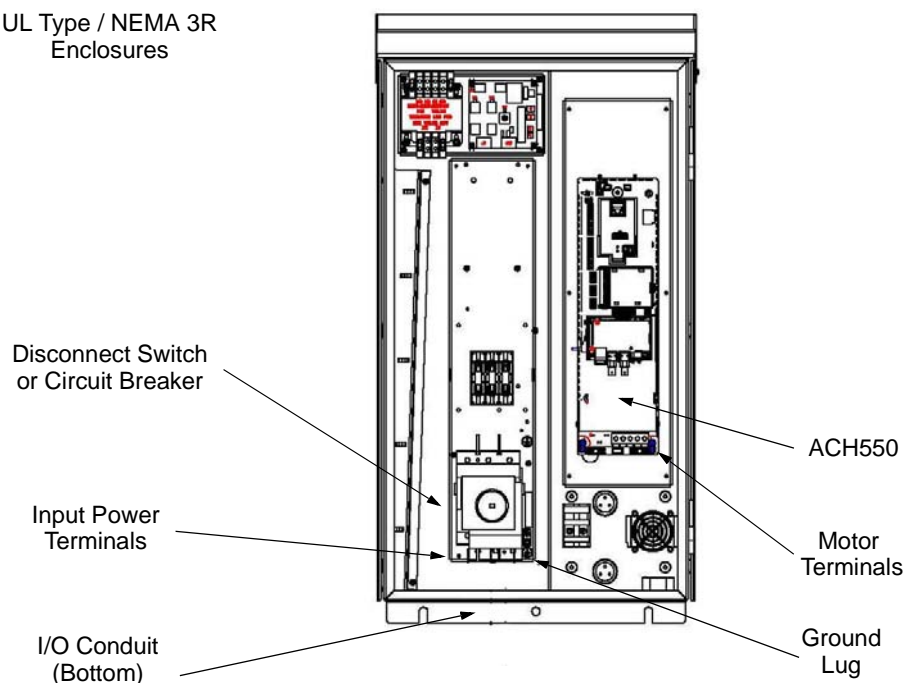

Power Connection – Standard Drive with Input Disconnect (Floor Mounted)

UL Type/NEMA 1 & 12 floor mounted ACS550 Standard Drive with Input Disconnect units are configured for wiring access from the top and include a removable conduit mounting plate. The following figure shows the wiring connection points. Refer to the ACS550-01/U1 User's Manual for control connections to the drive.

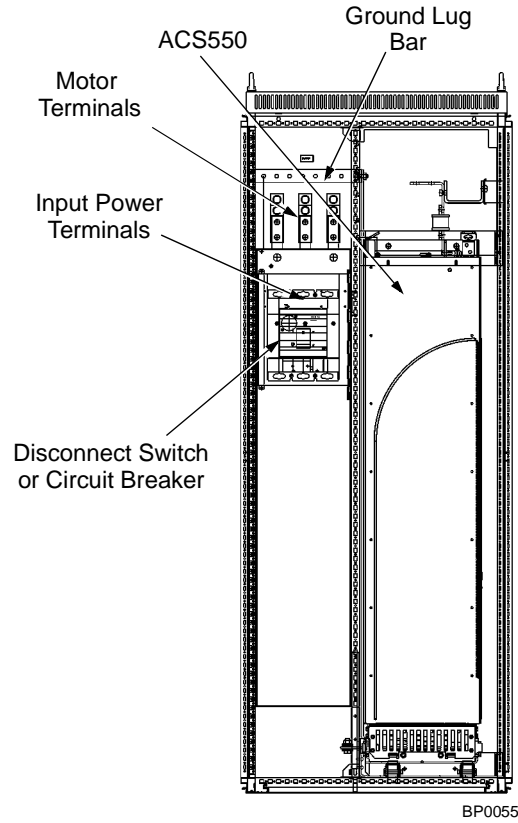

Install the Line Input Wiring

Line Input Connections – Standard Drive with Input Disconnect Configurations

Connect input power to the terminals of the disconnect switch or circuit breaker. Connect the equipment grounding conductor to the ground lug. The figure below shows the connection points for Standard Drive with Input Disconnect configurations.

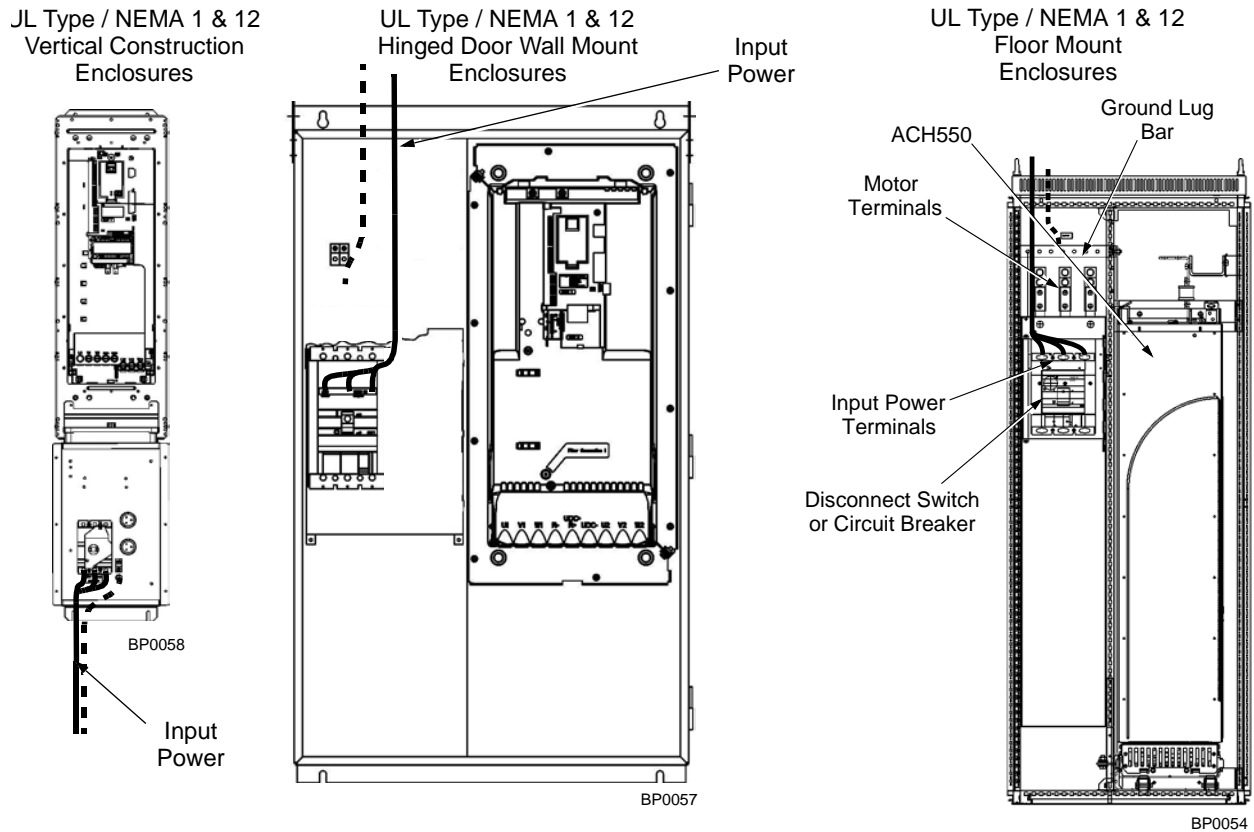

Dashed line is ground run.

Note! The terminals on disconnect switches for the following rated ACS550-PD products is 7 in-lbs. Do not use a power driver or over tighten to prevent breaking screw heads or strip the terminal.

230 VAC	460 VAC	600 VAC
-04A6-2	-03A3-4	-02A7-6
-06A6-2	-04A1-4	-03A9-6
-07A5-2	-06A9-4	-06A1-6
-012A-2	-08A8-4	-09A0-6
-017A-2	-012A-4	-011A-6
-024A-2	-015A-4	-017A-6
-031A-2	-023A-4	

UL Type / NEMA 3R
Enclosures

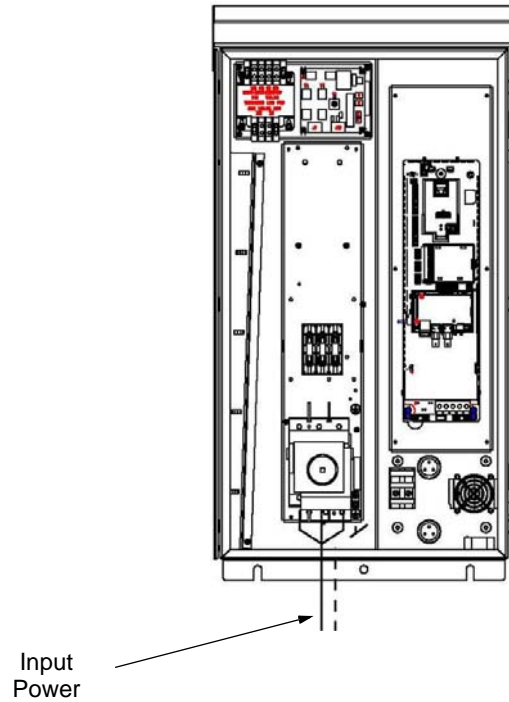

WARNING! Check the motor and motor wiring insulation before connecting the ACS550 to line power. Follow the procedure in the ACS550-01/U1 User's Manual. Before proceeding with the insulation resistance measurements, check that the ACS550 is disconnected from incoming line power. Failure to disconnect line power could result in death or serious injury.

Note! For the remainder of the installation and start-up (motor and control wiring) refer to the ACS550-01/U1 User's Manual.

Maintenance

Maintenance Intervals

If installed in an appropriate environment, the drive requires very little maintenance. This table lists the routine maintenance intervals recommended by ABB.

Maintenance	Configuration	Interval	Instruction
Check/replace hinged door wall mount enclosure inlet air filter	Hinged door wall Mount UL Type / NEMA 12 enclosures	Check every 3 months. Replace as needed.	“Enclosure Air Filter Replacement – UL Type / NEMA 12 Hinged Door Wall Mount Enclosures” on page 19
Check/replace floor mount enclosure inlet air filter	Floor mount UL Type / NEMA 12 enclosures	Check every 3 months. Replace as needed.	“Floor Mount – UL Type / NEMA 12 Enclosure Inlet Air Filter” on page 20
Check/replace floor mount enclosure exhaust air filter.	Floor mount UL Type / NEMA 12 enclosures	Check every 6 months. Replace as needed.	“Floor Mount – UL Type / NEMA 12 Enclosure Exhaust Filters” on page 21
Check/replace UL Type 3R/NEMA 3R enclosure air filters	UL Type / NEMA 3R enclosures - PX3R-5 and higher	Check every 3 months. Replace as needed.	See PX3R dimensional information on pages 31 and 36.
Check and clean heatsink.	All	Depends on the dustiness of the environment (every 6...12 months)	See “Maintenance” in ACS550-01/U1 User’s Manual.
Replace drive module fan.	All	Every six years	See “Maintenance” in ACS550-01/U1 User’s Manual.
Replace enclosure fan(s).	NEMA 12 and 3R enclosures	Every three years	See “Enclosure Fan Replacement – UL Type / NEMA 12 Floor Mount Enclosures” on page 18. For other frame sizes, see “Maintenance” in ACS550-01/U1 User’s Manual.
Change capacitor.	Frame sizes R5 and R6	Every ten years	See “Maintenance” in ACS550-01/U1 User’s Manual.
Replace battery in the Assistant control panel.	All	Every ten years	See “Maintenance” in ACS550-01/U1 User’s Manual.

Drive Module Fan Replacement

The drive module fan cools the heatsink. Fan failure can be predicted by the increasing noise from fan bearings and the gradual rise in the heatsink temperature in spite of heatsink cleaning. If the drive is operated in a critical part of a process, fan replacement is recommended once these symptoms start appearing. Replacement fans are available from ABB. Do not use other than ABB specified spare parts.

To monitor the running time of the cooling fan, see “Group 29: Maintenance Trig” in the ACS550-01/U1 Users’s Manual.

Refer to the installation instructions supplied with the fan kit.

Enclosure Fan Replacement – UL Type / NEMA 12 Floor Mount Enclosures

UL Type 12/NEMA 12 enclosures include an additional fan (or fans) to move air through the enclosure.

Floor Mount– UL Type / NEMA 12 Enclosures

The enclosure fan is located in the exhaust box on top of the UL Type / NEMA 12 enclosure.

1. Remove the left and right filter frames of the exhaust fan box by lifting them upwards.
2. Disconnect the fan's electrical connector from the cabinet roof (top right Inside the cabinet).

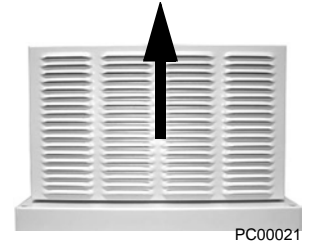

3. Undo the four fastening screws at the corners of the fan frame. The screws are through bolts with nuts on the inside of the cabinet. (Do not drop the hardware into the drive).

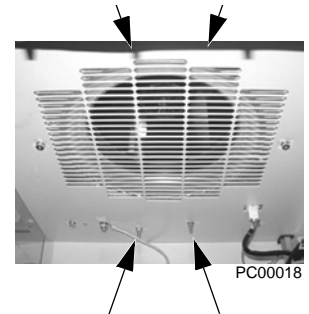
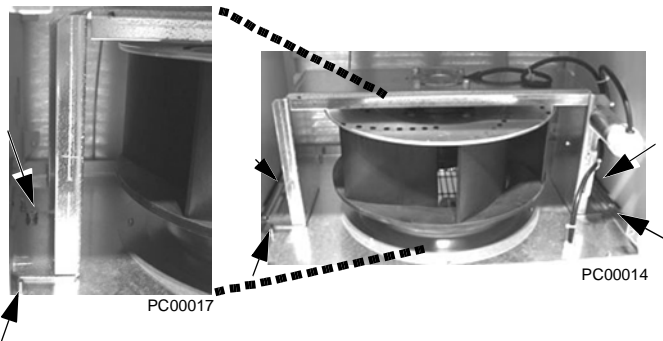

4. Remove the fan and fan frame as one unit.

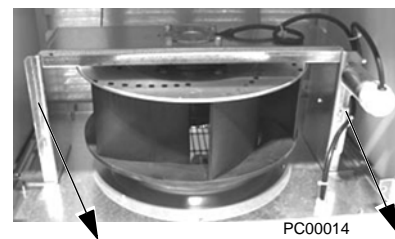

5. Disconnect the fan wiring and capacitor from the fan frame. Then remove the four screws attaching the fan to the fan frame. Remove the old fan.

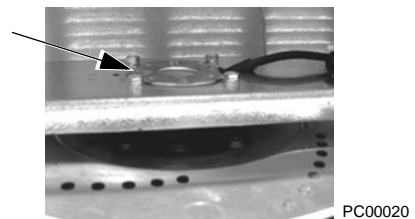

6. Install the new fan and capacitor with the replacement part for ABB in the reverse order of the above. Ensure the fan is centered on the velocity stack and rotates freely.

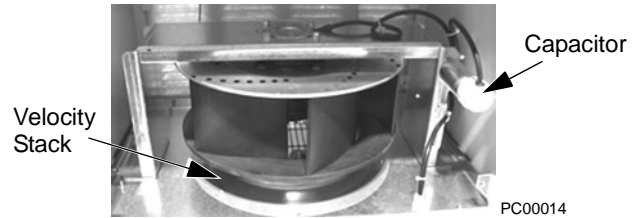

Enclosure Air Filter Replacement – UL Type / NEMA 12 Hinged Door Wall Mount Enclosures

This procedure applies to drive with disconnect configurations in UL Type / NEMA 12 hinged door wall mount enclosures. This filter is located at the bottom of the enclosure. Use the following procedure to check and replace filters.

1. On the enclosure, remove the screw holding the filter bracket in place.
2. Slide the filter bracket forward until the hooks on the bracket clear the slots on the enclosure base. This step allows the filter and bracket to drop free from the enclosure.

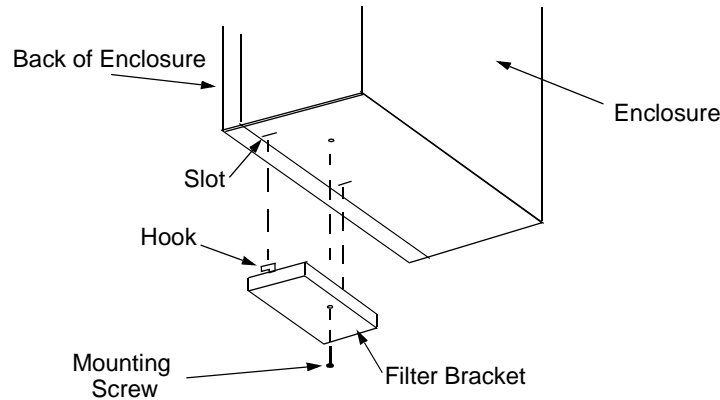

3. Lift the filter out of the filter bracket and replace as appropriate.
4. With the filter in the filter bracket, align the hooks on the bracket with the slots in the enclosure base, and press the hooks up into the slots.
5. Slide the filter bracket back, making sure that the hooks catch on the enclosure.
6. Replace the mounting screw. Tighten until the gasket on the bracket is about 50% compressed.

Floor Mount - UL Type / NEMA 12 Filter Material

Enclosure Type	Inlet (door)	Outlet (roof)
UL Type / NEMA 12	3AUA0000006723 (qty 1)	3AUA0000006722 (qty 2)

Note: When installing the filter media, the white side must face the outside of the cabinet and the colored side must face the inside of the cabinet.

Floor Mount – UL Type / NEMA 12 Enclosure Inlet Air Filter

The inlet air filter for the R7/R8 UL Type / NEMA 12 enclosure is located in the enclosure front door.

1. While holding the top of the filter frame, pull up on the bottom of the frame. The filter frame will slide up approximately 3/4 inch and can then safely removed by tilting away from the cabinet and lifting up.



PC00015

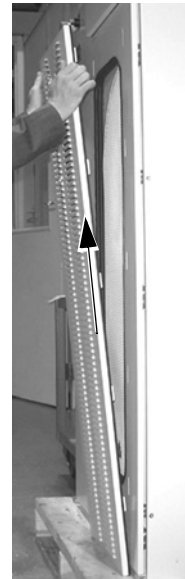

PC00010

2. Lay the filter frame on a flat work surface. Remove the 3 retaining brackets by squeezing the tabbed corners in towards the middle of each bracket until the bracket clears the filter frame. Save these brackets for replacement. Remove and inspect the filter.

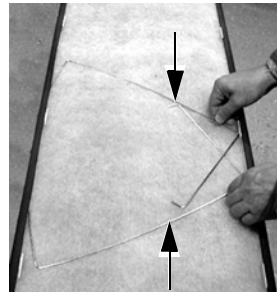

PC00009

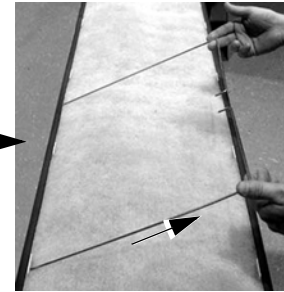

PC00007

3. Install the replacement filter. Be sure to tuck the filter into the groove around the entire filter frame. This is very important for proper installation.



PC00013

4. Reinstall the 3 filter restraining brackets. These will prevent the filter from being pulled out of the filter frame.
 - Install the center bracket first.
 - Install the 2nd bracket overlapping the center bracket by 1/2 to the left.

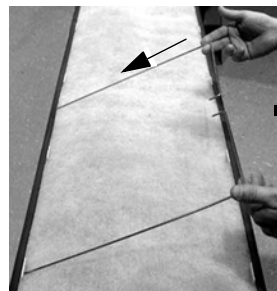

PC00007

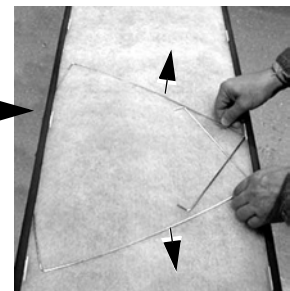

PC00009

- Install the 3rd bracket overlapping the center bracket by ½ to the right.

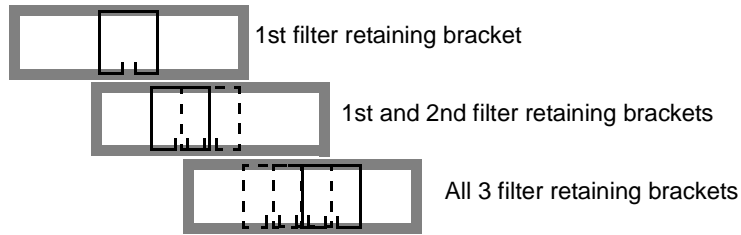

5. Install the filter frame back to the cabinet door. Carefully align the mounting hooks to the slots in the cabinet door. The hooks should be pointing down. Press in at the center of the filter frame with your knee and gently press down with your hands at the top of the frame. The filter frame will slide down approximately ¾ inch and should be sealed securely to the door around the entire filter frame.

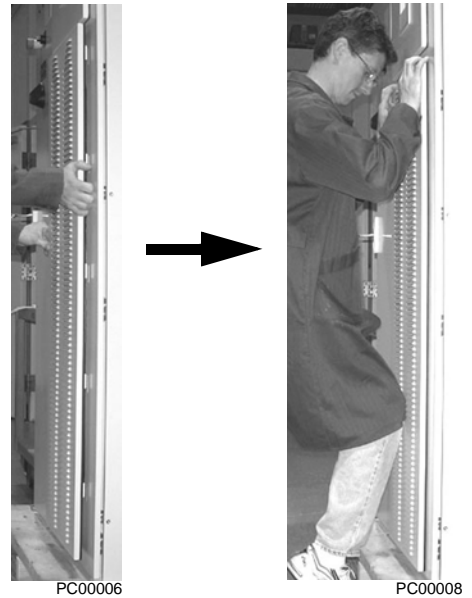

Floor Mount – UL Type / NEMA 12 Enclosure Exhaust Filters

The exhaust filters in the floor mount UL Type / NEMA 12 enclosure are located in the exhaust box at the top of the enclosure.

There are 2 filter frames attached to the exhaust box.

1. Remove each filter frame:
 - Lift up on the filter frame until it slides approximately ¾ inch.
 - Pull away from the exhaust box to remove.
2. For each filter frame, remove the wire retainers that hold the filters in place:
 - Lay the filter frames on a flat work surface.
 - The wire retainers have a square “U” shape. Remove by squeezing the open end of the

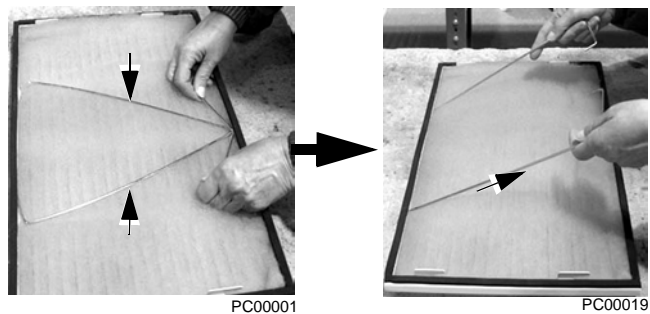
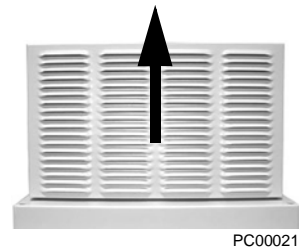

“U” towards the middle of the “square” until the retainer top (open end of “U”) clears the filter frame.

- Save the retainers for reinstallation.
3. Remove and inspect the filter.
 4. Install clean filters.

Note! When installing filter media, the white side must face to outside of the cabinet, and the colored side faces in. Be sure to tuck the filter edges into the groove around the entire filter frame. This detail is very important for proper operation.

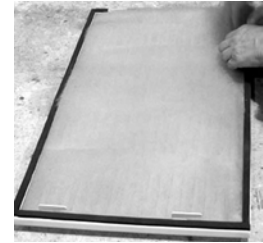

PC00022

5. Reinstall the filter restrainers.

- Insert the base of a retainer (bottom of “U” shape) into a filter frame channel.
- Squeeze the open end of the “U” until it clears the filter frame.
- Seat the open end of the “U” in the filter frame channel.
- Release the retainer to its relaxed, square shape.

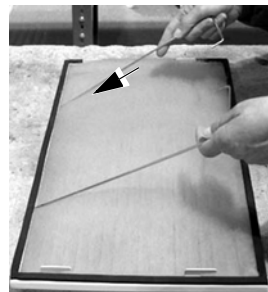

PC00019

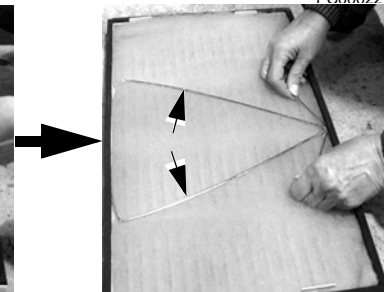

PC00007

6. Install each filter frame to the bonnet on top of the cabinet.

- Carefully align the frame's mounting hooks with the slots in the bonnet. (The hooks should be pointing down.)
- Press down at the top of the filter frame. (The filter frame slides down approximately 3/4 inch).
- Check all around the filter frame for a secure seal to the exhaust box.



PC00012

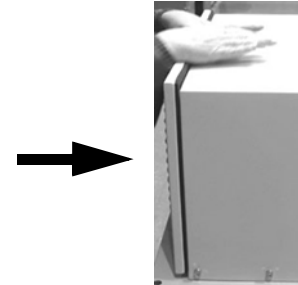

PC00011

Technical Data

Ratings (Supplement to ACS550-01/U1 User's Manual)

Note! The ratings listed below are exceptions to the ratings listed in the ACS550-01/U1 User's Manual.

Ratings, 480 Volt Drives

Type Code	Valid up to 40°C (104 °F)				Frame Size
	Normal Use		Heavy-Duty Use		
	I_{2N} A	P_N HP	I_{2hd} A	P_{hd} HP	
-316A-4	316	250	240	200	R8
-368A-4	368	300	302	250	R8
-414A-4	414	350	368	300	R8
-486A-4	486	400	414	350	R8
-526A-4	526	450	477	400	R8
-602A-4	602	500	515	450	R8
-645A-4	645	550	590	500	R8

Input Power Connections (Supplement to ACS550-01/U1 User's Manual)

Fuses

Note! Although fuses listed are similar in functional characteristics to fuses listed in the ACS550-01/U1 User's Manual, physical characteristics may differ. Fuses from other manufacturers can be used if they meet the functional characteristics of those in these tables.

208/240 Volt Fuses

208/240 Volt		Base Drive Frame Size	Drive Input Fuse Ratings	
HP	Identification ¹		Amps (600V)	Bussmann Type
1	ACS550-PD-04A6-2	R1	15	KTK-R-15
1.5	ACS550-PD-06A6-2	R1	15	KTK-R-15
2	ACS550-PD-07A5-2	R1	15	KTK-R-15
3	ACS550-PD-012A-2	R1	15	KTK-R-15
5	ACS550-PD-017A-2	R1	30	KTK-R-30
7.5	ACS550-PD-024A-2	R2	30	KTK-R-30
10	ACS550-PD-031A-2	R2	60	JJS-60
15	ACS550-PD-046A-2	R3	100	JJS-100
20	ACS550-PD-059A-2	R3	100	JJS-100
25	ACS550-PD-075A-2	R4	100	JJS-100
30	ACS550-Px-088A-2	R4	200	170M1370 ² or 170M2617
40	ACS550-Px-114A-2	R4	200	170M1370 ² or 170M2617
50	ACS550-Px-143A-2	R6	200	170M1370 ² or 170M2617
60	ACS550-Px-178A-2	R6	315	170M1372 ² or 170M2619
75	ACS550-Px-221A-2	R6	315	170M1372 ² or 170M2619
100	ACS550-Px-248A-2	R6	315	170M1372 ² or 170M2619

1. "Px" represents both PC and PD.

2. UL Type / NEMA 3R enclosed units are provided with Bussman Type JJS or equivalent fuses. Fuse ratings shown relate to latest production. Where installed product includes fuses of a lower rating, either rating may be used.

480 Volt Fuses

480 Volt		Base Drive Frame Size	Drive Input Fuse Ratings	
HP	Type Code		Amps (600V)	Bussmann Type
1/1.5	ACS550-PD-03A3-4	R1	15	KTK-R-15
2	ACS550-PD-04A1-4	R1	15	KTK-R-15
3	ACS550-PD-06A9-4	R1	15	KTK-R-15
5	ACS550-PD-08A8-4	R1	15	KTK-R-15
7.5	ACS550-PD-012A-4	R1	15	KTK-R-15
10	ACS550-PD-015A-4	R2	30	KTK-R-30
15	ACS550-PD-023A-4	R2	30	KTK-R-30
20	ACS550-PD-031A-4	R3	60	JJS-60
25	ACS550-PD-038A-4	R3	60	JJS-60
30	ACS550-PD-045A-4	R3	100	JJS-100
30	ACS550-PD-044A-4	R4	100	JJS-100
40	ACS550-PD-059A-4	R4	100	JJS-100
50	ACS550-PD-072A-4	R4	100	JJS-100
60	ACS550-PD-078A-4	R4	100	JJS-100
75	ACS550-Px-097A-4	R4	200	170M1370 ² or 170M2617
60	ACS550-Px-077A-4	R5	125	170M1368
75	ACS550-Px-096A-4	R5	125	170M1368 ²
100	ACS550-Px-125A-4	R5	200	170M1370 ² or 170M2617
100	ACS550-Px-124A-4	R6	160	170M1369 ²
125	ACS550-Px-157A-4	R6	200	170M1370 ² or 170M2617
150	ACS550-Px-180A-4	R6	315	170M1372 ² or 170M2619
200	ACS550-Px-246A-4	R6	315	170M1372 ² or 170M2619
200	ACS550-Px-245A-4	R7	400	JJS-400
250	ACS550-Px-316A-4	R8	400	JJS-400
300	ACS550-Px-368A-4	R8	400	JJS-400
350	ACS550-Px-414A-4	R8	600	JJS-600
400	ACS550-Px-486A-4	R8	600	JJS-600
450	ACS550-Px-526A-4	R8	800	JJS-800
500	ACS550-Px-602A-4	R8	800	JJS-800
550	ACS550-Px-645A-4	R8	800	JJS-800

1. "Px" represents both PC and PD.

2. UL Type / NEMA 3R enclosed units are provided with Bussman Type JJS or equivalent fuses. Fuse ratings shown relate to latest production. Where installed product includes fuses of a lower rating, either rating may be used.

Fuses, 600 Volt, Fuses

600 Volt		Base Drive Frame Size	Drive Input Fuse Ratings	
HP	Identification ¹		Amps (600V)	Bussmann Type
2	ACS550-PD-02A7-6	R2	15	KTK-R-15
3	ACS550-PD-03A9-6	R2	15	KTK-R-15
5	ACS550-PD-06A1-6	R2	15	KTK-R-15
7.5	ACS550-PD-09A0-6	R2	15	KTK-R-15
10	ACS550-PD-011A-6	R2	30	KTK-R-30
15	ACS550-PD-017A-6	R2	30	KTK-R-30
20	ACS550-PD-022A-6	R3	60	JJS-60
25	ACS550-PD-027A-6	R3	60	JJS-60
30	ACS550-PD-032A-6	R4	100	JJS-100
40	ACS550-PD-041A-6	R4	100	JJS-100
50	ACS550-PD-052A-6	R4	100	JJS-100
60	ACS550-PD-062A-6	R4	100	JJS-100
75	ACS550-Px-077A-6	R6	200	170M1370 ² or 170M2617
100	ACS550-Px-099A-6	R6	200	170M1370 ² or 170M2617
125	ACS550-Px-125A-6	R6	200	170M1370 ² or 170M2617
150	ACS550-Px-144A-6	R6	200	170M1370 ² or 170M2617

1. "Px" represents both PC and PD.

2. UL Type / NEMA 3R enclosed units are provided with Bussman Type JJS or equivalent fuses. Fuse ratings shown relate to latest production. Where installed product includes fuses of a lower rating, either rating may be used.

Drive's Power Connection Terminals (Supplement to ACS550-01/U1 User's Manual)

The following tables show maximum wire size and required tightening torque for incoming power, motor, and grounding terminals.

208/240 Volt, Terminals

208/240 Volt			Power Wiring Data ²						
HP	Type Code ¹	Base Drive Frame Size	Circuit Breaker UL Type/ NEMA 1 & 12	Circuit Breaker UL Type 3R/ NEMA 3R	Disconnect Switch UL Type/ NEMA 1 & 12	Disconnect Switch UL Type 3R/NEMA 3R	Motor Terminals	Ground Lugs UL Type/ NEMA 1 & 12	Ground Lugs UL Type 3R/ NEMA 3R
1	ACS550-Px-04A6-2	R1	#10 35 in-lbs	#10 62 in-lbs	#10 7 in-lbs	#10 7 in-lbs	Refer to "Drives Power Connection Terminals" in the ACS550- 01/U1 User Manual	#10 35 in-lbs	#10 40 in-lbs
1.5	ACS550-Px-06A6-2	R1							
2	ACS550-Px-07A5-2	R1							
3	ACS550-Px-012A-2	R1							
5	ACS550-Px-017A-2	R1							
7.5	ACS550-Px-024A-2	R2	#6 45 in-lbs	#6 62 in-lbs	#8 7 in-lbs	#8 7 in-lbs		#6 35 in-lbs	#6 40 in-lbs
10	ACS550-Px-031A-2	R2				#6 7 in-lbs			
15	ACS550-Px-046A-2	R3	#3 50 in-lbs	#3 62 in-lbs	#4 18 in-lbs	#4 18 in-lbs		#3 50 in-lbs	#3 50 in-lbs
20	ACS550-Px-059A-2	R3							
25	ACS550-Px-075A-2	R4	#1 50 in-lbs	#1 50 in-lbs	#1 55 in-lbs	#1 55 in-lbs		#2 50 in-lbs	#2 50 in-lbs
30	ACS550-Px-088A-2	R4							
40	ACS550-Px-114A-2	R4							
50	ACS550-Px-143A-2	R6							
60	ACS550-Px-178A-2	R6	350 MCM 274 in-lbs	300 MCM 200 in-lbs	300 MCM 275 in-lbs	300 MCM 200 in-lbs	3 x #3/0 250 in-lbs	#2/0 275 in-lbs	
75	ACS550-Px-221A-2	R6							
100	ACS550-Px-248A-2	R6							
			2 x 500 MCM 274 in-lbs	2 x 500 MCM 275 in-lbs	2 x 500 MCM 274 in-lbs	2 x 500 MCM 275 in-lbs		350 MCM 100 in-lbs	

1. "Px" represents both PC and PD.

2. Torque values shown relate to current production. Check component labels on previously installed units for required tightening torque.

480 Volt, Terminals

480 Volt			Power Wiring Data ²						
HP	Type Code ¹	Base Drive Frame Size	Circuit Breaker UL Type/ NEMA 1 & 12	Circuit Breaker UL Type 3R/ NEMA 3R	Disconnect Switch UL Type/ NEMA 1 & 12	Disconnect Switch UL Type 3R/NEMA 3R	Motor Terminals	Ground Lugs UL Type/ NEMA 1 & 12	Ground Lugs UL Type 3R/ NEMA 3R
1/1.5	ACS550-Px-03A3-4	R1	#10 35 in-lbs	#10 62 in-lbs	#10 7 in-lbs	#10 7 in-lbs	Refer to "Drives Power Connection Terminals" in the ACS550- 01/U1 User Manual	#10 35 in-lbs	#10 40 in-lbs
2	ACS550-Px-04A1-4	R1							
3	ACS550-Px-06A9-4	R1							
5	ACS550-Px-08A8-4	R1							
7.5	ACS550-Px-012A-4	R1							
10	ACS550-Px-015A-4	R2	#6 45 in-lbs	#6 62 in-lbs	#8 7 in-lbs	#8 7 in-lbs		#6 35 in-lbs	#6 40 in-lbs
15	ACS550-Px-023A-4	R2							
20	ACS550-Px-031A-4	R3	#3 50 in-lbs	#3 62 in-lbs	#4 18 in-lbs	#4 18 in-lbs		#3 50 in-lbs	#3 50 in-lbs
25	ACS550-Px-038A-4	R3							
30	ACS550-Px-045A-4	R3							
40	ACS550-Px-059A-4	R4	#1 50 in-lbs	#1 62 in-lbs	#1 55 in-lbs	#1 55 in-lbs		#1 50 in-lbs	#2 50 in-lbs
50	ACS550-Px-072A-4	R4							
60	ACS550-Px-078A-4	R4							
75	ACS550-Px-097A-4	R4							
100	ACS550-Px-125A-4	R5	350 MCM 274 in-lbs	300 MCM 200 in-lbs	#1/0 70 in-lbs	#1/0 70 in-lbs		3 x #3/0 250 in-lbs	#2/0 375 in-lbs
125	ACS550-Px-157A-4	R6							
150	ACS550-Px-180A-4	R6							
200	ACS550-Px-246A-4	R6	2 x 500 MCM 274 in-lbs	2 x 500 MCM 275 in-lbs	2 x 500 MCM 274 in-lbs	2 x 500 MCM 275 in-lbs		5 Bus Bar Holes (13/32")	350 MCM 100 in-lbs
250	ACS550-PC-316A-4	R8							
300	ACS550-PC-368A-4	R8							
350	ACS550-PC-414A-4	R8							
400	ACS550-PC-486A-4	R8							
450	ACS550-PC-526A-4	R8							
500	ACS550-PC-602A-4	R8							
550	ACS550-PC-645A-4	R8	3 x 400 MCM 375 in-lbs	3 x 400 MCM 375 in-lbs	3 x 400 MCM 375 in-lbs	3 x 400 MCM 375 in-lbs			

1. "Px" represents both PC and PD.

2. Torque values shown relate to current production. Check component labels on previously installed units for required tightening torque.

600 Volt, Terminals

600 Volt			Power Wiring Data ²							
HP	Type Code ¹	Frame Size	Circuit Breaker UL Type/ NEMA 1 & 12	Circuit Breaker UL Type 3R/ NEMA 3R	Disconnect Switch UL Type/ NEMA 1 & 12	Disconnect Switch UL Type 3R/NEMA 3R	Motor Terminals	Ground Lugs UL Type/ NEMA 1 & 12	Ground Lugs UL Type 3R/ NEMA 3R	
2	ACS550-Px-02A7-6	R2	#6 62 in-lbs	#6 62 in-lbs	#8 7 in-lbs	#8 7 in-lbs	Refer to "Drives Power Connection Terminals" in the ACS550- 01/U1 User Manual	#6 35 in-lbs	#6 40 in-lbs	
3	ACS550-Px-03A9-6	R2								
5	ACS550-Px-06A1-6	R2								
7.5	ACS550-Px-09A0-6	R2								
10	ACS550-Px-011A-6	R2								
15	ACS550-Px-017A-6	R2								
20	ACS550-Px-022A-6	R3	#3 62 in-lbs	#3 62 in-lbs	#4 18 in-lbs	#4 18 in-lbs		#3 50 in-lbs	#3 50 in-lbs	
25	ACS550-Px-027A-6	R3								
30	ACS550-Px-032A-6	R4								
40	ACS550-Px-041A-6	R4	#1 62 in-lbs	#1 62 in-lbs	#4 18 in-lbs	#1 55 in-lbs		#1 50 in-lbs	#2 50 in-lbs	#2 50 in-lbs
50	ACS550-Px-052A-6	R4								
60	ACS550-Px-062A-6	R4								
75	ACS550-Px-077A-6	R6	350 MCM 274 in-lbs	300 MCM 275 in-lbs	#1/0 70 in-lbs	#1/0 70 in-lbs	3 x #3/0 250 in-lbs	#2/0 375 in-lbs		
100	ACS550-Px-099A-6	R6								
125	ACS550-Px-125A-6	R6			300 MCM 275 in-lbs	300 MCM 200 in-lbs				
150	ACS550-Px-144A-6	R6								

1. "Px" represents both PC and PD.

2. Torque values shown relate to current production. Check component labels on previously installed units for required tightening torque.

Motor Connections

Motor Connection Specifications – R7/R8

Motor Connection Specifications				
Maximum Motor Cable Length	Frame Size	Max. Motor Cable Length*		
		$f_{sw} = 1 \text{ or } 4 \text{ kHz}$		$f_{sw} = 8 \text{ kHz or } 12 \text{ kHz}$
	R7...R8	300 m	980 ft	Does not apply



* Warning! Using a motor cable longer than specified in the chart above may cause permanent damage to the drive.

Cooling – R7/R8

Cooling Specifications	
Method	Internal fan, flow direction from bottom to top.
Requirement	<ul style="list-style-type: none"> R7/R8: Free space in front of enclosure: 152 mm (6 in). R7/R8: Free space above enclosure: None required for cooling. R7/R8: Free space at sides of enclosure: None required for cooling. R7/R8: Also see “Additional Free Space Recommendations” on page 37.

Air Flow, 480 Volt Drives – R7/R8

The following table lists heat loss and air flow data for 480 Volt drives.

Drive		Heat Loss		Air Flow	
ACS550-xx-	Frame Size	W	BTU/Hr	m ³ /h	ft ³ /min
-245A-4	R7	3850	13000	300	540
-316A-4	R8	5300	18000	700	1220
-368A-4	R8	6850	23000	700	1220
-414A-4	R8	7000	24000	700	1220
-486A-4	R8	7600	26000	700	1220
-526A-4	R8	7800	27000	700	1220
-602A-4	R8	8100	28000	700	1220
-645A-4	R8	9100	31000	700	1220

Dimensional References

The following tables contain dimensional references that identify the dimensional information applying to a given type code.

208/240V Drive with Disconnect

HP	Type Code ¹	AMP	Base Drive Frame	UL Type / NEMA 1 Dim. Ref. Page 34	(+B055) UL Type / NEMA 12 Dim. Ref. Page 35	(+B058) UL Type / NEMA 3R Dim. Ref. Page 36
1	ACS550-Px-04A6-2	4.6	R1	PX1-1	PX12-1	PX3R-1
1.5	ACS550-Px-06A6-2	6.6	R1	PX1-1	PX12-1	PX3R-1
2	ACS550-Px-07A5-2	7.5	R1	PX1-1	PX12-1	PX3R-1
3	ACS550-Px-012A-4	11.8	R1	PX1-1	PX12-1	PX3R-1
5	ACS550-Px-017A-2	16.7	R1	PX1-1	PX12-1	PX3R-1
7.5	ACS550-Px-024A-2	24.2	R2	PX1-2	PX12-2	PX3R-2
10	ACS550-Px-031A-2	30.8	R2	PX1-2	PX12-2	PX3R-3
15	ACS550-Px-046A-2	46.2	R3	PX1-3	PX12-3	PX3R-3
20	ACS550-Px-059A-2	59.4	R3	PX1-3	PX12-3	PX3R-3
25	ACS550-Px-075A-2	74.8	R4	PX1-4	PX12-4	PX3R-4
30	ACS550-Px-088A-2	88	R4	PX1-5	PX12-5	PX3R-5
40	ACS550-Px-114A-2	114	R4	PX1-5	PX12-5	PX3R-5
50	ACS550-Px-143A-2	143	R6	PX1-6	PX12-6	PX3R-6
60	ACS550-Px-178A-2	178	R6	PX1-6	PX12-6	PX3R-6
75	ACS550-Px-221A-2	221	R6	PX1-6	PX12-6	PX3R-6
100	ACS550-Px-248A-2	248	R6	PX1-6	PX12-6	PX3R-6

1. "Px" represents both PC and PD.

480V Drive with Disconnect

HP	Type Code ¹	AMP	Base Drive Frame	UL Type / NEMA 1 Dim. Ref. Page 34	(+B055) UL Type / NEMA 12 Dim. Ref. Page 35	(+B058) UL Type / NEMA 3R Dim. Ref. Page 36
1.5	ACS550-Px-03A3-4	3.3	R1	PX1-1	PX12-1	PX3R-1
2	ACS550-Px-04A1-4	4.1	R1	PX1-1	PX12-1	PX3R-1
3	ACS550-Px-06A9-4	6.9	R1	PX1-1	PX12-1	PX3R-1
5	ACS550-Px-08A8-4	8.8	R1	PX1-1	PX12-1	PX3R-1
7.5	ACS550-Px-012A-4	11.9	R1	PX1-1	PX12-1	PX3R-1
10	ACS550-Px-015A-4	15.4	R2	PX1-2	PX12-2	PX3R-2
15	ACS550-Px-023A-4	23	R2	PX1-2	PX12-2	PX3R-2
20	ACS550-Px-031A-4	31	R3	PX1-3	PX12-3	PX3R-3
25	ACS550-Px-038A-4	38	R3	PX1-3	PX12-3	PX3R-3
30	ACS550-Px-045A-4	44	R3	PX1-3	PX12-3	PX3R-3
40	ACS550-Px-059A-4	59	R4	PX1-4	PX12-4	PX3R-4
50	ACS550-Px-072A-4	72	R4	PX1-4	PX12-4	PX3R-4
60	ACS550-Px-078A-4	77	R4	PX1-4	PX12-4	PX3R-4
75	ACS550-Px-097A-4	96	R4	PX1-5	PX12-5	PX3R-5
100	ACS550-Px-125A-4	124	R5	PX1-5	PX12-5	PX3R-6
125	ACS550-Px-157A-4	157	R6	PX1-6	PX12-6	PX3R-6
150	ACS550-Px-180A-4	180	R6	PX1-6	PX12-6	PX3R-6
200	ACS550-Px-246A-4	245	R6	PX1-6	PX12-6	PX3R-6
250	ACS550-PC-316A-4	316	R8	PX1-8	PX12-8	
300	ACS550-PC-368A-4	368	R8	PX1-8	PX12-8	
350	ACS550-PC-414A-4	414	R8	PX1-8	PX12-8	
400	ACS550-PC-486A-4	486	R8	PX1-8	PX12-8	
450	ACS550-PC-526A-4	526	R8	PX1-8	PX12-8	
500	ACS550-PC-602A-4	602	R8	PX1-8	PX12-8	
550	ACS550-PC-645A-4	645	R8	PX1-8	PX12-8	

1. "Px" represents both PC and PD.

600V Drive with Disconnect

HP	Type Code ¹	AMP	Base Drive Frame	UL Type / NEMA 1 Dim. Ref. Page 34	(+B055) UL Type / NEMA 12 Dim. Ref. Page 35	(+B058) UL Type / NEMA 3R Dim. Ref. Page 36
2	ACS550-Px-02A7-6	2.7	R2	PX1-2	PX12-2	PX3R-2
3	ACS550-Px-03A9-6	3.9	R2	PX1-2	PX12-2	PX3R-2
5	ACS550-Px-06A1-6	6.1	R2	PX1-2	PX12-2	PX3R-2
7.5	ACS550-Px-09A0-6	9	R2	PX1-2	PX12-2	PX3R-2
10	ACS550-Px-011A-6	11	R2	PX1-2	PX12-2	PX3R-2
15	ACS550-Px-017A-6	17	R2	PX1-2	PX12-2	PX3R-2
20	ACS550-Px-022A-6	22	R3	PX1-3	PX12-3	PX3R-3
25	ACS550-Px-027A-6	27	R3	PX1-3	PX12-3	PX3R-3
30	ACS550-Px-032A-6	32	R4	PX1-4	PX12-4	PX3R-4
40	ACS550-Px-041A-6	41	R4	PX1-4	PX12-4	PX3R-4
50	ACS550-Px-052A-6	52	R4	PX1-4	PX12-4	PX3R-4
60	ACS550-Px-062A-6	62	R4	PX1-4	PX12-4	PX3R-4
75	ACS550-Px-077A-6	77	R6	PX1-6	PX12-6	PX3R-6
100	ACS550-Px-099A-6	99	R6	PX1-6	PX12-6	PX3R-6
125	ACS550-Px-125A-6	125	R6	PX1-6	PX12-6	PX3R-6
150	ACS550-Px-144A-6	144	R6	PX1-6	PX12-6	PX3R-6

1. "Px" represents both PC and PD.

Dimensions and Weights (Supplement to ACS550-01/U1 User’s Manual)

Dimensions: ACS550-Px UL Type / NEMA 1

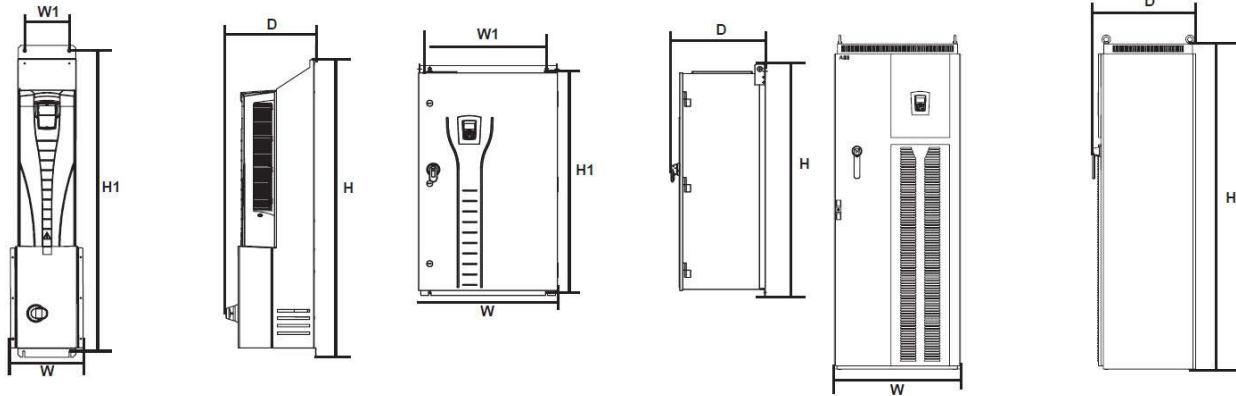

Wall Mount (PX1-1 - PX1-4)

Wall Mount (PX1-5 - PX1-6)

Floor Mount (PX1-8)

Dimension Reference	UL Type / NEMA 1 Mounting Dimensions mm [inches]			UL Type / NEMA 1 Dimensions and Weights mm kg [inches] [lbs]				Dimension Drawing
	H1	W1	Mouting Hardware	Height (H)	Weight (W)	Depth (D)	Weight	
PX1-1	712 [28]	98 [3.9]	M6 [0.25]	729 [28.7]	198 7.8	283 11.2	15 33	3AUA000008216 Sheet 1
PX1-2	812 [32]	98 [3.9]	M6 [0.25]	829 [32.6]	198 [7.8]	295 [11.6]	19 [42]	3AUA000008218 Sheet 1
PX1-3	983 [38.7]	160 [6.3]	M6 [0.25]	1013 [39.9]	260 [10.2]	304 [11.9]	34 [75]	3AUA000008220 Sheet 1
PX1-4	1117 [44]	160 [6.3]	M6 [0.25]	1147 [45.2]	260 [10.2]	332 [13.1]	43 [95]	3AUA000008221 Sheet 1
PX1-5	1175 [46.3]	600 [23.6]	M10 [0.375]	1212 [47.7]	713 [28.1]	483 [19]	121 [267]	3AUA000021148 Sheet 1
PX1-6	1175 [46.3]	600 [23.6]	M10 [0.375]	1212 [47.7]	713 [28.1]	483 [19]	163 [359]	3AUA000021148 Sheet 1
PX1-8 ¹	Free Standing		Ø16 [Ø0.63]	2125 [83.7]	806 [31.7]	659 [25.9]	360 [794]	3AUA000021152 Sheet 1

1. See page 37 for mounting dimension details and additional free space recommendations.

Dimensions: ACS550-PxR UL Type / NEMA 12

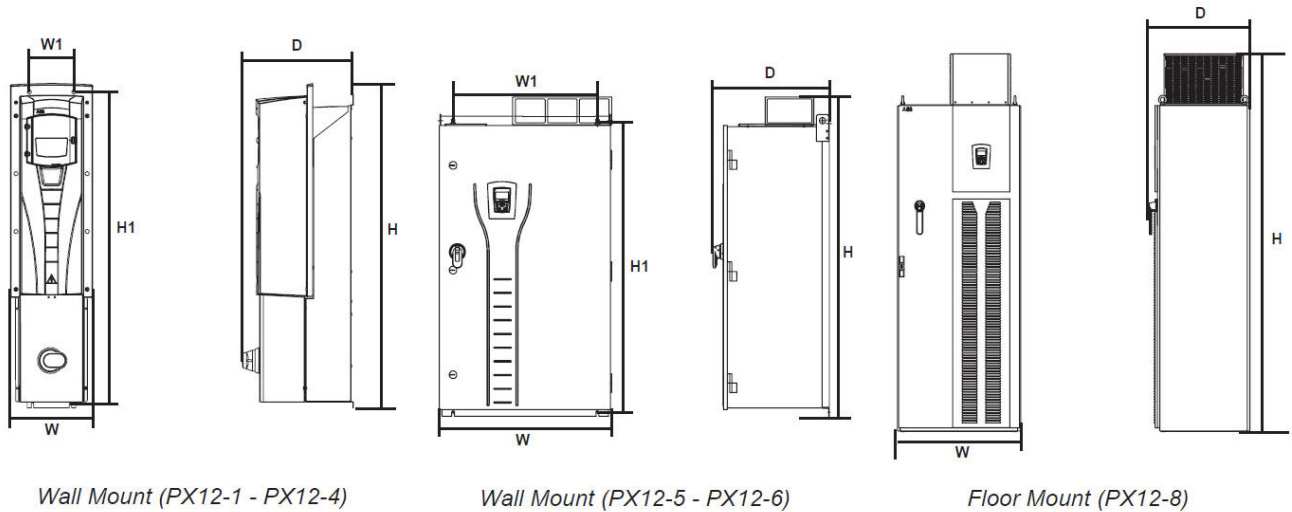

Dimension Reference	UL Type / NEMA 12 Mounting Dimensions mm [inches]			UL Type / NEMA 12 Dimensions and Weights mm kg [inches] [lbs]				
	H1	W1	Mounting Hardware	Height (H)	Weight (W)	Depth (D)	Weight	Drawing Dimension
PX12-1	712 [28]	98 [3.9]	M6 [0.25]	744 [29.3]	221 [8.7]	283 [11.2]	17 [37]	3AUA0000008216 Sheet 2
PX12-2	812 [32]	98 [3.9]	M6 [0.25]	844 [33.2]	221 [8.7]	295 [11.6]	21 [46]	3AUA0000008218 Sheet 2
PX12-3	983 [38.7]	160 [6.3]	M6 [0.25]	1030 [40.6]	267 [10.5]	304 [11.9]	36 [79]	3AUA0000008220 Sheet 2
PX12-4	1117 [44]	160 [6.3]	M6 [0.25]	1163 [45.8]	267 [10.5]	332 [13.1]	45 [99]	3AUA0000008221 Sheet 2
PX12-5	1175 [46.3]	600 [23.6]	M10 [0.375]	1380 [54.3]	713 [28.1]	483 [19]	121 [267]	3AUA0000021149 Sheet 1
PX12-6	1175 [46.3]	600 [23.6]	M10 [0.375]	1380 [54.3]	713 [28.1]	483 [19]	163 [359]	3AUA0000021149 Sheet 1
PX12-8 ¹	Free Standing		Ø16 [Ø0.63]	2377 [93.6]	806 [31.7]	659 [25.9]	380 [838]	3AUA0000021153 Sheet 1

1. See page 37 for mounting dimension details and additional free space recommendations.

Dimensions: ACS550-Px UL Type / NEMA 3R

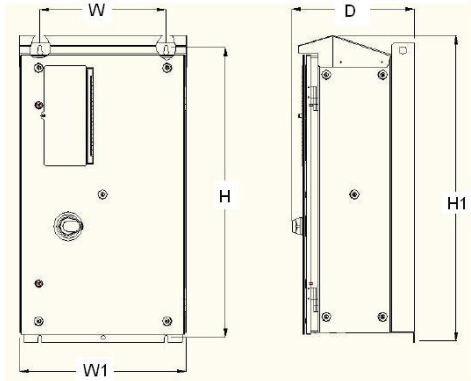

Wall Mount (PX3R-1 - PX3R-4)

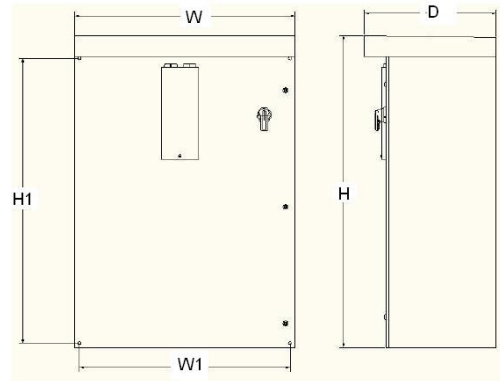

Wall Mount (PX3R-5 - PX3R-6)

Dimension Reference	UL Type / NEMA 3R Mounting Dimensions mm [inches]			UL Type / NEMA 3R Dimensions and Weights mm kg [inches] [lbs]				
	H1	W1	Mounting Hardware	Height (H)	Weight (W)	Depth (D)	Weight	Drawing Dimension
PX3R-1	810 [31.9]	320 [12.6]	M10 [0.375]	865 [34]	452 [17.8]	343 [13.5]	58 [128]	3AUA0000016377 Sheet 1
PX3R-2	810 [31.9]	320 [12.6]	M10 [0.375]	865 [34]	452 [17.8]	343 [13.5]	61 [134]	3AUA0000016377 Sheet 1
PX3R-3	918 [36.1]	400 [15.7]	M10 [0.375]	968 [38.1]	530 [20.9]	389 [15.3]	80 [176]	3AUA0000016380 Sheet 1
PX3R-4	918 [36.1]	400 [15.7]	M10 [0.375]	968 [38.1]	530 [20.9]	389 [15.3]	88 [194]	3AUA0000016380 Sheet 1
PX3R-5	876 [34.5]	724 [28.5]	M10 [0.375]	991 [39]	762 [30]	394 [15.5]	92.3 [203]	3AUA0000060123 Sheet 2
PX3R-6	1181 [46.5]	876 [34.5]	M10 [0.375]	1295 [51]	914 [36]	546 [21.5]	179.1 [395]	3AUA0000060124 Sheet 2

Note! UL Type 3R, PX3R-1, PX3R-2, PX3R-3 & PX3R-4 enclosures are designed to be mounted on a wall. Mounting these 3R enclosures on an open rack system requires the use of the supplied 3R enclosure back plates to maintain 3R integrity. See document #3AUA0000113577 for more details.

UL Type/NEMA 1&12, Floor Mount Enclosure Mounting Dimensions

UL Type/NEMA 1 & 12 – Floor Mount Enclosure Mounting Dimensions			
Ref.	R7 & R8		Top View
	mm	in	
W	806	31.7	
D	659	25.9	
a	675	26.6	
b	474.5	18.7	
c	61	2.4	
d	65.5	2.6	
Mounting Hardware			
	11 mm	13/32	

Additional Free Space Recommendations

In addition to the free space requirements for cooling (“Cooling - R7/R8”), allow:

- 800 mm (31.5 in) in front of UL Type / NEMA 1&12 floor mount enclosures – room for the cabinet door to swing open.
- 305 mm (12 in) above UL Type 12 / NEMA 12 floor mount enclosures – room for fan replacement.

Applicable Standards

Drive compliance with the following standards is identified by the standards “marks” on the type code label.

Mark	Applicable Standards	
	UL 508C and C22.2 No. 14	UL Standard for Safety, Power Conversion Equipment, second edition and CSA Standard for Industrial Control Equipment
	UL 508A	UL Standard for Safety, Industrial Control Panels
	C22.2 No. 14	CSA Standard for Industrial Control Equipment

Compliance is valid with the following provisions:

- The motor and control cables are chosen as specified in this manual.
- The installation rules of this manual are followed.

Index

Refer to the ACS550-01/U1 User's Manual index for topics not listed here.

A		H	
air flow	30	heat loss	30
C		heatsink	
capacitor		maintenance interval	17
charge, maintenance interval	17	I	
connection points		input disconnect	
floor mounted enclosures	14	see disconnect	
wall mounted enclosures	13	input power	
control panel		fuses	24
maintenance interval, battery	17	installation	
cooling	30	flow chart	6
D		preparation	7
dimensions		L	
mounting, R7...R8	37	location, mounting	9
UL Type / NEMA 1	34	M	
UL Type / NEMA 12	35	maintenance	
UL Type / NEMA 3R	36	drive module fan replacement	17
disconnect		enclosure fan replacement	18
diagram	4	intervals	17
drive		R7/R8 enclosure exhaust filter	21
fan replacement	17	manuals, listing	ii
proper lifting	7	motor	
E		connection specifications	30
enclosure, NEMA 12		motor cable	
air filter maintenance	19	max. length	30
fan replacement	18	R	
F		ratings	23
fan, drive module		S	
maintenance interval	17	safety	1
replacement procedure	17	specifications	
fan, enclosure		cooling	30
maintenance interval	17	motor connections	30
replacement procedure	18	standards	37
filter, enclosure		C22.2 No. 14	37
NEMA 3R, maintenance interval	17	UL 508C	37
R5/R6 inlet, maintenance interval	17		
R7/R8, exhaust, maintenance interval	17		
R7/R8, exhaust, maintenance procedure	21		
R7/R8, inlet, maintenance interval	17		
free space			
for access, R7/R8	37		
for cooling	30		
fuses	24		
208...240 volt drives	24		
380...480 volt drives	25		
500...600 volt drives	25		

W

warning

- automatic start up 1
- dangerous voltages. 1
- listing. 1
- parallel control connections. 1
- qualified installer 1

wiring

- connection diagrams, floor mounted 14
- connection diagrams, wall mounted 13
- line input installation 15
- overview 13
- requirements 12



ABB Oy
AC Drives
P.O. Box 184
FIN-00381 HELSINKI
FINLAND
Telephone +358 10 22 11
Telefax +358 10 22 22681
Internet <http://www.abb.com>

ABB Inc.
Automation Technologies
Drives & Machines
16250 West Glendale Drive
New Berlin, WI 53151
USA
Telephone +1 262 785-3200
+1 800 HELP-365
Telefax +1 262 780-5135
Internet www.abb-drives.com

3AJUA0000012131 REV H / EN
EFFECTIVE: 05/01/2012
SUPERSEDES: 10/22/2009