LOW VOLTAGE AC DRIVES

ABB industrial drives

ACS880, single drives

0.75 to 3300 hp (0.55 to 3200 kW)



Reliability, performance and safety. ACS880 series.

Table of contents

04–05	The all-compatible ACS880 series
06–07	Simplify your world without limiting your possibilities
08	Easy to use
09	Simple to select and install
10	Extended connectivity
11	Reliability
12	Cost and time savings with drive-based functional safety
13	Compatible with all kinds of processes
14–15	Application- and industry-specific solutions and programmability
16–17	Standard interface and extensions for plug-in connectivity
18	How to select a drive
19	Technical data
20–22	Wall-mounted single drives, ACS880-01
23–25	Cabinet-built single drives, ACS880-07
26–29	Regenerative drives, ACS880-17
30–33	Ultra-low harmonic drives, ACS880-37
34–37	Dimensions
38	Control panel options
39	Save time, ease troubleshooting and improve drive performance with ABB smartphone apps
40	Connectivity to automation systems
41	PC tool options
42	Remote monitoring options
43	Additional interface options
44–45	Safety options
46–47	EMC – electromagnetic compatibility
48–49	ABB automation products
50	Services to match your needs
51	Drives service
52	A lifetime of peak performance
54–57	Summary of features and options

The all-compatible ACS880 series

Reliability and flexibility

The ACS880 is an all-compatible ABB industrial drive, offered in a range of wall-mounted drives, drive modules and cabinet-built drives.

ABB's all-compatible drives are designed to provide customers across industries and applications with unprecedented levels of compatibility and flexibility. Our ACS880 single drives are standalone drives. They are customized to meet the particular needs of specific industries, such as oil and gas, mining, metals, chemicals, cement, power plants, material handling, pulp and paper, sawmills, marine, water and wastewater, food and beverage, and automotive. They can control a wide range of applications, including cranes, extruders, winches, winders, conveyors, mixers, compressors, centrifuges, test benches, elevators, extruders, pumps and fans.

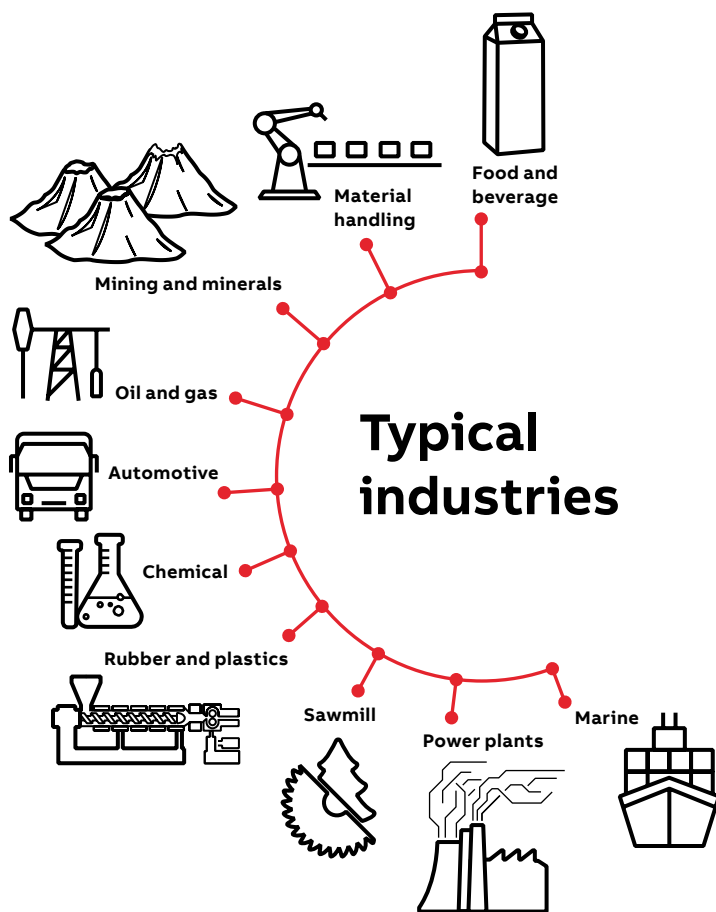

High quality

Reliability and consistent high quality

ACS880 drives are designed for customers who value high quality and robustness in their applications. They have features such as coated boards and high enclosure classes, making the ACS880 suitable for harsh conditions. Additionally, every ACS880 drive is factory-tested at full load to ensure maximum reliability. The tests include performance and all protective functions.

High performance, safety and configurability

The ACS880 offers the highest level of performance. The drives are equipped with ABB's signature direct torque control (DTC), which provides precise speed and torque control for all applications and supports virtually any type of motor.

Extensive ACS880 offering includes wall-mounted drives, drive modules and cabinet-built drives, as well as low harmonic and regenerative variants.

The ACS880 has all the essential features built-in reducing the time required for engineering, installation and commissioning. A wide range of options are also available to optimize the drive for different requirements, including certified, integrated safety features.



Simplify your world without limiting your possibilities

The ACS880 industrial drive is equipped with built-in features that simplify ordering and delivery, and reduce commissioning costs, since everything is provided in a single, compact and ready-to-use package.



Easy to use

- All-compatible ACS880 drives share the same easy-to-use user interface.

See page 8



Up to UL Type 12

Simple to select and install

- All the essential features built-in for simple drive selection, installation and use
- Flexible product configurations
- Enclosure classes for different environments
- Possibility for flange mounting

See page 9



Extended connectivity

- Communication with all major automation networks
- Remote monitoring
- Mobile connectivity
- Integration tools for PLCs from ABB and various other manufacturers

See page 10



9-year maintenance interval

Reliability

- Robust, long lifetime design for maximum reliability
- Removable memory unit
- Each drive factory tested at full load
- Nine-year service interval

See page 11



ACS880 drives are designed for maximum reliability



Cost and time savings with drive-based functional safety

- Safe torque off built-in as standard
- Optional safety modules for extended safety functions

See page 12



Compatible with all kinds of processes

- Direct torque control (DTC) for precise speed and torque control
- Support for various motor types
- Extensive selection of drives, including regenerative and ultra-low harmonic variants
- Global product approvals, e.g. CE, UL, cUL, CSA, marine certifications, ATEX
- Worldwide service and support

See page 13



Application- and industry-specific solutions and programmability

- Tailored, optimized solutions for various applications and industries
- Drive-based application programming

See page 14

Easy to use

All-compatible user interface saves commissioning and learning time

The ACS880 is part of ABB's all-compatible drives portfolio. Other drives in this portfolio are the ACS380, ACS480 and ACS580.

These drives share the same easy-to-use PC tools and multilingual control panels. To further enhance the user experience, they also have the same parameter structure, which saves time on commissioning and learning.

The drives also share the same communication options, simplifying the use of drives and spare parts handling.

Simplicity at your fingertips as standard

The control panel's assistants and pre-programmed application macros help you to set up the drive quickly and effectively. The intuitive, high-contrast, high-resolution display offers easy navigation in multiple languages.

The PC tool for commissioning and configuration provides extensive drive monitoring capabilities and quick access to drive settings, as well as features like a graphical interface for configuring safety functions, visual control diagrams, and direct links to user manuals.

The ACS880, part of the all-compatible drives portfolio



Simple to select and install

Built-in features simplify ordering and installation

All ACS880 drives have a choke for harmonic filtering, a Modbus RTU fieldbus interface, and safe torque off functionality as standard. Other built-in features, standard or optional, include EMC filters, brake choppers, low harmonic or regenerative functionality and various I/O extensions, fieldbus communication, and functional safety modules.

All essential features built-in

The built-in features make drive configuration simple – the number of external components is minimized and there is no need for extra enclosures. This cuts the engineering time, and reduces commissioning costs and the risk of errors. Built-in features simplify ordering and make installation fast and easy. As result, the whole drive system is more compact.

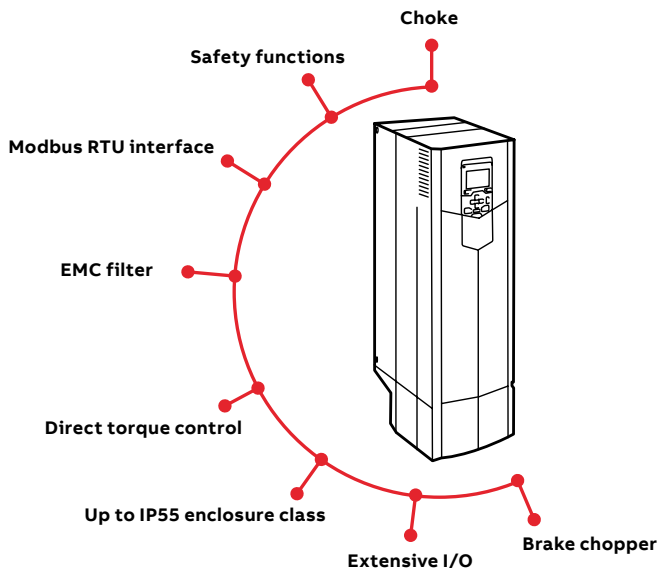

Different installation solutions

ACS880 offering has optimized variants for cabinet-building, wall-mounting and modules for cabinet assembly.

ACS880 offering also includes complete and compact solutions for dusty and wet environments with up to IP55 enclosure class.

Engineering support

ABB provides an extensive selection of support material and tools to help in engineering, such as:

- Dimensioning tools, e.g. DriveSize
- Safety circuit design tools
- EPLAN P8 macros
- A selection tool for choosing external components for the line and motor side of the drive, e.g. fuses and circuit breakers
- Electrical drawings
- Application guides
- Drive installation and configuration videos

These tools and support from our experts ensure that the drive system can be set up easily and reliably.

DriveSize dimensioning tool for selecting the optimal drive

DriveSize is designed to help select the optimal drive, motor and transformer for the application. Based on data supplied by the user, the tool calculates and suggests which drive and motors to use.

DriveSize is a free software and can be used either online or downloaded for PC from <http://new.abb.com/drives/software-tools/drivesize>.

Extended connectivity

Communication with all major automation networks

ACS880 drives come with Modbus RTU fieldbus interface and drive-to-drive communication link as standard. Plug-in connectivity adapters enable communication with all major industrial automation networks.

The drives support advanced fieldbus communication features:

- Redundant fieldbus connection
- Functional safety over fieldbus
- Multiple fieldbus communication
- Shared Ethernet connection – the Ethernet connection can use a shared network with Ethernet-based fieldbuses and PC tool

To minimize connectivity-related risks, cybersecurity is a built-in, integral part of the ACS880.

To simplify ACS880's connectivity to automation systems, ABB offers support tools for seamless integration with PLCs from ABB and several other manufacturers.

Remote monitoring

With a built-in web server and standalone data logger, the NETA-21 remote monitoring tool enables secure worldwide access to your drives.

Drive data can also be collected via a 3G mobile connection with the RMDE reliability monitoring device.



Mobile connectivity

The drive has a Bluetooth panel enabling easy connection to mobile devices.

ABB offers several smartphone applications, like Drivetune and Drivebase, to ease and enhance the use of ABB drives. These tools provide a user-friendly and easy-to-use approach for commissioning, servicing and using ABB drives.

Better connectivity and user experience

Reliability

Robust, long life time design

The ACS880 is designed to last for a long time, even in harsh conditions. The benefits include a nine-year service interval and good tolerance for vibrations and contamination.

Several design features make the ACS880 a safe choice:

- Coated circuit boards
- Minimized airflow through the control board section
- High IP class variants
- Designed for ambient temperatures up to 55°C
- Advanced IGBT and earth fault protections

Each ACS880 drive unit is tested in the factory at full load to ensure maximum reliability.

Removable memory unit

The memory unit stores the drive software, which includes parameter settings and motor data. This unit can be switched from one drive to another, allowing simple and rapid drive replacement without any special equipment, software loading, parameter settings, or other adjustments in the drive or automation system. It also eliminates the risk of software incompatibility. The new drive is ready to run as soon as the memory unit is plugged in.

9-year service interval



Advanced features for analyzing and resolving issues

The ACS880 has timers and counters that can be configured to remind you when the drive needs maintenance.

Accurate and reliable diagnostic information is obtained through alarm, limit and fault words. Data loggers store critical values before and during an event, such as a fault. The real-time clock allows you to see the exact times of events.

For faster remote support, all relevant drive data and changed parameters can be saved in a single file package that you can easily create with the PC tool or by creating a QR code with the control panel.

Cost and time savings with drive-based functional safety

Safety functions

ACS880 drives have a safe torque off (STO) function as a standard. Extended safety functions are provided by optional safety modules, which are easy to integrate inside the drive. Integration with automation systems is quick and reliable using PROFIsafe connectivity. Most safety functions achieve the SIL 3/PL e safety level.

Scalable safety with PROFIsafe and safety PLC

The safety functionality can be scaled to your needs. From STO wired to an emergency push button, to a complete safety system with PROFIsafe and a safety PLC, e.g. the AC500-S.

Safely limited speed with or without encoders

The SIL 3/PL e-certified safely limited speed (SLS) function prevents the motor from exceeding a defined speed limit, with or without using an encoder. This allows machine interaction to be performed at a safe speed without stopping the process.

Available safety functionality

The following safety functions are supported:

- Safe torque off (STO)
- Safe stop 1 (SS1)
- Safe stop emergency (SSE)
- Safe brake control (SBC)
- Safely-limited speed (SLS)
- Safe maximum speed (SMS)
- Prevention of unexpected startup (POUS)
- Safe direction (SDI)
- Safe speed monitor (SSM)
- Safe temperature monitoring (SMT)

Safety for explosive atmospheres

ACS880 and ABB Ex motors have been certified as a package providing a safe, proven solution for explosive atmospheres. ACS880 safety options for ATEX environments:

- ATEX-approved thermistor protection module
- ATEX-approved safe torque off

Integrated safety simplifies configuration

Easy configuration

Configuring the safety functions module is easy thanks to the graphical user interface of the Drive composer pro PC tool.

TÜV-certified safety design tool

The FSDT-01 functional safety design tool can be used to design complete safety circuits. It helps to increase the safety of users in the vicinity of machines. You can perform functional safety modeling, design, calculations and verification for machine functional safety.



Compatible with all kinds of processes

Direct torque control (DTC)

ABB's signature motor control technology provides precise speed and torque control, with or without an encoder, even close to zero speed. DTC provides reliable starts and rapid reactions to load or network changes, and ensures smooth and continuous operation. DTC provides optimal control, even with sine filters.

The energy optimizer feature maximizes motor efficiency by ensuring maximum torque per ampere, reducing the power drawn from the supply.

Support for different motor types

The ACS880 provides reliable control for various motors, such as squirrel cage, high-torque or servo-type permanent magnet, synchronous reluctance (SynRM), submersible and high-speed motors.

Regardless of the motor type, drive commissioning is easy, with no need for laborious manual tuning.

Low harmonic content

All ACS880 drives have a choke for harmonic reduction. If lower harmonic content is needed, an ultra-low harmonic variant is available. It produces exceptionally low harmonic content and meets the requirements of harmonics recommendations like IEEE519, IEC61000-3-12 and G5/4.

Regeneration of energy

The ACS880 offers a number of solutions for applications where electrical braking is needed. As standard, ACS880 drives have a flux braking feature that provides greater deceleration by increasing the motor flux. If this is not sufficient, the internal brake chopper can be used together with a brake resistor.

The most advanced solution is the ACS880 regenerative drive variant, which allows full, continuous braking, providing the possibility for remarkable energy savings.

Global product approvals and support

The ACS880 is a global product and has all the major global approvals, such as CE, UL, cUL, EAC, RCM and TÜV. Industry-specific approval, like different kinds of marine approval, ATEX and SEMI F47 are available either as standard or as an option.

For true global coverage, ABB offers worldwide support via its extensive pre- and after-sales network, structured to make sure that you have the experts you need close by, locally and globally.

Process all-compatible



Application- and industry-specific solutions and programmability

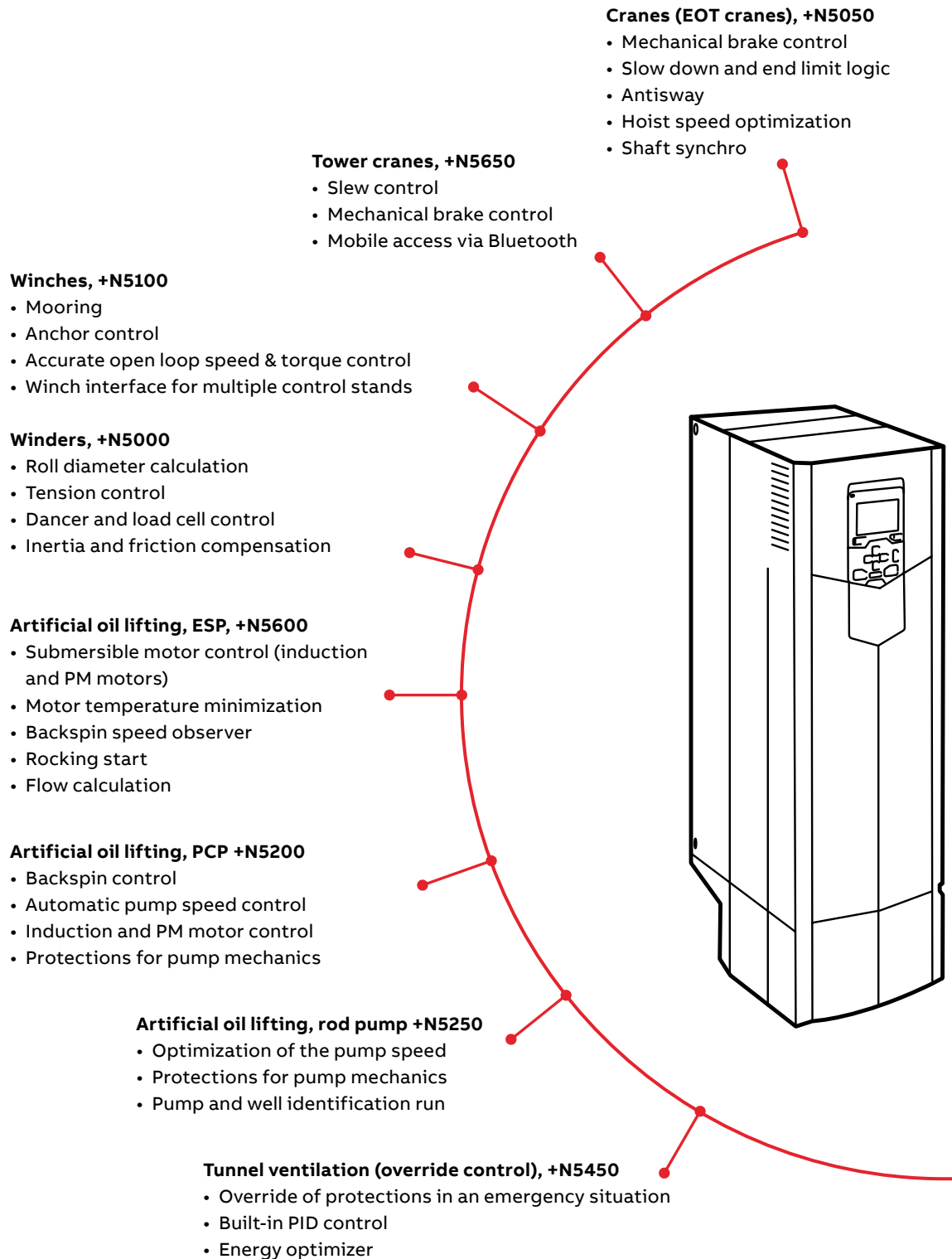

By working closely with customers over many years, ABB has developed application control programs and specific software features for specific applications and industries. This results in programs and features that include lessons learned from many customers, and that are designed to give you the flexibility to adapt the programs to your specific needs.

Advantages:

- Enhanced application usability
- Lower energy consumption
- Increased safety
- Reduced need for PLCs
- Protected machinery
- Optimized application productivity
- Optimized time usage and lower operational costs

Drive programming

To meet your specific application needs, you can customize your ACS880 with an extensive range of user-definable software settings (parameters) and adaptive programming. This makes fine-tuning the ready-made application control program functionalities easy. For further customization, drive application programming based on IEC 61131 standard is available for full PLC programmability. IEC programming uses the same programming environment as ABB PLCs. It is also easy to integrate the ACS880 with other components, such as PLCs and HMIs.

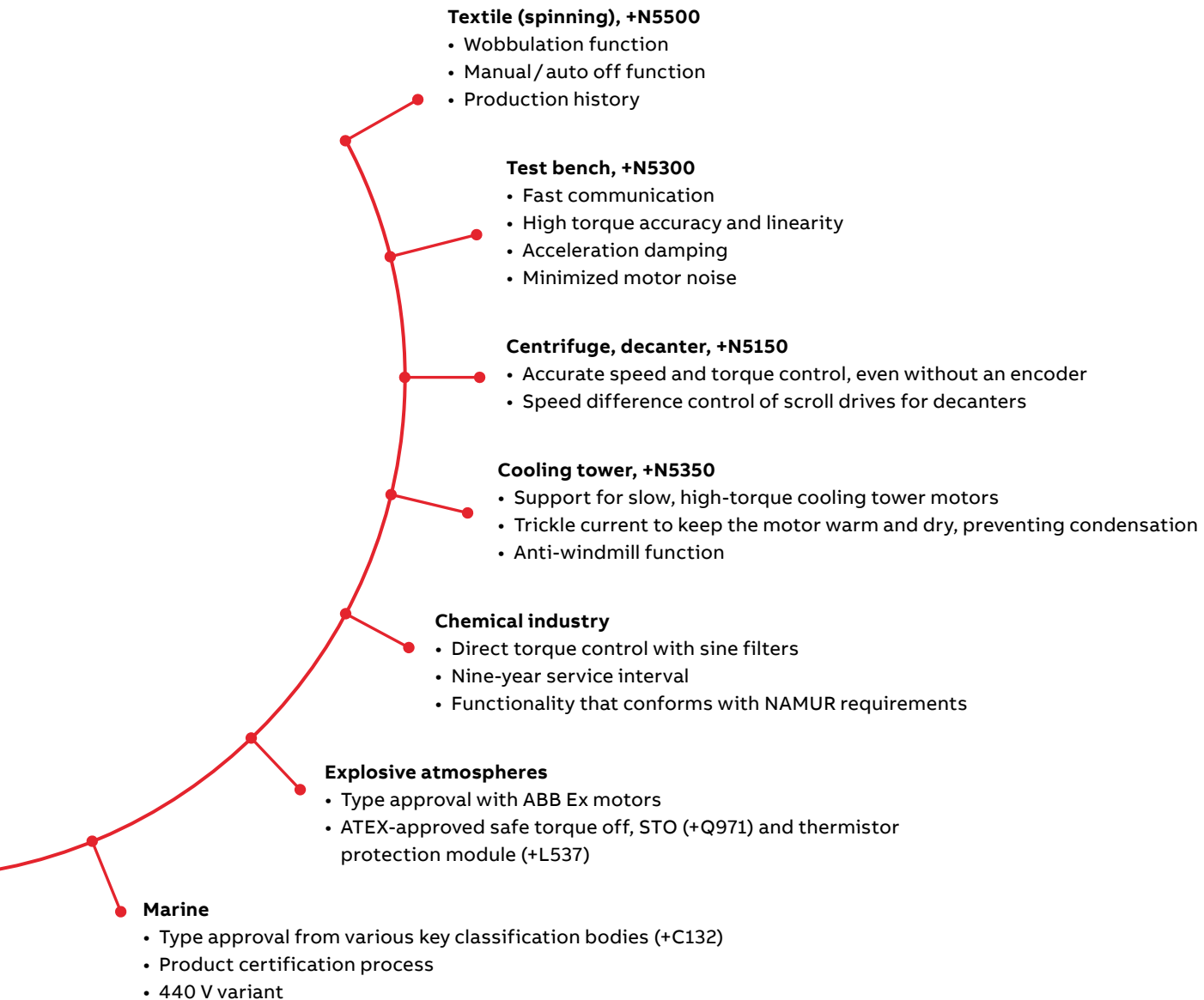

Standard interface and extensions for plug-in connectivity

—
01 Control unit ZCU

—
02 Example of a typical single drives input/output connection diagram. Variations may be possible. For further information, please see the ACS880 user manual.

ACS880 drives offer a wide range of standard interfaces. In addition, they offer three option slots that can be used for extensions, including fieldbus adapter modules, input/output extension modules, feedback modules, and a safety functions module. For I/O extensions, see page 40.



—
01

Control connections	Description
2 analog inputs (XAI)	Current input: -20 to 20 mA, R_{in} : 100 ohm Voltage input: -10 to 10 V, $R_{in} > 200$ kohm Resolution: 11 bit + sign bit
2 analog outputs (XAO)	0 to 20 mA, $R_{load} < 500$ ohm Frequency range: 0 to 300 Hz Resolution: 11 bit + sign bit
6 digital inputs (XDI)	Input type: NPN/PNP (DI1 to DI5), NPN (DI6) DI6 (XDI:6) can alternatively be used as an input for a PTC thermistor.
Digital input interlock (DIIL)	Input type: NPN/PNP
2 digital inputs/outputs (XDIO)	As input: 24 V logic levels: "0" < 5 V, "1" > 15 V R_{in} : 2.0 kohm Filtering: 0.25 ms As output: Total output current from 24 V DC is limited to 200 mA Can be set as pulse train input and output
3 relay outputs (XRO1, XRO2, XRO3)	250 V AC/30 V DC, 2 A
Safe torque off (XSTO)	For the drive to start, both connections must be closed
Drive-to-drive link (XD2D)	Physical layer: EIA-485
Built-in Modbus	EIA-485
Assistant control panel/PC tool connection	Connector: RJ-45

02

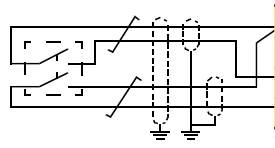
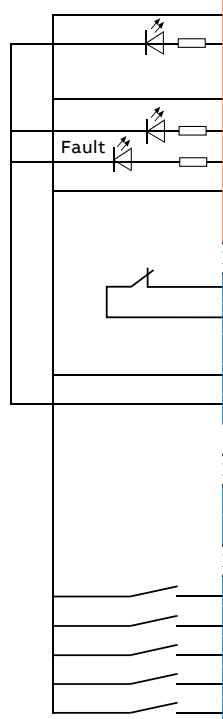
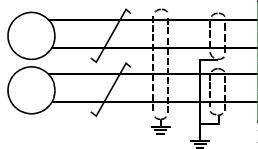
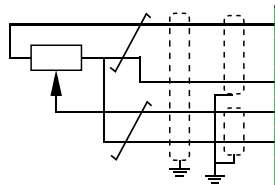

XPOW		External power input
1	+24VI	24 V DC, 2 A
2	GND	
XAI		Reference voltage and analog inputs
1	+VREF	10 V DC, R_L 1 to 10 kohm
2	-VREF	-10 V DC, R_L 1 to 10 kohm
3	AGND	Ground
4	AI1+	Speed reference
5	AI1-	0(2) to 10 V, R_{in} > 200 kohm
6	AI2+	By default not in use.
7	AI2-	0(4) to 20 mA, R_{in} > 100 ohm
J1	J1	AI1 current/voltage selection jumper
J2	J2	AI2 current/voltage selection jumper
XAO		Analog outputs
1	AO1	Motor speed rpm 0 to 20 mA, R_L < 500 ohm
2	AGND	
3	AO2	Motor current 0 to 20 mA, R_L < 500 ohm
4	AGND	
XD2D		Drive-to-drive link
1	B	Drive-to-drive link or built-in Modbus
2	A	
3	BGND	
J3	J3	Drive-to-drive link termination switch
XRO1, XRO2, XRO3		Relay outputs
11	NC	Ready 250 V AC/30 V DC 2 A
12	COM	
13	NO	
21	NC	Running 250 V AC/30 V DC 2 A
22	COM	
23	NO	
31	NC	Faulted (-) 250 V AC/30 V DC 2 A
32	COM	
33	NO	
XD24		Digital interlock
1	DIIL	Digital interlock
2	+24VD	+24 V DC 200 mA
3	DICOM	Digital input ground
4	+24VD	+24 V DC 200 mA
5	DIOGND	Digital input/output ground
J6		Ground selection switch
XDIO		Digital input/outputs
1	DIO1	Output: Ready
2	DIO2	Output: Running
XDI		Digital inputs
1	DI1	Stop (0)/Start (1)
2	DI2	Forward (0)/Reverse (1)
3	DI3	Reset
4	DI4	Acceleration and deceleration select
5	DI5	Constant speed 1 (1=On)
6	DI6	Not in use by default
XSTO		Safe torque off
1	OUT1	Safe torque off. Both circuits must be closed for the drive to start.
2	SGND	
3	IN1	
4	IN2	
X12		Safety functions module connection
X13		Control panel connection
X205		Memory unit connection

How to select a drive

The right drive is extremely easy to select. The following instructions show you how to order the right drive for your application.

1 Start by identifying the required drive variant and your supply voltage and select the related rating table. Or use ABB's DriveSize dimensioning tool.

2 Select your drive's order code (drive type) from the rating table based on the load current, or, if it is unknown, select the drive based on your motor's power and current ratings.

3 Choose your options and add the option codes to the drive's order code. Remember to use a "+" mark before each option code.

Control panel options

ABB Industrial Drives, ACS880, CATALOG

Bluetooth control panel, ACS-AP-W (standard control panel)
Commissioning and operation of the ACS880 is easy with the assistant control panel. The panel has a multilingual graphical display, Bluetooth connectivity and a USB interface for PC tool connection. The panel can be used with all drives belonging to ABB's AIA-compatible product portfolio.

There is no need to know any drive parameters, as the control panel helps you set up the essential settings quickly and get the drive into action. The Bluetooth connection enables the use of mobile apps like Drivertune. This app is available for free on the Google Play and the Apple App Store. Drivertune features include: commissioning, troubleshooting, monitoring and controlling the drive remotely. Drivertune also has full parameter access and backup and restore functionality.

Industrial control panel, ACS-AP-I
The ACS-AP-I industrial control panel has the same functionality as the ACS-AP-W Bluetooth panel, but without the Bluetooth connectivity.

Control panel mounting platform, DPMP-02 / 02
The DPMP-02 mounting platform is for flush mountings, and the DPMP-02-I is for surface mountings.

Option code	Description	Type designation
010000	No control panel	
010001	Industrial assistant control panel without Bluetooth connectivity	ACS-AP-I
010002	Control panel mounting platform, flush mounted, IP65 / UL Type 12	DPMP-02
010003	Control panel mounting platform, flush mounted, IP65 / UL Type 12	DPMP-02
010004	Control panel mounting platform, surface mounted, IP65 / UL Type 12	DPMP-02-I

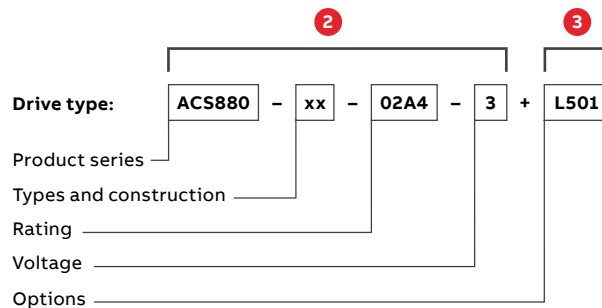

Technical data

Mains connection	
Voltage and power range	3-phase, U_{N2} 208 to 240 V, +10%/-15% (-01) 3-phase, U_{N3} 380 to 415 V, +10%/-15% (-01), ±10% (-07,-17-37) 3-phase, U_{N5} 380 to 500 V, +10%/-15% (-01), ±10% (-07,-17-37) 0.75 to 250 hp (0.55 to 250 kW) (-01) 60 to 3000 hp (45 to 2800 kW) (-07) 60 to 3300 hp (45 to 3200 kW) (-17,-37)
Frequency	50/60 Hz ±5%
Power factor	
ACS880-01, -07	$\cos\phi = 0.98$ (fundamental) $\cos\phi = 0.93$ to 0.95 (total)
ACS880-17, -37	$\cos\phi = 1$ (fundamental)
Efficiency (at nominal power)	ACS880-01, -07: 98% ACS880-17, -37: 97%
Motor connection	
Voltage	3-phase output voltage 0 to $U_{N2}/U_{N3}/U_{N5}/U_{N7}$
Frequency	0 to ±598 Hz ^{1) 2)}
Motor control	Direct torque control (DTC)
Torque control	Torque step rise time:
Open loop	<5 ms with nominal torque
Closed loop	<5 ms with nominal torque
	Non-linearity:
Open loop	± 4% with nominal torque
Closed loop	± 3% with nominal torque
Speed control	Static accuracy:
Open loop	10% of motor nominal slip
Closed loop	0.01% of nominal speed
	Dynamic accuracy:
Open loop	0.3 to 0.4% seconds with 100% torque step
Closed loop	0.1 to 0.2% seconds with 100% torque step
Product compliance	
CE	
Low Voltage Directive 2014/35/EU	
Machinery Directive 2006/42/EC	
EMC Directive 2014/30/EU	
ATEX Directive 2014/34/EU	
Quality assurance system ISO 9001 and Environmental system ISO 14001	
RoHS	
UL, cUL 508A or cUL 508C and CSA C22.2 NO.14-10 ⁷⁾ , RCM, EAC ⁴⁾	
Functional safety: STO TÜV Nord certificate	
ATEX-certified safe disconnection function, Ex II (2) GD ⁵⁾	
Marine type approvals:	
for -01: ABS, Bureau Veritas, CCS, DNV GL, Lloyd's, NK, RINA	
for -07/17/37: ABS, Bureau veritas, CCS, DNV GL, LR	
EMC according to EN 61800-3: 2004 + A1: 2012	
Categories C3 and C2 with internal option	
*C = Chemically active substances	
*S = Mechanically active substances	
¹⁾ For higher operational output frequencies please contact your local ABB office	
²⁾ Operation above 120 Hz might require type-specific derating, please contact your local ABB office	
³⁾ Please see rating tables for further details	
⁴⁾ EAC has replaced GOST R	
⁵⁾ Codes +L513/+L514, +Q971 for -07, -17,- 37	
⁶⁾ Derating reduced by lower than 40 °C ambient temperature	

Environmental limits	
Ambient temperature	
Transport	-40 to +70 °C
Storage	-40 to +70 °C
Operation area (air-cooled)	-15 to +40 °C, no frost allowed (-01) 0 to +50 °C, no frost allowed (-07, -17, -37) +40 to +55 °C with derating (-01) ³⁾ +40 to +50 °C with derating of 1%/1 °C (-07,-17,-37)
Cooling method	
Air-cooled	Dry clean air
Altitude	
0 to 1,000 m	Without derating
1,000 to 4,000 m	With derating of 1% / 100 m ⁶⁾
Relative humidity	5 to 95%, no condensation allowed
Degree of protection	
IP20	Option (-01)
IP21	Standard (-01)
IP22	Standard (-07, -17, -37)
IP42	Option (-07, -17, -37)
IP54	Option (-07, -17, -37)
IP55	Option (-01)
Paint color	RAL 9017/9002 (-01) RAL 9017/7035 (-07, -17, -37)
Contamination levels	No conductive dust allowed
Storage	IEC 60721-3-1, Class 1C2 (chemical gases), Class 1S2 (solid particles)*
Operation	IEC 60721-3-3, Class 3C2 (chemical gases), Class 3S2 (solid particles)*
Transportation	IEC 60721-3-2, Class 2C2 (chemical gases), Class 2S2 (solid particles)*
Functional safety	
Standard	Safe torque off (STO according to EN/IEC 61800-5-2) IEC 61508 ed2: SIL 3, IEC 61511: SIL 3, EN/IEC 62061: SIL CL 3, EN ISO 13849-1: PL e
With internal safety functions module	Safe stop 1 (SS1), safely-limited speed (SLS), safe stop emergency (SSE), safe brake control (SBC) and safe maximum speed (SMS), prevention of unexpected startup (POUS), safe direction (SDI), safe speed monitor (SSM) EN/IEC 61800-5-2, IEC 61508 ed2: SIL 3, IEC 61511: SIL 3, EN/IEC 62061: SIL CL 3, EN ISO 13849-1: PL e TÜV Nord certified
Safety over fieldbus	PROFIsafe over PROFINET, certified

Wall-mounted single drives

ACS880-01



Compact package for simple installation

The ACS880-01 comes in one compact package for easy installation and commissioning. The drive supports wall-mounting as standard and cabinet mounting as an option. The drive offering includes enclosure classes up to UL Type 12, making it suitable for most environments and installations.

ACS880-01 drives have all the essential features built-in. These features include as standard a choke for harmonic filtering as well as options like a brake chopper, EMC filter and fieldbus communication, functional safety and I/O extension modules. The extensive range of options also includes external output filters and brake resistors.

The ACS880-01 is also available with marine type approval from various key classification bodies.



Wall-mounted ACS880-01 drives

- Power ratings: 0.75 to 350 hp (0.55 to 250 kW)
- Enclosure classes: UL Type 1 for cabinet mounting, UL Type 1 (as standard) for wall-mounting and UL Type 12 for dusty and wet environments

Main options:

- C2 and C3 EMC filters, see page 47
- Brake chopper (as standard in frames R1 to R4)
- Brake resistor
- Marine type approval from various key classification bodies
- I/O extension modules, see page 40
- Fieldbus adapter modules, see page 40
- Speed feedback interfaces, see page 43
- Functional safety modules, see page 44
- Remote monitoring tool, see page 42
- Application specific software, see page 14
- Du/dt filters
- Sine filters
- Flange mounting

The drives have an extensive selection of built-in features and options. See page 54.

Highlights

- Wide power range supporting wall-mounting, 0.75 to 350 hp (0.55 to 250 kW)
- Enclosure classes up to UL Type 12
- Compact, single package with all the essential features built-in
- Easy installation for different environments
- Robust and reliable design
- Optional marine type approved version

Ratings, types and voltages

Wall-mounted drives, ACS880-01

$U_N = 240$ VAC (range 208 to 240 VAC). Power ratings are valid at nominal voltage 230 VAC, 60 Hz

Drive type	Frame size	Light duty			Heavy duty			Noise level (dBA)	Heat dissipation (BTU)	Air flow (cfm)
		I_{Ld} (A)	P_{Ld} (hp)	P_{Ld} (kW)	I_{Hd} (A)	P_{Hd} (hp)	P_{Hd} (kW)			
ACS880-01-04A6-2	R1	4.4	1	0.75	3.7	0.75	0.55	46	249	26
ACS880-01-06A6-2	R1	6.3	1.5	1.1	4.6	1	0.75	46	321	26
ACS880-01-07A5-2	R1	7.1	2	1.5	6.6	1.5	1.1	46	416	26
ACS880-01-10A6-2	R1	10.1	3	2.2	7.5	2	1.5	46	587	26
ACS880-01-16A8-2	R2	16	5	4	10.6	3	3	51	792	52
ACS880-01-24A3-2	R2	23.1	7.5	5.5	16.8	5	4	51	1150	52
ACS880-01-031A-2	R3	29.3	10	7.5	24.3	7.5	5.5	57	1559	79
ACS880-01-046A-2	R4	44	15	11	38	10	7.5	63	1706	79
ACS880-01-061A-2	R4	58	20	15	45	15	11	63	2150	165
ACS880-01-075A-2	R5	71	25	18.5	61	20	15	63	2320	165
ACS880-01-087A-2	R5	83	30	22	72	25	18.5	63	2491	165
ACS880-01-115A-2	R6	109	40	30	87	30	22	67	2866	256
ACS880-01-145A-2	R6	138	50	37	105	40	30	67	3207	256
ACS880-01-170A-2	R7	162	60	45	145	50	37	67	4299	265
ACS880-01-206A-2	R7	196	75	55	169	60	45	67	5118	265
ACS880-01-274A-2 ¹	R8	260	100	75	213	75	55	65	7165	324

$U_N = 500$ VAC (range 380 to 500 VAC). Power ratings are valid at nominal voltage 480 VAC, 60 Hz

Drive type	Frame size	Light duty			Heavy duty			Noise level (dBA)	Heat dissipation (BTU)	Air flow (cfm)
		I_{Ld} (A)	P_{Ld} (hp)	P_{Ld} (kW)	I_{Hd} (A)	P_{Hd} (hp)	P_{Hd} (kW)			
ACS880-01-02A1-5	R1	2.1	1	0.75	1.7	0.75	0.55	46	102	26
ACS880-01-03A0-5	R1	3	1.5	1.1	2.1	1	0.75	46	136	26
ACS880-01-03A4-5	R1	3.4	2	1.5	3	1.5	1.1	46	177	26
ACS880-01-04A8-5	R1	4.8	3	2.2	3.4	2	1.5	46	249	26
ACS880-01-07A6-5	R1	7.6	5	4	5.2	3	3	46	416	26
ACS880-01-11A0-5	R1	11	7.5	5.5	7.6	5	4	46	587	26
ACS880-01-014A-5	R2	14	10	7.5	11	7.5	5.5	51	792	52
ACS880-01-021A-5	R2	21	15	11	14	10	7.5	51	1150	52
ACS880-01-027A-5	R3	27	20	15	21	15	11	57	1559	79
ACS880-01-034A-5	R3	34	25	18.5	27	20	15	57	1918	79
ACS880-01-040A-5	R4	40	30	22	34	25	18.5	62	2276	79
ACS880-01-052A-5	R4	52	40	30	40	30	22	62	3095	165
ACS880-01-065A-5	R5	65	50	37	52	40	30	62	3811	165
ACS880-01-077A-5	R5	77	60	45	65	50	37	63	3822	165
ACS880-01-096A-5	R6	96	75	55	77	60	45	67	4419	256
ACS880-01-124A-5	R6	124	100	75	96	75	55	67	4913	256
ACS880-01-156A-5	R7	156	125	90	124	100	75	67	6620	265
ACS880-01-180A-5	R7	180	150	110	156	125	90	67	7882	265
ACS880-01-240A-5 ²	R8	240	200	132	180	150	110	65	11260	324
ACS880-01-260A-5 ¹	R8	260	200	132	240 ⁶	150	110	65	13307	324
ACS880-01-302A-5 ¹	R9	302	250	187.5	260	200	132	68	14331	677
ACS880-01-361A-5 ³	R9	361	300	200	302	250	187.5	68	16378	677
ACS880-01-414A-5 ⁴	R9	414*	350	250	361**	300	200	68	20473	677

$U_N = 600$ VAC (range 525 to 690 VAC). Power ratings are valid at nominal voltage 575 VAC, 60 Hz

Drive type	Frame size	Light duty			Heavy duty			Noise level (dBA)	Heat dissipation (BTU)	Air flow (cfm)
		I_{Ld} (A)	P_{Ld} (hp)	P_{Ld} (kW)	I_{Hd} (A)	P_{Hd} (hp)	P_{Hd} (kW)			
ACS880-01-07A3-7	R5	9	7.5	5.5	6.1	5	4	62	740	165
ACS880-01-09A8-7	R5	11	10	7.5	9	7.5	5.5	62	969	165
ACS880-01-14A2-7	R5	17	15	11	11	10	7.5	62	1361	165
ACS880-01-018A-7	R5	22	20	15	17	15	11	62	1672	165
ACS880-01-022A-7	R5	27	25	18.5	22	20	15	62	1972	165
ACS880-01-026A-7	R5	32	30	22	27	25	18.5	62	2252	165
ACS880-01-035A-7	R5	41	40	30	32	30	22	62	2948	165
ACS880-01-042A-7	R5	52	50	37	41	40	30	62	3405	165
ACS880-01-049A-7	R5	52	50	37	41	40	30	62	3822	165
ACS880-01-061A-7	R6	62	60	45	52	50	37	62	4419	256
ACS880-01-084A-7	R6	77	75	55	62	60	45	67	4913	256
ACS880-01-098A-7	R7	99	100	75	77	75	55	67	6620	265
ACS880-01-119A-7	R7	125	125	90	99	100	75	67	7882	265
ACS880-01-142A-7	R8	144	150	110	125	125	90	65	11260	324
ACS880-01-174A-7 ¹	R8	180	200 ⁷	132	144	150	110	65	13307	324
ACS880-01-210A-7 ⁵	R9	242	250	160	192	200	132	68	14331	677
ACS880-01-271A-7 ⁴	R9	271	250	200	242 ⁶	250	160	68	16378	677

Light duty use

I_{Ld} Continuous rms output current allowing 110% overload for 1 minute every 5 minutes.

P_{Ld} Typical motor power in light-overload use.

Heavy duty use

I_{Hd} Continuous rms output current allowing 150% overload for 1 minute every 5 minutes.

P_{Hd} Typical motor power in heavy-duty use.

Notes:

* Rating applies at an ambient temperature of 30°C. At an ambient temperature of 40°C, the rating is 393A.

** 25% overload for 1 minute every 5 minutes.

1 For drives with enclosure class UL type 12 (IP55), the ratings apply at an ambient temperature of 40°C.

For higher ambient temperatures, the derating is 1%/1°C from 40 to 45°C and 2.5%/1°C from 45 to 55°C.

2 For drives with enclosure class UL type 12 (IP55), the ratings apply at an ambient temperature of 40°C.

For higher ambient temperatures, the derating is 1%/1°C from 40 to 50°C and 2.5%/1°C from 50 to 55°C.

3 For drives with enclosure class UL type 12 (IP55), the ratings apply at an ambient temperature of 40°C.

For higher ambient temperatures, the derating is 1%/1°C from 40 to 45°C, 2.5%/1°C from 45 to 50°C, and 5%/1°C from 50 to 55°C.

4 For drives with enclosure class UL type 12 (IP55), the maximum ambient temperature is 35°C.

5 For drives with enclosure class UL type 12 (IP55), the ratings apply at an ambient temperature of 40°C.

For higher ambient temperatures, the derating is 1%/1°C from 40 to 45°C. The maximum ambient temperature is 45°C.

6 30% overload for 1 minute every 5 minutes.

7 This unit is capable of delivering 192A continuous at 40°C with no overload

Ratings apply at an ambient temperature of 40°C unless otherwise noted.

To achieve the rated motor power given in the table, the rated current of the drive must be higher than or equal to the rated motor current.

Cabinet-built single drives

ACS880-07



Our cabinet-built single drives are built to order, meeting your needs regardless of the technical challenges. The drive configuration includes a rectifier, DC link, inverter, fuses, line choke and a main switch, all built into a compact cabinet for easy assembly and commissioning.

The ACS880-07 offers a wide variety of standardized configurations for different application requirements, from line contactors, to preventing unexpected motor starts. If the application requires more, ABB's Order-Based Engineering services can add special features to the standard product, such as an additional cabinet for customer-specific devices.

Drives up to frame size R11 are based on a compact single module including rectifier and inverter. Larger drives consist of separate rectifier and inverter modules, providing redundancy with parallel connected units. If one module needs to be disconnected, the drive can continue running at reduced power.

The robust design and enclosures up to UL Type 12 make the ACS880-07 suitable for even very harsh environments.

The drives have an extensive selection of built-in features and options. See page 54.

Cabinet-built ACS880-07 drives

- Power ratings: 60 to 3000 hp (45 to 2800 kW)
- Enclosure classes UL Type 1 (as standard), UL Type 1 filtered and UL Type 12 for different environments, with option for air intake through the bottom of the cabinet and channeled air outlet on the top of the cabinet.

Main options:

- Cabling solutions for bottom and top entry and exit
- Functional safety modules, see page 44
- I/O extension modules, see page 40
- Fieldbus adapter modules, see page 40
- Speed feedback interfaces, see page 43
- Brake option inside the module or cabinet
- C2 and C3 EMC filters, see page 47
- Du/dt and common mode filter options for motor protection
- Marine construction option
- Cabinet light and heater option

Highlights

- Compact package for easy assembly and commissioning
- Available as an engineered, customer-specific solution
- All essential features built-in
- Robust design verified by various standards

Ratings, types and voltages

Cabinet-built drives, ACS880-07

$U_N = 500$ V (range 380 to 500V). Power ratings are valid at nominal voltage 480 V 60 Hz

Drive type	Frame size	Light duty			Heavy duty			Noise level (dBA)	Heat dissipation (BTU)	Air flow (cfm)
		I_{Ld} (A)	P_{Ld} (hp)	P_{Ld} (kW)	I_{Hd} (A)	P_{Hd} (hp)	P_{Hd} (kW)			
6-pulse diode										
ACS880-07-0096A-5+C129	R6	96	75	55	77	60	45	67	6125	1130
ACS880-07-0124A-5+C129	R6	124	100	75	96	75	55	67	6620	1130
ACS880-07-0156A-5+C129	R7	156	125	90	124	100	75	67	8326	1130
ACS880-07-0180A-5+C129	R7	180	150	110	156	125	90	67	9589	1130
ACS880-07-0240A-5+C129	R8	240	200	132	180	150	110	65	12967	1130
ACS880-07-0302A-5+C129	R9	302	250	200	260	200	132	68	16037	677
ACS880-07-0361A-5+C129	R9	361	300	200	302	250	200	68	18085	677
ACS880-07-0414A-5+C129	R9	414*	350	250	361**	300	200	68	22179	677
ACS880-07-0460A-5+C129	R10	450	375	315	330	275	200	72	20821	1837
ACS880-07-0503A-5+C129	R10	483	400	315	361	300	250	72	20821	1837
ACS880-07-0583A-5+C129	R10	573	450	400	414	350	250	72	23575	1837
ACS880-07-0635A-5+C129	R10	623	500	450	477	400	315	72	29420	1837
ACS880-07-0715A-5+C129	R11	705	600	500	566	450	400	72	32839	1837
ACS880-07-0820A-5+C129	R11	807	700	560	625	500	450	71	35357	1837
ACS880-07-0880A-5+C129	R11	857	700	560	697**	600	500	71	35357	1837
ACS880-07-1070A-5+C129+H359 ¹	D8T+2×R8i	1027	900	710	800	700	560	73	61419	2525
ACS880-07-1320A-5+C129+F255+H359 ²	2×D8T+2×R8i	1267	1100	900	987	850	710	74	75068	3367
ACS880-07-1450A-5+C129+F255+H359 ²	2×D8T+2×R8i	1392	1200	900	1085	900	710	74	75068	3367
ACS880-07-1580A-5+C129+F255+H359 ²	2×D8T+2×R8i	1517	1350	1000	1182	1000	800	74	92128	3367
ACS880-07-1800A-5+C129+F255+H359 ²	2×D8T+3×R8i	1728	1500	1200	1346	1200	900	75	92128	4208
ACS880-07-1980A-5+C129+F255+H359 ²	2×D8T+3×R8i	1901	1700	1300	1481	1300	1000	75	122837	4208
12-pulse connection³										
ACS880-07-0990A-5+A004+H359 ^{1,3}	2×D7T+2×R8i	950	800	630	741	600	500	73	54595	3367
ACS880-07-1320A-5+A004+H359 ^{1,3}	2×D8T+2×R8i	1267	1100	900	987	850	710	74	75067	3367
ACS880-07-1450A-5+A004+H359 ^{1,3}	2×D8T+2×R8i	1392	1200	900	1085	900	710	74	85304	3367
ACS880-07-1580A-5+A004+H359 ^{1,3}	2×D8T+2×R8i	1517	1300	1000	1182	1000	800	74	92128	3367
ACS880-07-1800A-5+A004+H359 ^{1,3}	2×D8T+3×R8i	1728	1500	1200	1346	1200	900	75	109189	4208
ACS880-07-1980A-5+A004+H359 ^{1,3}	2×D8T+3×R8i	1901	1700	1300	1481	1300	1000	75	122837	4208

$U_n = 600\text{ V}$ (range 525 to 690V). Power ratings are valid at nominal voltage 575 V 60 Hz
IMPORTANT: FOR 690V, DO NOT INCLUDE +C129

Drive type	Frame size	Light duty			Heavy duty			Noise level (dBA)	Heat dissipation (BTU)	Air flow (cfm)
		I_{Ld} (A)	P_{Ld} (hp)	P_{Ld} (kW)	I_{Hd} (A)	P_{Hd} (hp)	P_{Hd} (kW)			
6-pulse diode										
ACS880-07-0061A-7+C129	R6	62	60	45	49	50	37	67	6125	1130
ACS880-07-0084A-7+C129	R6	77	75	55	61	60	45	67	6620	1130
ACS880-07-0098A-7+C129	R7	99	100	75	84	75	55	67	8326	1130
ACS880-07-0119A-7+C129	R7	125	125	90	98	100	75	67	9589	1130
ACS880-07-0142A-7+C129	R8	144	150	110	119	125	90	65	12967	1130
ACS880-07-0174A-7+C129	R8	180	200	132	142	150	110	65	15014	1130
ACS880-07-0210A-7+C129	R9	242	250	160	174	200	132	68	16037	677
ACS880-07-0271A-7+C129	R9	271	250	200	210	250	160	68	18085	677
ACS880-07-0330A-7+C129	R10	320	300	315	255	250	250	72	16730	1837
ACS880-07-0370A-7+C129	R10	360	350	355	325	300	315	72	20821	1837
ACS880-07-0430A-7+C129	R10	420	450	400	360***	350	355	72	23575	1837
ACS880-07-0470A-7+C129	R11	455	450	450	415	450	400	72	29420	1837
ACS880-07-0522A-7+C129	R11	505	500	500	455	450	450	72	32839	1837
ACS880-07-0590A-7+C129	R11	571	600	560	505	500	500	71	35357	1837
ACS880-07-0650A-7+C129	R11	630	700	630	571***	600	560	71	37800	1978
ACS880-07-0721A-7+C129	R11	705	700	630	571***	600	560	71	37800	1978
ACS880-07-0800A-7+C129+H359 ¹	1×D8T+2×R8i	768	850	710	598	650	560	73	54595	2525
ACS880-07-0900A-7+C129+H359 ¹	1×D8T+2×R8i	864	1000	800	673	775	630	74	68243	2525
ACS880-07-1160A-7+C129+H359 ¹	2×D8T+2×R8i	1114	1200	1100	868	950	800	74	88716	3367
ACS880-07-1450A-7+C129+F255+H359 ²	2×D8T+3×R8i	1392	1500	1250	1085	1200	1000	75	109189	4208
ACS880-07-1650A-7+C129+F255+H359 ²	2×D8T+3×R8i	1584	1750	1500	1234	1350	1200	75	124544	4208
ACS880-07-1950A-7+C129+F255+H359 ²	3×D8T+4×R8i	1872	2000	1800	1459	1600	1400	78	150134	5892
ACS880-07-2300A-7+C129+F255+H359 ²	3×D8T+4×R8i	2208	2450	2000	1720	1900	1600	78	177412	5892
ACS880-07-2600A-7+C129+F255+H359 ²	4×D8T+5×R8i	2496	2750	2400	1945	2150	1900	78	197904	7575
ACS880-07-2860A-7+C129+F255+H359 ²	4×D8T+5×R8i	2746	3000	2400	2139	2350	2000	78	221790	7575
12-pulse connection³										
ACS880-07-0800A-7+A004+H359 ^{1,3}	2×D7T+2×R8i	768	850	710	598	650	560	73	54595	3367
ACS880-07-0950A-7+A004+H359 ^{1,3}	2×D8T+2×R8i	912	1000	800	711	775	630	74	68243	3367
ACS880-07-1160A-7+A004+H359 ^{1,3}	2×D8T+2×R8i	1114	1200	1100	868	950	800	74	88716	3367
ACS880-07-1450A-7+A004+H359 ^{1,3}	2×D8T+3×R8i	1392	1500	1250	1085	1200	1000	75	109189	4208
ACS880-07-1650A-7+A004+H359 ^{1,3}	2×D8T+3×R8i	1584	1750	1500	1234	1350	1200	75	124544	4208
ACS880-07-1950A-7+A004+H359 ^{1,3}	4×D8T+4×R8i	1872	2000	1800	1459	1600	1400	77	150134	6733
ACS880-07-2300A-7+A004+H359 ^{1,3}	4×D8T+4×R8i	2208	2450	2000	1720	1900	1600	77	177412	6733
ACS880-07-2600A-7+A004+H359 ^{1,3}	4×D8T+5×R8i	2496	2750	2400	1945	2150	1900	78	197904	7575
ACS880-07-2860A-7+A004+H359 ^{1,3}	4×D8T+5×R8i	2746	3000	2400	2139	2350	2000	78	221790	7575

Light duty use

I_{Ld} Continuous rms output current allowing 110% overload for 1 minute every 5 minutes.
 P_{Ld} Typical motor power in light-overload use.

Heavy duty use

I_{Hd} Continuous rms output current allowing 150% overload for 1 minute every 5 minutes.
 P_{Hd} Typical motor power in heavy-duty use.

Notes:

- * Rating applies at 30°C ambient. At 40°C ambient, rating is 393A
- ** 25% overload for 1 minute every 5 minutes
- *** 44% overload for 1 minute every 5 minutes
- 1 Type code and price include common motor terminal cubicle option (H359).
- 2 Air circuit breaker option (F255) is required with UL listed (C129) or CSA approved (C134) designs. Common motor terminal cabinet option (H359) is included as standard.
- 3 12-pulse ratings as shown are not UL listed or CSA approved as standard. UL listed / CSA approved designs are available as specially engineered cabinets.
 A Request For Quote must be submitted
- 4 Cabinet is a non-UL/CSA design which includes bottom cable entry and exit and European cable gland plates as standard

Regenerative drives

ACS880-17

—
01 Speed and
power curves in
cyclic operation

Energy savings

The ACS880-17 is a compact and complete regenerative drive solution with everything you need for regenerative operation in cyclic or continuous braking applications. With regenerative functionality, the braking energy of the motor is returned to the drive and distributed to the supply network so that it can be utilized by other equipment. Compared to mechanical or resistor braking, where braking energy is wasted as heat, regenerative drive operation offers significant savings in energy consumption and cooling.

The drive reaches a unity power factor. This high power factor indicates that electrical energy is used to its full potential.

—
Possibility to regenerate
100% of power continuously

Minimized downtime

Regenerative drive offers immunity to network disturbances. The drive will not interrupt the process or affect its quality in unstable supply network conditions. Drive's active supply unit is able to boost output voltage, enabling full motor voltage even when the supply voltage is below nominal. The drive can even compensate for rapid variations in supply voltage, ensuring reliable operation during network fluctuations. Voltage boost capability can also be utilized to overcome a voltage drop caused by long supply or motor cables or output filters.

Optimized cost and space

Everything needed for regenerative operation, such as an active supply unit and low harmonic line filter are integrated into the drive, and no external braking devices are needed.

Advantages:

- Quick, easy drive installation
- Small installation footprint
- No need to add cooling to handle the heat generated by mechanical or resistor braking
- Simplified wiring
- Less spare parts needed

The “all inside” design helps to cut engineering and assembly time, as well as reducing equipment costs and the risk of errors.

The drive's voltage boost capability can be an advantage in motor dimensioning. With a higher motor voltage, the same power is achieved with less current, which may allow a smaller motor to be used.

The drive offers a possibility for network power factor correction to compensate for low power factors of equipment connected to the same network. It reduces the need for additional power factor correction equipment, such as filters and large capacitor banks. It can also help to avoid penalty charges from electrical utilities for poor power factors.

—
Capture energy instead
of wasting it

Maximized motor performance and efficiency

The drive is able to provide full motor voltage in all conditions. Regeneration can occur for as long as necessary and as often as needed.

The drive features direct torque control (DTC) as standard, making it suitable also for very demanding applications. DTC provides precise speed and torque control for maximum motor performance and motor efficiency.

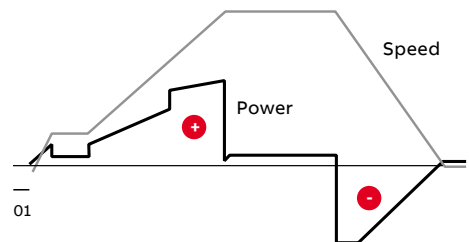

Low harmonic content

The drive produces exceptionally low harmonic content and exceeds the requirements of even the most stringent harmonic recommendations, like IEEE 519, IEC 61000-3-2, IEC 61000-3-12 and G5/4. Compared to conventional drives, the harmonic content is up to 97% lower. The total harmonic current distortion is typically <3% in nominal situation and undistorted network.



Cabinet-built regenerative drives, ACS880-17

- Power ratings: 250 to 3300 hp (45 to 3200 kW)
- Enclosure classes: UL Type 1 (as standard), UL Type 1 filtered and UL Type 12 for different environments, with option for air intake through bottom of the cabinet and channeled air outlet on the top of the cabinet
- EMC filter as standard

Main options:

- Cabling solutions for bottom and top entry and exit
- Functional safety modules, see page 44
- I/O extension modules, see page 40
- Fieldbus adapter modules, see page 40
- Speed feedback interfaces, see page 43
- Du/dt and common mode filter options for motor protection
- Marine construction option
- Cabinet light and heater option

The drives have an extensive selection of built-in features and options. See page 54.

Highlights

- Everything for regenerative operation in one compact package. Designed for easy installation
- Possibility to regenerate 100% of the power continuously
- The total harmonic current distortion is typically <3% in nominal situation and undistorted network
- Clear energy savings compared to other braking methods
- Reduced cost of ownership
- Unity power factor. Possibility also for network power factor correction
- Stable output voltage in all load conditions, even with fluctuating supply voltage

Ratings, types and voltages

Cabinet-built regenerative drives, ACS880-17

$U_n = 500$ V (range 380 to 500V). Power ratings are valid at nominal voltage 480 V 60 Hz

Drive type	Frame size	Light duty			Heavy duty			Noise level (dBA)	Heat dissipation (BTU)	Air flow (cfm)
		I_{Ld} (A)	P_{Ld} (hp)	P_{Ld} (kW)	I_{Hd} (A)	P_{Hd} (hp)	P_{Hd} (kW)			
ACS880-17-0420A-5+C129	1xR8i+1xR8i	403	350	250	314	250	200	75	44357	1680
ACS880-17-0570A-5+C129	1xR8i+1xR8i	547	500	355	426	350	250	75	58006	1680
ACS880-17-0780A-5+C129	1xR8i+1xR8i	749	650	500	583	500	400	75	85303	1680
ACS880-17-1010A-5+C129+H359	2xR8i+2xR8i	970	850	630	755	650	500	77	105776	3370
ACS880-17-1110A-5+C129+H359	2xR8i+2xR8i	1066	950	710	830	700	560	77	109188	3370
ACS880-17-1530A-5+C129+H359	2xR8i+2xR8i	1469	1300	1000	1144	1000	800	77	156958	3370
ACS880-17-1980A-5+C129+H359	3xR8i+3xR8i	1901	1700	1300	1481	1350	1000	78	201316	8580
ACS880-17-2270A-5+C129+H359	3xR8i+3xR8i	2179	1950	1500	1698	1500	1200	78	235437	8580

$U_n = 600$ V (range 525 to 690V). Power ratings are valid at nominal voltage 575 V 60 Hz

IMPORTANT: FOR 690V, DO NOT INCLUDE +C129

Drive type	Frame size	Light duty			Heavy duty			Noise level (dBA)	Heat dissipation (BTU)	Air flow (cfm)
		I_{Ld} (A)	P_{Ld} (hp)	P_{Ld} (kW)	I_{Hd} (A)	P_{Hd} (hp)	P_{Hd} (kW)			
ACS880-17-0320A-7+C129	1xR8i+1xR8i	307	300	250	239	250	200	75	54594	1680
ACS880-17-0390A-7+C129	1xR8i+1xR8i	374	400	315	292	300	250	75	64830	1680
ACS880-17-0580A-7+C129	1xR8i+1xR8i	557	600	450	434	450	350	75	88715	1680
ACS880-17-0660A-7+C129+H359	2xR8i+2xR8i	634	700	550	494	500	400	77	102364	3370
ACS880-17-0770A-7+C129+H359	2xR8i+2xR8i	739	800	630	576	650	500	77	116012	3370
ACS880-17-0950A-7+C129+H359	2xR8i+2xR8i	912	1000	800	711	750	560	77	136485	3370
ACS880-17-1130A-7+C129+H359	2xR8i+2xR8i	1085	1200	900	845	950	710	77	163782	3370
ACS880-17-1450A-7+C129+H359	3xR8i+3xR8i	1392	1500	1150	1085	1200	900	78	214964	5050
ACS880-17-1680A-7+C129+H359	3xR8i+3xR8i	1613	1800	1350	1257	1400	1100	78	252498	5050
ACS880-17-1950A-7+C129+H359	4xR8i+4xR8i	1872	2100	1600	1459	1600	1200	79	286619	6730
ACS880-17-2230A-7+C129+H359	4xR8i+4xR8i	2141	2400	1850	1668	1850	1400	79	324153	6730
ACS880-17-2770A-7+C129+H359	6xR8i+5xR8i	2659	2900	2200	2072	2300	1750	79	406044	8420
ACS880-17-3310A-7+C129+H359	6xR8i+6xR8i	3178	3300	2500	2476	2750	2050	79	484524	10100

Light duty use

I_{Ld}	Continuous rms output current allowing 110% overload for 1 minute every 5 minutes.
----------	--

P_{Ld}	Typical motor power in light-overload use.
----------	--

Heavy duty use

I_{Hd}	Continuous rms output current allowing 150% overload for 1 minute every 5 minutes.
----------	--

P_{Hd}	Typical motor power in heavy-duty use.
----------	--

Ratings apply at an ambient temperature of 40 °C unless otherwise noted.

To achieve the rated motor power given in the table, the rated current of the drive must be higher than or equal to the rated motor current

Ultra-low harmonic drives

ACS880-37

Harmonic distortions can disturb or even damage sensitive equipment connected in the same environment. Harmonics also cause additional losses in the network.

Clean supply network

Our ultra-low harmonic drive produces exceptionally low harmonic content and exceeds the requirements of harmonic recommendations like IEEE 519 and G5/4. Compared to a conventional drive, the harmonic content is reduced by up to 97%. The total harmonic current distortion is typically <3% in nominal situation and undistorted network.

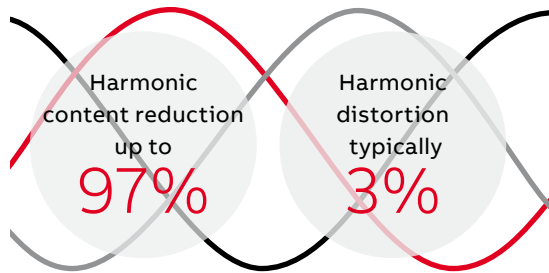

Keeps the network clean

Minimized downtime

ABB's ultra-low harmonic drive offers immunity to network disturbances. The drive will not interrupt the process or affect its quality in unstable supply network conditions. Drives' active supply unit is able to boost the output voltage to enable full motor voltage even when the supply voltage is below nominal. This ensures reliable operation in weak networks. This voltage boost capability can also be utilized to overcome voltage drops caused by long supply or motor cables.

The possibility to stabilize the output voltage of the drive is an advantage compared to alternative low harmonic solutions where voltage cannot be boosted.

Optimized cost and space

The compact drive has harmonics mitigation built-in. This includes an active supply unit and integrated, low harmonic line filter.

The "all Inside" design means there is no need for external filters, multi-pulse arrangements or special transformers. The simple installation offers significant savings in space, time and cost.

As the risk of overheating is lower with lower harmonic currents, there is no need to over-dimension equipment, such as transformers and cables.

The drive's voltage boost capability can be an advantage in motor dimensioning. With a higher motor voltage, the same power is achieved with less current, which improves motor efficiency and may allow a smaller motor to be used.

Maximized motor performance and efficiency

The drive is able to provide full motor voltage even if the supply voltage fluctuates. It features direct torque control (DTC) as standard, making it suitable also for very demanding applications. DTC provides precise speed and torque control for maximum motor performance and motor efficiency.

Reduces the total cost of ownership

Efficient energy utilization

Ultra-low harmonic drives achieve a unity power factor. This high power factor indicates that electrical energy is used efficiently.

The drive offers the possibility for network power factor correction to compensate for low power factors of equipment connected to the same network. It can help to avoid penalty charges set by electrical utilities for poor power factors.

Lower harmonics and full motor voltage at all times means reduced system losses and better overall system efficiency.

For more information, visit <http://new.abb.com/drives/harmonics>.



Cabinet-built ultra-low harmonic drives, ACS880-37

- Power ratings: 250 to 3300 hp (45 to 3200 kW)
- Enclosure classes: UL Type 1 (as standard), UL Type 1 filtered and UL Type 12 for different environments, with option for air intake through bottom of the cabinet and channeled air outlet on the top of the cabinet
- EMC filter as standard

Main options:

- Cabling solutions for bottom and top entry and exit
- Functional safety modules, see page 44
- I/O extension modules, see page 40
- Fieldbus adapter modules, see page 40
- Speed feedback interfaces, see page 43
- Du/dt and common mode filter options for motor protection
- Marine construction option
- Cabinet light and heater option

The drives have an extensive selection of built-in features and options. See page 54.

Highlights

- The total harmonic current distortion is typically <3% in nominal situation and undistorted network. Low harmonic content also at partial loads
- “All inside” design: no need for external filters, multi-pulse arrangements or special transformers
- Simple and cost-effective installation
- Unity power factor. Possibility for network power factor correction
- Small installation footprint
- Output voltage stabilization secures operation in weak networks
- Stable output voltage in all load conditions

Ratings, types and voltages

Cabinet-built ultra-low harmonic drives, ACS880-37

$U_N = 500$ V (range 380 to 500V). Power ratings are valid at nominal voltage 480 V 60 Hz

Drive type	Frame size	Light duty			Heavy duty			Noise level (dBA)	Heat dissipation (BTU)	Air flow (cfm)
		I_{Ld} (A)	P_{Ld} (hp)	P_{Ld} (kW)	I_{Hd} (A)	P_{Hd} (hp)	P_{Hd} (kW)			
ACS880-37-0420A-5+C129	1xR8i+1xR8i	403	350	250	314	250	200	75	44357	1680
ACS880-37-0570A-5+C129	1xR8i+1xR8i	547	500	355	426	350	250	75	58006	1680
ACS880-37-0780A-5+C129	1xR8i+1xR8i	749	650	500	583	500	400	75	85303	1680
ACS880-37-1010A-5+C129+H359	2xR8i+2xR8i	970	850	630	755	650	500	77	105776	3370
ACS880-37-1110A-5+C129+H359	2xR8i+2xR8i	1066	950	710	830	700	560	77	109188	3370
ACS880-37-1530A-5+C129+H359	2xR8i+2xR8i	1469	1300	1000	1144	1000	800	77	156958	3370
ACS880-37-1980A-5+C129+H359	3xR8i+3xR8i	1901	1700	1300	1481	1350	1000	78	201316	8580
ACS880-37-2270A-5+C129+H359	3xR8i+3xR8i	2179	1950	1500	1698	1500	1200	78	235437	8580

$U_N = 600$ V (range 525 to 690V). Power ratings are valid at nominal voltage 575 V 60 Hz

IMPORTANT: FOR 690V, DO NOT INCLUDE +C129

Drive type	Frame size	Light duty			Heavy duty			Noise level (dBA)	Heat dissipation (BTU)	Air flow (cfm)
		I_{Ld} (A)	P_{Ld} (hp)	P_{Ld} (kW)	I_{Hd} (A)	P_{Hd} (hp)	P_{Hd} (kW)			
ACS880-37-0320A-7+C129	1xR8i+1xR8i	307	300	250	239	250	200	75	54594	1680
ACS880-37-0390A-7+C129	1xR8i+1xR8i	374	400	315	292	300	250	75	64830	1680
ACS880-37-0580A-7+C129	1xR8i+1xR8i	557	600	450	434	450	350	75	88715	1680
ACS880-37-0660A-7+C129+H359	2xR8i+2xR8i	634	700	550	494	500	400	77	102364	3370
ACS880-37-0770A-7+C129+H359	2xR8i+2xR8i	739	800	630	576	650	500	77	116012	3370
ACS880-37-0950A-7+C129+H359	2xR8i+2xR8i	912	1000	800	711	750	560	77	136485	3370
ACS880-37-1130A-7+C129+H359	2xR8i+2xR8i	1085	1200	900	845	950	710	77	163782	3370
ACS880-37-1450A-7+C129+H359	3xR8i+3xR8i	1392	1500	1150	1085	1200	900	78	214964	5050
ACS880-37-1680A-7+C129+H359	3xR8i+3xR8i	1613	1800	1350	1257	1400	1100	78	252498	5050
ACS880-37-1950A-7+C129+H359	4xR8i+4xR8i	1872	2100	1600	1459	1600	1200	79	286619	6730
ACS880-37-2230A-7+C129+H359	4xR8i+4xR8i	2141	2400	1850	1668	1850	1400	79	324153	6730
ACS880-37-2770A-7+C129+H359	6xR8i+5xR8i	2659	2900	2200	2072	2300	1750	79	406044	8420
ACS880-37-3310A-7+C129+H359	6xR8i+6xR8i	3178	3300	2500	2476	2750	2050	79	484524	10100

Light duty use

I_{Ld}	Continuous rms output current allowing 110% overload for 1 minute every 5 minutes.
----------	--

P_{Ld}	Typical motor power in light-overload use.
----------	--

Heavy duty use

I_{Hd}	Continuous rms output current allowing 150% overload for 1 minute every 5 minutes.
----------	--

P_{Hd}	Typical motor power in heavy-duty use.
----------	--

Ratings apply at an ambient temperature of 40 °C unless otherwise noted.

To achieve the rated motor power given in the table, the rated current of the drive must be higher than or equal to the rated motor current

Dimensions

ACS880

ACS880-01, UL Type 1

Frame size	Height		Width		Depth		Weight			
	H1 (in)	H1 (mm)	H2 (in)	H2 (mm)	(in)	(mm)	(in)	(mm)	(lb)	(kg)
R1	16.0	405	14.6	370	6.1	155	9	226	13.2	6
R2	16.0	405	14.6	370	6.1	155	10	249	17.6	8
R3	18.5	471	16.5	420	6.7	172	10	261	22.0	10
R4	22.9	580	18.19	462	8	203	11	274	40.8	18.5
R5	28.8	732	23.5	596	8	203	11	274	50.7	23
R6	28.6	727	21.6	548	9.9	252	14	357	99.2	70
R7	34.6	880	23.6	600	11.2	284	14.4	365	121.3	55
R8	38.0	965	26.8	680	11.8	300	15.2	386	154.3	70
R9	37.6	955	26.7	680	15	380	16.23	412	216.0	98

H1 = Height with cable entry box. H2 = Height without cable entry box.

Width and depth with cable entry box.

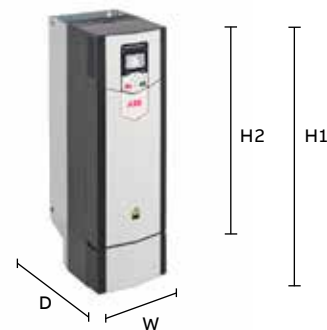

ACS880-01, UL Type 12

Frame size	Height		Width		Depth		Weight	
	(in)	(mm)	(in)	(mm)	(in)	(mm)	(lb)	(kg)
R1	17.6	450	6.3	162	11.5	295	13	6
R2	17.6	450	6.3	162	12.3	315	18	8
R3	20.5	525	7.0	180	12.8	327	22	10
R4	28.9	735	9.3	236	13.5	344	41	18.5
R5	34.9	886	9.3	236	13.5	344	51	23
R6	34.8	884	11.5	291	16.4	417	99	45
R7	40.9	1038	12.8	324	16.5	418	121	55
R8	44.2	1123	13.8	350	17.8	452	159	72
R9	46.8	1188	17.0	431	18.8	477	220	100



ACS880-07, UL Type 1								
Frame size	Height (H)		Width (W)		Depth (D)		Weight	
	(in)	(mm)	(in)	(mm)	(in)	(mm)	(lb)	(kg)
ACS880-07 R6-R8 (+C129)								
R6	84.5	2145	16.9	430	26.5	673	528	240
R7	84.5	2145	16.9	430	26.5	673	550	250
R8	84.5	2145	16.9	430	26.5	673	583	265
ACS880-07 R6-R8 MCCB (+C129+F289)								
R6	84.5	2145	32.7	830	26.5	673	715	325
R7	84.5	2145	32.7	830	26.5	673	737	360
R8	84.5	2145	32.7	830	26.5	673	770	350
ACS880-07 R9 (+C129)								
R9	84.5	2145	32.7	830	27.5	698	825	375
ACS880-07 R9 MCCB (+C129+F289)								
R9	84.5	2145	32.7	830	27.5	698	825	375
ACS880-07 R10-R11 (+C129)								
R10	84.5	2145	32.7	830	27.5	698	1170	530
R11	84.5	2145	32.7	830	27.5	698	1280	580
ACS880-07 R10-R11 (+C129+D150 or +C129+H356)								
R10	84.5	2145	44.5	1130	27.5	698	1520	690
R11	84.5	2145	44.5	1130	27.5	698	1630	740
ACS880-07 1xD8T+2xR8i (+C129+H359)								
1xD8T+2xR8i	84.5	2145	83.9	2130	27.5	698	3590	1630
ACS800-07 2xD7T+2xR8i (+A004+H359)								
2xD7T+2xR8i	84.5	2145	91.8	2330	27.5	698	4120	1870
ACS880-07 2xD8T+2xR8i (+C129+F255+H359)								
2xD8T+2xR8i	84.5	2145	107.5	2730	28.1	714	5020	2280
ACS880-07 2xD8T+3xR8i (+C129+F255+H359)								
2xD8T+3xR8i	84.5	2145	119.3	3030	28.1	714	5435	2470
ACS880-07 3xD8T+4xR8i (+C129+F255+H359)								
3xD8T+4xR8i	84.5	2145	142.9	3630	28.1	714	6880	3120
ACS880-07 4xD8T+4xR8i (+A004+H359)								
4xD8T+4xR8i	84.5	2145	150.8	3830	27.5	698	6970	3160
ACS880-07 4xD8T+5xR8i (+C129+F255+H359)								
A	84.5	2145	166	4215	28.1	714	7473	3390
B	84.5	2145	24.2	615	25.9	657	1124	510
Total	---	---	190.2	4830	---	---	8597	3900



NOTE: These dimensions are for the default type codes. Any "plus" codes may alter one or more of these dimensions.

ACS880-07, UL Type 12								
Frame size	Height (H)		Width (W)		Depth (D)		Weight	
	(in)	(mm)	(in)	(mm)	(in)	(mm)	(lb)	(kg)
ACS880-07 R6-R8 (+B055+C129)								
R6	91.2	2315	16.9	430	26.5	673	528	240
R7	91.2	2315	16.9	430	26.5	673	550	250
R8	91.2	2315	16.9	430	26.5	673	583	265
ACS880-07 R6-R8 (+B055+C129)								
R6	91.2	2315	32.7	830	26.5	673	715	325
R7	91.2	2315	32.7	830	26.5	673	737	360
R8	91.2	2315	32.7	830	26.5	673	770	350
ACS880-07 R9 (+B055+C129)								
R9	91.2	2315	32.7	830	27.5	698	825	375
ACS880-07 R9 MCCB (+B055+C129+F289)								
R9	91.2	2315	32.7	830	27.5	698	825	375
ACS880-07 R10-R11 (+B055+C129)								
R10	91.2	2315	32.7	830	27.5	698	1170	530
R11	91.2	2315	32.7	830	27.5	698	1280	580
ACS880-07 R10-R11 (+B055+C129+D150 or +B055+C129+H356)								
R10	91.2	2315	44.5	1130	27.5	698	1520	690
R11	91.2	2315	44.5	1130	27.5	698	1630	740
ACS880-07 1xD8T+2xR8i (+B055+C129+H359)								
1xD8T+2xR8i	91.2	2315	83.9	2130	27.5	698	3590	1630
ACS880-07 2xD8T+2xR8i (+A004+B055+H359)								
2xD8T+2xR8i	91.2	2315	91.8	2330	27.5	698	4120	1870
ACS880-07 2xD8T+2xR8i (+B055+C129+F255+H359)								
2xD8T+2xR8i	91.2	2315	107.5	2730	28.1	714	5020	2280
ACS880-07 2xD8T+3xR8i (+B055+C129+F255+H359)								
2xD8T+3xR8i	91.2	2315	119.3	3030	28.1	714	5435	2470
ACS880-07 3xD8T+4xR8i (+B055+C129+F255+H359)								
3xD8T+4xR8i	91.2	2315	142.9	3630	28.1	714	6880	3120
ACS880-07 4xD8T+4xR8i (+A004+B055+H359)								
4xD8T+4xR8i	91.2	2315	150.8	3830	27.5	698	6970	3160
ACS880-07 4xD8T+5xR8i (+B055+C129+F255+H359)								
A	91.2	2315	166	4215	28.1	714	7473	3390
B	91.2	2315	24.2	615	27	686	1124	510
Total	---	---	190.2	4830	---	---	8597	3900



ACS880-17/-37, UL Type 1

Frame size	Height		Width		Depth		Weight	
	(in)	(mm)	(in)	(mm)	(in)	(mm)	(lb)	(kg)
1xR8i+1xR8i	84.5	2145	48.5	1230	35.4	898	2602	1180
2xR8i+2xR8i	84.5	2145	99.6	2530	27.5	698	4695	2130
3xR8i+3xR8i	84.5	2145	150.8	3830	28.1	714	7231	3280
4xR8i+4xR8i	84.5	2145	174.4	4430	28.1	714	8930	4050
6xR8i+5xR8	84.5	2145	245.3	6230	28.1	714	11729	5320
6xR8i+6xR8i	84.5	2145	253.2	6430	28.1	714	12060	5470

ACS880-17/-37, UL Type 12

Frame size	Height		Width		Depth		Weight	
	(in)	(mm)	(in)	(mm)	(in)	(mm)	(lb)	(kg)
1xR8i+1xR8i	91.2	2315	48.5	1230	35.4	898	2602	1180
2xR8i+2xR8i	91.2	2315	99.6	2530	27.5	698	4695	2130
3xR8i+3xR8i	91.2	2315	146.9	3730	28.1	714	7143	3240
4xR8i+4xR8i	91.2	2315	174.4	4430	28.1	714	8930	4050
6xR8i+5xR8	91.2	2315	245.3	6230	28.1	714	11729	5320
6xR8i+6xR8i	91.2	2315	253.2	6430	28.1	714	12060	5470



Control panel options

—
01 Assistant control panel with Bluetooth is included as standard.

—
02 Optional Industrial Assistant control panel without Bluetooth.

—
03 Control panel mounting platform DPMP-01

Bluetooth control panel, ACS-AP-W (standard control panel)

Commissioning and operation of the ACS880 is easy with the assistant control panel. The panel has a multilingual graphical display, Bluetooth connectivity and a USB interface for PC tool connection. The panel can be used with all drives belonging to ABB's all-compatible product portfolio.

There is no need to know any drive parameters, as the control panel helps you set up the essential settings quickly and get the drive into action.

The Bluetooth connection enables the use of mobile apps like Drivetune. This app is available

for free on the Google Play and the Apple App store. Drivetune features include: commissioning, troubleshooting, monitoring and controlling the drive remotely. Drivetune also has full parameter access and backup and restore functionality.

Industrial control panel, ACS-AP-I

The ACS-AP-I industrial control panel has the same functionality as the ACS-AP-W Bluetooth panel, but without the Bluetooth connectivity.

Control panel mounting platform, DPMP-01/02

The DPMP-01 mounting platform is for flush mountings, and the DPMP-02 is for surface mountings.



Control panel options

Assistant control panel ACS-AP-W is included as standard in the delivery. ACS-AP-W (+J400) can be replaced by +J options below.

Option code	Description	Type designation
+0J400	No control panel	-
+J425	Industrial Assistant control panel without Bluetooth connection	ACS-AP-I
3AUA0000108878	Control panel mounting platform, flush mounted, IP54 / UL Type 12 (does not include control panel)	DPMP-01
3AXD5000009374	Control panel mounting platform, surface mounted, IP65 / UL Type 12 (does not include control panel)	DPMP-02

Save time, ease troubleshooting and improve drive performance with ABB smartphone apps

Better connectivity and user experience with Drivetune

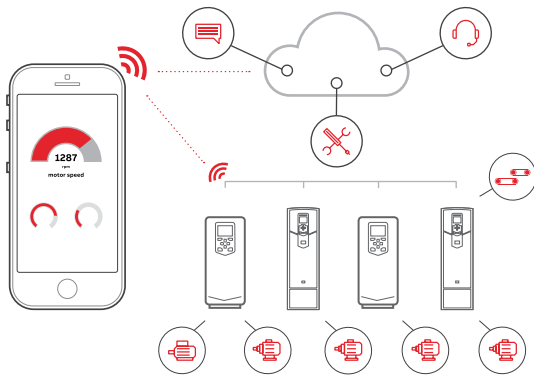

Easy and fast access to product information and support

Manage your drives and the process lines and machines they control



Easy access to cloud-based drive and process information from anywhere via an online connection



Start up, commission and tune your drive and application



Simplified user guidance with instant access to drive status and configuration



Performance optimization via drive troubleshooting features and fast support

Services and support on the go with Drivebase

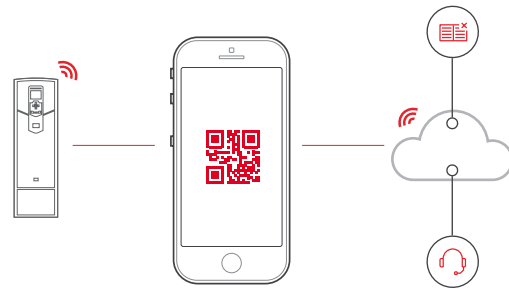

Search for support documents and contacts

Maintain and service all your installed drives on one or multiple sites



Get 6 months extra warranty for free by registering your drive with the Drivebase app



Access your product and service information in the cloud from anywhere



Access your drive's diagnostics data



Push notifications for critical product and service updates

Access information anywhere

Download the apps using the QR codes below or directly from the app stores



Connectivity to automation systems

—
01 ACS880 is compatible with many fieldbus protocols

—
02 Input/output extension modules

Fieldbus adapter modules

ACS880 industrial drives are compatible with a wide range of fieldbus protocols. The drive comes with a Modbus RTU fieldbus interface as standard.

The ACS880 supports two different fieldbus connections simultaneously and offers the possibility for redundant fieldbus communication. PROFIsafe (functional safety over PROFINET) is also supported.



—
01

Input/output extension modules

Standard input and output can be extended by using optional analog and digital input/output extension modules. The modules are easily installed in the extension slots located on the drive.

If there are not enough I/O extension slots in the drive, the FEA-03 module can increase the number of slots. The FEA-03 has two option slots for digital I/O extensions and speed feedback interface modules. The connection to the control unit is via an optical fiber link, and the adapter can be mounted on a DIN rail (35 × 7.5 mm).

Connectivity adapters

Option code	Fieldbus protocol	Adapter
+K451	DeviceNet™	FDNA-01
+K454	PROFIBUS DP, DPV0/DPV1	FPBA-01
+K457	CANopen®	FCAN-01
+K458	Modbus RTU	FSCA-01
+K462	ControlNet	FCNA-01
+K469	EtherCAT®	FECA-01
+K470	POWERLINK	FEPL-02
+K475	Two port EtherNet/IP™, Modbus TCP, PROFINET IO, PROFIsafe ¹⁾	FENA-21
+K491	Modbus/TCP	FMBT-21
+K492	PROFINET IO	FPNO-21
+K490	EtherNet/IP	FEIP-21

¹⁾ For the PROFIsafe to work the PROFINET fieldbus adapter module (FENA-21) and the safety functions module FSO-12 (+Q973) or FSO-21 (+Q972) are required.



—
02

Analog and digital input/output extension modules

Option code	Description	I/O module
+L501	4×DI/O, 2×RO	FIO-01
+L500	3×AI (mA/V), 1×AO (mA), 2×DI/O	FIO-11
+L515	2×F-type option extension slots	FEA-03
+L525	2×AI(mA/V), 2×AO(mA)	FAIO-01
+L526	3×DI (up to 250 V DC or 230 V AC), 2×RO	FDIO-01

PC tool options

—
01 Drive composer
PC tool

PC tools

The Drive composer PC tool offers fast and harmonized setup, commissioning and monitoring for ABB's all-compatible drives. The free version of the tool provides startup and maintenance capabilities, and includes support for adaptive programming. It also gathers all drive information, such as parameter loggers, faults, backups and event lists, into a support diagnostics file.

Drive composer pro provides additional features, such as custom parameter windows, graphical control diagrams of the drive's configuration, and improved monitoring and diagnostics. It also has a graphical interface for configuring functional safety features.

IEC programming of the drive is accomplished with ABB Automation Builder software. Automation Builder can also be used as an alternative configuration tool to Drive composer. It supports several ABB automation products, such as drives, PLCs, HMIs and robots.



—
01

PC tools

Ordering code	Description	PC tool
3AUA0000108087	PC tool for setup, commissioning and monitoring of drives	Drive composer pro
	Automation Builder 2.x Basic (1). Free 61131-3 engineering for simple PLC solutions.	
1SAS010000R0102	Automation Builder 2.x Standard (2). Integrated engineering for PLC, drives, motion, SCADA and panels.	Automation Builder ¹⁾
1SAS010002R0102	Automation Builder 2.x Premium (5). Integrated Engineering and features for engineering productivity and collaboration.	
+N8010	License key for drive application programming based on IEC 61131-3 using Automation Builder	IEC programming

¹⁾ For IEC programming license key is needed for the ACS880 drive (+N8010)

Remote monitoring options

—
01 Remote monitoring tool NETA-21

—
02 RMDE reliability monitoring device

Remote monitoring access worldwide

The NETA-21 remote monitoring tool gives easy access to the drive via the Internet or a local Ethernet network. NETA-21 comes with a built-in web server. Compatible with standard web browsers, it ensures easy access to a web-based user interface. Through the web interface, the user can configure drive parameters, and monitor drive log data, load levels, runtime, energy consumption, I/O data, and the bearing temperatures of the motor connected to the drive. One NETA-21 supports up to 10 ABB single drives.



—
01

RMDE reliability monitoring device

The RMDE reliability monitoring device collects drive performance and event data so that it can be stored remotely and utilized for service, maintenance and troubleshooting. RMDE consists of the NETA-21 remote monitoring tool, a modem, and environmental sensors that enable collection of measured ambient temperature and humidity values. The device comes in a compact IP54 enclosure, making it suitable even for harsh environments.

—
Remote monitoring option

Ordering code	Description	Type
3AUA0000094517	2 x panel bus interface 2 x 32 = max. 10 drives 2 x Ethernet interface SD memory card USB port for WLAN/3G	NETA-21



—
02

—
RMDE reliability monitoring device

Ordering code	Description	Type
RMDE-01-1-1 Configurable product	RMDE reliability monitoring device	RMDE-01

Additional interface options

—
01 FEN-01 TTL encoder
interface module

—
02 FDCO-01 DDCS
communication module

Speed feedback interfaces for precise process control

ACS880 drives can be connected to various feedback devices, such as HTL pulse encoders, TTL pulse encoders, absolute encoders and resolvers. The optional feedback module is installed in the option slot on the drive.

It is possible to use two feedback modules at the same time, either of the same type or different types*.

* Excluding FSE-31.



—
01

Feedback interface modules

Option code	Description	Feedback module
+L517	2 inputs (TTL pulse encoder), 1 output	FEN-01
+L518	2 inputs (SinCos absolute, TTL pulse encoder), 1 output	FEN-11
+L516	2 inputs (Resolver, TTL pulse encoder), 1 output	FEN-21
+L502	1 input (HTL pulse encoder), 1 output	FEN-31
+L521	Pulse encoder interface for functional safety (for more details see section "Safety options")	FSE-31



—
02

DDCS communication option modules

The FDCO-0X optical DDCS communication options are add-on modules on the ACS880 industrial drives control unit. The modules include connectors for two fiber optic DDCS channels. The FDCO-0X modules make it possible to perform master-follower and AC800 M communication. Alternative way for drive to drive communication is to use the standard RS485 connection.

Optical communication modules

Option code	Description	Module
+L503	Optical DDCS (10 Mbd/10 Mbd)	FDCO-01
+L508	Optical DDCS (5 Mbd/10 Mbd)	FDCO-02

Safety options

—
01 ACS880 drive
with FSO-12

Integrated safety

Integrated safety reduces the need for external safety components, simplifying configuration and reducing installation space. The safety functionality is a built-in feature of the ACS880, with safe torque off (STO) as standard. The STO function corresponds to an uncontrolled stop in accordance with stop category 0 of EN 60204-1. Additional safety functions can be commissioned with the optional and compact safety functions module. ACS880 drives offer functional safety with or without encoder. The drives' functional safety is designed in accordance with EN/IEC 61800-5-2 and complies with the requirements of the European Union Machinery Directive (2006/42/EC).



—
01

Safety function modules

Option code	Description	Safety module
+Q973	Safety functions module FSO-12	FSO-12
+Q972+L521	Safety functions module FSO-21 and encoder FSE-31	FSO-21+FSE-31
+Q971	ATEX-certified safe disconnection function, EX II (2) GD	
+L536	Thermistor protection module FPTC-01	FPTC-01
+L537	ATEX-certified thermistor protection module FPTC-02	FPTC-02

The safety functions modules

The safety functions module (FSO-12 and -21) is easy to connect and configure, and offers a wide range of safety functions and a self-diagnostic function that meets current safety requirements and standards, all in one compact module. The safety functions are seamlessly integrated with the drive functionality. This reduces engineering time and implementation of the safety functions compared to using external safety components. Typically this also results in reduced total cost and size and increased reliability.

The safety functions module enables safety functions with or without an encoder. If the application requires safe encoder feedback, it can be established with the safety-certified FSE-31 pulse encoder interface module. The FSE module provides safe encoder data to the safety functions module, and can simultaneously be used as a feedback device for the drive.

Commissioning and configuration of the safety functions module is done with the Drive composer pro PC tool, which provides an easy-to-use graphical user interface. Larger safety systems can be built using PROFIsafe over PROFINET connection between a safety PLC (such as AC500-S) and the ACS880 drive. The connection is achieved using the FENA-21 or FPNO-21 fieldbus adapter module and the safety functions module.

The safety functions module can also be ordered as a spare part kit and installed afterwards to the drive. The kit includes most common assembly accessories for ACS880 drives.

The module supports the following safety functions (which achieve a safety level up to SIL 3 or PL e (Cat. 3)):

- **Safe stop 1 (SS1)** brings the machine to a stop using a monitored deceleration ramp. It is

typically used in applications where the machinery motion needs to be brought to a stop (stop category 1) in a controlled way before switching over to the no-torque (STO) state.

- **Safe stop emergency (SSE)** can be configured to, upon request, either activate STO instantly (category 0 stop), or first initiate motor deceleration and then, once the motor has stopped, activate the STO (category 1 stop).
- **Safe brake control (SBC)** provides a safe output for controlling the motor's external (mechanical) brakes, together with STO.
- **Safely-limited speed (SLS)** ensures that the specified speed limit of the motor is not exceeded. This allows machine interaction to be performed at slow speed without stopping the drive. The safety function module comes with four individual SLS settings for speed monitoring.
- **Safe maximum speed (SMS)** monitors that the speed of the motor does not exceed the configured maximum speed limit.
- **Prevention of unexpected startup (POUS)** ensures that the machine remains stopped when people are in the danger area.
- **Safe direction (SDI)** ensures that rotation is allowed only in the selected direction (available only with FSO-21 and FSE-31).
- **Safe speed monitor (SSM)** provides a safe output signal to indicate whether the motor speed is between user-defined limits (available only with FSO-21).

Safe Torque Off (STO) over PROFIsafe: STO is a standard feature of the ACS880. But if STO needs to be used over fieldbus, it can be accomplished with the safety functions module.

Safe temperature monitoring (STM) can be done by using FPTC thermistor protection modules. These modules have SIL 2 or PL c safety level.

EMC – electromagnetic compatibility

—
01 Immunity and
emission compatibility

Each ACS880 model can be equipped with a built-in filter to reduce high-frequency emissions.

EMC standards

The EMC product standard (EN 61800-3) covers the specific EMC requirements for drives (tested with motor and motor cable) within the EU. EMC standards such as EN 55011 or EN 61000-6-3/4 are applicable to industrial and domestic equipment and systems, including the components inside the drive. Drive units compliant with EN 61800-3 are also compliant with comparable categories in EN 55011 and EN 61000-6-3/4, but not necessarily vice versa. EN 55011 and EN 61000-6-3/4 do not specify cable length or require a motor to be connected as a load. The emission limits are comparable

to EMC standards according to the table on the next page.

Domestic environments versus public low voltage networks

The first environment includes domestic premises. It also includes establishments directly connected without an intermediate transformer to a low-voltage power supply network that supplies buildings used for domestic purposes.

The second environment includes all establishments other than those directly connected to a low-voltage power supply network that supplies buildings used for domestic purposes.

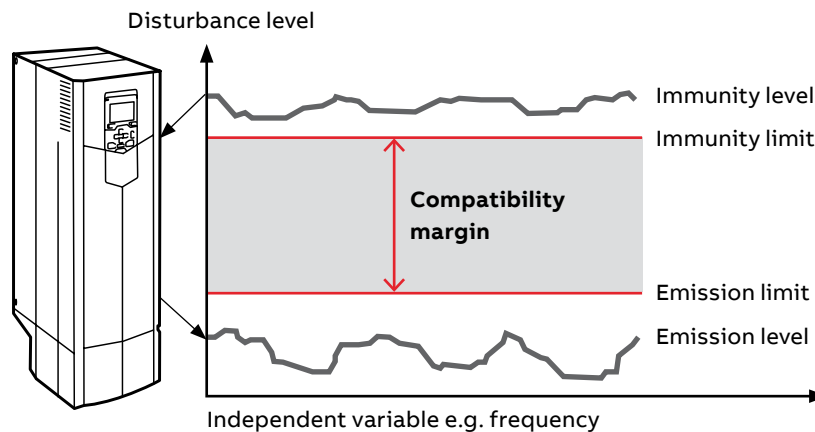

—
01

EMC standards				
EMC according to EN 61800-3:2004 + A1:2012 product standard	EN 61800-3 product standard	EN 55011, product family standard for industrial, scientific and medical (ISM) equipment	EN 61000-6-4, generic emission standard for industrial environments	EN 61000-6-3, generic emission standard for residential, commercial and light-industrial environment
1 st environment, unrestricted distribution	Category C1	Group 1. Class B	Not applicable	Applicable
1 st environment, restricted distribution	Category C2	Group 1. Class A	Applicable	Not applicable
2 nd environment, unrestricted distribution	Category C3	Group 2. Class A	Not applicable	Not applicable
2 nd environment, restricted distribution	Category C4	Not applicable	Not applicable	Not applicable

Selecting an EMC filter

Drive type	Voltage (V)	Frame sizes	1st environment, restricted distribution, C2, grounded network (TN) Option code	2nd environment, C3, grounded network (TN) Option code	2nd environment, C3, ungrounded network (IT) Option code¹⁾	2nd environment, C3, grounded/ ungrounded network (TN/IT) Option code	2nd environment, C4, grounded network (TN)
ACS880-01	380 to 500	R1 to R9	+E202	+E200	+E201 ¹⁾	-	As standard
ACS880-01	690	R3 to R9	-	+E200	+E201 ¹⁾	-	As standard
ACS880-07	380 to 500	R6 to R9	+E202	+E200	+E201	-	As standard
ACS880-07	690	R6 to R9	-	+E200	+E201 (R7 to R9 frame size)	-	As standard
ACS880-07	380 to 690	R10 to R11	+E202 (not for 690 V)	+E200 (not for 400 V/500 V)	+E201 (not for 400 V/500 V)	+E210 (not for 690 V)	As standard
ACS880-07	380 to 690	n×R8i	+E202 (only for 1140A-3 and 1070A-5)	-	-	As standard	As standard
ACS880-17	380 to 690	R8 to R11	+E202 (not for 690 V)	+E200 (only for R8)	+E201 (only for R8)	As standard for R11	As standard
ACS880-17	380 to 690	n×R8i	+E202 (not for 690 V, only for 1xR8i)	-	-	As standard	As standard
ACS880-37	380 to 690	R8 to R11	+E202 (not for 690 V)	+E200 (only for R8)	+E201 (only for R8)	As standard for R11	As standard
ACS880-37	380 to 690	n×R8i	+E202 (not for 690 V, only for 1xR8i)	-	-	As standard	As standard

¹⁾ 2nd environment, C4: ACS880-01, 380 to 500 V, frame sizes R1 to R5. ACS880-01, 690 V, frame sizes R3 to R6.

ABB automation products

AC500

ABB's powerful flagship PLC provides a wide range of performance levels and scalability within a single simple concept, where most competitors require multiple product ranges to deliver similar functionality.



AC500-S

A PLC-based modular automation solution that makes it easier than ever to mix and match standard and safety I/O modules to expertly meet your safety requirements in all functional safety applications. An "extreme conditions" version is also available.



Programmability

Automation Builder integrates the engineering and maintenance of PLCs, drives, motion, HMI and robotics. It complies with the IEC 61131-3 standard, offering all five IEC programming languages for PLC and drive configuration. Automation Builder supports a number of languages and comes with new libraries, FTP functions, SMTP, SNTP, smart diagnostics and debugging capabilities.



AC motors

ABB's low voltage AC motors are designed to save energy, reduce operating costs and enable demanding motor applications to perform reliably and without unscheduled downtime. General performance motors seamlessly combine convenience and easy handling with ABB's engineering expertise. Process performance motors provide the most comprehensive, versatile set of motors for process industries and heavy-duty applications.



AC500-eCo

Meets the cost-effectiveness demands of the small PLC market, while offering total inter-operability with the core AC500 range. Web server, FTP server and Modbus TCP for all Ethernet versions. A Pulse Train output module is available for multi-axis positioning.



AC500-XC

"Extreme conditions" modules with extended operating temperature, immunity to vibration and hazardous gases, for use at high altitudes, in humid conditions, etc. It replaces expensive cabinets with its built-in protection.

**Control panels**

Our control panels offer a wide range of touchscreen graphical displays, from 3.5" up to 15". They are provided with user-friendly configuration software that enables customized HMI solutions. Rich sets of graphical symbols and the relevant drivers for ABB automation products are provided. Control panels for visualization of AC500 web server applications are available.

**All-compatible drives portfolio**

The all-compatible drives share the same architecture: software platform, tools, user interface and options. Yet, there is an optimal drive from the smallest water pump to the biggest cement kiln, and everything in the between. When you have learned to use one drive, it is easy use any of the other drives in the portfolio.

**Jokab Safety products**

ABB Jokab Safety offers an extensive range of innovative products and solutions for machine safety systems. It is represented in standardization organizations for machine safety and works daily with the practical application of safety requirements in combination with production requirements.



Services to match your needs

Your service needs depend on your operation, life cycle of your equipment and business priorities. We have identified our customers' four most common needs and defined service options to satisfy them. What is your choice to keep your drives at peak performance?

Is uptime your priority?

Keep your drives running with precisely planned and executed maintenance.

Example services include:

- ABB Ability Life Cycle Assessment
- Installation and Commissioning
- Spare Parts
- Preventive Maintenance
- Reconditioning
- ABB Drive Care agreement
- Drive Exchange

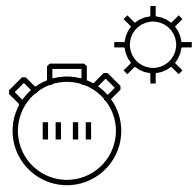

Operational efficiency

Is rapid response a key consideration?

If your drives require immediate action, our global network is at your service.

Example services include:

- Technical Support
- On-site Repair
- ABB Ability Remote Assistance
- Response time agreements
- Training

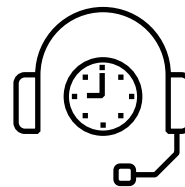

Rapid response

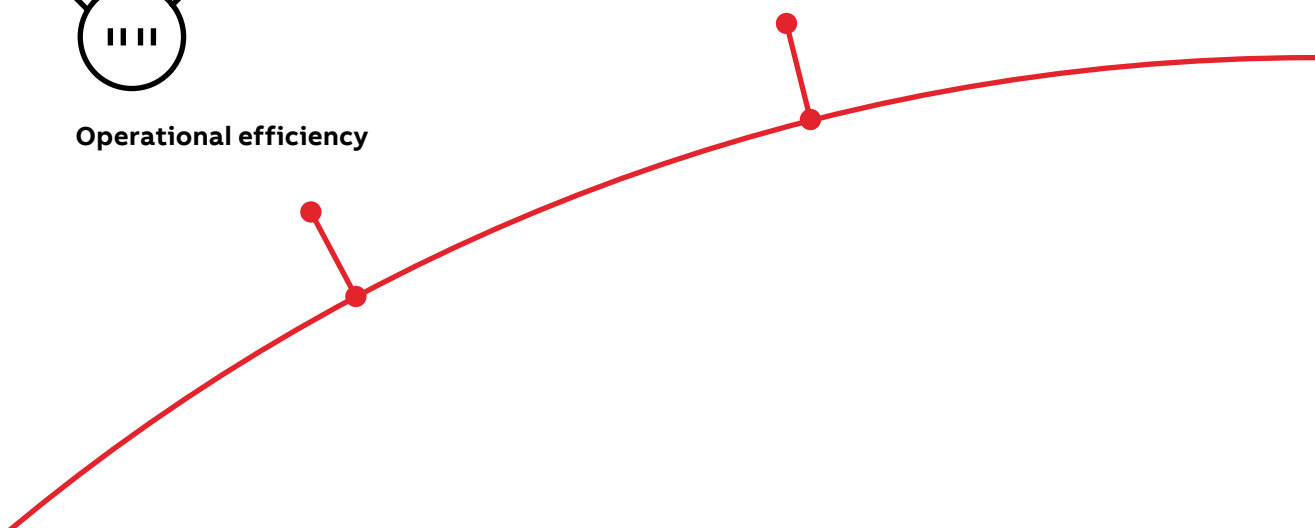

Drives service

Your choice, your future

The future of your drives depends on the service you choose.

Whatever you choose, it should be a well-informed decision. No guesswork. We have the expertise and experience to help you find and implement the right service for your drive equipment. You can start by asking yourself these two critical questions:

- Why should my drive be serviced?
- What would my optimal service options be?

From here, you have our guidance and full support along the course you take, throughout the entire lifetime of your drives.

Need to extend your assets' lifetime?

Maximize your drive's lifetime with our services.

Example services include:

- ABB Ability Life Cycle Assessment
- Upgrades, Retrofits and Modernization
- Replacement, Disposal and Recycling

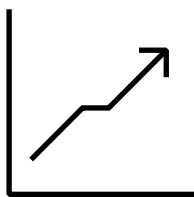

Life cycle management

Your choice, your business efficiency

ABB Drive Care agreement lets you focus on your core business. A selection of predefined service options matching your needs provides optimal, more reliable performance, extended drive lifetime and improved cost control. So you can reduce the risk of unplanned downtime and find it easier to budget for maintenance.

We can help you more by knowing where you are!

Register your drive at www.abb.com/drivereg for extended warranty options and other benefits.

Is performance most critical to your operation?

Get optimal performance out of your machinery and systems.

Example services include:

- ABB Ability Remote Services
- Engineering and Consulting
- Inspection and Diagnostics
- Upgrades, Retrofits and Modernization
- Workshop Repair
- Tailored services

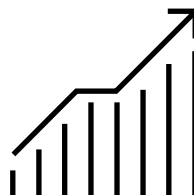

Performance improvement

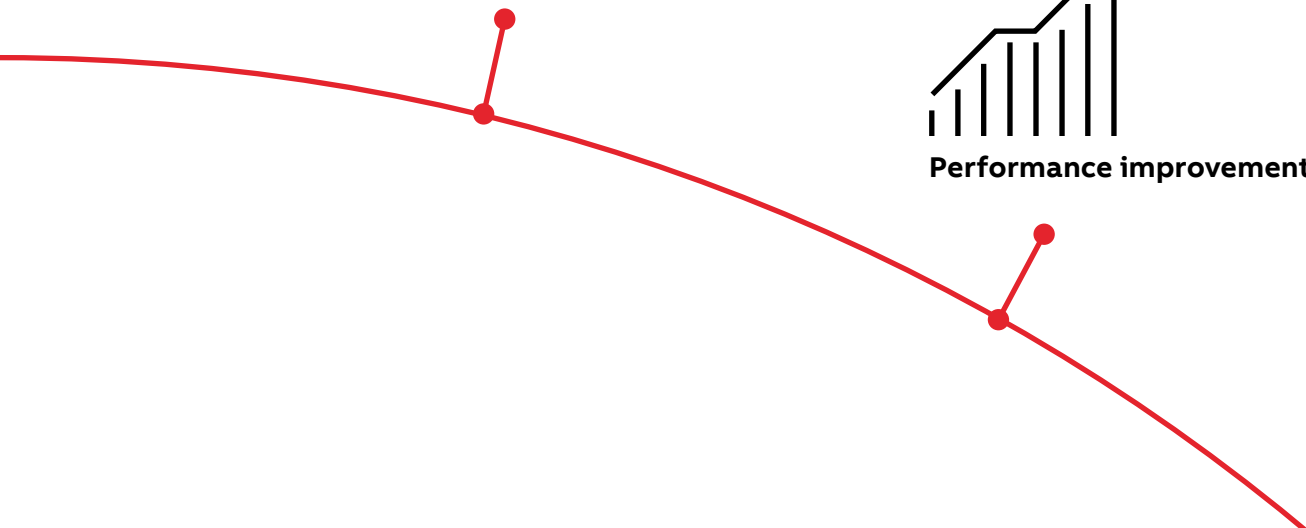

A lifetime of peak performance

You're in control of every life cycle phase of your drives. At the heart of drive services is a four-phase product life cycle management model. This model defines the services recommended and available throughout drives lifespan.

Now it's easy for you to see the exact service and maintenance available for your drives.

ABB drives life cycle phases explained:

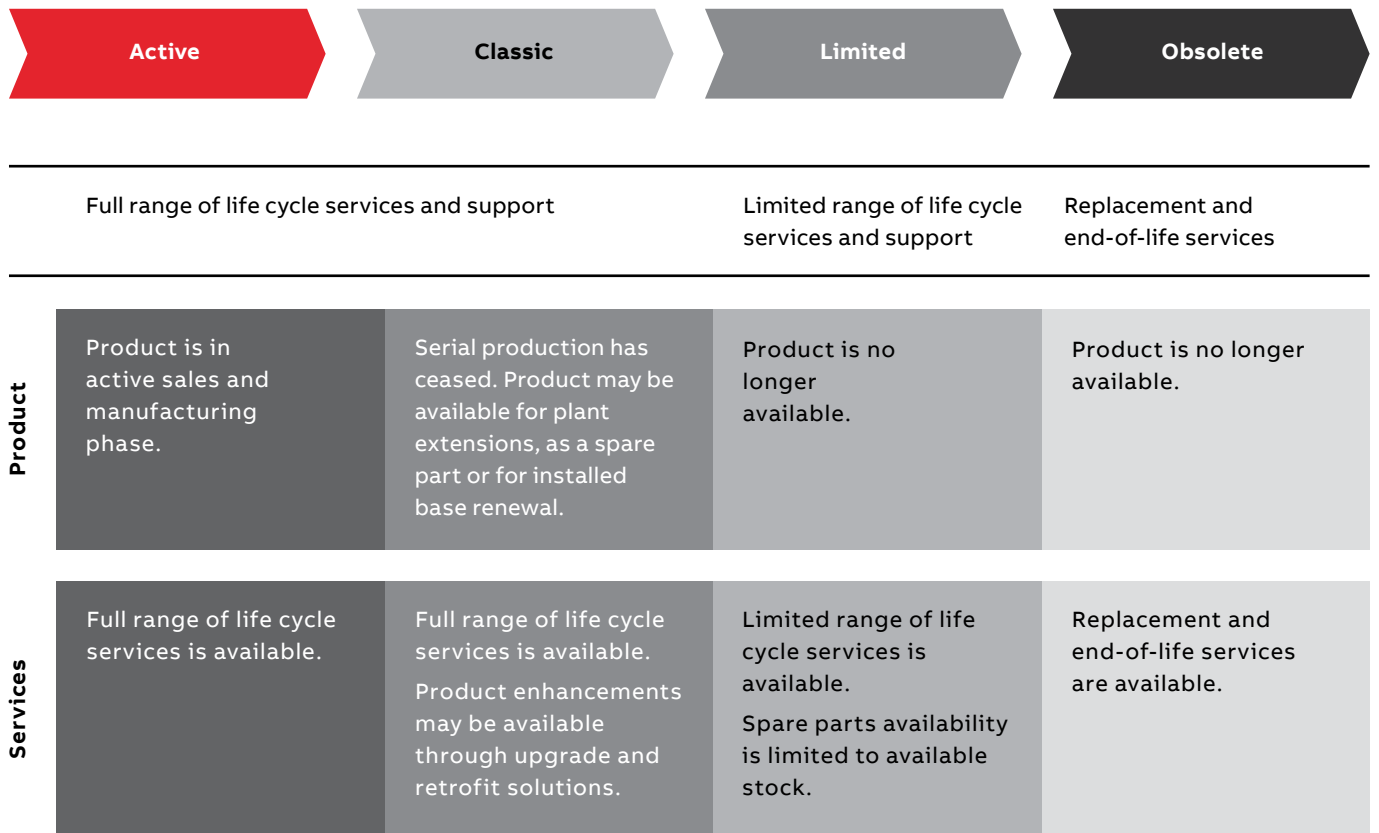

Keeping you informed

We notify you every step of the way using life cycle status statements and announcements.

Your benefit is clear information about your drives' status and precise services available. It helps you plan the preferred service actions ahead of time and make sure that continuous support is always available.

Step 1

Life Cycle Status Announcement

Provides early information about the upcoming life cycle phase change and how it affects the availability of services.

Step 2

Life Cycle Status Statement

Provides information about the drive's current life cycle status, availability of product and services, life cycle plan and recommended actions.



Summary of features and options

	Ordering code	ACS880-01 R1 to R9	ACS880-07 R6 to R11	ACS880-07 nxR8i	ACS880- 17/37 R8 to R11	ACS880- 17/37 nxR8i ⁹⁾
Mounting						
Wall-mounting		●	-	-	-	-
For cabinet mounting	+P940	□	-	-	-	-
	+P944	□	-	-	-	-
Cabinet-built		-	●	●	●	●
Flange mounting	+C135	□ ¹⁶⁾	-	-	-	-
Cabling						
Bottom entry and exit		●	●	●	●	●
Top entry and exit		-	□	□	□	□
Degree of protection						
UL type 1 (IP20)	+P940	□	-	-	-	-
	+P944	□	-	-	-	-
UL type 1 (IP21)		●	-	-	-	-
UL type 1 (IP22)		-	●	●	●	●
UL type 1 (IP42)	+B054	-	□	□	□	□
UL type 12 (IP54)	+B055	-	□	□	□	□
UL type 12 (IP55)	+B056	□	-	-	-	-
Motor control						
DTC motor control		●	●	●	●	●
Control panel						
Intuitive control panel		● ¹⁾	●	●	●	●
Integrated control panel holder in the drive		●	-	-	-	-
Control panel mounting platform DPMP-01 (flush) / DPMP-02 (surface)		■	-	-	-	-
EMC filters						
EMC 1 st environment, restricted distribution, C2, grounded network (TN)	+E202	□ ²⁾	□ ²⁾	□ ¹⁸⁾	□ ²¹⁾	□ ²⁴⁾
EMC 2 nd environment, C3, grounded network (TN)	+E200	□ ³⁾	□ ³⁾	-	□ ²²⁾	-
EMC 2 nd environment, C3, ungrounded network (IT)	+E201	□ ⁴⁾	□ ⁴⁾	-	□ ²⁵⁾	-
EMC 2 nd environment, C3, grounded (TN) and ungrounded (IT)	+E210	-	□ ⁵⁾	●	● ²³⁾	●
Line filter						
AC or DC choke		●	●	●	-	-
LCL		-	-	-	●	●
Output filter						
Common mode filter	+E208	□	□	●	□	●
du/dt filters	+E205	■	□	●	□	●
Braking						
Brake chopper	+D150	□ ⁶⁾	□	□ ⁷⁾	□	-
Brake Resistors*						

* PowerOhm resistors are used for these products

	Ordering code	ACS880-01 R1 to R9	ACS880-07 R6 to R11	ACS880-07 nxR8i	ACS880-17/37 R8 to R11	ACS880-17/37 nxR8i ⁹⁾
Software						
Primary control program		●	●	●	●	●
Drive application programming based on IEC 61131-3 using Automation Builder	+N8010	□	□	□	□	□
Application control program for winder	+N5000	□	□	□	-	□
Application control program for crane	+N5050	□	□	□	-	□
Application control program for winch	+N5100	□	□	□	-	□
Application control program for centrifuge/decanter	+N5150	□	-	-	-	-
Application control program for PCP pump	+N5200	□	□	□	-	□
Application control program for Rod pump	+N5250	□	-	-	-	□
Application control program for test bench	+N5300	□	□	□	-	□
Application control program for cooling tower direct drive	+N5350	□	-	-	-	-
Application control program for override control	+N5450	□	□	□	-	□
Application control program for spinning and traverse	+N5500	□	-	-	-	-
Application control program for ESP pumps	+N5600	□	□	□	-	□
Application control program for tower cranes	+N5650	□	-	-	-	-
Support for asynchronous motor		●	●	●	●	●
Support for permanent magnet motor		●	●	●	●	●
Support for synchronous reluctance motor (SynRM)		●	●	●	●	●
Rectifier bridge						
12-pulse	+A004	-	-	□	-	-
Line side apparatus						
aR line fuses		-	●	●	●	●
Main switch		-	●	●	●	●
Line contactor	+F250	-	□	□ ¹¹⁾	●	● ¹²⁾
Air circuit breaker	+F255	-	-	□ ⁸⁾	-	● ¹³⁾
Earthing switch	+F259	-	-	□	-	□
Cabinet options						
Cabinet heater (ext. supply)	+G300	-	□	□	□	□
Output for motor heater (ext. supply)	+G313	-	□	□	□	□
Customized options	+P902	-	□	□	□	□

	Ordering code	ACS880-01 R1 to R9	ACS880-07 R6 to R11	ACS880-07 nxR8i	ACS880- 17/37 R8 to R11	ACS880- 17/37 nxR8i ⁹⁾
Safety functions²⁰⁾						
Safe torque off (STO)		●	●	●	●	●
Safety functions module, FSO-12, without encoder, programmable functions: - Safe stop 1 (SS1), - Safely-limited speed (SLS) - Safe brake control (SBC) - Safe maximum speed (SMS) - Safe stop emergency (SSE) - Prevention of unexpected startup (POUS) - Safe torque off (STO)	+Q973	□	□	□	□	□
Safety functions module, FSO-21, with encoder support, programmable functions: - Safe stop 1 (SS1) - Safely-limited speed (SLS) - Safe brake control (SBC) - Safe maximum speed (SMS) - Safe stop emergency (SSE) - Prevention of unexpected startup (POUS) - Safe direction (SDI), requires encoder feedback, FSE-31 - Safe speed monitoring (SSM) - Safe torque off (STO)	+Q972	□	□	□	□	□
Pulse encoder interface module, FSE-31	+L521	□	□	□	□	□
Prevention of unexpected startup with safety relay (preconfigured)	+Q957	-	□	□	□	□
Prevention of unexpected startup with FSO-12 and -21 (preconfigured)	+Q950	-	□	□	□	□
Emergency stop, category 0 with opening the main contactor/breaker, with safety relay (preconfigured)	+Q951	-	□	□	□	□
Emergency stop, category 1 with opening the main contactor/breaker, with safety relay (preconfigured)	+Q952	-	□	□	□	□
Emergency stop, category 0 with STO, with safety relay (preconfigured)	+Q963	-	□	□	□	□
Emergency stop, category 1 with STO, with safety relay (preconfigured)	+Q964	-	□	□	□	□
Emergency stop, configurable category 0 or 1 with opening the main contactor/breaker, with FSO-12 and -21 (preconfigured)	+Q978	-	□	□	□	□
Emergency stop, configurable category 0 or 1 with STO and FSO-12 and -21 (preconfigured)	+Q979	-	□	□	□	□
Safely-limited speed with encoder, with FSO-21 and FSE-31 (preconfigured)	+Q965	-	□	□	□	□
ATEX certified thermistor protection module, FPTC-02	+L537 +Q971	□	□	□	□	□
ATEX thermal motor protection PTC/Pt100, Ex II (2) GD	+L513/+L514 +Q971	-	□	□	□	□
Earth fault protection						
Earth fault monitoring, earthed mains		●	●	●	●	●
Earth fault monitoring, unearthed mains	+Q954	-	□	□	□	□

	Ordering code	ACS880-01 R1 to R9	ACS880-07 R6 to R11	ACS880-07 nxR8i	ACS880- 17/37 R8 to R11	ACS880- 17/37 nxR8i ⁹⁾
Control connections (I/O) and communications						
2 pcs analog inputs, programmable, galvanically isolated		●	●	●	●	●
2 pcs analog outputs, programmable		●	●	●	●	●
6 pcs digital inputs, programmable, galvanically isolated - can be divided into two groups		●	●	●	●	●
2 pcs digital inputs/outputs		●	●	●	●	●
1 pcs digital input interlock		●	●	●	●	●
3 pcs relay outputs programmable		●	●	●	●	●
Drive-to-drive link/Built-in Modbus		●	●	●	●	●
Assistant control panel/PC tool connection		●	●	●	●	●
Possibility for external power supply for control unit		●	●	●	●	●
Built-in I/O extension and speed feedback modules: for more details see sections: "Input/output extension modules", "Speed feedback interfaces for precise process control" and "DACS communication option modules" ²⁰⁾		□	□	□	□	□
Built-in adapters for several fieldbuses: for more details see section "Fieldbus adapter modules" ²⁰⁾		□	□	□	□	□
Approvals						
CE		●	●	●	●	●
UL, cUL	+C129	●	□	□	□	□
CSA	+C134	●	□	□	□	□
EAC/GOST R ¹⁰⁾		●	●	●	●	●
RoHS		●	●	●	●	●
RCM		●	●	●	●	●
Marine type approvals	+C132	□ ¹⁴⁾	□ ⁹⁾¹⁹⁾	□ ⁹⁾¹⁹⁾	□ ⁹⁾	□ ⁹⁾
Marine design requires project approval	+C121	–	□	□	□	□
Marine product certification for essential applications		□ ⁹⁾	9)	9)	–	–
TÜV nord certificate for safety functions		●	●	●	●	●
VTT ATEX protective device certificate	+Q971	□	□	□	□	□
SEMI F47		●	●	●	●	●

● Standard

□ Selectable option, with plus code

■ Selectable option, external, no plus code

– Not available

¹⁾ Without control panel, +0J400²⁾ Grounded network: Frame sizes R1 to R9, 380 to 500 V (-01). Frame sizes R6 to R11, 380 to 500 V (-07). Not for 690 V.³⁾ Grounded network: Frame sizes R1 to R9, 380 to 500 V (-01). Frame sizes R3 to R9, 690 V (-01). Frame sizes R6 to R9, 380 to 690 V (-07). Frame sizes R10 to R11, only for 690 V (-07).⁴⁾ 2nd environment, C4: Frame sizes R1 to R5, 380 to 500 V (-01). Frame sizes R3 to R6, 690 V (-01). Ungrounded network: Frame sizes R6 to R9, 380 to 500 V (-01). Frame sizes R7 to R9, 690 V (-01). Frame sizes R6 to R9, 380 to 500 V (-07). Frame sizes R7 to R11, 690 V (-07).⁵⁾ Grounded/ungrounded network frame sizes R10 to R11, 380 to 500 V (-07). Not for 690 V.⁶⁾ Frame sizes R1 to R4 built-in and R5 to R9 as selectable option⁷⁾ 2×R8i⁸⁾ 2×D8T to 4×D8T⁹⁾ Check availability from local ABB¹⁰⁾ EAC has replaced GOST R¹¹⁾ D8T, 2×D7T and 2×D8T¹²⁾ R8i to 2×R8i, 400 to 500 V. R8i to 3×R8i, 690 V¹³⁾ 3×R8i, 400 to 500 V. 4×R8i and 6×R8i, 690 V¹⁴⁾ Marine type approvals for ACS880-01 (ABS, Bureau veritas, CCS, DNV GL, Lloyd's, NK, RINA)¹⁵⁾ For cabinet-built drives (-07)¹⁶⁾ Available only with IP20 (P940 or P944)¹⁷⁾ +E202 for frame size R8: Please contact ABB to check availability.¹⁸⁾ Grounded network, only for 1140A-3 and 1070A-5 (-07 nxR8i)¹⁹⁾ Marine type approvals for ACS880-07 pending (ABS, Bureau veritas, CCS, DNV GL, Lloyd's)²⁰⁾ Three option slots are available for I/O extension, speed feedback, fieldbus and functional safety options. The slot number for I/O and encoder options can be extended with FEA-03 option. Please note that functional safety and fieldbus options cannot be used with FEA-03. With frame R6 and bigger frames, the functional safety module, FSO-xx, can be mounted into a separate option slot, which does not consume the slots for other options.²¹⁾ Grounded network, frame sizes R8 to R11, 380 to 500 V (-17, -37). Not for 690 V.²²⁾ Grounded network, only for frame size R8, 380 to 690 V (-17, -37)²³⁾ Grounded/ungrounded network as standard for frame size R11 (-17, -37)²⁴⁾ Grounded network, frame size 1xR8i, 380 to 500 V (-17, -37). Not for 690 V.²⁵⁾ Ungrounded network only for frame size R8, 380 to 690 V (-17, -37)

Additional information

We reserve the right to make technical changes or modify the contents of this document without prior notice. With regard to purchase orders, the agreed particulars shall prevail. ABB does not accept any responsibility whatsoever for potential errors or possible lack of information in this document.

We reserve all rights in this document and in the subject matter and illustrations contained therein. Any reproduction, disclosure to third parties or utilization of its contents – in whole or in parts – is forbidden without prior written consent of ABB.

—
For more information, please contact
your local ABB representative or visit

www.abb.com/ACS880
www.abb.com/drives

Video playlist:
ACS880 how-to videos

