

Features

- 15" Active Matrix TFT LCD
- Max Resolution at 1024 x 768
- 5-Wire Resistive Touch Screen
- NEMA 4/4X Front Bezel
- VGA and DVI Input
- 24VDC Input Option Available



RS-232
Touch



USB 2.0
Touch



VGA
Input



DVI
Input

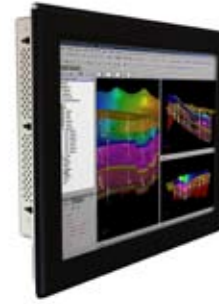

ADM-1815BP



Specifications	ADM-1815 BP	Line Drawing
LCD Display		
Display Size (Diagnol)	15 inch	
Resolution	1024 x 768	
Backlight Lifetime (Hours)	30,000	
Visual Characteristics		
Colors	16 Million	
Aspect ratio	4:3	
Viewing angle (V/H)	120° / 130°	
Response time(Typical)	12 ms	
Pixel Pitch(mm)	0.297 x 0.297	
Contrast ratio	500:1	
Brightness	250 nits	
Input Interface		
VGA	Yes	
DVI	Yes	
S-Video	N/A	
Composite Video	N/A	
Component Video	N/A	
Touch Screen		
Technology	5 Wire Resistive	
Touch rating	35 Million Touches	
MTBF	490,000 hours	
Interface	RS-232, USB	
Driver	WinCE, WinXP Pro	
Front Bezel		
NEMA 4	Black Powder Coated	
NEMA 4x	Stainless Steel (Optional)	
Rack Mount Bezel	N/A	
OS SUPPORT		
OS Support	Win XPe, Win2000, WinXP Pro	
Power/Thermal Specs.		
Power Requirement (Max)	110VAC @ 0.3A, 220VAC @ 0.15A 12VDC @ 2.5A Max, 24VDC @ 1.25A Max	
Power Consumption (Max)	30W	
Heat Dissipation	102 BTU/hr	
Physical Information		
Mounting	Panel Mount	
Net Weight	11 Lb / 4.98 Kg	
Physical Dimension (WxHxD)	14.51 x 11.80 x 1.89 inch (*3.22") 368.6 x 299.8 x 48.0 mm	
Cutout Dimension (WxH)	13.56 x 10.93 inch 344.4 x 277.7 mm	
Environmental		
Operating Temp	0° - 50° C (32° - 122° F)	
Storage Temp	-20° - 60° C (-4° - 140° F)	
Relative Humidity	5% - 95% (non-condensing)	
Rating	NEMA 4/4X Bezel	
Certification	FCC, CE	

*depth including power adaptor

- 1
ARP
1700
Series
- 2
ARP
2200
Series
- 3
ARP
3600
Series
- 4
ARP
5500AX
Series
- 5
ADM
1500
Series
- 6
ADM
1800
Series
- 7
ADM
5800
Series
- 8
ARD
1000
- 9
Box PC
- 10
AMA
Series
- 11
AMS
Series
- 12
AVW
Series
- 13
Thin
Clients
- 14
MPC
Series
- 15
RS
Series



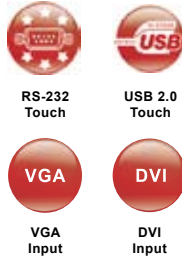

Features

- 17" Active Matrix TFT LCD
- Max Resolution at 1280 x 1024
- 5-Wire Resistive Touch Screen
- NEMA 4/4X Front Bezel
- VGA and DVI Input
- 24VDC Input Option Available

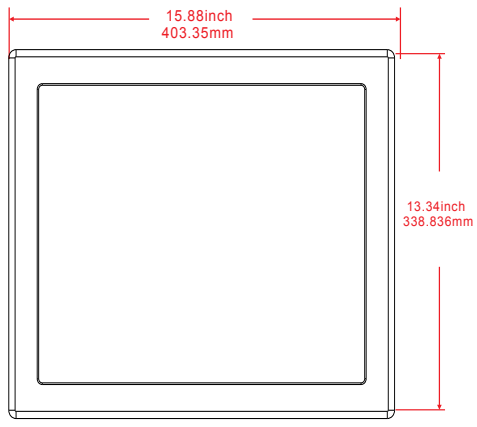
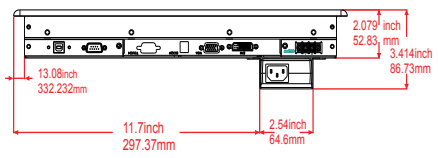
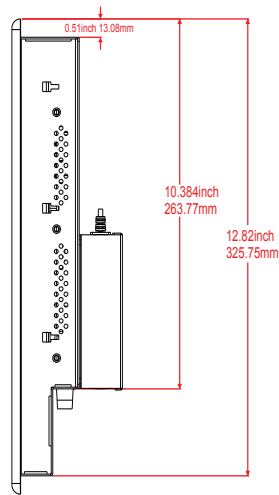

ADM-1817AP

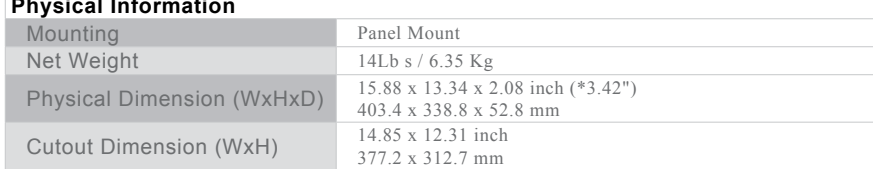
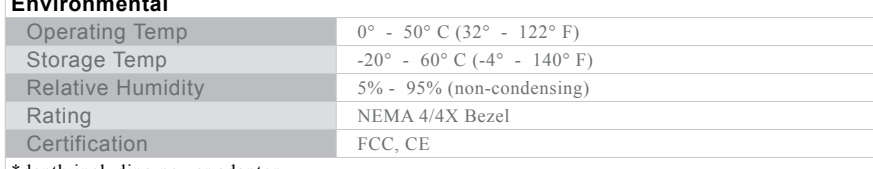
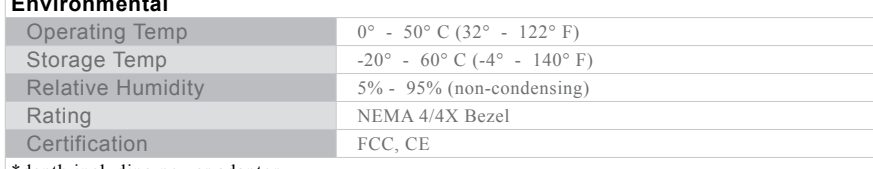

 Specifications	ADM-1817 AP	Line Drawing	
LCD Display			
Display Size (Diagnol)	17 inch		
Resolution	1280 x 1024		
Backlight Lifetime (Hours)	50,000		
Visual Characteristics			
Colors	16 Million		
Aspect ratio	4:3		
Viewing angle (V/H)	140° / 140°		
Response time(Typical)	12 ms		
Pixel Pitch(mm)	0.264 x 0.264		
Contrast ratio	800:1		
Brightness	300 nits		
Input Interface			
VGA	Yes		
DVI	Yes		
S-Video	N/A		
Composite Video	N/A		
Component Video	N/A		
Touch Screen			
Technology	5 Wire Resistive		
Touch rating	35 Million Touches		
MTBF	490,000 hours		
Interface	RS-232, USB		
Driver	WinCE, WinXP Pro		
Front Bezel			
NEMA 4	Black Powder Coated		
NEMA 4x	Stainless Steel (Optional)		
Rack Mount Bezel	N/A		
OS SUPPORT			
OS Support	Win XPe, Win2000, WinXP Pro		
Power/Thermal Specs.			
Power Requirement (Max)	110VAC @ 0.4A, 220VAC @ 0.2A 12VDC @ 3.2A, 24VDC@ 1.6A		
Power Consumption (Max)	38W		
Heat Dissipation	129 BTU/hr		
Physical Information			
Mounting	Panel Mount		
Net Weight	14Lb s / 6.35 Kg		
Physical Dimension (WxHxD)	15.88 x 13.34 x 2.08 inch (*3.42") 403.4 x 338.8 x 52.8 mm		
Cutout Dimension (WxH)	14.85 x 12.31 inch 377.2 x 312.7 mm		
Environmental			
Operating Temp	0° - 50° C (32° - 122° F)		
Storage Temp	-20° - 60° C (-4° - 140° F)		
Relative Humidity	5% - 95% (non-condensing)		
Rating	NEMA 4/4X Bezel		
Certification	FCC, CE		
*depth including power adaptor			

Features

- 19" Active Matrix TFT LCD
- Max Resolution at 1280 x 1024
- 5-Wire Resistive Touch Screen
- NEMA 4/4X Front Bezel
- VGA and DVI Input
- 24VDC Input Option Available

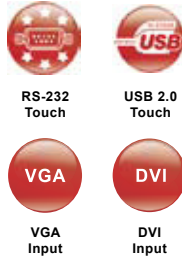

ADM-1819AP



Specifications	ADM-1819 AP	Line Drawing	
LCD Display			
Display Size (Diagnol)	19 inch		
Resolution	1280 x 1024		
Backlight Lifetime (Hours)	50,000		
Visual Characteristics			
Colors	16 Million		
Aspect ratio	4:3		
Viewing angle (V/H)	178° / 178°		
Response time(Typical)	20 ms		
Pixel Pitch(mm)	0.294 x 0.294		
Contrast ratio	700:1		
Brightness	300 nits		
Input Interface			
VGA	Yes		
DVI	Yes		
S-Video	N/A		
Composite Video	N/A		
Component Video	N/A		
Touch Screen			
Technology	5 Wire Resistive		
Touch rating	35 Million Touches		
MTBF	490,000 hours		
Interface	RS-232, USB		
Driver	WinCE, WinXP Pro		
Front Bezel			
NEMA 4	Black Powder Coated		
NEMA 4x	Stainless Steel (Optional)		
Rack Mount Bezel	Black Powder Coated		
OS SUPPORT			
OS Support	Win XPe, Win2000, WinXP Pro		
Power/Thermal Specs.			
Power Requirement (Max)	110VAC @ 0.45A, 220VAC @ 0.25A		
Power Consumption (Max)	45W		
Heat Dissipation	153 BTU/hr		
Physical Information			
Mounting	Panel Mount / Rack Mount		
Net Weight	17Lbs / 7.71 Kg		
Physical Dimension (WxHxD)	17.80 x 14.60 x 2.39 inch (*3.72")		
Panel Mount	452.1 x 370.8 x 60.7 mm		
Cutout Dimension (WxH)	16.81 x 13.61 inch		
Panel Mount	427.0 x 345.7 mm		
Physical Dimension (WxHxD)	17.80 x 14.60 x 2.39 inch		
Rack Mount	452.1 x 370.8 x 60.7 mm		
Environmental			
Operating Temp	0° - 50° C (32° - 122° F)		
Storage Temp	-20° - 60° C (-4° - 140° F)		
Relative Humidity	5% - 95% (non-condensing)		
Rating	NEMA 4/4X Bezel		
Certification	FCC, CE		
*depth including power adaptor			

- 1**
ARP
1700
Series
- 2**
ARP
2200
Series
- 3**
ARP
3600
Series
- 4**
ARP
5500AX
Series
- 5**
ADM
1500
Series
- 6**
ADM
1800
Series
- 7**
ADM
5800
Series
- 8**
ARD
1000
- 9**
Box PC
- 10**
AMA
Series
- 11**
AMS
Series
- 12**
AVW
Series
- 13**
Thin
Clients
- 14**
MPC
Series
- 15**
RS
Series

Features

- 20" Active Matrix TFT LCD
- Max Resolution at 1600 x 1200
- 5-Wire Resistive Touch Screen
- NEMA 4/4X Front Bezel
- VGA and DVI Input
- 24VDC Input Option Available



RS-232
Touch



USB 2.0
Touch



VGA
Input



DVI
Input



ADM-1820AP



Specifications	ADM-1820 AP	Line Drawing
LCD Display		
Display Size (Diagnol)	20.1 inch	
Resolution	1600 x 1200	
Backlight Lifetime (Hours)	50,000	
Visual Characteristics		
Colors	16 Million	
Aspect ratio	4:3	
Viewing angle (V/H)	178° / 178°	
Response time(Typical)	16 ms	
Pixel Pitch(mm)	0.255 x 0.255	
Contrast ratio	1000:1	
Brightness	300 nits	
Input Interface		
VGA	Yes	
DVI	Yes	
S-Video	N/A	
Composite Video	N/A	
Component Video	N/A	
Touch Screen		
Technology	5 Wire Resistive	
Touch rating	35 Million Touches	
MTBF	490,000 hours	
Interface	RS-232, USB	
Driver	WinCE, WinXP Pro	
Front Bezel		
NEMA 4	Black Powder Coated	
NEMA 4x	Stainless Steel (Optional)	
Rack Mount Bezel	Black Powder Coated	
OS SUPPORT		
OS Support	Win XPe, Win2000, WinXP Pro	
Power/Thermal Specs.		
Power Requirement (Max)	110VAC @ 0.6A, 220VAC @ 0.3A 12VDC @ 4.8A, 24VDC@ 2.4A	
Power Consumption (Max)	60W	
Heat Dissipation	204 BTU/hr	
Physical Information		
Mounting	Panel Mount / Rack Mount	
Net Weight	20Lbs / 9.07 Kg	
Physical Dimension (WxHxD) Panel Mount	19.00 x 15.70 x 2.41inch 482.6 x 398.8 x 61.2 mm	
Cutout Dimension (WxH) Panel Mount	17.30 x 14.60 inch 439.4 x 370.8 mm	
Physical Dimension (WxHxD) Rack Mount	19 x 15.7 x 2.41 inch 482.6 x 398.8 x 61.2 mm	
Environmental		
Operating Temp	0° - 50° C (32° - 122° F)	
Storage Temp	-20° - 60° C (-4° - 140° F)	
Relative Humidity	5% - 95% (non-condensing)	
Rating	NEMA 4/4X Bezel	
Certification	FCC, CE	



ADM-1819AP



ADM-1820AP



ADM-1819 AP Line Drawing - Rack Mount

ADM-1820 AP Line Drawing - Rack Mount

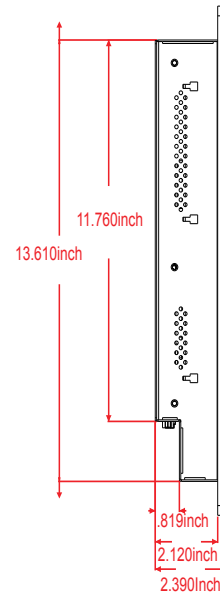
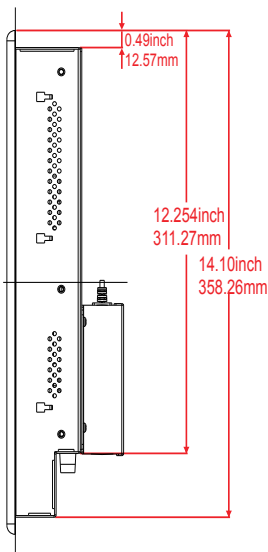
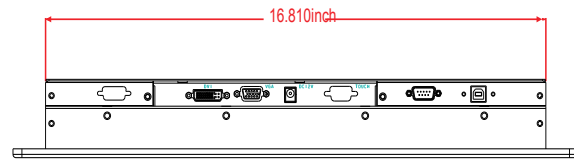
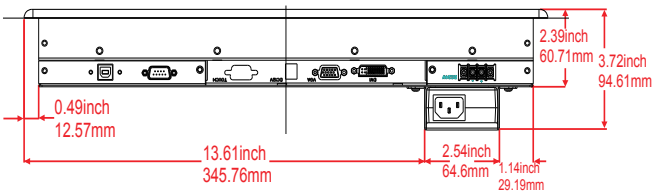
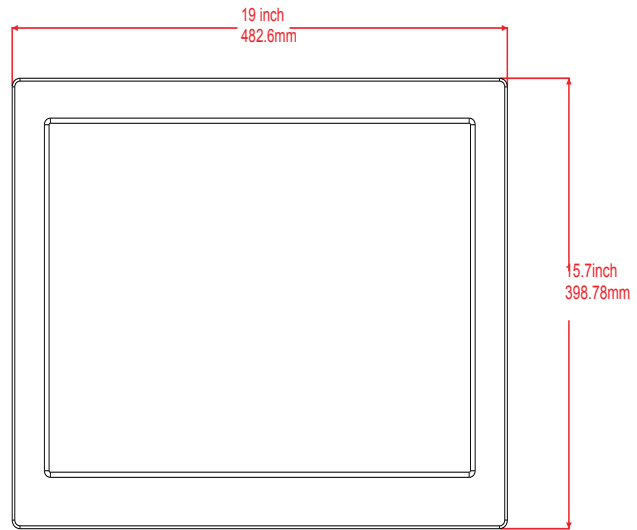
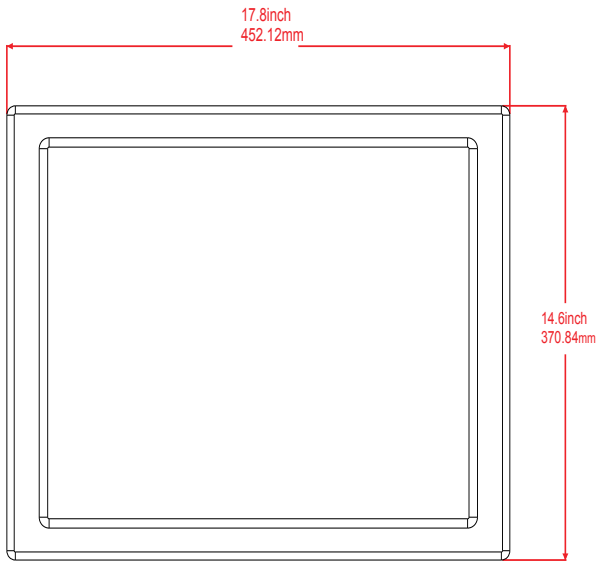

- 1** ARP 1700 Series
- 2** ARP 2200 Series
- 3** ARP 3600 Series
- 4** ARP 5500AX Series
- 5** ADM 1500 Series
- 6** ADM 1800 Series
- 7** ADM 5800 Series
- 8** ARD 1000
- 9** Box PC
- 10** AMA Series
- 11** AMS Series
- 12** AVW Series
- 13** Thin Clients
- 14** MPC Series
- 15** RS Series

Features

- 24" Active Matrix TFT LCD
- 16:9 (Wide) Aspect Ratio
- Max Resolution at 1920 x 1080
- 5-Wire Resistive Touch Screen
- NEMA 4/4X Front Bezel
- VGA and DVI Input
- 24VDC Input Option Available

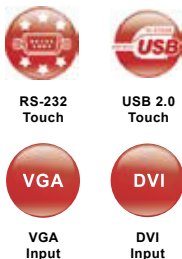

ADM-1824AP

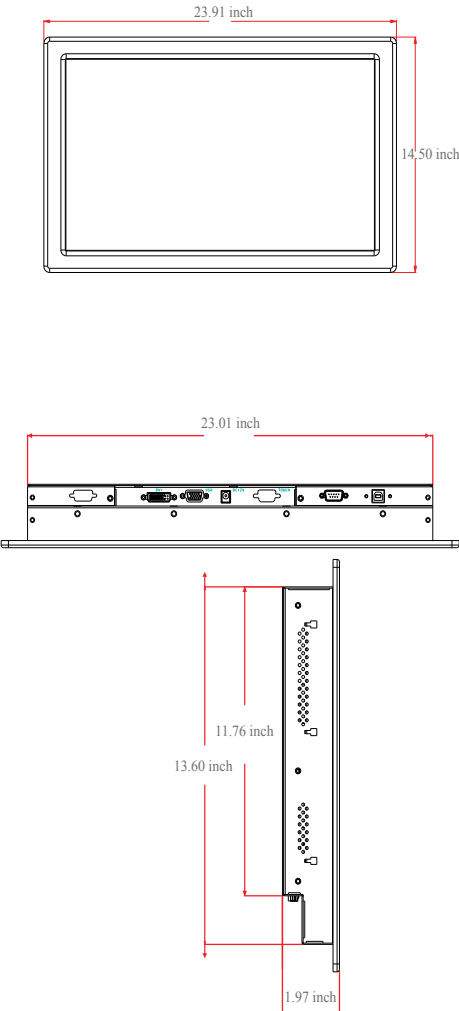
Specifications	ADM-1824 AP	Line Drawing
LCD Display		
Display Size (Diagnol)	24 inch	
Resolution	1920 x 1080	
Backlight Lifetime (Hours)	50,000	
Visual Characteristics		
Colors	16 Million	
Aspect ratio	16:9	
Viewing angle (V/H)	170° / 160°	
Response time(Typical)	16 ms	
Pixel Pitch(mm)	0.277 x 0.277	
Contrast ratio	1000:1	
Brightness	300 nits	
Input Interface		
VGA	Yes	
DVI	Yes	
S-Video	N/A	
Composite Video	N/A	
Component Video	N/A	
Touch Screen		
Technology	5 Wire Resistive	
Touch rating	35 Million Touches	
MTBF	490,000 hours	
Interface	RS-232, USB	
Driver	WinCE, WinXP Pro	
Front Bezel		
NEMA 4	Black Powder Coated	
NEMA 4x	Stainless Steel (Optional)	
OS SUPPORT		
OS Support	Win XPe, Win2000, WinXP Pro	
Power/Thermal Specs.		
Power Requirement (Max)	110VAC @ 0.6A, 220VAC @ 0.3A 12VDC @ 4.8A, 24VDC@ 2.4A	
Power Consumption (Max)	60W	
Heat Dissipation	204 BTU/hr	
Physical Information		
Mounting	Panel Mount	
Net Weight	20 Lbs / 9 Kg	
Physical Dimension (WxHxD)	23.91 x 14.50 x 1.97 inch 607.3 x 368.3 x 50.0 mm	
Cutout Dimension (WxH)	584.6 x 345.6 mm (23.01 x 13.60 inch)	
Environmental		
Operating Temp	0° - 50° C (32° - 122° F)	
Storage Temp	-20° - 60° C (-4° - 140° F)	
Relative Humidity	5% - 95% (non-condensing)	
Rating	NEMA 4/4X Bezel (Panel Mount)	
Certification		

 **Power Supply Line Drawing**

ADM-1815BP, ADM-1817AP, ADM-1819AP Power Adaptor

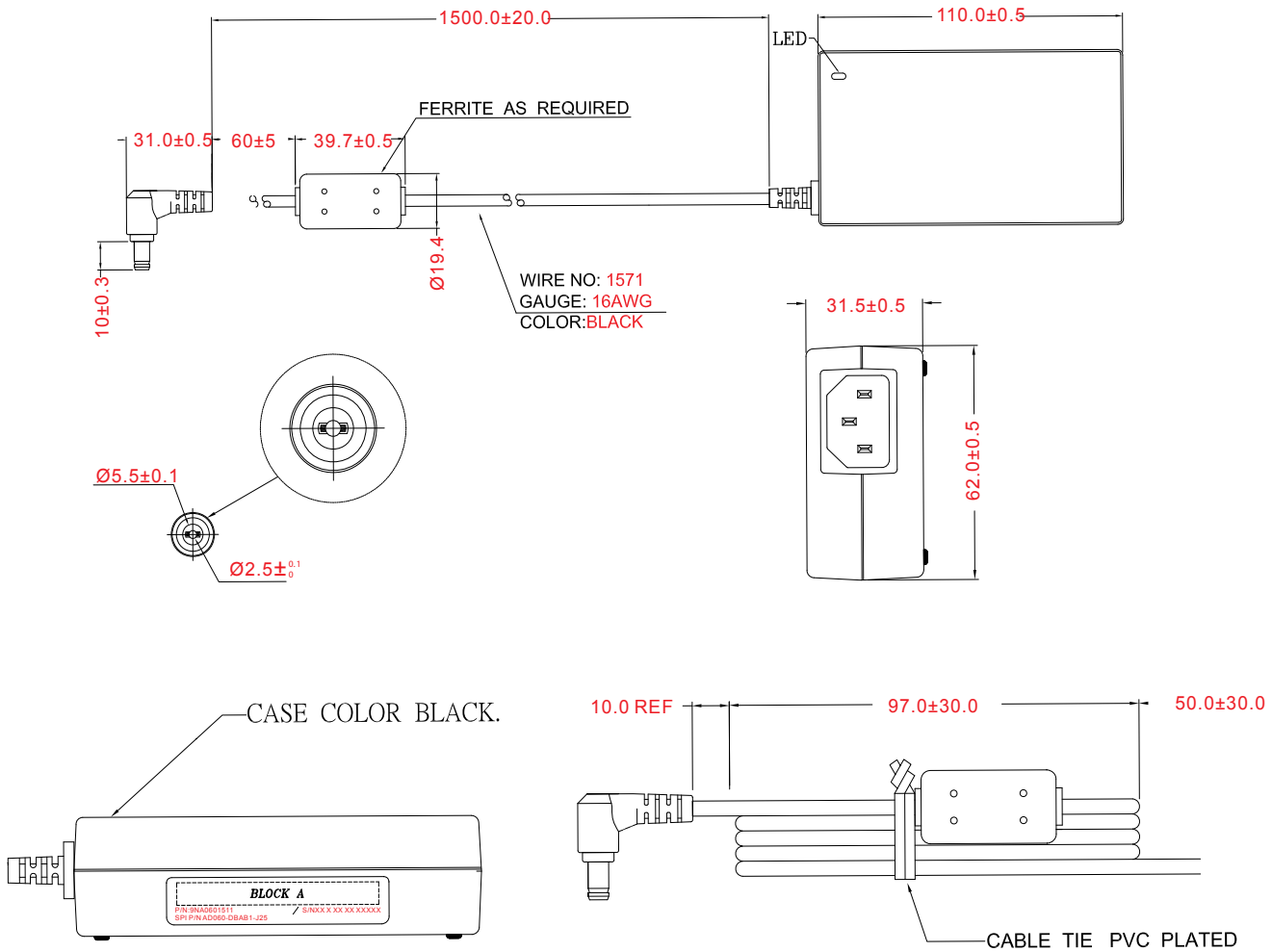

ADM-1820AP Power Adaptor

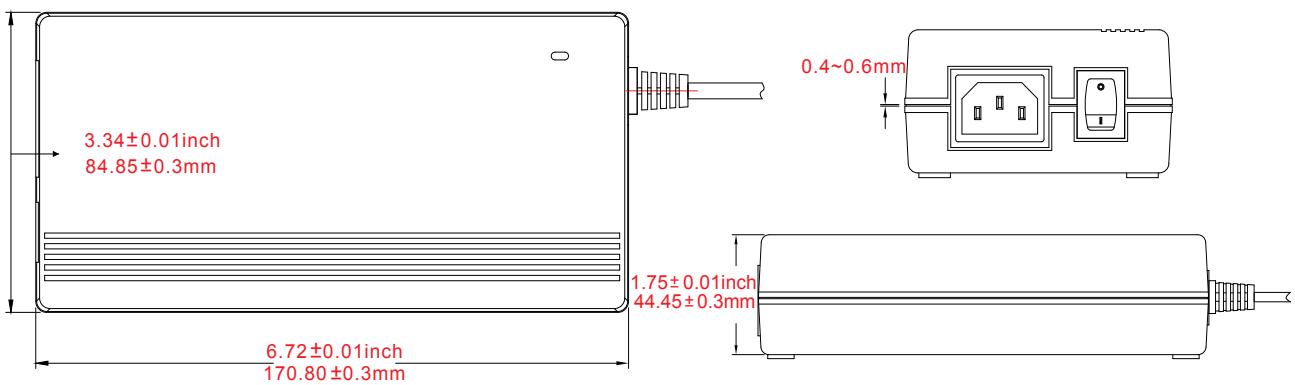

1	ARP 1700 Series
2	ARP 2200 Series
3	ARP 3600 Series
4	ARP 5500AX Series
5	ADM 1500 Series
6	ADM 1800 Series
7	ADM 5800 Series
8	ARD 1000
9	Box PC
10	AMA Series
11	AMS Series
12	AVW Series
13	Thin Clients
14	MPC Series
15	RS Series

Ordering Information	With Touch	Without Touch
----------------------	------------	---------------

ADM - 1815 BP	Panel Mount	ADM-1815BP-000	ADM-1815BP-001	ADM-1815BP-Z00	ADM-1815BP-Z01
LCD Display 15 inch	Touch Screen	5-Wire Resistive	5-Wire Resistive	No Touch	No Touch
	Bezel	Black Color Bezel	Black Color Bezel	Black Color Bezel	Black Color Bezel
	Power Supply	24VDC Input	110/220VAC Input	24VDC Input	110/220VAC Input
	Panel Mount	ADM-1815BP-004	ADM-1815BP-005	ADM-1815BP-Z04	ADM-1815BP-Z05
	Touch Screen	5-Wire Resistive	5-Wire Resistive	No Touch	No Touch
	Bezel	Stainless Steel Bezel	Stainless Steel Bezel	Stainless Steel Bezel	Stainless Steel Bezel
	Power Supply	24VDC Input	110/220VAC Input	24VDC Input	110/220VAC Input

ADM - 1817 AP	Panel Mount	ADM-1817AP-000	ADM-1817AP-001	ADM-1817AP-Z00	ADM-1817AP-Z01
LCD Display 17 inch	Touch Screen	5-Wire Resistive	5-Wire Resistive	No Touch	No Touch
	Bezel	Black Color Bezel	Black Color Bezel	Black Color Bezel	Black Color Bezel
	Power Supply	24VDC Input	110/220VAC Input	24VDC Input	110/220VAC Input
	Panel Mount	ADM-1817AP-004	ADM-1817AP-005	ADM-1817AP-Z04	ADM-1817AP-Z05
	Touch Screen	5-Wire Resistive	5-Wire Resistive	No Touch	No Touch
	Bezel	Stainless Steel Bezel	Stainless Steel Bezel	Stainless Steel Bezel	Stainless Steel Bezel
	Power Supply	24VDC Input	110/220VAC Input	24VDC Input	110/220VAC Input

ADM - 1819 AP	Panel Mount	ADM-1819AP-000	ADM-1819AP-001	ADM-1819AP-Z00	ADM-1819AP-Z01
LCD Display 19 inch	Touch Screen	5-Wire Resistive	5-Wire Resistive	No Touch	No Touch
	Bezel	Black Color Bezel	Black Color Bezel	Black Color Bezel	Black Color Bezel
	Power Supply	24VDC Input	110/220VAC Input	24VDC Input	110/220VAC Input
	Panel Mount	ADM-1819AP-004	ADM-1819AP-005	ADM-1819AP-Z04	ADM-1819AP-Z05
	Touch Screen	5-Wire Resistive	5-Wire Resistive	No Touch	No Touch
	Bezel	Stainless Steel Bezel	Stainless Steel Bezel	Stainless Steel Bezel	Stainless Steel Bezel
	Power Supply	24VDC Input	110/220VAC Input	24VDC Input	110/220VAC Input
	Rack Mount	ADM-1819AP-008	ADM-1819AP-009	ADM-1819AP-Z06	ADM-1819AP-Z09
	Touch Screen	5-Wire Resistive	5-Wire Resistive	No Touch	No Touch
	Bezel	Black Color Bezel	Black Color Bezel	Black Color Bezel	Black Color Bezel
Power Supply	24VDC Input	110/220VAC Input	24VDC Input	110/220VAC Input	

ADM - 1820 AP	Panel Mount	ADM-1820AP-000	ADM-1820AP-001	ADM-1820AP-Z00	ADM-1820AP-Z01
LCD Display 20.1 inch	Touch Screen	5-Wire Resistive	5-Wire Resistive	No Touch	No Touch
	Bezel	Black Color Bezel	Black Color Bezel	Black Color Bezel	Black Color Bezel
	Power Supply	24VDC Input	110/220VAC Input	24VDC Input	110/220VAC Input
	Panel Mount	ADM-1820AP-004	ADM-1820AP-005	ADM-1820AP-Z04	ADM-1820AP-Z05
	Touch Screen	5-Wire Resistive	5-Wire Resistive	No Touch	No Touch
	Bezel	Stainless Steel Bezel	Stainless Steel Bezel	Stainless Steel Bezel	Stainless Steel Bezel
	Power Supply	24VDC Input	110/220VAC Input	24VDC Input	110/220VAC Input
	Rack Mount	ADM-1820AP-008	ADM-1820AP-009	ADM-1820AP-Z06	ADM-1820AP-Z09
	Touch Screen	5-Wire Resistive	5-Wire Resistive	No Touch	No Touch
	Bezel	Black Color Bezel	Black Color Bezel	Black Color Bezel	Black Color Bezel
Power Supply	24VDC Input	110/220VAC Input	24VDC Input	110/220VAC Input	

ADM - 1824 AP	Panel Mount	ADM-1824AP-000	ADM-1824AP-001	ADM-1824AP-Z00	ADM-1824AP-Z01
LCD Display 24 inch	Touch Screen	5-Wire Resistive	5-Wire Resistive	No Touch	No Touch
	Bezel	Black Color Bezel	Black Color Bezel	Black Color Bezel	Black Color Bezel
	Power Supply	24VDC Input	110/220VAC Input	24VDC Input	110/220VAC Input
	Panel Mount	ADM-1824AP-004	ADM-1824AP-005	ADM-1824AP-Z04	ADM-1824AP-Z05
	Touch Screen	5-Wire Resistive	5-Wire Resistive	No Touch	No Touch
	Bezel	Stainless Steel Bezel	Stainless Steel Bezel	Stainless Steel Bezel	Stainless Steel Bezel
	Power Supply	24VDC Input	110/220VAC Input	24VDC Input	110/220VAC Input