

### Features

- ▶ 8.4" Active Matrix TFT LCD
- ▶ Max Resolution at 800 x 600
- ▶ 4-Wire Resistive Touch Screen
- ▶ NEMA 4/4X Front Bezel
- ▶ VGA and DVI Input



RS-232  
Touch



VGA  
Input



DVI  
Input



ADM-1508AP



Specifications	ADM-1508 AP	Line Drawing
<b>LCD Display</b>		
Display Size (Diagnol)	8.4 inch	
Resolution	800 x 600	
Backlight Lifetime (Hours)	50,000	
<b>Visual Characteristics</b>		
Colors	262K	
Aspect ratio	4:3	
Viewing angle (V/H)	80° / 120°	
Response time(Typical)	35 ms	
Pixel Pitch(mm)	0.213 x 0.213	
Contrast ratio	350:1	
Brightness	150 nits	
<b>Input Interface</b>		
VGA	Yes	
DVI	Yes	
S-Video	N/A	
Composite Video	N/A	
Component Video	N/A	
<b>Touch Screen</b>		
Technology	4 Wire Resistive	
Touch rating	1 Million Touches	
MTBF	14,000 hours	
Interface	RS-232	
Driver	WinCE, WinXP	
<b>Front Bezel</b>		
NEMA 4	Black Powder Coated	
NEMA 4x	Stainless Steel (Optional)	
<b>Power/Thermal Specs.</b>		
Power Requirement ( Max )	110VAC@0.12A, 220VAC@0.06A 12VDC@1A	
Power Consumption ( Max )	12W	
Heat Dissipation	41 BTU/hr	
<b>Physical Information</b>		
Mounting	Panel Mount	
Physical Dimension (WxHxD)	9.80 x 7.00 x 2.09 inch 248.9 x 177.8 x 53.1 mm	
Cutout Dimension (WxH)	8.79 x 5.98 inch 223.3 x 151.9 mm	
<b>Environmental</b>		
Operating Temp	0° - 50° C (32° - 122° F)	
Storage Temp	-20° - 60° C (-4° - 140° F)	
Relative Humidity	0% - 95% (non-condensing)	
Rating	NEMA 4/4X Bezel	
Certification	FCC, CE	

- 1**  
ARP  
1700  
Series
- 2**  
ARP  
2200  
Series
- 3**  
ARP  
3600  
Series
- 4**  
ARP  
5500AX  
Series
- 5**  
ADM  
1500  
Series
- 6**  
ADM  
1800  
Series
- 7**  
ADM  
5800  
Series
- 8**  
ARD  
1000
- 9**  
Box PC
- 10**  
AMA  
Series
- 11**  
AMS  
Series
- 12**  
AVW  
Series
- 13**  
Thin  
Clients
- 14**  
MPC  
Series
- 15**  
RS  
Series

### Features

- ▶ 10.4" Active Matrix TFT LCD
- ▶ Max Resolution at 800 x 600
- ▶ 4-Wire Resistive Touch Screen
- ▶ NEMA 4/4X Front Bezel
- ▶ VGA and DVI Input



RS-232  
Touch



VGA  
Input



DVI  
Input



ADM-1510AP

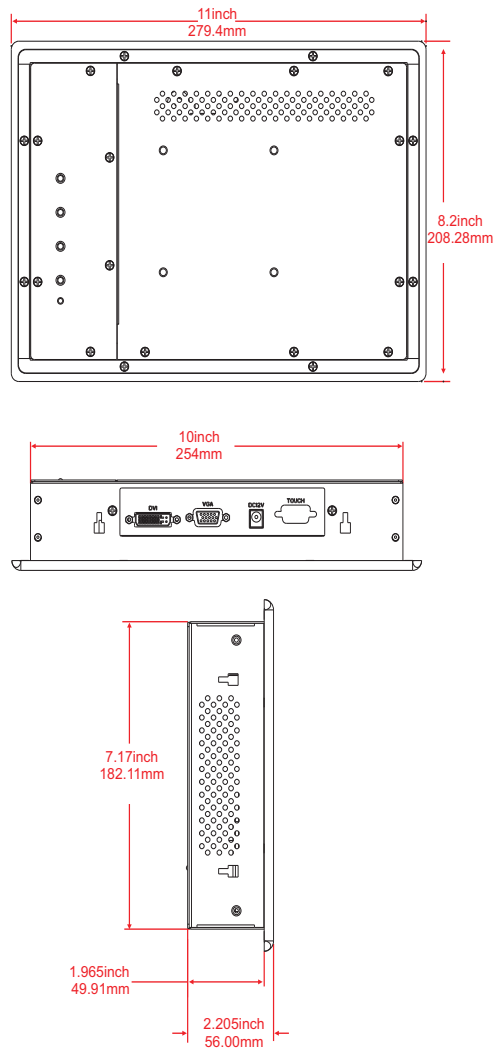

Specifications	ADM-1510 AP	Line Drawing
<b>LCD Display</b>		
Display Size (Diagnol)	10.4 inch	
Resolution	800 x 600	
Backlight Lifetime (Hours)	50,000	
<b>Visual Characteristics</b>		
Colors	262K	
Aspect ratio	4:3	
Viewing angle (V/H)	100° / 120°	
Response time(Typical)	35 ms	
Pixel Pitch(mm)	0.264 x 0.264	
Contrast ratio	500:1	
Brightness	230 nits	
<b>Input Interface</b>		
VGA	Yes	
DVI	Yes	
S-Video	N/A	
Composite Video	N/A	
Component Video	N/A	
<b>Touch Screen</b>		
Technology	4 Wire Resistive	
Touch rating	1 Million Touches	
MTBF	14,000 hours	
Interface	RS-232	
Driver	WinCE, WinXP	
<b>Front Bezel</b>		
NEMA 4	Black Powder Coated	
NEMA 4x	Stainless Steel (Optional)	
<b>Power/Thermal Specs.</b>		
Power Requirement ( Max )	110VAC@0.12A, 220VAC@0.06A 12VDC@1A	
Power Consumption ( Max )	12W	
Heat Dissipation	41 BTU/hr	
<b>Physical Information</b>		
Mounting	Panel Mount	
Physical Dimension (WxHxD)	11.00 x 8.20 x 2.205 inch 279.4 x 208.3 x 56.0 mm	
Cutout Dimension (WxH)	10.00 x 7.17 inch 254.0 x 182.1 mm	
<b>Environmental</b>		
Operating Temp	0° - 50° C (32° - 122° F)	
Storage Temp	-20° - 60° C (-4° - 140° F)	
Relative Humidity	0% - 95% (non-condensing)	
Rating	NEMA 4/4X Bezel	
Certification	FCC, CE	

### Features

- ▶ 12.1" Active Matrix TFT LCD
- ▶ Max Resolution at 800 x 600
- ▶ 4-Wire Resistive Touch Screen
- ▶ NEMA 4/4X Front Bezel
- ▶ VGA and DVI Input



RS-232  
Touch



VGA  
Input



DVI  
Input



ADM-1512AP



Specifications	ADM-1512 AP	Line Drawing
<b>LCD Display</b>		
Display Size (Diagnol)	12.1 inch	
Resolution	800 x 600	
Backlight Lifetime (Hours)	50,000	
<b>Visual Characteristics</b>		
Colors	262K	
Aspect ratio	4:3	
Viewing angle (V/H)	120° / 140°	
Response time(Typical)	35 ms	
Pixel Pitch(mm)	0.3075 x 0.3075	
Contrast ratio	500:1	
Brightness	400 nits	
<b>Input Interface</b>		
VGA	Yes	
DVI	Yes	
S-Video	N/A	
Composite Video	N/A	
Component Video	N/A	
<b>Touch Screen</b>		
Technology	4 Wire Resistive	
Touch rating	1 Million Touches	
MTBF	14,000 hours	
Interface	RS-232	
Driver	WinCE, WinXP	
<b>Front Bezel</b>		
NEMA 4	Black Powder Coated	
NEMA 4x	Stainless Steel (Optional)	
<b>Power/Thermal Specs.</b>		
Power Requirement ( Max )	110VAC@0.16A, 220VAC@0.08A 12VDC@1.5A	
Power Consumption ( Max )	18W	
Heat Dissipation	61 BTU/hr	
<b>Physical Information</b>		
Mounting	Panel Mount	
Physical Dimension (WxHxD)	12.60 x 10.03 x 2.29 inch 320.0 x 254.8 x 58.4 mm	
Cutout Dimension (WxH)	11.76 x 9.18 inch 298.7 x 233.2 mm	
<b>Environmental</b>		
Operating Temp	0° - 50° C (32° - 122° F)	
Storage Temp	-20° - 60° C (-4° - 140° F)	
Relative Humidity	0% - 95% (non-condensing)	
Rating	NEMA 4/4X Bezel	
Certification	FCC, CE	

- 1**  
ARP  
1700  
Series
- 2**  
ARP  
2200  
Series
- 3**  
ARP  
3600  
Series
- 4**  
ARP  
5500AX  
Series
- 5**  
ADM  
1500  
Series
- 6**  
ADM  
1800  
Series
- 7**  
ADM  
5800  
Series
- 8**  
ARD  
1000  
Box PC
- 10**  
AMA  
Series
- 11**  
AMS  
Series
- 12**  
AVW  
Series
- 13**  
Thin  
Clients
- 14**  
MPC  
Series
- 15**  
RS  
Series

### Features

- ▶ 15" Active Matrix TFT LCD
- ▶ Max Resolution at 1024 x 768
- ▶ 5-Wire Resistive Touch Screen
- ▶ NEMA 4/4X Front Bezel
- ▶ VGA Input



RS-232  
Touch



VGA  
Input



ADM-1515BP



Specifications	ADM-1515 BP	Line Drawing
<b>LCD Display</b>		
Display Size (Diagnol)	15 inch	
Resolution	1024 x 768	
Backlight Lifetime (Hours)	30,000	
<b>Visual Characteristics</b>		
Colors	16 Million	
Aspect ratio	4:3	
Viewing angle (V/H)	120° / 130°	
Response time(Typical)	12 ms	
Pixel Pitch(mm)	0.297 x 0.297	
Contrast ratio	500:1	
Brightness	250 nits	
<b>Input Interface</b>		
VGA	Yes	
DVI	No	
S-Video	N/A	
Composite Video	N/A	
Component Video	N/A	
<b>Touch Screen</b>		
Technology	5 Wire Resistive	
Touch rating	35 Million Touches	
MTBF	490,000 hours	
Interface	RS-232	
Driver	WinCE, WinXP	
<b>Front Bezel</b>		
NEMA 4	Black Powder Coated	
NEMA 4x	Stainless Steel (Optional)	
<b>Power/Thermal Specs.</b>		
Power Requirement ( Max )	110VAC@0.3A, 220VAC@0.15A 12VDC@2.5A Max, 24VDC@1.25A Max	
Power Consumption ( Max )	30W	
Heat Dissipation	102 BTU/hr	
<b>Physical Information</b>		
Mounting	Panel Mount	
Physical Dimension (WxHxD)	19.00 x 12.19 x 1.84 inch 482.6 x 309.6 x 46.6 mm	
Cutout Dimension (WxH)	15.56 x 10.93 inch 395.2 x 277.7 mm	
<b>Environmental</b>		
Operating Temp	0° - 50° C (32° - 122° F)	
Storage Temp	-20° - 60° C (-4° - 140° F)	
Relative Humidity	0% - 95% (non-condensing)	
Rating	NEMA 4/4X Bezel	
Certification	FCC, CE	

### Features

- 15" Active Matrix TFT LCD
- Max Resolution at 1024 x 768
- 5-Wire Resistive Touch Screen
- NEMA 4/4X Front Bezel
- VGA Input
- 24 Function Keys
- 60 Alphanumeric Keys



RS-232  
Touch



VGA  
Input



ADM-1515BW



Specifications	ADM-1515 BW	Line Drawing
<b>LCD Display</b>		
Display Size (Diagnol)	15 inch	
Resolution	1024 x 768	
Backlight Lifetime (Hours)	30,000	
<b>Visual Characteristics</b>		
Colors	16 Million	
Aspect ratio	4:3	
Viewing angle (V/H)	120° / 130°	
Response time(Typical)	12 ms	
Pixel Pitch(mm)	0.297 x 0.297	
Contrast ratio	500:1	
Brightness	250 nits	
<b>Input Interface</b>		
VGA	Yes	
DVI	No	
S-Video	N/A	
Composite Video	N/A	
Component Video	N/A	
<b>Touch Screen</b>		
Technology	5 Wire Resistive	
Touch rating	35 Million Touches	
MTBF	490,000 hours	
Interface	RS-232	
Driver	WinCE, WinXP	
<b>Front Bezel</b>		
NEMA 4	Black Powder Coated	
NEMA 4x	Stainless Steel (Optional)	
<b>Power/Thermal Specs.</b>		
Power Requirement ( Max )	110VAC@0.3A, 220VAC@0.15A 12VDC@2.5A Max, 24VDC@1.25A Max	
Power Consumption ( Max )	30W	
Heat Dissipation	102 BTU/hr	
<b>Physical Information</b>		
Mounting	Panel Mount	
Physical Dimension (WxHxD)	19.00 x 13.88 x 2.00 inch 482.6 x 352.5 x 50.8 mm	
Cutout Dimension (WxH)	16.93 x 12.64 inch 430.00 x 321.1 mm	
<b>Environmental</b>		
Operating Temp	0° - 50° C (32° - 122° F)	
Storage Temp	-20° - 60° C (-4° - 140° F)	
Relative Humidity	0% - 95% (non-condensing)	
Rating	NEMA 4/4X Bezel	
Certification	FCC, CE	

- 1  
ARP  
1700  
Series
- 2  
ARP  
2200  
Series
- 3  
ARP  
3600  
Series
- 4  
ARP  
5500AX  
Series
- 5  
ADM  
1500  
Series
- 6  
ADM  
1800  
Series
- 7  
ADM  
5800  
Series
- 8  
ARD  
1000
- 9  
Box PC
- 10  
AMA  
Series
- 11  
AMS  
Series
- 12  
AVW  
Series
- 13  
Thin  
Clients
- 14  
MPC  
Series
- 15  
RS  
Series



ADM-1515BP



ADM-1515BW



 ADM-1515 BP Line Drawing - Rack Mount

 ADM-1515 BW Line Drawing - Rack Mount

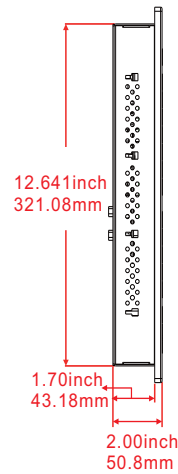
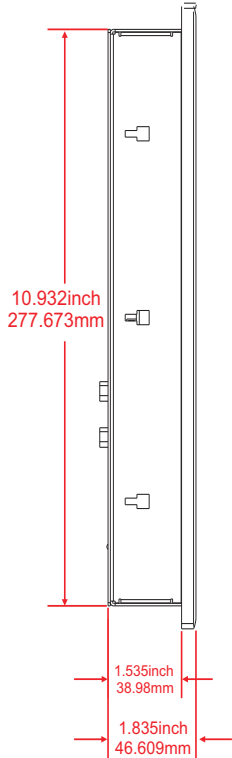
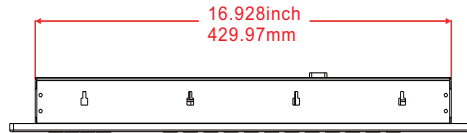
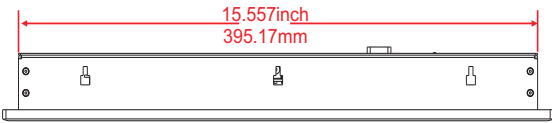
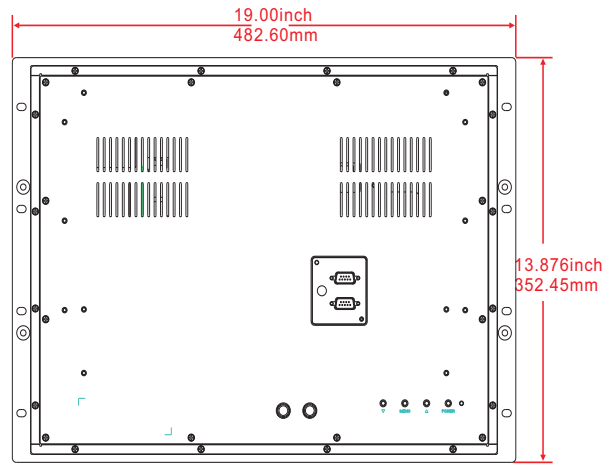
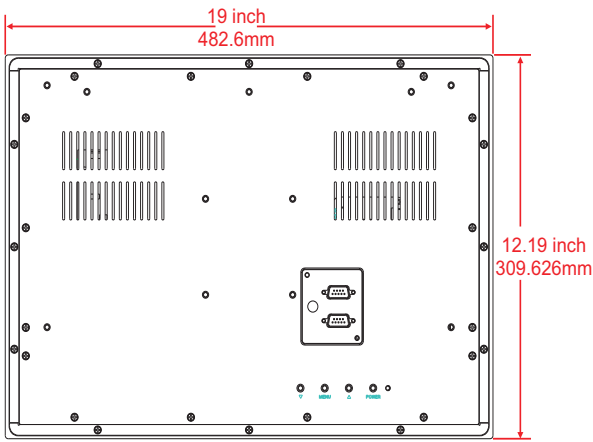

### Features

- ▶ 17" Active Matrix TFT LCD
- ▶ Max Resolution at 1280 x 1024
- ▶ 5-Wire Resistive Touch Screen
- ▶ NEMA 4/4X Front Bezel
- ▶ VGA Input



RS-232  
Touch



VGA  
Input



ADM-1517AP



Specifications	ADM-1517 AP	Line Drawing
<b>LCD Display</b>		
Display Size (Diagnol)	17 inch	
Resolution	1280 x 1024	
Backlight Lifetime (Hours)	50,000	
<b>Visual Characteristics</b>		
Colors	16 Million	
Aspect ratio	4:3	
Viewing angle (V/H)	178° / 178°	
Response time(Typical)	20 ms	
Pixel Pitch(mm)	0.294 x 0.294	
Contrast ratio	700:1	
Brightness	300 nits	
<b>Input Interface</b>		
VGA	Yes	
DVI	No	
S-Video	N/A	
Composite Video	N/A	
Component Video	N/A	
<b>Touch Screen</b>		
Technology	5 Wire Resistive	
Touch rating	35 Million Touches	
MTBF	490,000 hours	
Interface	RS-232, USB	
Driver	WinCE, WinXP, Vista, Win 7	
<b>Front Bezel</b>		
NEMA 4	Black Powder Coated	
NEMA 4x	Stainless Steel (Optional)	
<b>Power/Thermal Specs.</b>		
Power Requirement ( Max )	110VAC@0.4A, 220VAC@0.2A 12VDC@3.2A, 24VDC@1.6A	
Power Consumption ( Max )	38W	
Heat Dissipation	129 BTU/hr	
<b>Physical Information</b>		
Mounting	Panel Mount	
Rack Mount Dimension (LxWxH)	17.8 x 13.512x2.30 inch 252.12 x 343.23 x 58.42 mm	
Physical Dimension (WxHxD)	19.00 x 13.88 x 2.30 inch 482.6 x 352.5 x 58.4 mm	
Cutout Dimension (WxH)	16.93 x 12.64 inch 430.00 x 321.1 mm	
<b>Environmental</b>		
Operating Temp	0° - 50° C (32° - 122° F)	
Storage Temp	-20° - 60° C (-4° - 140° F)	
Relative Humidity	0% - 95% (non-condensing)	
Rating	NEMA 4/4X Bezel	
Certification	FCC, CE	

- 1  
ARP  
1700  
Series
- 2  
ARP  
2200  
Series
- 3  
ARP  
3600  
Series
- 4  
ARP  
5500AX  
Series
- 5  
ADM  
1500  
Series
- 6  
ADM  
1800  
Series
- 7  
ADM  
5800  
Series
- 8  
ARD  
1000
- 9  
Box PC
- 10  
AMA  
Series
- 11  
AMS  
Series
- 12  
AVW  
Series
- 13  
Thin  
Clients
- 14  
MPC  
Series
- 15  
RS  
Series

### Features

- ▶ 19" Active Matrix TFT LCD
- ▶ Max Resolution at 1280 x 1024
- ▶ 5-Wire Resistive Touch Screen
- ▶ NEMA 4/4X Front Bezel
- ▶ VGA Input



RS-232  
Touch



VGA  
Input



ADM-1519AP



Specifications	ADM-1519 AP	Line Drawing
<b>LCD Display</b>		
Display Size (Diagnol)	19 inch	
Resolution	1280 x 1024	
Backlight Lifetime (Hours)	50,000	
<b>Visual Characteristics</b>		
Colors	16 Million	
Aspect ratio	4:3	
Viewing angle (V/H)	178° / 178°	
Response time(Typical)	20 ms	
Pixel Pitch(mm)	0.294 x 0.294	
Contrast ratio	700:1	
Brightness	300 nits	
<b>Input Interface</b>		
VGA	Yes	
DVI	No	
S-Video	N/A	
Composite Video	N/A	
Component Video	N/A	
<b>Touch Screen</b>		
Technology	5 Wire Resistive	
Touch rating	35 Million Touches	
MTBF	490,000 hours	
Interface	RS-232, USB	
Driver	WinCE, WinXP, Vista, Win 7	
<b>Front Bezel</b>		
NEMA 4	Black Powder Coated	
NEMA 4x	Stainless Steel (Optional)	
<b>Power/Thermal Specs.</b>		
Power Requirement ( Max )	110VAC@0.45A, 220VAC@0.25A 12VDC@3.8A, 24VDC@1.9A	
Power Consumption ( Max )	45W	
Heat Dissipation	153 BTU/hr	
<b>Physical Information</b>		
Mounting	Panel Mount	
Physical Dimension (WxHxD)	19.00 x 14.60 x 2.00 inch 482.6 x 370.8 x 50.8 mm	
Cutout Dimension (WxH)	16.81 x 13.61 inch 427.0 x 345.7 mm	
<b>Environmental</b>		
Operating Temp	0° - 50° C (32° - 122° F)	
Storage Temp	-20° - 60° C (-4° - 140° F)	
Relative Humidity	0% - 95% (non-condensing)	
Rating	NEMA 4/4X Bezel	
Certification	FCC, CE	





ADM-1517AP



ADM-1519AP



**ADM-1517 AP Line Drawing - Rack Mount**

**ADM-1519 AP Line Drawing - Rack Mount**

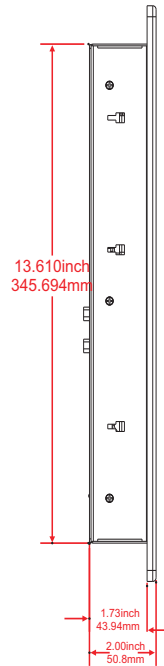
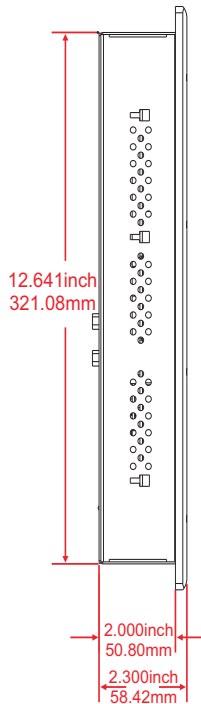
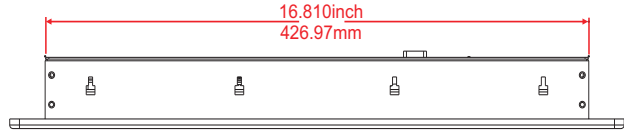
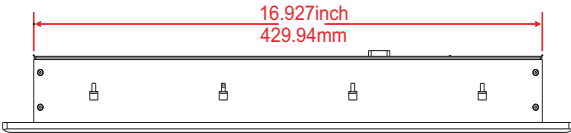
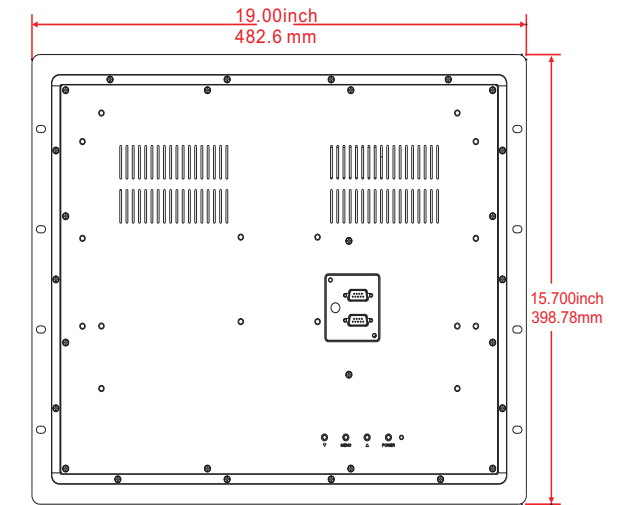
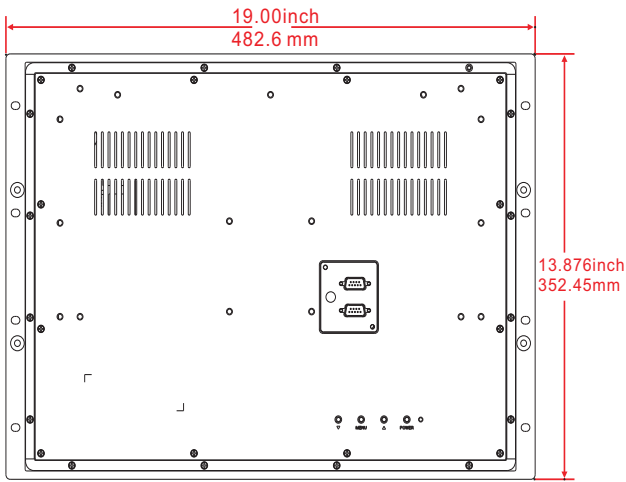

- 1 ARP 1700 Series
- 2 ARP 2200 Series
- 3 ARP 3600 Series
- 4 ARP 5500AX Series
- 5 **ADM 1500 Series**
- 6 ADM 1800 Series
- 7 ADM 5800 Series
- 8 ARD 1000
- 9 Box PC
- 10 AMA Series
- 11 AMS Series
- 12 AVW Series
- 13 Thin Clients
- 14 MPC Series
- 15 RS Series

### Features

- ▶ 20.1" Active Matrix TFT LCD
- ▶ Max Resolution at 1600 x 1200
- ▶ 5-Wire Resistive Touch Screen
- ▶ NEMA 4/4X Front Bezel
- ▶ VGA Input



RS-232  
Touch



VGA  
Input



ADM-1520AP



Specifications	ADM-1520 AP	Line Drawing
<b>LCD Display</b>		
Display Size (Diagnol)	20 inch	
Resolution	1600 x 1200	
Backlight Lifetime (Hours)	50,000	
<b>Visual Characteristics</b>		
Colors	16 Million	
Aspect ratio	4:3	
Viewing angle (V/H)	178° / 178°	
Response time(Typical)	20 ms	
Pixel Pitch(mm)	0.294 x 0.294	
Contrast ratio	700:1	
Brightness	300 nits	
<b>Input Interface</b>		
VGA	Yes	
DVI	No	
S-Video	N/A	
Composite Video	N/A	
Component Video	N/A	
<b>Touch Screen</b>		
Technology	5 Wire Resistive	
Touch rating	35 Million Touches	
MTBF	490,000 hours	
Interface	RS-232, USB	
Driver	WinCE, WinXP, Vista, Win 7	
<b>Front Bezel</b>		
NEMA 4	Black Powder Coated	
NEMA 4x	Stainless Steel (Optional)	
<b>Power/Thermal Specs.</b>		
Power Requirement ( Max )	110VAC@0.6A, 220VAC@0.3A 12VDC@4.8A, 24VDC@2.4A	
Power Consumption ( Max )	60W	
Heat Dissipation	204 BTU/hr	
<b>Physical Information</b>		
Mounting	Panel Mount	
Physical Dimension (WxHxD)	19.00 x 15.70 x 2.42 inch 482.6 x 398.8 x 61.5 mm	
Cutout Dimension (WxH)	17.30 x 14.60 inch 439.4 x 370.8 mm	
<b>Environmental</b>		
Operating Temp	0° - 50° C (32° - 122° F)	
Storage Temp	-20° - 60° C (-4° - 140° F)	
Relative Humidity	0% - 95% (non-condensing)	
Rating	NEMA 4/4X Bezel	
Certification	FCC, CE	

### ADM-1520 AP Line Drawing - Rack Mount

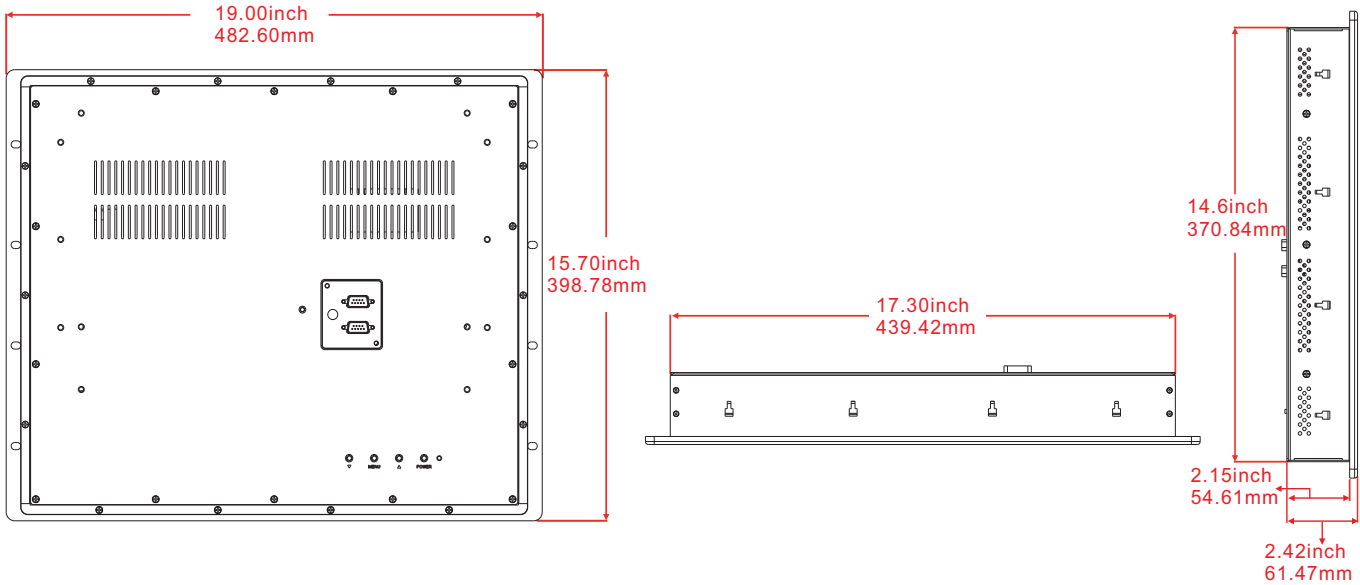

### ADM - 1508 AP / 10AP / 12AP / 15BP / 15BW / 17AP / 19AP Power Supply

Model : AD060 - DBAB1-J25 (110 / 220 VAC Input, 24VDC Output power supply)

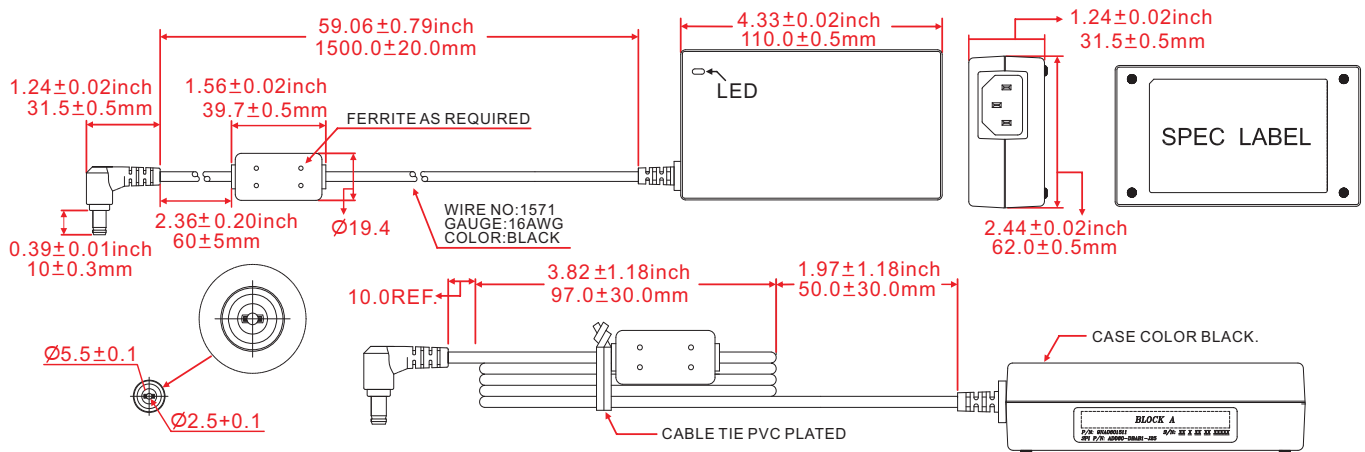

### ADM - 1520 AP Power Supply

Model: SPU65 Series (110 / 220VAC Input, 24VDC Output power supply)

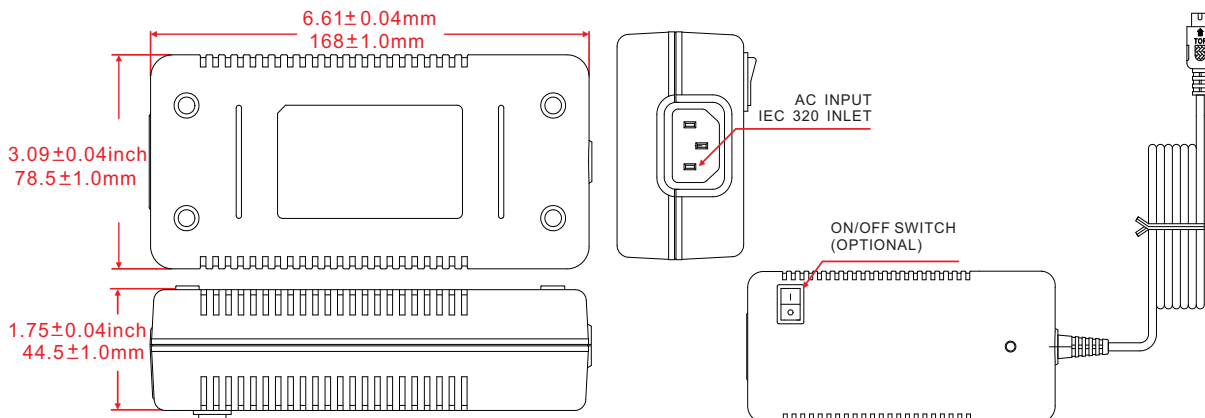

1	ARP 1700 Series
2	ARP 2200 Series
3	ARP 3600 Series
4	ARP 5500AX Series
5	ADM 1500 Series
6	ADM 1800 Series
7	ADM 5800 Series
8	ARD 1000
9	Box PC
10	AMA Series
11	AMS Series
12	AVW Series
13	Thin Clients
14	MPC Series
15	RS Series

Ordering Information		With Touch		Without Touch		
<b>ADM - 1508 AP</b>		<b>Panel Mount</b>	<b>ADM-1508AP-001</b>	<b>ADM-1508AP-005</b>	<b>ADM-1508AP-Z01</b>	<b>ADM-1508AP-Z05</b>
LCD Display	8.4 inch	Touch Screen	4-Wire Resistive	4-Wire Resistive	No Touch	No Touch
Power Supply	110 /220 VAC Input	Bezel	Black Color Bezel	Stainless Steel Bezel	Black Color Bezel	Stainless Steel Bezel
<b>ADM - 1510 AP</b>		<b>Panel Mount</b>	<b>ADM-1510AP-001</b>	<b>ADM-1510AP-005</b>	<b>ADM-1510AP-Z01</b>	<b>ADM-1510AP-Z05</b>
LCD Display	10.4 inch	Touch Screen	4-Wire Resistive	4-Wire Resistive	No Touch	No Touch
Power Supply	110 /220 VAC Input	Bezel	Black Color Bezel	Stainless Steel Bezel	Black Color Bezel	Stainless Steel Bezel
<b>ADM - 1512 AP</b>		<b>Panel Mount</b>	<b>ADM-1512AP-001</b>	<b>ADM-1512AP-005</b>	<b>ADM-1512AP-Z01</b>	<b>ADM-1512AP-Z05</b>
LCD Display	12.1 inch	Touch Screen	4-Wire Resistive	4-Wire Resistive	No Touch	No Touch
Power Supply	110 /220 VAC Input	Bezel	Black Color Bezel	Stainless Steel Bezel	Black Color Bezel	Stainless Steel Bezel
<b>ADM - 1515 BP</b>		<b>Panel Mount</b>	<b>ADM-1515BP-001</b>	<b>ADM-1515BP-005</b>	<b>ADM-1515BP-Z01</b>	<b>ADM-1515BP-Z05</b>
LCD Display	15 inch	Touch Screen	5-Wire Resistive	5-Wire Resistive	No Touch	No Touch
Power Supply	110 /220 VAC Input	Bezel	Black Color Bezel	Stainless Steel Bezel	Black Color Bezel	Stainless Steel Bezel
		<b>Rack Mount</b>	<b>ADM-1515BP-008</b>		<b>ADM-1515BP-Z08</b>	
		Touch Screen	5-Wire Resistive		No Touch	
		Bezel	Black Color Rack Mount Bezel		Black Color Rack Mount Bezel	
<b>ADM - 1515 BW</b>		<b>Panel Mount</b>	<b>ADM-1515BW-001</b>	<b>ADM-1515BW-005</b>	<b>ADM-1515BW-Z01</b>	<b>ADM-1515BW-Z05</b>
LCD Display	15 inch	Touch Screen	5-Wire Resistive	5-Wire Resistive	No Touch	No Touch
Power Supply	110 /220 VAC Input	Bezel	Black Color Bezel	Stainless Steel Bezel	Black Color Bezel	Stainless Steel Bezel
		<b>Rack Mount</b>	<b>ADM-1515BW-008</b>		<b>ADM-1515BW-Z08</b>	
		Touch Screen	5-Wire		No Touch	
		Bezel	Black Color Rack Mount Bezel		Black Color Rack Mount Bezel	
<b>ADM - 1517 AP</b>		<b>Panel Mount</b>	<b>ADM-1517AP-001</b>	<b>ADM-1517AP-005</b>	<b>ADM-1517AP-Z01</b>	<b>ADM-1517AP-Z05</b>
LCD Display	17 inch	Touch Screen	5-Wire Resistive	5-Wire Resistive	No Touch	No Touch
Power Supply	110 /220 VAC Input	Bezel	Black Color Bezel	Stainless Steel Bezel	Black Color Bezel	Stainless Steel Bezel
		<b>Rack Mount</b>	<b>ADM-1517AP-008</b>		<b>ADM-1517AP-Z08</b>	
		Touch Screen	5-Wire		No Touch	
		Bezel	Black Color Rack Mount Bezel		Black Color Rack Mount Bezel	
<b>ADM - 1519 AP</b>		<b>Panel Mount</b>	<b>ADM-1519AP-001</b>	<b>ADM-1519AP-005</b>	<b>ADM-1519AP-Z01</b>	<b>ADM-1519AP-Z05</b>
LCD Display	19 inch	Touch Screen	5-Wire Resistive	5-Wire Resistive	No Touch	No Touch
Power Supply	110 /220 VAC Input	Bezel	Black Color Bezel	Stainless Steel Bezel	Black Color Bezel	Stainless Steel Bezel
		<b>Rack Mount</b>	<b>ADM-1519AP-008</b>		<b>ADM-1519AP-Z08</b>	
		Touch Screen	5-Wire Resistive		No Touch	
		Bezel	Black Color Rack Mount Bezel		Black Color Rack Mount Bezel	
<b>ADM - 1520 AP</b>		<b>Panel Mount</b>	<b>ADM-1520AP-001</b>	<b>ADM-1520AP-005</b>	<b>ADM-1520AP-Z01</b>	<b>ADM-1520AP-Z05</b>
LCD Display	20.1 inch	Touch Screen	5-Wire Resistive	5-Wire Resistive	No Touch	No Touch
Power Supply	110 /220 VAC Input	Bezel	Black Color Bezel	Stainless Steel Bezel	Black Color Bezel	Stainless Steel Bezel
		<b>Rack Mount</b>	<b>ADM-1520AP-008</b>		<b>ADM-1520AP-Z08</b>	
		Touch Screen	5-Wire Resistive		No Touch	
		Bezel	Black Color Rack Mount Bezel		Black Color Rack Mount Bezel	