



Customer information packet

EM3713T

15HP, 3500RPM, 3PH, 60HZ, 215T, 3752M, TEFC, F1

Class - None

Division - Not Applicable

Specifications

Enclosure	TEFC
Frame	215T
Frame Material	Steel
Frequency	60.00 Hz
Motor Letter Type	Three Phase
Output @ Frequency	15.000 HP @ 60 HZ
Phase	3
Synchronous Speed @ Frequency	3600 RPM @ 60 HZ
Voltage @ Frequency	230.0 V @ 60 HZ 460.0 V @ 60 HZ
XP Class and Group	None
XP Division	Not Applicable
Agency Approvals	CSA EEV CURUSEEV NEMA PREMIUM NEMA_PREMIUM UR
Ambient Temperature	40 °C
Auxillary Box	No Auxillary Box
Auxillary Box Lead Termination	None
Base Indicator	Rigid
Bearing Grease Type	Polyrex EM (-20F +300F)
Blower	None
Current @ Voltage	34.000 A @ 230.0 V 36.800 A @ 208.0 V 17.000 A @ 460.0 V
Design Code	A
Drip Cover	No Drip Cover
Duty Rating	CONT
Efficiency @ 100% Load	91.0 %
Electrically Isolated Bearing	Not Electrically Isolated
Feedback Device	NO FEEDBACK

Part detail

Revision	S
Type	AC
Mech. spec.	37H244
Base	
Status	PRD/A
Elec. spec.	37WGR228
Layout	37LYH244
Eff. date	08-11-2022
CD Diagram	CD0180
Poles	02
Leads	9#14
Proprietary	False
Created date	01-16-2012

Front Face Code	Standard
Front Shaft Indicator	None
Heater Indicator	No Heater
High Voltage Full Load Amps	17.0 a
Insulation Class	F
Inverter Code	Inverter Ready
KVA Code	J
Lifting Lugs	Standard Lifting Lugs
Locked Bearing Indicator	No Locked Bearing
Motor Lead Exit	Ko Box
Motor Lead Quantity/Wire Size	9 @ 14 AWG
Motor Lead Termination	Flying Leads
Motor Standards	NEMA
Motor Type	3752M
Mounting Arrangement	F1
Number of Poles	2
Overall Length	20.52 IN
Power Factor	89
Product Family	General Purpose
Pulley End Bearing Type	Ball
Pulley Face Code	Standard
Pulley Shaft Indicator	Standard
Rodent Screen	None
Service Factor	1.15
Shaft Diameter	1.375 IN
Shaft Extension Location	Pulley End
Shaft Ground Indicator	No Shaft Grounding
Shaft Rotation	Reversible
Shaft Slinger Indicator	No Slinger
Speed	3500 rpm
Speed Code	Single Speed
Starting Method	Direct on line
Thermal Device - Bearing	None
Thermal Device - Winding	None

Vibration Sensor Indicator	No Vibration Sensor
Winding Thermal 1	None
Winding Thermal 2	None

Nameplate

NP3441LUA

CAT.NO.	EM3713T						
SPEC	37H244R228G1						
HP	15						
VOLTS	230/460						
AMPS	34/17						
RPM	3500						
FRAME	215T		HZ	60		PH	3
SF	1.15	CODE	J	DES	A	CLASS	F
NEMA NOM. EFF	91	PF	89				
RATING	40C AMB-CONT						
CC	010A	USABLE AT 208V				N/A	
ENCL	TEFC	SER					
DE	6307	ODE	6206				
VPWM INVERTER READY							
CT6-60H(10:1)VT3-60H(20:1	50Hz 15HP 190/380V 40.8/20.4A						SF1.0

AC Induction Motor Performance Data

Record # 53380

Typical performance - not guaranteed values

Winding: 37WGR228-R023		Type: 3752M		Enclosure: TEFC		
Nameplate Data			460 V, 60 Hz: High Voltage Connection			
Rated Output (HP)	15	Full Load Torque	22.12 LB-FT			
Volts	230/460	Start Configuration	direct on line			
Full Load Amps	34/17	Breakdown Torque	103 LB-FT			
R.P.M.	3500	Pull-up Torque	40.16 LB-FT			
Hz	60 Phase	3	Locked-rotor Torque	57.59 LB-FT		
NEMA Design Code	A KVA Code	J	Starting Current	150 A		
Service Factor (S.F.)	1.15	No-load Current	5.55 A			
NEMA Nom. Eff.	91 Power Factor	89	Line-line Res. @ 25°C	0.47 Ω		
Rating - Duty	40C AMB-CONT	Temp. Rise @ Rated Load	68°C			
S.F. Amps		Temp. Rise @ S.F. Load	79°C			
		Locked-rotor Power Factor	30.9			
		Rotor inertia	0.474 LB-FT ²			

Load Characteristics 460 V, 60 Hz, 15 HP

% of Rated Load	25	50	75	100	125	150	S.F.
Power Factor	56	78	85	89	90	90	89
Efficiency	86.8	91	91.9	91.4	90.8	89.8	91.3
Speed	3579	3557	3534	3500	3484	3456	3495
Line amperes	6.7	9.57	13.19	17.03	21.12	25.61	19.5

ABB Motors and Mechanical Inc.

WINDING # 37WGR228

Typical performance - not guaranteed values.

15 HP 3 PH 60 HZ 3500 RPM 460 V 3752M

TORQUES (LB-FT): PO=103 PU=40.16 LR=57.59 LRA=150

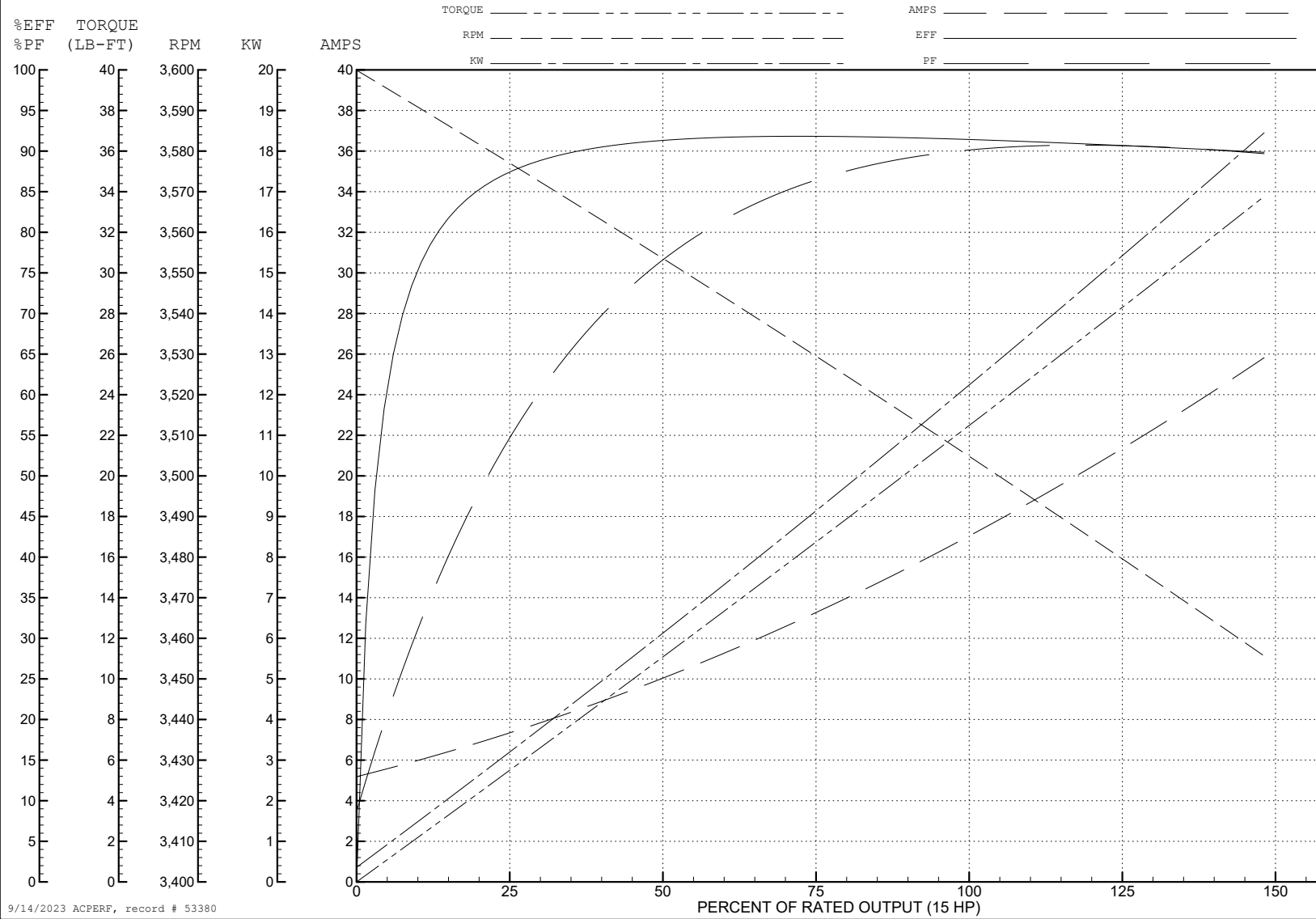

9/14/2023 ACPERF, record # 53380

AC Induction Motor Performance Data

Record # 57899

Typical performance - not guaranteed values

Winding: 37WGR228-R023		Type: 3752M		Enclosure: TEFC	
Nameplate Data			230 V, 60 Hz: Low Voltage Connection		
Rated Output (HP)	15	Full Load Torque	22.1 LB-FT		
Volts	230/460	Start Configuration	direct on line		
Full Load Amps	34/17	Breakdown Torque	104 LB-FT		
R.P.M.	3500	Pull-up Torque	40.3 LB-FT		
Hz	60	Phase	3	Locked-rotor Torque	57.8 LB-FT
NEMA Design Code	A	KVA Code	J	Starting Current	300 A
Service Factor (S.F.)	1.15	No-load Current	11.1 A		
NEMA Nom. Eff.	91	Power Factor	89	Line-line Res. @ 25°C	0.111 Ω
Rating - Duty	40C AMB-CONT		Temp. Rise @ Rated Load	67°C	
S.F. Amps			Temp. Rise @ S.F. Load	82°C	
			Locked-rotor Power Factor	30.3	
			Rotor inertia	0.474 LB-FT ²	

Load Characteristics 230 V, 60 Hz, 15 HP

% of Rated Load	25	50	75	100	125	150	S.F.
Power Factor	56	77	85	89	90	90	90
Efficiency	86.8	91.1	92	91.8	91	90	91.3
Speed	3579	3558	3534	3510	3485	3456	3495
Line amperes	13.4	19.1	26.4	34	42.2	51.2	38.9

ABB Motors and Mechanical Inc.

WINDING # 37WGR228

Typical performance - not guaranteed values.

15 HP 3 PH 60 HZ 3500 RPM 230 V 3752M

TORQUES (LB-FT): PO=104 PU=40.3 LR=57.8 LRA=300

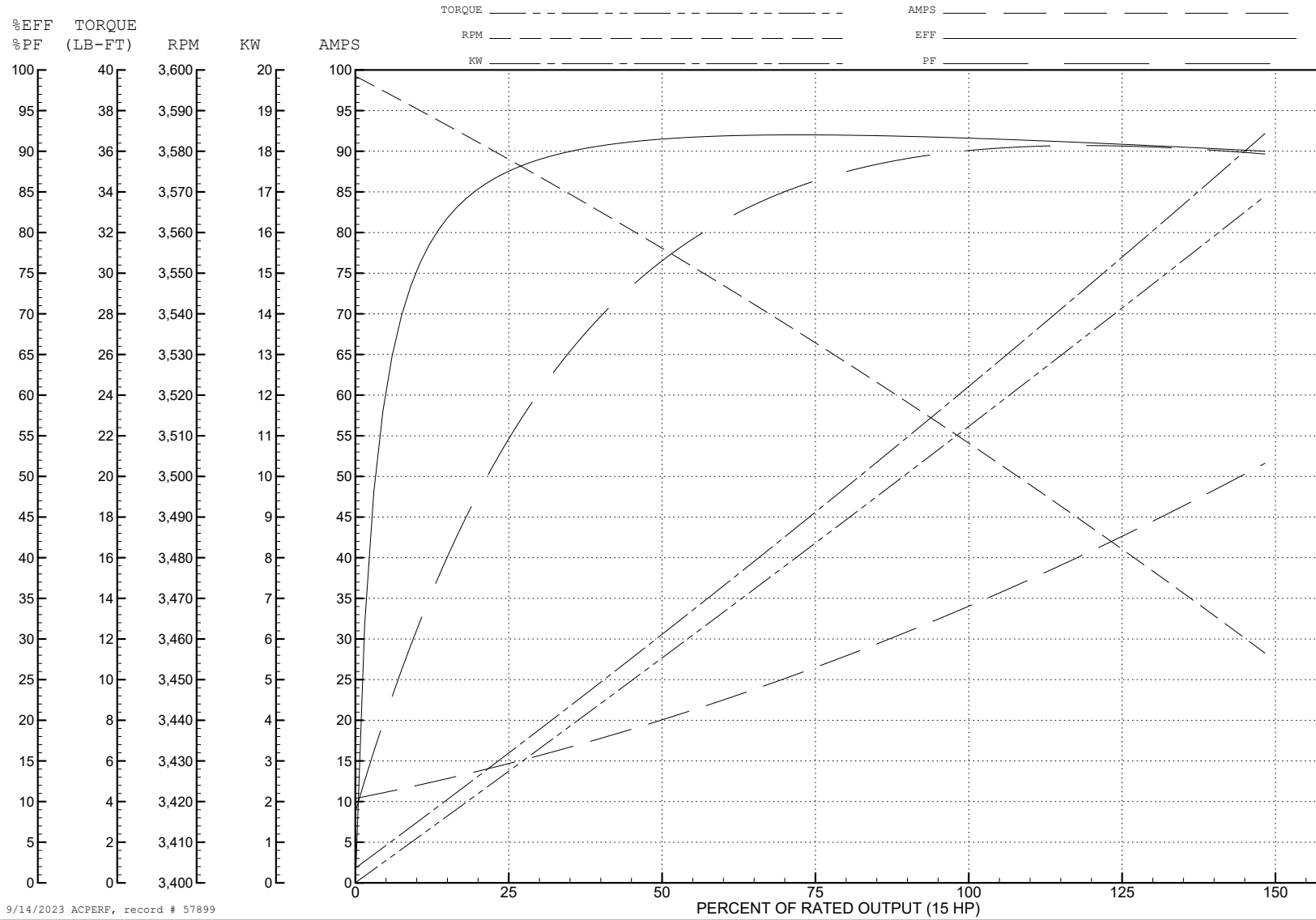

9/14/2023 ACPERF, record # 57899

AC Induction Motor Performance Data

Record # 70097

Typical performance - not guaranteed values

Winding: 37WGR228-RXXX		Type: 3752M		Enclosure: TEFC	
Nameplate Data			380 V, 50 Hz: High Voltage Connection		
Rated Output (HP)	15	Full Load Torque	17.68 LB-FT		
Volts	230/460	Start Configuration	direct on line		
Full Load Amps	34/17	Breakdown Torque	98.71 LB-FT		
R.P.M.	3500	Pull-up Torque	42.31 LB-FT		
Hz	60	Phase	3	Locked-rotor Torque	60.68 LB-FT
NEMA Design Code	A	KVA Code	J	Starting Current	146 A
Service Factor (S.F.)			1.15	No-load Current	5.43 A
NEMA Nom. Eff.	91	Power Factor	89	Line-line Res. @ 25°C	0.47 Ω
Rating - Duty	40C AMB-CONT			Temp. Rise @ Rated Load	52°C
S.F. Amps				Temp. Rise @ S.F. Load	63°C
				Locked-rotor Power Factor	34.6
				Rotor inertia	0.474 LB-FT ²

Load Characteristics 380 V, 50 Hz, 10 HP

% of Rated Load	25	50	75	100	125	150	S.F.
Power Factor	51	73	82	87	89	90	88
Efficiency	81.7	88	89.8	89.9	89.6	88.9	89.7
Speed	2982	2964	2945	2918	2905	2883	2910
Line amperes	6.27	8.45	11.29	14.27	17.46	20.98	16.2

ABB Motors and Mechanical Inc.

WINDING # 37WGR228

Typical performance - not guaranteed values.

10 HP 3 PH 50 HZ 3500 RPM 380 V 3752M

TORQUES (LB-FT): PO=98.71 PU=42.31 LR=60.68 LRA=146

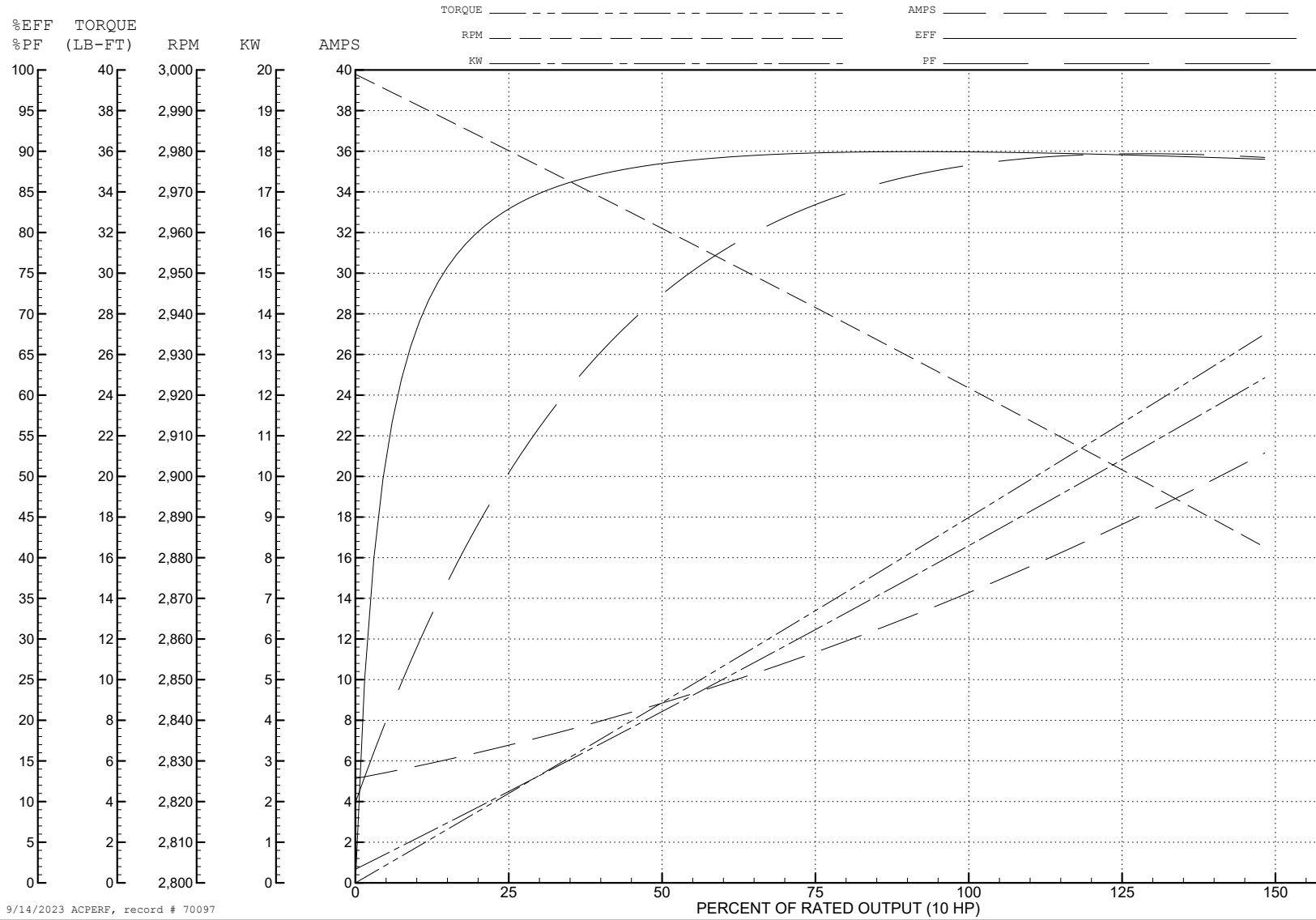

9/14/2023 ACPERF, record # 70097

AC Induction Motor Performance Data

Record # 73419

Typical performance - not guaranteed values

Winding: 37WGR228-RXXX		Type: 3752M		Enclosure: TEFC		
Nameplate Data			480 V, 60 Hz: High Voltage Connection			
Rated Output (HP)	15	Full Load Torque	22.12 LB-FT			
Volts	230/460	Start Configuration	direct on line			
Full Load Amps	34/17	Breakdown Torque	113 LB-FT			
R.P.M.	3500	Pull-up Torque	44.76 LB-FT			
Hz	60 Phase	3	Locked-rotor Torque	64.18 LB-FT		
NEMA Design Code	A KVA Code	J	Starting Current	159 A		
Service Factor (S.F.)	1.15	No-load Current	6.32 A			
NEMA Nom. Eff.	91 Power Factor	89	Line-line Res. @ 25°C	0.47 Ω		
Rating - Duty	40C AMB-CONT	Temp. Rise @ Rated Load	67°C			
S.F. Amps		Temp. Rise @ S.F. Load	83°C			
		Locked-rotor Power Factor	31.2			
		Rotor inertia	0.474 LB-FT ²			

Load Characteristics 480 V, 60 Hz, 15 HP

% of Rated Load	25	50	75	100	125	150	S.F.
Power Factor	50	72	82	86	88	89	87
Efficiency	86.2	90.7	91.8	91.5	90.9	90.1	91.1
Speed	3580	3560	3538	3506	3491	3465	3497
Line amperes	7.28	9.85	13.18	16.77	20.58	24.75	19.1

ABB Motors and Mechanical Inc.

WINDING # 37WGR228

Typical performance - not guaranteed values.

15 HP 3 PH 60 HZ 3500 RPM 480 V 3752M

TORQUES (LB-FT): PO=113 PU=44.76 LR=64.18 LRA=159

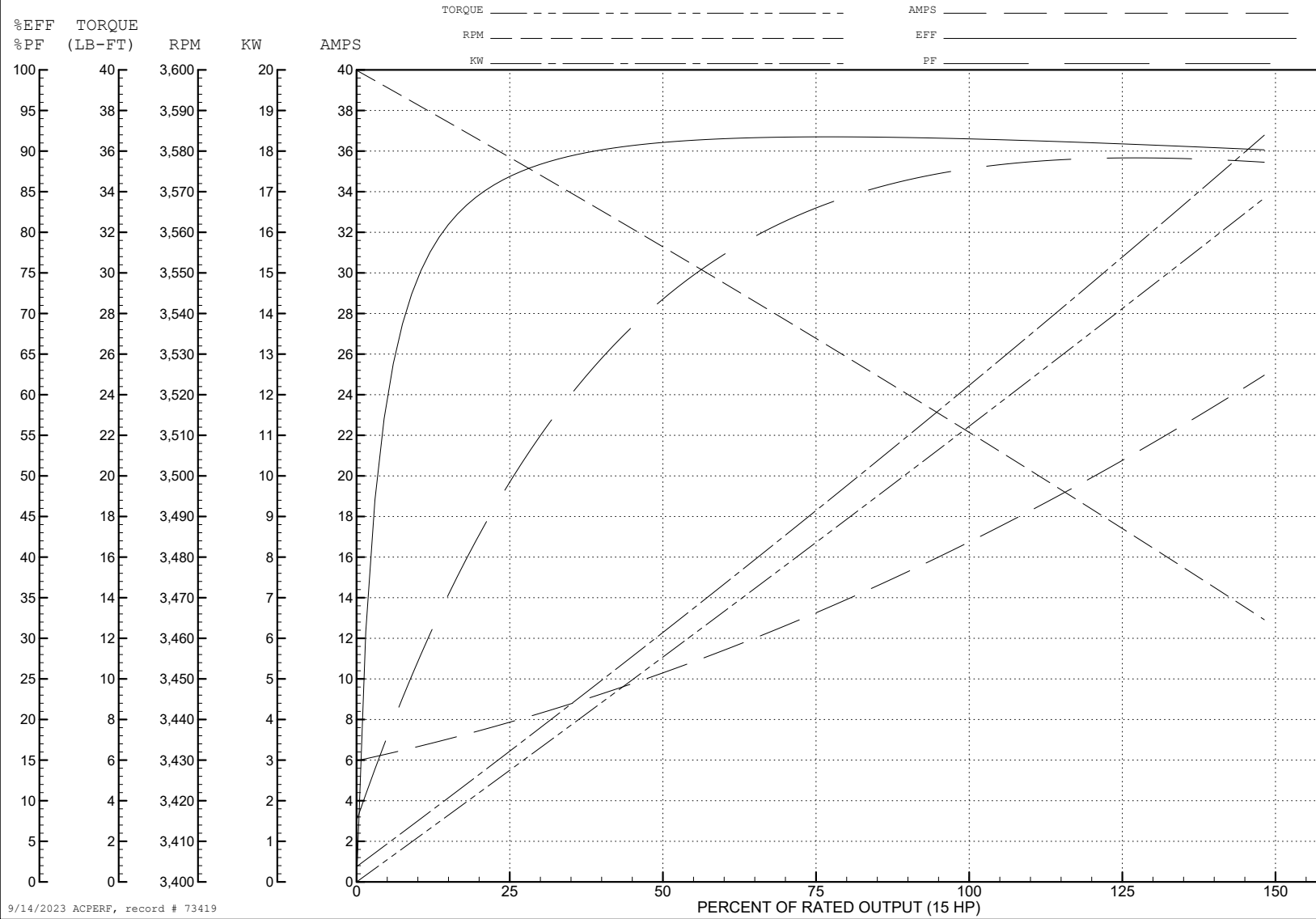

9/14/2023 ACPERF, record # 73419

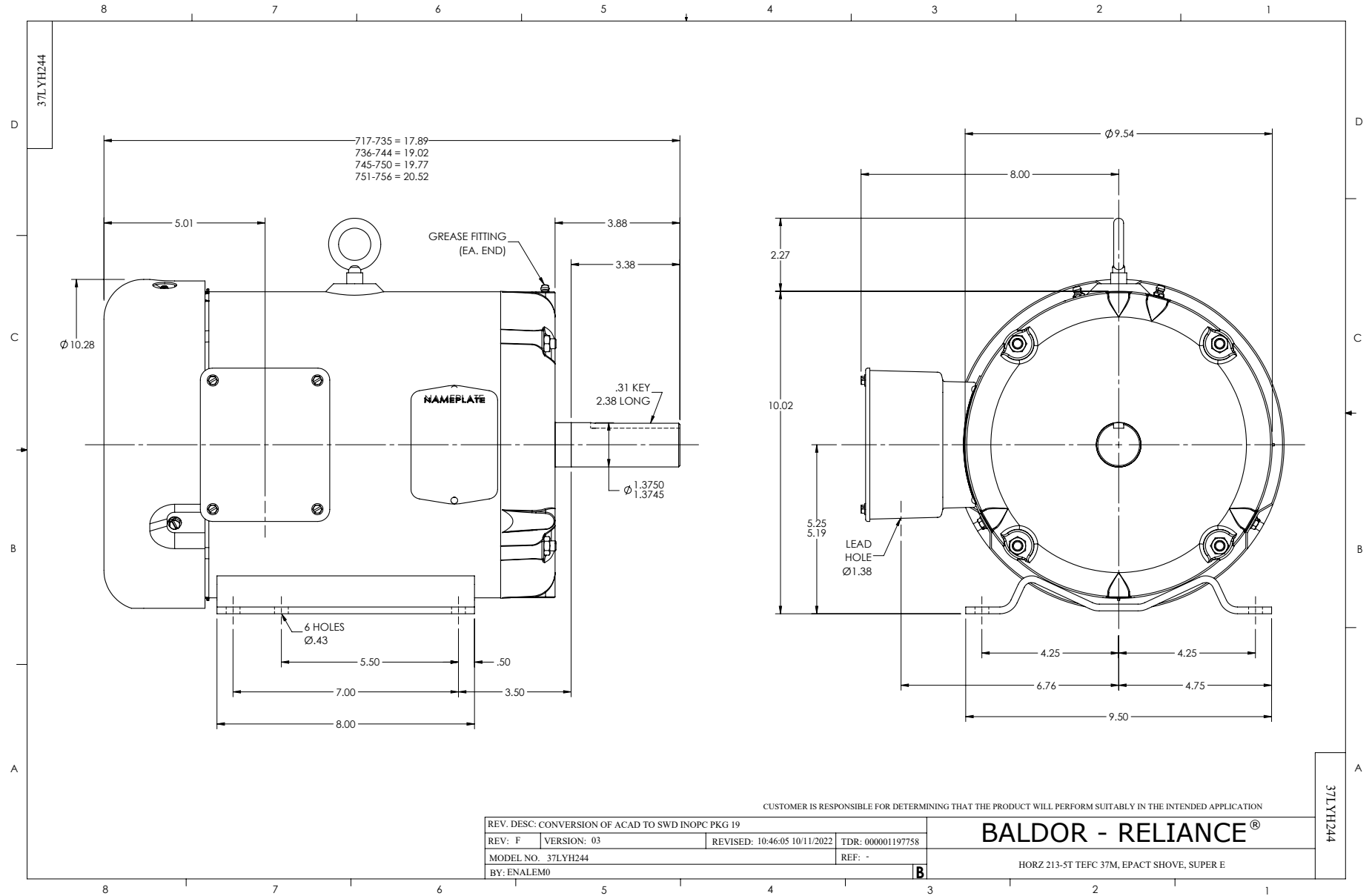

CD0180

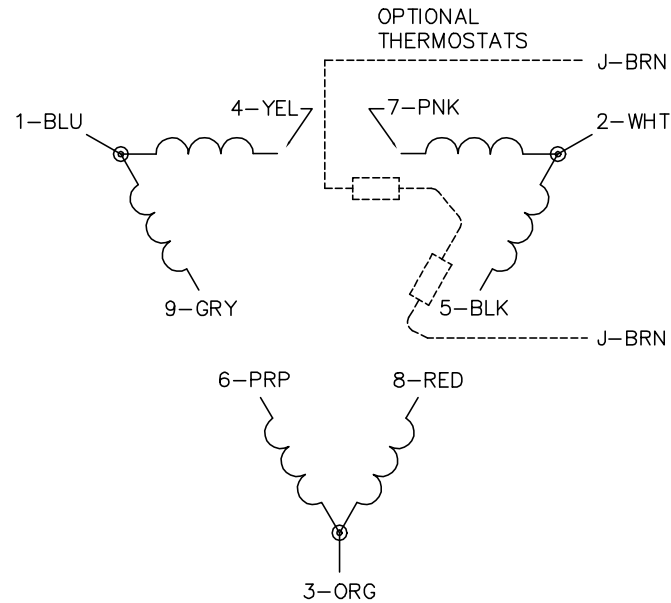

LOW VOLTAGE
(2D)

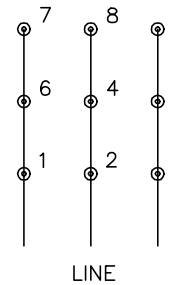

HIGH VOLTAGE
(1D)

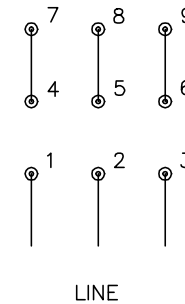

NOTES:

1. INTERCHANGE ANY TWO LINE LEADS TO REVERSE ROTATION.
2. OPTIONAL THERMOSTATS ARE PROVIDED WHEN SPECIFIED.
3. ACTUAL NUMBER OF INTERNAL PARALLEL CIRCUITS MAY BE A MULTIPLE OF THOSE SHOWN ABOVE.
4. LEAD COLORS ARE OPTIONAL. LEADS MUST ALWAYS BE NUMBERED AS SHOWN.

CD0180

REV. DESC: ADD CLASS CONN00000007		
REV. LTR: D	VERSION: 01	TDR: 000001099922
FILE: \AAA\00005\148	REVISED: 10: 25: 29 02/19/2019	BY: ENBRIRO
MTL: -	© □	

BALDOR - RELIANCE®

3PH, DV, 9 LEADS, DELTA CONNECTION

SH 1 of 1