

LOGIC

SUPPLY



BUILD IT WITH LOGIC

Industrial Computers Engineered For Reliability

2019 Q1

TASHA DICKINSON ↗
PRODUCT MANAGER

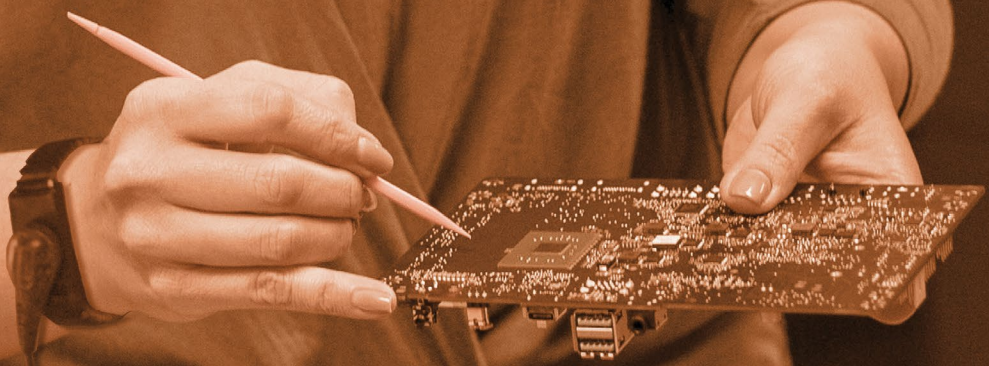



HANS BRAKELEY
MECHANICAL ENGINEER

Contents

- Our Market**
IoT & Beyond..... 3

- Our Process**
From Inquiry Through Rollout 5

- Our Services**
Leave the Hardware to Us..... 7

- Our Results**
Spotlight on Singlewire 9

- Our Products**11
 - New Arrivals13
 - Commercial Line.....17
 - Industrial Line27
 - Rugged Line.....45
 - Rackmount Line59
 - Panel PC Line.....67



**ALSO IN THIS CATALOG -
REAL LIFE CUSTOMER STORIES**

JIM WATSON
FIELD APPLICATIONS ENGINEER

POWERING YOUR INNOVATION

OUR MARKET

Connecting You At The IoT Edge

Application expertise across industries

Enabling Smart Retail



- Digital Signage
- Wayfinding
- Point of Sale Kiosks

From creating immersive shopping experiences, to advanced merchandising and on-site e-commerce, Logic Supply hardware helps enable today's smart retail revolution.

Advancing Smart Medicine



- Medical Carts
- Patient Data Management
- Telemedicine

With a focus on hardware reliability, our systems help manage and protect critical data and connect doctors with patients more quickly and effectively than ever before.

Driving Smart Industry



- Manufacturing
- Logistics
- Machine Vision

Enabling the Industrial Internet of Things and the evolution of Industry 4.0, Logic Supply computers help to reduce downtime and enhance operational efficiency.

Connecting The Smart City



- Surveillance
- Building Automation
- Autonomous Vehicles

Built for the demands of outdoor, mobile and remote deployments, computing solutions from Logic Supply provide unparalleled connectivity and installation flexibility.

OUR PROCESS

Getting You To Production Faster

A four step approach to project success



Step 1 - Select Your Hardware & Setup Your Account

- Select your PC yourself or work with us on Needs Analysis and Solution Development.
- Leverage our online tools and comprehensive Hardware Checklist.
- If you are prototyping for a volume project, apply for TryLogic, our risk-free trial program.
- Finally, set up your account, complete vendor/supplier forms and your credit application.



Step 2 - Validate Your Prototype

- Develop your application and validate that the computer will meet your needs.
- Receive a free Prototype Follow Up seven days after you receive your system.
- Once you have confirmed your hardware choice, we can provide a Volume Quote & Proposal.
- Want to visit Logic Supply? We would be happy to host you.



Step 3 - Customize Your PC & Add Services

- Need additional customization? Our in-house team of engineers, FAEs, and regulatory experts can help with "last mile" hardware changes, custom branding and certifications.
- Need more? We can augment your hardware with modular services like Rapid Branding, Imaging & BIOS Changes, Custom Labeling & Serializing. We also offer business related services like Extended Warranties, Consignment, Leasing, and Drop Shipping.



Step 4 - Deploy Your Solution

- Work with us to forecast demand and schedule deliveries so we can meet your lead times.
- We'll produce your systems in our ISO 9001 manufacturing facilities.
- Our team will ship, or drop ship your goods as desired.
- Contact our Technical Support team by phone or email if you need help.
- Finally, we'll work with you to monitor product lifecycles and plan any necessary migrations.

TryLogic 30-Day Risk-Free Prototyping

Learn More

logicsupply.com/trylogic19

DELIVERING WHAT YOU NEED, ON TIME

MARK FITZKO
HEAD OF FULFILMENT



*TOSHA HAWLEY
PRODUCT MANAGER*



BRINGING YOUR IDEAS TO LIFE

OUR SERVICES

Creating Your Unique Solution

Modular services, from branding through fulfillment



PROTOTYPING

The first phase in any hardware project is arguably the most important. We've designed a suite of services to ensure you get the right system to test for your application, fast.



TESTING

Logic Supply is an experienced system integrator capable highly-specific production and testing runs of any size in our ISO Certified facility using our proprietary Marathon™ software.



ENGINEERING

Logic Supply's in-house Design and Engineering team, comprised of mechanical and electrical engineers, as well as industrial designers, offers an array of engineering services.



FULFILLMENT

Simplify your supply chain by utilizing our warehouse to store your built and tested systems. Ship directly to your customers from our facilities to cut shipping times and keep you out of logistics.



BRANDING

Our branding services help you improve the out-of-box experience and allow you to personalize your hardware and packaging with your colors, logos, product name, or custom inserts.



SUPPORT

We know you rely on our computers for 24/7 uptime in challenging environments, so having an experienced technical support department backed by a robust warranty is something we take pride in.



IMAGING

Simplify the setup process for you and your customers by letting us handle all your imaging and BIOS customization needs. You focus on your business, leave the hardware to us.



LIFECYCLE MANAGEMENT

Our Product Management team takes great care to ensure that we can offer embedded lifecycles of at least 3-5 years on the vast majority of our hardware solutions.



CERTIFICATIONS

We take a consultative approach in working with you to ensure your computer complies with any industry or application-required standards, from FCC or CE compliance, to CCC certification.



FINANCING

Purchase online in just a few steps or let our Solution Specialists assist you with more complex purchasing and financing agreements.

Learn More

logicsupply.com/services19



 **SPOTLIGHT: SINGLEWIRE**

"Logic Supply worked with us in terms of putting the branding onto the system and really making it feel like a Singlewire device. They've also helped us with logistics in terms of getting it to our customers, making it a real partnership in the sense that it's really an extension of Singlewire."

—Pat Scheckel, Singlewire Executive VP of Product Management & Marketing

A leader in emergency and mass notification software, Singlewire was looking for a fast, reliable, branded system they could deploy to customers who often lack a reliable internet connection or any type of virtualization capabilities.

What they found was the fastest system they'd ever tested, the Logic Supply CL100. More than that, they found a partner that fit into their business and development workflow, and a guide through the regulatory certifications required for their application. Now, their Informacast Fusion Server is helping to protect and inform their clients in the event of an emergency. ■





OUR RESULTS

Helping You Realize Your Vision

Products and services that empower you to Build It With Logic

MURAT ERDOGAN
VP OF PRODUCTS

DESIGNING FOR YOUR SUCCESS

OUR PRODUCTS

Providing Hardware For Your Innovation

Industrial computers designed to last, built to order, delivered in days

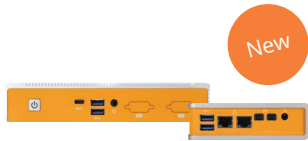

New Arrivals

The newest additions to our hardware lines, including our smallest and most flexible systems ever.

p13

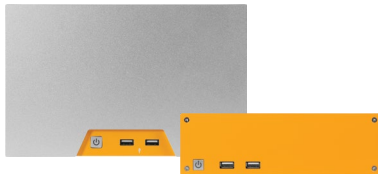

Commercial Line

Reliable performance, compact footprint. Actively cooled, small form factor PCs.

p17



Industrial Line

The latest in cutting-edge fanless and ventless design. Hardshell™ Fanless Technology ensures reliability.

p27



Rugged Line

Durable, fanless systems that stand up to dust, extreme temps and vibration. Powerful computing in an ultra-reliable, compact footprint.

p45



Rackmount Line

Easy to integrate 1U, 1.5U and 2U rackmount computers. Energy efficient and ideal for networking, servers or data acquisition.

p59



Panel PC Line

Industrial touchscreens for kiosk, POS and HMI applications. Unique modular design and an IP65 rated front bezel create a flexible, durable all-in-one solution.

p67



CL200

Our Smallest Fanless PC Ever

New

IoT Ready

Ready for the Industrial IoT edge, the CL200 Series is configurable with 4G LTE capability or Wi-Fi and Bluetooth - all in one ultra-small device.

[Learn more on p32 >](#)

x86 Architecture

The CL200 Series makes development easy and integration seamless, thanks to its x86 architecture.

Sealed, Fanless Design

Hardshell™ Fanless Technology seals components in a durable, ventless enclosure that cools and protects the system.

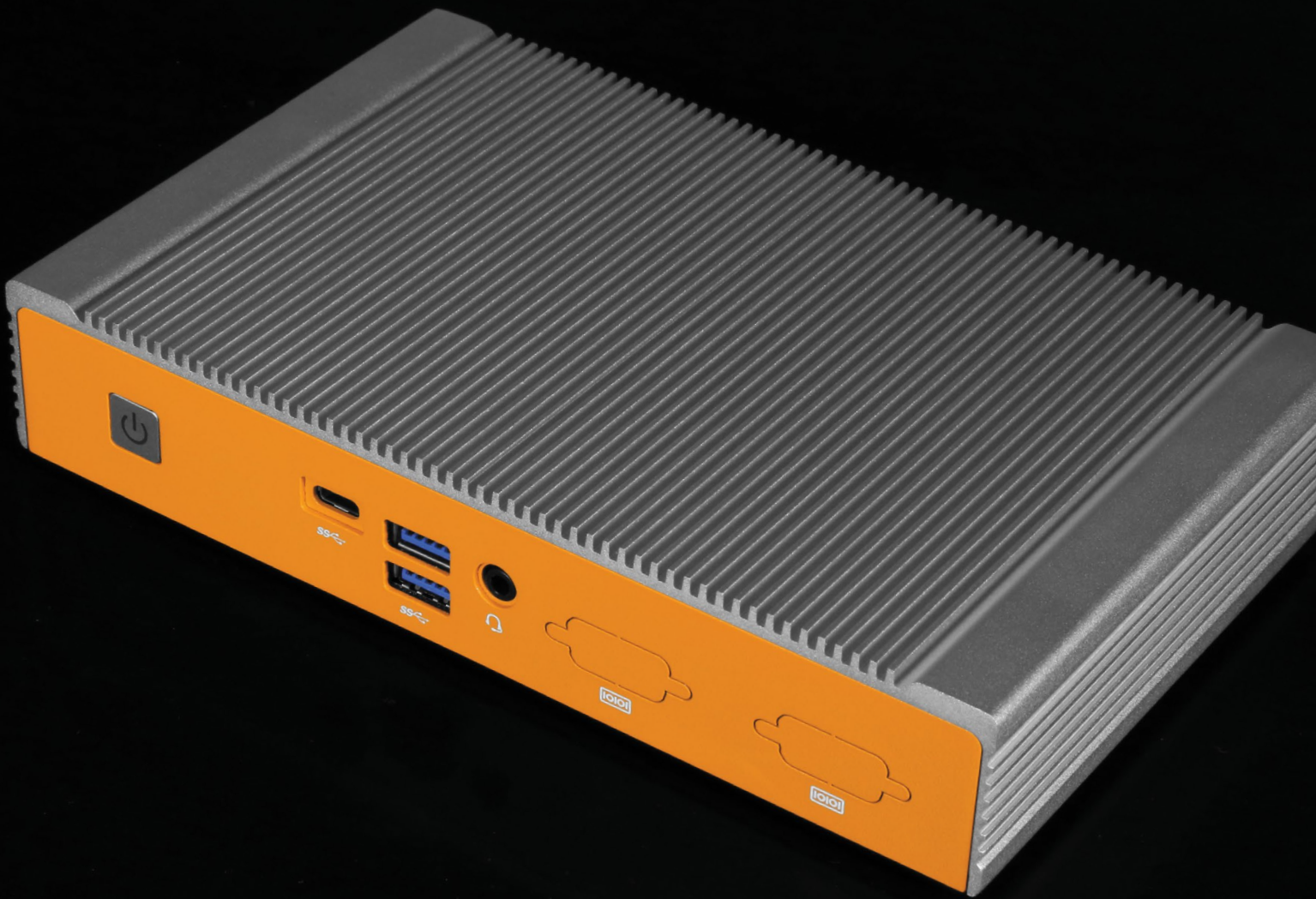

ML350 Adaptable for Any Application

New

Intel® Apollo Lake Processing
With Apollo Lake processing, the ML350 is ready to tackle industrial tasks and data acquisition while staying lean, cool, and efficient.

3 Expansion Slots
Two full-height mPCIe and one mSATA slot gives you room to build the ML350 to your specifications.

Dual LAN, Wi-Fi Or 4G
With two optional COM ports, 6 USB, dual Gb LAN, and 4G LTE options, the ML350 was purpose-built with connection in mind.

[Learn more on p34 >](#)



NC100

The NUC, Reimagined

New

Palm-Sized Performance

Measuring just 115 x 113 x 46mm, the NC100 brings desktop-level performance without the extra real estate.

Ultra HD 4K Displays

Equipped with Intel® HD 620 Graphics, the NC100 offers native 4K support via two HDMI ports.

Ultimate Connection

With LAN, Wi-Fi/Bluetooth, the NC100 can be configured to fit your application.

[Learn more on p19 >](#)



COFFEE LAKE More Cores, More Performance, More Connectivity



New 6 Core CPUs

Intel® 8th generation processors feature 6-cores and Hyper-Threading capabilities for impressive performance and multitasking.

USB 3.1 Gen 2 Support

With models featuring the H310 chipset, native support for the latest USB connectivity standard means data transfer speeds of up to 10Gbps.

Multi-Display Optimized

The new H310 chipset also provides support for 3 full-featured DisplayPorts, making Coffee Lake a great option for digital signage or other multi-display applications.



COMMERCIAL LINE

Reliable performance, compact footprint.
Actively cooled, small form factor PCs.

Designed For Durability



Advanced Cooling

Our Commercial Line utilizes cross-case ventilation to keep fan noise to a minimum while providing the system with the ability to operate 24/7 without failure.



EMI & ESD Protected

With its durable zinc coated steel construction, our Commercial Line resists corrosion and rust. Double right angle folds at interfacing edges reduce EMI and improve EMC performance.















Versatile Configurations

Our Commercial Line lends itself to limitless configurations with support for nearly every Mini-ITX motherboard. Eight mounting points support additional drives for storage intensive applications.

Logic Supply Commercial Computers

Actively Cooled And Highly-Configurable

	 NC100 Series Commercial Mini PCs 1 Model	 MC500 Series Commercial Mini-ITX PCs 2 Models	 MC600 Series Mini-ITX with Expansion 2 Models	 MC850 Series GPU Capable Computer 3 Model
Features	 DIN, VESA, and Wall Mounting  2 4K Displays	 DIN, VESA, and Wall Mounting  2 Displays	 DIN and Wall Mounting  PCIe x16 Expansion	 GPU Capable  Server Grade Hardware
Processor Options	<div style="display: flex; justify-content: space-around;"> <div style="background-color: #ccc; width: 20px; height: 10px;"></div> <div style="background-color: #ccc; width: 20px; height: 10px;"></div> <div style="background-color: #e67e22; width: 20px; height: 10px;"></div> </div> Celeron® Pentium® Core™ i3 <div style="display: flex; justify-content: space-around;"> <div style="background-color: #e67e22; width: 20px; height: 10px;"></div> <div style="background-color: #e67e22; width: 20px; height: 10px;"></div> <div style="background-color: #ccc; width: 20px; height: 10px;"></div> </div> Core i5 Core i7 Xeon®	<div style="display: flex; justify-content: space-around;"> <div style="background-color: #e67e22; width: 20px; height: 10px;"></div> <div style="background-color: #e67e22; width: 20px; height: 10px;"></div> <div style="background-color: #e67e22; width: 20px; height: 10px;"></div> </div> Celeron Pentium Core i3 <div style="display: flex; justify-content: space-around;"> <div style="background-color: #e67e22; width: 20px; height: 10px;"></div> <div style="background-color: #e67e22; width: 20px; height: 10px;"></div> <div style="background-color: #ccc; width: 20px; height: 10px;"></div> </div> Core i5 Core i7 Xeon	<div style="display: flex; justify-content: space-around;"> <div style="background-color: #e67e22; width: 20px; height: 10px;"></div> <div style="background-color: #e67e22; width: 20px; height: 10px;"></div> <div style="background-color: #e67e22; width: 20px; height: 10px;"></div> </div> Celeron Pentium Core i3 <div style="display: flex; justify-content: space-around;"> <div style="background-color: #e67e22; width: 20px; height: 10px;"></div> <div style="background-color: #e67e22; width: 20px; height: 10px;"></div> <div style="background-color: #ccc; width: 20px; height: 10px;"></div> </div> Core i5 Core i7 Xeon	<div style="display: flex; justify-content: space-around;"> <div style="background-color: #e67e22; width: 20px; height: 10px;"></div> <div style="background-color: #e67e22; width: 20px; height: 10px;"></div> <div style="background-color: #e67e22; width: 20px; height: 10px;"></div> </div> Celeron Pentium Core i3 <div style="display: flex; justify-content: space-around;"> <div style="background-color: #e67e22; width: 20px; height: 10px;"></div> <div style="background-color: #e67e22; width: 20px; height: 10px;"></div> <div style="background-color: #e67e22; width: 20px; height: 10px;"></div> </div> Core i5 Core i7 Xeon
Memory	Up to 32 GB	Up to 32 GB	Up to 32 GB	Up to 64 GB
Connectivity	Wi-Fi and Bluetooth	4G or Wi-Fi and Bluetooth	4G or Wi-Fi and Bluetooth	4G or Wi-Fi and Bluetooth

[Learn more on p19 >](#)

[See detailed specs on p23 >](#)

[Learn more on p20 >](#)

[See detailed specs on p23 >](#)

[Learn more on p21 >](#)

[See detailed specs on p24 >](#)

[Learn more on p22 >](#)

[See detailed specs on p24-25 >](#)



NC100

The NUC, Reimagined



Model

See detailed specs on p23 >



NC100-50



- Intel® Core i3-7100U, i5-7300U, i7-8650U
- Dual HDMI 2.0 and M.2 expansion
- DIN, VESA, and Wall mounting

Build Yours Online: www.logicsupply.com/nc100-series/

Dimensional Drawings



FRONT



SIDE

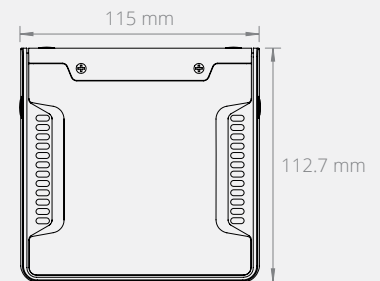

BOTTOM



MC500

A Versatile Mini-ITX PC



Models

See detailed specs on p23 >



MC500-11

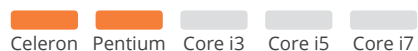

- Intel Celeron N3350 or Pentium N4200
- 6 USB, 3 COM, 2 Gb LAN
- Up to 8 GB of DDR3L memory



MC500-51



- Up to Intel Core i7
- 2 Gb LAN, 2 COM, DisplayPort, HDMI
- Up to 32 GB of memory

Build Yours Online: www.logicsupply.com/mc500-series/

Dimensional Drawings

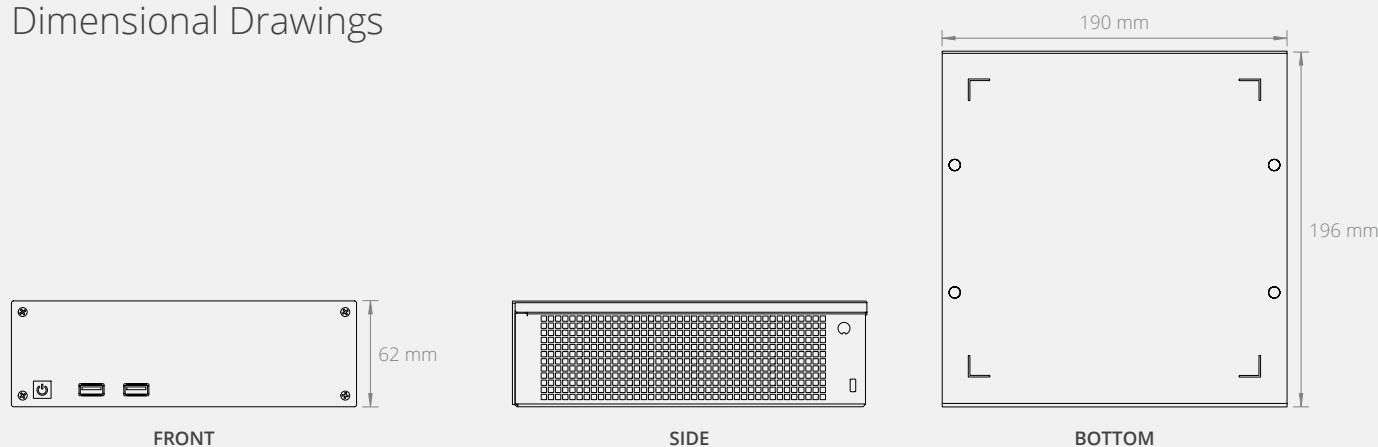

MC600

Mini-ITX With Expansion



Models [See detailed specs on p24 >](#)



MC600-11

4G Capable



- Intel® Celeron N3350 or Pentium N4200
- 6 USB, 3 COM, PCIe x1 slot
- Up to 8GB of DDR3L memory



MC600-52

4G Capable



- Up to Intel Core i7
- 2 Gb LAN, 2 COM, DisplayPort, HDMI
- PCIe x16 expansion options

Build Yours Online: www.logicsupply.com/mc600-series/

Dimensional Drawings

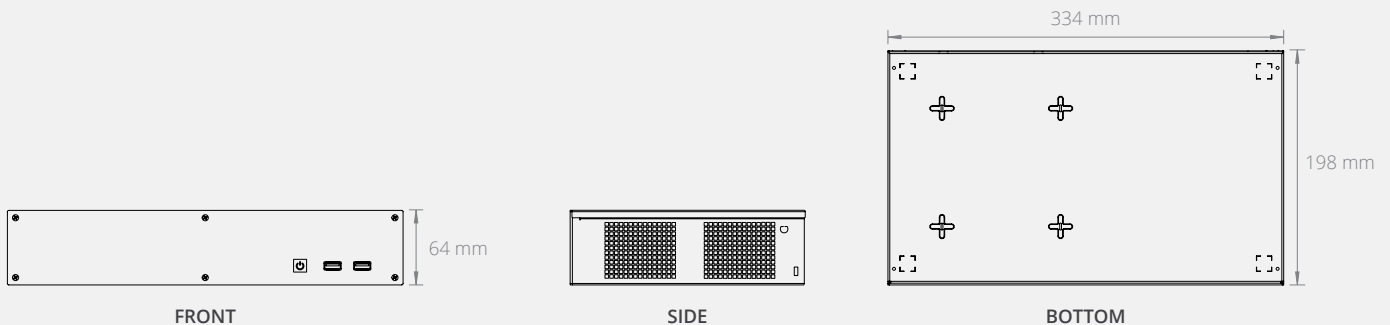

MC850

Small Footprint, Big Performance



Models

See detailed specs on p24-25 >



MC850-50



- Up to Intel Core i7
- Dual COM, triple independent displays
- Full height GPU compatibility



MC850-51



- Intel Xeon D1541 processor
- 2 GbE, 2 10GbE, 1 IPMI port
- Up to 64GB of memory



MC850-52

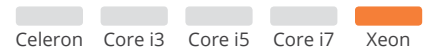

- Intel Xeon E3-1585v5 processor
- 4 GbE, 1 IPMI port
- Up to 64GB of memory

Build Yours Online: www.logicsupply.com/mc850-series/

Dimensional Drawings

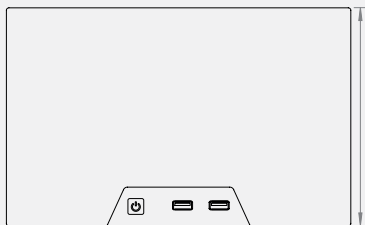

FRONT

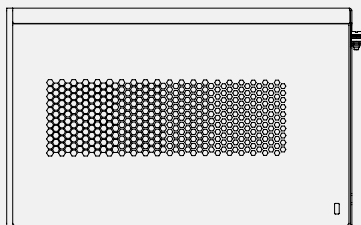

SIDE

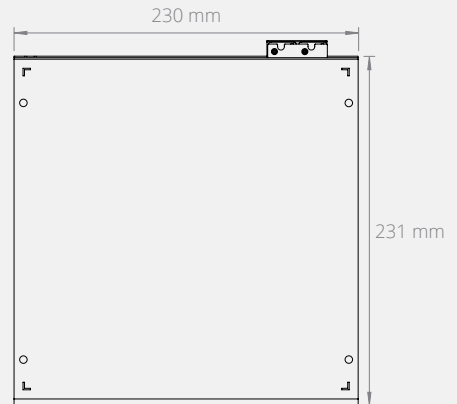

BOTTOM



Specifications

NC100-50

MC500-11

MC500-51

Series	NC100 Series	MC500 Series	
Processor	Intel® Core™ i3/i5/i7	Intel Celeron® N3350 Intel Pentium® N4200	Intel Celeron Intel Pentium Intel Core i3/i5/i7
Processor Speed	1.90 ~ 4.20 GHz	1.10 ~ 2.50 GHz	2.30 ~ 4.20 GHz
Processor Generation	Kaby Lake	Apollo Lake	Skylake Kaby Lake
Processor Cores / Threads	2 ~ 4 Cores / 4 ~ 8 Threads	2 ~ 4 Cores / 2 ~ 4 Threads	2 ~ 4 Cores / 2 ~ 8 Threads
Graphics / GPU	Intel HD Graphics 620 Intel UHD HD Graphics 620	Intel HD Graphics 500 Intel HD Graphics 505	Intel HD Graphics 510/530 Intel HD Graphics 610/630
Memory	DDR4-2133 SO-DIMM (non-ECC) DDR4-2400 SO-DIMM (non-ECC) Up to 32 GB	DDR3L-1866 SO-DIMM (non-ECC) Up to 8 GB	DDR4-2133 SO-DIMM (non-ECC) Up to 32 GB
Storage Options	1 NVMe/SATA III M.2 2280 SSD	1 SATA III M.2 2260/2280 SSD 1 SATA III 2.5" HDD/SSD	1 SATA III mSATA SSD 2 SATA III 2.5" HDD/SSD
Rear I/O	2 USB 3.0 ports 2 HDMI ports 1 Gb LAN port	1 VGA port 1 HDMI port 2 Gb LAN ports 4 USB 3.0 ports 3 COM (RS-232/422/485) ports 2 Audio (Mic-in, Line-out) jacks 2 PS/2 ports	1 HDMI port 1 DisplayPort 1 VGA port 4 USB 3.0 ports 2 Gb LAN ports 1 COM (RS-232/422/485) port 1 COM (RS-232) port 2 Audio (Mic-in, Line-out) jacks
Front I/O	2 USB 3.0 ports 1 Power Button	2 USB 2.0 Ports 1 Power Button	
Expansion Options	1 M.2 2230 (key E) slot	1 M.2 2230 (key E) slot 1 Mini-PCIe full/half height slot	1 Mini-PCIe full/half height slot
LAN Controller	1 Intel I219-LM GbE	2 Realtek RTL8111G GbE	1 Intel I210 GbE 1 Intel I219-V GbE
Input Voltage	12 ~ 24 V	12 V / 19~24 V	12 V
Power Input	DC jack	DC jack	
Operating Temp. Range	0 ~ 40°C	0 ~ 50°C	
Dimensions (WxHxD)	115 x 49 x 113 mm	190 x 62 x 196 mm	
Mounting Options	DIN Mount VESA Mount Wall Mount	DIN Mount VESA Mount Wall Mount	
Regulatory Information	2011/65/EU (RoHS 2 Directive) CE EN 55022 EN 55024 EN 55032 EN 60950-1 FCC 47 CFR Part 15	2011/65/EU (RoHS 2 Directive) CE EN 55022 EN 55024 EN 55032 EN 60950-1 FCC 47 CFR Part 15	2011/65/EU (RoHS 2 Directive) CE EN 55022 EN 55024 EN 55032 EN 60950-1 EN 62368-1 FCC 47 CFR Part 15



MC600-11



MC600-52



MC850-50



MC850-51

MC600 Series		MC850 Series	
Intel Celeron N3350 Intel Pentium N4200	Intel Celeron Intel Pentium Intel Core i3/i5/i7	Intel Celeron Intel Pentium Intel Core i3/i5/i7	Intel Xeon® D-1541
1.10 ~ 2.50 GHz	2.30 ~ 4.20 GHz	2.30 ~ 4.20 GHz	2.10 ~ 2.70 GHz
Apollo Lake	Skylake Kaby Lake	Skylake Kaby Lake	Broadwell
2 ~ 4 Cores / 2 ~ 4 Threads	2 ~ 4 Cores / 2 ~ 8 Threads	2 ~ 4 Cores / 2 ~ 8 Threads	8 Cores / 16 Threads
Intel HD Graphics 500 Intel HD Graphics 505	Intel HD Graphics 510/530 Intel HD Graphics 610/630	Intel HD Graphics 510/530 Intel HD Graphics 610/630 nVidia GTX 1060 (optional)	ASPEED AST2400
DDR3L-1866 SO-DIMM (non-ECC) Up to 8 GB	DDR4-2133 SO-DIMM (non-ECC) Up to 32 GB	DDR4-2133 SO-DIMM (non-ECC) Up to 32 GB	DDR4-2400 UDIMM (ECC) DDR4-2400 UDIMM (non-ECC) Up to 64 GB
1 SATA III M.2 2260/2280 SSD 1 SATA III 2.5" HDD/SSD	1 SATA III mSATA SSD 2 SATA III 2.5" HDD/SSD	1 SATA III mSATA SSD 2 SATA III 2.5" HDD/SSD	1 NVMe M.2 2280 SSD 2 SATA III 2.5" HDD/SSD
1 VGA port 1 HDMI port 2 Gb LAN ports 4 USB 3.0 ports 3 COM (RS-232/422/485) ports 2 Audio (Mic-in, Line-out) jacks 2 PS/2 ports	1 HDMI port 1 DisplayPort 1 VGA port 4 USB 3.0 ports 2 Gb LAN ports 1 COM (RS-232/422/485) port 1 COM (RS-232) port 2 Audio (Mic-in, Line-out) jacks	1 HDMI port 1 DisplayPort 1 VGA port 2 Gb LAN ports 4 USB 3.0 ports 2 COM (RS-232/422/485) ports 2 Audio (Mic-in, Line-out) jacks	2 USB 3.0 ports 1 VGA port 2 10Gb LAN ports 2 Gb LAN port 1 IPMI port 1 UID switch/LED
	2 USB 2.0 ports 1 Power Button	2 USB 2.0 ports 1 Power Button	1 Power Button
1 M.2 2230 (key E) slot 1 Mini-PCIe full/half height slot 1 PCIe x1 slot 2 Additional COM (RS-232) ports	1 Mini-PCIe full/half height slot 1 PCIe x16 slot 2 Additional COM (RS-232) ports	1 Mini-PCIe full/half height slot 1 PCIe x16 slot	1 PCIe x16 slot
2 Realtek RTL8111G GbE	1 Intel I210 GbE 1 Intel I219-V GbE	1 Intel I210 GbE 1 Intel I219-LM GbE	2 Intel I210 GbE 2 Intel X557-AT2 10GbE
	12 V		100 - 240 VAC
	DC jack		C13 - C14 Coupler
	0 ~ 50°C	0 ~ 50°C	10 ~ 35°C
	334 x 64 x 198 mm		230 x 146 x 241.5 mm
	DIN Mount Wall Mount		Wall Mount
	2011/65/EU (RoHS 2 Directive) CE EN 55022 EN 55024 EN 55032 EN 60950-1 FCC 47 CFR Part 15		2011/65/EU (RoHS 2 Directive) CE EN 55022 EN 55024 EN 55032 EN 60950-1 FCC 47 CFR Part 15

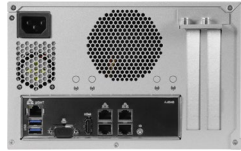

Specifications

MC850-52

NUC817HXK

Series	MC850 Series	Intel® Hades Canyon NUC
Processor	Intel® Xeon® E3-1585 v5	Intel Core™ i7-8705G Intel Core i7-8809G
Processor Speed	3.50 ~ 3.90 GHz	3.10 ~ 4.20 GHz
Processor Generation	Skylake	Kaby Lake G
Processor Cores / Threads	4 Cores / 8 Threads	4 Cores / 8 Threads
Graphics / GPU	Intel Iris Pro Graphics P580	AMD Radeon™ RX Vega M GL Graphics AMD Radeon RX Vega M GH Graphics Intel HD Graphics 630
Memory	DDR4-2133 SO-DIMM (ECC) DDR4-2133 SO-DIMM (non-ECC) Up to 64 GB	DDR4-2400 SO-DIMM (non-ECC) Up to 32 GB
Storage Options	2 SATA III 2.5" HDD/SSD	2 NVMe/SATA III M.2 2280 SSD
Rear I/O	2 USB 3.0 ports 1 HDMI port 1 VGA port 4 Gb LAN ports 1 RJ45 IPMI port 1 UID switch/LED	1 HDMI port 2 Mini DisplayPorts 2 Thunderbolt 3 USB Type-C ports 2 Gb LAN ports 4 USB 3.0 ports 1 Audio (Line-out, Optical-out) jack
Front I/O	2 USB 2.0 ports 1 Power Button	1 HDMI port 1 USB 3.0 charging port 1 USB 3.1 Gen 2 Type-A port 1 USB 3.1 Gen 2 Type-C port 1 Audio (Mic-in, Line-out) jack 1 SDXC UHS-I slot 1 Power button
Expansion Options	1 M.2 2230/2242 (key M) slot 1 PCIe x16 slot	1 M.2 2230 (key E) slot (pre-populated) 1 Intel Wireless-AC 8265
LAN Controller	4 Intel I350-AM4 LAN1 supports NCSI	1 Intel I210-AT GbE 1 Intel I219-LM GbE
Input Voltage	100 ~ 240 V AC	19 V
Power Input	C13 ~ C14 Coupler	DC jack
Operating Temp. Range	10 ~ 35°C	0 ~ 40°C
Dimensions (WxHxD)	230 x 146 x 241.5 mm	221 mm x 142 mm x 39 mm
Mounting Options	Wall Mount	VESA Mount (with bracket)
Regulatory Information	2011/65/EU (RoHS 2 Directive) CE EN 55022 EN 55024 EN 55032 EN 60950-1 FCC 47 CFR Part 15	2002/96/EC (WEEE Directive) 2011/65/EU (RoHS 2 Directive) CE EN 55024 EN 55032 EN 60950-1 FCC 47 CFR Part 15 IEC 60950-1 UL 60950-1 VCCI-CISPR-32



The future of delicious.
Mother



PUSH

 SPOTLIGHT: MOTHER

EATING BETTER

thanks to next generation, healthier vending machines.

Mother had a simple goal: help busy people eat better. The result is The Pod, a next generation, cloud-connected vending machine that's doing just that by using Logic Supply systems to ensure hungry customers always have the fuel they need.



INDUSTRIAL LINE

The latest in cutting-edge fanless and ventless design.
Hardshell™ Fanless Technology ensures reliability.

Logic Supply Industrial Computers

Built With Hardshell™ Fanless Technology

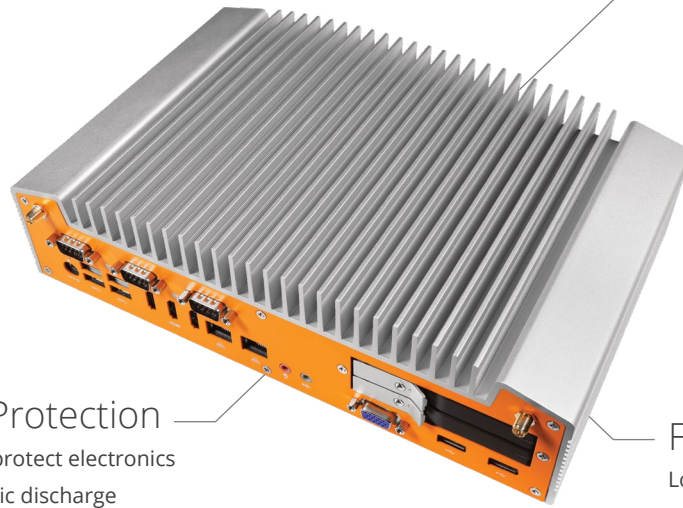

**No Fans,
No Vents, No Worries**
Our innovative Hardshell™ Fanless Technology ensures reliability by wrapping internal components in a durable, dust-resistant fanless enclosure.

Interference Protection
EMI-shielding gaskets protect electronics by directing electrostatic discharge through the case, while nickel plated interior coatings provide additional EMI protection.

Forward Thinking Design
Long lifecycle components, high performance cooling, and a forward thinking approach to enclosure architecture make the Industrial Line an ideal innovation platform.

Advanced Solid State Computing



At The IoT Edge
With a range of connectivity options, including our Extrovert 4G LTE modems, our Industrial Line helps bridge the gap between your data and the cloud, while powerful Intel® processing enables bandwidth-saving edge computing.

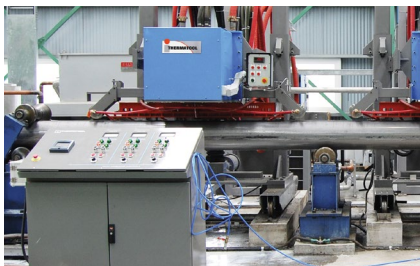

In Embedded Applications
Designed for easy integration, the Industrial Line is the perfect fit for device builders and OEMs who need an embedded solution that takes up minimal space while offering versatile, ultra-reliable computing performance.



Wherever You Need It
The Industrial Line lets you choose the configuration and customization options that best suit your unique application, while our selection of OEM services put you in control of the final look and feel of your hardware device.

Industrial Computers

Features



CL100 Series
Fanless Mini PC
1 Model



CL200 Series
Ultra Small Fanless PC
4 Models



ML100 Series
Fanless NUC
1 Model



ML300 Series
Low Profile Fanless NUC
2 Models



ML400 Series
Fanless Mini-ITX
3 Models



ML500 Series
High-Performance Fanless Mini-ITX
2 Models

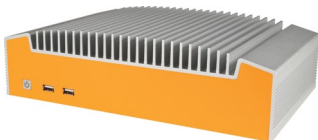

ML600 Series
Fanless Server
2 Models



Processor Options	Memory	Connectivity
<p>Celeron® Pentium® Core™ i3 Core i5 Core i7 Xeon®</p>	Up to 16 GB	<p>Wi-Fi and Bluetooth</p> <p>Learn more on p31 ></p> <p>See detailed specs on p39 ></p>
<p>Celeron Pentium Core i3 Core i5 Core i7 Xeon</p>	Up to 4 GB	<p>4G or Wi-Fi and Bluetooth</p> <p>Learn more on p32 ></p> <p>See detailed specs on p39 ></p>
<p>Celeron Pentium Core i3 Core i5 Core i7 Xeon</p>	Up to 32 GB	<p>4G or Wi-Fi and Bluetooth</p> <p>Learn more on p33 ></p> <p>See detailed specs on p40 ></p>
<p>Celeron Pentium Core i3 Core i5 Core i7 Xeon</p>	Up to 32 GB	<p>4G or Wi-Fi and Bluetooth</p> <p>Learn more on p34 ></p> <p>See detailed specs on p40 ></p>
<p>Celeron Pentium Core i3 Core i5 Core i7 Xeon</p>	Up to 32 GB	<p>4G or Wi-Fi and Bluetooth</p> <p>Learn more on p35 ></p> <p>See detailed specs on p40-41 ></p>
<p>Celeron Pentium Core i3 Core i5 Core i7 Xeon</p>	Up to 32 GB	<p>Wi-Fi and Bluetooth</p> <p>Learn more on p36 ></p> <p>See detailed specs on p41-42 ></p>
<p>Celeron Pentium Core i3 Core i5 Core i7 Xeon</p>	Up to 32 GB	<p>Wi-Fi and Bluetooth</p> <p>Learn more on p37 ></p> <p>See detailed specs on p42 ></p>



CL100

Anything, Anywhere



Model

See detailed specs on p39 >



CL100



- Intel® Celeron or Pentium processor
- 2 HDMI, 1 DisplayPort, Gb LAN
- 3 independent displays or 4K media playback

Build Yours Online: www.logicsupply.com/cl100-series/

Dimensional Drawings

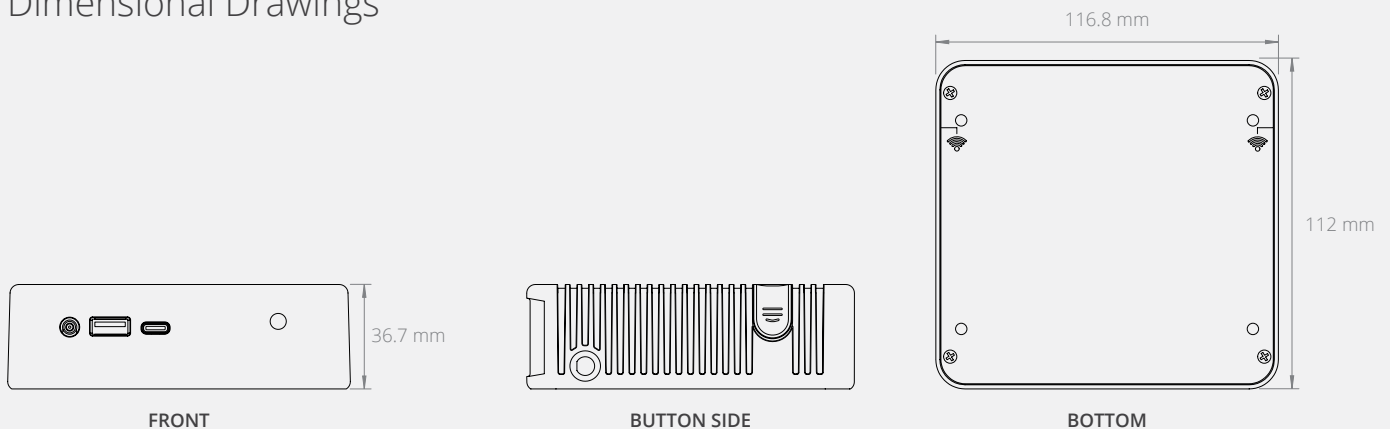

CL200

Our Smallest Fanless PC Ever

Industrial



Models

See detailed specs on p39 >



CL200G-10, CL200G-11

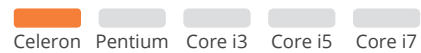

CL210G-10, CL210G-11

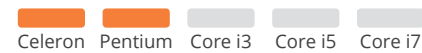

- Intel Celeron N3350 processor
- 4G Capable
- TPM via Intel Platform Trust Technology

- Intel Celeron or Pentium processor
- Dual LAN, 4G Capable
- TPM via Intel Platform Trust Technology

Build Yours Online: www.logicsupply.com/cl200-series/

Dimensional Drawings

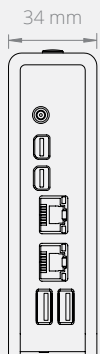

CL210G-10 FRONT

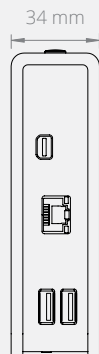

CL200G-10 FRONT

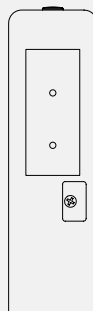

BACK

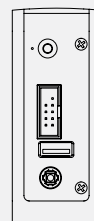

SIDE

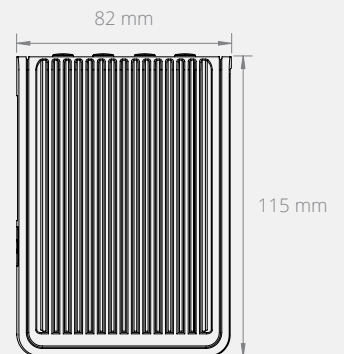

TOP



ML100

NUC, Evolved

Model

See detailed specs on p40 >



ML100G-31



Celeron® Pentium® Core™ i3 Core i5 Core i7

- Intel® Core i3, i5 or i7 processor
- Dual HDMI 2.0 and M.2 expansion
- DIN, VESA, and Wall mounting

Build Yours Online: www.logicsupply.com/ml100-series/

Dimensional Drawings

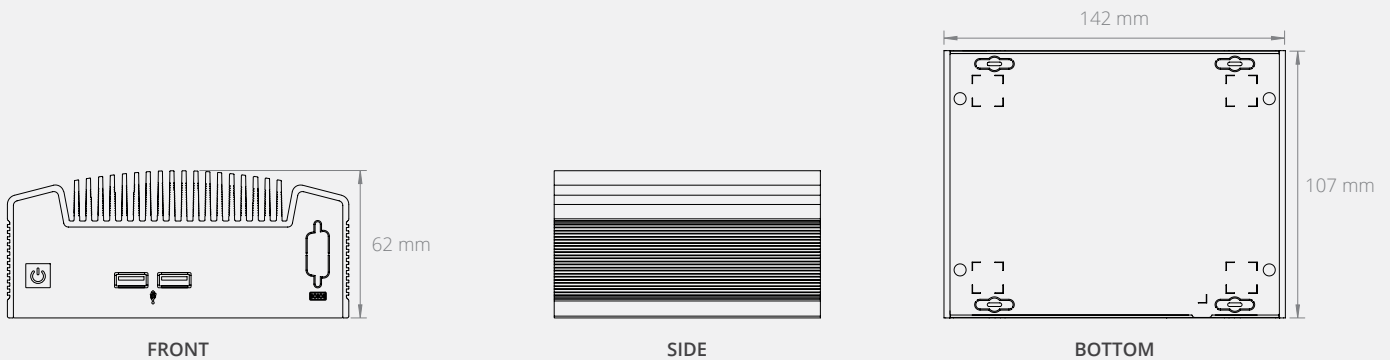



ML300

Compact & Customizable

Models [See detailed specs on p40 >](#)



ML340G-51

4G Capable



ML350G-10

4G Capable

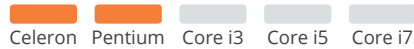

- Up to Intel Core i7
- Up to 32 GB of memory
- Dual DisplayPort connectors

- Intel Apollo Lake processing
- 2 mPCIe (1 w/ mSATA support), 1 mSATA
- Up to 8 GB of DDR3L memory

Build Yours Online: www.logicsupply.com/ml300-series/

Dimensional Drawings

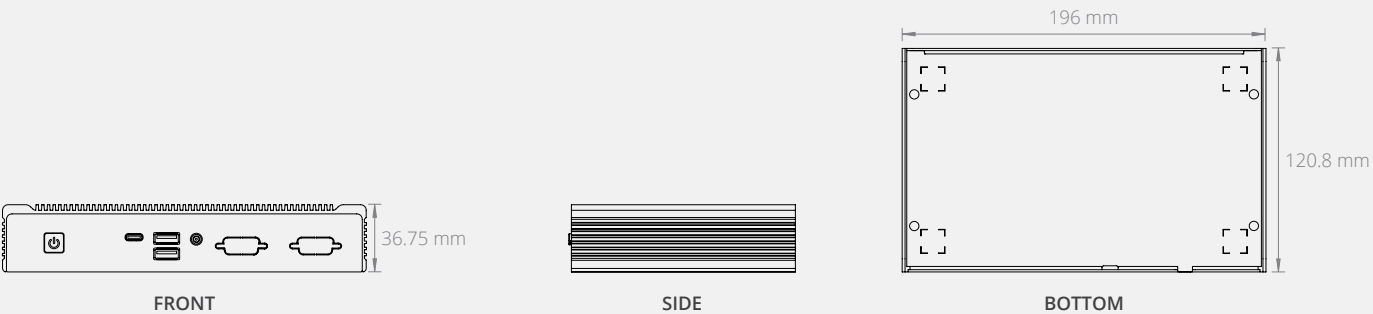

ML400

Industrial Mini-ITX



Models [See detailed specs on p40-41 >](#)

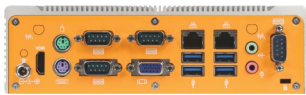

ML450G-11

4G Capable



- Intel® Apollo Lake processing
- 6 USB, 4 COM, dual Gb LAN
- Optional TPM



ML450G-51

4G Capable



- Up to Intel Core i5
- 3 HDMI, 3 COM, 1 VGA, dual Gb LAN
- Optional TPM



ML450G-52

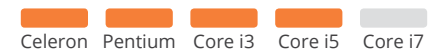

- Up to Intel Core i5
- 4 USB 3.0, dual Gb LAN, HDMI
- Optional 4 RS-232 COM

Build Yours Online: www.logicsupply.com/ml400-series/

Dimensional Drawings



FRONT

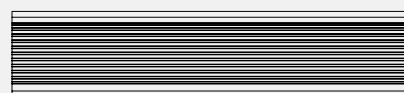

SIDE

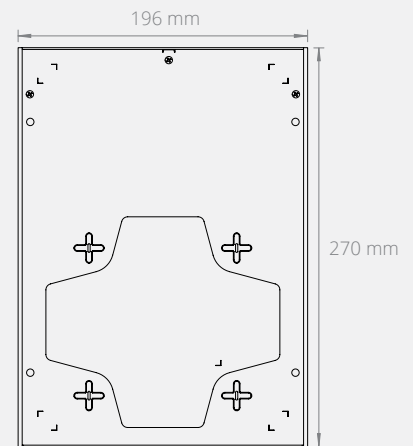

BOTTOM

ML500

High-Performance Mini-ITX



Models [See detailed specs on p41-42 >](#)



ML500G-30

- Celeron
- Pentium
- Core i3
- Core i5
- Core i7

- Up to Intel Core i7
- 4 USB 3.0, 2 Gb LAN, HDMI, DisplayPort
- Optional 4 COM



ML500G-50

- Celeron
- Pentium
- Core i3
- Core i5
- Core i7

- Up to Intel Core i7
- 2 COM, 4 USB 3.0, dual Gb LAN
- Wall and DIN mounting

Build Yours Online: www.logicsupply.com/ml500-series/

Dimensional Drawings

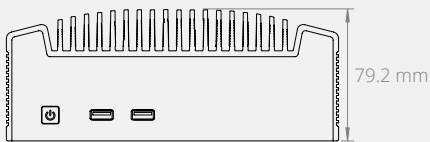

FRONT



SIDE

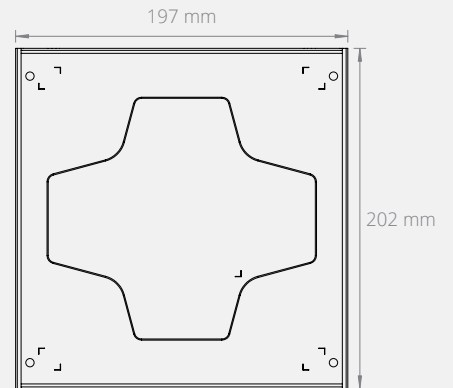

BOTTOM



ML600

Fanless Server Capability



Models [See detailed specs on p42 >](#)



ML600G-10

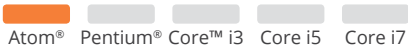

- Intel® Avoton processing
- Dual Gb LAN, COM, VGA, IPMI port
- Dual 2.5" hot-swap bays w/ RAID support



ML600G-52



- Up to Intel Core i7
- 3 HDMI, COM, dual Gb LAN
- Dual 2.5" hot-swap bays w/ RAID support

Build Yours Online: www.logicsupply.com/ml600-series/

Dimensional Drawings

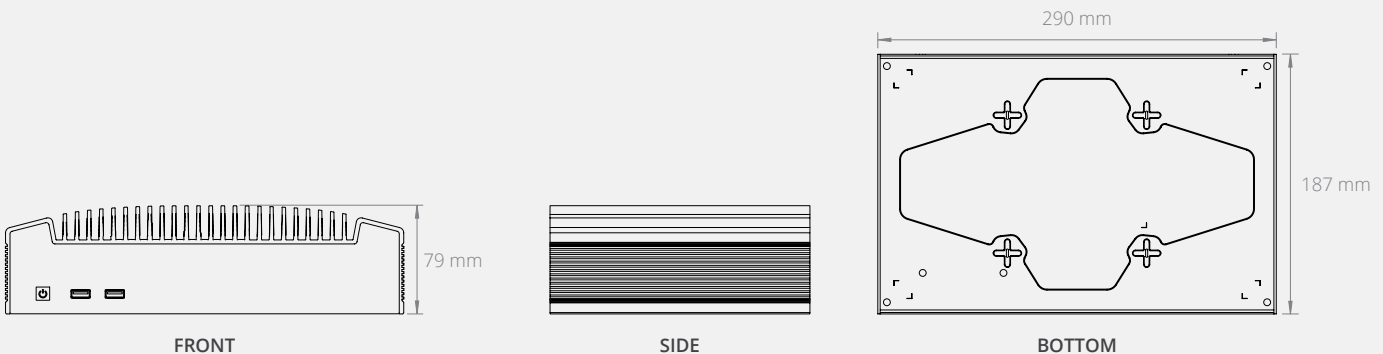



PROVIDING PEACE OF MIND

with secure asset issuance and tracking.

CaptureTech is helping businesses around the world protect and track valuable assets, like tools, tablets and keys with their CapLocker technology. Logic Supply hardware powers CaptureTech's RFID technology, ensuring dependable performance.

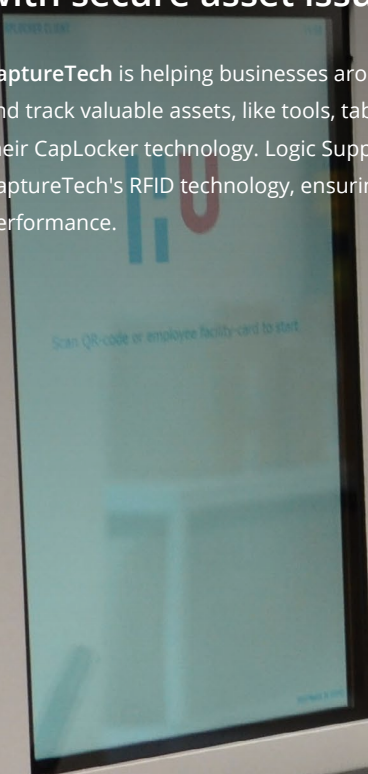



Specifications

CL100

CL200G-10, CL200G-11

CL210G-10, CL210G-11

Series	CL100 Series	CL200 Series	
Processor	Intel® Celeron® N3160 Intel Pentium® N3710	Intel Celeron N3350	Intel Celeron N3350 Intel Pentium N4200
Processor Speed	1.60 ~ 2.56 GHz	1.10 ~ 2.50 GHz	
Processor Generation	Braswell	Apollo Lake	
Processor Cores / Threads	4 Cores / 4 Threads	2 ~ 4 Cores / 2 ~ 4 Threads	
Graphics / GPU	Intel HD Graphics	Intel HD Graphics 500	Intel HD Graphics 500 Intel HD Graphics 505
Memory	DDR3L-1600 SO-DIMM (non-ECC) Up to 16 GB	LPDDR4-2133 (non-ECC) Up to 2GB	LPDDR4-2133 (non-ECC) Up to 4GB
Storage Options	1 SATA III mSATA SSD	1 eMMC up to 8 GB 1 SATA III mSATA SSD (colay with Mini-PCIe) 1 MicroSD card slot	1 eMMC up to 64 GB 1 SATA III mSATA SSD (colay with Mini-PCIe) 1 MicroSD card slot
Rear I/O	2 HDMI ports 1 DisplayPort 1 Gb LAN port 2 USB 3.0 ports	1 MicroSD Card slot 1 Power button 1 COM (RS-232) port 1 USB 2.0 port	
Front I/O	1 USB 3.0 port 1 USB 3.0 Type-C port 1 Audio (Mic-in, Line-out) jack	2 USB 3.0 ports 1 Mini DisplayPort 1 Gb LAN port	2 USB 3.0 ports 2 Mini DisplayPorts 2 Gb LAN ports 1 Audio (Mic-in, Line-out) jack
Expansion Options	1 Mini-PCIe half height slot	1 Mini-PCIe full height slot (colay with mSATA) 1 Mini-PCIe half height slot	
LAN Controller	1 Realtek RTL8111G GbE	1 Realtek RTL8111G GbE	2 Realtek RTL8111G GbE
Input Voltage	12 V	12 V	
Power Input	DC jack	DC jack	
Operating Temp. Range	0 ~ 40°C	0 ~ 40°C	
Dimensions (WxHxD)	116.75 x 36.7 x 112 mm	116 mm x 82 mm x 34 mm	
Mounting Options	VESA Mount (with bracket) DIN Mount Wall Mount	DIN Mount VESA Mount Wall Mount	
Regulatory Information	2011/65/EU (RoHS 2 Directive) CB scheme CE EN 55022, EN 55024, EN 55032, EN 60950-1 FCC 47 CFR Part 15 UL Listed configurations available	2002/96/EC (WEEE Directive) 2011/65/EU (RoHS 2 Directive) Additional Safety and EMC certifications pending CB scheme CE EN 55024, EN 55032, EN 62368-1 FCC 47 CFR Part 15, IEC 62368-1, IP50, UL Listed	



ML100G-31



ML340G-51



ML350G-10



ML450G-11

ML100 Series	ML300 Series		ML400 Series
Intel Core™ i3/i5/i7	Intel Core i3/i5/i7	Intel Celeron N3350 Intel Pentium N4200	Intel Celeron N3350 Intel Pentium N4200
1.90 ~ 4.20 GHz	2.30 ~ 3.40 GHz	1.10 ~ 2.50 GHz	1.10 ~ 2.50 GHz
Kaby Lake	Skylake	Apollo Lake	Apollo Lake
2 ~ 4 Cores / 2 ~ 4 Threads	2 Cores / 4 Threads	2 ~ 4 Cores / 2 ~ 4 Threads	2 ~ 4 Cores / 2 ~ 4 Threads
Intel HD Graphics 620 Intel UHD HD Graphics 620	Intel HD Graphics 520	Intel HD Graphics 500 Intel HD Graphics 505	Intel HD Graphics 500 Intel HD Graphics 505
DDR4-2133 SO-DIMM (non-ECC) DDR4-2400 SO-DIMM (non-ECC) Up to 32 GB	DDR4-2133 SO-DIMM (non-ECC) Up to 32 GB	DDR3L-1866 SO-DIMM (non-ECC) Up to 8 GB	DDR3L-1866 SO-DIMM (non-ECC) Up to 8 GB
1 NVMe/SATA III M.2 2280 SSD	1 SATA III mSATA SSD (colay with Mini-PCIe)	2 SATA III mSATA SSD (1 colay with Mini-PCIe)	1 SATA III M.2 2260/2280 SSD 1 SATA III 2.5" HDD/SSD
2 USB 3.0 ports 2 HDMI ports 1 Gb LAN port	4 USB 3.0 ports 2 DisplayPort connectors 2 Gb LAN ports	4 USB 2.0 ports 1/2 Gb LAN ports 2 DisplayPorts	1 VGA port 1 HDMI port 2 Gb LAN ports 4 USB 3.0 ports 1 COM (RS-232) port 1 COM (RS-232/422/485) port 2 Audio (Mic-in, Line-out) jacks
2 USB 3.0 ports 1 Power Button	2 USB 2.0 ports 1 Power Button	2 USB 3.0 ports 1 USB 3.0 Type-C port 1 Audio (Mic-in, Line-out) jack 1 Power Button	2 USB 2.0 ports 1 Power button
1 M.2 2230 (key E) slot 1 COM (RS232) port 8 Optical Isolated DIO (4 in, 4 out)	1 Mini-PCIe full/half height slot 1 Mini-PCIe full height slot (colay with mSATA) 3 COM (RS232) ports	1 Mini-PCIe full/half height slot 1 Mini-PCIe full height slot (colay with mSATA) 2 COM (RS232) ports	1 M.2 2230 (key E) slot 1 Mini-PCIe full/half slot 1 Parallel port
1 Intel I219-LM GbE	1 Intel I211-AT GbE 1 Intel I219-LM/V GbE	2 Realtek RTL8111G GbE	2 Realtek RTL8111G GbE
12 ~ 24 V	12 ~ 36 V	9 ~ 24 V	12 V / 19~24 V
DC jack	DC jack		DC jack
0 ~ 40°C	0 ~ 45°C	0 ~ 50°C	0 ~ 50°C
142 x 62 x 107 mm	196 x 36.75 x 141 mm	196 x 36.75 x 120.8 mm	196 x 57 x 270 mm
DIN Mount VESA Mount Wall Mount	DIN Mount VESA Mount Wall Mount		DIN Mount VESA Mount Wall Mount
2011/65/EU (RoHS 2 Directive) CE EN 55022, EN 55024, EN 55032, EN 60950-1 FCC 47 CFR Part 15	2011/65/EU (RoHS 2 Directive) CE EN 55022, EN 55024, EN 55032, EN 60950-1 FCC 47 CFR Part 15		211/65/EU (RoHS 2 Directive) CE EN (55022, 55024,55032,60950-1) FCC 47 CFR Part 15



Specifications

ML450G-51

ML450G-52

ML500G-30

Series	ML400 Series		ML500 Series
Processor	Intel® Celeron® Intel Pentium® Intel Core™ i3/i5		Intel Celeron Intel Pentium Intel Core i3/i5/i7
Processor Speed	2.30 ~ 2.70 GHz		2.30 ~ 3.80 GHz
Processor Generation	Skylake Kaby Lake		Skylake Kaby Lake
Processor Cores / Threads	2 ~ 4 Cores / 2 ~ 4 Threads		2 ~ 4 Cores / 2 ~ 8 Threads
Graphics / GPU	Intel HD Graphics 510/530 Intel HD Graphics 610/630		Intel HD Graphics 510/530 Intel HD Graphics 610/630
Memory	DDR4-2133 SO-DIMM (non-ECC) Up to 32 GB		DDR4-2133 SO-DIMM (non-ECC) Up to 32 GB
Storage Options	1 SATA III mSATA SSD (colay with Mini-PCIe) 2 SATA III 2.5" HDD/SSD		1 SATA III mSATA SSD (colay with Mini-PCIe)
Rear I/O	3 HDMI ports 2 Gb LAN ports 4 USB 3.0 ports 2 COM (RS-232/422/485) ports 1 COM (RS-232) port 1 VGA port 2 Audio (Mic-in, Line-out) jacks	1 HDMI port 1 DisplayPort 2 Gb LAN ports 4 USB 3.0 ports 2 Audio (Mic-in, Line-out) jacks	1 HDMI port 1 DisplayPort 2 Gb LAN ports 4 USB 3.0 ports 2 Audio (Mic-in, Line-out) jacks
Front I/O	2 USB 2.0 ports 1 Power button		2 USB 2.0 ports 1 Power button
Expansion Options	1 Mini-PCIe half height slot 1 Mini-PCIe full height slot (colay with mSATA)	1 Mini-PCIe half height slot 1 Mini-PCIe full/half height slot (colay with mSATA) 4 Additional COM (RS232) ports 2 Additional Gb LAN ports	1 Mini-PCIe half height slot 1 Mini-PCIe full/half height slot (colay with mSATA) 4 Additional COM (RS232) ports
LAN Controller	1 Intel I210 GbE 1 Intel I219-LM GbE	1 Intel I210 GbE 1 Intel I219-LM GbE	1 Intel I210 GbE 1 Intel I219-LM GbE
Input Voltage	12 V / 19~24 V	12V	12 V
Power Input	DC jack		DC jack
Operating Temp. Range	0 ~ 40°C		0 ~ 50°C
Dimensions (WxHxD)	196 x 57 x 270 mm		197 x 79.2 x 202 mm
Mounting Options	DIN Mount VESA Mount Wall Mount		DIN Mount VESA Mount Wall Mount
Regulatory Information	2011/65/EU (RoHS 2 Directive) CE EN 55022 EN 55024 EN 55032 EN 60950-1 FCC 47 CFR Part 15		2011/65/EU (RoHS 2 Directive) CE EN 55022 EN 55024 EN 55032 EN 60950-1 FCC 47 CFR Part 15



ML500G-50



ML600G-10



ML600G-52

ML500 Series	ML600 Series	
Intel Celeron Intel Pentium Intel Core i3/i5/i7	Intel Atom® C2550 Intel Atom C2750	Intel Celeron Intel Pentium Intel Core i3/i5/i7
2.30 ~ 3.80 GHz	2.40 ~ 2.60 GHz	2.30 ~ 4.20 GHz
Skylake Kaby Lake	Avoton	Skylake Kaby Lake
2 ~ 4 Cores / 2 ~ 8 Threads	4 ~ 8 Cores / 4 ~ 8 Threads	2 ~ 4 Cores / 2 ~ 8 Threads
Intel HD Graphics 510/530 Intel HD Graphics 610/630	ASPEED AST2300	Intel HD Graphics 510/530 Intel HD Graphics 610/630
DDR4-2133 SO-DIMM (non-ECC) Up to 32 GB	DDR3-1600 UDIMM (ECC) DDR3-1600 UDIMM (non-ECC) Up to 32 GB	DDR4-2133 SO-DIMM (non-ECC) Up to 32 GB
1 SATA III mSATA SSD	1 SATA III 2.5" HDD/SSD 2 SATA III 2.5" Hot-swap HDD/SSD	1 SATA III mSATA SSD (colay with Mini-PCIe) 2 SATA III 2.5" Hot-swap HDD/SSD
1 HDMI ports 1 DisplayPort 1 VGA port 2 Gb LAN ports 4 USB 3.0 ports 1 COM (RS-232/422/485) port 1 COM (RS-232) port 2 Audio (Mic-in, Line-out) jacks	1 USB 2.0 ports 2 Gb LAN ports 1 IPMI port 1 COM (RS-232) port 1 VGA port	3 HDMI ports 2 Gb LAN ports 2 USB 2.0 ports 4 USB 3.0 ports 2 COM (RS-232/422/485) ports 1 COM (RS-232) port 1 VGA port 2 Audio (Mic-in, Line-out) jacks
2 USB 2.0 ports 1 Power button	2 USB 2.0 ports 1 Power button	
1 Mini-PCIe full/half height slot	-	1 Mini-PCIe half height slot 1 Mini-PCIe full height slot (colay with mSATA)
1 Intel I210 GbE 1 Intel I219-V GbE	2 Intel I210 GbE	1 Intel I210 GbE 1 Intel I219-LM GbE
12 V	12 V	12 V / 19~24 V
DC jack	DC jack	
0 ~ 50°C	0 ~ 50°C	
197 x 79.2 x 202 mm	187 x 79 x 290mm	
DIN Mount VESA Mount Wall Mount	DIN Mount VESA Mount Wall Mount	
2011/65/EU (RoHS 2 Directive) CE EN 55022 EN 55024 EN 55032 EN 60950-1 FCC 47 CFR Part 15	2011/65/EU (RoHS 2 Directive) CE EN 55022 EN 55024 EN 55032 EN 60950-1 FCC 47 CFR Part 15	



SPOTLIGHT: TIMS MEDICAL

SAVING LIVES

with advanced medical video streaming.

TIMS Medical, a division of Foresight Imaging, chose Logic Supply to help them create their TIMS Consultant, a fully customized interactive video broadcast device being used worldwide to allow doctors, surgeons and other medical professionals to collaborate in real-time.





RUGGED LINE

Durable, fanless systems that stand up to dust, extreme temps and vibration. Powerful computing in an ultra-reliable, compact footprint.

Rugged Computers Engineered For Extreme Environments

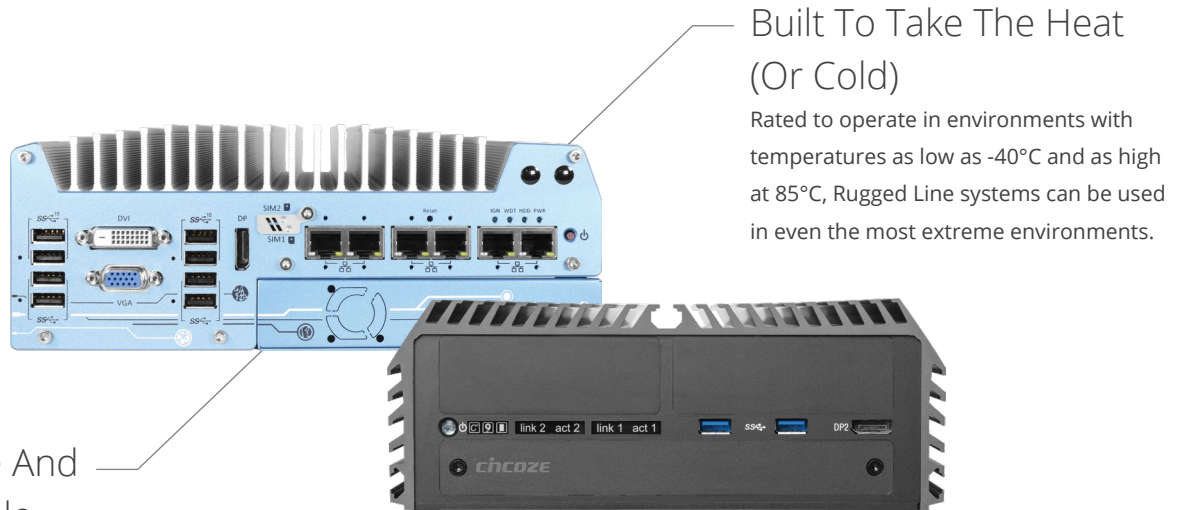

Built To Take The Heat (Or Cold)

Rated to operate in environments with temperatures as low as -40°C and as high as 85°C, Rugged Line systems can be used in even the most extreme environments.

Expandable And Customizable

With the varied needs of today's computing applications in mind, the Rugged Line features a huge range of expansion and configuration options to suit any application.

Shock And Vibration Resistant

With no moving parts and enhanced component isolation, the Rugged Line is built to last, even when subject to vibration or impact forces.

Built For The Most Challenging Computing Applications



In-Vehicle Computing

With enhanced shock & vibration resistance, and wide power input ranges, the Rugged Line is perfect for mobile computing applications.

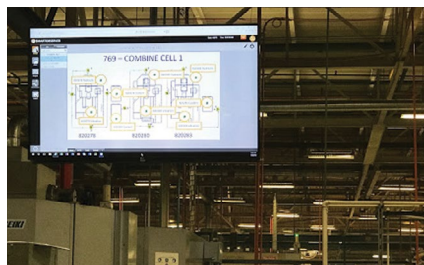

Industry 4.0

Highly-configurable, connectible and customizable, the Rugged Line can handle any machine vision, automation or Industrial Internet of Things tasks you throw at it.



Remote Installations

Built for 24/7 operation virtually anywhere, if your project makes accessing the computer hardware challenging, the ultra-dependable Rugged Line has you covered.

Rugged Computers

Features



DA & DC Series
Power Efficient & Compact
2 Models



Power Efficient



Compact



DI & DX Series
Compact Performance
2 Models



High Performance



Compact



DS Series
Expandable & Customizable
3 Models



High Performance



Expandable



POC Series
Palm-Sized Rugged
2 Models



Automotive Power



Compact



Nuvo-6000 Series
GPU Capable & Highly Expandable
1 Models



High Performance



GPU Capable



Nuvo-7000 Series
GPU Capable With Intel Coffee Lake CPU
5 Models



High Performance



Expandable

Processor Options

Memory

Connectivity

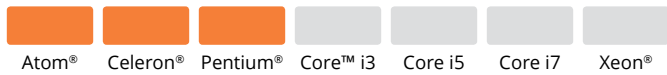

Up to 8 GB

4G or
Wi-Fi and Bluetooth

[Learn more on p49 >](#)

[See detailed specs on p53 >](#)



Up to 32 GB

4G or
Wi-Fi and Bluetooth

[Learn more on p49 >](#)

[See detailed specs on p54 >](#)



Up to 32 GB

4G or
Wi-Fi and Bluetooth

[Learn more on p49 >](#)

[See detailed specs on p54 >](#)

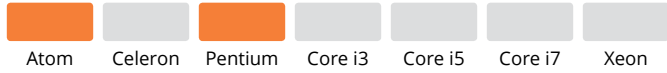

Up to 8 GB

4G or
Wi-Fi and Bluetooth

[Learn more on p51 >](#)

[See detailed specs on p55 >](#)

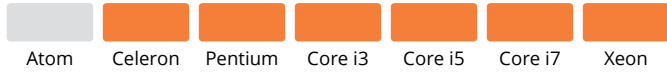

Up to 32 GB

Wi-Fi and Bluetooth

[Learn more on p51 >](#)

[See detailed specs on p55 >](#)

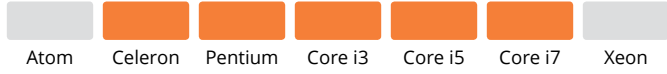

Up to 32 GB

4G or
Wi-Fi and Bluetooth

[Learn more on p51 >](#)

[See detailed specs on p56 >](#)



Rugged Computers

by Cincoze

Models

See detailed specs on p53-54 >



DA-1100

Atom® Celeron® Pentium® Core™ i3 Core i5

- 2 COM, 2 LAN, 4 USB 3.0, 1 USB 2.0
- 2 mPCIe, 1 CMI slot, CFM PoE
- CMI Expansion: COM, DIO, DP, DVI, VGA



DC-1200

Atom Celeron Pentium Core i3 Core i5

- 2 COM, 2 LAN, 4 USB 3.0
- 2 mPCIe, CFM Ignition Sensing & PoE
- CMI Expansion: COM, DIO, DVI, VGA



DI-1000

4G Capable

Celeron Pentium Core i3 Core i5 Core i7

- 6 COM, 2 LAN, 4 USB 3.0, 8-bit DIO
- 2 mPCIe, CFM Ignition Sensing
- CMI expansion: PoE, LAN



DX-1000

4G Capable

Pentium Core i3 Core i5 Core i7 Xeon®

- 4 COM, 2 LAN, 8 USB 3.0
- 4 mPCIe, CFM Ignition Sensing & PoE
- CMI Expansion: LAN, COM, DIO



DS-1200

Celeron Pentium Core i3 Core i5 Core i7

- 4 COM, 2 LAN, 6 USB 3.1, 2 USB 2.0
- 3 mPCIe, CFM Ignition Sensing & PoE
- CMI Expansion: LAN, COM, DIO

Build Yours Online: www.logicsupply.com/cincoze/

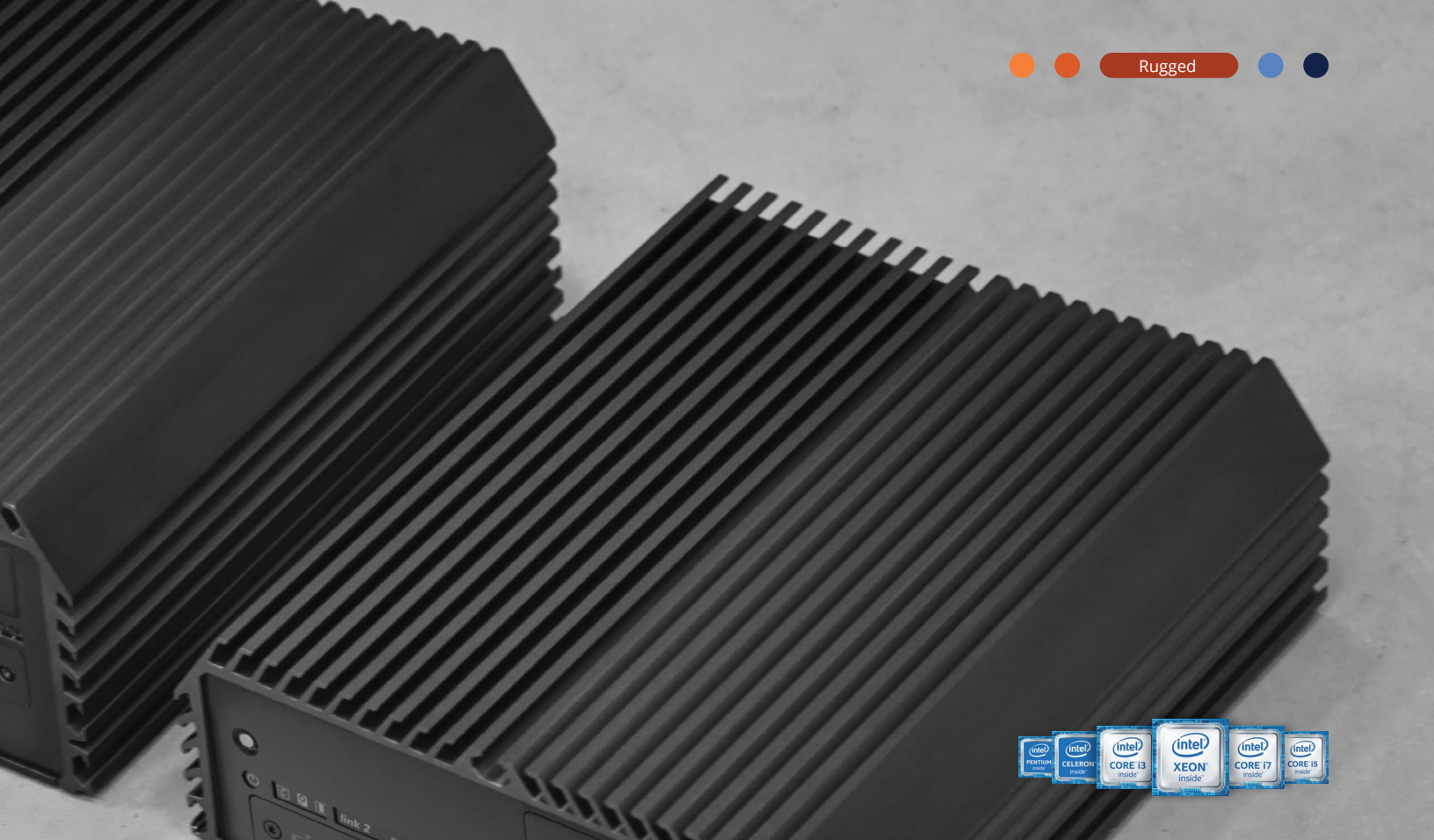

CMI Modules: I/O Expansion



Outfit Your Ideal Configuration

Cincoze CMI (Combined Multiple I/O) modules offer flexible connectivity expansion. Choose from an array of additional LAN, PoE, COM, DIO, DisplayPort, DVI or VGA to add to your compatible Cincoze rugged PC.



4x LAN or PoE (RJ45 or M12)

Compatible with:

- DI-1000, DX-1000, DS-1200



2 or 4x Serial COM Ports

Compatible with:

- 2x: DA-1100, DC-1200, DI-1000, DX-1000
- 4x: DS-1200



8 or 16-bit Isolated DIO Port

Compatible with:

- 8-bit: DA-1100, DC-1200, DS-1200
- 16-bit: DX-1000



1x DisplayPort

Compatible with:

- DA-1100, DC-1200



1x VGA Port

Compatible with:

- DA-1100, DC-1200



1x DVI-D Connector

Compatible with:

- DA-1100, DC-1200

Rugged Computers

by Neousys

Models

See detailed specs on p55-56 >



POC-300, POC-351VTC

Atom® Celeron® Pentium® Core™ i3 Core i5

- 2 COM, 2 LAN, 2 USB 3.0, 2 USB 2.0
- **300:** 1 mPCIe, 1 MeziO expansion port
- **351VTC:** 3 mPCIe, CAN bus



Nuvo-6108GC

Celeron Pentium Core i3 Core i5 Core i7

- 2 COM, 2 LAN, 4 USB 3.0
- 1 mPCIe, 1 M.2
- 1 PCIe x16 for up to 250W GPU



Nuvo-7000LP

Celeron Pentium Core i3 Core i5 Core i7

- 4 COM, 2 or 6 LAN, 8 USB 3.1
- 1 mPCIe, 1 M.2, 1 MeziO expansion port
- Low profile design



Nuvo-7000E, Nuvo-7000DE

Celeron Pentium Core i3 Core i5 Core i7

- 4 COM, 2 or 6 LAN, 8 USB 3.1
- 1 mPCIe, 1 M.2, 1 MeziO expansion port
- 1 PCIe x16 or 2 PCIe x8 slots



Nuvo-7160GC

Celeron Pentium Core i3 Core i5 Core i7

- 4 COM, 2 or 6 LAN, 8 USB 3.1
- 1 mPCIe, 1 M.2, 1 MeziO expansion port
- 1 PCIe x16 slot in cassette for 120W GPU



Nuvo-7100VTC

Celeron Pentium Core i3 Core i5 Core i7

- 4 COM, 2 or 6 LAN, 8 USB 3.1
- 3 mPCIe, 2 M.2
- Ignition Sensing, CAN bus, 8-bit DIO

Build Yours Online: www.logicsupply.com/neousys/



MezIO: I/O Expansion & Ignition Control



Choose The I/O You Need

Neosys MezIO (interchangeable mezzanine I/O board) allows you to incorporate application-oriented I/O. Logic Supply offers MezIO modules that feature RS-232/422/485, isolated DIO, ignition power control and storage expansion.

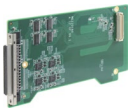

8x RS-232/422/485

Compatible with:

- POC-300, Nuvo-7000 Series



16 or 32-bit Isolated DIO

Compatible with:

- POC-300, Nuvo-7000 Series

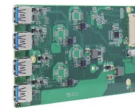

4x USB 3.0 ports

Compatible with:

- POC-300, Nuvo-7000 Series



16-mode Ignition Power Control

Compatible with:

- POC-300, Nuvo-7000 Series

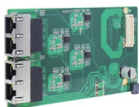

4x LAN or PoE

Compatible with:

- Nuvo-7000 Series



SATA port for 2.5" HDD/SSD

Compatible with:

- POC-300



DA-1100



DC-1200

Specifications

Series	DA Series	DC Series
Processor	Intel Atom® x5-E3940 Intel® Celeron® N3350 Intel Pentium® N4200	Intel Atom x5-E3940 Intel Celeron N3350 Intel Pentium N4200
Processor Speed	1.10 ~ 2.50 GHz	1.10 ~ 2.50 GHz
Processor Generation	Apollo Lake	Apollo Lake
Processor Cores / Threads	2 ~ 4 Cores / 2 ~ 4 Threads	2 ~ 4 Cores / 2 ~ 4 Threads
Graphics / GPU	Intel HD Graphics 500 Intel HD Graphics 505	Intel HD Graphics 500 Intel HD Graphics 505
Memory	DDR3L-1866 SO-DIMM (non-ECC) Up to 8 GB	DDR3L-1866 SO-DIMM (non-ECC) Up to 8 GB
Storage Options	1 SATA III mSATA SSD (colay with Mini-PCIe) 1 SATA III 2.5" HDD/SSD	1 SATA III mSATA SSD (colay with Mini-PCIe) 1 SATA III 2.5" HDD/SSD
Rear I/O	1 DVI-I port 2 COM (RS-232/422/485) ports	1 DVI-D port 2 COM (RS-232/422/485) ports 1 Remote Power On/Off connector
Front I/O	4 USB 3.0 ports 1 USB 2.0 port 2 Gb LAN ports 2 Audio (Mic-in, Line-out) jacks 1 SIM card slot 1 Power button 1 Remote Power On/Off connector	4 USB 3.0 ports 1 DisplayPort 2 Gb LAN ports 2 Audio (Mic-in, Line-out) jacks 2 SIM card slot 1 Power button
Expansion Options	1 Cincoze CMI module slot 1 Cincoze CFM module slot 2 Mini-PCIe full height slots (1 colay with mSATA)	2 Cincoze CMI module slots 2 Cincoze CFM module slots 2 Mini-PCIe full height slots (1 colay with mSATA)
LAN Controller	2 Intel I210-AT GbE	2 Intel I210-AT GbE
Input Voltage	9 ~ 48 V	9 ~ 48 V
Power Input	3-pin terminal block DC connector	3-pin terminal block DC connector
Operating Temp. Range	-40 ~ 85°C	-40 ~ 85°C
Dimensions (WxHxD)	150 x 56 x 105 mm	185 x 54.5 x 131 mm
Mounting Options	Wall Mount (kit included), Side Mount, DIN Mount, VESA Mount	Wall Mount (kit included), Side Mount, DIN Mount, VESA Mount
Regulatory Information	2011/65/EU (RoHS 2 Directive), CE, EN 55022, EN 55024, FCC 47 CFR Part 15	2011/65/EU (RoHS 2 Directive), CE, EN 55022, EN 55024, FCC 47 CFR Part 15



DI-1000



DX-1000



DS-1200

DI Series	DX Series	DS Series
Intel i3-6100U Intel i5-6300U Intel i7-6600U	Intel Celeron Intel Pentium Intel Core™ i3/i5/i7 Intel Xeon® E3	Intel Celeron Intel Pentium Intel Core i3/i5/i7
2.3 ~ 3.4 GHz	2.30 ~ 4.20 GHz	2.10 ~ 4.60 GHz
Skylake	Skylake Kaby Lake	Coffee Lake
2 Cores / 4 Threads	2 ~ 4 Cores / 2 ~ 8 Threads	2 ~ 6 Cores / 2 ~ 12 Threads
Intel HD Graphics 520	Intel HD Graphics 510/530 Intel HD Graphics 610/630	Intel UHD Graphics 610 Intel UHD Graphics 630
DDR4-2133 SO-DIMM (non-ECC) Up to 16 GB	DDR4-2133 SO-DIMM (non-ECC) DDR4-2400 SO-DIMM (non-ECC) Up to 32 GB	DDR4-2400 SO-DIMM (non-ECC) DDR4-2666 SO-DIMM (non-ECC) Up to 32 GB
2 SATA III mSATA SSD (colay with Mini-PCIe) 1 SATA III 2.5" HDD/SDD 1 SATA III 2.5" Hot-swap HDD/SSD	4 SATA III mSATA SSD (colay with Mini-PCIe) 2 SATA III 2.5" Hot-swap HDD/SSD	1 NVMe M.2 2280 SSD 3 SATA III mSATA SSD (colay with Mini-PCIe) 1 SATA III 2.5" HDD/SDD 1 SATA III 2.5" Hot-swap HDD/SSD
4 USB 3.0 ports 2 Gb LAN ports 1 DisplayPort 1 DVI-I port 2 COM (RS-232/422/485) ports 1 PS/2 port 8 Optical Isolated DIO (4 in, 4 out)	4 USB 3.0 ports 2 Gb LAN ports 1 DisplayPort 1 DVI-I port 4 COM (RS-232/422/485) ports 2 Audio (Mic-in, Line-out) jacks 1 External Fan connector 1 Remote Power On/Off connector	4 USB 3.1 ports 2 USB 2.0 ports 2 Gb LAN ports 1 DisplayPort 1 DVI-I port 2 COM (RS-232/422/485) ports 1 PS/2 port 2 Audio (Mic-in, Line-out) jacks 1 External Fan connector 1 Remote Power On/Off connector 1 Remote Power Reset connector
2 USB 2.0 ports 4 COM (RS-232/422/485) ports 2 Audio (Mic-in, Line-out) jacks 1 SIM card slot 1 Power button 1 Remote Power On/Off connector	4 USB 3.0 ports 1 DisplayPort 1 SIM card slot 1 Power button	2 USB 3.1 ports 1 DisplayPort 2 SIM card slots 1 Power button
1 Cincoze CMI module slot 1 Cincoze CFM module slot 2 Mini-PCIe full height slots (colay with mSATA)	3 Cincoze CMI module slots 2 Cincoze CFM module slot 4 Mini-PCIe full height slots (colay with mSATA)	4 Cincoze CMI module slots 1 Cincoze CFM module slot 3 Mini-PCIe full height slots (colay with mSATA) 1 PCIe x1, 2 PCIe x8, 1 PCIe x16, 2 PCI
1 Intel I219-LM GbE 1 Intel I210-AT GbE	1 Intel I219-LM GbE 1 Intel I210-AT GbE	Intel I219-LM GbE Intel I210-AT GbE
9 ~ 48 V	9 ~ 48 V	9 ~ 48 V
3-pin terminal block DC connector	3-pin terminal block DC connector	3-pin terminal block DC connector
-40 ~ 70°C	-40 ~ 70°C	-20 ~ 70°C
203 x 66.8 x 142 mm	242 x 77 x 174 mm	DS-1200: 227 x 86 x 261 mm DS-1201: 227 x 106 x 261 mm DS-1202: 227 x 126 x 261 mm
Wall Mount (kit included), Side Mount, DIN Mount, VESA Mount	Wall Mount (kit included), Side Mount, DIN Mount, VESA Mount	Wall Mount (kit included)
2011/65/EU (RoHS 2 Directive), CE, E-Mark EN 50121-3-2, EN 50155, EN 55024, EN 55032, FCC 47 CFR Part 15	CE, E-Mark, EN 45545-2, EN 50121-3-2, EN 50155, EN 60950-1, FCC 47 CFR Part 15	2011/65/EU (RoHS 2 Directive), CE, EN 55022, EN 55024, FCC 47 CFR Part 15



Specifications

POC-300

POC-351VTC

Nuvo-6108GC

Series	POC Series		Nuvo-6000 Series
Processor	Intel Atom® x7-E3950 Intel® Pentium® N4200	Intel Atom x7-E3950	Intel Celeron® Intel Pentium Intel Core™ i3/i5/i7 Intel Xeon® E3
Processor Speed	1.10 ~ 2.50 GHz	1.60 ~ 2.00 GHz	2.30 ~ 4.00 GHz
Processor Generation	Apollo Lake		Skylake
Processor Cores / Threads	4 Cores / 4 Threads		2 ~ 4 Cores / 2 ~ 8 Threads
Graphics / GPU	Intel HD Graphics 505		Intel HD Graphics 510 Intel HD Graphics 530
Memory	DDR3L-1866 SO-DIMM (non-ECC) Up to 8 GB		DDR4-2133 SO-DIMM (ECC) DDR4-2133 SO-DIMM (non-ECC) Up to 32 GB
Storage Options	1 SATA III mSATA half height SSD 1 SATA III 2.5" HDD/SDD (with MezIO-R11)	1 SATA III mSATA half height SSD 1 SATA III mSATA full height SSD	4 SATA III 2.5" HDD/SDD
Rear I/O	2 COM (RS-232/422/485) ports 2 Audio (Mic-in, Line-out) jacks	2 COM (RS-232/422/485) ports 2 Audio (Mic-in, Line-out) jacks 1 CANbus port 8 Optical Isolated DIO (4 in, 4 out)	-
Front I/O	2 USB 3.0 ports 2 USB 2.0 ports 3 Gb LAN ports (2 PoE optional) 1 DVI-I port 1 Power button 1 Reset button	2 USB 3.0 ports 2 USB 2.0 ports 1 Gb LAN port 2 Gb PoE LAN ports 1 DVI-I port 1 Power button 1 Reset button	4 USB 3.0 ports 2 Gb LAN port 2 DVI-D port 2 COM (RS-232/422/485) ports 2 Audio (Mic-in, Line-out) jacks 1 Power button 1 Reset button 1 Remote Power On/Off connector
Expansion Options	1 Neosys MezIO expansion slot 1 Mini-PCIe full height slot 1 Additional Mini-PCIe full height slot (with MezIO-V20)	1 M.2 2242 (key B) slot 3 Mini-PCIe full height slot	1 M.2 2242 (key B) slot 1 Mini-PCIe full height slot 2 PCIe x8 (4-lanes PCIe signals) 1 PCIe x16 (16-lanes PCIe signals)
LAN Controller	3 Intel I210-IT GbE		1 Intel I219-LM GbE 1 Intel I210-IT GbE
Input Voltage	8 - 35 V		24 V
Power Input	3-pin terminal block DC connector		3-pin terminal block DC connector
Operating Temp. Range	-25 ~ 70°C		-25 ~ 60°C
Dimensions (WxHxD)	56 x 108 x 153 mm		164 x 174 x 360 mm
Mounting Options	DIN Mount (included), Wall Mount	Horizontal Wall Mount (kit included), Vertical Wall Mount, DIN Mount	Wall Mount (with damping bracket)
Regulatory Information	2011/65/EU (RoHS 2 Directive), CE, EN 55022, EN 55024, EN 55032, FCC 47 CFR Part 15	2011/65/EU (RoHS 2 Directive), CE, E-Mark, EN 50155, EN 55022, EN 55024, FCC 47 CFR Part 15	2011/65/EU (RoHS 2 Directive), CE, EN 55022, EN 55024, FCC 47 CFR Part 15



Nuvo-7000LP



Nuvo-7000E/DE



Nuvo-7160GC



Nuvo-7100VTC

Nuvo-7000 Series			
Intel Celeron Intel Pentium Intel Core i3/i5/i7			
2.10 ~ 4.60 GHz			
Coffee Lake			
2 ~ 6 Cores / 2 ~ 12 Threads			
Intel UHD Graphics 610 Intel UHD Graphics 630			
DDR4-2400 SO-DIMM (non-ECC) DDR4-2666 SO-DIMM (non-ECC) Up to 32 GB			
1 NVMe M.2 2280 SSD 1 SATA III mSATA SSD (colay with Mini-PCIe) 1 SATA III 2.5" HDD/SDD 1 SATA III 2.5" Hot-swap HDD/SSD	1 NVMe M.2 2280 SSD 1 SATA III mSATA SSD (colay with Mini-PCIe) 2 SATA III 2.5" HDD/SDD		1 NVMe M.2 2280 SSD 1 SATA III mSATA SSD (colay with Mini-PCIe) 1 SATA III 2.5" HDD/SDD 1 SATA III 2.5" Hot-swap HDD/SSD
2 COM (RS-232/422/485) ports 2 COM (RS-232) ports 1 Audio (Mic-in, Line-out) jack 1 Remote Power On/Off connector		2 COM (RS-232/422/485) ports 2 COM (RS-232) ports 1 CANbus port 8 Optical Isolated DIO (4 in, 4 out) 1 Audio (Mic-in, Line-out) jack 1 Remote Power On/Off connector	
4 USB 3.1 Gen 1 ports 4 USB 3.1 Gen 2 ports 2 Gb LAN ports (6 optional) 1 DisplayPort 1 DVI-D port 1 VGA port 2 SIM card slots 1 Power button 1 Reset button			
1 Neosys MezIO expansion slot 1 M.2 2280 (key M) slot 1 Mini-PCIe full height slots (colay with mSATA)	1 Neosys MezIO expansion slot 1 M.2 2280 (key M) slot 1 Mini-PCIe full height slots (colay with mSATA) 1 PCIe x16 (8-lanes PCIe signals) or 2 PCIe x8 (4-lanes PCIe signals)	1 Neosys MezIO expansion slot 1 M.2 2280 (key M) slot 1 Mini-PCIe full height slots (colay with mSATA) 1 PCIe x16 (16-lanes PCIe signals with 120W GPU support)	1 M.2 2280 (key M) slot 1 Mini-PCIe full height slots (colay with mSATA) 2 Mini-PCIe full height slots (USB signals only)
1 Intel I219-LM GbE 2 Intel I210-IT GbE (4 additional optional)			
8 ~ 35 V			
3-pin terminal block DC connector			
-25 ~ 70°C		-25 ~ 60°C	
240 x 79 x 225 mm	7000E: 240 x 90 x 225 mm 7000DE: 240 x 110.5 x 225 mm	240 x 111 x 225 mm	240 x 79 x 225 mm
Wall Mount (kit included), DIN Mount			
2011/65/EU (RoHS 2 Directive), CE, EN 55024, EN 55032, FCC 47 CFR Part 15			2011/65/EU (RoHS 2 Directive), CE, EN 55022, EN 55024, FCC 47 CFR Part 15



FISHING SMARTER

with remote catch monitoring.

Integrated Monitoring turned to Logic Supply for rugged computers to power their fisheries' monitoring technology to streamline regulatory compliance, improve worker safety, and keep fishing crews connected with their families on shore.





RACKMOUNT LINE

Easy to integrate 1U, 1.5U and 2U rackmount computers.
Energy efficient and ideal for networking, servers or data acquisition.

High Performance Rackmount Computing



Easy To Integrate

With 1U, 1.5U and 2U options, our rackmount systems bring Logic Supply hardware reliability to your existing rack-based IT infrastructure.



Highly Configurable

Our rackmount computers are powered by a range of efficient Intel® processors, offering impressive performance even under heavy computing loads.











Rackmount Your Fanless PC

The MK020 Series lets you add fanless PC reliability to your rackmount installation, with space for up to two solid state fanless computers in each 2U adapter.

Logic Supply Rackmount Computers

Customizable Computing That's Easy To Integrate

	 <p>MK100 Series 1U Rackmounts 2 Models</p>	 <p>MK150 Series 1.5U Rackmounts 1 Model</p>	 <p>MK020 Series Fanless Rackmounts 2 Models</p>
Features	 1U Rackmount Form Factor	 1.5U Rackmount Form Factor	 2U Rackmount Form Factor
	 Actively Cooled	 Actively Cooled	 Fanless
Processor Options	 Celeron® Pentium® Core™ i3	 Celeron Pentium Core i3	 Celeron Pentium Core i3
	 Core i5 Core i7 Xeon®	 Core i5 Core i7 Xeon	 Core i5 Core i7 Xeon
Memory	Up to 32 GB	Up to 64 GB	Up to 16 GB
Connectivity	4G or Wi-Fi and Bluetooth	4G or Wi-Fi and Bluetooth	Wi-Fi and Bluetooth

[Learn more on p61 >](#)

[See detailed specs on p63 >](#)

[Learn more on p61 >](#)

[See detailed specs on p64 >](#)

[Learn more on p62 >](#)

[See detailed specs on p64 >](#)

MK100 & MK150 Series

Server Grade Connectivity

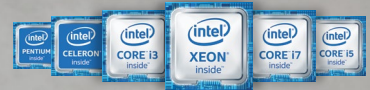

Models [See detailed specs on p63-64 >](#)



MK100B-51



- Up to Intel® Core i7
- 2 COM, Gb LAN, DisplayPort, HDMI
- PCIe x16 expansion



MK100B-52



- Intel Xeon E3-1585v5 processor
- 4 GbE, 1 IPMI port
- Up to 64GB of memory



MK150B-52



- Intel Skylake processing
- Up to 32GB of DDR4 RAM
- PCIe x16 expansion, dual Gb LAN

Build Yours Online: www.logicsupply.com/commercial-rackmounts/

Dimensional Drawings

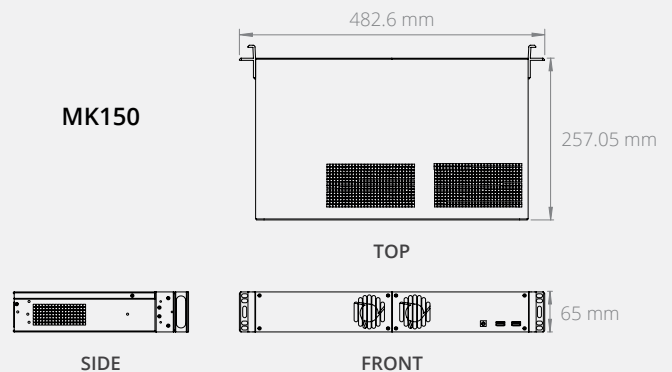
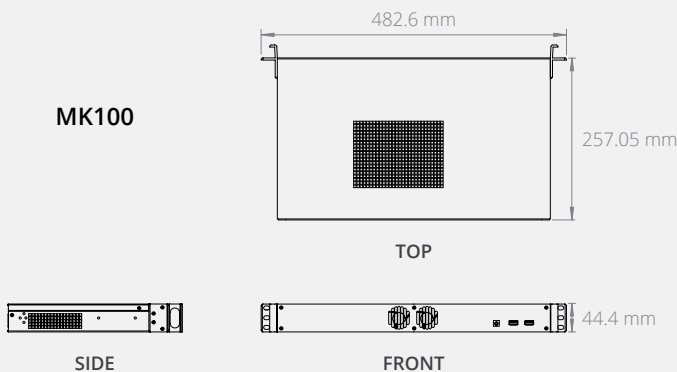



MK020 Series

Reliable Fanless Rackmounts



Models [See detailed specs on p64 >](#)



MK020-10

- Celeron
- Pentium
- Core i3
- Core i5
- Core i7

- Intel N3150 Celeron processor
- 4 USB 3.0, 2 Gb LAN, HDMI, DisplayPort
- Optional 3 COM ports



MK020-50

- Celeron
- Pentium
- Core i3
- Core i5
- Core i7

- Up to Intel Core i3
- 4 USB, 3 COM, dual Gb LAN
- Optional TPM

Build Yours Online: www.logicsupply.com/fanless-rackmounts/

Dimensional Drawings

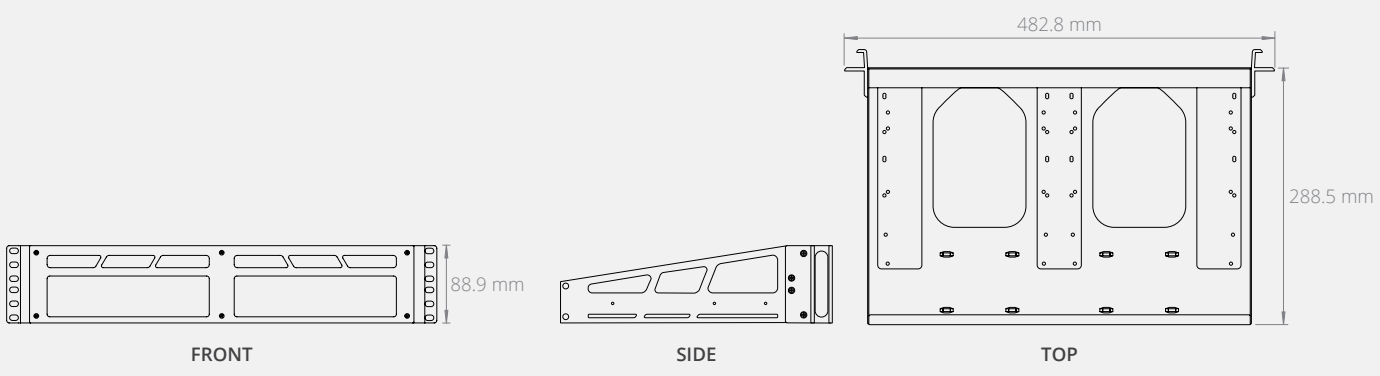



Specifications

MK100B-51

MK100B-52

Series	MK100 Series	
Processor	Intel® Celeron® Intel Pentium® Intel Core™ i3/i5/i7	Intel Xeon® E3-1585 v5
Processor Speed	2.30 ~ 3.80 GHz	3.50 ~ 3.90 GHz
Processor Generation	Skylake Kaby Lake	Skylake
Processor Cores / Threads	2 ~ 4 Cores / 2 ~ 8 Threads	4 Cores / 8 Threads
Graphics / GPU	Intel HD Graphics 510/530 Intel HD Graphics 610/630	Intel Iris Pro Graphics P580
Memory	DDR4-2133 SO-DIMM (non-ECC) Up to 32 GB	DDR4-2133 SO-DIMM (ECC) DDR4-2133 SO-DIMM (non-ECC) Up to 64 GB
Storage Options	1 SATA III mSATA SSD 2 SATA III 2.5" HDD/SSD	2 SATA III 2.5" HDD/SSD
Rear I/O	1 HDMI port 1 DisplayPort 1 VGA port 2 Gb LAN ports 4 USB 3.0 ports 1 COM (RS-232/422/485) port 1 COM (RS-232) port 2 Audio (Mic-in, Line-out) jacks	2 USB 3.0 ports 1 HDMI port 4 Gb LAN ports 1 RJ45 IPMI port 1 UID switch/LED
Front I/O	2 USB 2.0 ports 1 Power Button	2 USB 2.0 ports 1 Power Button
Expansion Options	1 Mini-PCIe full/half height slot 1 PCIe x16 slot	1 M.2 NGFF 2242 slot 1 PCIe x16 slot
LAN Controller	1 Intel I210 GbE 1 Intel I219-V GbE	4 Intel I350-AM4 LAN1 supports NCSI
Operating Temp. Range	0 ~ 50°C	10 ~ 35°C
Dimensions (WxHxD)	482.6 x 44.4 x 257.05 mm	
Mounting Options	Rackmount	
Regulatory Information	2011/65/EU (RoHS 2 Directive) CE EN 55022 EN 55024 EN 55032 EN 60950-1 FCC 47 CFR Part 15	2002/96/EC (WEEE Directive) 2011/65/EU (RoHS 2 Directive) EN 60950-1 EN 62368-1 FCC 47 CFR Part 15 CE EN 55024 EN 55032



MK150B-52



MK020-10



MK020-50

MK150 Series	MK020 Series	
Intel Celeron Intel Pentium Intel Core i3/i5/i7	Intel Celeron	Intel Celeron Intel Pentium Intel Core i3
2.30 ~ 4.20 GHz	1.60 ~ 2.24 GHz	2.20 ~ 2.40 GHz
Skylake Kaby Lake	Braswell	Haswell
2 ~ 4 Cores / 2 ~ 8 Threads	4 Cores / 4 Threads	2 Cores / 2 ~ 4 Threads
Intel HD Graphics 510/530 Intel HD Graphics 610/630	Intel HD Graphics	Intel HD Graphics Intel HD Graphics 4600
DDR4-2133 SO-DIMM (non-ECC) Up to 32 GB	DDR3L-1600 SO-DIMM (non-ECC) Up to 8 GB	DDR3L-1600 SO-DIMM (non-ECC) Up to 16 GB
1 SATA III mSATA SSD 2 SATA III 2.5" HDD/SSD	mSATA	
1 HDMI port 1 DisplayPort 1 VGA port 2 Gb LAN ports 4 USB 3.0 ports 1 COM (RS-232/422/485) port 1 COM (RS-232) port 2 Audio (Mic-in, Line-out) jacks	4 USB 3.0 ports 2 Gb LAN ports 1 VGA port 1 HDMI port 2 Audio (Mic-in, Line-out) jacks	1 HDMI port 1 DisplayPort 1 DVI-I port 4 USB 3.0 ports 2 Gb LAN ports 3 COM (RS-232/422/485) ports 2 Audio (Mic-in, Line-out) jacks
2 USB 2.0 ports 1 Power Button	2 USB 2.0 ports 1 Power Button	2 USB 2.0 ports 1 Power Button
1 Mini-PCIe full/half height slot 1 PCIe x16 slot	1 Mini-PCIe full/half height slot 1 COM (RS-232/422/485) port 2 COM (RS-232) ports	-
1 Intel I210 GbE 1 Intel I219-V GbE	2 Realtek RTL8111G GbE	1 Intel I210 GbE 1 Intel I217-LM GbE
0 ~ 50°C	0°C ~ 55°C	0°C ~ 45°C
482.6 x 65 x 257.05 mm	482.6 x 88.9 x 288.5 mm	
Rackmount	Rackmount	
2002/96/EC (WEEE Directive) 2011/65/EU (RoHS 2 Directive) EN 60950-1 EN 62368-1 FCC 47 CFR Part 15 CE EN 55024 EN 55032	2011/65/EU (RoHS 2 Directive) CE EN 55022 EN 55024 EN 55032 EN 60950-1 FCC 47 CFR Part 15	



SPOTLIGHT: SAN DIEGO ASTRONOMY ASSOCIATION

OBSERVING THE UNIVERSE

from the middle of the desert.

The San Diego Astronomy Association is using Logic Supply's ML600 system in their fully robotic, remote controlled observatories to monitor a range of celestial bodies from remote installations in Tierra Del Sol, California, where temperatures bounce between 20°F and 100°F.





PANEL PC LINE

Industrial touchscreens for kiosk, POS and HMI applications. Unique modular design and an IP65 rated front bezel create a flexible, durable all-in-one solution.

Designed For Durability



Functional Beauty

Our line of Panel PCs combine a flush bezel for easy cleaning, top of the line brightness and resolution capabilities, IP65 rated protection and a range of customization options.



Unique Modularity

Interchangeable PCs and displays allow for easy upgrades and maintenance without the need to replace the entire system. Choose from a range of display sizes and PC modules to create your ideal all-in-one solution.













No Fan? No Problem

With their fanless design, our Panel PCs help to minimize the downtime and damage caused by dust and airborne debris, creating a durable, long-lasting Panel PC solution.

Panel PCs From Cincoze

Modular, All-In-One Touchscreens

Panels	 <p>CV-100 Series Industrial Displays 7 Models</p>	 <p>Resistive or Projected Capacitive touchscreen</p>
	 <p>CS-100 Series Industrial Sunlight-Readable Displays 5 Models</p>	 <p>Projected Capacitive touchscreen</p>  <p>Sunlight Readable</p>
Modules	 <p>P1101 Series Industrial Apollo Lake Module 1 Model</p>	 <p>Power Efficient</p>  <p>2 LAN, 2 COM, DIO</p>
	 <p>P2002 Series Industrial Skylake Module 1 Model</p>	 <p>High Performance</p>  <p>2 LAN, 6 COM, DIO</p>

[See detailed specs on p69 >](#)

Build Your Perfect Panel PC



1. Select Your Display
2. Select Your PC Module



Industrial Displays

- From 8.4" to 21.5"

4G Capable

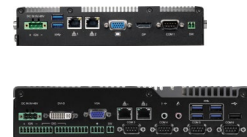

Industrial PC Modules

- P1101: Intel® Atom® or Pentium®
- P2002: Intel Core™ i5



Specifications

CV-100 Displays

CS-100 Displays

Series	CV-100 Series	CS-100 Series
Touchscreen Type	CV-108: 5-wire Resistive CV-110 - CV-W121: 5-wire Resistive or Capacitive	CS-110 - CS-119: Capacitive
Display Size	CV-108: 8.4" CV-110: 10.4" CV-112H: 12.1" CV-115: 15" CV-117: 17" CV-119: 19" CV-W121: 21.5"	CS-110: 10.4" CS-112H: 12.1" CS-115: 15" CS-117: 17" CS-119: 19"
Display Resolution / Aspect Ratio	CV-108 & CV-110: 800 x 600 / 4:3 CV-112H: 1024 x 768 / 4:3 CV-115: 1024 x 768 / 4:3 CV-117 & CV-119: 1280 x 1024 / 5:4 CV-W121: 1920 x 1080 / 16:9	CS-110, CS-112H, CS-115: 1024 x 768 / 4:3 CS-117 & CS-119: 1280 x 1024 / 5:4
Display Brightness	CV-108 & CV-110: 400 cd/m ² CV-112H: 500 cd/m ² CV-115, CV-117, CV-119: 350 cd/m ² CV-W121: 300 cd/m ²	CS-110 & CS-112H: 1500 cd/m ² CS-115: 1600 cd/m ² CS-117: 1500 cd/m ² CS-119: 1600 cd/m ²
Contrast Ratio	CV-108: 600:1 CV-110 & CV-112H: 700:1 CV-115 & CV-117: 800:1 CV-119: 1000:1 CV-W121: 5000:1	CS-110: 1400 : 1 CS-112H: 700 : 1 CS-115 & CS-117: 800 : 1 CS-119: 1000 : 1
Viewing Angle (L/R:T/B)	CV-108: 150 / 130 CV-110: 160 / 130 CV-112H & CV-115: 160 / 160 CV-117 & CV-119: 170 / 160 CV-W121: 178 / 178	CS-110: 178 / 178 CS-112H & CS-115: 160 / 160 CS-117: 160 / 140 CS-119: 170 / 160
Operating Temp. Range	CV-108: -20°C ~ 70°C CV-110 & CV-112H: -20°C ~ 75°C CV-115: 0°C to 60°C CV-117: -20°C ~ 75°C CV-119: 0°C to 50°C CV-W121: 0°C to 60°C	CS-110, CS-112H, CS-115, CS-117, CS-119: -20°C ~ 70°C
Dimensions (WxHxD)	CV-108: 262 x 186 x 65 mm CV-110: 295 x 227.3 x 65 mm CV-112H: 345 x 265.3 x 66.5 mm CV-115: 408 x 312.4 x 68 mm CV-117: 450 x 350 x 72 mm CV-119: 510 x 389.3 x 72 mm CV-W121: 550 x 331.8 x 88 mm	CS-110: 295 x 227.3 x 65 mm CS-112H: 345 x 265.3 x 82 mm CS-115: 408 x 312.4 x 84.5 mm CS-117: 450 x 350 x 88.5 mm CS-119: 510 x 389.3 x 88.5 mm
Mounting Options	VESA Mount, Panel Mount	VESA Mount, Panel Mount
Regulatory Information	CE, FCC Class A	CE, FCC Class A



Specifications

P1101

P2002/E

Series	Modules	
Processor	Intel Atom® x7-E3950 Intel® Pentium® N4200	Intel i5-6300U
Processor Speed	1.10 ~ 2.50 GHz	2.40 ~ 3.0 GHz
Processor Generation	Apollo Lake	Skylake
Processor Cores / Threads	4 Cores / 4 Threads	2 Cores / 4 Threads
Graphics / GPU	Intel HD Graphics 505	Intel HD Graphics 520
Memory	DDR3L-1866 SO-DIMM (non-ECC) Up to 8 GB	DDR4-2133 SO-DIMM (non-ECC) Up to 32 GB
Storage Options	1 SATA III mSATA SSD (colay with Mini-PCIe) 1 SATA III 2.5" HDD/SDD	2 SATA III mSATA SSD (1 colay with Mini-PCIe) 2 SATA III 2.5" HDD/SDD 1 CFast SSD
I/O	4 USB 3.0 ports 1 DisplayPort 1 VGA port 4 COM (RS-232/422/485) ports 8 Optical Isolated DIO (4 in, 4 out) 2 Gb LAN ports 2 Audio (Mic-in, Line-out) jacks 1 SIM card slot 1 LCD On/Off button 2 LCD brightness buttons 1 Reset button 1 Power button 1 Remote Power On/Off connector	4 USB 3.0 ports 1 USB 2.0 port 1 DVI-D port 1 VGA port 6 COM (RS-232/422/485) ports 16 Optical Isolated DIO (4 in, 4 out) 2 Gb LAN ports (PoE optional) 2 Audio (Mic-in, Line-out) jacks 1 SIM card slot 1 LCD On/Off button 2 LCD brightness buttons 1 Reset button 1 Power button 1 Remote Power On/Off connector
Expansion Options	2 Cincoze CFM module slots 2 mPCIe sockets (full-size)	2 Cincoze CFM module slots 2 Mini-PCIe full height slots (1 colay with mSATA)
LAN Controller	2 Intel I210-AT GbE	1 Intel I219-LM GbE 1 Intel I210-AT GbE
Input Voltage	9 ~ 48 V	
Power Input	3-pin terminal block DC connector	
Operating Temp. Range	-40°C ~ 75°C (without panel)	-25°C to 70°C (without panel)
Dimensions (WxHxD)	204.5 x 41.5 x 149 mm	254.5 x 54 x 220 mm
Mounting Options	Wall Mount DIN Mount VESA Mount Panel Mount	Wall Mount VESA Mount Panel Mount
Regulatory Information	CE, FCC Class A	

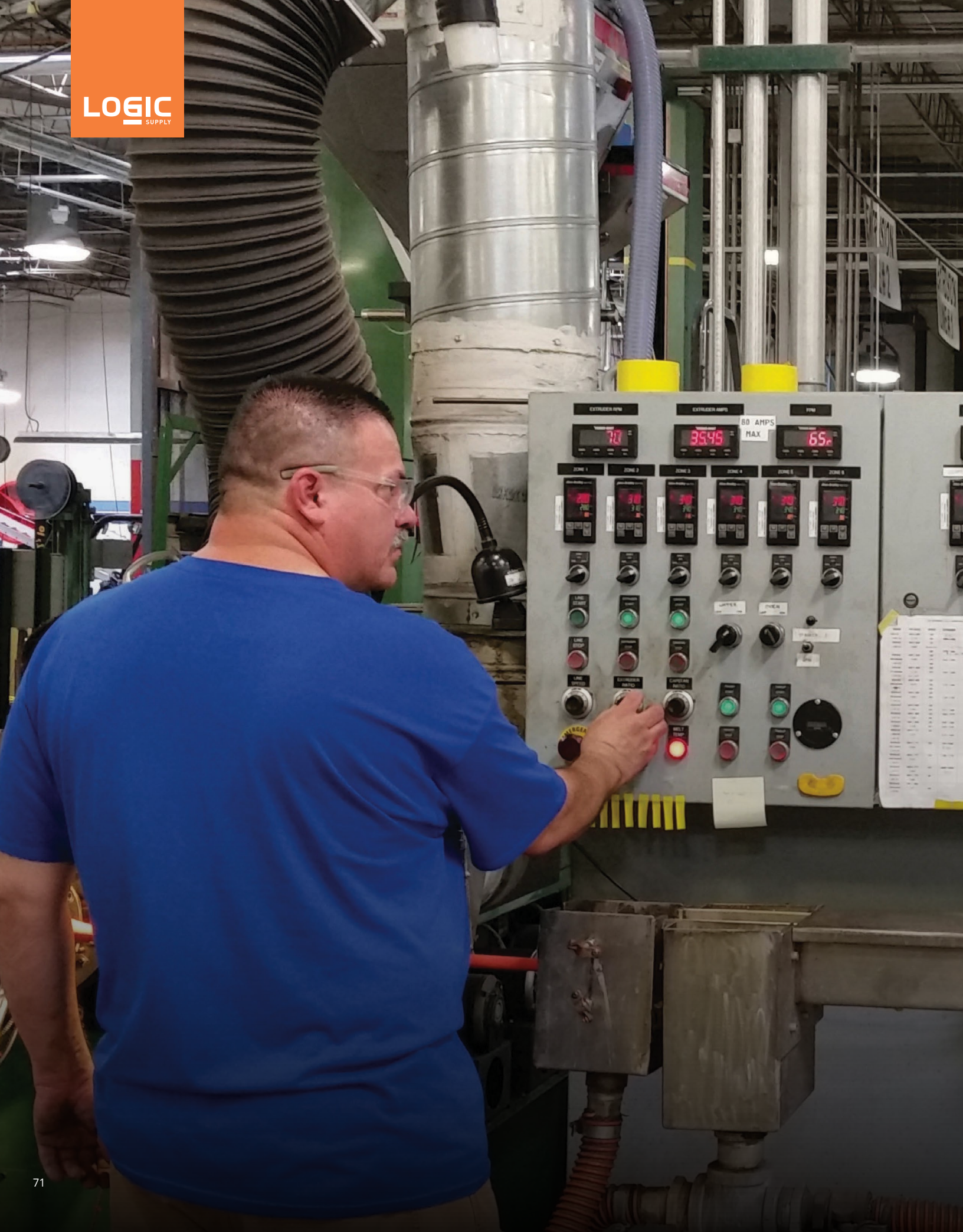



Cure	0.5769	Name	Cold
Hot	0.6627	Nominal:	0.6690
Cold	0.6651	Average	0.6707
Wall	0.0443	Maximum	0.6768
		Minimum	0.6632
		PpK	2.52
		Samples	198137



SPOTLIGHT: CHAMPLAIN CABLE

PREVENTING DOWNTIME

with Hardshell™ Fanless Technology.

Champlain Cable uses the Logic Supply ML500 on their wire and cable manufacturing floor to minimize line downtime and optimize production. Even with considerable airborne debris, and challenging workloads, they know they can depend on Logic.

LOGIC
SUPPLY



Contact Us

North America

Phone +1 802 861 2300
Email info@logicsupply.com
Website www.logicsupply.com

Europe

Phone +31 88 5200 700
Email info.eu@logicsupply.com
Website www.logicsupply.com

Asia

Phone +886 2 8227 9151
Email info.tw@logicsupply.com
Website www.logicsupply.com



Logic Supply
North America
35 Thompson Street
South Burlington, VT 05403
+1 802 861 2300 | info@logicsupply.com

Logic Supply
Europe
De Boedingen 37
Oosterhout, Nederland
+31 88 5200 700 | info.eu@logicsupply.com



Reliable Computers, Accessible Expertise

www.logicsupply.com