

AWK-5232-M12-RCC User's Manual

Edition 4.0, September 2017

www.moxa.com/product



© 2017 Moxa Inc. All rights reserved.

AWK-5232-M12-RCC User's Manual

The software described in this manual is furnished under a license agreement and may be used only in accordance with the terms of that agreement.

Copyright Notice

© 2017 Moxa Inc. All rights reserved.

Trademarks

The MOXA logo is a registered trademark of Moxa Inc.
All other trademarks or registered marks in this manual belong to their respective manufacturers.

Disclaimer

Information in this document is subject to change without notice and does not represent a commitment on the part of Moxa.

Moxa provides this document as is, without warranty of any kind, either expressed or implied, including, but not limited to, its particular purpose. Moxa reserves the right to make improvements and/or changes to this manual, or to the products and/or the programs described in this manual, at any time.

Information provided in this manual is intended to be accurate and reliable. However, Moxa assumes no responsibility for its use, or for any infringements on the rights of third parties that may result from its use.

This product might include unintentional technical or typographical errors. Changes are periodically made to the information herein to correct such errors, and these changes are incorporated into new editions of the publication.

Technical Support Contact Information

www.moxa.com/support

Moxa Americas

Toll-free: 1-888-669-2872
Tel: +1-714-528-6777
Fax: +1-714-528-6778

Moxa Europe

Tel: +49-89-3 70 03 99-0
Fax: +49-89-3 70 03 99-99

Moxa India

Tel: +91-80-4172-9088
Fax: +91-80-4132-1045

Moxa China (Shanghai office)

Toll-free: 800-820-5036
Tel: +86-21-5258-9955
Fax: +86-21-5258-5505

Moxa Asia-Pacific

Tel: +886-2-8919-1230
Fax: +886-2-8919-1231

Table of Contents

1. Introduction	1-1
Overview	1-2
Package Checklist	1-2
Product Features	1-2
Product Specifications	1-3
Functional Design	1-5
LED Indicators	1-5
Beeper	1-6
Reset Button	1-6
Relay (Digital Output)	1-7
Antennas	1-7
2. Getting Started	2-1
First-time Installation and Configuration	2-2
Communications Testing	2-3
Function Guide	2-5
3. Web Console Configuration	3-1
Configuration by Web Browser	3-2
Overview	3-3
Basic Settings	3-4
System Info Settings	3-4
Network Settings	3-5
Time Settings	3-6
Wireless Settings	3-7
Operation Mode	3-7
Basic Wireless Settings	3-9
No-Probe Response	3-11
WLAN Security Settings	3-14
Advanced Wireless Settings	3-22
WLAN Certification Settings (for EAP-TLS in Client or Slave mode only)	3-24
Extended Control Settings (AP mode only)	3-25
Advanced Settings	3-26
Using Virtual LAN	3-26
Configuring Virtual LAN	3-28
DHCP Server (for AP mode only)	3-29
Packet Filters	3-30
RSTP Settings (for Master, Slave, or ACC mode only)	3-32
SNMP Agent	3-34
Storm Protection	3-35
Link Fault Pass-Through (for Client/Slave mode only)	3-36
CCU Alive Time Settings	3-36
NAT/Port Forwarding	3-38
Auto Warning Settings	3-38
System Log	3-38
Syslog	3-39
E-mail	3-40
Relay	3-41
Trap	3-42
Status	3-44
Wireless Status	3-44
Associated Client List (for AP/Master/ACC modes only)	3-45
DHCP Client List (for AP mode only)	3-45
System Log	3-46
Relay Status	3-46
DI and Power Status	3-47
Maintenance	3-47
Console Settings	3-47
Ping	3-47
Firmware Upgrade	3-48
Config Import Export	3-48
Default Config Import	3-49
Load Factory Default	3-49
Password	3-50
Misc. Settings	3-50
Save Configuration	3-50
Restart	3-51
Logout	3-51
4. Software Installation/Configuration	4-1

Overview	4-2
AWK Search Utility.....	4-2
Installing AWK Search Utility	4-2
Configuring AWK Search Utility	4-5
5. Other Console Configurations.....	5-1
RS-232 Console Configuration (115200, None, 8, 1, VT100)	5-2
Configuration by Telnet and SSH Consoles.....	5-4
Configuration by Web Browser with HTTPS/SSL.....	5-5
Disabling Telnet and Browser Access.....	5-6
6. References	6-1
Beacon.....	6-2
DTIM.....	6-2
Fragment.....	6-2
RTS Threshold.....	6-2
STP and RSTP	6-2
The STP/RSTP Concept	6-2
Differences between RSTP and STP.....	6-3
7. Supporting Information	7-1
DoC (Declaration of Conformity).....	7-2
Federal Communication Commission Interference Statement	7-2
R&TTE Compliance Statement.....	7-2
Firmware Recovery	7-3
Technical Support Contact Information.....	7-4

Introduction

Moxa AirWorks AWK-5232-M12-RCC with dual-RF wireless capability allows wireless users to access network resources more reliably. The AWK-5232-M12-RCC is rated to operate at temperatures ranging from 0 to 60°C for standard models and -40 to 75°C for extended temperature models, and is rugged enough for any harsh industrial environment.

The following topics are covered in this chapter:

- ❑ **Overview**
- ❑ **Package Checklist**
- ❑ **Product Features**
- ❑ **Product Specifications**
- ❑ **Functional Design**
 - LED Indicators
 - Beeper
 - Reset Button
 - Relay (Digital Output)
 - Antennas

Overview

The AWK-5232-M12-RCC Industrial a/b/g/n Wireless AP/Bridge/Client is an ideal wireless solution for connecting mobile equipment connected over a TCP/IP network in hard-to-wire situations. The AWK-5232-M12-RCC provides faster throughput than standard 802.11g devices, and at temperatures ranging from 0 to 60°C for standard models or -40 to 75°C for wide temperature models, making the AWK-5232-M12-RCC series rugged enough for any industrial environment. With two independent RF modules, the AWK-5232-M12-RCC supports a greater variety of wireless configurations and applications while increasing the reliability of the entire wireless network. The AWK-5232-M12-RCC's two DC power inputs make the power supply more reliable, and it can be powered via PoE+ for easier deployment.

Package Checklist

Moxa's AWK-5232-M12-RCC is shipped with the following items. If any of these items is missing or damaged, please contact your customer service representative for assistance.

- AWK-5232-RCC wireless AP/bridge/client
- Cable holder with 1 screw
- plastic RJ45 protective caps for Console ports
- 1 plastic M12-female protective cap
- Quick installation guide (printed)
- Warranty card

NOTE The above items come with the AWK-5232-M12-RCC standard version. The package contents may vary in a customized version.

Product Features

- IEEE 802.11a/b/g/n compliant
- Three-in-one design (AP/Bridge/Client)
- Advanced wireless security:
 - 64-bit and 128-bit WEP/WPA/WPA2
 - SSID Hiding/IEEE 802.1X/RADIUS
 - Packet access control & filtering
- STP/RSTP support for redundancy of system networking
- Dedicated antenna selection
- Free firmware update for more advanced functions
- RS-232 console management
- 2DI+1DO for on-site monitoring and warning
- Operating temperature ranges from -40 to 75°C (-T model)
- Power input by redundant 24 VDC power inputs or IEEE802.3at Power over Ethernet Plus
- DIN-Rail or wall mounting ability
- IP30 protected high-strength metal housing

Product Specifications

WLAN Interface

Standards:

IEEE 802.11a/b/g/n for Wireless LAN
 IEEE 802.11i for Wireless Security
 IEEE 802.3 for 10BaseT
 IEEE 802.3u for 100BaseTX
 IEEE 802.3ab for 1000BaseT
 IEEE 802.3at for Power-over-Ethernet Plus
 IEEE 802.1D for Spanning Tree Protocol
 IEEE 802.1w for Rapid STP
 IEEE 802.1Q for VLAN

Spread Spectrum and Modulation (typical):

- DSSS with DBPSK, DQPSK, CCK
- OFDM with BPSK, QPSK, 16QAM, 64QAM
- 802.11b: CCK @ 11/5.5 Mbps, DQPSK @ 2 Mbps, DBPSK @ 11 Mbps
- 802.11a/g: 64QAM @ 54/48 Mbps, 16QAM @ 36/24 Mbps, QPSK @ 18/12 Mbps, BPSK @ 9/6 Mbps
- 802.11n: 64QAM @ 300 Mbps to BPSK @ 6.5 Mbps (multiple rates supported)

Operating Channels (central frequency):

US:

2.412 to 2.462 GHz (11 channels)
 5.18 to 5.24 GHz (4 channels)

EU:

2.412 to 2.472 GHz (13 channels)
 5.18 to 5.24 GHz (4 channels)

JP:

2.412 to 2.472 GHz (13 channels, OFDM)
 2.412 to 2.484 GHz (14 channels, DSSS)
 5.18 to 5.24 GHz (4 channels for W52)

Security:

- SSID broadcast enable/disable
- Firewall for MAC/IP/Protocol/Port-based filtering
- 64-bit and 128-bit WEP encryption, WPA /WPA2-Personal and Enterprise (IEEE 802.1X/RADIUS, TKIP and AES)

Transmission Rates:

802.11b: 1, 2, 5.5, 11 Mbps
 802.11a/g: 6, 9, 12, 18, 24, 36, 48, 54 Mbps
 802.11n: 6.5 to 300 Mbps (multiple rates supported)

TX Transmit Power:

802.11b:

1 to 11 Mbps: Typ. 18 dBm (± 1.5 dBm)

802.11g:

6 to 24 Mbps: Typ. 18 dBm (± 1.5 dBm)
 36 to 48 Mbps: Typ. 17 dBm (± 1.5 dBm)
 54 Mbps: Typ. 15 dBm (± 1.5 dBm)

802.11a:

6 to 24 Mbps: Typ. 17 dBm (± 1.5 dBm)
 36 to 48 Mbps: Typ. 16 dBm (± 1.5 dBm)
 54 Mbps: Typ. 14 dBm (± 1.5 dBm)

TX Transmit Power MIMO:

802.11a/n (20/40 MHz):

MCS15 20 MHz: Typ. 13 dBm (± 1.5 dBm)

MCS15 40 MHz: Typ. 12 dBm (± 1.5 dBm)

802.11g/n (20 MHz):

MCS15 20 MHz: Typ. 14 dBm (± 1.5 dBm)

RX Sensitivity:

802.11b:

-92 dBm @ 1 Mbps, -90 dBm @ 2 Mbps, -88 dBm @ 5.5 Mbps, -84 dBm @ 11 Mbps

802.11g:

-87 dBm @ 6 Mbps, -86 dBm @ 9 Mbps, -85 dBm @ 12 Mbps, -82 dBm @ 18 Mbps, -80 dBm @ 24 Mbps, -76 dBm @ 36 Mbps, -72 dBm @ 48 Mbps, -70 dBm @ 54 Mbps

802.11a:

-87 dBm @ 6 Mbps, -86 dBm @ 9 Mbps, -85 dBm @ 12 Mbps, -82 dBm @ 18 Mbps,

-80 dBm @ 24 Mbps, -76 dBm @ 36 Mbps, -72 dBm @ 48 Mbps, -70 dBm @ 54 Mbps

RX Sensitivity MIMO:

802.11a/n:

-68 dBm @ MCS15 40 MHz, -69 dBm @ MCS15 20 MHz,

-70 dBm @ MCS7 40 MHz, -71 dBm @ MCS7 20 MHz

802.11g/n:

-69 dBm @ MCS15 20 MHz, -71 dBm @ MCS7 20 MHz

Protocol Support

General Protocols: Proxy ARP, DNS, HTTP, HTTPS, IP, ICMP, SNMP, TCP, UDP, RADIUS, SNMP, PPPoE, DHCP

AP-only Protocols: ARP, BOOTP, DHCP, STP/RSTP (IEEE 802.1D/w)

Interface

Default Antennas*: 4 dual-band omni-directional antennas, 2 dBi, RP-SMA (male)

***Only available with the AWK-5232-M12-RCC model.**

Connector for External Antennas:

AWK-5232-M12-RCC: RP-SMA (female)

AWK-5232-M12-RCC-M12: QMA (female)

RJ45 Ports: 2, 10/100/1000BaseT(X), auto negotiation speed, F/H duplex mode, and auto MDI/MDI-X connection (AWK-5232-M12-RCC only)

M12 Ports: 2, 10/100/1000BaseT(X) auto negotiation speed, F/H duplex mode, and auto MDI/MDI-X connection (AWK-5232-M12-RCC-M12 only)

Console Port: RS-232 (RJ45-type)

LED Indicators: PWR1, PWR2, PoE+, FAULT, STATE, WLAN1, WLAN2, 100M, 1000M (TP Ports), LAN1, LAN2 (M12 Ports)

Alarm Contact (Digital Output): 1 relay output with current carrying capacity of 1 A @ 24 VDC

Digital Inputs: 2 electrically isolated inputs

- +13 to +30 V for state "1"
- +3 to -30 V for state "0"
- Max. input current: 8 mA

Physical Characteristics

Housing: Metal, IP30 protection

Weight: 1.2 Kg

Dimensions: 74.55 x 135 x 105 mm (2.94 x 5.31 x 4.13 in)

Installation: DIN-Rail mounting (standard), wall mounting (optional)

Environmental Limits**Operating Temperature:**

Standard Models: -25 to 60°C (-13 to 140°F)

Wide Temp. Models: -40 to 75°C (-40 to 167°F)

Storage Temperature: -40 to 85°C (-40 to 185°F)

Ambient Relative Humidity: 5% to 95% (non-condensing)

Power Requirements

Input Voltage: 12 to 48 VDC, redundant dual DC power inputs or 48 VDC Power-over-Ethernet Plus (IEEE 802.3at compliant)

***Compliant with EN 50155 on 24 VDC**

Connector: 10-pin removable terminal block

Power Consumption: 12 to 48 VDC, 1.5 A (max.)

Reverse Polarity Protection: Present

Standards and Certifications

Safety: UL 60950-1, EN 60950-1

EMC: EN 301 489-1/17, FCC Part 15 Subpart B, EN 55032/55024, IEC 61000-6-2/4

Radio: EN 300 328, EN 301 893

Rail Traffic: EN 50155, EN 50121-1/4

Note: Please check Moxa's website for the most up-to-date certification status.

Warranty

Warranty Period: 5 years

Details: See www.moxa.com/warranty



ATTENTION

The AWK-5232-M12-RCC is NOT a portable mobile device and should be located at least 20cm away from the human body. The AWK-5232-M12-RCC is NOT designed for the general public. To safely deploy the AWK-5232-M12-RCCs within a wireless network, a well-trained technician is required for installation.

Patent http://www.moxa.com/doc/operations/Moxa_Patent_Marking.pdf

Functional Design

LED Indicators

The LEDs on the front panel of the AWK-5232-M12-RCC allow you to quickly identify device status and wireless settings.

LED	Color	State	Description
Front Panel LED Indicators (System)			
PWR1	Green	On	Power is being supplied from power input 1
		Off	Power is not being supplied from power input 1
PWR2	Green	On	Power is being supplied from power input 2
		Off	Power is not being supplied from power input 2
PoE+	Amber	On	Power is being supplied via PoE+
		Off	Power is not being supplied via PoE+
FAULT	Red	On	Relay is event-triggered
		Blink (slow)	Cannot get an IP address from the DHCP server (interval: 1 sec)
		Blink (fast)	IP address conflict (interval: 0.5 sec)
		Off	Normal status
STATE	Green/Red	Green	Software Ready
		Blinking Green	The AWK has been located by AWK Search Utility(interval: 1 sec)
		Red	Booting or Error condition

LED	Color	State	Description
WLAN1	Green/Amber	Green On	WLAN1 is in Client/Slave/ACC mode
		Blinking Green	WLAN1's data communication is running in Client/Slave/ACC mode
		Amber On	WLAN1 is in AP/Master/ACC mode
		Blinking Amber	WLAN1's data communication is running in AP/Master/ACC mode
		Off	WLAN1 is not in use
WLAN2	Green/Amber	Green On	WLAN2 is in Client/Slave/ACC mode
		Blinking Green	WLAN2's data communication is running in Client/Slave/ACC mode
		Amber On	WLAN2 is in AP/Master/ACC mode
		Blinking Amber	WLAN2's data communication is running in AP/Master/ACC mode
		Off	WLAN2 is not in use
TP Port (LAN1, LAN2) LED Indicators (Port Interface)			
100M	Amber	On	TP port's 10/100 Mbps link is active
		Blinking	Data is being transmitted at 10/100 Mbps
		Off	TP port's 10/100 Mbps link is inactive
1000M	Green	On	TP port's 1000 Mbps link is active
		Blinking	Data is being transmitted at 1000 Mbps
		Off	TP port's 1000 Mbps link is inactive



ATTENTION

When the LEDs for **STATE** (Green), **FAULT**, **WLAN1** and **WLAN2** all light up simultaneously and blink at one-second intervals, it means the system has failed to boot. This may be due to improper operation or uncontrollable issues, such as an unexpected shutdown during a firmware update. To recover the firmware, refer to "Firmware Recovery" in Chapter 7.

Beeper

The beeper signals that the system is ready with two short beeps.

Reset Button

The **RESET** button is located on the top panel of the AWK-5232-M12-RCC. You can reboot the AWK-5232-M12-RCC or reset it to factory defaults by pressing the **RESET** button with a pointed object, like a straightened paper clip.

- **System reboot:** Hold the RESET button down for under 5 seconds and then release.
- **Reset to factory default:** Hold the RESET button down for over 5 seconds until the **STATE** LED starts blinking green. Release the button to reset the AWK-5232-M12-RCC.

RESET button

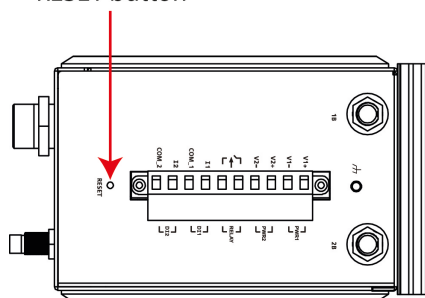

Relay (Digital Output)

The AWK-5232-M12-RCC has one relay output, which consists of the 2 terminal block contacts on the top panel, as shown below. These relay contacts are used to forward notifications of system failure and user-configured events.

The two wires attached to the relay contacts form an open circuit when a user-configured event is triggered. If a user-configured event does not occur, the relay circuit will remain closed. For safety reasons, the relay circuit is kept open when the AWK-5232-M12-RCC is not powered.

The AWK-5232-M12-RCC's relay status is summarized as follows:

Power Status	Event	Relay
Off	---	Open
On	Yes	Open
	No	Short

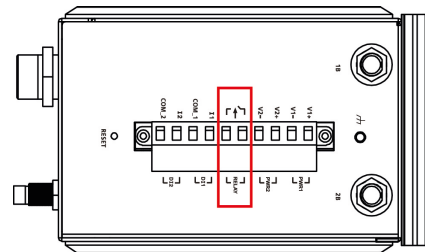

Antennas

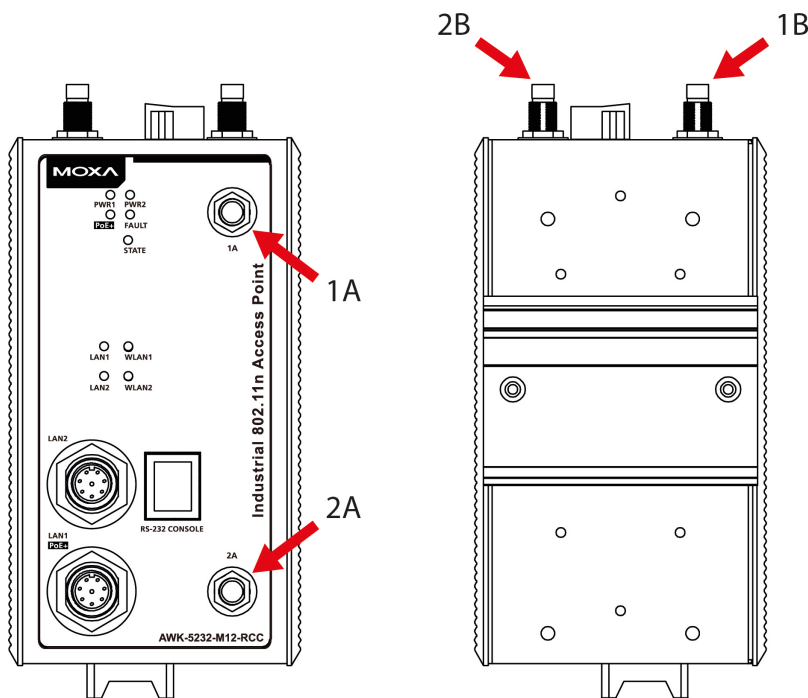

The AWK-5232-M12-RCC provides dual RF technology that meets the 802.11 a/b/g/n standards, giving full 2x2 MIMO. Antennas 1A and 1B are the MIMO antennas associated with RF1, and 2A and 2B are the MIMO antennas associated with RF2.

Getting Started

This chapter explains how to install Moxa's AirWorks AWK-5232-M12-RCC for the first time, to quickly set up your wireless network and test whether the connection is running well. With this function guide, you will gain access to the functions you need easily.

The following topics are covered in this chapter:

- ❑ **First-time Installation and Configuration**
- ❑ **Communications Testing**
- ❑ **Function Guide**

First-time Installation and Configuration

Before installing the AWK-5232-M12-RCC, make sure that all items in the Package Checklist are in the box. In addition, you will need access to a notebook computer or PC equipped with an Ethernet port. The AWK-5232-M12-RCC has a default IP address that you must use when connecting to the device for the first time.

Step 1: Select the power source.

The AWK-5232-M12-RCC can be powered by DC power input or PoE+ (Power over Ethernet Plus). The AWK-5232-M12-RCC will use whichever power source you choose.



ATTENTION

Do NOT use either an IEEE802.3af PoE Injector NOR a PSE (Power Sourcing Equipment). Use only an IEEE802.3at compliant PSE for PoE+ (Power over Ethernet Plus) device.

Step 2: Connect the AWK-5232-M12-RCC to a notebook or PC.

Since the AWK-5232-M12-RCC supports MDI/MDI-X auto-sensing, you can use either a straight through cable or crossover cable to connect the AWK-5232-M12-RCC to a computer. If the LED indicator on AWK-5232-M12-RCC's LAN port lights up, it means the connection is established.

Step 3: Set up the computer's IP address.

Set an IP address on the same subnet as the AWK-5232-M12-RCC. Since the AWK-5232-M12-RCC's default IP address is **192.168.127.253**, and the subnet mask is **255.255.255.0**, you should set the IP address of the computer to **192.168.127.xxx**.

NOTE

After you select **Maintenance → Load Factory Default** and click the **Submit** button, the AWK-5232-M12-RCC will be reset to factory default settings and the IP address will be also reset to **192.168.127.253**.

Step 4: Use the web-based manager to configure AWK-5232-M12-RCC

Open your computer's web browser and type `http://192.168.127.253` in the address field to access the homepage of the web-based Network Manager. Before the homepage opens, you will need to enter the user name and password as shown in the following figure. For first-time configuration, enter the default username and password and then click on the **Login** button:

Moxa AWK-5232-M12-RCC-JP

Username : admin

Password :

Login

goahead
WEB SERVER

NOTE Default user name and password:

Username: **admin**

Password: **moxa**

For security reasons, we strongly recommend changing the default password. To do so, select **Maintenance** → **Password**, and then follow the on-screen instructions to change the password. (Firmware Version 1.6 password: moxa; Firmware Versions 1.0 to 1.5 password: root)

NOTE After you click **Submit** to apply changes, you can see that the web page is refreshed, and the string “(Update)” and a blinking reminder will be shown on the upper-right corner of web page, as follow.



To make the changes effective, click **Restart** and then **Save and Restart** after you change the settings. About 30 seconds are needed for the AWK-5232-M12-RCC to complete its restart process.

Step 5: Select the operation mode for the AWK-5232-M12-RCC.

By default, the AWK-5232-M12-RCC's operation mode is set to Wireless redundancy. You can change the setting in **Wireless Settings** → **Operation mode** if you would like to use the Wireless bridge or AP-Client mode instead. Detailed information about configuring the AWK-5232-M12-RCC's operation can be found in Chapter 3.

Step 6: Test communications.

We will describe 2 test methods to make sure the network connection has been established. Please refer to the following section for more details.

Communications Testing

After installation, you can run a sample test to make sure the AWK-5232-M12-RCC and wireless connection are functioning normally. Two testing methods are explained in the following sections. Use the first method if you are using only one AWK-5232-M12-RCC device, and use the second method if you are using two or more AWK-5232-M12-RCCs.

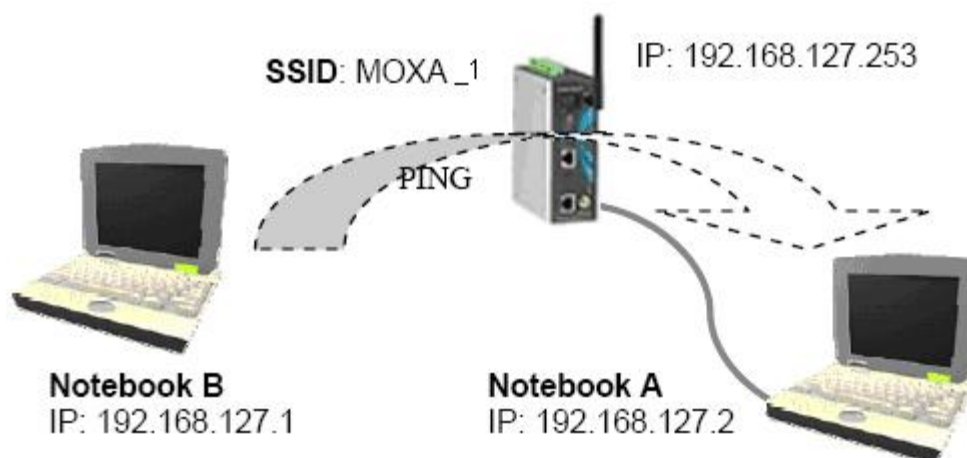

Testing Method for one AWK-5232-M12-RCC

If you are only using one AWK-5232-M12-RCC, you will need a second notebook computer equipped with a WLAN card. Configure the WLAN card to connect to the AWK-5232-M12-RCC (NOTE: the default SSID is

MOXA_1), and change the IP address of the second notebook (B) so that it is on the same subnet as the first notebook (A), which is connected to the AWK-5232-M12-RCC.

After configuring the WLAN card, establish a wireless connection with the AWK-5232-M12-RCC and open a DOS window on Notebook B. At the prompt, type

```
ping <IP address of notebook A>
```

and then press **Enter** (see the figure below). A "Reply from IP address ..." response means the communication was successful. A "Request timed out." response means the communication failed. In this case, recheck the configuration to make sure the connections are correct.

Testing Method for two or more AWK-5232-M12-RCCs

If you have two or more AWK-5232-M12-RCCs, you will need a second notebook computer (B) equipped with an Ethernet port. Use the default settings for the first AWK-5232-M12-RCC connected to notebook A and change the second or third AWK-5232-M12-RCC connected to notebook B to Client mode. Then, configure the notebooks and AWK-5232-M12-RCCs properly.

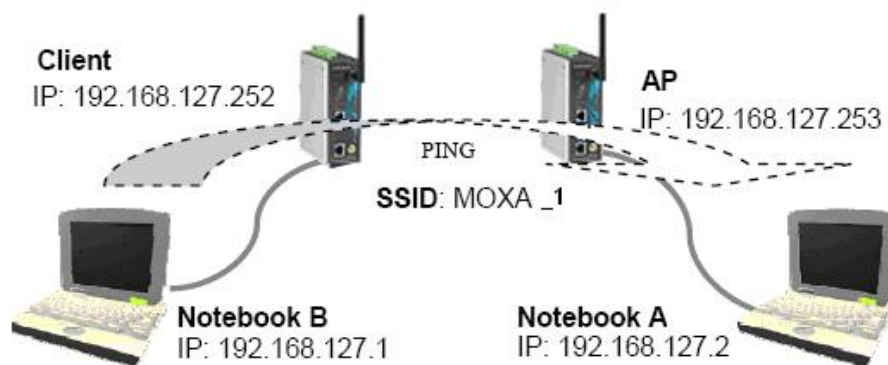

After setting up the testing environment, open a DOS window on notebook B. At the prompt, type

```
ping <IP address of notebook A>
```

and then press **Enter**. A "Reply from IP address ..." response means the communication was successful. A "Request timed out" response means the communication failed. In this case, recheck the configuration to make sure the connections are correct.

Function Guide

The management functions are categorized in a tree and shown in the left field of the web-based management console. You can efficiently locate the function you need with the following guide.

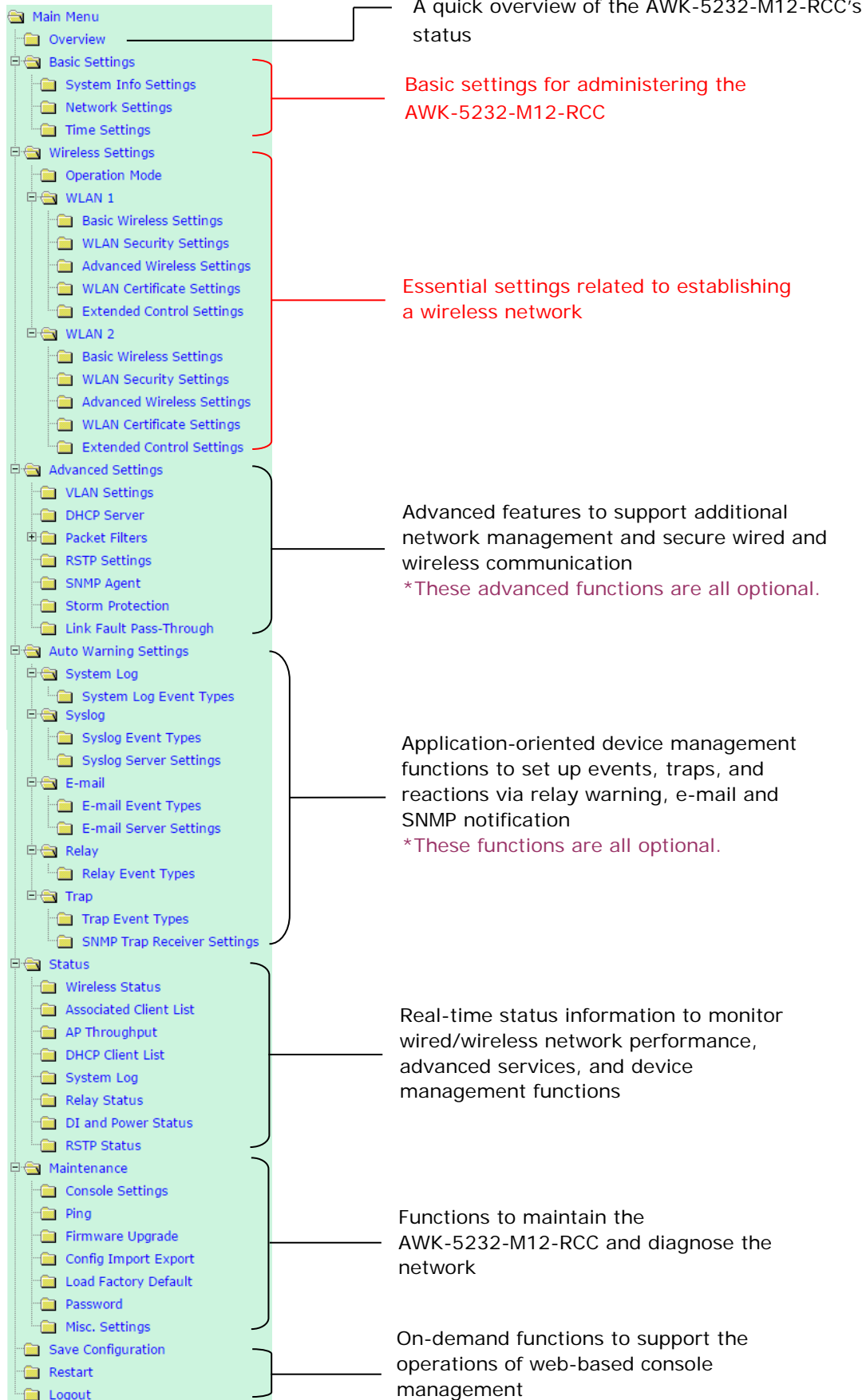

A quick overview of the AWK-5232-M12-RCC's status

Basic settings for administering the AWK-5232-M12-RCC

Essential settings related to establishing a wireless network

Advanced features to support additional network management and secure wired and wireless communication
**These advanced functions are all optional.*

Application-oriented device management functions to set up events, traps, and reactions via relay warning, e-mail and SNMP notification
**These functions are all optional.*

Real-time status information to monitor wired/wireless network performance, advanced services, and device management functions

Functions to maintain the AWK-5232-M12-RCC and diagnose the network

On-demand functions to support the operations of web-based console management

Web Console Configuration

In this chapter, we will explain each web management page of the web-based console configuration. Moxa's easy-to-use management functions will help you set up your AWK-5232-M12-RCC, as well as establish and maintain your wireless network easily.

The following topics are covered in this chapter:

❑ Configuration by Web Browser

❑ Overview

❑ Basic Settings

- System Info Settings
- Network Settings
- Time Settings

❑ Wireless Settings

- Operation Mode

❑ Basic Wireless Settings

- No-Probe Response
- WLAN Security Settings
- Advanced Wireless Settings
- WLAN Certification Settings (for EAP-TLS in Client or Slave mode only)
- Extended Control Settings (AP mode only)

❑ Advanced Settings

- Using Virtual LAN
- Configuring Virtual LAN
- DHCP Server (for AP mode only)
- Packet Filters
- RSTP Settings (for Master, Slave, or ACC mode only)
- SNMP Agent
- Storm Protection
- Link Fault Pass-Through (for Client/Slave mode only)
- CCU Alive Time Settings
- NAT/Port Forwarding

❑ Auto Warning Settings

- System Log
- Syslog
- E-mail
- Relay
- Trap

❑ Status

- Wireless Status
- Associated Client List (for AP/Master/ACC modes only)
- DHCP Client List (for AP mode only)
- System Log
- Relay Status
- DI and Power Status

❑ Maintenance

- Console Settings
- Ping
- Firmware Upgrade
- Config Import Export
- Default Config Import
- Load Factory Default
- Password
- Misc. Settings

❑ Save Configuration

❑ Restart

❑ Logout

Configuration by Web Browser

Moxa AWK-5232-M12-RCC's web browser interface provides a convenient way to modify its configuration and access the built-in monitoring and network administration functions. The recommended web browser is Microsoft® Internet Explorer 5.5 or 6.0 with JVM (Java Virtual Machine) installed.

NOTE To use the AWK-5232-M12-RCC's management and monitoring functions from a PC host connected to the same LAN as the AWK-5232-M12-RCC, you must make sure that the PC host and AWK-5232-M12-RCC are on the same logical subnet. Similarly, if the AWK-5232-M12-RCC is configured for other VLAN settings, you must make sure your PC host is on the management VLAN.
The Moxa AWK-5232-M12-RCC's default IP is **192.168.127.253**.

Follow the steps below to access the AWK-5232-M12-RCC's web-based console management.

1. Open your web browser (ex. Internet Explorer) and type the AWK-5232-M12-RCC's IP address in the address field. Then press **Enter** to establish the connection.

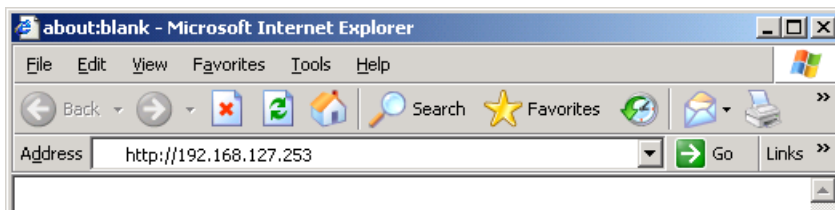

2. The Web Console Login page will open. Enter the password (Username is set as **admin**; the default password is **moxa** if a new password has not been set.) and then click **Login** to continue.

NOTE Firmware Version 1.6 password: moxa
Firmware Versions 1.0 to 1.5 password: root

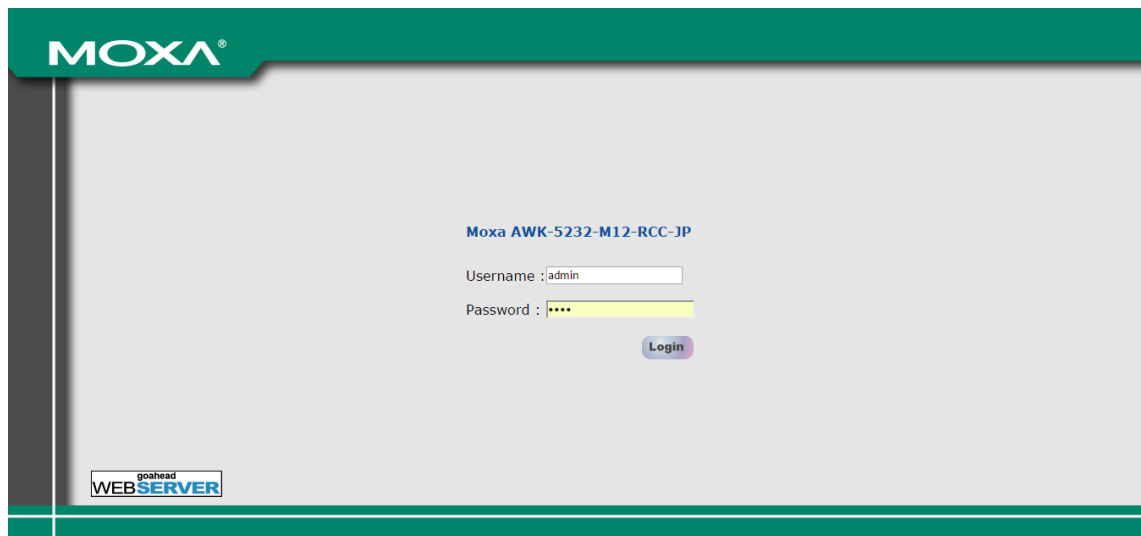

You may need to wait a few moments for the web page download onto your computer. Please note that the Model name and IP address of your AWK-5232-M12-RCC are both shown on the title of the web page. This information can help you identify multiple AWK-5232-M12-RCCs.

You can use the menu tree on the left side of the window to open the function pages to access each of AWK-5232-M12-RCC's functions.

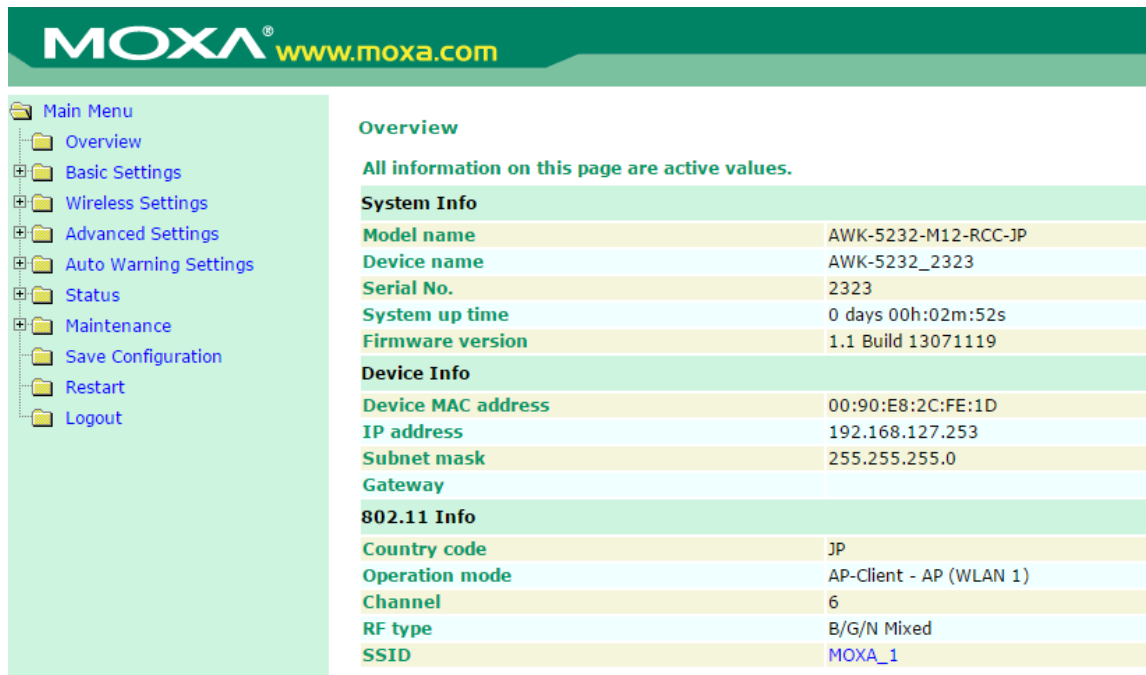

In the following paragraphs, we will go through each of the AWK-5232-M12-RCC’s management functions in detail. You can also get a quick overview of these functions in the “Function Guiding Map” section of Chapter 2.

NOTE The model name of the AWK-5232-M12-RCC is shown as AWK-5232-M12-RCC-XX where XX indicates the country code. The country code represents the AWK-5232-M12-RCC version and which bandwidth it uses. We use **AWK-5232-M12-RCC-JP** as an example in the following figures. The country code of model name on the screen may vary if you are using a different version (band) AWK-5232-M12-RCC.

NOTE For security reasons, you will need to log back into the AWK-5232-M12-RCC after the 5-minute time-out.

Overview

The **Overview** page summarizes the AWK-5232-M12-RCC’s current status. The information is categorized into several groups: **System Info**, **Device info** and **802.11 Info**.

Overview

All information on this page are active values.

System Info

Model name	AWK-5232-M12-RCC-JP
Device name	AWK-5232_2323
Serial No.	2323
System up time	0 days 00h:02m:52s
Firmware version	1.1 Build 13071119

Device Info

Device MAC address	00:90:E8:2C:FE:1D
IP address	192.168.127.253
Subnet mask	255.255.255.0
Gateway	

802.11 Info

Country code	JP
Operation mode	AP-Client - AP (WLAN 1)
Channel	6
RF type	B/G/N Mixed
SSID	MOXA_1

Basic Settings

The Basic Settings group includes the most commonly used settings required by administrators to maintain and control the AWK-5232-M12-RCC.

System Info Settings

The **System Info** items, especially **Device name** and **Device description**, are displayed and included on the **Overview** page, SNMP information, and alarm emails. Setting **System Info** items makes it easier to identify the different AWK-5232-M12-RCCs connected to your network.

System Info Settings

Device name	AP_011
Device location	Area 32, 5th Floor
Device description	No. 11 of ABC supporting system
Device contact information	John Davis, sysop@abc.com

Device name

Setting	Description	Factory Default
Max. 31 Characters	This option is useful for specifying the role or application of different AWK-5232-M12-RCC units.	AWK-5232-M12-RCC_<Serial No. of this AWK-5232-M12-RCC>

Device location

Setting	Description	Factory Default
Max. 31 Characters	To specify the location of different AWK-5232-M12-RCC units.	None

Device description

Setting	Description	Factory Default
Max. 31 Characters	Use this space to record more detailed description of AWK-5232-M12-RCC	None

Device name

Setting	Description	Factory Default
Max. 31 Characters	To provide information about whom to contact in order to resolve problems. Use this space to record contact information of the person responsible for maintaining this AWK-5232-M12-RCC.	None

Network Settings

The Network Settings configuration allows you to modify the usual TCP/IP network parameters. An explanation of each configuration item is given below.

Network Settings

IP configuration	Static ▼
IP address	192.168.127.253
Subnet mask	255.255.255.0
Gateway	
Primary DNS server	
Secondary DNS server	

Ethernet Settings

Allowed port	LAN1+LAN2 ▼
---------------------	-------------

IP configuration

Setting	Description	Factory Default
DHCP	The AWK-5232-M12-RCC's IP address will be assigned automatically by the network's DHCP server	Static
Static	Set up the AWK-5232-M12-RCC's IP address manually.	

IP address

Setting	Description	Factory Default
AWK-5232-M12-RCC's IP address	Identifies the AWK-5232-M12-RCC on a TCP/IP network.	192.168.127.253

Subnet mask

Setting	Description	Factory Default
AWK-5232-M12-RCC's subnet mask	Identifies the type of network to which the AWK-5232-M12-RCC is connected (e.g., 255.255.0.0 for a Class B network, or 255.255.255.0 for a Class C network).	255.255.255.0

Gateway

Setting	Description	Factory Default
AWK-5232-M12-RCC's default gateway	The IP address of the router that connects the LAN to an outside network.	None

Primary/ Secondary DNS server

Setting	Description	Factory Default
IP address of Primary/ Secondary DNS server	The IP address of the DNS Server used by your network. After entering the DNS Server's IP address, you can input the AWK-5232-M12-RCC's URL (e.g., <i>http://ap11.abc.com</i>) in your browser's address field instead of entering the IP address. The Secondary DNS server will be used if the Primary DNS server fails to connect.	None

Allowed Ports

Setting	Description	Factory Default
LAN1+LAN2	Select the LAN port the AWK uses to transmit data.	LAN1+LAN2
LAN1 only	Select LAN1+LAN2 to allow data transmission on both LAN ports.	
LAN2 only		

NOTE In Client-Router Mode, the WAN (wireless interface) and LAN (wired interface) are configured separately.

Time Settings

The AWK-5232-M12-RCC has a time calibration function based on information from an NTP server or user specified Date and Time information. Functions such as Auto warning can add real-time information to the message.

Time Settings

Date (YYYY/MM/DD) Time (HH:MM:SS)

Current local time / / : :

Time zone

Daylight saving time Enable

Starts at : (HH:MM)

Stops at : (HH:MM)

Time offset

Time server 1

Time server 2

Query period (600~9999 seconds)

Current local time shows the AWK-5232-M12-RCC's system time when you open this web page. You can click on the **Set Time** button to activate the update after setting up the date and time parameters. An "(Updated)" string will appear to indicate that the change is complete. Local time settings will be immediately activated in the system without running Save and Restart.

NOTE The AWK-5232-M12-RCC has a real time clock (RTC). Users are strongly recommended to update the **Local time** for the AWK-5232-M12-RCC after initial setup or long-term shutdown, especially when the network does not have an Internet connection for accessing the NTP server or there is no NTP server on the LAN.

Current local time

Setting	Description	Factory Default
User adjustable time	The date and time parameters allow configuration of the local time with immediate activation.	None (yyyy/mm/dd hh:mm:ss format; 24-hour format.)

Time zone

Setting	Description	Factory Default
User selectable time zone	The time zone setting allows conversion from GMT (Greenwich Mean Time) to local time.	GMT (Greenwich Mean Time)

 **ATTENTION** Changing the time zone will automatically adjust the **Current local time**. You should configure the **Time zone** before setting the **Current local time**.

Daylight saving time

Setting	Description	Factory Default
Enable/ Disable	Daylight saving time (also know as DST or summer time) involves advancing clocks (usually 1 hour) during the summer time to provide an extra hour of daylight in the afternoon.	Disable

When **Daylight saving time** is enabled, the following parameters can be shown:

- The **Starts at** parameter allows users to enter the date that daylight saving time begins.
- The **Stops at** parameter allows users to enter the date that daylight saving time ends.
- The **Time offset parameter** indicates how many hours forward the clock should be advanced.

Time server 1/ 2

Setting	Description	Factory Default
The 1st/ 2nd time server IP/Name	IP or Domain address of NTP time server. The 2nd time will be used if the 1st NTP server fails to connect.	None

Query period

Setting	Description	Factory Default
Query period time (1- 9999 seconds)	This parameter determines how often the time is updated from the NTP server.	600 (seconds)

Wireless Settings

The essential settings for wireless networks are presented in this function group. Settings must be properly set before establishing your wireless network.

Operation Mode

The AWK-5232-M12-RCC supports three operation modes for wireless network operations.

Wireless Bridge

A bridge is a network component that connects two networks. AWK-5232-M12-RCC's bridge operation is based on the AP (**master**) and Client (**Slave**) concept. Both sides of the connection must have the same RF type, SSID, and security settings.

For single RF mesh networks, the conventional setup is to use WDS to establish a static bridge link. In this case, the APs at both ends of the WDS link must be configured manually with each other's MAC addresses. The performance of a single RF bridge will be poor if more nodes are added.

The AWK-5232-M12-RCC's dual RF bridge concept is different from using a single RF, because the AWK-5232-M12-RCC has dual RFs, and offer users a cascade link to bridge the two ends without narrowing down the throughput.

Operation mode Wireless bridge

WLAN 1 Operation mode AP

WLAN 2 Operation mode Master

WLAN 1/WLAN 2 Operation mode

Setting	Description	Factory Default
Master	Master can build a connection with a Slave that has the same RF type, SSID, and security settings.	AP for WLAN 1 Master for WLAN 2
Slave	Slave can build a connection with a master that has the same RF type, SSID, and security settings.	

NOTE When used as a bridge for an established network, the AWK-5232-M12-RCC can be configured to serve as a virtual AP for clients configured along an existing SSID. To add a virtual AP in **Wireless Bridge** mode, go to **Wireless Settings** and click **Master**, then select **Add SSID**; enter the name of the SSID, and then click **Save**.

Basic Wireless Settings (Multiple SSID)

Status	SSID	Operation Mode	Action
Active	MOXA_1	AP	<input type="button" value="Edit"/>
Inactive	<input type="text"/>	AP	<input type="button" value="Save"/> <input type="button" value="Cancel"/>

AP-Client

AP-Client mode provides a more flexible topology to allow the user to configure the 2 RF module for an AP or Client.

Operation mode

WLAN 1 Operation mode

WLAN 2 Operation mode

Matching Table for AP-Client's WLANs:

WLAN 1	WLAN 2	Allowable Setting
AP	AP	Allow
AP	Client or Client-Router	Allow
Client or Client-Router	Client or Client-Router	Not Allow
Client or Client-Router	AP	Allow

Inter-carriage

The inter-carriage mode is for establishing automatic wireless bridge connections between carriages of a train. The wireless automatic carriage connection is call “ACC”, which is an operation mode that we two devices are configured in ACC mode, both will connect to form an ACC link as a transparent wireless bridge between two carriages. With the dual radio AP, both radios can be flexible to be configured as AP+ACC or ACC+ACC such as the examples below:

Passenger-WiFi with wireless inter-carriage connection

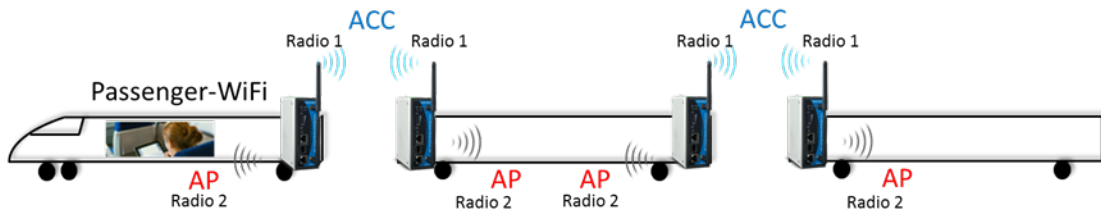

Wireless inter-carriage connection only

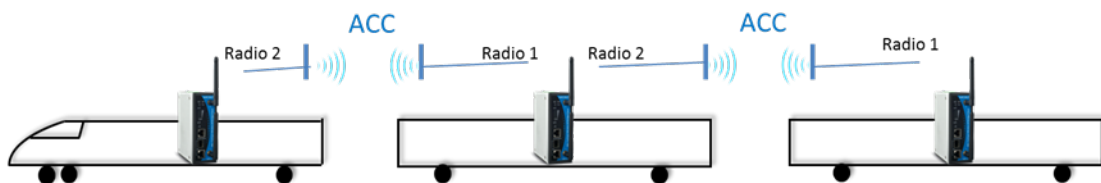

Operation mode

WLAN 1 Operation mode

WLAN 2 Operation mode

Inter-carriage

AP

ACC

Submit

Setting	Description	Default
ACC	This mode collocates with another AWK-5232-RCC’s ACC mode to form an ACC link. Both AWK-5232-RCCs must have the same basic wireless and security settings.	WLAN1: AP WLAN2: ACC

Basic Wireless Settings

The “WLAN Basic Setting Selection” panel is used to add and edit SSIDs. An SSID is a unique identifier that wireless networking devices use to establish and maintain wireless connectivity. Multiple access points on a network or sub-network can use the same SSIDs. You can configure your AWK to use up to 9 SSIDs, and configure each SSID differently. All of the SSIDs are active at the same time; that is, client devices can use any of the SSIDs to associate with the access point.

WLAN Basic Setting Selection

Status	SSID	Operation Mode	Action
Active	MOXA	AP	Edit

Add SSID

Click on **Add SSID** to create more SSIDs.

Click on **Edit** to assign different configuration settings to each SSID. The configuration panel appears as follows:

WLAN 1 Basic Wireless Settings

Operation mode AP
RF type B/G/N Mixed
Channel 6
Channel width 20 MHz
SSID MOXA_1
SSID broadcast Enable Disable
No probe response Enable Disable

Client isolation
Client isolation No isolation
Gateway
Netmask

NOTE When you switch to **Client** mode, a **Site Survey** button will be available on the Basic Wireless Settings panel. Click the “Site Survey” button to view information about available APs, as shown in the following figure. You can click on the SSID of an entity and bring the value of its SSID onto the SSID field of the Basic Wireless Settings page. Click the **Refresh** button to re-scan and update the table. If this client is connecting to an AP, a brief disconnection will occur during site survey.

Basic Wireless Settings

Operation mode Client
RF type B/G/N Mixed
Channel 6
Channel width 20 MHz
SSID MOXA
SSID broadcast Enable Disable
No probe response Enable Disable

No.	SSID	MAC address	Channel	Mode	Signal
1	MHQ-Visitor	FE:F1:28:CB:5D:AB	1	BSS/OPEN	(-99dBm)
2	CARL_TEST	06:90:E8:2B:5F:FA	6	BSS/OPEN	(-100dBm)
3	AWK_VLAN_Test	06:90:E8:4E:9A:7D	6	BSS/OPEN	(-95dBm)
4	MHQ-Visitor	FE:F1:28:CB:5D:93	6	BSS/OPEN	(-101dBm)
5	MHQ-Visitor	FE:F1:28:CB:5D:3F	11	BSS/OPEN	(-104dBm)
6	MHQ-Visitor	FE:F1:28:CB:5D:90	11	BSS/OPEN	(-103dBm)
8	MHQ-Visitor	FE:F1:28:CB:5D:99	6	BSS/OPEN	(-105dBm)

RF type

Setting	Description	Factory Default
2.4 GHz		
B	Only supports the IEEE 802.11b standard	B/G/N Mixed
G	Only supports the IEEE 802.11g standard	
B/G Mixed	Supports IEEE 802.11b/g standards, but 802.11g may operate at a slower speed if when 802.11b clients are on the network	
G/N Mixed	Supports IEEE 802.11g/n standards, but 802.11n may operate at a slower speed if 802.11g clients are on the network	
B/G/N Mixed	Supports IEEE 802.11b/g/n standards, but 802.11g/n may operate at a slower speed if 802.11b clients are on the network	
N Only (2.4GHz)	Only supports the 2.4 GHz IEEE 802.11n standard	
5 GHz		
A	Only supports the IEEE 802.11a standard	
A/N Mixed	Supports IEEE 802.11a/n standards, but 802.11n may operate at a slower speed if 802.11a clients are on the network	
N Only (5GHz)	Only supports the 5 Ghz IEEE 802.11n standard	

Channel (for AP/Master/ACC mode only)

Setting	Description	Factory Default
Available channels vary with RF type	The AWK plays the role of wireless AP, Master, or ACC.	6 (in B/G/N Mixed mode)

Channel Width (for any 11N RF type only)

Setting	Description	Factory Default
20 MHz	Select your channel width, If you are not sure which option to use, select 20/ 40MHz (Auto)	20 MHz
20/40 MHz		

SSID

Setting	Description	Factory Default
Max. of 31 characters	The SSID of a client and the SSID of the AP must be identical for the client and AP to be able to communicate with each other.	MOXA

SSID broadcast (for AP/Master/ACC mode only)

Setting	Description	Factory Default
Enable/ Disable	SSID can be broadcast or not	Enable

No-Probe Response

Passenger Wi-Fi Application

The fact that most phones and pads use the 2.4-GHz band to negotiate with the AP can cause overcrowding of the 2.4-GHz channel. To avoid this, some applications set up APs in the 5-GHz band to reduce 2.4 GHz channel usage. For AWK-5232-M12-RCC, we suggest that you enable the No-Probe Response function in your 2.4 GHz RF, and then set up the transmission power of your 5 GHz RF to be higher than the 2.4 GHz RF. In this case, clients that support both 2.4 GHz and 5 GHz will get higher priority when they try to connect to the 5 GHz RF.

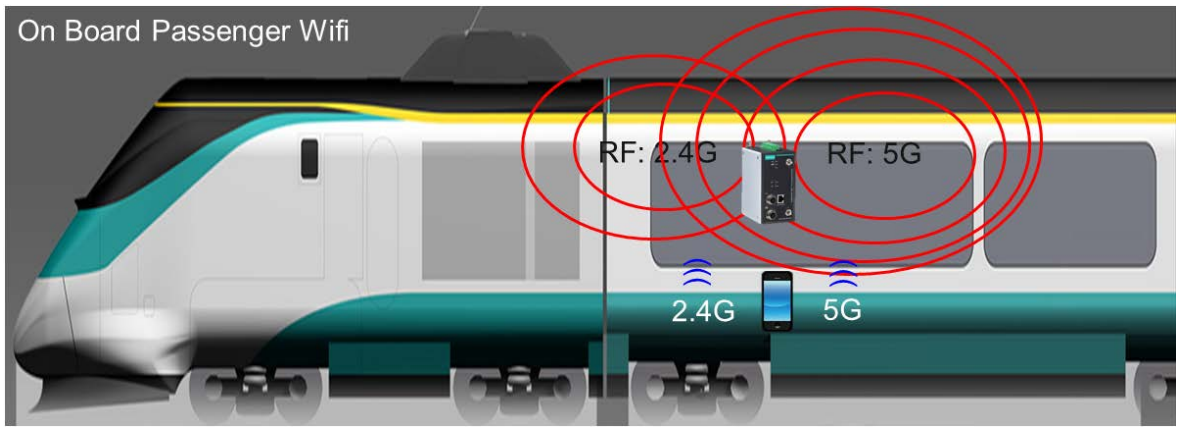

Description



RF-1: 2.4G RF-2: 5G

No Probe response
Disable Disable



1. Client sends 2.4 GHz or 5 GHz probe request to AP.
2. AP sends 2.4 GHz or 5 GHz probe response to Client.



RF-1: 2.4G RF-2: 5G

No Probe response
Enable Disable



1. Client sends 2.4 GHz or 5 GHz probe request to AP.
2. AP sends 5 GHz probe response only to the Client.

No Probe response

Setting	Description	Factory Default
Enable/Disable	<p>Enable: The AP only sends a probe response to the 5 GHz Client, which will cause the 2.4 GHz Client active scan behavior to fail.</p> <p>Disable: The AP sends a probe response to the 2.4/5 GHz Client.</p> <p>Note: This function works only in AP mode. See the IEEE 802.11 standards for standard active/passive scan behavior and detailed negotiation procedure.</p>	Disable

Client Isolation (for AP mode only)

Client isolation is used to isolate the associated wireless clients in one or more APs. Isolated clients cannot communicate with each other, so the level of security is increased. Depending on the type of client isolation, you may also define the exception clients inside the isolation network. It can be used in server access.

Client isolation

Client isolation Isolated within the same subnet ▼

Gateway

Netmask

Allowed subnet with TCP/UDP port

No	<input type="checkbox"/> Active	IP	Netmask	Protocol	Port
1	<input type="checkbox"/>	<input type="text"/>	<input type="text"/>	All ▼	<input type="text"/> ~ <input type="text"/>
2	<input type="checkbox"/>	<input type="text"/>	<input type="text"/>	All ▼	<input type="text"/> ~ <input type="text"/>
3	<input type="checkbox"/>	<input type="text"/>	<input type="text"/>	All ▼	<input type="text"/> ~ <input type="text"/>
4	<input type="checkbox"/>	<input type="text"/>	<input type="text"/>	All ▼	<input type="text"/> ~ <input type="text"/>
5	<input type="checkbox"/>	<input type="text"/>	<input type="text"/>	All ▼	<input type="text"/> ~ <input type="text"/>
6	<input type="checkbox"/>	<input type="text"/>	<input type="text"/>	All ▼	<input type="text"/> ~ <input type="text"/>
7	<input type="checkbox"/>	<input type="text"/>	<input type="text"/>	All ▼	<input type="text"/> ~ <input type="text"/>
8	<input type="checkbox"/>	<input type="text"/>	<input type="text"/>	All ▼	<input type="text"/> ~ <input type="text"/>

Client Isolation

Setting	Description	Factory Default
No isolation	No isolation is applied.	No isolation
Isolated within the same AP	All clients associated to this AP will be isolated from each other.	
Isolated within the same subnet	All clients in the specified subnet will be isolated from each other. The subnet is defined by the following two parameters, gateway and netmask.	

Gateway

Setting	Description	Factory Default
Gateway for client isolation function	This setting is used when “Isolated within the same subnet” is selected. Gateway and netmask are used to define the network in which wireless clients will be isolated from each other.	None

Netmask

Setting	Description	Factory Default
Netmask for client isolation function	This setting is used when “Isolated within the same subnet” is selected. Gateway and netmask are used to define the network in which wireless clients will be isolated from each other.	None

“Allowed subnet with TCP/UDP port” settings are used to define the exception subnets (or hosts) when “Isolated within the same subnet” is selected. Up to eight subnets or hosts can be defined.

Active

Setting	Description	Factory Default
Enable/Disable	This checkbox enables or disables the rule for allowed subnet settings.	Disable

IP

Setting	Description	Factory Default
IP address for allowed subnet definition	The IP address of the subnet definition. Hosts in this subnet can be accessed by other hosts or wireless clients in the same subnet.	None

Netmask

Setting	Description	Factory Default
Netmask for allowed subnet definition	The netmask of the subnet definition. Hosts in this subnet can be accessed by other hosts or wireless clients in the same subnet. You can also define the exception host by entering 255.255.255.255 in this field.	None

Protocol

Setting	Description	Factory Default
Protocol for allowed subnet definition	The protocol of the subnet definition. Hosts in this subnet can be accessed by other hosts or wireless clients in the same subnet.	All

Port

Setting	Description	Factory Default
Port for allowed subnet definition	The port range of the subnet definition. Hosts in this subnet can be accessed by other hosts or wireless clients in the same subnet.	None

NOTE The AWK-5232-RCC-EU (for European frequency bands) only connects SSID-hidden APs for IEEE 802.11b/g/n channels.

WLAN Security Settings

The following figure shows the WLAN1/2 Security Settings page. The parameters and options are described as follows:

NOTE When you switch to the **WLAN Security Settings** overview page. Please click on **Edit** to modify WLAN security settings.

WLAN Security Settings (Multiple SSID)

Status	SSID	Operation Mode	Security Mode	Action
Active	MOXA_1	AP	OPEN	<input type="button" value="Edit"/>

The AWK-5232-M12-RCC provides four standardized wireless security modes: Open, WEP (Wired Equivalent Privacy), WPA (Wi-Fi Protected Access) and WPA2. Several types of security models are available in AWK-5232-M12-RCC by selecting **Security mode** and **WPA type**:

- **Open:** No authentication, no data encryption.
- **WEP:** Static WEP (Wired Equivalent Privacy) keys must be manually configured (this option is not supported under N only mode).
- **WPA/WPA2-Personal:** also known as WPA/WPA2-PSK. You need to specify the Pre-Shared Key in the **Passphrase** field, which will be used by the TKIP or AES engine as a master key to generate keys that actually encrypt outgoing packets and decrypt incoming packets.
- **WPA/WPA2-Enterprise:** also called WPA/WPA2-EAP (Extensible Authentication Protocol). In addition to device-based authentication, WPA/WPA2-Enterprise enables user-based authentication via IEEE802.1X. The AWK-5232-M12-RCC can support three EAP methods: EAP-TLS, EAP-TTLS, and EAP-PEAP.

SSID MOXA_1
 Security mode Open ▾

Submit

Security mode

Setting	Description	Factory Default
Open	No authentication	Open
WEP	Static WEP is used <i>Note: This option is not supported under 802.11n.</i>	
WPA	Fully supports IEEE 802.11i with "TKIP/AES + 802.1X" in 802.11a/b/g mode; supports IEEE 802.11i with "AES + 802.1X" in 802.11n mode	
WPA2	Fully supports IEEE 802.11i with "TKIP/AES + 802.1X" in 802.11a/b/g mode; supports IEEE 802.11i with "AES + 802.1X" in 802.11n mode	

Open

For security reasons, it is highly recommended that the security mode should be set to the options other than Open System. When the security mode is set to Open System, no authentication or data encryption will be performed.

WEP

According to the IEEE802.11 standard, WEP can be used for authentication and data encryption (confidentiality). **Shared** (or **Shared Key**) authentication type is used if WEP authentication and data encryption are both needed. Normally, **Open** (or **Open System**) authentication type is often used when WEP data encryption is run with authentication.

When WEP is enabled as a security mode, the length of a key (so-called WEP seed) can be specified as 64/128 bits, which is actually a 40/104-bit secret key with a 24-bit initialization vector. The AWK-5232-M12-RCC provides 4 entities of WEP key settings that can be selected to use with **Key index**. The selected key setting specifies the key to be used as a *send-key* for encrypting traffic from the AP side to the wireless client side. All 4 WEP keys are used as *receive-keys* to decrypt traffic from the wireless client side to the AP side.

The WEP key can be presented in two **Key type**, HEX and ASCII. Each ASCII character has 8 bits, so a 40-bit (or 64-bit) WEP key contains 5 characters, and a 104-bit (or 128-bit) key has 13 characters. In hex, each character uses 4 bits, so a 40-bit key has 10 hex characters, and a 128-bit key has 26 characters.

SSID MOXA_1
 Security mode WEP ▾
 Authentication type Open ▾
 Key type HEX ▾
 Key length 64 bits ▾
 Key index 1 ▾
 WEP key 1
 WEP key 2
 WEP key 3
 WEP key 4

Submit

Authentication type

Setting	Description	Factory Default
Open	Data encryption is enabled, but no authentication.	Open
Shared	Data encryption and authentication are both enabled.	

Key type

Setting	Description	Factory Default
HEX	Specifies WEP keys in hex-decimal number form	HEX
ASCII	Specifies WEP keys in ASCII form	

Key length

Setting	Description	Factory Default
64 bits	Uses 40-bit secret keys with 24-bit initialization vector	64 bits
128 bits	Uses 104-bit secret key with 24-bit initialization vector	

Key index

Setting	Description	Factory Default
1-4	Specifies which WEP key is used	Open

WEP key 1-4

Setting	Description	Factory Default
ASCII type: 64 bits: 5 chars 128 bits: 13chars HEX type: 64 bits: 10 hex chars 128 bits: 26 hex chars	A string that can be used as a WEP seed for RC4 encryption engine.	None

WPA/WPA2-Personal

WPA (Wi-Fi Protected Access) and WPA2 are significantly improved encryption methods of WEP. WPA is a security standard based on 802.11i draft 3, while WPA2 is based on the fully ratified version of 802.11i. The initial vector is transmitted, encrypted, and enhanced with its 48 bits, twice as long as WEP. The key is regularly changed so that true session is secured.

Even though AES encryption is only included in the WPA2 standard, it is widely available in the WPA security mode of some wireless APs and clients as well. The AWK-5232-M12-RCC also supports AES algorithms in WPA and WPA2 for better compatibility.

Personal versions of WPA/WPA2, also know as WPA/WPA-PSK (*Pre-Shared Key*), provides a simple way of encrypting a wireless connection for high confidentiality. A **Passphrase** is used as a basis for encryption methods (or cipher types) in a WLAN connection. The passphrases should be complex and as long as possible. The number of ASCII characters of the Passphrase must be at least 8 and can go up to 63. For security reason, this passphrase should be disclosed to the relevant users only and changed regularly.

SSID MOXA_1
Security mode WPA
WPA type Personal
Encryption method TKIP
Passphrase TKIP
Key renewal 3600 (60~86400 seconds)

WPA Type

Setting	Description	Factory Default
Personal	Provides Pre-Shared Key-enabled WPA and WPA2	Personal
Enterprise	Provides enterprise-level security for WPA and WPA2	

Encryption method

Setting	Description	Factory Default
TKIP	Temporal Key Integrity Protocol is enabled <i>Note: This option is not supported under 802.11n.</i>	TKIP
AES	Advance Encryption System is enabled	
Mixed	Provides TKIP broadcast key and TKIP+AES unicast key for some legacy AP clients. This option is rarely used. <i>Note: This option is available in AP or Master mode only.</i>	

Passphrase

Setting	Description	Factory Default
8 – 63 characters	Master key to generate keys for encryption and decryption	None

Key renewal (for AP or Master mode only)

Setting	Description	Factory Default
60 – 86400 seconds (1 minute to 1 day)	Specifies the time period of group key renewal	3600 (seconds)

NOTE The value for **key renewal** instructs the wireless AP how often it should change the encryption keys. Usually the security level will be higher if you set this value shorter so that the encryption keys are changed more often. Default value is 3600 seconds (6 minutes). Longer time periods can be considered if traffic is not so busy.

WPA/WPA2-Enterprise (for AP or Master mode)

By selecting **WPA type** as **Enterprise**, you can use **EAP (Extensible Authentication Protocol)**, a framework authentication protocol used by 802.1X to provide network authentication. In these Enterprise-level security modes, a back-end RADIUS (Remote Authentication Dial-In User Service) server is needed if IEEE 802.1X functionality is enabled in WPA /WPA2. The IEEE 802.1X protocol also offers the possibility of carrying out an efficient connection authentication in a large-scaled network. It is not necessary to exchange keys or pass phrases.

WLAN 1 WLAN Security Settings

SSID	MOXA_1
Security mode	WPA2 ▾
WPA type	Enterprise ▾
Encryption method	TKIP ▾
Primary RADIUS server IP	TKIP <input type="text"/>
Primary RADIUS server port	AES <input type="text"/>
Primary RADIUS shared key	Mixed <input type="text"/>
Secondary RADIUS server IP	1812 <input type="text"/>
Secondary RADIUS server port	<input type="text"/>
Secondary RADIUS shared key	<input type="text"/>
Key renewal	3600 (60~86400 seconds)

WPA Type

Setting	Description	Factory Default
Personal	Provides Pre-Shared Key-enabled WPA and WPA2	Personal
Enterprise	Provides enterprise-level security for WPA and WPA2	

Encryption method

Setting	Description	Factory Default
TKIP	Temporal Key Integrity Protocol is enabled <i>Note: This option is not supported under 802.11n.</i>	TKIP
AES	Advance Encryption System is enabled	
Mixed	Provides TKIP broadcast key and TKIP+AES unicast key for some legacy AP clients. This option is rarely used. <i>Note: This option is available in AP or Master mode only.</i>	

Primary/ Secondary RADIUS server IP

Setting	Description	Factory Default
The IP address of RADIUS server	Specifies the delegated RADIUS server for EAP	None

Primary/ Secondary RADIUS port

Setting	Description	Factory Default
Port number	Specifies the port number of the delegated RADIUS server	1812

Primary/ Secondary RADIUS shared key

Setting	Description	Factory Default
Max. 31 characters	The secret key shared between AP and RADIUS server	None

Key renewal

Setting	Description	Factory Default
60 – 86400 seconds (1 minute to 1 day)	Specifies the time period of group key renewal	3600 (seconds)

WPA/WPA2-Enterprise (Client and Slave modes)

In a client role, the AWK-5232-M12-RCC can support three EAP methods (or **EAP protocols**): **EAP-TLS**, **EAP-TTLS**, and **EAP-PEAP**, corresponding to WPA/WPA-Enterprise settings on the AP side.

WLAN 1 WLAN Security Settings

SSID MOXA_1
Security mode WPA2 ▾
WPA type Enterprise ▾
Encryption method TKIP ▾
EAP protocol TLS ▾
 TLS
 TTLS
 PEAP

Encryption method

Setting	Description	Factory Default
TKIP	Temporal Key Integrity Protocol is enabled <i>Note: This option is not supported under 802.11n.</i>	AES
AES	Advance Encryption System is enabled	

EAP Protocol

Setting	Description	Factory Default
TLS	Specifies Transport Layer Security protocol	TLS
TTLS	Specifies Tunneled Transport Layer Security	
PEAP	Specifies Protected Extensible Authentication Protocol, or Protected EAP	

Before choosing the EAP protocol for your WPA/WPA2-Enterprise settings on the client end, please contact the network administrator to make sure the system supports the protocol on the AP end. Detailed information on these three popular EAP protocols is presented in the following sections:

EAP-TLS

TLS is the standards-based successor to the Secure Socket Layer (SSL). It can establish a trusted communication channel over a distrusted network. TLS provides mutual authentication through certificate exchange. EAP-TLS is also secure to use. You are required to submit a digital certificate to the authentication server for validation, but the authentication server must also supply a certificate.

You can use **WLAN 1/2 → WLAN Certificate Settings** to import your WLAN certificate and enable EAP-TLS on the client end.

WLAN 1 WLAN Security Settings

SSID	MOXA_1
Security mode	WPA2 ▼
WPA type	Enterprise ▼
Encryption method	TKIP ▼
EAP protocol	TLS ▼
Certificate issued to	N/A
Certificate issued by	N/A
Certificate expiration date	N/A

You can check the current certificate status in **Current Status** if it is available.

Certificate issued to: shows the certificate user.

Certificate issued by: shows the certificate issuer.

Certificate expiration date: indicates when the certificate gets invalid.

EAP-TTLS

It is usually much easier to re-use existing authentication systems, such as a Windows domain or Active Directory, LDAP directory, or Kerberos realm, rather than creating a parallel authentication system. As a result, TTLS (Tunneled TLS) and PEAP (Protected EAP) are used to support the use of so-called “legacy authentication methods.”

TTLS and PEAP work in a similar way. First, they establish a TLS tunnel, like EAP-TLS, and validate whether the network is trustworthy with digital certificates on the authentication server. This step is run to establish a tunnel that protects the next step (or “inner” authentication) so it is sometimes referred to as the “outer” authentication. Then the TLS tunnel is used to encrypt an older authentication protocol that authenticates the user for the network.

As you can see, digital certificates are still needed for the outer authentication in a simplified form. Only a small number of certificates are required, which can be generated by a small certificate authority. Certificate reduction makes TTLS and PEAP much more popular than EAP-TLS.

The AWK-5232-M12-RCC provides some non-cryptographic EAP methods including **PAP**, **CHAP**, **MS-CHAP**, and **MS-CHAP-V2**. These EAP methods are not recommended for direct use on wireless networks. However, they may be useful as inner authentication methods with TTLS or PEAP.

Because the inner and outer authentications can use distinct user names in TTLS and PEAP, you can use an anonymous user name for the outer authentication, while the true user name is shown only through the encrypted channel. Remember, not all client software supports anonymous alteration. Confirm this with the network administrator before you enable identity hiding in TTLS and PEAP.

WLAN 1 WLAN Security Settings

SSID MOXA_1
Security mode WPA2 ▾
WPA type Enterprise ▾
Encryption method TKIP ▾
EAP protocol TTLS ▾
TTLS inner authentication MS-CHAP-V2 ▾
Anonymous name
User name
Password

TTLS Inner Authentication

Setting	Description	Factory Default
PAP	Password Authentication Protocol is used	MS-CHAP-V2
CHAP	Challenge Handshake Authentication Protocol is used	
MS-CHAP	Microsoft CHAP is used	
MS-CHAP-V2	Microsoft CHAP version 2 is used	

Anonymous

Setting	Description	Factory Default
Max. 31 characters	A distinct name used for outer authentication	None

User name & Password

Setting	Description	Factory Default
	User name and password used in inner authentication	None

PEAP

There are a few differences in the inner authentication procedures for TTLS and PEAP. TTLS uses the encrypted channel to exchange attribute-value pairs (AVPs), while PEAP uses the encrypted channel to start a second EAP exchange inside of the tunnel. The AWK-5232-M12-RCC provides **MS-CHAP-V2** merely as an EAP method for inner authentication.

WLAN 1 WLAN Security Settings

SSID	MOXA_1
Security mode	WPA2 ▾
WPA type	Enterprise ▾
Encryption method	TKIP ▾
EAP protocol	PEAP ▾
Inner EAP protocol	MS-CHAP-V2 ▾
Anonymous name	<input type="text" value="MS-CHAP-V2"/>
User name	<input type="text"/>
Password	<input type="password"/>

Inner EAP protocol

Setting	Description	Factory Default
MS-CHAP-V2	Microsoft CHAP version 2 is used	MS-CHAP-V2

Anonymous

Setting	Description	Factory Default
Max. 31 characters	A distinct name used for outer authentication	None

User name & Password

Setting	Description	Factory Default
	User name and password used in inner authentication	None

Advanced Wireless Settings

Additional wireless-related parameters are presented in this section to help you set up your wireless network in detail.

WLAN 1 Advanced Wireless Settings

Transmission rate	Auto ▼
Multicast rate	6M ▼
Guard interval	800ns ▼
Transmission power	10 dBm ▼
Beacon interval	100 (40~1000ms)
DTIM interval	1 (1~15)
Fragmentation threshold	2346 (256~2346)
RTS threshold	2346 (256~2346)
Noise protection	Disable ▼
Antenna	Auto ▼
WMM	Enable ▼
Full 11a channel support	Disable ▼
ACC connection threshold	-60 (-96~-26 dBm)
ACC disconnection threshold	-60 (-96~-26 dBm)
ACC connection time	60 (60~180 seconds)
ACC disconnection time	60 (60~180 seconds)

Transmission Rate

Setting	Description	Factory Default
Auto	The AWK-5232-M12-RCC senses and adjusts the data rate automatically	Auto
Available rates	Users can manually select a target transmission data rate	

Multicast Rate

Setting	Description	Factory Default
Available rates	You can set a fixed multicast rate for the transmission of broadcast and multicast packets on a per-radio basis. This parameter can be useful in an environment where multicast video streaming is occurring in the wireless medium, providing the wireless clients are capable of handling the configured rate.	6M

Guarding Interval

Setting	Description	Factory Default
Guarding Interval	Guarding interval is used to ensure that distinct transmissions do not interfere with one another. You can select the guarding interval manually for Wireless-N connections. The two options are Short (400ns) and Long (800ns).	800ns.

Transmission Power

Setting	Description	Factory Default
0 to 20 dBm	The maximum transmission power allowable in dBm.	10 dBm

Beacon Interval (for AP/Master mode only)

Setting	Description	Factory Default
Beacon Interval (40 to 1000 ms)	Indicates the frequency interval of the beacon	100 (ms)

DTIM Interval (for AP/Master mode only)

Setting	Description	Factory Default
Data Beacon Rate (1 to 15)	Indicates how often the AWK-5232-M12-RCC sends out a Delivery Traffic Indication Message	1

Fragmentation threshold

Setting	Description	Factory Default
Fragment Length (256 to 2346)	Specifies the maximum size a data packet before splitting and creating another new packet	2346

RTS threshold

Setting	Description	Factory Default
RTS/CTS Threshold (256 to 2346)	Determines how large a packet can be before the Access Point coordinates transmission and reception to ensure efficient communication	2346

NOTE You can refer to the related glossaries in Chapter 5 for detailed information about the above-mentioned settings. By setting these parameters properly, you can better tune the performance of your wireless network and avoid the problem of hidden nodes.

Noise protection

Setting	Description	Factory Default
Enable/Disable	Adjusts the interference coping capability of the wireless signal. This option should be enabled for communication distance under 500 meters, and should be disabled for communication distances over 500 meters.	Enable

WMM

Setting	Description	Factory Default
Enable/Disable	WMM is a QoS standard for WLAN traffic. Voice and video data will be given priority bandwidth when enabled with WMM supported wireless clients. <i>Note: WMM will always be enabled under 802.11n mode.</i>	Enable

Full 11a channel support

Setting	Description	Factory Default
Enable/Disable	Enabling this option allows users to select 5GHz channels from both licensed and unlicensed bands.	Disable

ACC Connection Threshold

Setting	Description	Factory Default
ACC Connection Threshold	If the signal strength of an AWK-5232-RCC can be above this value for the period of time specified in the "ACC Connection Time" field, this AWK-5232-RCC will be considered a connecting candidate.	-60 dBm

ACC Disconnection Threshold

Setting	Description	Factory Default
ACC Disconnection Threshold	If the signal strength of the AWK-5232-RCC is below this threshold value for the period of time specified in the "ACC Disconnection Time" field, the ACC link will be brought down.	-60 dBm

ACC Connection Time

Setting	Description	Factory Default
ACC Connection Time	This is the period of time for an AWK-5232-RCC to be considered as a connecting candidate.	60 seconds

Step 1:

Certificate private password

Step 2:

Select certificate/key file

NOTE The WLAN certificate will remain after the AWK-5232-M12-RCC reboots. Even though it is expired, it can still be seen on *Current Certificate*.

Extended Control Settings (AP mode only)

This function lets you quickly switch to your favorite profile recorded in the device, making it easy to demo the device or change the settings of your device.

An example of how you can quickly change the settings from the 2.4 GHz band to the 5 GHz band is illustrated below:

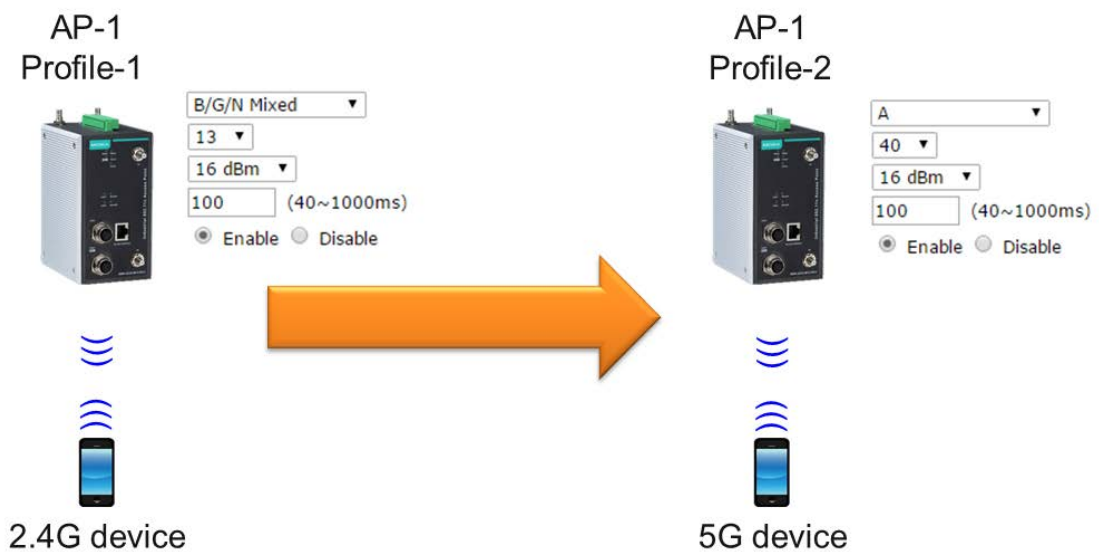

Extended Control Setting (AP mode only)

Setting	Description	Factory Default
Enable/Disable	Enable this function to quickly switch to your favorite profile.	Disable

Favorite Profile

Setting	Description	Factory Default
Profile 1/ Profile 2	Choose your favorite profile to quickly switch RF type, channel, transmission power, beacon interval, and beacon broadcast status.	No Extended Control

Extended Control Settings (AP mode only)

Extended control	Disable ▾
Favourite profile	No Extended Control ▾

Profile 1

RF type 1	B/G/N Mixed ▾
Channel 1	6 ▾
Transmission power 1	10 dBm ▾
Beacon interval 1	100 (40~1000ms)
SSID broadcast 1	<input checked="" type="radio"/> Enable <input type="radio"/> Disable

Profile 2

RF type 2	B/G/N Mixed ▾
Channel 2	6 ▾
Transmission power 2	10 dBm ▾
Beacon interval 2	100 (40~1000ms)
SSID broadcast 2	<input checked="" type="radio"/> Enable <input type="radio"/> Disable

Advanced Settings

Several advanced functions are available to increase the functionality of your AWK-5232-M12-RCC and wireless network system. The DHCP server helps you deploy wireless clients efficiently. Packet filters provide security mechanisms, such as firewalls, in different network layers. Moreover, the AWK-5232-M12-RCC can support STP/RSTP protocol to increase the reliability across the entire network. In addition, SNMP support can ease the network management via SNMP protocols.

Using Virtual LAN

Setting up Virtual LANs (VLANs) on your AWK series increases the efficiency of your network by dividing the LAN into logical segments, as opposed to physical segments. In general, VLANs are easier to manage.

The Virtual LAN (VLAN) Concept

What is a VLAN?

A virtual LAN, commonly known as a VLAN, is a group of hosts with a common set of requirements that communicate as if they were attached to the same broadcast domain, regardless of their physical location. A VLAN has the same attributes as a physical LAN, but it allows for end stations to be grouped together even if they are not located on the same network switch. Network reconfiguration can be done through software instead of physically relocating devices.

VLANs now extend as far as the reach of the access point signal. Clients can be segmented into wireless sub-networks via SSID and VLAN assignment. A Client can access the network by connecting to an AP configured to support its assigned SSID/VLAN.

Benefits of VLANs

VLANs are used to conveniently, efficiently, and easily manage your network in the following ways:

- Manage adds, moves, and changes from a single point of contact
- Define and monitor groups
- Reduce broadcast and multicast traffic to unnecessary destinations
- Improve network performance and reduce latency
- Increase security
- Secure network restricts members to resources on their own VLAN
- Clients roam without compromising security

VLAN Workgroups and Traffic Management

The AP assigns clients to a VLAN based on a Network Name (SSID). The AP can support up to 9 SSIDs per radio interface, with a unique VLAN configurable per SSID.

The AP matches packets transmitted or received to a network name with the associated VLAN. Traffic received by a VLAN is only sent on the wireless interface associated with that same VLAN. This eliminates unnecessary traffic on the wireless LAN, conserving bandwidth and maximizing throughput.

In addition to enhancing wireless traffic management, the VLAN-capable AP supports easy assignment of wireless users to workgroups. In a typical scenario, each user VLAN represents a department workgroup; for example, one VLAN could be used for a marketing department and the other for a human resource department.

In this scenario, the AP would assign every packet it accepted to a VLAN. Each packet would then be identified as marketing or human resource, depending on which wireless client received it. The AP would insert VLAN headers or "tags" with identifiers into the packets transmitted on the wired backbone to a network switch.

Finally, the switch would be configured to route packets from the marketing department to the appropriate corporate resources such as printers and servers. Packets from the human resource department could be restricted to a gateway that allowed access to only the Internet. A member of the human resource department could send and receive e-mail and access the Internet, but would be prevented from accessing servers or hosts on the local corporate network.

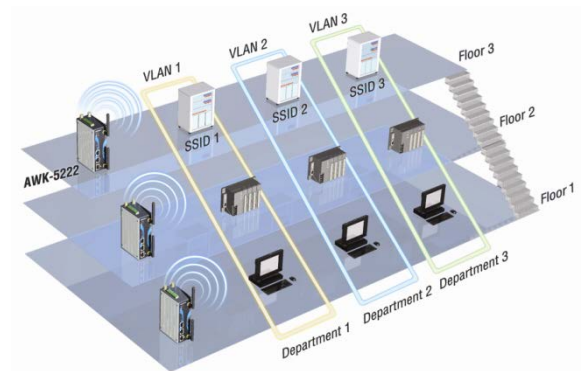

Configuring Virtual LAN

VLAN Settings

To configure the AWK's VLAN, use the VLAN Setting page to configure the ports.

VLAN Settings (for AP/Master/Slave mode only)

Management VLAN ID:

Port	PVID	VLAN Tagged (Please use comma to separate multiple VLAN tags.)
LAN	<input type="text" value="1"/>	<input type="text"/>
MOXA	<input type="text" value="1"/>	<input type="text"/>
SSID2	<input type="text" value="1"/>	<input type="text"/>
SSID3	<input type="text" value="1"/>	<input type="text"/>
SSID4	<input type="text" value="1"/>	<input type="text"/>
SSID5	<input type="text" value="1"/>	<input type="text"/>
SSID6	<input type="text" value="1"/>	<input type="text"/>
SSID7	<input type="text" value="1"/>	<input type="text"/>
SSID8	<input type="text" value="1"/>	<input type="text"/>
SSID9	<input type="text" value="1"/>	<input type="text"/>

Management VLAN ID

Setting	Description	Factory Default
VLAN ID ranges from 1 to 4094	Set the management VLAN of this AWK.	1

Port

Type	Description	Trunk Port
LAN 1/2	This port is the LAN 1/2/etc. port on the AWK.	Yes
WLAN 1, etc	This is a wireless port for the specific SSID. This field will refer to the SSID that you have created. If more SSIDs have been created, new rows will be added.	

PVID

Setting	Description	Factory Default
VLAN ID ranging from 1 to 4094	Set the port's VLAN ID for devices that connect to the port. The port can be a LAN port or WLAN ports.	1

VLAN Tagged

Setting	Description	Factory Default
A comma-seperated list of VLAN IDs. Each of the VLAN IDs range from 1 to 4094.	Specify which VLANs can communicate with this specific VLAN.	(Empty)

NOTE The VLAN feature can allow wireless clients to manage the AP. If the VLAN Management ID matches a VLAN ID, then those wireless clients who are members of that VLAN will have AP management access.

CAUTION: Once a VLAN Management ID is configured and is equivalent to one of the VLAN IDs on the AP, all members of that User VLAN will have management access to the AP. Be careful to restrict VLAN membership to those with legitimate access to the AP.

DHCP Server (for AP mode only)

DHCP (Dynamic Host Configuration Protocol) is a networking protocol that allows administrators to assign temporary IP addresses to network computers by “leasing” an IP address to a user for a limited amount of time, instead of assigning permanent IP addresses.

The AWK-5232-M12-RCC can act as a simplified DHCP server and easily assign IP addresses to your wireless clients by responding to the DHCP requests from the client ends. The IP-related parameters you set on this page will also be sent to the client.

You can also assign a static IP address to a specific client by entering its MAC address. The AWK-5232-M12-RCC provides a **Static DHCP mapping** list with up to 16 entities. Be reminded to check the **Active** check box for each entity to activate the setting.

You can check the IP assignment status under **Status → DHCP Client List**.

DHCP Server (for AP mode only)

DHCP server	<input type="button" value="Disable"/>
Default gateway	<input type="button" value="Enable"/> <input type="text"/>
Subnet mask	<input type="text"/>
Primary DNS server	<input type="text"/>
Secondary DNS server	<input type="text"/>
Start IP address	<input type="text"/>
Maximum number of users	<input type="text"/>
Client lease time	<input type="text" value="10"/> (1~10 days)

Static DHCP mapping

No	<input type="checkbox"/> Active	IP address	MAC address
1	<input type="checkbox"/>	<input type="text"/>	<input type="text"/>
2	<input type="checkbox"/>	<input type="text"/>	<input type="text"/>
3	<input type="checkbox"/>	<input type="text"/>	<input type="text"/>
4	<input type="checkbox"/>	<input type="text"/>	<input type="text"/>

DHCP server (AP only)

Setting	Description	Factory Default
Enable	Enables AWK-5232-M12-RCC as a DHCP server	Disable
Disable	Disable DHCP server function	

Default gateway

Setting	Description	Factory Default
IP address of a default gateway	The IP address of the router that connects to an outside network	None

Subnet mask

Setting	Description	Factory Default
subnet mask	Identifies the type of sub-network (e.g., 255.255.0.0 for a Class B network, or 255.255.255.0 for a Class C network)	None

Primary/ Secondary DNS server

Setting	Description	Factory Default
IP address of Primary/ Secondary DNS server	The IP address of the DNS Server used by your network. After entering the DNS Server’s IP address, you can use URL as well. The Secondary DNS server will be used if the Primary DNS server fails to connect.	None

Start IP address

Setting	Description	Factory Default
IP address	Indicates the IP address which AWK-5232-M12-RCC can start assigning.	None

Maximum number of users

Setting	Description	Factory Default
1 – 999	Specifies how many IP address can be assigned continuously	None

Client lease time

Setting	Description	Factory Default
1 – 10 days	The lease time for which an IP address is assigned. The IP address may go expired after the lease time is reached.	10 (days)

Packet Filters

The AWK-5232-M12-RCC includes various filters for **IP-based** packets going through LAN and WLAN interfaces. You can set these filters as a firewall to help enhance network security.

MAC Filter

The AWK-5232-M12-RCC’s MAC filter is a policy-based filter that can allow or filter out IP-based packets with specified MAC addresses. The AWK-5232-M12-RCC provides 8 entities for setting MAC addresses in your filtering policy. Remember to check the **Active** check box for each entity to activate the setting.

MAC Filters

Enable

Policy

No	<input type="checkbox"/> Active	Name	MAC address
1	<input type="checkbox"/>	<input type="text"/>	<input type="text"/>
2	<input type="checkbox"/>	<input type="text"/>	<input type="text"/>
3	<input type="checkbox"/>	<input type="text"/>	<input type="text"/>

Enable

Setting	Description	Factory Default
Enable	Enables MAC filter	Disable
Disable	Disables MAC filter	

Policy

Setting	Description	Factory Default
Accept	Only the packets fitting the entities on list can be allowed.	Drop
Drop	Any packet fitting the entities on list will be denied.	



ATTENTION

Be careful when you enable the filter function:

Drop + “no entity on list is activated” = all packets are **allowed**

Accept + “no entity on list is activated” = all packets are **denied**

IP Protocol Filter

The AWK-5232-M12-RCC's IP protocol filter is a policy-based filter that can allow or filter out IP-based packets with specified IP protocol and source/destination IP addresses.

The AWK-5232-M12-RCC provides 8 entities for setting IP protocol and source/destination IP addresses in your filtering policy. Four IP protocols are available: **All**, **ICMP**, **TCP**, and **UDP**. You must specify either the Source IP or the Destination IP. By combining IP addresses and netmasks, you can specify a single IP address or a range of IP addresses to accept or drop. For example, "IP address 192.168.1.1 and netmask 255.255.255.255" refers to the sole IP address 192.168.1.1. "IP address 192.168.1.1 and netmask 255.255.255.0" refers to the range of IP addresses from 192.168.1.1 to 192.168.255. Remember to check the **Active** check box for each entity to activate the setting.

IP Protocol Filters

Enable

Policy

No	<input type="checkbox"/> Active	Protocol	Source IP	Source netmask	Destination IP	Destination netmask
1	<input type="checkbox"/>	All				
2	<input type="checkbox"/>	All				
3	<input type="checkbox"/>	All				

Enable

Setting	Description	Factory Default
Enable	Enables IP protocol filter	Disable
Disable	Disables IP protocol filter	

Policy

Setting	Description	Factory Default
Accept	Only the packets fitting the entities on the list can be allowed	Drop
Drop	Any packet fitting the entities on the list will be denied	



ATTENTION

Be careful when you enable the filter function:

Drop + "no entity on list is activated" = all packets are **allowed**.

Accept + "no entity on list is activated" = all packets are **denied**.

TCP/UDP Port Filter

The AWK-5232-M12-RCC's TCP/UDP port filter is a policy-based filter that can allow or filter out TCP/UDP-based packets with a specified source or destination port.

The AWK-5232-M12-RCC provides 8 entities for setting the range of source/destination ports of a specific protocol. In addition to selecting TCP or UDP protocol, you can set either the source port, destination port, or both. The end port can be left empty if only a single port is specified. Of course, the end port cannot be larger than the start port.

The **Application name** is a text string that describes the corresponding entity with up to 31 characters. Remember to check the **Active** check box for each entity to activate the setting.

TCP/UDP Port Filters

Enable

Policy

No	<input type="checkbox"/> Active	Source port	Destination port	Protocol	Application name
1	<input type="checkbox"/>	<input type="text"/> ~ <input type="text"/>	<input type="text"/> ~ <input type="text"/>	TCP	<input type="text"/>
2	<input type="checkbox"/>	<input type="text"/> ~ <input type="text"/>	<input type="text"/> ~ <input type="text"/>	TCP	<input type="text"/>
3	<input type="checkbox"/>	<input type="text"/> ~ <input type="text"/>	<input type="text"/> ~ <input type="text"/>	TCP	<input type="text"/>

Enable

Setting	Description	Factory Default
Enable	Enables TCP/UDP port filter	Disable
Disable	Disables TCP/UDP port filter	

Policy

Setting	Description	Factory Default
Accept	Only the packets fitting the entities on list can be allowed.	Drop
Drop	Any packet fitting the entities on list will be denied.	



ATTENTION

Be careful when you enable the filter function:

Drop + "no entity on list is activated" = all packets are **allowed**

Accept + "no entity on list is activated" = all packets are **denied**

RSTP Settings (for Master, Slave, or ACC mode only)

AWK-5232-M12-RCC supports IEEE802.1D Spanning Tree Protocol and IEEE802.1w Rapid STP standards. In addition to eliminating unexpected path looping, STP/RSTP can provide a backup path recovery if a wired/wireless path fails accidentally. The reliability and availability can increase because this fail-over function.

AWK-5232-M12-RCC's STP/RSTP feature is disabled by default. To be completely effective, you must enable RSTP/STP on every AWK-5232-M12-RCC connected to your network.

The following figures indicate which Spanning Tree Protocol parameters can be configured. A more detailed explanation of each parameter is given below the figure.

RSTP Settings (for Master or Slave mode only)

Bridge priority

Hello time (1~10 seconds)

Forwarding delay (4~30 seconds)

Max age (6~40 seconds)

No	<input type="checkbox"/> Enable RSTP	Port Priority	Port Cost	<input type="checkbox"/> Edge Port
1 LAN 1	<input type="checkbox"/>	128	200000	<input type="checkbox"/>
2 LAN 2	<input type="checkbox"/>	128	200000	<input type="checkbox"/>
3 WLAN 1 : Master	<input type="checkbox"/>	128	2000000	<input type="checkbox"/>
4 WLAN 2 : Slave	<input type="checkbox"/>	128	2000000	<input type="checkbox"/>

RSTP status

This field will appear only when selected to operate STP/RSTP. It indicates whether this AWK-5232-M12-RCC is the Root of the Spanning Tree (the root is determined automatically) or not.

Bridge priority

Setting	Description	Factory Default
Numerical value selected by user	You can increase the bridge priority by selecting a lower number. A higher bridge priority brings a greater chance of being established as the root of the Spanning Tree topology.	32768

Hello time

Setting	Description	Factory Default
Numerical value input by user (1 – 10 seconds)	The root of the Spanning Tree topology periodically sends out a "hello" message to other devices on the network to check if the topology is healthy. Hello time indicates how often the root sends hello messages.	2 (seconds)

Forwarding delay

Setting	Description	Factory Default
Numerical value input by user (4 – 30 seconds)	The amount of time this device waits before checking to see if it should change to a different topology.	15 (seconds)

Max. age

Setting	Description	Factory Default
Numerical value input by user (6 – 40 seconds)	As a non-root role, if the device has not received a hello message from the root longer than Max. age , it will reconfigure itself as a root. Once two or more devices on the network are recognized as a root, the devices will renegotiate to set up a new Spanning Tree topology.	20 (seconds)

Enable RSTP

Setting	Description	Factory Default
Enable/ disable	Enables or disables the port as a node on the Spanning Tree topology.	Disable (unchecked)

Port priority

Setting	Description	Factory Default
Numerical value selected by user	Increase this port's priority as a node on the Spanning Tree topology by inputting a lower number.	128

Port cost

Setting	Description	Factory Default
Enable/ Disable	Input a higher cost to indicate that this port is less suitable as a node for the Spanning Tree topology	20000

Edge port

Setting	Description	Factory Default
Checked/ unchecked	Sets a port, which no BPDU expectedly goes through, as an edge port	unchecked, except WLAN1/2 ports

NOTE We recommend you set an edge port for the port, which is connected to a non-STP/RSTP sub-network or an end device (PLC, RTU, etc.) as opposed to network equipment. This can prevent unnecessary waiting and negotiation of STP/RSTP protocol, and accelerate system initialization. When an edge port receives BPDUs, it can still function as an STP/RSTP port and start negotiation. Setting an edge port is different from disabling STP/RSTP on a port. If you disable STP/RSTP, a port will not deal with STP/RSTP BPDUs at all.

Port Status

Port Status indicates the current Spanning Tree status of this port. Use **Forwarding** for normal transmission, or **Blocking** to block transmission.

SNMP Agent

The AWK-5232-M12-RCC supports SNMP V1/V2c/V3. SNMP V1 and SNMP V2c use a community string match for authentication, which means that SNMP servers access all objects with read-only or read/write permissions using the community string *public/private* (default value). SNMP V3, which requires you to select an authentication level of MD5 or SHA, is the most secure protocol. You can also enable data encryption to enhance data security.

The AWK-5232-M12-RCC's MIB can be found in the software CD and supports reading the attributes via SNMP. (Only *get* method is supported.)

SNMP security modes and security levels supported by the AWK-5232-M12-RCC are shown in the following table. Select the security mode and level that will be used to communicate between the SNMP agent and manager.

Protocol Version	Setting on UI web page	Authentication Type	Data Encryption	Method
SNMP V1, V2c	V1, V2c Read Community	Community string	No	Use a community string match for authentication
	V1, V2c Write/Read Community	Community string	No	Use a community string match for authentication
SNMP V3	No-Auth	No	No	Use account with admin or user to access objects
	MD5 or SHA	Authentication based on MD5 or SHA	No	Provides authentication based on HMAC-MD5, or HMAC-SHA algorithms. 8-character passwords are the minimum requirement for authentication.
	MD5 or SHA	Authentication based on MD5 or SHA	Data encryption key	Provides authentication based on HMAC-MD5 or HMAC-SHA algorithms, and data encryption key. 8-character passwords and a data encryption key are the minimum requirements for authentication and encryption.

The following parameters can be configured on the **SNMP Agent** page. A more detailed explanation of each parameter is given below the following figure.

SNMP Agent

Enable

Read community

Write community

SNMP agent version

Admin auth type

Admin privacy key

Privacy key

Private MIB information

Device object ID

Enable

Setting	Description	Factory Default
Enable	Enables SNMP Agent	Disable
Disable	Disables SNMP Agent	

Read community (for V1, V2c, V3 or V1, V2c)

Setting	Description	Factory Default
Read Community	Use a community string match with a maximum of 31 characters for authentication. This means that the SNMP agent can access all objects with read-only permissions using this community string.	public

Write community (for V1, V2c, V3 or V1, V2c)

Setting	Description	Factory Default
Read /Write Community	Use a community string match with a maximum of 31 characters for authentication. This means that the SNMP agent can accesses all objects with read/write permissions using this community string.	private

SNMP agent version

Setting	Description	Factory Default
V1, V2c, V3, or V1, V2c, or V3 only	Select the SNMP protocol version used to manage the switch.	V1, V2c

Admin auth type (for V1, V2c, V3, and V3 only)

Setting	Description	Factory Default
No Auth	Use admin account to access objects. No authentication	No Auth
MD5	Provide authentication based on the HMAC-MD5 algorithms. 8-character passwords are the minimum requirement for authentication.	
SHA	Provides authentication based on HMAC-SHA algorithms. 8-character passwords are the minimum requirement for authentication.	

Admin private key (for V1, V2c, V3, and V3 only)

Setting	Description	Factory Default
Disable	No data encryption	Disable
DES	DES-based data encryption	
AES	AES-based data encryption	

Private Key

A data encryption key is the minimum requirement for data encryption (maximum of 63 characters)

Private MIB Information Device Object ID

Also know as **OID**. This is the AWK-5232-M12-RCC's enterprise value. It is fixed.

Storm Protection

In general, one host should not be allowed to occupy unlimited bandwidth, particularly when the device malfunctions. For example, so-called "broadcast storms" could be caused by an incorrectly configured topology or a malfunctioning device.

Storm Protection

Storm protection Enable Disable

Multicast & flooding Enable Disable

Storm Protection

Setting	Description	Factory Default
Enable/Disable	Enable or disable Broadcast Storm Protection globally for multicast packets	Enable

Multicast and flooding

Setting	Description	Factory Default
Enable/Disable	If you enable Storm Protection, the Multicast and flooding option will show up. You can Enable or Disable Broadcast Storm Protection globally for unknown multicast and unknown unicast packets.	Disable

Link Fault Pass-Through (for Client/Slave mode only)

This function means if Ethernet port is link down, wireless connection will be forced to disconnect. Once Ethernet link is recovered, AWK will try to connect to AP.

If wireless is disconnected, AWK restarts auto-negotiation on Ethernet port but always stays in the link failure state. Once the wireless connection is recovered, AWK will try to recover the Ethernet link.

System log will indicate the link fault pass through events in addition to the original link up/down events.

Link Fault Pass-Through (for Client/Slave mode only)

Link Fault Pass-Through Enable Disable

Submit

Link Fault Pass-Through

Setting	Description	Factory Default
Enable	Enables Link Fault Pass-Through	Disable
Disable	Disables Link Fault Pass-Through	

CCU Alive Time Settings

You can enable the CCU Alive Check feature to redirect connected clients to the default landing page when the central control unit (CCU) becomes unavailable. You can upload the web page or graphic for the default landing page that serves as an out-of-service notice.

CCU Alive Check Settings

CCU alive check enable

CCU ping host

CCU ping timeout (1~5 seconds)

CCU ping interval (1~5 seconds)

CCU ping number of attempts (1~10 times)

CCU reboot count (0~5 times)

CCU station's DHCP server IP

Submit

Web Page Import

Select web page

Upload File Remove File

GIF File Import

Select gif file

Upload File

Remove File

CCU alive check enable

Setting	Description	Factory Default
Enable/Disable	Enable or disable the CCU Alive check function.	Disable

CCU ping host

Setting	Description	Factory Default
IP address	Set the IP address of the CCU to which the AWK sends ping requests for alive check.	empty

CCU ping timeout

Setting	Description	Factory Default
1 to 5 sec.	The ping reply timeout duration for the AWK to determine the availability of the CCU.	1

CCU ping interval

Setting	Description	Factory Default
1 to 5 sec.	The time between ping attempts.	1

CCU ping number of attempts

Setting	Description	Factory Default
1 to 10 times	The time between ping attempts. The CCU is considered as unavailable when it fails to respond to all ping attempts.	5

CCU reboot count

Setting	Description	Factory Default
0 to 5 times	This setting will set the AWK to reboot when the CCU is determined to be unavailable. This is an attempt to recover the AWK should it be the failed node on the network.	1

CCU stations' DHCP server IP

Setting	Description	Factory Default
IP Address	The IP address of the AWK that is the DHCP server when the CCU is not available.	empty

Web/GIF Import

Setting	Description	Factory Default
Web/GIF File	Import the landing page. The landing page is allowed to display 1 imported GIF image.	empty

NAT/Port Forwarding

Set the NAT/Port Forwarding settings to allow the AWK to route specified outgoing and incoming traffic to other subnets. You can select the port forwarding protocol and enter the WAN port whose traffic the AWK forwards to a device with the defined LAN port and IP address.

NAT/Port Forwarding

NAT enable Enable ▼

No	Active	Protocol	WAN port	LAN IP	LAN port
1	<input type="checkbox"/>	TCP ▼	<input type="text"/>	<input type="text"/>	<input type="text"/>
2	<input type="checkbox"/>	TCP ▼	<input type="text"/>	<input type="text"/>	<input type="text"/>
3	<input type="checkbox"/>	TCP ▼	<input type="text"/>	<input type="text"/>	<input type="text"/>
4	<input type="checkbox"/>	TCP ▼	<input type="text"/>	<input type="text"/>	<input type="text"/>
5	<input type="checkbox"/>	TCP ▼	<input type="text"/>	<input type="text"/>	<input type="text"/>
6	<input type="checkbox"/>	TCP ▼	<input type="text"/>	<input type="text"/>	<input type="text"/>
7	<input type="checkbox"/>	TCP ▼	<input type="text"/>	<input type="text"/>	<input type="text"/>
8	<input type="checkbox"/>	TCP ▼	<input type="text"/>	<input type="text"/>	<input type="text"/>

Auto Warning Settings

Since industrial-grade devices are often located at the endpoints of a system, these devices will not always know what is happening elsewhere on the network. This means that these devices, including wireless APs or clients, must provide system maintainers with real-time alarm messages. Even when system administrators are out of the control room for an extended period, they can still be informed of the status of devices almost instantaneously when exceptions occur.

In addition to logging these events, the AWK-5232-M12-RCC supports different approaches to warn engineers automatically, such as SNMP trap, e-mail, and relay output. It also supports two digital inputs to integrate sensors into your system to automate alarms by email and relay output.

System Log

System Log Event Types

Detail information for grouped events is shown in the following table. You can check the box for **Enable log** to enable the grouped events. All default values are enabled (checked). The log for system events can be seen in **Status → System Log**.

System log Event Types

Event group	Enable log
System-related events	<input checked="" type="checkbox"/>
Network-related events	<input checked="" type="checkbox"/>
Config-related events	<input checked="" type="checkbox"/>
Power events	<input checked="" type="checkbox"/>
DI events	<input checked="" type="checkbox"/>

System-related events	Event is triggered when...
System restart (warm start)	The AWK-5232-M12-RCC is rebooted, such as when its settings are changed (IP address, subnet mask, etc.).
Network-related events	Event is triggered when...
LAN 1 or LAN 2 link on	The LAN port is connected to a device or network.
LAN 1 or LAN 2 link off	The port is disconnected (e.g., the cable is pulled out, or the opposing device shuts down).
Client joined/ left for WLAN 1 or WLAN 2 (for AP or Master mode)	A wireless client is associated or disassociated.
WLAN 1 or WLAN 2 connected to AP (Client or Slave mode)	The AWK-5232-M12-RCC is associated with an AP.
WLAN 1 or WLAN 2 disconnected (Client or Slave mode)	The AWK-5232-M12-RCC is disassociated from an AP.
Config-related events	Event is triggered when...
Configuration Changed	A configuration item has been changed.
Configuration file import via Web Console	The configuration file is imported to the AWK-5232-M12-RCC.
Console authentication failure	An incorrect password is entered.
Firmware upgraded	The AWK-5232-M12-RCC's firmware is updated.
Power events	Event is triggered when...
Power 1/2 transition (On → Off)	The AWK-5232-M12-RCC is powered down in PWR1/2.
PoE transition (On → Off)	The AWK-5232-M12-RCC is powered down in PoE.
Power 1/2 transition (Off → On)	The AWK-5232-M12-RCC is powered via PWR1/2.
PoE transition (Off → On)	The AWK-5232-M12-RCC is powered via PoE.
DI events	Event is triggered when...
DI1/2 transition (On → Off)	Digital Input 1/2 is triggered by on to off transition
DI1/2 transition (Off → On)	Digital Input 1/2 is triggered by off to on transition

Syslog

This function provides the event logs for the Syslog server. The function supports up to three configurable Syslog servers and Syslog server UDP port numbers. When an event occurs, the event will be sent as a Syslog UDP packet to the specified Syslog servers.

Syslog Event Types

Detail information for the grouped events is shown in the following table. You can check the box for **Enable log** to enable the grouped events. All default values are enabled (checked). Details for each event group can be found on the "System log Event Types" table on page 3-31.

Syslog Event Types

Event group	Enable log
System-related events	<input checked="" type="checkbox"/>
Network-related events	<input checked="" type="checkbox"/>
Config-related events	<input checked="" type="checkbox"/>
Power events	<input checked="" type="checkbox"/>
DI events	<input checked="" type="checkbox"/>

Syslog Server Settings

You can configure the parameters for your Syslog servers in this page.

Syslog Server Settings

Syslog server 1	<input type="text"/>
Syslog port	<input type="text" value="514"/>
Syslog server 2	<input type="text"/>
Syslog port	<input type="text" value="514"/>
Syslog server 3	<input type="text"/>
Syslog port	<input type="text" value="514"/>

Syslog server 1 / 2 / 3

Setting	Description	Factory Default
IP address	Enter the IP address of the 1st/ 2nd/ 3rd Syslog Server	None

Syslog port

Setting	Description	Factory Default
Port destination (1 to 65535)	Enter the UDP port of the corresponding Syslog server	514

E-mail

E-mail Event Types

Check the box for **Active** to enable the event items. All default values are deactivated (unchecked). Details for each event item can be found on the "System log Event Types" table on page 3-39.

E-mail Event Types

Event	<input type="checkbox"/> Active
Cold start	<input type="checkbox"/>
Warm start	<input type="checkbox"/>
Power 1 transition (On-->Off)	<input type="checkbox"/>
Power 1 transition (Off-->On)	<input type="checkbox"/>
Power 2 transition (On-->Off)	<input type="checkbox"/>
Power 2 transition (Off-->On)	<input type="checkbox"/>
PoE transition (On-->Off)	<input type="checkbox"/>
PoE transition (Off-->On)	<input type="checkbox"/>
Configuration changed	<input type="checkbox"/>
Console authentication failure	<input type="checkbox"/>
DI 1 transition (On-->Off)	<input type="checkbox"/>
DI 1 transition (Off-->On)	<input type="checkbox"/>
DI 2 transition (On-->Off)	<input type="checkbox"/>
DI 2 transition (Off-->On)	<input type="checkbox"/>
LAN 1 link On	<input type="checkbox"/>
LAN 1 link Off	<input type="checkbox"/>
LAN 2 link On	<input type="checkbox"/>
LAN 2 link Off	<input type="checkbox"/>

E-mail Server Settings

You can set up to 4 e-mail addresses to receive alarm emails from the AWK-5232-M12-RCC. The following parameters can be configured on the **E-mail Server Settings** page. In addition, a **Send Test Mail** button can be used to test whether the Mail server and e-mail addresses work well. More detailed explanations about these parameters are given after the following figure.

E-mail Server Settings

Mail server (SMTP)

User name

Password

From e-mail address

To e-mail address 1

To e-mail address 2

To e-mail address 3

To e-mail address 4

Mail server (SMTP)

Setting	Description	Factory Default
IP address	The IP Address of your email server.	None

User name & Password

Setting	Description	Factory Default
	User name and password used in the SMTP server	None

From e-mail address

Setting	Description	Factory Default
Max. 63 characters	Enter the administrator's e-mail address which will be shown in the "From" field of a warning e-mail.	None

To E-mail address 1/ 2/ 3/ 4

Setting	Description	Factory Default
Max. 63 characters	Enter the receivers' e-mail addresses.	None

Relay

The AWK-5232-M12-RCC has one relay output, which consists of 2 terminal block contacts on the AWK-5232-M12-RCC's top panel. These relay contacts are used to indicate user-configured events and system failure.

The two wires attached to the relay contacts form an open circuit when a user-configured event is triggered. If a user-configured event does not occur, the relay circuit will remain closed. For safety reasons, the relay circuit is kept open when the AWK-5232-M12-RCC is not powered.

Relay Event Types

You can check the box for **Active** to enable the event items. All default values are deactivated (unchecked). Details for each event item can be found in the “System log Event Types” table on page 3-31.

Relay Event Types

Event	Active
Power 1 transition (On-->Off)	<input type="checkbox"/>
Power 2 transition (On-->Off)	<input type="checkbox"/>
PoE transition (On-->Off)	<input type="checkbox"/>
DI 1 transition (On-->Off)	<input type="checkbox"/>
DI 1 transition (Off-->On)	<input type="checkbox"/>
DI 2 transition (On-->Off)	<input type="checkbox"/>
DI 2 transition (Off-->On)	<input type="checkbox"/>
LAN 1 link On	<input type="checkbox"/>
LAN 1 link Off	<input type="checkbox"/>
LAN 2 link On	<input type="checkbox"/>
LAN 2 link Off	<input type="checkbox"/>

Trap

Traps can be used to signal abnormal conditions (notifications) to a management station. This trap-driven notification can make your network more efficient.

Because a management station usually takes care of a large number of devices that have a large number of objects, it will be overloading for the management station to poll or send requests to query every object on every device. It would be better if the managed device agent could notify the management station by sending a message known as a trap for the event.

Trap Event Types

Trap Event Types

Event	<input type="checkbox"/> Active
Cold start	<input type="checkbox"/>
Warm start	<input type="checkbox"/>
Power 1 transition (On-->Off)	<input type="checkbox"/>
Power 1 transition (Off-->On)	<input type="checkbox"/>
Power 2 transition (On-->Off)	<input type="checkbox"/>
Power 2 transition (Off-->On)	<input type="checkbox"/>
PoE transition (On-->Off)	<input type="checkbox"/>
PoE transition (Off-->On)	<input type="checkbox"/>
Configuration changed	<input type="checkbox"/>
Console authentication failure	<input type="checkbox"/>
DI 1 transition (On-->Off)	<input type="checkbox"/>
DI 1 transition (Off-->On)	<input type="checkbox"/>
DI 2 transition (On-->Off)	<input type="checkbox"/>
DI 2 transition (Off-->On)	<input type="checkbox"/>
LAN 1 link On	<input type="checkbox"/>
LAN 1 link Off	<input type="checkbox"/>
LAN 2 link On	<input type="checkbox"/>
LAN 2 link Off	<input type="checkbox"/>

SNMP Trap Receiver Settings

SNMP traps are defined in SMIV1 MIBs (SNMPv1) and SMIV2 MIBs (SNMPv2c). The two styles are basically equivalent, and it is possible to convert between the two. You can set the parameters for SNMP trap receivers through the web page.

SNMP Trap Receiver Settings

1st Trap version

1st Trap server IP/name

1st Trap community

2nd Trap version

2nd Trap server IP/name

2nd Trap community

1st / 2nd Trap version

Setting	Description	Factory Default
V1	SNMP trap defined in SNMPv1	V1
V2	SNMP trap defined in SNMPv2	

1st / 2nd Trap server IP/name

Setting	Description	Factory Default
IP address or host name	Enter the IP address or name of the trap server used by your network.	None

1st / 2nd Trap community

Setting	Description	Factory Default
Max. 31 characters	Use a community string match with a maximum of 31 characters for authentication.	alert

Status

Wireless Status

The status for **802.11 info** parameters, such as Operation mode and Channel, are shown on the **Wireless Status** page. The status will refresh every 5 seconds if the **Auto refresh** box is checked.

Certain values for **802.11 info** may not appear with different operation modes. For example, **Current BSSID** and **RSSI** are not available in AP or Master modes.

It is helpful to use the continuously updated information option on this page, such as RSSI, to monitor the signal strength of the AWK-5232-M12-RCC in Redundant Client or Slave modes. ACC connection status information, including target surveys and connection states, can also be monitors on this status page.

Wireless Status

Auto refresh

Show status of WLAN 1 (SSID: MOXA_1) ▼

802.11 Info	
Operation mode	AP-Client - AP (WLAN 1)
Channel	6
RF type	B/G/N Mixed
SSID	MOXA_1
MAC	06:90:E8:2C:FE:1D
Security mode	OPEN
Current BSSID	06:90:E8:2C:FE:1D
Signal strength	N/A
Transmission rate	Auto
Transmission power	10 dBm
ACC state	N/A
ACC target	N/A

Associated Client List (for AP/Master/ACC modes only)

Associated Client List shows all the clients that are currently associated to a particular AWK-5232-M12-RCC. You can click **Select all** to select all the content in the list for further editing. You can click **Refresh** to refresh the list.

Associated Client List (for Redundant AP, AP, or Master mode only)

Show clients for WLAN 1 (SSID: MOXA_1) ▾

WLAN 1 (SSID: MOXA_1)

WLAN 2 (SSID: MOXA_2)

Select All Refresh

DHCP Client List (for AP mode only)

When you enable the DHCP server, the DHCP Client List shows all the clients that require and have successfully received IP assignments. You can click the **Refresh** button to refresh the list.

DHCP Client List

	MAC	IP
1.	00:13:ce:e1:ee:ef	192.168.127.2

Select all Refresh

You can press **Select all** button to select all content in the list for further editing.

	MAC	IP
1.	00:13:ce:e1:ee:ef	192.168.127.2

Cut

Copy

Paste

Select All

Print

Select all Refresh

System Log

Triggered events are recorded in System Log. You can export the log contents to an available viewer by clicking **Export Log**. You can use the **Clear Log** button to clear the log contents and the **Refresh** button to refresh the log.

System log

```
( 196) 2009/06/18,16h:31m:52s Power 1 transition (Off -> On)
( 197) 2009/06/18,16h:32m:16s LAN 1 link on
( 198) 2009/06/18,16h:32m:17s LAN 2 link on
( 199) 2009/06/18,16h:32m:33s RSTP topology changed
( 200) 2009/06/18,16h:32m:33s LAN 1 link off
( 201) 2009/06/18,16h:32m:34s LAN 2 link off
( 202) 2009/06/18,16h:32m:43s LAN 1 link on
( 203) 2009/06/18,16h:32m:45s LAN 2 link on
( 204) 2009/06/18,16h:33m:13s RSTP topology changed
( 205) 2009/06/18,16h:33m:53s RSTP topology changed
( 206) 2009/06/18,16h:34m:31s RSTP topology changed
( 207) 2009/06/18,16h:35m:09s RSTP topology changed
( 208) 2009/06/18,19h:10m:17s System cold start
( 209) 2009/06/18,19h:10m:17s Power 1 transition (Off -> On)
( 210) 2009/06/18,19h:10m:53s LAN 1 link on
( 211) 2009/06/18,19h:11m:01s LAN 1 link off
( 212) 2009/06/18,19h:11m:08s LAN 2 link on
( 213) 2009/06/18,19h:11m:39s RSTP topology changed
```

Export Log Clear Log Refresh

Relay Status

The status of user-configurable events can be found under **Relay Status**. The status will refresh every 5 seconds if the **Auto refresh** box is checked.

If an event is triggered, it will be noted on this list. System administrators can click **Acknowledge Event** when he has acknowledged the event and addressed it.

Relay Status

Auto refresh

Relay Status		
Power 1 transition (On-->Off)	---	Acknowledge Event
Power 2 transition (On-->Off)	---	Acknowledge Event
PoE transition (On-->Off)	---	Acknowledge Event
DI 1 transition (On-->Off)	---	Acknowledge Event
DI 1 transition (Off-->On)	---	Acknowledge Event
DI 2 transition (On-->Off)	---	Acknowledge Event
DI 2 transition (Off-->On)	---	Acknowledge Event
LAN 1 link On	---	Acknowledge Event
LAN 1 link Off	---	Acknowledge Event
LAN 2 link On	---	Acknowledge Event
LAN 2 link Off	---	Acknowledge Event

DI and Power Status

The status of power inputs and digital inputs is shown on this web page. The status will refresh every 5 seconds if the **Auto refresh** box is checked.

Din and Power status

Auto refresh

Input status	On / Off
Power 1 status	On
Power 2 status	Off
PoE status	Off
DI 1 status	Off
DI 2 status	Off

Maintenance

Maintenance functions provide the administrator with tools to manage the AWK-5232-M12-RCC and wired/wireless networks.

Console Settings

You can enable or disable access permission for the following consoles: HTTP, HTTPS, Telnet and SSH connections. For more security, we recommend you only allow access to the two secured consoles, HTTPS and SSH.

Console Settings

- HTTP console Enable Disable
- HTTPS console Enable Disable
- Telnet console Enable Disable
- SSH console Enable Disable

Ping

Ping helps to diagnose the integrity of wired or wireless networks. By inputting a node's IP address in the **Destination** field, you can use the **ping** command to make sure it exists and whether or not the access path is available.

Ping

Destination

If the node and access path are available, you will see that all packets were successfully transmitted with no loss. Otherwise, some, or even all, packets may get lost, as shown in the following figure.

Ping

Destination

PING 192.168.127.2 (192.168.127.2): 56 data bytes

--- 192.168.127.2 ping statistics ---

4 packets transmitted, 0 packets received, 100% packet loss

Firmware Upgrade

The AWK-5232-M12-RCC can be enhanced with more value-added functions by installing firmware upgrades. The latest firmware is available at Moxa's download center.

Before running a firmware upgrade, make sure the AWK-5232-M12-RCC is off-line. Click the **Browse** button to specify the firmware image file and click **Firmware Upgrade and Restart** to start the firmware upgrade. After the progress bar reaches 100%, the AWK-5232-M12-RCC will reboot itself.

When upgrading your firmware, the AWK-5232-M12-RCC's other functions are forbidden.

Firmware Upgrade

Select update image



ATTENTION

Please make sure the power source is stable when you upgrade your firmware. An unexpected power breakup may damage your AWK-5232-M12-RCC.

Config Import Export

You can back up or restore the AWK's configuration with **Config Import Export**.

In the **Config Import** section, click **Browse** to specify the configuration file and click **Config Import** button to begin importing the configuration.

Config Export

You can also back up or restore the ABC-01 (HW Rev. 1.1 support only) configuration with **Config Import Export**.

ABC-01 Import

ABC-01 Export

To download the configuration to the AWK:

1. Turn off the AWK.
2. Plug in the ABC-01 to the AWK's RS-232 console.
3. Turn on AWK.
4. AWK will detect ABC-01 during bootup, and download the configuration from the ABC-01 to the AWK automatically. Once the configuration downloads and if configuration format is correct, the AWK will emit three short beeps, then continue the boot up.
5. Once the AWK has booted up successfully, it will emit the normal two beeps, and the ready LED will turn to solid green.

SNMP MIB file Export

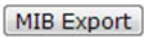

SNMP MIB file for AWK is embedded in the device. To export the MIB file, simply click on the "MIB Export" button and save it to your local drive.

Default Config Import

You can use the **Default Config Import** screen to import a default configuration file on the AWK. This default configuration file is used when you reset the AWK to the defaults.

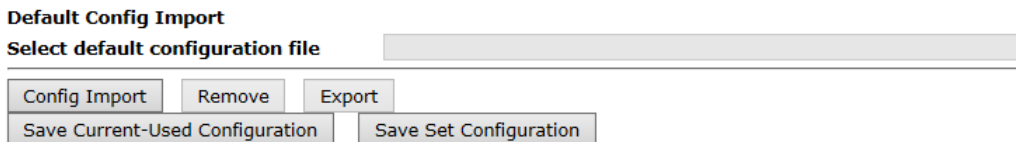

Hint:
 "Save Current-Used Configuration" saves the current running configuration as customized default configuration.
 "Save Set Configuration" saves the set configuration shown on UI as customized default configuration.

Load Factory Default

Use this function to reset the AWK and roll all settings back to the factory or customized (using imported configuration file in the **Default Config Import** screen) default values. You can also reset the hardware by pressing the reset button on the top panel of the AWK.

Load Factory Default



Click **Activate** to reset all settings, including the console password, to the factory default values.

The system will be restarted immediately.

Note that the customized default config will be removed.

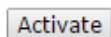

Click **Activate** to reset all settings, including the console password, to the **customized** default values.

The system will be restarted immediately.

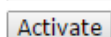

Password

You can change the administration password for each of the AWK-5232-M12-RCC's console managers by using the **Password** function. Before you set up a new password, you must input the current password and reenter the new password for confirmation. For your security, do not use the default password *moxa*, and remember to change the administration password regularly.

NOTE Firmware Version 1.6 password: moxa
 Firmware Versions 1.0 to 1.5 password: root

Password

Current password

New password

Confirm password

Misc. Settings

Additional settings to help you manage your AWK-5232-M12-RCC, are available on this page.

Misc. Settings

Reset button Always enable Disable after 60 sec

Reset button

Setting	Description	Factory Default
Always enable	The AWK-5232-M12-RCC's Reset button works normally.	Always enable
Disable after 60 sec	The AWK-5232-M12-RCC's Reset button will become invalid 60 seconds after the AWK-5232-M12-RCC completes booting.	

Save Configuration

The following figure shows how the AWK-5232-M12-RCC stores the setting changes into volatile and non-volatile memory. All data stored in volatile memory will disappear when the AWK-5232-M12-RCC is shutdown or rebooted unless they are **y**. Because the AWK-5232-M12-RCC starts up and initializes with the settings stored in flash memory, all new changes must be saved to flash memory before restarting the AWK-5232-M12-RCC.

This also means the new changes will not work unless you run either the **Save Configuration** function or the **Restart** function.

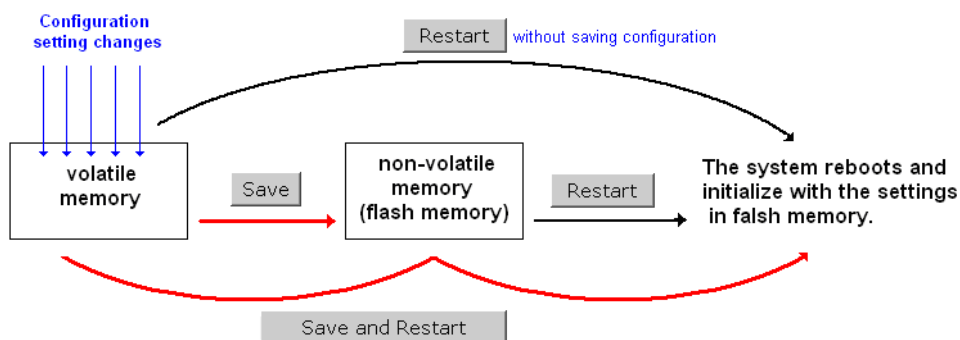

After you click on **Save Configuration** in the left menu box, the following screen will appear. Click **Save** if you wish to update the configuration settings in the flash memory at this time. Alternatively, you may choose to run other functions and put off saving the configuration until later. However, the new setting changes will remain in the non-volatile memory until you save the configurations.

Save Configuration

If you have submitted any configuration changes, you must save the changes and restart the system before they take effect. Click **Save** to save the changes in AWK-5222-US's memory. Click **Restart** to activate new settings in the navigation panel.

Restart

If you submitted configuration changes, you will find a blinking string in the upper right corner of the screen. After making all your changes, click the **Restart** function in the left menu box. One of two different screens will appear.

If you made changes recently but did not save, you will be given two options. Clicking the **Restart** button here will reboot the AWK-5232-M12-RCC directly, and all setting changes will be ignored. Clicking the **Save and Restart** button will apply all setting changes and then reboot the AWK-5232-M12-RCC.

Restart

!!! Warning !!!

Click "Restart" to discard changes and reboot AWK-5232-US directly.

Click "Save and Restart" to apply all setting changes and reboot AWK-5232-US.

If you run the **Restart** function without changing any configurations or saving all your changes, you will see just one **Restart** button on your screen.

Restart

!!! Warning !!!

Clicking Restart will disconnect all Ethernet connections and reboot AWK-5232-US.

You will not be able to run any of the AWK-5232-M12-RCC's functions while the system is rebooting.

Logout

Logout helps users disconnect the current HTTP or HTTPS session and go to the Login page. For security reasons, we recommend you logout before quitting the console manager.

Logout

Click **Logout** button to default Login page.

Software Installation/Configuration

The following topics are covered in this chapter:

- **Overview**
- **AWK Search Utility**
 - Installing AWK Search Utility
 - Configuring AWK Search Utility

Overview

The Documentation & Software CD included with your AWK-5232-M12-RCC is designed to make the installation and configuration procedure easy and straightforward. This auto-run CD includes AWK Search Utility (to broadcast search for all AWK's accessible over the network), the AWK-5232-M12-RCC User's Manual, and Quick Installation Guide.

AWK Search Utility

Installing AWK Search Utility

1. Click the **INSTALL UTILITY** button in the AWK Installation CD auto-run window to install AWK Search Utility. Once the program starts running, click **Yes** to proceed.
2. Click **Next** when the Welcome screen opens to proceed with the installation.

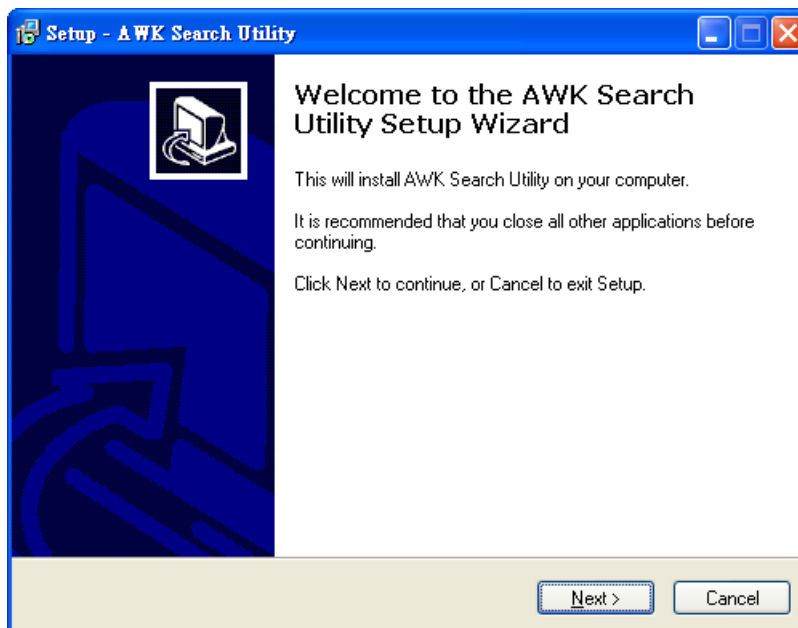

3. Click **Next** to install program files to the default directory, or click **Browse** to select an alternate location.

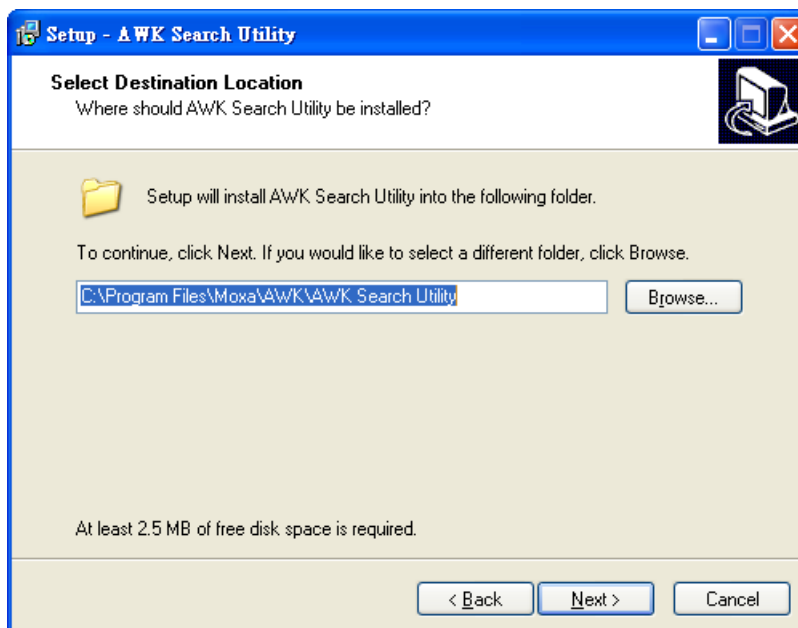

- Click **Next** to create the program's shortcut files to the default directory, or click **Browse** to select an alternate location.

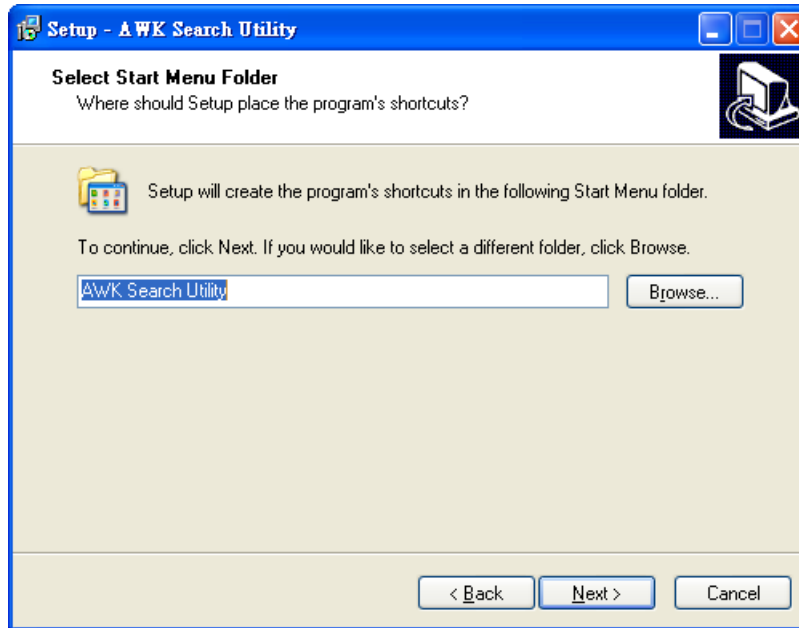

- Click **Next** to select additional tasks.

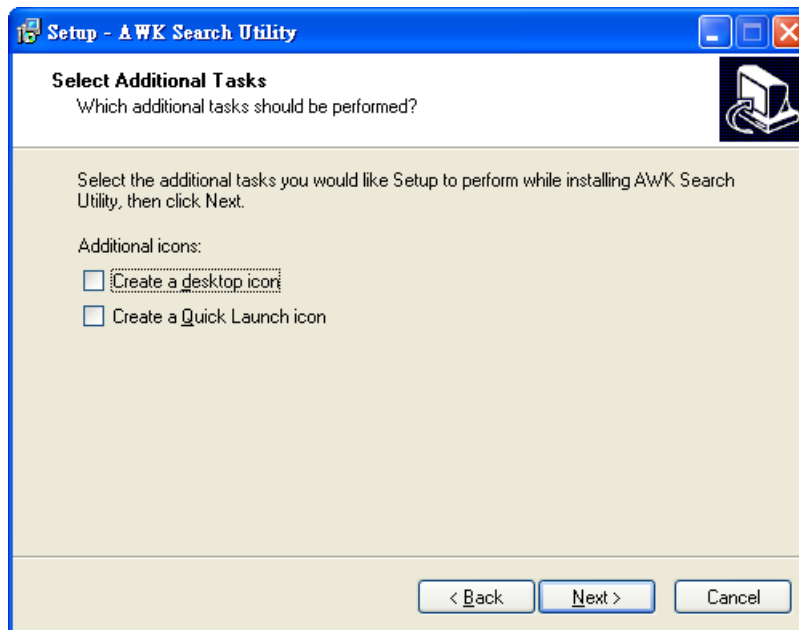

- Click **Next** to proceed with the installation. The installer then displays a summary of the installation options.

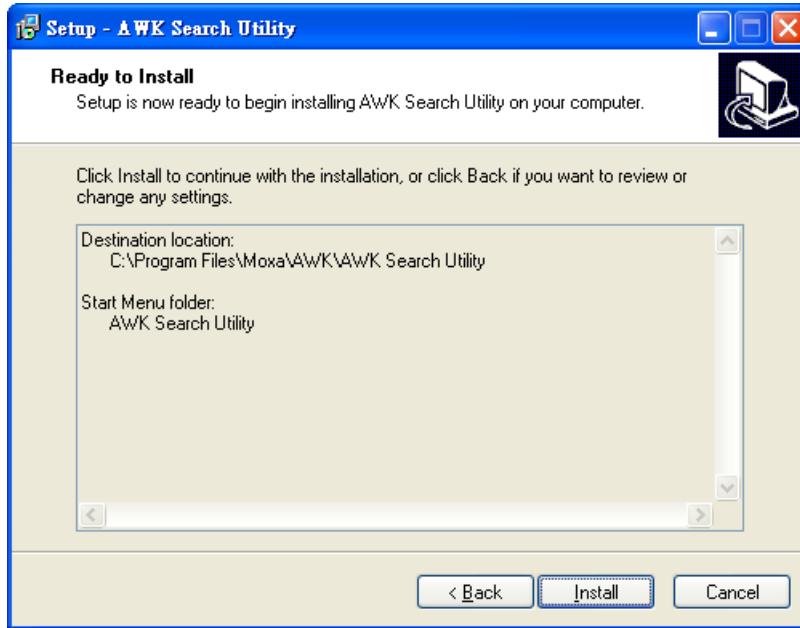

- Click **Install** to begin the installation. The setup window will report the progress of the installation. To change the installation settings, click **Back** and navigate to the previous screen.
- Click **Finish** to complete the installation of AWK Search Utility.

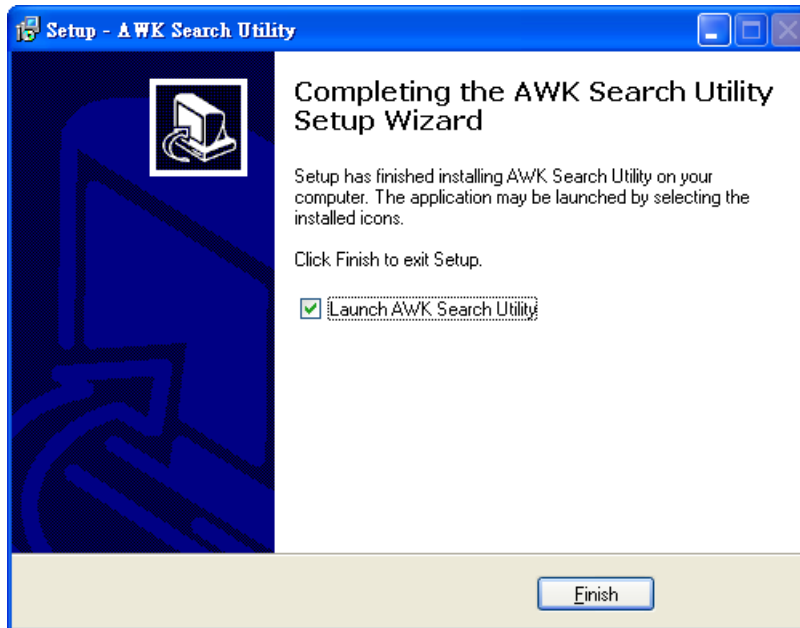

Configuring AWK Search Utility

The Broadcast Search function is used to locate all AWK-5232-M12-RCC APs that are connected to the same LAN as your computer. After locating an AWK-5232-M12-RCC, you will be able to change its IP address. Since the Broadcast Search function searches by TCP packet and not IP address, it doesn't matter if the AWK-5232-M12-RCC is configured as an AP or Client. In either case, APs and Clients connected to the LAN will be located, regardless of whether or not they are part of the same subnet as the host.

1. Start the **AWK Search Utility** program. When the Login page appears, select the "Search AWK only" option to search for AWKs and to view each AWK's configuration. Select the "AWK management" option to assign IPs, upgrade firmware, and locate devices.

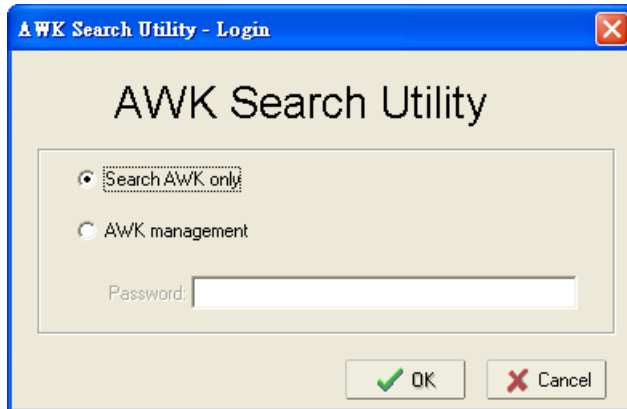

2. Open the AWK Search Utility and then click the **Search** icon.

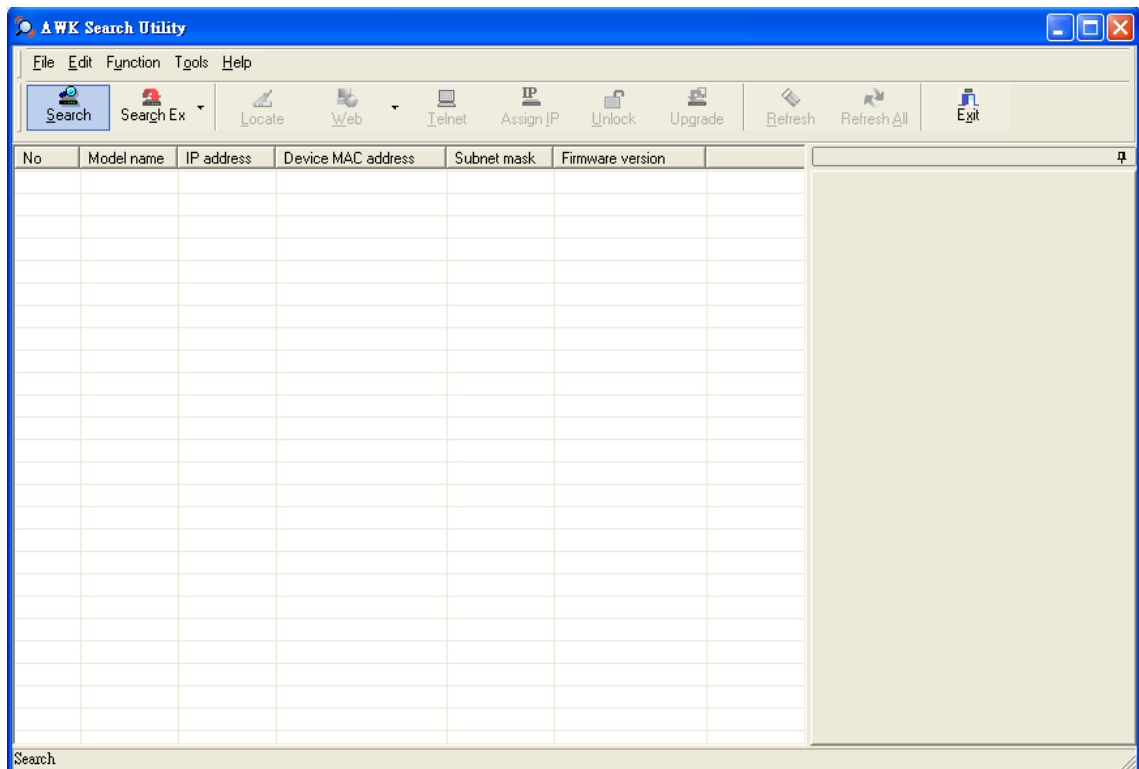

The "Searching" window indicates the progress of the search.

3. When the search is complete, all AWKs that were located will be displayed in the AWK Search Utility window.

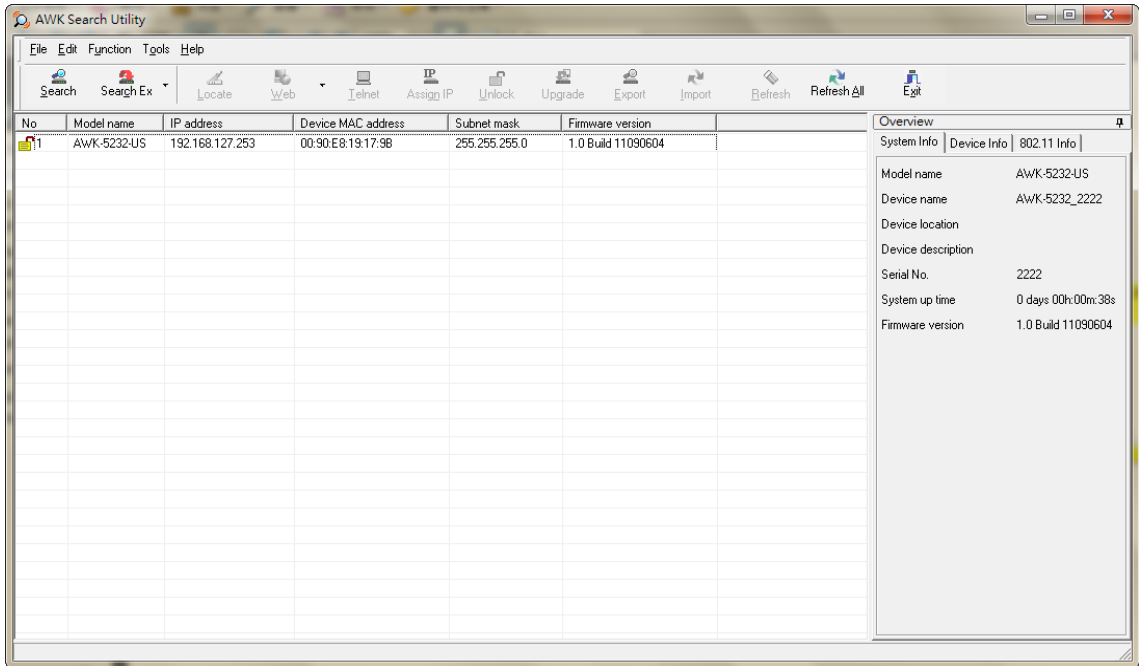

Click **Locate** to cause the selected device to beep.

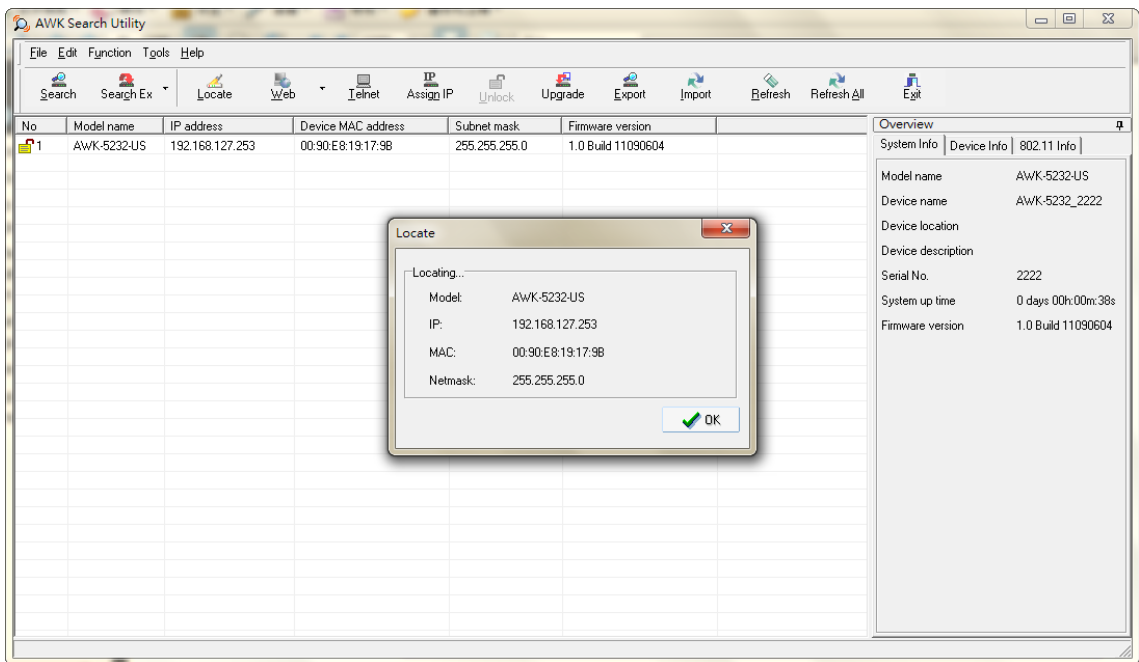

Make sure your AWK is **unlocked** before using the search utility's icons setting. The AWK will unlock automatically if the password is set to the default. Otherwise you must enter the new password manually. Go to **Tools** → **AWK login Options** to manage and unlock additional AWKs.

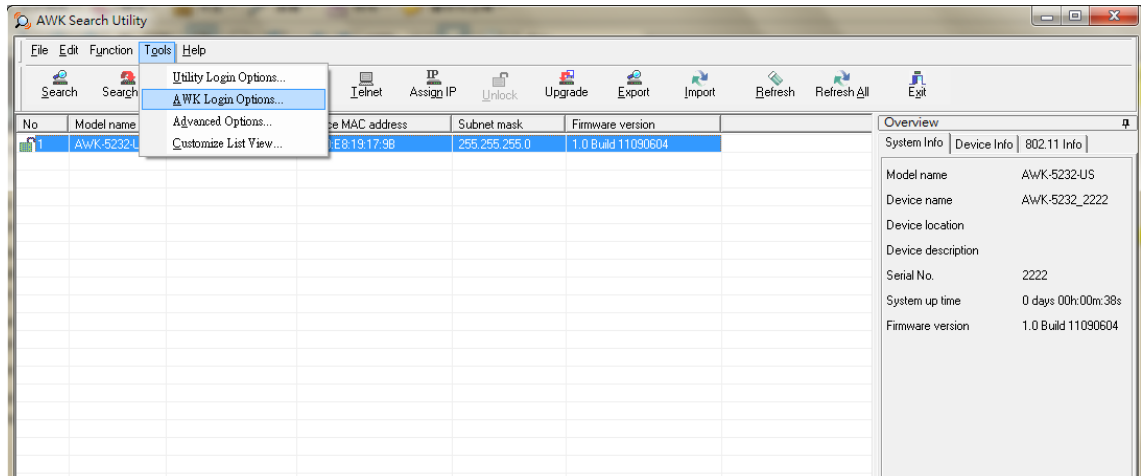

Use the scroll down list to select the MAC addresses of those AWKs you would like to manage, and then click **Add**. Key in the password for the AWK device and then click **OK** to save. If you return to the search page and search for the AWK again, you will find that the AWK will unlock automatically.



ATTENTION

For security purposes, we suggest you can change the AWK search utility login password instead of using default.

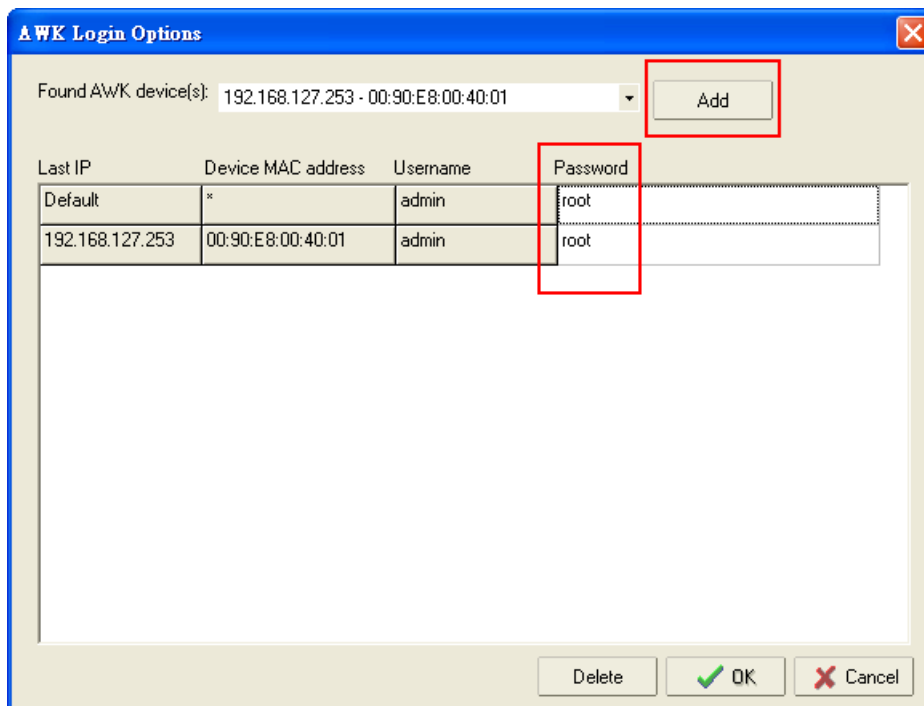

To modify the configuration of the highlighted AWK, click on the Web icon to open the web console. This will take you to the web console, where you can make all configuration changes. Refer to Chapter 3, "Using the Web Console," for information on how to use the web console.

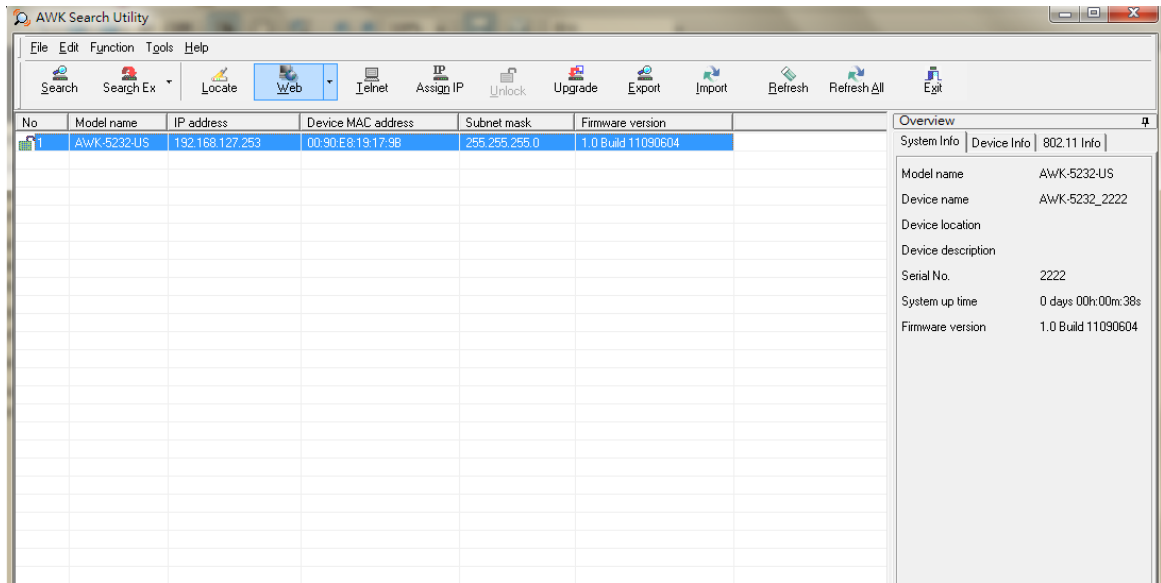

Click on **Telnet** if you would like to use telnet to configure your AWKs.

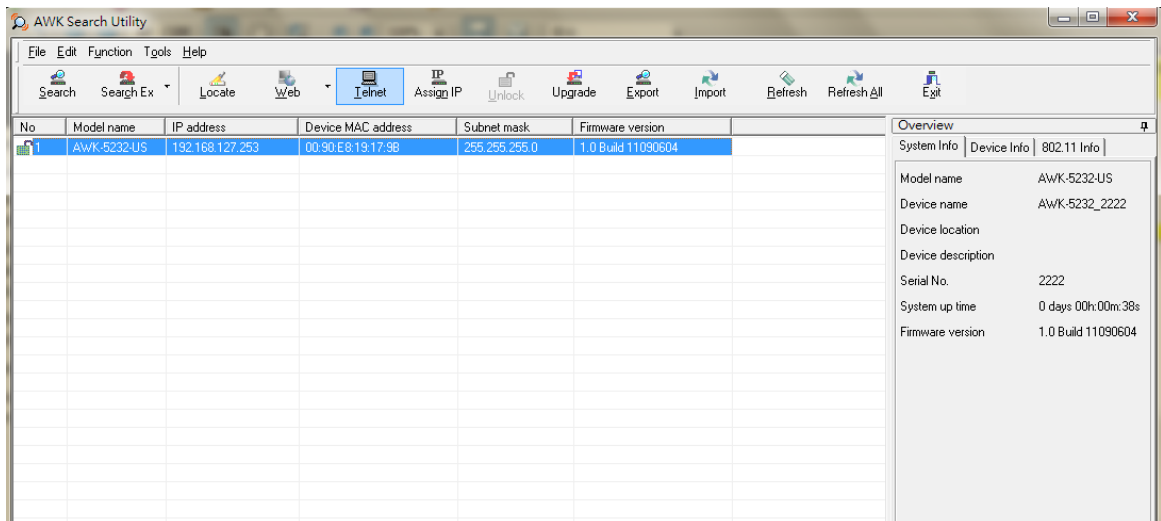

Click **Assign IP** to change the IP setting.

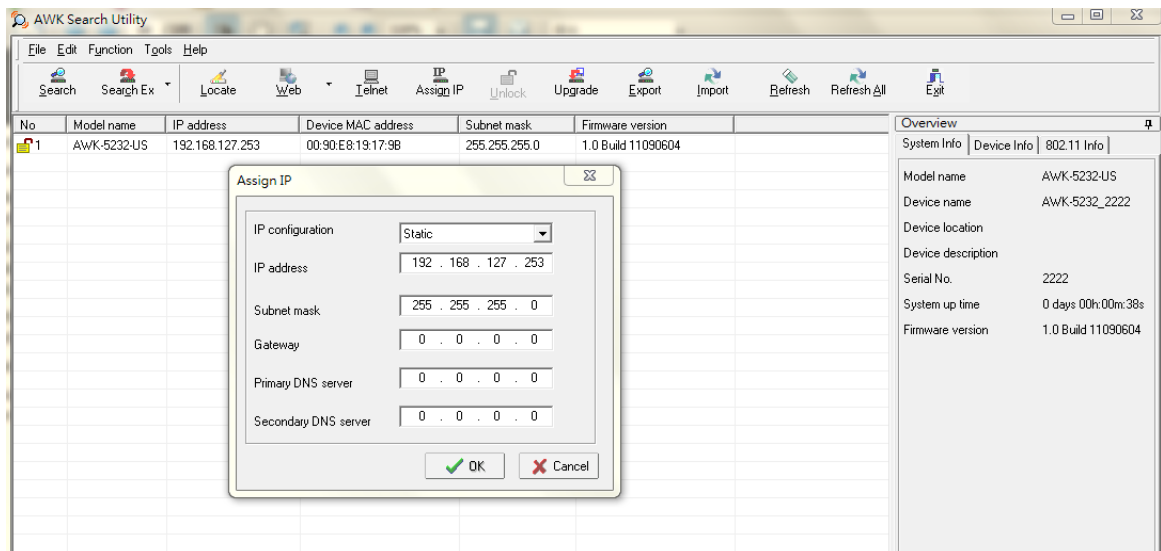

The three advanced options—**Search**, **Connection**, and **Miscellaneous**—are explained below:

Search

Retry count (default=5): Indicates how many times the search will be retried automatically.

Retry interval (ms): The time lapsed between retries.

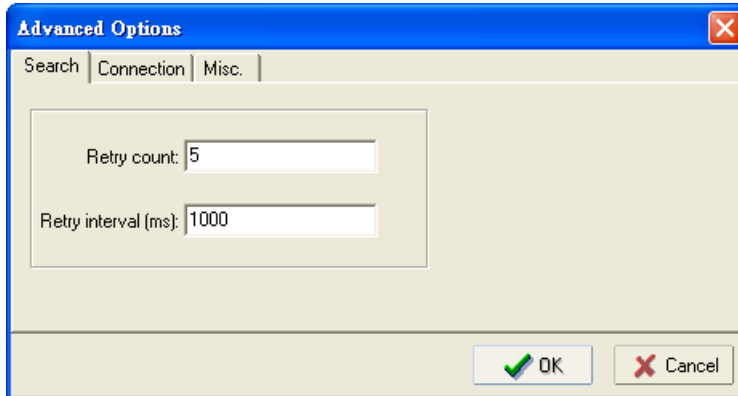

Connection

Connection timeout (secs): Use this option to set the waiting time for the **Default Login**, **Locate**, **Assign IP**, **Upload Firmware**, and **Unlock** to complete.

Upgrade timeout (secs): Use this option to set the waiting time for the connection to disconnect while the firmware is upgrading. Use this option to set the waiting time for the Firmware to write to flash.

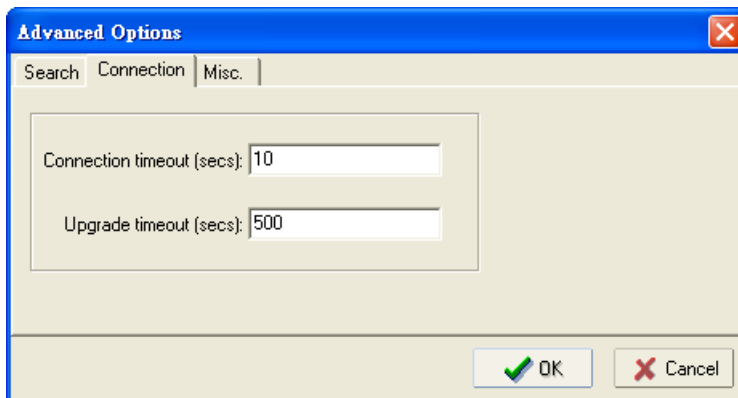

Misc.

Search on start: Checkmark this box if you would like the search function to start searching for devices after you log in to the AWK search Utility.

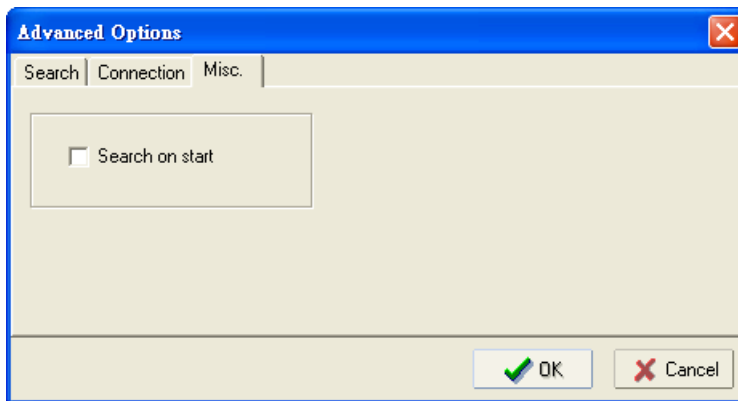

Other Console Configurations

This chapter explains how to access the AWK-5232-M12-RCC for the first time. In addition to HTTP access, there are four ways to access AWK-5232-M12-RCC: serial console, Telnet console, SSH console, and HTTPS console. The serial console connection method, which requires using a short serial cable to connect the AWK-5232-M12-RCC to a PC's COM port, can be used if you do not know the AWK-5232-M12-RCC's IP address. The other consoles can be used to access the AWK-5232-M12-RCC over an Ethernet LAN, or over the Internet.

The following topics are covered in this chapter:

- ❑ **RS-232 Console Configuration (115200, None, 8, 1, VT100)**
- ❑ **Configuration by Telnet and SSH Consoles**
- ❑ **Configuration by Web Browser with HTTPS/SSL**
- ❑ **Disabling Telnet and Browser Access**

**ATTENTION**

1. You **CANNOT** connect to the AWK-5232-M12-RCC by two or more of these console configurations simultaneously.
2. You can connect to the AWK-5232-M12-RCC simultaneously by web browser and serial/ Telnet /SSH console. However, we strongly suggest that you do **NOT** use more than one connection method at the same time. Following this advice will allow you to maintain better control over the configuration of your AWK-5232-M12-RCC.

RS-232 Console Configuration (115200, None, 8, 1, VT100)

The serial console connection method, which requires using a short serial cable to connect the AWK-5232-M12-RCC to a PC's COM port, can be used if you do not know the AWK-5232-M12-RCC's IP address. It is also convenient to use serial console configurations when you cannot access the AWK-5232-M12-RCC over Ethernet LAN, such as in the case of LAN cable disconnections or broadcast storming over the LAN.

**ATTENTION**

Do not use the RS-232 console manager when the AWK-5232-M12-RCC is powered at reversed voltage (ex. -48VDC), even though reverse voltage protection is supported. If you need to connect the RS-232 console at reversed voltage, Moxa's TCC-82 isolator is your best solution.

NOTE We recommend using **Moxa PComm (Lite)** Terminal Emulator, which can be downloaded free of charge from Moxa's website.

Before running PComm Terminal Emulator, use an RJ45 to DB9-F (or RJ45 to DB25-F) cable to connect the AWK-5232-M12-RCC's RS-232 console port to your PC's COM port (generally COM1 or COM2, depending on how your system is set up). After installing PComm Terminal Emulator, take the following steps to access the RS-232 console utility.

1. From the Windows desktop, open the Start menu and start **PComm Terminal Emulator** in the PComm (Lite) group.
2. Select Open under Port Manager to open a new connection.

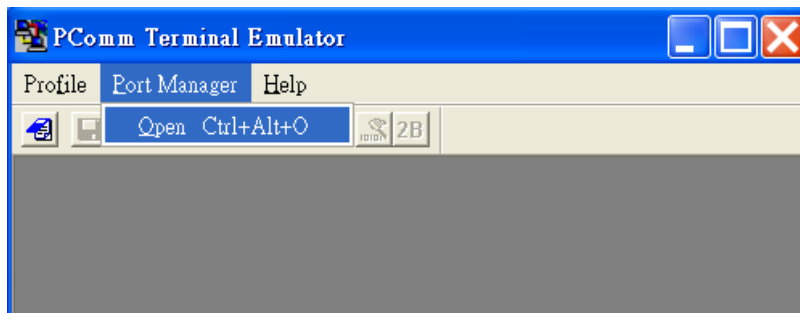

- The **Communication Parameter** page of the Property window opens. Select the appropriate COM port for Console Connection, **115200** for Baud Rate, **8** for Data Bits, **None** for Parity, and **1** for Stop Bits.

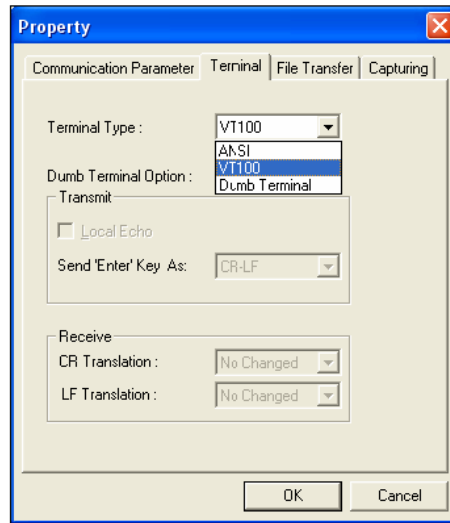
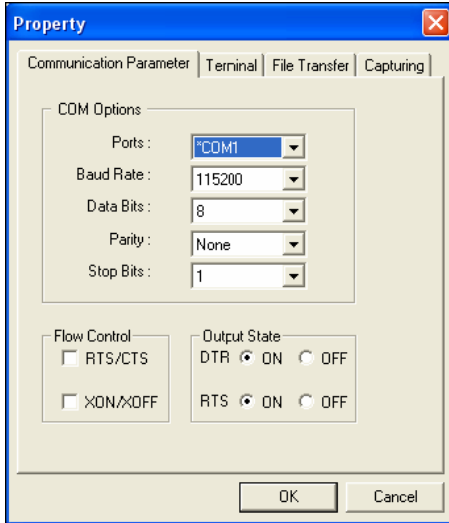

- Click on the **Terminal** tab, and select **VT100 (or ANSI)** for Terminal Type. Click on **OK** to continue.
- The Console login screen will appear. Log into the RS-232 console with the login name (default: **admin**) and password (default: **moxa**, if no new password is set).

NOTE Firmware Version 1.6 password: moxa
 Firmware Versions 1.0 to 1.5 password: root

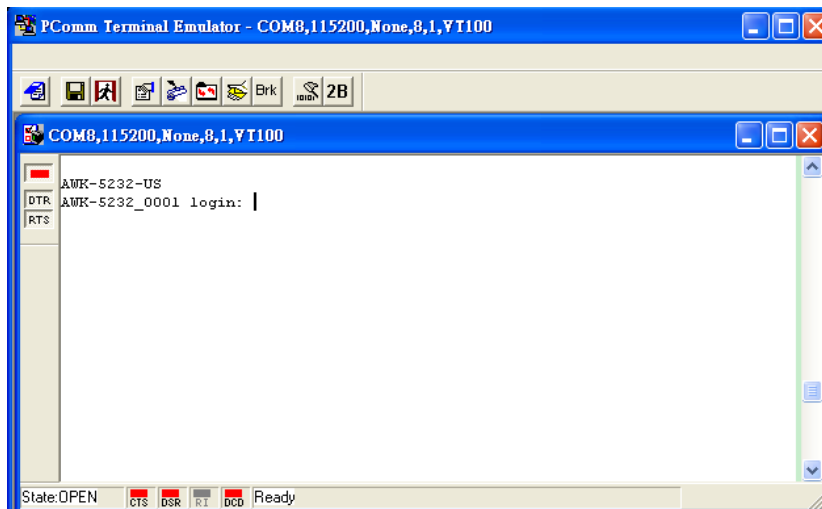

- The AWK-5232-M12-RCC's device information and Main Menu will be displayed. Please follow the description on screen and select the administration option you wish to perform.

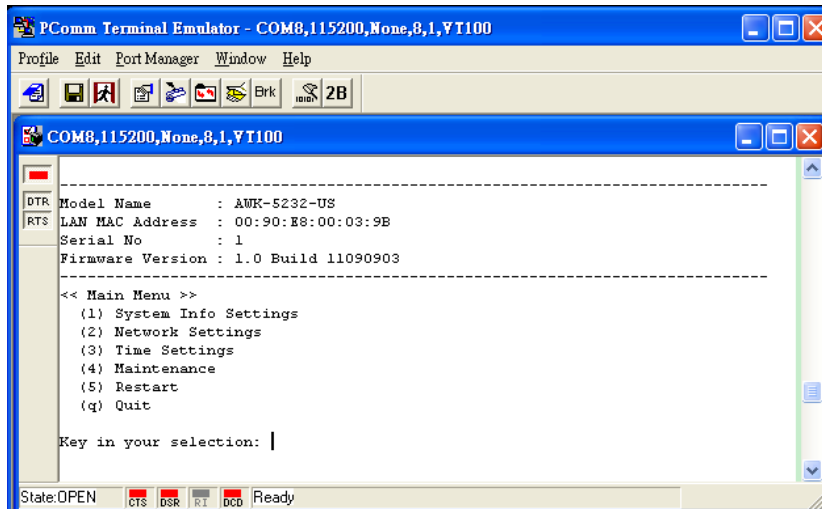

NOTE To modify the appearance of the PComm Terminal Emulator window, select **Edit → Font** and then choose the desired formatting options.

ATTENTION  If you unplug the RS-232 cable or trigger **DTR**, a disconnection event will be evoked to enforce logout for network security. You will need to log in again to resume operation.

Configuration by Telnet and SSH Consoles

You may use Telnet or SSH client to access the AWK-5232-M12-RCC and manage the console over a network. To access the AWK-5232-M12-RCC's functions over the network from a PC host that is connected to the same LAN as the AWK-5232-M12-RCC, you need to make sure that the PC host and the AWK-5232-M12-RCC are on the same logical subnet. To do this, check your PC host's IP address and subnet mask.

NOTE The AWK-5232-M12-RCC's default IP address is **192.168.127.253** and the default subnet mask is **255.255.255.0** (for a Class C network). If you do not set these values properly, please check the network settings of your PC host and then change the IP address to 192.168.127.xxx and subnet mask to 255.255.255.0.

Follow the steps below to access the console utility via Telnet or SSH client.

- From Windows Desktop, run **Start → Run**, and then use Telnet to access the AWK-5232-M12-RCC's IP address from the Windows Run window. (You may also issue the telnet command from the MS-DOS prompt.)

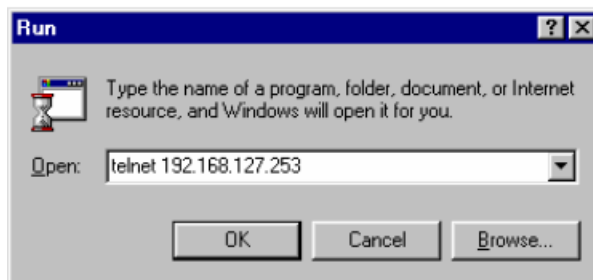

When using SSH client (ex. PuTTY), please run the client program (ex. putty.exe) and then input the AWK-5232-M12-RCC's IP address, specifying **22** for the SSH connection port.

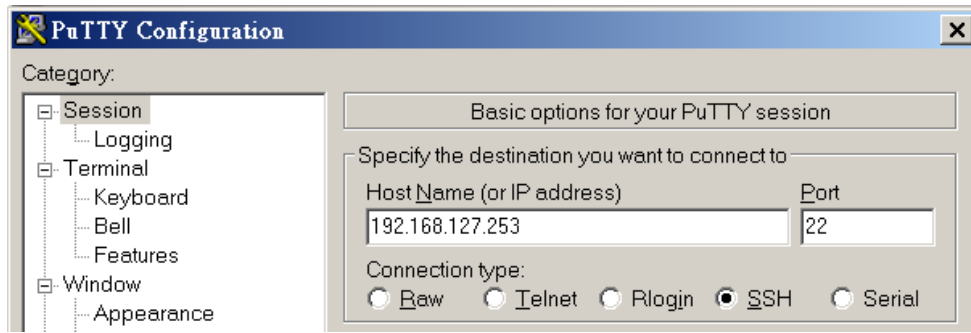

2. The Console login screen will appear. Please refer to the previous paragraph "RS-232 Console Configuration" and for login and administration.

Configuration by Web Browser with HTTPS/SSL

To secure your HTTP access, the AWK-5232-M12-RCC supports HTTPS/SSL encryption for all HTTP traffic. Perform the following steps to access the AWK-5232-M12-RCC's web browser interface via HTTPS/SSL.

1. Open your web browser and type `https://<AWK-5232-M12-RCC's IP address>` in the address field. Press **Enter** to establish the connection.

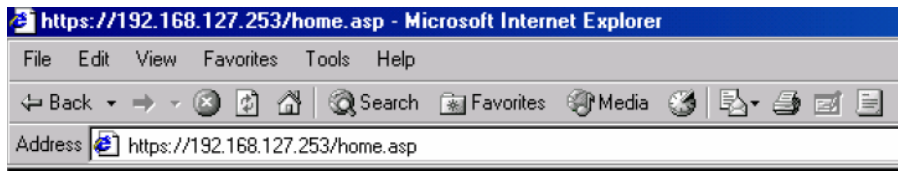

2. Warning messages will pop out to warn users that the security certificate was issued by a company they have not chosen to trust.

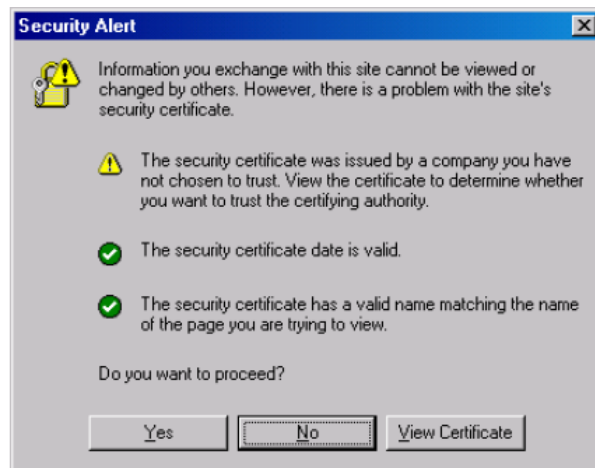

3. Select **Yes** to accept the certificate issued by Moxa IW and then enter the AWK-5232-M12-RCC's web browser interface secured via HTTPS/SSL. (You can see the protocol in URL is **https**.) Then you can use the menu tree on the left side of the window to open the function pages to access each of AWK-5232-M12-RCC's functions.

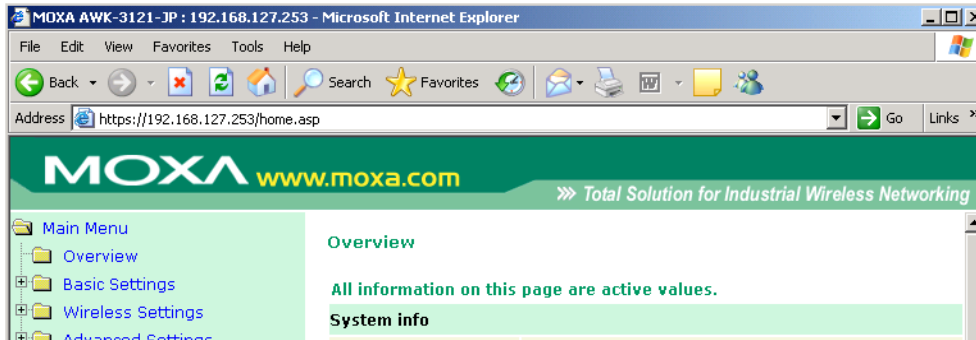

Disabling Telnet and Browser Access

If you are connecting the AWK-5232-M12-RCC to a public network but do not intend to use its management functions over the network, then we suggest disabling both Telnet Console and Web Configuration. Please run **Maintenance → Console Settings** to disable them, as shown in the following figure.

Console Settings

- HTTP console Enable Disable
- HTTPS console Enable Disable
- Telnet console Enable Disable
- SSH console Enable Disable

Submit

This chapter provides more detailed information about wireless-related technologies. The information in this chapter can help you administer your AWK-5232-M12-RCCs and plan your industrial wireless network better.

The following topics are covered in this chapter:

- ❑ **Beacon**
- ❑ **DTIM**
- ❑ **Fragment**
- ❑ **RTS Threshold**
- ❑ **STP and RSTP**
 - The STP/RSTP Concept
 - Differences between RSTP and STP

Beacon

A beacon is a packet broadcast by the AP to keep the network synchronized. A beacon includes the wireless LAN service area, the AP address, the Broadcast destination address, a time stamp, Delivery Traffic Indicator Maps (DTIM), and the Traffic Indicator Message (TIM). Beacon Interval indicates the frequency interval of AP.

DTIM

Delivery Traffic Indication Map (DTIM) is contained in beacon frames. It is used to indicate that broadcast and multicast frames buffered by the AP will be delivered shortly. Lower settings result in more efficient networking, while preventing your PC from dropping into power-saving sleep mode. Higher settings allow your PC to enter sleep mode, thus saving power.

Fragment

A lower setting means smaller packets, which will create more packets for each transmission. If you have decreased this value and experience high packet error rates, you can increase it again, but it will likely decrease overall network performance. Only minor modifications of this value are recommended.

RTS Threshold

RTS Threshold (256-2346) – This setting determines how large a packet can be before the Access Point coordinates transmission and reception to ensure efficient communication. This value should remain at its default setting of 2,346. When you encounter inconsistent data flow, only minor modifications are recommended.

STP and RSTP

The STP/RSTP Concept

Spanning Tree Protocol (STP) was designed to help reduce link failures in a network, and provide protection from loops. Networks that have a complicated architecture are prone to broadcast storms caused by unintended loops in the network. The STP protocol is part of the IEEE802.1D standard, 1998 Edition bridge specification.

Rapid Spanning Tree Protocol (RSTP) implements the Spanning Tree Algorithm and Protocol defined by IEEE802.1w-2001 standard. RSTP provides the following benefits:

- The topology of a bridged network will be determined much more quickly compared to STP.
- RSTP is backward compatible with STP, making it relatively easy to deploy. For example:
 - Defaults to sending 802.1D-style BPDUs if packets with this format are received.
 - STP (802.1D) and RSTP (802.1w) can operate on the LAN ports and WLAN ports (AP and WDS1-WDS8) of the same AWK-5232-M12-RCC.

This feature is particularly helpful when the AWK-5232-M12-RCC connects to older equipment, such as legacy switches.

Differences between RSTP and STP

RSTP is similar to STP, but includes additional information in the BPDUs that allow each bridge to confirm that it has taken action to prevent loops from forming when it decides to enable a link to a neighboring bridge. Adjacent bridges connected via point-to-point links will be able to enable a link without waiting to ensure that all other bridges in the network have had time to react to the change. The main benefit of RSTP is that the configuration decision is made locally rather than network-wide, allowing RSTP to carry out automatic configuration and restore a link faster than STP.

Supporting Information

This chapter presents additional information about this manual and product. You can also learn how to contact Moxa for technical support.

The following topics are covered in this chapter:

- ❑ **DoC (Declaration of Conformity)**
 - Federal Communication Commission Interference Statement
 - R&TTE Compliance Statement
- ❑ **Firmware Recovery**
- ❑ **Technical Support Contact Information**

DoC (Declaration of Conformity)

Federal Communication Commission Interference Statement

This equipment has been tested and found to comply with the limits for a Class B digital device, pursuant to Part 15 of the FCC Rules. These limits are designed to provide reasonable protection against harmful interference in a residential installation. This equipment generates, uses and can radiate radio frequency energy and, if not installed and used in accordance with the instructions, may cause harmful interference to radio communications. However, there is no guarantee that interference will not occur in a particular installation. If this equipment does cause harmful interference to radio or television reception, which can be determined by turning the equipment off and on, the user is encouraged to try to correct the interference by one of the following measures:

- Reorient or relocate the receiving antenna.
- Increase the separation between the equipment and receiver.
- Connect the equipment into an outlet on a circuit different from that to which the receiver is connected.
- Consult the dealer or an experienced radio/TV technician for help.

FCC Caution: To assure continued compliance, (example – use only shielded interface cables when connecting to computer or peripheral devices). Any changes or modifications not expressly approved by the party responsible for compliance could void the user's authority to operate this equipment. This transmitter must not be co-located or operated in conjunction with any other antenna or transmitter.

FCC Radiation Exposure Statement

This equipment complies with FCC radiation exposure limits set forth for an uncontrolled environment. This equipment should be installed and operated with a minimum distance of 20 cm between the radiator & your body.

This device complies with Part 15 of the FCC Rules. Operation is subject to the following two conditions: (1) This device may not cause harmful interference, and (2) this device must accept any interference received, including interference that may cause undesired operation.

FCC 15.407(e): Within the 5.15-5.25 GHz band, U-NII devices will be restricted to indoor operations to reduce any potential for harmful interference to co-channel MSS operations.

R&TTE Compliance Statement

This equipment complies with all the requirements of DIRECTIVE 1999/5/CE OF THE EUROPEAN PARLIAMENT AND THE COUNCIL OF 9 March 1999 on radio equipment and telecommunication terminal equipment and the mutual recognition of their conformity (R&TTE).

The R&TTE Directive repeals and replaces in the directive 98/13/EEC (Telecommunications Terminal Equipment and Satellite Earth Station Equipment) as of April 8, 2000.

Safety

This equipment is designed with the utmost care for the safety of those who install and use it. However, special attention must be paid to the dangers of electric shock and static electricity when working with electrical equipment. All guidelines of this and of the computer manufacturer must therefore be allowed at all times to ensure the safe use of the equipment.

EU Countries Intended for Use

The ETSI version of this device is intended for home and office use in Austria, Belgium, Denmark, Finland, France (with Frequency channel restrictions), Germany, Greece, Ireland, Italy, Luxembourg, Portugal, Spain, Sweden, The Netherlands, and United Kingdom.

The ETSI version of this device is also authorized for use in EFTA member states Norway and Switzerland.

EU Countries Not Intended for Use

None.

Potential Restrictive Use

France: only channels 10, 11, 12, and 13.

CE Warning

This is a class B product. In a domestic environment this product may cause radio interference in which case the user may be required to take adequate measures.

Firmware Recovery

When the LEDs of **FAULT**, and **STATE** all light up simultaneously and blink at one-second interval, it means the system booting has failed. It may result from some wrong operation or uncontrollable issues, such as an unexpected shutdown during firmware update. The AWK-5232-M12-RCC is designed to help administrators recover such damage and resume system operation rapidly. You can refer to the following instructions to recover the firmware:

Connect to the AWK-5232-M12-RCC's RS-232 console with **115200bps and N-8-1**. You will see the following message shown on the terminal emulator every one second.

```
Press Ctrl-C to enter Firmware Recovery Process.....
Press Ctrl-C to enter Firmware Recovery Process.....
Press Ctrl-C to enter Firmware Recovery Process.....
Press Ctrl-C to enter Firmware Recovery Process.....
Press Ctrl-C to enter Firmware Recovery Process.....
Press Ctrl-C to enter Firmware Recovery Process.....
Press Ctrl-C to enter Firmware Recovery Process.....
Press Ctrl-C to enter Firmware Recovery Process.....
Press Ctrl-C to enter Firmware Recovery Process.....
Press Ctrl-C to enter Firmware Recovery Process.....
Press Ctrl-C to enter Firmware Recovery Process.....
Press Ctrl-C to enter Firmware Recovery Process.....
Press Ctrl-C to enter Firmware Recovery Process.....
Press Ctrl-C to enter Firmware Recovery Process.....
```

Press **Ctrl-C** and the following message will appear.

```
Press Ctrl - C and the following message will appear.
Press Ctrl-C to enter Firmware Recovery Process.....
Press Ctrl-C to enter Firmware Recovery Process.....
=====
IP address of AWK-5232 : 192.168.40.155
Netmask of AWK-5222 : 255.255.252.0
Gateway of AWK-5222 : 192.168.43.254
IP address of TFTP server : 192.168.40.142
=====
1. Start to firmware upgrade using the above network setting immediately.
2. Change the network settings.
Enter your selection : (1-2,enter for abort): |
```

Enter **2** to change the network setting. Specify where the AWK-5232-M12-RCC's firmware file on the TFTP server and press **y** to write the settings into flash memory.

```
=====
1. Start to firmware upgrade using the above network setting immediately.
2. Change the network settings.
Enter your selection : (1-2,enter for abort): 2

IP address of AWK-5232 : 192.168.1.2
IP address of TFTP server : 192.168.1.1
Netmask of AWK-5232 : 255.255.252.0
Gateway of AWK-5232 : 192.168.1.254
Update RedBoot non-volatile configuration - continue (y/n)? y
```

AWK-5232-M12-RCC restarts, and the "Press Ctrl-C to enter Firmware Recovery Process..." message will reappear. Press **Ctrl-C** to enter the menu and select **1** to start the firmware upgrade process.

```
Press Ctrl-C to enter Firmware Recovery Process.....
=====
IP address of AWK-5232 : 192.168.1.2
Netmask of AWK-5232 : 255.255.252.0
Gateway of AWK-5232 : 192.168.40.142
IP address of TFTP server : 255.255.252.0
=====
1. Start to firmware upgrade using the above network setting immediately.
2. Change the network settings.
Enter your selection : (1-2,enter for abort): 1
```

Select **0** in the sub-menu to load the firmware image via LAN, and then enter the file name of the firmware to start the firmware recovery.

```
=====
Load method select :
0. Load from LAN
1. Load from serial with Xmodem
q. Abort
=====
Please select item : 0
Please input file name.
Default file name : AWK-5232.rom
User Input file name : AWK-5232_1.0.rom
```

Technical Support Contact Information

Customer satisfaction is our number one concern, and to ensure that customers receive the full benefit of our products, Moxa Internet Services has been set up to provide technical support, driver updates, product information, certification status, installation guide and user's manual updates.

The following services are provided:

- E-mail for technical support:
 - support@moxa.com (Worldwide)
 - support@usa.moxa.com (The Americas)
- World Wide Web (WWW) Site for product information:
 - <http://www.moxa.com>