

DA-720 Series Expansion Modules

Expansion modules with PRP/HSR ports, RS-232/422/485 serial ports, Giga LAN ports, and SATA kit

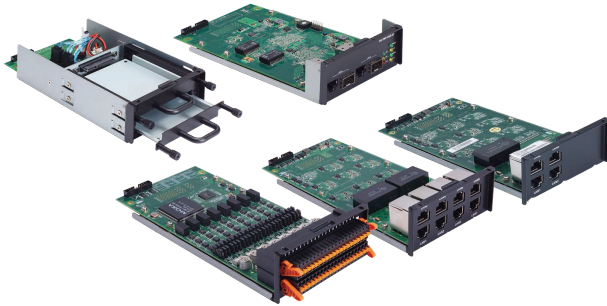

- > PRP/HSR module
- > 4-port Giga LAN module
- > 8-port Giga LAN module
- > SATA Storage expansion module
- > IRIG-B time-synchronization module (coming soon)
- > 8-port RS-232/422/485 software-selectable serial modules with isolation protection



Overview

DA-720's peripheral expansion modules, which come with PRP/HSR ports, serial ports, LAN ports, time-synchronization IRIG-B ports, and SATA storage expansion kit, give end-users the greatest flexibility for setting up industrial applications.

The serial port modules include an 8-port RS-232/422/485 module with terminal block connectors and designed with 2 kV digital isolation, making it fully suitable for the great demands of industrial applications that use serial communication.

In addition, a 4-port LAN module, 8-port LAN module, and PRP/HSR module are available for setting up industrial communication applications with Ethernet-based devices. A SATA storage kit is also available for expanding data storage to industrial applications.

The time-synchronization module features 4 digital inputs and 4 digital outputs and provides precision timing information using IRIG-B input signals. All modules are designed to offer the greatest flexibility for setting up applications and performing industrial tasks. In particular, users can swap out modules quickly and easily.

The PRP/HSR expansion module is compliant with IEC 62439-3 Clause 4 (PRP) and IEC 62439-3 Clause 5 (HSR) to ensure the highest system availability and data integrity for mission-critical applications that require redundancy and zero-time recovery. With dual Gigabit Ethernet port design, the DA-PRP/HSR provides high performance for redundant network systems. Moxa's DA-720 series industrial computer with the DA-PRP/HSR is the ideal solution for power substation automation and process automation systems.

Appearance

DE-PRP-HSR-EF

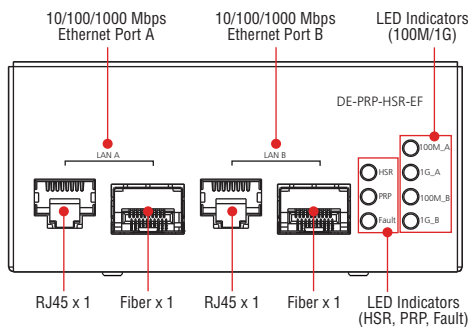

DE-LN08-RJ

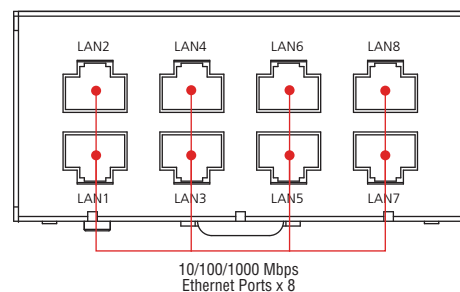

DE-LN04-RJ

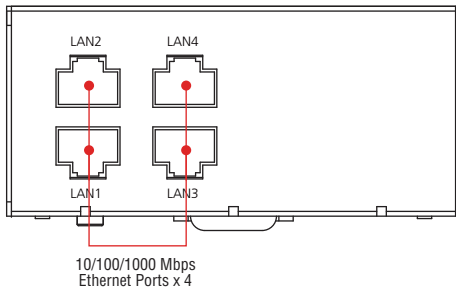

DE-SP08-I-TB

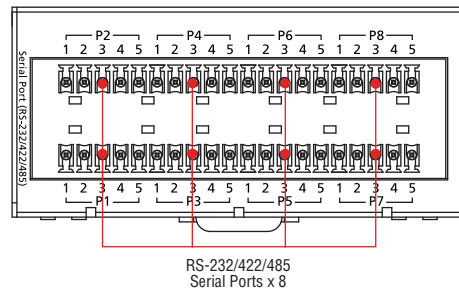

DE-2-SATA

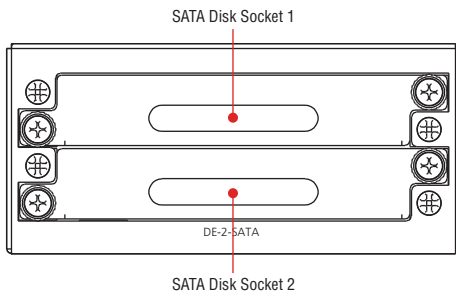

DE-2-IRIGB-4-DI/DO (COMING SOON)

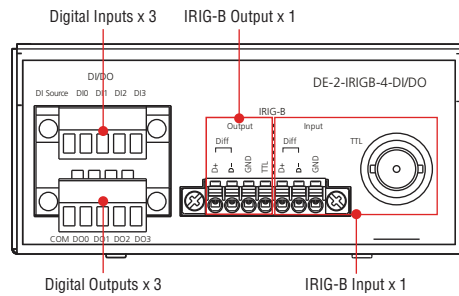

Dimensions

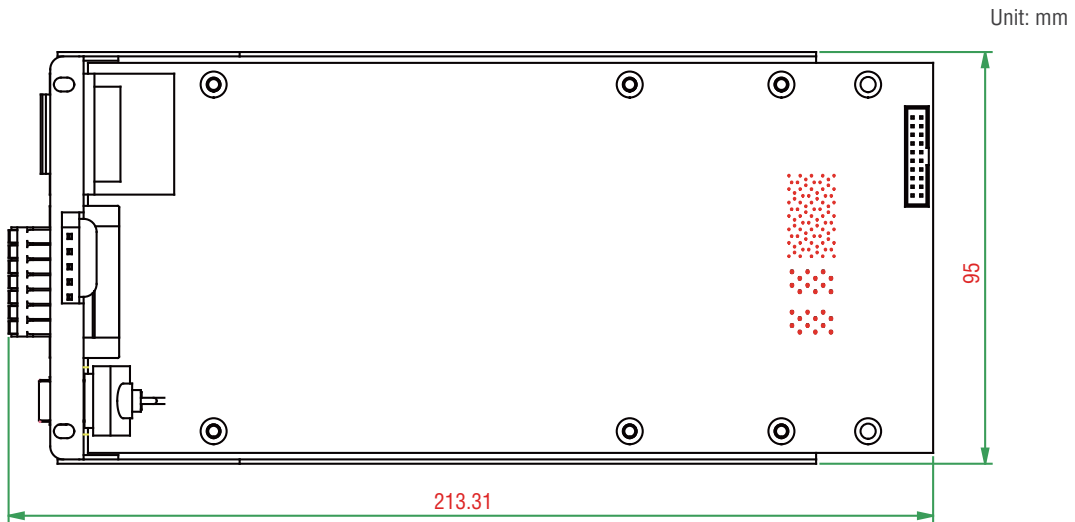

DE-PRP-HSR-EF Hardware Specifications

Ethernet Interface

LAN: 2 auto-sensing 100/1000 Mbps unmanaged Ethernet switch ports (RJ45 and SFP)

Fiber Ports: 1000 Base SFP slot

Magnetic Isolation Protection: 15 kV built-in

Physical Characteristics

Weight: TBD

Dimensions: 213.31 x 95 mm (8.398 x 3.74 in)

MTBF (mean time between failures): TBD

Environmental Limits

Operating Temperature: -25 to 55°C (-13 to 131°F)

Warranty

Warranty Period: 3 years

Details: See www.moxa.com/warranty

Software Installation

Details: DA-720 Series Linux Software User's Manual, Chapter 6

Details: DA-720 Series Windows Software User's Manual, Chapter 7

DE-LN08-RJ/DE-LN04-RJ Hardware Specifications

Ethernet Interface

LAN:

DE-LN04-RJ: 4 auto-sensing 10/100/100 Mbps ports (RJ45)

DE-LN08-RJ: 8 auto-sensing 10/100/100 Mbps ports (RJ45)

Magnetic Isolation Protection: 1.5 kV built-in

Physical Characteristics

Weight: TBD

Dimensions: 213.31 x 95 mm (8.398 x 3.74 in)

MTBF (mean time between failures): TBD

Environmental Limits

Operating Temperature: -25 to 55°C (-13 to 131°F)

Warranty

Warranty Period: 3 years

Details: See www.moxa.com/warranty

DE-SP08-I-TB Hardware Specifications

Serial Interface

Serial Standards: 8 RS-232/422/485 ports, software selectable (DB9 male or terminal block connector)

ESD Protection: 8 kV contact, 15 kV air

Surge Protection: 2 kV line-to-line and 4 kV line-to-ground surge protection, 8/20 μs waveform

Insulation: 500 V

Isolation: 2 kV digital isolation

Pull low/high: 1k/150k, jumper selectable

Termination Resistor: 120 ohms, jumper selectable

Serial Communication Parameters

Data Bits: 5, 6, 7, 8

Stop Bits: 1, 1.5, 2

Parity: None, Even, Odd, Space, Mark

Flow Control: RTS/CTS, XON/XOFF, ADDC® (automatic data direction control) for RS-485

Baudrate: 50 bps to 921.6 kbps (supports non-standard baudrates; see user's manual for details)

Serial Signals

RS-232: TxD, RxD, RTS, CTS, GND

RS-422: TxD+, TxD-, RxD+, RxD-, GND

RS-485-4w: TxD+, TxD-, RxD+, RxD-, GND

RS-485-2w: Data+, Data-, GND

Physical Characteristics

Weight: TBD

Dimensions: 213.31 x 95 mm (8.398 x 3.74 in)

MTBF (mean time between failures): TBD

Environmental Limits

Operating Temperature: -25 to 55°C (-13 to 131°F)

Warranty

Warranty Period: 3 years

Details: See www.moxa.com/warranty

DE-2-SATA Hardware Specifications

Hardware

Interface: 2 x 2.5" SATA III Socket

Physical Characteristics

Weight: TBD

Dimensions: 213.31 x 95 mm (8.398 x 3.74 in)

MTBF (mean time between failures): TBD

Environmental Limits

Operating Temperature: -25 to 55°C (-13 to 131°F)

Warranty

Warranty Period: 3 years

Details: See www.moxa.com/warranty

DE-2-IRIGB-4-DI/DO Hardware Specifications (Coming Soon)

Interface

IRIG-B: 7-pin terminal block and BNC

DI/DO: 2 x 5-pin terminal block

Time Code Input

IRIG-B: Based on the IRIG STANDARD 200-04 and IEEE 1344

Precision and Accuracy

Accuracy (Time Synchronization): ±1 µs

Accuracy (Free Running): ±500 ms @ 24 hr

Input Signals

Single Level:

- Open: High
- Short to GND: > Low
- Level Input: 5 to 12 V

Differential Level:

- D+ - D- > 0.2 V, RXD is High
- D+ - D- < -0.2 V, RXD is Low
- Level Input: 5 V

Protection

ESD Protection: 8 kV contact, 15 kV Air ESD protection

Surge Protection: 2 kV line-to-line and 4 kV line-to-ground surge protection, 8/20 µs waveform

Insulation: 500 V

Digital Input

Input Channels: 4, source type

Input Voltage: 0 to 30 VDC

Digital Input Levels for Dry Contacts:

- Logic level 0: Close to GND
- Logic level 1: Open

Digital Input Levels for Wet Contacts:

- Logic level 0: +3 V max.
- Logic level 1: +10 V to +30 V (source to DI)

Isolation: 3 kV optical isolation

Digital Output

Output Channels: 4, sink type

Output Current: Max. 200 mA per channel

On-state Voltage: 24 VDC nominal, open collector to 30 V

Isolation: 3 kV optical isolation

Physical Characteristics

Weight: TBD

Dimensions: 213.31 x 95 mm (8.398 x 3.74 in)

MTBF (mean time between failures): TBD

Environmental Limits

Operating Temperature: -25 to 55°C (-13 to 131°F)

Storage Temperature: -40 to 85°C (-40 to 185°F)

Ambient Relative Humidity: 5 to 95% (non-condensing)

Altitude: Up to 2000 m

Warranty

Warranty Period: 3 years

Details: See www.moxa.com/warranty

Ordering Information

Available Models

DE-PRP-HSR-EF: 2-port Gigabit Ethernet expansion module compliant with IEC62439-3 protocol for Moxa DA-720 series industrial computers

DE-2-IRIGB-4-DI/DO: 2 IRIG-B signal input port, 4 digital inputs, 4 digital outputs (coming soon)

DE-SP08-I-TB: 8-port RS-232/422/485 serial module with terminal block connector and digital isolation

DE-LN04-RJ: 4-port 10/100/1000 Mbps LAN module

DE-LN08-RJ: 8-port 10/100/1000 Mbps LAN module

DE-2-SATA: 2 x SATA-III 2.5" Storage kit

Optional DA-720 Expansion Modules (can be purchased separately)

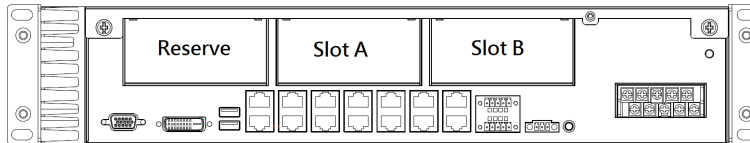

Expansion Module	Description	Reserve Slot	Module Slot A	Module Slot B
DE-LN04-RJ	4-port 100/1000 Mbps PCIe LAN module	N/A (Bandwidth Limitation)	✓	N/A (Bandwidth Limitation)
DE-LN08-RJ	8-port 100/1000 Mbps PCIe LAN module	N/A (Bandwidth Limitation)	✓	N/A (Bandwidth Limitation)
DE-2-SATA	2 x 2.5" SATA III SSD/HDD Socket Module	✓	✓	N/A (Heat Limitation)
DE-PRP-HSR-EF	2-Port 100/1000 Mbps PCIe PRP/HSR LAN Module	✓	✓	N/A (Heat Limitation)
DE-SP08-I-TB	8-port RS-232/422/485 PCIe serial module	✓	✓	✓

Note: Please refer to the DA-720 Hardware/Software manuals for detailed information.