

ioLogik E1261W-T User's Manual

Edition 2.2, March 2017

www.moxa.com/product

MOXA®

© 2017 Moxa Inc. All rights reserved.

ioLogik E1261W-T User's Manual

The software described in this manual is furnished under a license agreement and may be used only in accordance with the terms of that agreement.

Copyright Notice

© 2017 Moxa Inc. All rights reserved.

Trademarks

The MOXA logo is a registered trademark of Moxa Inc.
All other trademarks or registered marks in this manual belong to their respective manufacturers.

Disclaimer

Information in this document is subject to change without notice and does not represent a commitment on the part of Moxa.

Moxa provides this document as is, without warranty of any kind, either expressed or implied, including, but not limited to, its particular purpose. Moxa reserves the right to make improvements and/or changes to this manual, or to the products and/or the programs described in this manual, at any time.

Information provided in this manual is intended to be accurate and reliable. However, Moxa assumes no responsibility for its use, or for any infringements on the rights of third parties that may result from its use.

This product might include unintentional technical or typographical errors. Changes are periodically made to the information herein to correct such errors, and these changes are incorporated into new editions of the publication.

Technical Support Contact Information

www.moxa.com/support

Moxa Americas

Toll-free: 1-888-669-2872
Tel: +1-714-528-6777
Fax: +1-714-528-6778

Moxa Europe

Tel: +49-89-3 70 03 99-0
Fax: +49-89-3 70 03 99-99

Moxa India

Tel: +91-80-4172-9088
Fax: +91-80-4132-1045

Moxa China (Shanghai office)

Toll-free: 800-820-5036
Tel: +86-21-5258-9955
Fax: +86-21-5258-5505

Moxa Asia-Pacific

Tel: +886-2-8919-1230
Fax: +886-2-8919-1231

Table of Contents

1. Introduction	1-1
Product Features	1-2
Inside the Box	1-2
Product Specifications	1-3
Physical Dimensions	1-4
Hardware Reference	1-5
Panel Guide	1-5
Ethernet Port	1-5
LED Indicators	1-6
2. Initial Setup	2-1
Hardware Installation	2-2
Connecting the Power	2-2
Grounding the ioLogik E1261W-T	2-2
Connecting to the Network	2-2
I/O Wiring Diagrams	2-3
ioSearch™ Installation	2-4
Load Factory Default Settings	2-4
3. Using the Web Console	3-1
Introduction to the Web Console	3-2
Overview	3-3
Network Settings for the Web Console	3-3
General Settings	3-3
Ethernet Configuration	3-4
User-Defined Modbus Addressing	3-4
Default Modbus Address	3-5
Active OPC Server Settings	3-5
Tag Generation	3-6
I/O Settings	3-7
DI Channels	3-7
AI Channels	3-9
AI Input Range	3-10
RTD Channels	3-12
System Management	3-14
Accessibility IP List	3-14
Network Connection	3-15
Firmware Update	3-15
Import System Configuration Settings	3-15
Export System Settings	3-16
RS-485 Setting	3-16
Change Password	3-16
Load Factory Defaults	3-17
Save/Restart	3-17
4. Using ioSearch™	4-1
Introduction to ioSearch™	4-2
ioSearch™ Main Screen	4-2
Main Screen Overview	4-2
ioSearch™ Setup	4-3
System	4-3
Sort	4-4
Quick Links	4-4
Main Function	4-4
Locate	4-5
Firmware Upgrade	4-5
Unlock	4-5
Import	4-6
Export	4-6
Change IP Address	4-7
Batch TCP/IP Configuration on Multiple Devices	4-7
Restart System	4-8
Reset to Default	4-8
Mass Deployment (Import)	4-9
Mass Deployment (Export)	4-9
5. Active OPC Server	5-1
Introduction to Active OPC Server	5-2
OLE for Process Control	5-2
Active OPC Server—From Pull to Push	5-3

Features of Active OPC Server	5-5
One Simple Click Creates Active Tags	5-5
Faster, More Accurate Data Collection than Traditional "Pull Technology".....	5-5
Dynamic IP Assignments for Cellular Remote IOs	5-6
Active OPC Server Setup	5-6
Installing Active OPC Server	5-6
Main Screen Overview.....	5-7
Menu Bar	5-7
A. Modbus/TCP Default Address Mappings	A-1
0xxxx Read/Write Coils (Functions 1, 5, 15).....	A-2
1xxxx Read only Coils (Support function 2).....	A-9
3xxxx Read only Registers (Support function 4)	A-10
4xxxx Read/Write Registers (Support function 3,6,16)	A-12
B. Network Port Numbers.....	B-1
C. Factory Default Settings.....	C-1
D. FCC Interference Statement.....	D-1
E. European Community (CE)	E-1

Introduction

The Moxa ioLogik E1261W-T is designed for Ethernet-based remote condition monitoring systems. With 3 RTD, 5 AI, and 12 DIO channels, the ioLogik E1261W-T's I/O combination is ideal for monitoring wind turbines and environmental conditions. Unlike other remote I/O products, which are passive and must poll for data, the ioLogik E1261W-T supports active communication with Moxa's patented Active OPC Server to seamlessly connect with SCADA systems in real time.

The following topics are covered in this chapter:

- ❑ **Product Features**
- ❑ **Inside the Box**
- ❑ **Product Specifications**
- ❑ **Physical Dimensions**
- ❑ **Hardware Reference**
 - Panel Guide
 - Ethernet Port
 - LED Indicators

Product Features

- Active communication with patented Active OPC Server
- Easy mass deployment and configuration with ioSearch™ utility
- User-friendly configuration via web browser
- User-defined Modbus/TCP addressing
- Simplify I/O management with MXIO library on either Windows or Linux platform
- Wide operating temperature: -40 to 75°C (-40 to 167°F)
- Supports SNMPv1/v2c

Inside the Box

The ioLogik E1261W-T is shipped with the following items:

- ioLogik E1261W-T remote Ethernet I/O server

NOTE: Notify your sales representative if any of the above items are missing or damaged.

Product Specifications

Inputs and Outputs

Digital Inputs: 3 channels

Analog Inputs: 5 channels

Configurable DIOs: 12 channels

Isolation: 3k VDC or 2k Vrms

RTD Input

Resolution: 16 bits

Input Type: PT100

Accuracy:

- $\pm 0.1\%$ FSR @ 25°C
- $\pm 1\%$ FSR @ -40 and 75°C

Sampling Rate: 12 samples/sec (all channels)

Resistance: 625k ohms (min.)

Analog Input

Type: Differential input

Resolution: 16 bits

I/O Mode: Current

Input Range: 4 to 20 mA

Accuracy:

- $\pm 0.1\%$ FSR @ 25°C
- $\pm 1\%$ FSR @ -40 and 75°C

Sampling Rate: 12 samples/sec (all channels)

Built-in Resistor for Current Input: 120 ohms

Digital Input

Sensor Type: Wet Contact (NPN or PNP), Dry Contact

I/O Mode: DI or Event Counter

Dry Contact:

- On: short to GND
- Off: open

Wet Contact (DI to GND):

- On: 0 to 3 VDC
- Off: 10 to 30 VDC

Common Type: 12 points per COM (Configurable DIOs)

Over-Voltage Protection: 36 VDC

Digital Output

Type: Sink

I/O Mode: DO or pulse output

Over-Voltage Protection: 45 VDC

Over-Current Protection: 400 mA (typical)

Current Rating: Max. 200 mA per channel

LAN

Ethernet: 1 10/100 Mbps switch port, RJ45

Protection: 1.5 kV magnetic isolation

Protocols: Modbus/TCP, TCP/IP, UDP, DHCP, Bootp, HTTP

Power Requirements

Power Input: 24 VDC nominal, 12 to 36 VDC

Physical Characteristics

Wiring: I/O cable max. 14 AWG

Environmental Limits

Operating Temperature: -40 to 75°C (-40 to 140°F)

Storage Temperature: -40 to 85°C (-40 to 185°F)

Ambient Relative Humidity: 5 to 95% (non-condensing)

Serial Communication

Interface: Data+, Data-, GND (3-contact terminal block)

Serial Line Protection: 15 kV ESD for all signals

Serial Communication Parameters

Parity: None

Data Bits: 8

Stop Bits: 1

Flow Control: None

Baudrate: 1200 bps to 115,200 bps

Protocols: Modbus RTU

Warranty

Warranty Period: 5 years

Details: See www.moxa.com/warranty

Physical Dimensions

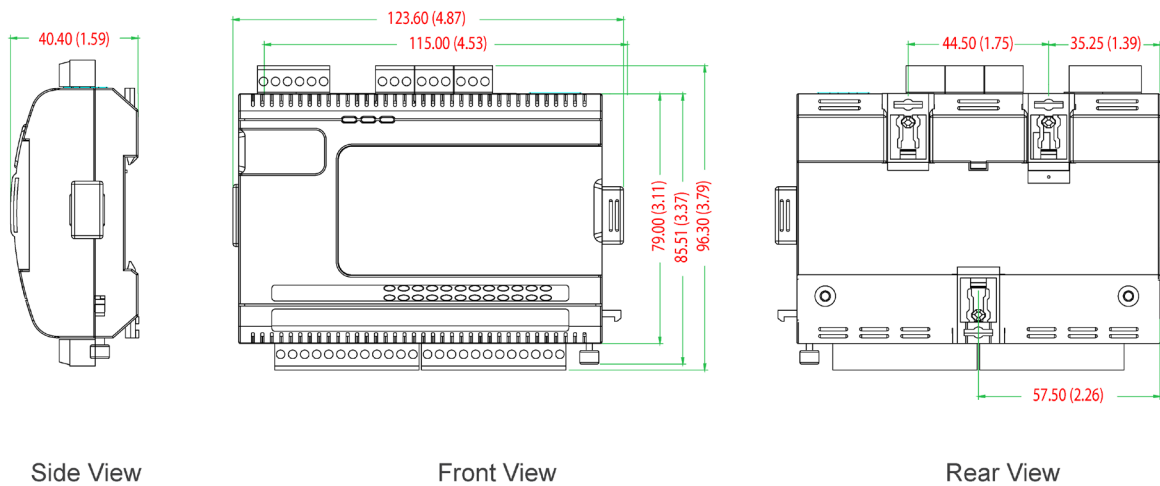

Hardware Reference

Panel Guide

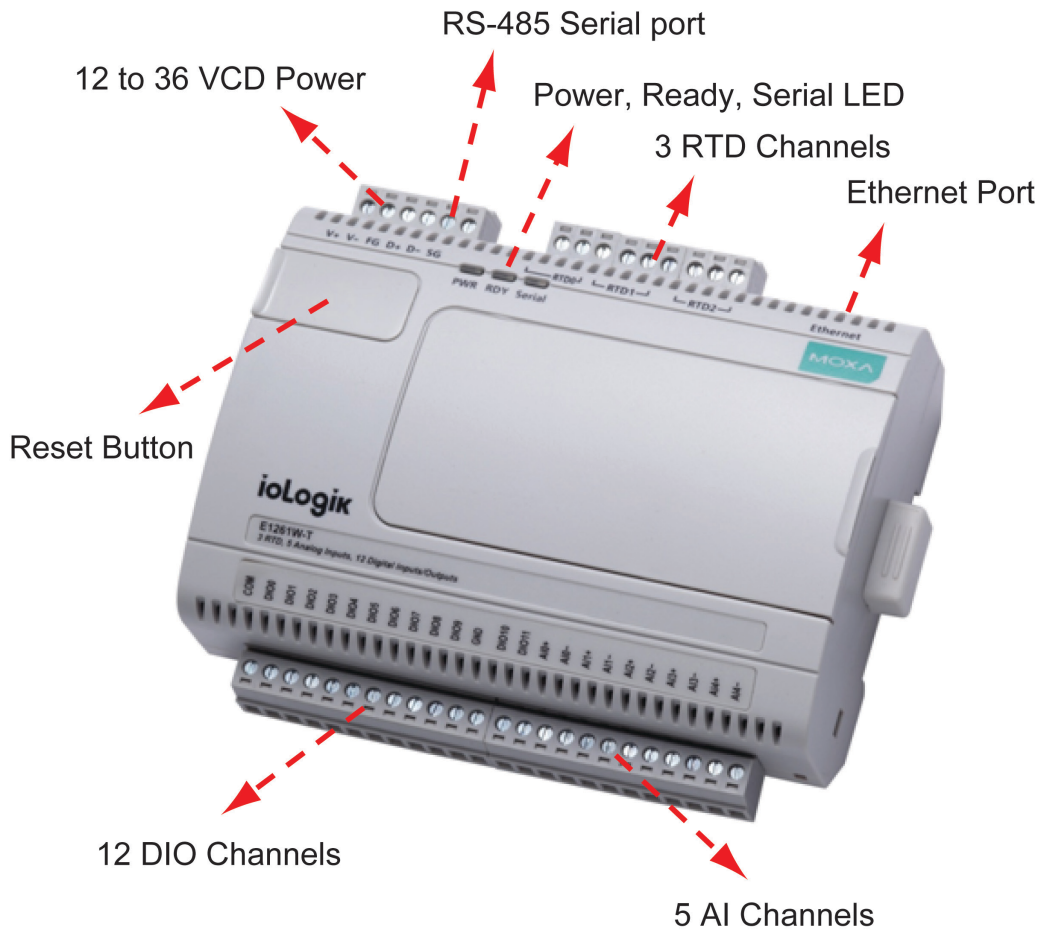

NOTE The RESET button restarts the server and resets all settings to factory defaults. Use a pointed object such as a straightened paper clip to hold down the RESET button for 5 seconds. The factory defaults will be loaded once the READY LED turns green again. You may then release the RESET button.

Ethernet Port

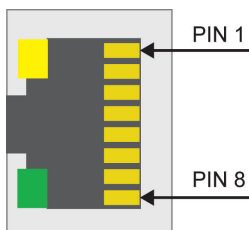

Pin	1	2	3	4
Signal	TXD+	TXD-	RXD+	---

Pin	5	6	7	8
Signal	---	RXD-	---	---

LED Indicators

LED	State	Description
Power	Red	System power is ON
	Off	System power is OFF
RDY	Green	System is ready
	Blinking	System in safe mode
	Off	System is not ready
Serial	Off	Serial port not connected
	Green	Serial port connected
	Blinking	Sending and receiving data
Ethernet	Amber	Ethernet connection enabled at 10 Mbps
	Green	Ethernet connection enabled at 100 Mbps
	Flashing	Transmitting or receiving data

This chapter describes how to install the ioLogik E1261W-T.

The following topics are covered in this chapter:

▣ **Hardware Installation**

- Connecting the Power
- Grounding the ioLogik E1261W-T
- Connecting to the Network
- I/O Wiring Diagrams

▣ **ioSearch™ Installation**

▣ **Load Factory Default Settings**

Hardware Installation

Connecting the Power

Connect the 12 to 36 VDC power line to the ioLogik E1261W-T's terminal block (TB1). If power is properly supplied, the **Power** LED will glow a solid red color.



ATTENTION

Determine the maximum possible current for each power wire and common wire. Observe all electrical codes dictating the maximum current allowable for each wire size. If the current exceeds the maximum rating, the wiring may overheat, causing serious damage to your equipment. For safety reasons, we recommend an average cable size of 22 AWG. However, depending on the current load, you may want to adjust your cable size (the maximum wire size for power connectors is 2 mm).

Grounding the ioLogik E1261W-T

The ioLogik E1261W-T is equipped with two grounding points, one on the wallmount socket and the other on the DIN-rail mount. Both grounding points are connected on the same conducting pathway.

Connect the ground pin () if earth ground is available.

Connecting to the Network

The ioLogik E1261W-T has two built-in RJ45 Ethernet ports for connecting a standard direct or cross-over Ethernet cable to either the host PC or another ioLogik E1261W-T device. For initial setup of the ioLogik E1261W-T, it is recommended that the ioLogik E1261W-T be configured using a direct connection to a host computer rather than remotely over the network.

Configure the host PC's IP address to 192.168.127.xxx (where xxx ranges from 001 to 253). When using Windows, you will need to configure from the Control Panel.

ioLogik E1261W-T Default IP Address	Default Netmask	Default Gateway
192.168.127.254	255.255.255.0	None

Use the web console or ioSearch™ configuration utility to connect to the ioLogik E1261W-T. Once the ioLogik E1261W-T has been detected, modify the settings as needed for your network environment, and then restart the server. Refer to Chapters 3 and 4 for further details.

I/O Wiring Diagrams

DI Dry Contact

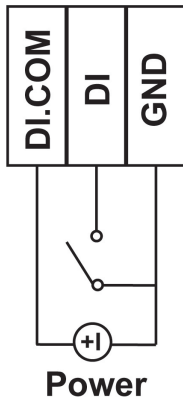

DI Wet Contact

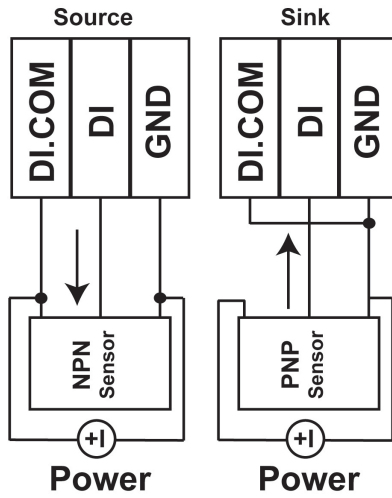

A **Dry Contact** is a contact that does not provide voltage.

A **Wet Contact** is a contact that will provide voltage when closed.

Voltage/Current

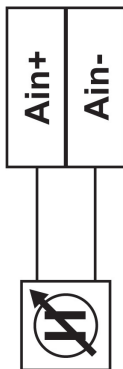

DO (Sink)

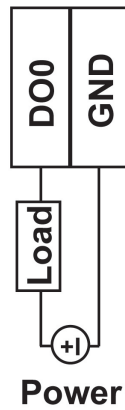

0-10V 4-20 mA

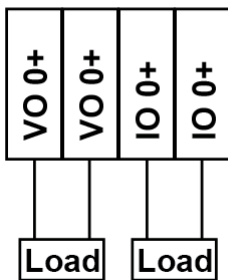

2-Wire RTD

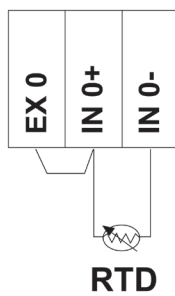

3-Wire RTD

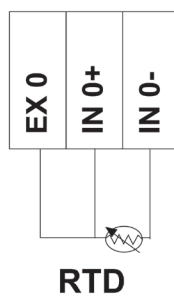

ioSearch™ Installation

ioSearch™ is a search utility that helps the user locate ioLogik E1261W-T devices on the local network. You may download the latest version of ioSearch from Moxa's website.

1. **Installing ioSearch™:** Download the ioSearch™ utility from Moxa's website, double click the installation file, and then follow the installation wizard's instructions to complete the installation. You can also download and install the MXIO DLL library separately.
2. **Open ioSearch:** After installation is finished, run ioSearch™ from **Start → Program Files → MOXA → IO Server → Utility → ioSearch.**
3. **Search the network for the server:** On the menu bar, select **System → Auto Scan Active Ethernet I/O Server.** A dialog window will pop up. Click **Start Search** to begin searching for the ioLogik E1261W-T.

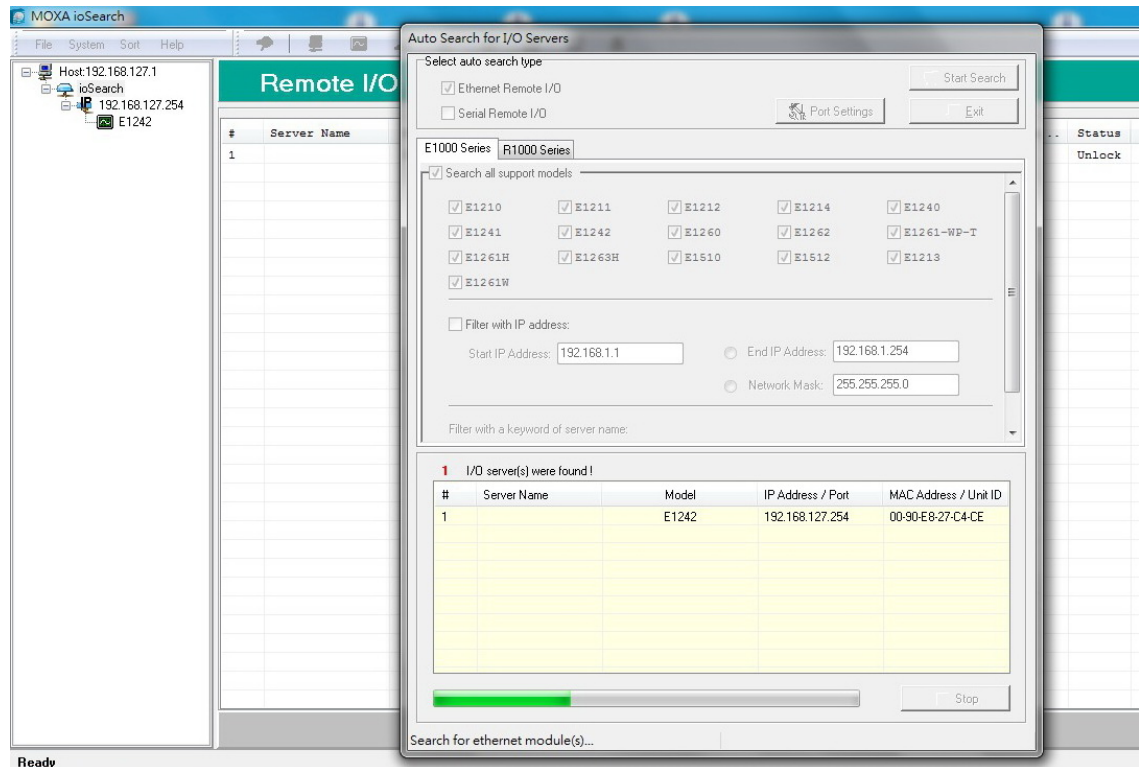

If multiple ioLogik E1261W-T units are installed on the same network, remember that each unit has the same default IP address. You will need to assign a different IP address to each unit to avoid IP conflicts.

Load Factory Default Settings

There are three ways to restore the ioLogik E1261W-T to factory default settings.

1. Hold down the RESET button for 5 seconds
2. Right-click on the specific ioLogik device in the ioSearch™ utility and select **Reset to Default**
3. Select **Load Factory Default** from the web console

Using the Web Console

The ioLogik E1261W-T's main configuration and management utility is the built-in web console, which can be used to configure a wide range of options.

The following topics are covered in this chapter:

- ❑ **Introduction to the Web Console**
- ❑ **Overview**
- ❑ **Network Settings for the Web Console**
 - General Settings
 - Ethernet Configuration
- ❑ **User-Defined Modbus Addressing**
 - Default Modbus Address
- ❑ **Active OPC Server Settings**
- ❑ **Tag Generation**
- ❑ **I/O Settings**
 - DI Channels
 - AI Channels
 - AI Input Range
 - RTD Channels
- ❑ **System Management**
 - Accessibility IP List
 - Network Connection
 - Firmware Update
 - Import System Configuration Settings
 - Export System Settings
 - RS-485 Setting
- ❑ **Change Password**
- ❑ **Load Factory Defaults**
- ❑ **Save/Restart**

Introduction to the Web Console

The ioLogik E1261W-T web console is a browser-based configuration utility. When the ioLogik E1261W-T is connected to your network, you may enter the server's IP address in your web browser to access the web console.

The screenshot shows the web console interface for the ioLogik Remote Ethernet I/O Server. At the top, the MOXA logo and the title "ioLogik Remote Ethernet I/O Server" are visible, along with the website URL "www.moxa.com". Below the header, there is a status bar displaying key system information:

- Model: E1261W-T Ethernet IO Server
- Name: -
- Location: -
- IP: 192.168.127.254
- Serial No.: 05660
- System Elapsed Time: 00:00:55
- MAC Address: 00-90-e8-2f-fe-9a
- Firmware: V1.0 Build13091719

The interface is divided into two main sections:

- Navigation Panel (Left):** Contains a menu tree for navigating through various settings and categories. The menu items include:
 - Main Menu - E1261W-T
 - Overview
 - Network Settings
 - User-defined Modbus Addressing
 - AOPC Server Settings
 - I/O Settings
 - System Management
 - RS-485 Settings
 - Change Password
 - Load Factory Default
 - Save/Restart
- Main Window (Right):** Displays the current configuration and status. It includes:
 - Welcome to ioLogik Series**
 - Remote Ethernet I/O Server** section with details:
 - Model Name: E1261W-T
 - Serial Number: 05660
 - Firmware Version: V1.0 Build13091719
 - BIOS Version: V1.0.0
 - Ethernet IP Address: 192.168.127.254
 - Ethernet MAC Address: 00-90-e8-2f-fe-9a
 - I/O Status** section, which is a table showing the status of DI channels:

DI Channel	Mode	Status	Filter	Counter Trigger
DI-00	DI	OFF	100.0 ms	--
DI-01	DI	OFF	100.0 ms	--
DI-02	DI	OFF	100.0 ms	--
DI-03	DI	OFF	100.0 ms	--

The left panel is the navigation panel and contains an expandable menu tree for navigating among the various settings and categories. When you click on a menu item in the navigation panel, the main window will display the corresponding options for that item. Configuration changes can then be made in the main window. For example, if you click on **Network Settings** in the navigation panel, the main window will show a page of basic settings that you can configure.

You must click on the **Submit** button after making configuration changes. The **Submit** button will be located at the bottom of every page that has configurable settings. If you navigate to another page without clicking the **Submit** button, your changes will not be retained.

Submitted changes will not take effect until they are saved and the ioLogik E1261W-T is restarted!

You may save and restart the server in one step by clicking on the **Save/Restart** button after you submit a change. If you need to make several changes before restarting, you may save your changes without restarting by selecting **Save/Restart** in the navigation panel. If you restart the ioLogik E1261W-T without saving your configuration, the ioLogik E1261W-T will discard all submitted changes.

Overview

The **Overview** page contains basic information about the ioLogik E1261W-T, including the model name, serial number, firmware version, MAC address, and current IP address. Most importantly, you can see the current I/O status by pressing the F5 key on the computer keyboard to refresh the page.

The screenshot displays the web console interface for the ioLogik Remote Ethernet I/O Server. At the top, the MOXA logo and the title 'ioLogik Remote Ethernet I/O Server' are visible, along with the website URL 'www.moxa.com'. Below this, a green header bar contains system information:

- Model: E1261W-T Ethernet IO Server
- Name: -
- Location: -
- IP: 192.168.127.254
- Serial No.: 05660
- System Elapsed Time: 00:00:55
- MAC Address: 00-90-e8-2f-fe-9a
- Firmware: V1.0 Build13091719

A 'Welcome to ioLogik Series' message is followed by a section titled 'Remote Ethernet I/O Server' which lists the following details:

- Model Name: E1261W-T
- Serial Number: 05660
- Firmware Version: V1.0 Build13091719
- BIOS Version: V1.0.0
- Ethernet IP Address: 192.168.127.254
- Ethernet MAC Address: 00-90-e8-2f-fe-9a

Below this is the 'I/O Status' section, which contains a table with the following data:

DI Channel	Mode	Status	Filter	Counter Trigger
DI-00	DI	OFF	100.0 ms	--
DI-01	DI	OFF	100.0 ms	--
DI-02	DI	OFF	100.0 ms	--
DI-03	DI	OFF	100.0 ms	--

Network Settings for the Web Console

General Settings

On the **General Settings** page, you can assign a server name and location to assist you in differentiating between different ioLogik E1261W-T units. You may also configure the Modbus/TCP timeout interval or enable the **Communication Watchdog** function.

General Settings

I/O Server Settings

Server Name

Server Location

Enable Server Socket Idle Connection Timeout Interval sec (1-65535, default = 60, disable = 0)

Enable communication watchdog sec (1-65535, default = 0, disable = 0)

Locate I/O Server

Enable Server Socket Idle Connection Timeout Interval automatically disconnects the Modbus/TCP connection from the server after a specified time period to free up the port for the next connection.

Enable Communication Watchdog activates **Safe Mode** when a specified period of time has passed and there is a loss of Modbus/TCP network connectivity. **Safe Mode** is specially designed for products with output channels to output a suitable value (see Chapter 3: **AO Safe Mode Setting**) or status (see Chapter 3: **DO Safe Mode Setting**) when the ioLogik E1261W-T cannot be controlled by a remote PC (such as in the event of a network failure). By default, the watchdog is disabled. Users can configure how each output channel responds on the I/O Settings page.

To enable the Communication Watchdog function, select the **Enable Communication Watchdog** checkbox, set the timeout value, and then restart the server. When the watchdog is enabled, the ioLogik E1261W-T will enter **Safe Mode** after there is a disruption in communication that exceeds the specified time limit.

Enable I/O Locate enables remote toggling of the **Ready** LED from off to flashing to enable remote control of LEDs for easier location of devices when troubleshooting.

Ethernet Configuration

On the **Ethernet Configuration** page, you can set up a static or dynamic IP address for the ioLogik E1261W-T, and configure the subnet mask and gateway address.

Ethernet Configuration

Ethernet Parameters	
IP Configuration	Static
IP Address	192.168.127.254
Subnet Mask	255.255.255.0
Gateway	0.0.0.0

User-Defined Modbus Addressing

The input and output address can be configured in a different format on a specific settings page. Check the **Enable User-defined Modbus Addressing** box, select the Modbus function, and then configure the start address of each item.

User-defined Modbus Addressing

Enable User-defined Modbus Addressing

User-defined Modbus address							
No.	Description	User-defined Start Address (DEC)	Function Code	Read/Write	Reference Address (DEC)	Total Channels	Data Type
1	DI Value	0001	02:INPUT STATUS	R	10001	16	1 bit
2	DI Counter Value (Double Word)	0017	01:COIL STATUS 02:INPUT STATUS 03:HOLDING REGISTER 04:INPUT REGISTER	R	30017	16	2 WORD
3	DI Value All Channel (Ch0-Ch15)	0049	01:COIL STATUS	R	30049	1	1 WORD
4	DI Counter Start/Stop	0257	01:COIL STATUS	RW	00257	16	1 bit
5	DI Counter Clear	0273	01:COIL STATUS	RW	00273	16	1 bit

Default Modbus Address

You can view the default Modbus address for all I/O devices on the **Default Modbus Address** settings page. However, only the starting address will be displayed for each item with multiple reference addresses. For example, if the reference addresses for DI Value start from 10001 and the second DI channel's reference address is 10002, only the first DI channel's Modbus address of 10001 will be displayed. See the diagram below.

Default Modbus Address

Default Modbus address							
No.	Description	User-defined Start Address (DEC)	Function Code	Read/Write	Reference Address (DEC)	Total Channels	Data Type
1	DI Value	0001	02:INPUT STATUS	R	10001	16	1 BIT
2	DI Counter Value Double Word	0017	04:INPUT REGISTER	R	30017	16	2 WORD
3	DI Value All Channel (Ch0-Ch15)	0049	04:INPUT REGISTER	R	30049	1	1 WORD
4	DI Counter Start/Stop	0257	01:COIL STATUS	RW	00257	16	1 BIT
5	DI Counter Clear	0273	01:COIL STATUS	RW	00273	16	1 BIT



ATTENTION

Disable the user-defined Modbus addressing function if using the MXIO (.NET) library or Active OPC Server to control or monitor the ioLogik E1261W-T's I/O status.

Active OPC Server Settings

Moxa's Active OPC Server™ is a software package operated as an OPC driver of an HMI or SCADA system. It seamlessly connects Moxa's ioLogik products to a wide variety of SCADA systems, including the most popular: Wonderware, Citect, and iFix. Active OPC Server™ conforms to the OPC Foundation's latest data access standard, DA 3.0, to connect with other standards-compliant devices and host OPC machines.

Hardware Requirements	
CPU	Intel Pentium 4 and above
RAM	512 MB (1024 MB recommended)
Network Interface	10/100 MB Ethernet
Software Requirements	
Operating System	Microsoft Windows 2000, XP or later
Editor (not required)	Microsoft Office 2003 (Access 2003) or later
OPC Server Specifications	
OPC Data Access	1.0a, 2.0, 2.05a, 3.0
Max. No. of Tags	5000 (V1.12 or later)

Active OPC Server can be downloaded from the Moxa website support page at www.moxa.com/support/.

After downloading the Active OPC Server file, unzip the file and run Install.exe. The installation program will guide you through the installation process and install the Active OPC Server Utility.

For more details on Active OPC Server installation and use, please refer to the Active OPC Server user's manual or Chapter 5.

Tag Generation

Use the web console to create Active OPC (AOPC) tags for the ioLogik E1261W-T by opening your browser and navigating to the **Active OPC Server Settings** page.

Follow these steps to create the tags and send them from the ioLogik E1261W-T to Active OPC Server:

1. On the **AOPC & I/O Settings** page, select the **Enable Active OPC** checkbox and specify the IP address where the Active OPC Server is installed.
2. Select the I/O channels that need to be created in Active OPC Server.
3. Configure the **Heartbeat Interval**, if necessary.

NOTE The **Heartbeat Interval** can be used to determine the connection status between the ioLogik E1261W-T and Active OPC Server, and to ensure that the ioLogik is connected and alive. If the heartbeat interval is set and the network between the ioLogik E1261W-T and Active OPC Server is down, Active OPC Server will detect the stopped heartbeat and the **Quality** column in the Active OPC will display BAD to indicate the loss of connectivity.

The screenshot shows the Moxa web console interface. At the top, there is a header with the Moxa logo, the title "ioLogik Remote Ethernet I/O Server", and the website "www.moxa.com". Below the header is a status bar with system information: Model (E1261W-T Ethernet IO Server), Name, Location, IP (192.168.127.254), Serial No. (05660), System Elapsed Time (00:00:55), MAC Address (00-90-e8-2f-fe-9a), and Firmware (V1.0 Build13091719). The left navigation menu includes "Main Menu - E1261W-T" with sub-items like Overview, Network Settings, General Settings, Ethernet Configuration, User-defined Modbus Addressing, Default Address, AOPC Server Settings, AOPC & I/O Settings (highlighted with a red box), Create AOPC Tag, I/O Settings, System Management, and RS-485 Settings. The main content area is titled "Active OPC Server Settings" and contains:

- An "Enable Active OPC" checkbox.
- A table with columns "No.", "IP Address", and "Port". Two rows are visible, both with "9900" in the Port column.
- An "I/O Channel Settings" section with an "Update by" dropdown set to "I/O On Change" and a "Heartbeat Interval" set to "1" second with a value of "1-65535".
- Checkboxes for "Enable All DI Channels" and "Enable All DO Channels", each followed by a list of channels (Ch00 to Ch11) with individual checkboxes.

4. Click the **Submit** button and then the **Save/Restart** button on the next page.

Configuration Complete!

Warning! The changes will take effect until you Save/Restart the I/O Server.

You can Save / Restart the I/O Server now or Save / Restart the I/O Server when all settings complete.

- On the **Create AOPC Tag** page, click on the **Create Tags** button to “push” tag configurations to the Active OPC Server utility.

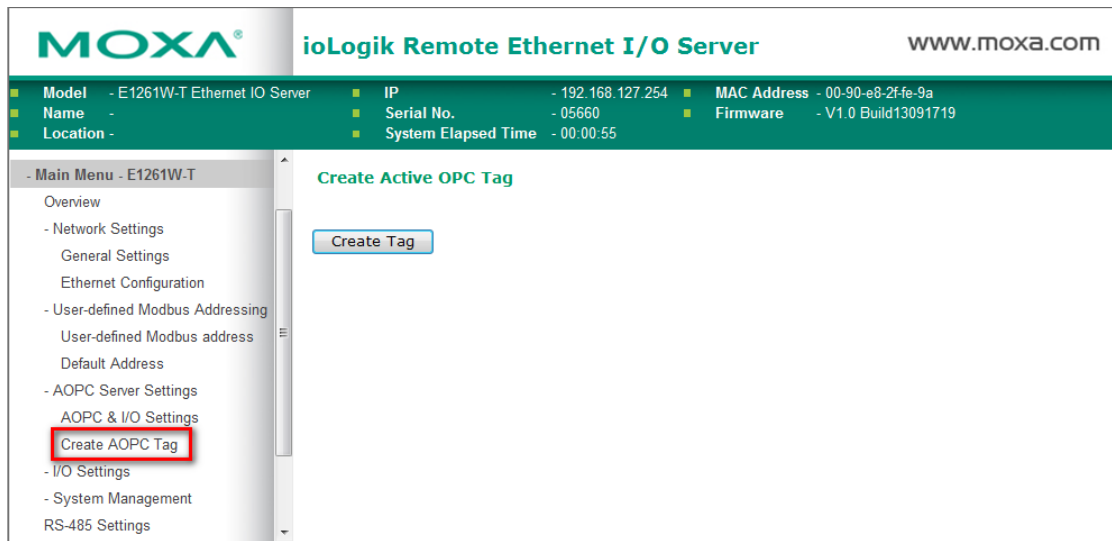

- Launch the Active OPC Server utility and the tags will be automatically created. Remember to save the configuration of the Active OPC Server when exiting the program.

I/O Settings

DI Channels

The status of each DI (digital input) channel appears on the **DI Channel Settings** page.

DI Channel Settings

Refresh page

DI Channel	Mode	Status	Filter	Counter Trigger
DI-00	DI	OFF	100.0 ms	--
DI-01	DI	OFF	100.0 ms	--
DI-02	DI	OFF	100.0 ms	--
DI-03	DI	OFF	100.0 ms	--
DI-04	DI	OFF	100.0 ms	--
DI-05	DI	OFF	100.0 ms	--
DI-06	DI	OFF	100.0 ms	--
DI-07	DI	OFF	100.0 ms	--
DI-08	DI	OFF	100.0 ms	--
DI-09	DI	OFF	100.0 ms	--
DI-10	DI	OFF	100.0 ms	--
DI-11	DI	OFF	100.0 ms	--

You can also configure each channel’s digital input mode and parameters by clicking on the channel. DI channels can operate in **DI mode** or **Event Counter mode**.

DI Channel 0 Settings

Mode	Filter	Counter Trigger	Counter Start
1. Current Setting			
DI	100		
DI			
Counter			
3. Safe Status Setting			

Activate **Event Counter** mode by selecting the **Counter Start** field and configure the **Counter Trigger** by selecting **Lo to Hi**, **Hi to Lo**, or **Both** from the dropdown menu. When the **Counter Start** field is not selected, you can still activate the counter by using Modbus commands.

NOTE Confirm that the Counter Filter is not set to 0; otherwise, the counter will never be activated.

DI Channel 0 Settings

Mode	Filter	Counter Trigger	Counter Start
1. Current Setting			
Counter ▾	100	Lo to Hi ▾	<input type="checkbox"/>
2. Power On Setting			
		Lo to Hi Hi to Lo Both	<input type="checkbox"/>

Power On Settings: You may configure DI channels in **Event Counter** mode whether or not counting begins when powering up.

Safe Status Settings: For DI channels in Event Counter mode, you can configure whether or not counting starts or continues when Safe Status has been activated. When the network connection is lost, as specified in the Host Connection Watchdog, the ioLogik E1261W-T will start or stop the counter according to the channel's Safe Status settings.

NOTE The Host Connection Watchdog is disabled by default, and must be enabled for Safe Status settings to take effect.

Save Status On Power Failure: The ioLogik E1261W-T will automatically save the counter value when there is a power failure if this function selected.

Reset Counter: Select this function to reset the counter.

2. Power On Setting	<input type="checkbox"/>
3. Safe Status Setting	<input type="checkbox"/>
4. Save Status On Power Failure	<input type="checkbox"/>
5. Reset Counter	<input type="checkbox"/>

The DI channel's **Alias Name** and logic definition can also be configured on this page. You can apply the alias name to all channels by selecting the **Apply to all DI channels** checkbox.

Apply to all DI channels

Alias name of channel

DI

Alias name of "OFF" status

OFF

Alias name of "ON" status

ON

DI Channel Specification:

Apply to all DI channels

5. Alias Name

Alias name of channel

DI

Alias name of "OFF" status

OFF

Alias name of "ON" status

ON

Submit Close

Note1: Filter unit=1ms, range=1~65535.

Note2:

Sensor Type -> Wet Contact (Source or Sink) and Dry Contact.

Dry Contact -> OFF : Open.

-> ON : Short to GND.

Wet Contact (Source/PNP) -> OFF : 10 - 30VDC.

-> ON : 0 - 3 VDC.

Wet Contact (Sink/NPN) -> OFF : 0 - 3 VDC.

-> ON : 10 - 30VDC.

WARNING: Be sure to Save/Restart your settings.

AI Channels

The current status of each AI (analog input) channel can be viewed on the **AI Channel Settings** page.

AI Channel Settings

Refresh page

Clear Max.and Min.

AI Channel	Range	Value	Min.	Max.
AI-00	0-10V	0.010V	0.007V	0.010V
AI-01	0-10V	0.009V	0.009V	0.012V
AI-02	0-10V	0.009V	0.006V	0.009V
AI-03	0-10V	0.007V	0.007V	0.010V
AI-04	0-10V	0.010V	0.010V	0.013V
AI-05	0-10V	0.009V	0.009V	0.012V
AI-06	0-10V	0.008V	0.008V	0.011V
AI-07	0-10V	0.009V	0.009V	0.012V

Click on a specific AI channel to enable or disable it by selecting the **Enable AI Channel** field. There are two modes available for the AI channels:

1. **Voltage Mode**

Enable AI Channel

AI Input Range

0-10V

X Settings (Only "4-20mA BurnOut")

3.000 (0.000 - 3.999 mA)

* (0 < X (mA), RAW Data=0)

2. Current Mode

Enable AI Channel

AI Input Range

4-20mA

X Settings (Only "4-20mA BurnOut")

3.000 (0.000 - 3.999 mA)

* (0 < X (mA), RAW Data=0)

Auto Scaling and Slope-intercept functions of the AI value can be defined on this page.

Auto Scaling Settings

- Disable Scaling
- Enable Point-Slope formula

	Actual (x.xxx)		Scaled (x.xxx)
Min (n1)	<input type="text"/>	Min (n2)	<input type="text"/>
Max (m1)	<input type="text"/>	Max (m2)	<input type="text"/>
Unit	<input type="text"/>	Unit	<input type="text"/>

*Result = n2 + (input - n1) x [(m2-n2)/(m1-n1)]

- Enable Slope-intercept

M=

D=

Unit

*Result = M x Input + D

- Apply to All Channels

AI Input Range

Set the AI input ranges for each mode, as follows:

1. Voltage Mode (V)

There is only one default analog Voltage input range: [0-10V]

2. Current Mode (mA)

There are three modes in the analog Current input range: [4-20 mA], [0-20 mA], [4-20 mA (Burn Out)]

AI Input: Current Mode

Enable AI Channel

AI Input Range

0-10V

0-10V

4-20mA

4-20mA (Burn Out)

0-20mA

(0.000 - 3.999 mA)

* (0 < X (mA), RAW Data=0)

AI Input: Burn Out Mode

Burn Out mode indicates when the Current AI has burned out. For example, the 4–20 mA **Burn Out** mode is defined in the following diagram:

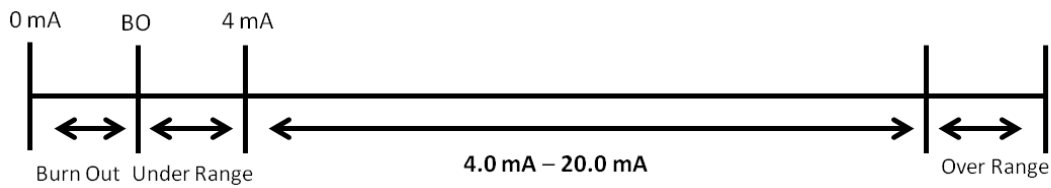

Users can define **Burn Out** (BO) values (default = 2 mA) for selected ranges. When input values are in the **Burn Out** range, raw data will register as 0000h to indicate that the analog input has burned out. The definition of raw data is as follows:

Burnout Value (BO)	0.0 < BO < 4.0	User defined (default 2 mA)
Burnout State	0 ≤ AI < BO mA	S/W output 0000h
Under Range	BO ≤ AI < 4 mA	S/W output raw data
Normal Range	4 ≤ AI ≤ 20.00 mA	S/W output raw data until FFFEh
Over Range	XX > 20.00 mA	S/W output FFFFh

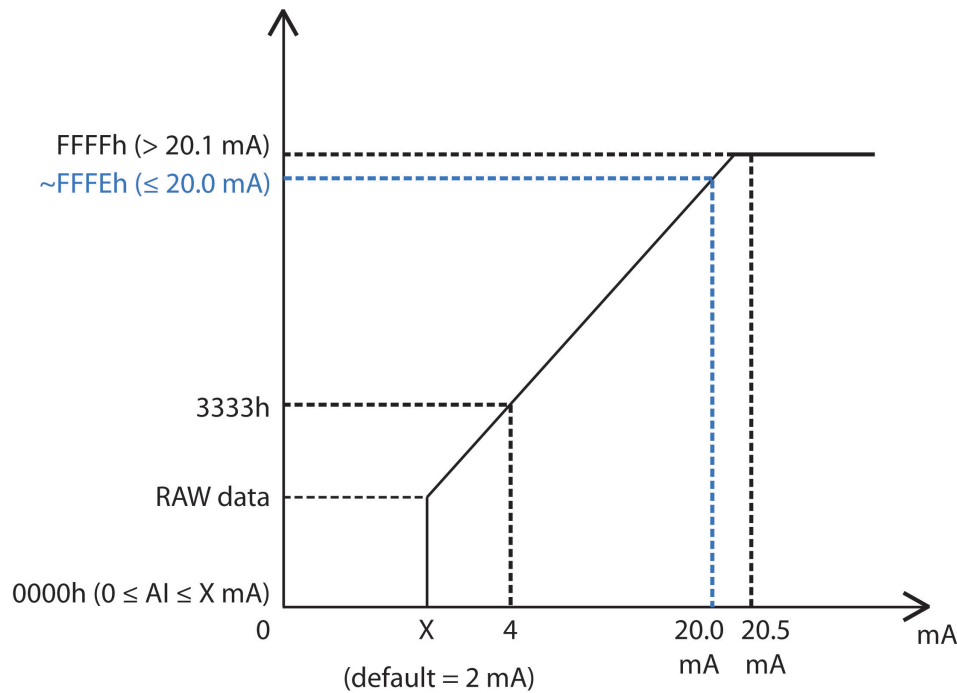

Selecting **Enable Point-Slope formula** on the **Auto Scaling Settings** page will linearly convert the actual current or voltage value into other user-defined units, such as percentage or ppm (parts per million).

NOTE The scaled value's Modbus address differs from the original value.

Auto Scaling Settings

- Disable Scaling
- Enable Point-Slope formula

	Actual (x.xxx)		Scaled (x.xxx)
Min (n1)	<input type="text" value="0.000"/>	Min (n2)	<input type="text" value="0.000"/>
Max (m1)	<input type="text" value="10.000"/>	Max (m2)	<input type="text" value="1000.000"/>
Unit	<input type="text" value="V"/>	Unit	<input type="text" value="ppm"/>

*Result = n2 + (input - n1) × [(m2-n2)/(m1-n1)]

The slope-intercept function is used to compensate when the measurement requires a slight adjustment.

Enable Slope-intercept

M=	1.1
D=	0.02
Unit	V

*Result = M x Input + D

The AI channel's **Alias Name** can also be configured on this page.

Alias Name of Channel

RTD Channels

The current status of each RTD (Resistance Temperature Detector) channel can be viewed on the **RTD Channel** page.

RTD Channel Settings

RTD Channel	Sensor Type	Range	Status	Value	Min	Max
RTD-00	PT 100	-200 ~ 850°C	Enabled	--	--	--
RTD-01	PT 100	-200 ~ 850°C	Enabled	--	--	--
RTD-02	PT 100	-200 ~ 850°C	Enabled	--	--	--

Click on a specific channel to access the RTD channel settings.

Select the **Enable RTD Channel** checkbox and then select the sensor type from the dropdown menu that meets the physical attachment to the ioLogik E1261W-T.

RTD Channel 0 Settings

Enable RTD Channel

RTD Sensor Type	Range	Unit
PT 100 ($\alpha = 0.00385$)	-200 ~ 850	°C

Apply to All Channels

Alias Name Settings

Alias Name of Channel

WARNING: Be sure to Save/Restart your settings

The ioLogik E1261W-T allows you to calibrate the temperature sensors. In each channel configuration section, follow the instructions and click **Calibrate** button to start the RTD sensor calibration. Each calibration requires around 30 seconds per channel.

Calibration

Select Channel :

Sensor Type:

1. Ensure the sensor is connected.
2. Ensure the channel and its sensor type is correctly selected.
3. Put the sensor into a glass that contains a mixture of ice and water.
4. Click on the "Calibrate" button.
5. Wait until the page shows "Calibration Completed".

NOTE:

1. Do not remove the sensor from the ice water during calibration.
2. Load factory default will clear the current calibrated settings.

NOTE: Resistance types of sensors are not supported to be calibrated.

The ioLogik E1261W-T allows you to manually adjust the current temperature reading. In each channel configuration section, select the channel, apply the offset value, and click the **Submit** button.

Offset

Channel	Offset	Unit
Select Channel : <input type="text" value="Channel 0"/>	<input type="text" value="1.8"/>	<input type="text" value="°C"/>

NOTE: Offset range: -1000.0 to +1000.0, unit = 0.1 °C/°F.

System Management

Accessibility IP List

You can control network access to the ioLogik E1261W-T from the **Accessibility IP List** page by enabling access only from specific IP addresses. When the **Enable the accessibility IP list** checkbox is enabled, a host's IP address must be provided and enabled in the list in order to gain access to the ioLogik E1261W-T.

Accessibility IP List

Enable the accessibility IP List (if unchecked, all connection requests will be accepted.)

No.	Enable	IP Address	Netmask
1	<input checked="" type="checkbox"/>	192.168.127.253	255.255.255.255
2	<input checked="" type="checkbox"/>	192.168.1.0	255.255.255.0
3	<input type="checkbox"/>	0.0.0.0	255.255.255.0
4	<input type="checkbox"/>	0.0.0.0	255.255.255.0
5	<input type="checkbox"/>	0.0.0.0	255.255.255.0
6	<input type="checkbox"/>	0.0.0.0	255.255.255.0
7	<input type="checkbox"/>	0.0.0.0	255.255.255.0
8	<input type="checkbox"/>	0.0.0.0	255.255.255.0
9	<input type="checkbox"/>	0.0.0.0	255.255.255.0
10	<input type="checkbox"/>	0.0.0.0	255.255.255.0

Enable access for a range of IP addresses by specifying the IP address and netmask, as follows:

To allow access for a specific IP address

Enter the IP address in the **IP Address** field and 255.255.255.255 in the **Netmask** field.

To allow access for hosts on a specific subnet

Enter 0 as the last digit in both the **IP Address** field and **Netmask** field (e.g., 192.168.1.0 and 255.255.255.0).

To allow unrestricted access

Deselect the **Enable the accessible IP list** option.

Refer to the following table for additional configuration examples.

Allowed Hosts	IP Address/Netmask
Any host	Disable
192.168.1.120	192.168.1.120 / 255.255.255.255
192.168.1.1 to 192.168.1.254	192.168.1.0 / 255.255.255.0
192.168.0.1 to 192.168.255.254	192.168.0.0 / 255.255.0.0
192.168.1.1 to 192.168.1.126	192.168.1.0 / 255.255.255.128
192.168.1.129 to 192.168.1.254	192.168.1.128 / 255.255.255.128

Network Connection

TCP connections from other hosts appear on the Network Connection page. This information can assist you with managing your devices.

Network Connection

Total TCP/IP Connection(s)

1

Source Host Address	Connection Type
192.168.19.201	Web/HTTP

Firmware Update

Load new or updated firmware onto the ioLogik from the Firmware Update page.

Firmware Update

Choose a new firmware file path :

D:\FWR_E1261W_V1.0_Build13100915_STD.1kp

WARNING:

1. The firmware update process may take a few minutes.
2. NOTE! Once you click the "Update" button, the update process cannot be canceled.
3. DO NOT DISCONNECT POWER OR NETWORK CABLE during the update process, since doing so could cause the firmware to become corrupted.

Import System Configuration Settings

Import a configuration into the ioLogik server from the Import System Config page. This function can be used to duplicate settings between ioLogik servers. You will be prompted for the location of the configuration file (i.e., "ik1261.txt").

Import System Configuration File

Update network settings (IP, Gateway, etc.)

Choose a system configuration file path :

C:\jk1261.txt

WARNING:

1. The file import process could take up to 10 seconds.
2. DO NOT DISCONNECT POWER OR NETWORK CABLE during the upload process, since doing so could cause the system to become corrupted.

Export System Settings

On the **Export System Settings** page, you can export a copy of the ioLogik's configuration file for backup or import into another ioLogik server.

Export System Settings

Click "[ik1261.txt](#)" to export & save system settings.

RS-485 Setting

The RS-485 port is used to communicate with other RS-485 devices or to link to another ioLogik RS-485 I/O server. The RS-485 port can run Modbus/RTU or I/O command sets. The baudrate is set under the **RS-485 Setting** field. The default settings are: baudrate = 115200; parity check = N; data bits = 8; and stop bit = 1.

RS-485 Configuration

RS-485 Parameters

Modbus ID	<input type="text" value="1"/>
Baud rate	<input type="text" value="115200"/>
Data bit	<input type="text" value="8"/>
Stop bit	<input type="text" value="1"/>
Parity	<input type="text" value="none"/>

Change Password

For all changes to the ioLogik E1261W-T's password protection settings, you will first need to enter the old password. Leave this blank if you are setting up password protection for the first time. To set up a new password or change the existing password, enter your desired password under both **New password** and **Confirm password**. To remove password protection, leave the **New password** and **Confirm password** fields blank.

Change Password

Password

Old password :	<input type="password" value="...."/>
New password :	<input type="password" value=".."/>
Retype password :	<input type="password" value=".."/>



ATTENTION

If you forget the password, the **ONLY** way to configure the ioLogik E1261W-T is by using the Reset button to load the factory default settings.

Before you set a password for the first time, it is a good idea to export the configuration file when you have finished setting up your ioLogik E1261W-T. Your configuration can then be easily imported back into the ioLogik E1261W-T if you need to reset the ioLogik E1261W-T due to a forgotten password or for other reasons.

Load Factory Defaults

This function will reset all of the ioLogik E1261W-T's settings to the factory default values. All previous settings, including the console password, will be lost.

Load Factory Default

This function will reset the I/O Server settings to their factory default values. Current settings will be overwritten.

Save/Restart

If you change the configuration, do not forget to reboot the system.

Save/Restart

The configuration has been changed. Click Submit to reboot with the new configuration.

WARNING: Rebooting will disconnect your Ethernet connections and some data loss may occur.

This chapter describes ioSearch™, which is used to search for and locate ioLogik E1261W-T units.

The following topics are covered in this chapter:

- ❑ **Introduction to ioSearch™**
- ❑ **ioSearch™ Main Screen**
 - Main Screen Overview
- ❑ **ioSearch™ Setup**
 - System
 - Sort
 - Quick Links
- ❑ **Main Function**
 - Locate
 - Firmware Upgrade
 - Unlock
 - Import
 - Export
 - Change IP Address
 - Batch TCP/IP Configuration on Multiple Devices
 - Restart System
 - Reset to Default
 - Mass Deployment (Import)
 - Mass Deployment (Export)

Introduction to ioSearch™

Moxa's ioSearch™ utility is software tool that searches for ioLogik E1261W-T units on a physical network. The following functions are supported by the ioSearch™ utility:

- Search for and locate ioLogik E1261W-T units
- Configure IP addresses
- Upgrade firmware for multiple ioLogik E1261W-T units (same model)
- Export configuration files from multiple ioLogik E1261W-T units
- Import configuration files from multiple ioLogik E1261W-T units (same model)
- Reset to default for multiple ioLogik E1261W-T units

ioSearch™ Main Screen

Main Screen Overview

The main screen displays the results of a broadcast search for ioLogik E1261W-T units.

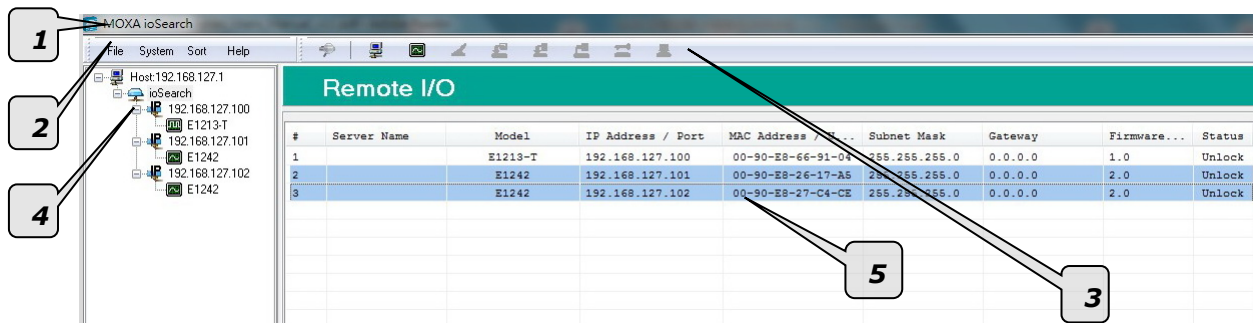

ioSearch™ Main Screen

1. Title
2. Menu bar
3. Quick link
4. Navigation panel
5. Main window

ioSearch™ Setup

System

Several operations are possible from the **System** menu.

Auto Scan Active Ethernet I/O Servers will search for ioLogik servers on the network. When connecting for the first time or recovering from a network disconnection, you can use this command to find I/O servers that are on the network.

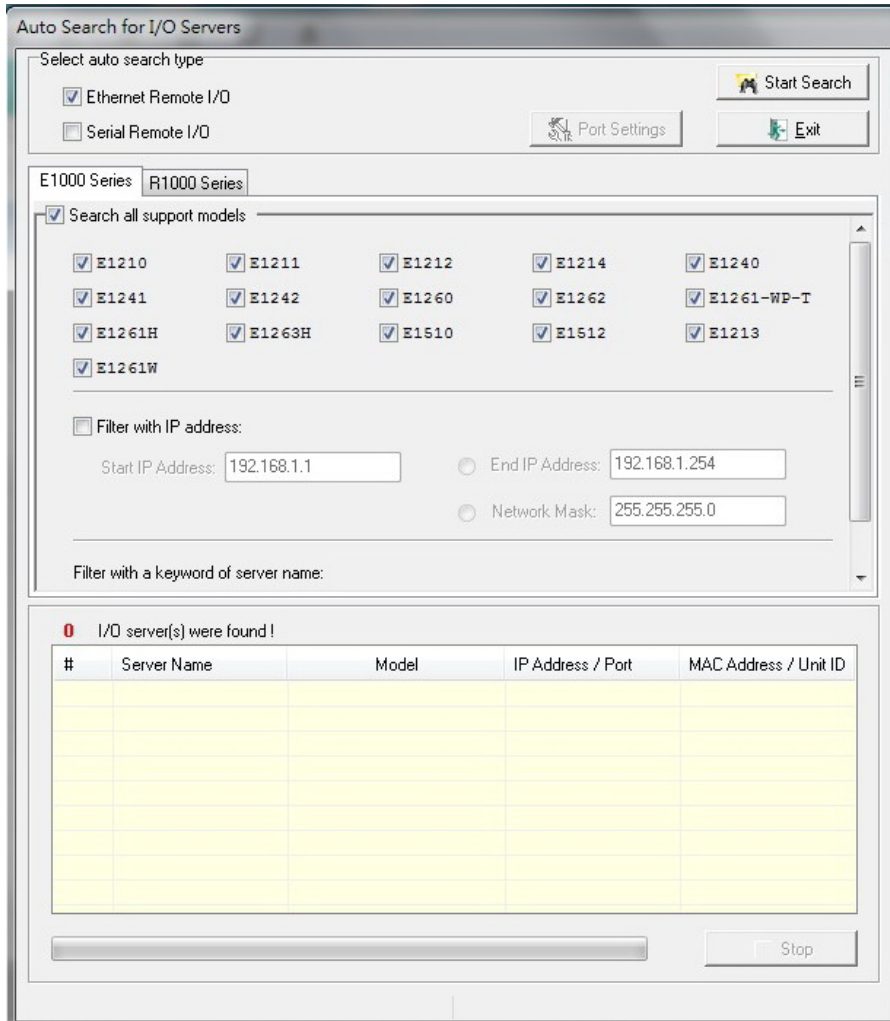

Network Interface allows you to select a network to use, if the PC has multiple network adaptors installed.

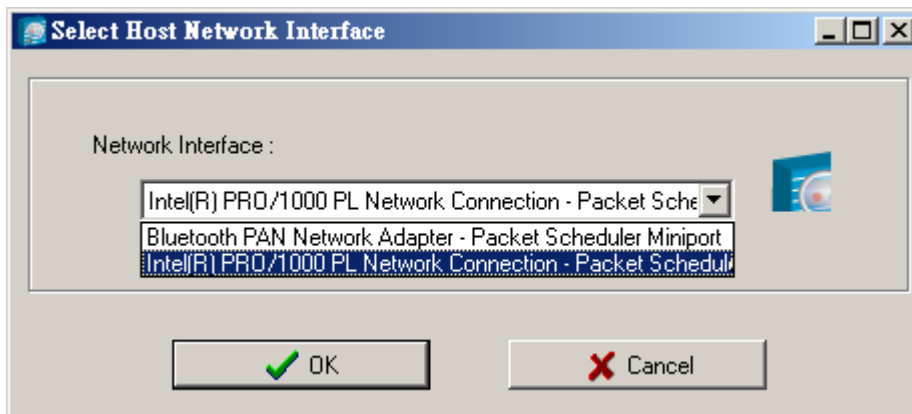

Sort

The **Sort** menu allows the server list in the navigation panel to be sorted by ioLogik connection and server (model).

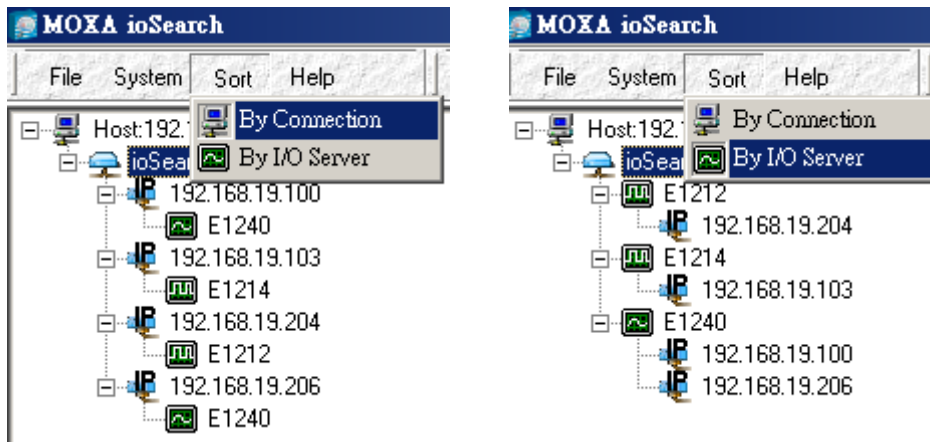

Quick Links

Quick links are provided to search for I/O servers on the network and sort the server list.



1	Automatically search the local network
2	Sort by ioLogik E1261W-T's IP address (connection)
3	Sort by ioLogik E1261W-T model
4	Locate an ioLogik E1261W-T
5	Upgrade Firmware
6	Import settings
7	Export settings
8	Unlock an ioLogik E1261W-T which is password protected
9	Change IP Address of an ioLogik E1261W-T

Main Function

Right click on a particular ioLogik E1261W-T to view the ioSearch™ function menu.

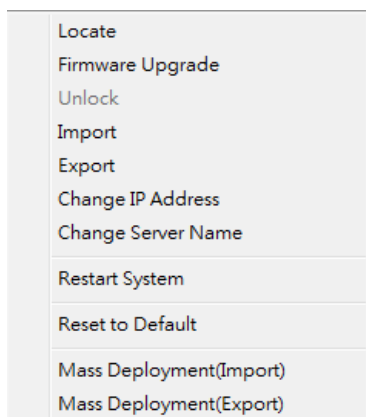

Locate

The locate function helps users find a dedicated ioLogik on the network. When this function is triggered, the ready LED on the selected unit will start to blink indicating its location.

Locate Server						
#	Server Name	Model	IP Address	MAC Address	Firmware Ver.	Status
1		E1240	192.168.19.100	00-90-E8-00-11-02	1.0	Unlock

NOTE: The device LED will blink until the stop button is pressed.



Firmware Upgrade

The ioLogik E1261W-T supports a remote firmware upgrade function. Enter the path to the firmware file or click on the icon to browse for the file. The wizard will lead you through the process until the server is restarted.

Batch Upgrades on Multiple Devices of the Same Model

Batch firmware upgrades are possible on multiple devices of the same ioLogik model. To upgrade multiple models, press the "Shift" key, select "ioLogik", and right click to process multiple firmware upgrades.

#	Server Name	Model	IP Address	MAC Address	Subnet Mask	Gateway	Firmware...	Status
1		E1212	192.168.19.204	00-90-E1-0D-52-11	255.255.255.0	0.0.0.0	1.0	Lock
2	b	E1214	192.168.19.103	00-90-E8-66-32-19	255.255.255.0	0.0.0.0	1.0	Unlock
3		E1240	192.168.19.206	00-90-E8-11-22-33	255.255.255.0	0.0.0.0	1.0	Unlock
4		E1240	192.168.19.100	00-90-E8-00-11-02	255.255.255.0	0.0.0.0	1.0	Unlock

Locate
 Firmware Upgrade
 Unlock
 Import
 Export
 Change IP Address
 Change Server Name
 Restart System
 Reset to Default
 Mass Deployment(Import)
 Mass Deployment(Export)



ATTENTION

Do not interrupt the firmware update process! An interruption in the process may result in your device becoming unrecoverable.

Unlock

If an ioLogik E1261W-T is password protected, unlock the ioLogik E1261W-T by entering the password before using any of the functions.

Unlock Server							
#	Server Name	Model	IP Address	MAC Address	Firmware Ver.	Status	Unlock
1		E1212	192.168.19.204	00-90-E1-0D-52-11	1.0	Lock	

Enter Password: (8 char max.)

Import

Select this command to reload a configuration that was exported to a text file.

Importing one configuration file to multiple ioLogik E1261W-T units (same model) is allowed. To do this, press the **"Shift"** key, select **"ioLogik"**, and then right click.

#	Server Name	Model	IP Address	MAC Address	Subnet Mask	Gateway	Firmware...	Status
1		E1212	192.168.19.204	00-90-E1-0D-52-11	255.255.255.0	0.0.0.0	1.0	Lock
2	b	E1214	192.168.19.103	00-90-E8-66-32-19	255.255.255.0	0.0.0.0	1.0	Unlock
3		E1240	192.168.19.206	00-90-E8-11-22-33	255.255.255.0	0.0.0.0	1.0	Unlock
4		E1240	192.168.19.100	00-90-E8-00-11-02	255.255.255.0	0.0.0.0	1.0	Unlock

- Locate
- Firmware Upgrade
- Unlock
- Import
- Export
- Change IP Address
- Change Server Name
- Restart System
- Reset to Default
- Mass Deployment(Import)
- Mass Deployment(Export)

Export

The export function is used to export the current configuration file of an ioLogik E1261W-T. The export file format will be **ik12xx.txt** where "xx" represents the model type of the ioLogik E1261W-T.

Exporting multiple files for different models of ioLogik E1261W-T is allowed. The file format is **ik12xx_MAC Address.txt**, where the xx represents the model types of the ioLogik E1261W-T.

e.g., ik1214_00-90-E8-66-32-19.txt

To export multiple configuration files, select the ioLogik and right click to process this function.

#	Server Name	Model	IP Address	MAC Address	Subnet Mask	Gateway	Firmware...	Status
1		E1212	192.168.19.204	00-90-E1-0D-52-11	255.255.255.0	0.0.0.0	1.0	Lock
2	b	E1214	192.168.19.103	00-90-E8-66-32-19	255.255.255.0	0.0.0.0	1.0	Unlock
3		E1240	192.168.19.206	00-90-E8-11-22-33	255.255.255.0	0.0.0.0	1.0	Unlock
4		E1240	192.168.19.100	00-90-E8-00-11-02	255.255.255.0	0.0.0.0	1.0	Unlock

- Locate
- Firmware Upgrade
- Unlock
- Import
- Export
- Change IP Address
- Change Server Name
- Restart System
- Reset to Default
- Mass Deployment(Import)
- Mass Deployment(Export)

Change IP Address

The Change IP Address function allows you to directly modify the IP address for one or multiple ioLogik E1261W-T series devices, and is especially useful for first time installation.

First, select the ioLogik E1261W-T device(s) you wish to modify. Then, right-click on the device(s) and select "Change IP Address" from the drop-down menu to open the Change IP Address window. After changing the IP address, click "Set" to complete setup, and search the network again to reveal the modified IP addresses.

#	Server Name	Model	IP Address	MAC Address	Subnet Mask	Gateway	Firmware...	Status
1		E1212	192.168.19.204	00-90-E1-0D-52-11	255.255.255.0	0.0.0.0	1.0	Lock
2	b	E1214	192.168.19.103	00-90-E8-66-32-19	255.255.255.0	0.0.0.0	1.0	Unlock
3		E1240	192.168.19.206	00-90-E8-11-22-33	255.255.255.0	0.0.0.0	1.0	Unlock
4		E1240	192.168.19.100	00-90-E8-11-22-33	255.255.255.0	0.0.0.0	1.0	Unlock

#	Server Name	Model	IP Address	MAC Address	Firmware Ver.	Status	Change IP
1	b	E1214	192.168.19.103	00-90-E8-66-32-19	1.0	Unlock	
2		E1240	192.168.19.206	00-90-E8-11-22-33	1.0	Unlock	Set

Batch TCP/IP Configuration on Multiple Devices

Users can batch modify IP addresses, subnet masks, and gateways for devices of the same model from a single window while submitting the changes at one time. First, select several devices of the same model, click the right mouse button, and then click "Change IP Address" in the pop-up menu to launch a new window.

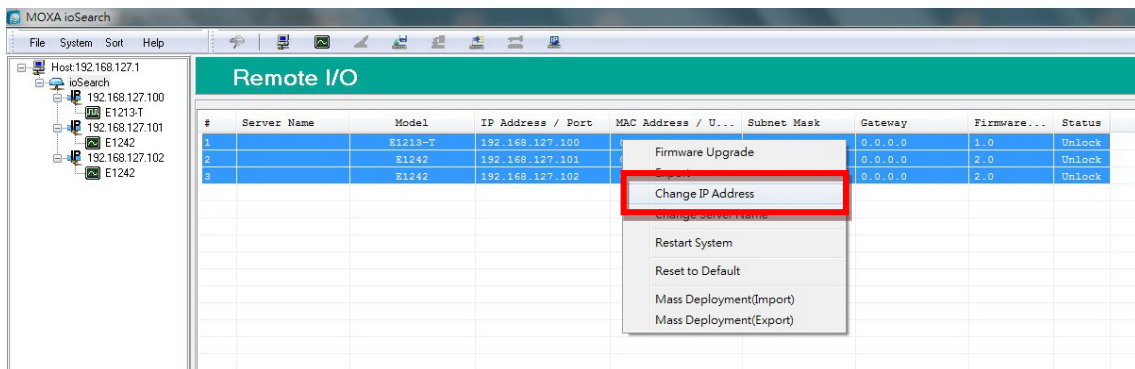

The following screenshot shows the window used to modify IP addresses, subnet masks, and gateways. Users can modify each item and click "Set" to confirm the modification, or click the "Advance" button to automatically assign IP addresses incrementally.

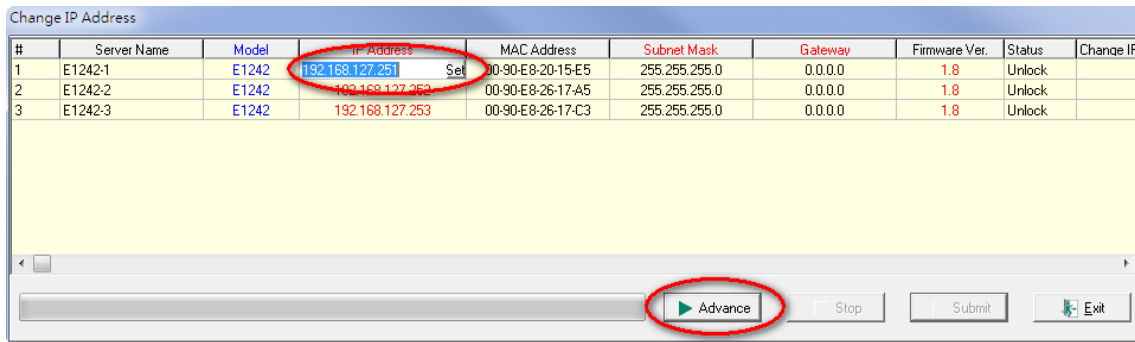

After clicking the **Advance** button, a window will pop up to allow users to use ioSearch™ to set the IP address by MAC address. ioSearch™ will automatically set sequential IP addresses on the selected devices, with the subnet mask and gateway set to the same value.

Restart System

Select this command to restart the selected ioLogik E1261W-T.

Restarting multiple ioLogik E1261W-T units is allowed. Select the ioLogik E1261W-T and right click to process this function.

#	Server Name	Model	IP Address	MAC Address	Subnet Mask	Gateway	Firmware...	Status
1		E1212	192.168.19.204	00-90-E1-0D-52-11	255.255.255.0	0.0.0.0	1.0	Lock
2	b	E1214	192.168.19.103	00-90-E8-66-32-19	255.255.255.0	0.0.0.0	1.0	Unlock
3		E1240	192.168.19.206	00-90-E8-66-32-19	255.255.255.0	0.0.0.0	1.0	Unlock
4		E1240	192.168.19.100	00-90-E8-66-32-19	255.255.255.0	0.0.0.0	1.0	Unlock

- Locate
- Firmware Upgrade
- Unlock
- Import
- Export
- Change IP Address
- Change Server Name
- Restart System**
- Reset to Default
- Mass Deployment(Import)
- Mass Deployment(Export)

#	Server Name	Model	IP Address	MAC Address	Firmware Ver.	Status	Restart
1	b	E1214	192.168.19.103	00-90-E8-66-32-19	1.0	Unlock	Success
2		E1240	192.168.19.206	00-90-E8-11-22-33	1.0	Unlock	

Restarting I/O Server

Wait for IO server to restart. **3**

Progress bar: [|||||]

Buttons: Stop, Exit

Reset to Default

Select this function to reset all settings, including console password, to factory default values.

Resetting multiple ioLogik E1261W-T units to the default configuration is allowed. Select the ioLogik E1261W-T and right click to process this function.

#	Server Name	Model	IP Address	MAC Address	Subnet Mask	Gateway	Firmware...	Status
1		E1212	192.168.19.204	00-90-E1-0D-52-11	255.255.255.0	0.0.0.0	1.0	Lock
2	b	E1214	192.168.19.103	00-90-E8-66-32-19	255.255.255.0	0.0.0.0	1.0	Unlock
3		E1240	192.168.19.206	00-90-E8-66-32-19	255.255.255.0	0.0.0.0	1.0	Unlock
4		E1240	192.168.19.100	00-90-E8-66-32-19	255.255.255.0	0.0.0.0	1.0	Unlock

- Locate
- Firmware Upgrade
- Unlock
- Import
- Export
- Change IP Address
- Change Server Name
- Restart System
- Reset to Default**
- Mass Deployment(Import)
- Mass Deployment(Export)

Mass Deployment (Import)

Users can import E1261-T series module information via ioSearch™. Select this command to reload a configuration from an exported .CSV file.

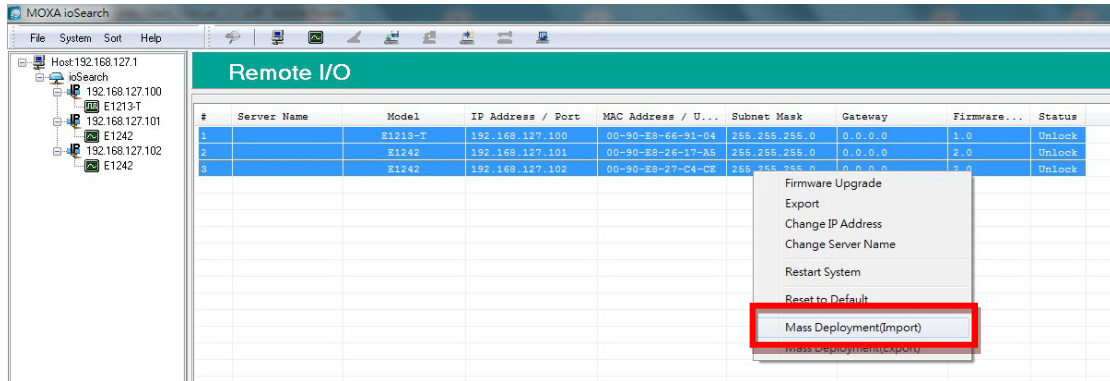

Mass Deployment (Export)

Users can export E1261-T series module information via ioSearch™. The export file format will be **E1261-T_Series_List**.

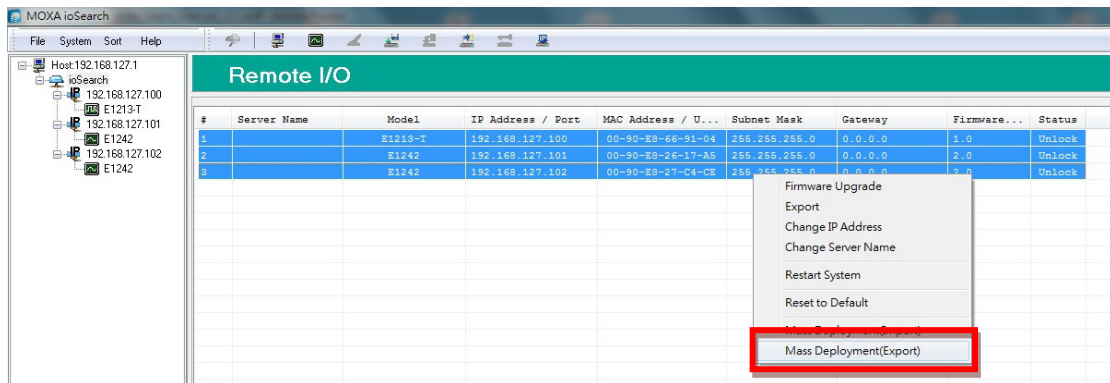

Active OPC Server

Active OPC Server is a software package provided by Moxa that operates as an OPC driver for an HMI or SCADA system. It offers seamless connection from Moxa's ioLogik series products to SCADA systems, such as Wonderware, Citect, and iFix. Active OPC Server meets the latest standard of OPC DA 3.0, which allows connections to various kinds of devices and host OPC machines.

The following topics are covered in this chapter:

❑ Introduction to Active OPC Server

- OLE for Process Control
- Active OPC Server—From Pull to Push

❑ Features of Active OPC Server

- One Simple Click Creates Active Tags
- Faster, More Accurate Data Collection than Traditional "Pull Technology"
- Dynamic IP Assignments for Cellular Remote IOs

❑ Active OPC Server Setup

- Installing Active OPC Server
- Main Screen Overview
- Menu Bar

Introduction to Active OPC Server

Moxa Active OPC Server is a software package operated as an OPC driver of an HMI or SCADA system. It offers seamless connection from Moxa ioLogik series products to SCADA systems, including the most popular—Wonderware, Citect, and iFix. Active OPC Server meets the latest standard of OPC DA3.0 to connect various kinds of devices and host OPC machines.

Active OPC Server System Requirements

Hardware Requirements	
CPU	Intel Pentium (Pentium 4 and above)
RAM	512 MB (1024 MB recommended)
Network Interface	10/100 Mb Ethernet
Software Requirements	
Operating System	Microsoft Windows 2000, XP or later
Editor(not necessary)	Microsoft Office 2003 (Access 2003) or later
OPC Server Specifications	
OPC Data Access	1.0a, 2.0, 2.05a, 3.0
Max. tags	256
ioLogik Support	
Product Model	ioLogik E1261W-T series, E2200 series, E4200, and W5300 series
Firmware version	V3.0 or above
ioAdmin version	V3.0 or above

NOTE The latest versions are Active OPC Server V1.11 and ioAdmin 3.10. Use firmware V1.3 or above for the ioLogik W5312 series, V1.5 or above for the ioLogik W5340 series, and V1.2 or above for the ioLogik W5340-HSDPA series for the following descriptions to be valid.

OLE for Process Control

OPC (originally OLE for process control) is an industry standard created by the leading worldwide automation hardware and software suppliers working in cooperation with Microsoft. The standard defines methods for exchanging real-time automation data between PC-based clients using Microsoft operating systems. The organization that manages this standard is the OPC Foundation.

The OPC Specification is a non-proprietary technical specification that defines a set of standard interfaces based on Microsoft's OLE/COM/DCOM platform and .NET technology. The application of the OPC standard interface makes possible interoperability between automation/control applications, field systems/devices, and business/office applications.

Traditionally, software and application developers needed to write a custom interface or server/driver to exchange data with hardware field devices. OPC eliminates this requirement by defining a common, high performance interface that permits this to be done once, and then easily reused by HMI, SCADA, control, and custom applications.

Drivers must be installed several times to connect to different devices

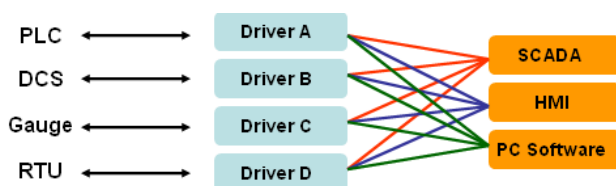

OPC Client/Server creates a common interface to connect to different devices

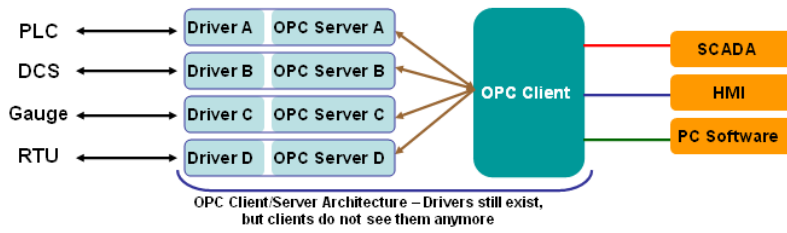

Active OPC Server—From Pull to Push

When looking up an I/O devices’ Modbus table, 19 or more steps are required to create a single tag. The steps include specifying the IP address, selecting the protocols, and defining the data type. The procedure is repeated over and over again until all the devices and tags are created. It takes about 1 minute for a user with a technical background to create one tag. But what if there are 400 tags in an OPC system? Not only does it take a long time to configure such a large number of tags, it also puts a heavy load on the CPU.

OPC also requires the connected I/O devices to use fixed IP addresses. This type of architecture is sometimes referred to as “pull” technology, because the OPC server always needs to pull data (by “polling”) from the I/O devices for tag creation, IP connection, and tag status updates.

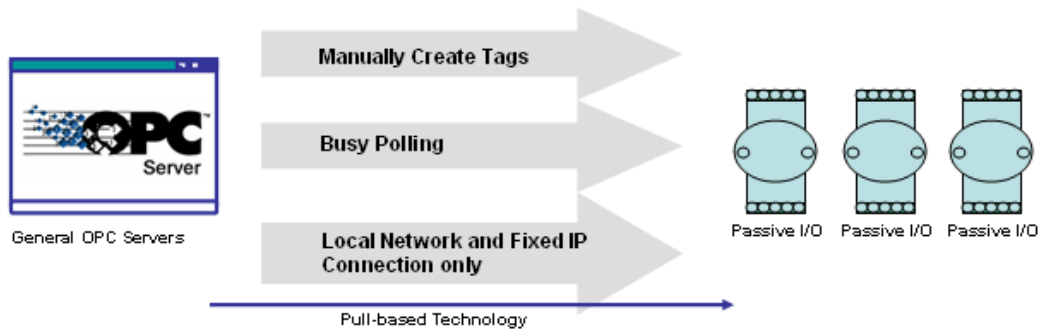

In addition, Moxa's ioLogik products now support OPC technology. An ioLogik can automatically generate tags without requesting any data or even a device’s IP address. All the user needs to do is launch Active OPC Server, and the I/O channels selected by the user will be “pushed” from the ioLogik to Active OPC Server.

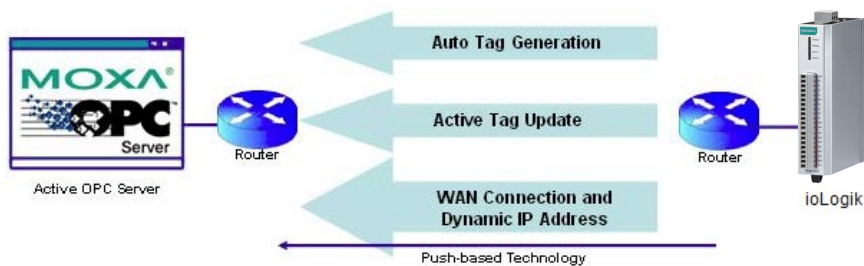

The “push” technology also includes the update for the tags. When the I/O status changes, the ioLogik will send updates to the Active OPC Server. Compared to polling the status (the so-called pull-based method), this feature efficiently reduces network bandwidth usage and speeds up response time with event-driven, push-based status updates. At the same time, the heartbeat function monitors the system’s basic signs of life.

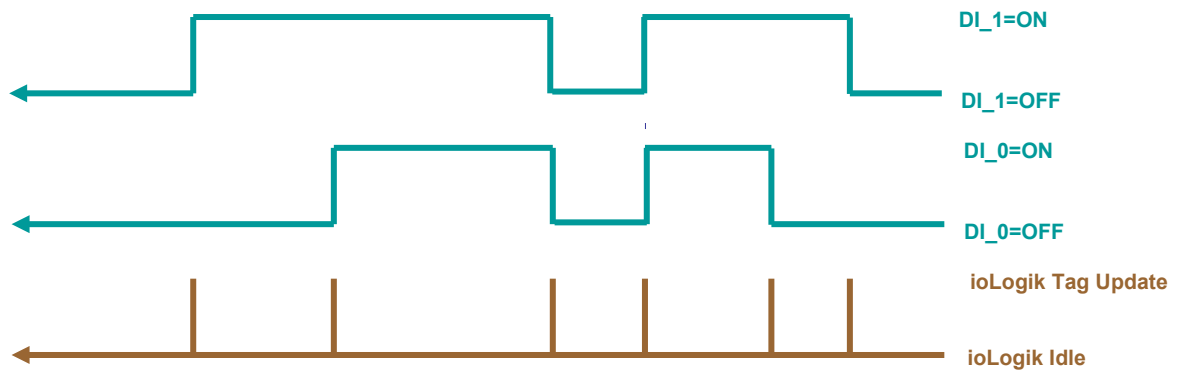

Active OPC Server

← Push for tag updates
 ← Heartbeat every X seconds



ioLogik

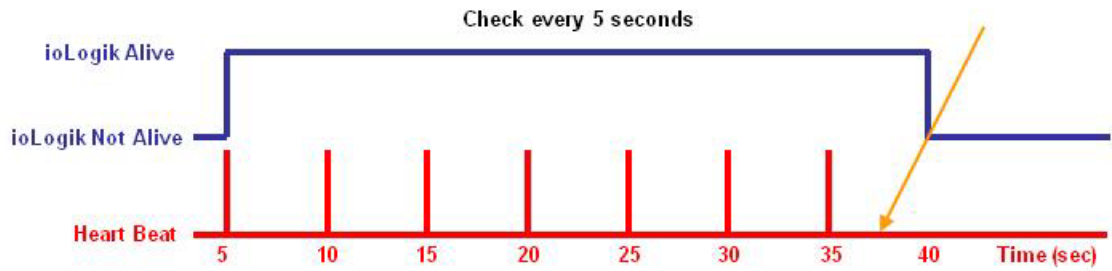

Features of Active OPC Server

One Simple Click Creates Active Tags

Moxa’s RTUs, remote I/O devices, and Active OPC Servers support automatic tag generation, which eliminates the headache of specifying individual target IP addresses, I/O channels, and data formats, while even eliminating any need for editing and importing configuration files. Working from either of Moxa’s ioAdmin or ioSearch™ utilities, users only need to select specific I/O channels, set the update criteria, and then click a single button for their active tags to be automatically generated and configured.



Faster, More Accurate Data Collection than Traditional “Pull Technology”

Moxa has pioneered the concept of “active type” OPC software in the automation industry. The patented Active OPC Server offers non-polling architecture alongside the standard OPC protocol, giving users the alternative of active, push-based communication from Moxa’s RTUs and remote I/O devices. This adaptation of push technology means that I/O status will be updated at the Active OPC Server only when there is an I/O status change, a pre-configured interval is reached, or when a request is issued by a user. This application of push technology cuts metadata overhead, resulting in faster I/O response times and more accurate data collection than traditional pull-based architectures. With Moxa’s “active technology” advantage, users can now instantly receive alarms and real time updates allowing for timely risk response.

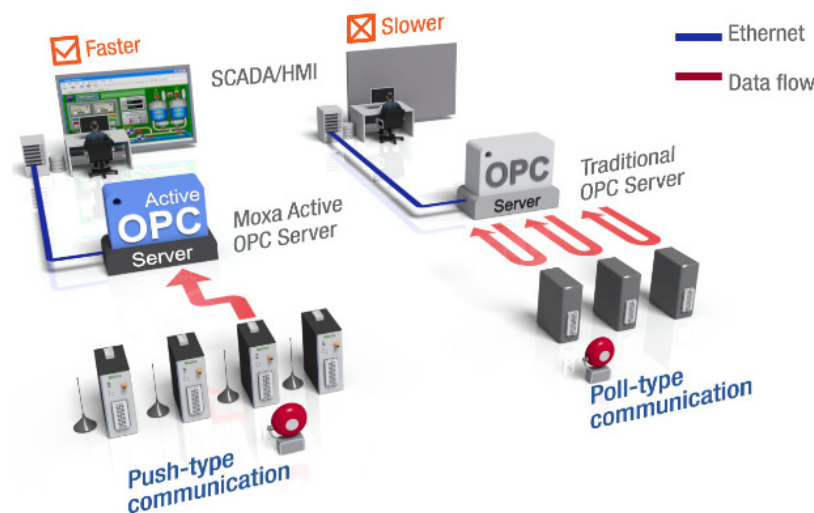

Dynamic IP Assignments for Cellular Remote IOs

For most cellular solutions, each remote modem as well as the central SCADA server are assigned static public IPs when establishing bi-directional communication. Yet cellular network carriers charge higher monthly fees for static, public IPs than dynamic, private ones. Moxa's ioLogik W5300 series and patented Active OPC Server allow users to implement dynamic IP assignments for the Remote IOs. The ioLogik W5300 can automatically establish communications with the Active OPC Server using a fixed IP, and the Active OPC Server will receive and register the ioLogik W5300's IP address and receive or record tag updates accordingly.

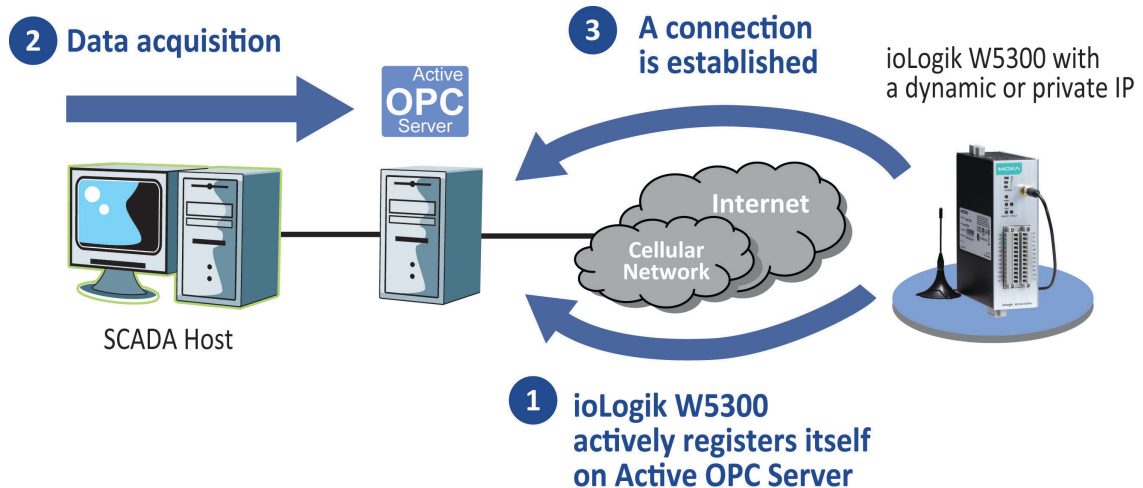

Active OPC Server Setup

Installing Active OPC Server

Active OPC Server downloaded from Moxa's website support page at www.moxa.com/support/. The following instructions explain how to install the software:

- 1. Installing Active OPC Server:** After downloading the Active OPC Server, unzip the file and run Install.exe. The installation program will guide you through the installation process and install the utility.
- 2. Open Active OPC Server:** After installation is finished, run Active OPC Server from the Windows Start menu: **Start** → **Program Files** → **MOXA** → **IO Server** → **ActiveOPC** → **ActiveOPC**

Main Screen Overview

Active OPC Server Lite’s main screen displays a figure of the mapped iologik with the status of every I/O tag. Note that configuration and tags are not available until you set the ioLogik to create the tags.

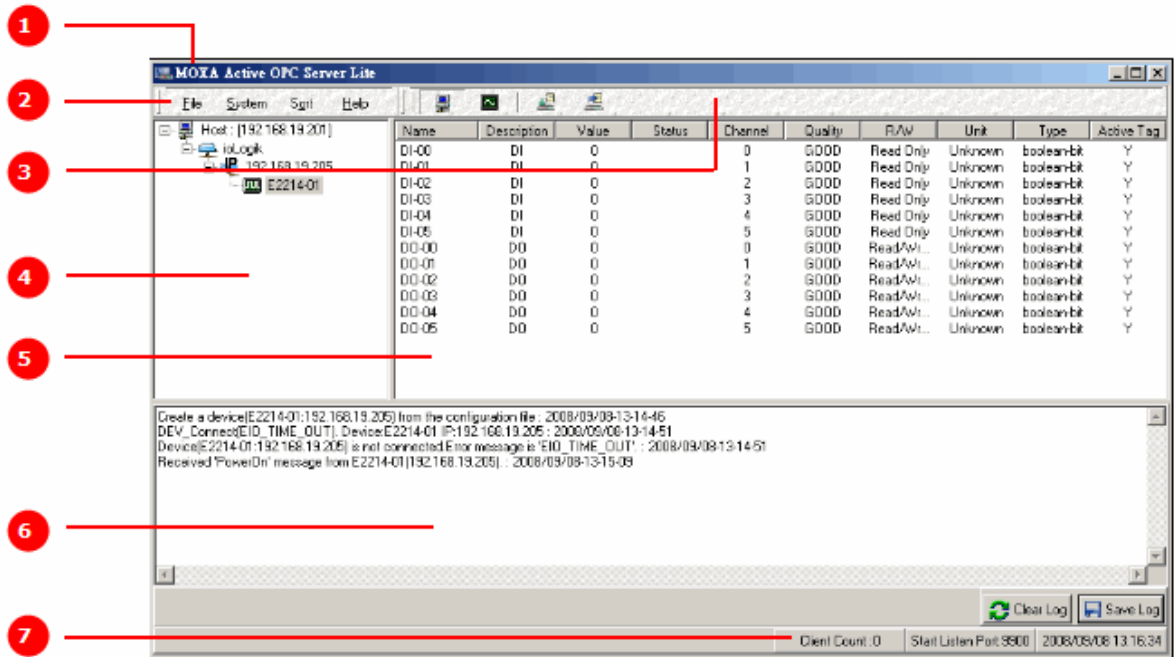

1. Title	2. Menu bar	3. Quick link	4. Navigation panel
5. Tag Window	6. Log Monitor	7. Status bar	

Menu Bar

File

From the **File** menu, you can export the list of the ioLogik devices currently displayed in the navigation panel, and import a list into Active OPC Server.

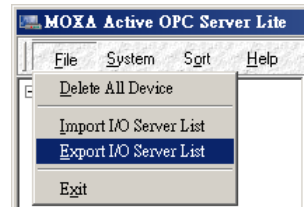

The file will have .mdb and .xls extensions, which can be opened using Microsoft Office Access or Microsoft Excel. The server list includes the current tag information of the mapped ioLogik.

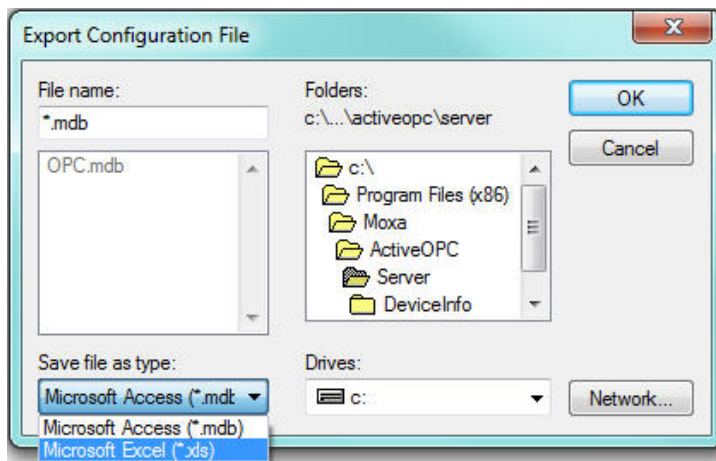

System

Several operations can be accessed from the **System** menu.

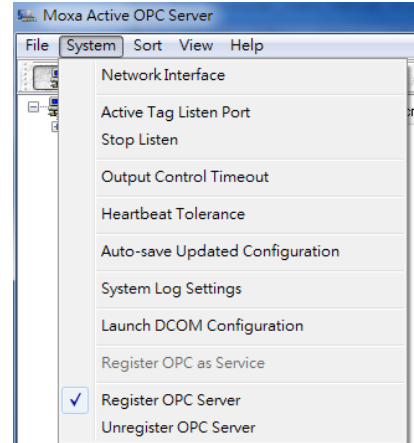

Network Interface: Select which network to use if the PC has multiple network adaptors installed.

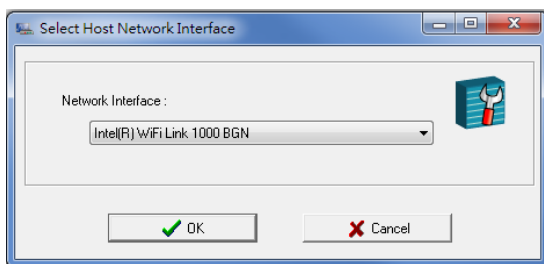

Active Tag Listen Port: Select the preferred TCP socket port for tag generation from ioAdmin.

Stop Listen: Stop receiving tag generation messages and I/O status updates.

Output Control Timeout: Define the timeout interval for controlling an output channel on a remote ioLogik device.

Heartbeat Tolerance: Define the timeout interval to wait for a heartbeat signal from a remote ioLogik device. (Default: 60 Seconds)

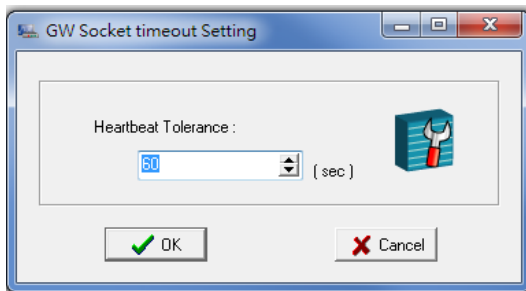

Auto-save Updated Configuration: Once you activate auto-save, Active OPC Server will automatically save the configuration when Access synchronizes.

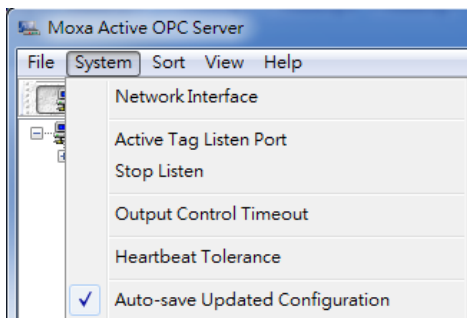

System Log Settings: Enable or disable the Active OPC Server system log function. It will keep a Log file of all the Logging information.

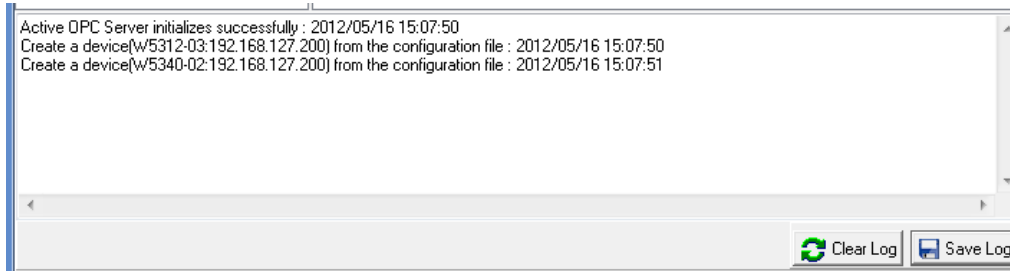

Launch DCOM Configuration: Launch the Windows DCOM configuration utility.

Register OPC as Service: Force Active OPC Server to run as a Windows system service.

Register OPC Server: Register the DCOM components to a Windows system. After Active OPC Server Lite is installed, it will automatically configure the DCOM.

Unregister OPC Server: Cancel the registration of DCOM components from the Windows system.

Sort

The **Sort** menu allows the server list in the navigation panel to be sorted by connection and type (model).



Quick Links

Quick links are provided for sorting the server list and importing/exporting configurations.



	Sort by connection		Import configuration
	Sort by server type		Export configuration

A

Modbus/TCP Default Address Mappings

The following topics are covered in this appendix:

- ❑ **0xxxx Read/Write Coils (Functions 1, 5, 15)**
- ❑ **1xxxx Read only Coils (Support function 2)**
- ❑ **3xxxx Read only Registers (Support function 4)**
- ❑ **4xxxx Read/Write Registers (Support function 3,6,16)**

NOTE The Modbus/TCP ID of the ioLogik E1261W-T is set to "1" by default.

0xxxx Read/Write Coils (Functions 1, 5, 15)

Reference	Address	Data Type	Description
00001	0x0000	1 bit	CH0 DO Value 0: Off 1: On
00002	0x0001	1 bit	CH1 DO Value 0: Off 1: On
00003	0x0002	1 bit	CH2 DO Value 0: Off 1: On
00004	0x0003	1 bit	CH3 DO Value 0: Off 1: On
00005	0x0004	1 bit	CH4 DO Value 0: Off 1: On
00006	0x0005	1 bit	CH5 DO Value 0: Off 1: On
00007	0x0006	1 bit	CH6 DO Value 0: Off 1: On
00008	0x0007	1 bit	CH7 DO Value 0: Off 1: On
00009	0x0008	1 bit	CH8 DO Value 0: Off 1: On
00010	0x0009	1 bit	CH9 DO Value 0: Off 1: On
00011	0x000A	1 bit	CH10 DO Value 0: Off 1: On
00012	0x000B	1 bit	CH11 DO Value 0: Off 1: On
00017	0x0010	1 bit	CH0 DO Pulse Operate Status 0: Off 1: On
00018	0x0011	1 bit	CH1 DO Pulse Operate Status 0: Off 1: On
00019	0x0012	1 bit	CH2 DO Pulse Operate Status 0: Off 1: On
00020	0x0013	1 bit	CH3 DO Pulse Operate Status 0: Off 1: On
00021	0x0014	1 bit	CH4 DO Pulse Operate Status 0: Off 1: On
00022	0x0015	1 bit	CH5 DO Pulse Operate Status 0: Off 1: On
00023	0x0016	1 bit	CH6 DO Pulse Operate Status 0: Off 1: On
00024	0x0017	1 bit	CH7 DO Pulse Operate Status 0: Off 1: On
00025	0x0018	1 bit	CH8 DO Pulse Operate Status 0: Off 1: On
00026	0x0019	1 bit	CH9 DO Pulse Operate Status 0: Off 1: On
00027	0x001A	1 bit	CH10 DO Pulse Operate Status 0: Off 1: On
00028	0x001B	1 bit	CH11 DO Pulse Operate Status 0: Off 1: On
00257	0x0100	1 bit	CH0 DI Counter Operate Status 0: Stop 1: Start(R/W)
00258	0x0101	1 bit	CH1 DI Counter Operate Status 0: Stop 1: Start(R/W)
00259	0x0102	1 bit	CH2 DI Counter Operate Status 0: Stop 1: Start(R/W)
00260	0x0103	1 bit	CH3 DI Counter Operate Status 0: Stop 1: Start(R/W)
00261	0x0104	1 bit	CH4 DI Counter Operate Status 0: Stop 1: Start(R/W)
00262	0x0105	1 bit	CH5 DI Counter Operate Status 0: Stop 1: Start(R/W)
00263	0x0106	1 bit	CH6 DI Counter Operate Status 0: Stop 1: Start(R/W)
00264	0x0107	1 bit	CH7 DI Counter Operate Status 0: Stop 1: Start(R/W)
00265	0x0108	1 bit	CH8 DI Counter Operate Status 0: Stop 1: Start(R/W)
00266	0x0109	1 bit	CH9 DI Counter Operate Status 0: Stop 1: Start(R/W)
00267	0x010A	1 bit	CH10 DI Counter Operate Status 0: Stop 1: Start(R/W)
00268	0x010B	1 bit	CH11 DI Counter Operate Status 0: Stop 1: Start(R/W)
00273	0x0110	1 bit	CH0 DI Clear Count Value Read Always return:0 Write: 1 : Clear counter value 0 : Return illegal data value(0x03)
00274	0x0111	1 bit	CH1 DI Clear Count Value Read Always return:0 Write: 1 : Clear counter value 0 : Return illegal data value(0x03)
00275	0x0112	1 bit	CH2 DI Clear Count Value Read Always return:0

			Write: 1 : Clear counter value 0 : Return illegal data value(0x03)
00276	0x0113	1 bit	CH3 DI Clear Count Value Read Always return:0 Write: 1 : Clear counter value 0 : Return illegal data value(0x03)
00277	0x0114	1 bit	CH4 DI Clear Count Value Read Always return:0 Write: 1 : Clear counter value 0 : Return illegal data value(0x03)
00278	0x0115	1 bit	CH5 DI Clear Count Value Read Always return:0 Write: 1 : Clear counter value 0 : Return illegal data value(0x03)
00279	0x0116	1 bit	CH6 DI Clear Count Value Read Always return:0 Write: 1 : Clear counter value 0 : Return illegal data value(0x03)
00280	0x0117	1 bit	CH7 DI Clear Count Value Read Always return:0 Write: 1 : Clear counter value 0 : Return illegal data value(0x03)
00281	0x0118	1 bit	CH8 DI Clear Count Value Read Always return:0 Write: 1 : Clear counter value 0 : Return illegal data value(0x03)
00282	0x0119	1 bit	CH9 DI Clear Count Value Read Always return:0 Write: 1 : Clear counter value 0 : Return illegal data value(0x03)
00283	0x011A	1 bit	CH10 DI Clear Count Value Read Always return:0 Write: 1 : Clear counter value 0 : Return illegal data value(0x03)
00284	0x011B	1 bit	CH11 DI Clear Count Value Read Always return:0 Write: 1 : Clear counter value 0 : Return illegal data value(0x03)
04097	0x1000	1 bit	CH0 DO Power On Value 0: Off 1: On
04098	0x1001	1 bit	CH1 DO Power On Value 0: Off 1: On
04099	0x1002	1 bit	CH2 DO Power On Value 0: Off 1: On
04100	0x1003	1 bit	CH3 DO Power On Value 0: Off 1: On
04101	0x1004	1 bit	CH4 DO Power On Value 0: Off 1: On
04102	0x1005	1 bit	CH5 DO Power On Value 0: Off 1: On
04103	0x1006	1 bit	CH6 DO Power On Value 0: Off 1: On
04104	0x1007	1 bit	CH7 DO Power On Value 0: Off 1: On
04105	0x1008	1 bit	CH8 DO Power On Value 0: Off 1: On
04106	0x1009	1 bit	CH9 DO Power On Value 0: Off 1: On
04107	0x100A	1 bit	CH10 DO Power On Value 0: Off 1: On
04108	0x100B	1 bit	CH11 DO Power On Value 0: Off 1: On
04113	0x1010	1 bit	CH0 DO Safe Value 0: Off 1: On
04114	0x1011	1 bit	CH1 DO Safe Value 0: Off 1: On
04115	0x1012	1 bit	CH2 DO Safe Value 0: Off 1: On
04116	0x1013	1 bit	CH3 DO Safe Value 0: Off 1: On

04117	0x1014	1 bit	CH4 DO Safe Value 0: Off 1: On
04118	0x1015	1 bit	CH5 DO Safe Value 0: Off 1: On
04119	0x1016	1 bit	CH6 DO Safe Value 0: Off 1: On
04120	0x1017	1 bit	CH7 DO Safe Value 0: Off 1: On
04121	0x1018	1 bit	CH8 DO Safe Value 0: Off 1: On
04122	0x1019	1 bit	CH9 DO Safe Value 0: Off 1: On
04123	0x101A	1 bit	CH10 DO Safe Value 0: Off 1: On
04124	0x101B	1 bit	CH11 DO Safe Value 0: Off 1: On
04129	0x1020	1 bit	CH0 DO PowerOn Pulse Operate Status 0: Off 1: On
04130	0x1021	1 bit	CH1 DO PowerOn Pulse Operate Status 0: Off 1: On
04131	0x1022	1 bit	CH2 DO PowerOn Pulse Operate Status 0: Off 1: On
04132	0x1023	1 bit	CH3 DO PowerOn Pulse Operate Status 0: Off 1: On
04133	0x1024	1 bit	CH4 DO PowerOn Pulse Operate Status 0: Off 1: On
04134	0x1025	1 bit	CH5 DO PowerOn Pulse Operate Status 0: Off 1: On
04135	0x1026	1 bit	CH6 DO PowerOn Pulse Operate Status 0: Off 1: On
04136	0x1027	1 bit	CH7 DO PowerOn Pulse Operate Status 0: Off 1: On
04137	0x1028	1 bit	CH8 DO PowerOn Pulse Operate Status 0: Off 1: On
04138	0x1029	1 bit	CH9 DO PowerOn Pulse Operate Status 0: Off 1: On
04139	0x102A	1 bit	CHA DO PowerOn Pulse Operate Status 0: Off 1: On
04140	0x102B	1 bit	CHB DO PowerOn Pulse Operate Status 0: Off 1: On
04145	0x1030	1 bit	CH0 DO Safe Pulse Operate Status 0: Off 1: On
04146	0x1031	1 bit	CH1 DO Safe Pulse Operate Status 0: Off 1: On
04147	0x1032	1 bit	CH2 DO Safe Pulse Operate Status 0: Off 1: On
04148	0x1033	1 bit	CH3 DO Safe Pulse Operate Status 0: Off 1: On
04149	0x1034	1 bit	CH4 DO Safe Pulse Operate Status 0: Off 1: On
04150	0x1035	1 bit	CH5 DO Safe Pulse Operate Status 0: Off 1: On
04151	0x1036	1 bit	CH6 DO Safe Pulse Operate Status 0: Off 1: On
04152	0x1037	1 bit	CH7 DO Safe Pulse Operate Status 0: Off 1: On
04153	0x1038	1 bit	CH8 DO Safe Pulse Operate Status 0: Off 1: On
04154	0x1039	1 bit	CH9 DO Safe Pulse Operate Status 0: Off 1: On
04155	0x103A	1 bit	CH10 DO Safe Pulse Operate Status 0: Off 1: On
04156	0x103B	1 bit	CH11 DO Safe Pulse Operate Status 0: Off 1: On
04161	0x1040	1 bit	CH0 DO Mode 0: DO 1: Pulse
04162	0x1041	1 bit	CH1 DO Mode 0: DO 1: Pulse
04163	0x1042	1 bit	CH2 DO Mode 0: DO 1: Pulse
04164	0x1043	1 bit	CH3 DO Mode 0: DO 1: Pulse
04165	0x1044	1 bit	CH4 DO Mode 0: DO 1: Pulse
04166	0x1045	1 bit	CH5 DO Mode 0: DO 1: Pulse
04167	0x1046	1 bit	CH6 DO Mode 0: DO 1: Pulse
04168	0x1047	1 bit	CH7 DO Mode 0: DO 1: Pulse
04169	0x1048	1 bit	CH8 DO Mode 0: DO 1: Pulse
04170	0x1049	1 bit	CH9 DO Mode 0: DO 1: Pulse
04171	0x104A	1 bit	CH10 DO Mode 0: DO 1: Pulse
04172	0x104B	1 bit	CH11 DO Mode 0: DO 1: Pulse
AI Channel			
04609	0x1200	1 bit	Reset CH0 AI Min Value Read: always 0 Write : 1: reset AI Min value 0: return Illegal Data Value
04610	0x1201	1 bit	Reset CH1 AI Min Value Read: always 0 Write : 1: reset AI Min value 0: return Illegal Data Value

04611	0x1202	1 bit	Reset CH2 AI Min Value Read: always 0 Write : 1: reset AI Min value 0: return Illegal Data Value
04612	0x1203	1 bit	Reset CH3 AI Min Value Read: always 0 Write : 1: reset AI Min value 0: return Illegal Data Value
04613	0x1204	1 bit	Reset CH4 AI Min Value Read: always 0 Write : 1: reset AI Min value 0: return Illegal Data Value
04617	0x1208	1 bit	Reset CH0 AI Max Value Read: always 0 Write : 1: reset AI Max value 0: return Illegal Data Value
04618	0x1209	1 bit	Reset CH1 AI Max Value Read: always 0 Write : 1: reset AI Max value 0: return Illegal Data Value
04619	0x120A	1 bit	Reset CH2 AI Max Value Read: always 0 Write : 1: reset AI Max value 0: return Illegal Data Value
04620	0x120B	1 bit	Reset CH3 AI Max Value Read: always 0 Write : 1: reset AI Max value 0: return Illegal Data Value
04621	0x120C	1 bit	Reset CH4 AI Max Value Read: always 0 Write : 1: reset AI Max value 0: return Illegal Data Value
04625	0x1210	1 bit	CH0 AI Enable
04626	0x1211	1 bit	CH1 AI Enable
04627	0x1212	1 bit	CH2 AI Enable
04628	0x1213	1 bit	CH3 AI Enable
04629	0x1214	1 bit	CH4 AI Enable
RTD Channel			
05633	0x1600	1 bit	CH0 RTD Reset Minimum Value <R> Always 0 <W> 1=Reset to current value, 0=return illegal data value
05634	0x1601	1 bit	CH1 RTD Reset Minimum Value <R> Always 0 <W> 1=Reset to current value, 0=return illegal data value
05635	0x1602	1 bit	CH2 RTD Reset Minimum Value <R> Always 0 <W> 1=Reset to current value, 0=return illegal data value
05645	0x160C	1 bit	CH0 RTD Reset Maximum Value <R> Always 0 <W> 1=Reset to current value, 0=return illegal data value

05646	0x160D	1 bit	CH1 RTD Reset Maximum Value <R> Always 0 <W> 1=Reset to current value, 0=return illegal data value
05647	0x160E	1 bit	CH2 RTD Reset Maximum Value <R> Always 0 <W> 1=Reset to current value, 0=return illegal data value
05657	0x1618	1 bit	CH0 RTD Enable
05658	0x1619	1 bit	CH1 RTD Enable
05659	0x161A	1 bit	CH2 RTD Enable
08193	0x2000	1 bit	CH0 DI Mode 0: DI, 1: Counter (R/W)
08194	0x2001	1 bit	CH1 DI Mode 0: DI, 1: Counter (R/W)
08195	0x2002	1 bit	CH2 DI Mode 0: DI, 1: Counter (R/W)
08196	0x2003	1 bit	CH3 DI Mode 0: DI, 1: Counter (R/W)
08197	0x2004	1 bit	CH4 DI Mode 0: DI, 1: Counter (R/W)
08198	0x2005	1 bit	CH5 DI Mode 0: DI, 1: Counter (R/W)
08199	0x2006	1 bit	CH6 DI Mode 0: DI, 1: Counter (R/W)
08200	0x2007	1 bit	CH7 DI Mode 0: DI, 1: Counter (R/W)
08201	0x2008	1 bit	CH8 DI Mode 0: DI, 1: Counter (R/W)
08202	0x2009	1 bit	CH9 DI Mode 0: DI, 1: Counter (R/W)
08203	0x200A	1 bit	CH10 DI Mode 0: DI, 1: Counter (R/W)
08204	0x200B	1 bit	CH11 DI Mode 0: DI, 1: Counter (R/W)
08209	0x2010	1 bit	CH0 DI PowerOn Counter Operate Status 0: Stop 1: Start (R/W)
08210	0x2011	1 bit	CH1 DI PowerOn Counter Operate Status 0: Stop 1: Start (R/W)
08211	0x2012	1 bit	CH2 DI PowerOn Counter Operate Status 0: Stop 1: Start (R/W)
08212	0x2013	1 bit	CH3 DI PowerOn Counter Operate Status 0: Stop 1: Start (R/W)
08213	0x2014	1 bit	CH4 DI PowerOn Counter Operate Status 0: Stop 1: Start (R/W)
08214	0x2015	1 bit	CH5 DI PowerOn Counter Operate Status 0: Stop 1: Start (R/W)
08215	0x2016	1 bit	CH6 DI PowerOn Counter Operate Status 0: Stop 1: Start (R/W)
08216	0x2017	1 bit	CH7 DI PowerOn Counter Operate Status 0: Stop 1: Start (R/W)
08217	0x2018	1 bit	CH8 DI PowerOn Counter Operate Status 0: Stop 1: Start (R/W)
08218	0x2019	1 bit	CH9 DI PowerOn Counter Operate Status 0: Stop 1: Start (R/W)
08219	0x201A	1 bit	CH10 DI PowerOn Counter Operate Status 0: Stop 1: Start (R/W)
08220	0x201B	1 bit	CH11 DI PowerOn Counter Operate Status 0: Stop 1: Start (R/W)
08225	0x2020	1 bit	CH0 DI Safe Mode Counter Operate Status 0: Stop 1: Start (R/W)

08226	0x2021	1 bit	CH1 DI Safe Mode Counter Operate Status 0: Stop 1: Start (R/W)
08227	0x2022	1 bit	CH2 DI Safe Mode Counter Operate Status 0: Stop 1: Start (R/W)
08228	0x2023	1 bit	CH3 DI Safe Mode Counter Operate Status 0: Stop 1: Start (R/W)
08229	0x2024	1 bit	CH4 DI Safe Mode Counter Operate Status 0: Stop 1: Start (R/W)
08230	0x2025	1 bit	CH5 DI Safe Mode Counter Operate Status 0: Stop 1: Start (R/W)
08231	0x2026	1 bit	CH6 DI Safe Mode Counter Operate Status 0: Stop 1: Start (R/W)
08232	0x2027	1 bit	CH7 DI Safe Mode Counter Operate Status 0: Stop 1: Start (R/W)
08233	0x2028	1 bit	CH8 DI Safe Mode Counter Operate Status 0: Stop 1: Start (R/W)
08234	0x2029	1 bit	CH9 DI Safe Mode Counter Operate Status 0: Stop 1: Start (R/W)
08235	0x202A	1 bit	CH10 DI Safe Mode Counter Operate Status 0: Stop 1: Start (R/W)
08236	0x202B	1 bit	CH11 DI Safe Mode Counter Operate Status 0: Stop 1: Start (R/W)
08241	0x2030	1 bit	CH0 DI Counter Trigger · 0=Low to High, 1=High to Low (R/W)
08242	0x2031	1 bit	CH1 DI Counter Trigger · 0=Low to High, 1=High to Low (R/W)
08243	0x2032	1 bit	CH2 DI Counter Trigger · 0=Low to High, 1=High to Low (R/W)
08244	0x2033	1 bit	CH3 DI Counter Trigger · 0=Low to High, 1=High to Low (R/W)
08245	0x2034	1 bit	CH4 DI Counter Trigger · 0=Low to High, 1=High to Low (R/W)
08246	0x2035	1 bit	CH5 DI Counter Trigger · 0=Low to High, 1=High to Low (R/W)
08247	0x2036	1 bit	CH6 DI Counter Trigger · 0=Low to High, 1=High to Low (R/W)
08248	0x2037	1 bit	CH7 DI Counter Trigger · 0=Low to High, 1=High to Low (R/W)
08249	0x2038	1 bit	CH8 DI Counter Trigger · 0=Low to High, 1=High to Low (R/W)
08250	0x2039	1 bit	CH9 DI Counter Trigger · 0=Low to High, 1=High to Low (R/W)
08251	0x203A	1 bit	CH10 DI Counter Trigger · 0=Low to High, 1=High to Low (R/W)

			(R/W)
08252	0x203B	1 bit	CH11 DI Counter Trigger · 0=Low to High, 1=High to Low (R/W)
08257	0x2040	1 bit	CH0 DI OverFlow Status Read : 0 : Normal · 1 : Overflow Write : 0 : Clear overflow status 1 : Return illegal data value (0x03)
08258	0x2041	1 bit	CH1 DI OverFlow Status Read : 0 : Normal · 1 : Overflow Write : 0 : Clear overflow status 1 : Return illegal data value (0x03)
08259	0x2042	1 bit	CH2 DI OverFlow Status Read : 0 : Normal · 1 : Overflow Write : 0 : Clear overflow status 1 : Return illegal data value (0x03)
08260	0x2043	1 bit	CH3 DI OverFlow Status Read : 0 : Normal · 1 : Overflow Write : 0 : Clear overflow status 1 : Return illegal data value (0x03)
08261	0x2044	1 bit	CH4 DI OverFlow Status Read : 0 : Normal · 1 : Overflow Write : 0 : Clear overflow status 1 : Return illegal data value (0x03)
08262	0x2045	1 bit	CH5 DI OverFlow Status Read : 0 : Normal · 1 : Overflow Write : 0 : Clear overflow status 1 : Return illegal data value (0x03)
08263	0x2046	1 bit	CH6 DI OverFlow Status Read : 0 : Normal · 1 : Overflow Write : 0 : Clear overflow status 1 : Return illegal data value (0x03)
08264	0x2047	1 bit	CH7 DI OverFlow Status Read : 0 : Normal · 1 : Overflow Write : 0 : Clear overflow status 1 : Return illegal data value (0x03)
08265	0x2048	1 bit	CH8 DI OverFlow Status Read : 0 : Normal · 1 : Overflow Write : 0 : Clear overflow status 1 : Return illegal data value (0x03)
08266	0x2049	1 bit	CH9 DI OverFlow Status Read : 0 : Normal · 1 : Overflow Write : 0 : Clear overflow status 1 : Return illegal data value (0x03)
08267	0x204A	1 bit	CH10 DI OverFlow Status Read : 0 : Normal · 1 : Overflow Write : 0 : Clear overflow status 1 : Return illegal data value (0x03)
08268	0x204B	1 bit	CH11 DI OverFlow Status Read : 0 : Normal · 1 : Overflow Write : 0 : Clear overflow status 1 : Return illegal data value (0x03)
08273	0x2050	1 bit	CH0 Power Off Storage Read/Wirte : 0 : Disable · 1 : Enable
08274	0x2051	1 bit	CH1 Power Off Storage

			Read/Wirte : 0 : Disable · 1 : Enable
08275	0x2052	1 bit	CH2 Power Off Storage Read/Wirte : 0 : Disable · 1 : Enable
08276	0x2053	1 bit	CH3 Power Off Storage Read/Wirte : 0 : Disable · 1 : Enable
08277	0x2054	1 bit	CH4 Power Off Storage Read/Wirte : 0 : Disable · 1 : Enable
08278	0x2055	1 bit	CH5 Power Off Storage Read/Wirte : 0 : Disable · 1 : Enable
08279	0x2056	1 bit	CH6 Power Off Storage Read/Wirte : 0 : Disable · 1 : Enable
08280	0x2057	1 bit	CH7 Power Off Storage Read/Wirte : 0 : Disable · 1 : Enable
08281	0x2058	1 bit	CH8 Power Off Storage Read/Wirte : 0 : Disable · 1 : Enable
08282	0x205A	1 bit	CH9 Power Off Storage Read/Wirte : 0 : Disable · 1 : Enable
08283	0x205B	1 bit	CH10 Power Off Storage Read/Wirte : 0 : Disable · 1 : Enable
08284	0x2050	1 bit	CH11 Power Off Storage Read/Wirte : 0 : Disable · 1 : Enable

1xxxx Read only Coils (Support function 2)

Reference	Address	Data Type	Description
10001	0x0000	1 bit	CH0 DI Value , 0=OFF , 1=ON (Read only)
10002	0x0001	1 bit	CH1 DI Value , 0=OFF , 1=ON (Read only)
10003	0x0002	1 bit	CH2 DI Value , 0=OFF , 1=ON (Read only)
10004	0x0003	1 bit	CH3 DI Value , 0=OFF , 1=ON (Read only)
10005	0x0004	1 bit	CH4 DI Value , 0=OFF , 1=ON (Read only)
10006	0x0005	1 bit	CH5 DI Value , 0=OFF , 1=ON (Read only)
10007	0x0006	1 bit	CH6 DI Value , 0=OFF , 1=ON (Read only)
10008	0x0007	1 bit	CH7 DI Value , 0=OFF , 1=ON (Read only)
10009	0x0008	1 bit	CH8 DI Value , 0=OFF , 1=ON (Read only)
10010	0x0009	1 bit	CH9 DI Value , 0=OFF , 1=ON (Read only)
10011	0x000A	1 bit	CH10 DI Value , 0=OFF , 1=ON (Read only)
10012	0x000B	1 bit	CH11 DI Value , 0=OFF , 1=ON (Read only)
14097	0x1000	1 bit	DIO0 direction (1: DO ,0:DI)
14098	0x1001	1 bit	DIO1 direction (1: DO ,0:DI)
14099	0x1002	1 bit	DIO2 direction (1: DO ,0:DI)
14100	0x1003	1 bit	DIO3 direction (1: DO ,0:DI)
14101	0x1004	1 bit	DIO4 direction (1: DO ,0:DI)
14102	0x1005	1 bit	DIO5 direction (1: DO ,0:DI)
14103	0x1006	1 bit	DIO6 direction (1: DO ,0:DI)
14104	0x1007	1 bit	DIO7 direction (1: DO ,0:DI)
14105	0x1008	1 bit	DIO8 direction (1: DO ,0:DI)
14106	0x1009	1 bit	DIO9 direction (1: DO ,0:DI)
14107	0x100A	1 bit	DIO10 direction (1: DO ,0:DI)
14108	0x100B	1 bit	DIO11 direction (1: DO ,0:DI)
14609	0x1200	1 bit	CH0 AI Mode 1: current(mA) , 0: Voltage(mV) (R)

14610	0x1201	1 bit	CH1 AI Mode 1: current(mA) , 0: Voltage(mV) (R)
14611	0x1202	1 bit	CH2 AI Mode 1: current(mA) , 0: Voltage(mV) (R)
14612	0x1203	1 bit	CH3 AI Mode 1: current(mA) , 0: Voltage(mV) (R)
14613	0x1204	1 bit	CH4 AI Mode 1: current(mA) , 0: Voltage(mV) (R)

3xxxx Read only Registers (Support function 4)

Reference	Address	Data Type	Description
30001	0x0000	1 word	CH0 DI WordValue , 0=OFF , 1=ON (Read only)
30002	0x0001	1 word	CH1 DI WordValue , 0=OFF , 1=ON (Read only)
30003	0x0002	1 word	CH2 DI WordValue , 0=OFF , 1=ON (Read only)
30004	0x0003	1 word	CH3 DI WordValue , 0=OFF , 1=ON (Read only)
30005	0x0004	1 word	CH4 DI WordValue , 0=OFF , 1=ON (Read only)
30006	0x0005	1 word	CH5 DI WordValue , 0=OFF , 1=ON (Read only)
30007	0x0006	1 word	CH6 DI WordValue , 0=OFF , 1=ON (Read only)
30008	0x0007	1 word	CH7 DI WordValue , 0=OFF , 1=ON (Read only)
30009	0x0008	1 word	CH8 DI WordValue , 0=OFF , 1=ON (Read only)
30010	0x0009	1 word	CH9 DI WordValue , 0=OFF , 1=ON (Read only)
30011	0x000A	1 word	CH10 DI WordValue , 0=OFF , 1=ON (Read only)
30012	0x000B	1 word	CH11 DI WordValue , 0=OFF , 1=ON (Read only)
30017	0x0010	1 word	CH0 DI Counter Value Hi- Word (Read only)
30018	0x0011	1 word	CH0 DI Counter Value Lo- Word (Read only)
30019	0x0012	1 word	CH1 DI Counter Value Hi- Word (Read only)
30020	0x0013	1 word	CH1 DI Counter Value Lo- Word (Read only)
30021	0x0014	1 word	CH2 DI Counter Value Hi- Word (Read only)
30022	0x0015	1 word	CH2 DI Counter Value Lo- Word (Read only)
30023	0x0016	1 word	CH3 DI Counter Value Hi- Word (Read only)
30024	0x0017	1 word	CH3 DI Counter Value Lo- Word (Read only)
30025	0x0018	1 word	CH4 DI Counter Value Hi- Word (Read only)
30026	0x0019	1 word	CH4 DI Counter Value Lo- Word (Read only)
30027	0x001A	1 word	CH5 DI Counter Value Hi- Word (Read only)
30028	0x001B	1 word	CH5 DI Counter Value Lo- Word (Read only)
30029	0x001C	1 word	CH6 DI Counter Value Hi- Word (Read only)
30030	0x001D	1 word	CH6 DI Counter Value Lo- Word (Read only)
30031	0x001E	1 word	CH7 DI Counter Value Hi- Word (Read only)
30032	0x001F	1 word	CH7 DI Counter Value Lo- Word (Read only)
30033	0x0020	1 word	CH8 DI Counter Value Hi- Word (Read only)
30034	0x0021	1 word	CH8 DI Counter Value Lo- Word (Read only)
30035	0x0022	1 word	CH9 DI Counter Value Hi- Word (Read only)
30036	0x0023	1 word	CH9 DI Counter Value Lo- Word (Read only)
30037	0x0024	1 word	CH10 DI Counter Value Hi- Word (Read only)
30038	0x0025	1 word	CH10 DI Counter Value Lo- Word (Read only)
30039	0x0026	1 word	CH11 DI Counter Value Hi- Word (Read only)
30040	0x0027	1 word	CH11 DI Counter Value Lo- Word (Read only)
30049	0x0030	1 word	DI Value (Ch0~11) Bit0 = Ch0 DI Value (0=OFF, 1=ON) Bit11 = Ch11 DI Value (0=OFF, 1=ON)
30513	0x0200	1 word	CH0 Read AI Value(RAW)
30514	0x0201	1 word	CH1 Read AI Value(RAW)

30515	0x0202	1 word	CH2 Read AI Value(RAW)
30516	0x0203	1 word	CH3 Read AI Value(RAW)
30517	0x0204	1 word	CH4 Read AI Value(RAW)
30521	0x0208	1 word	CH0 Read AI Scaling Value Hi (float)
30522	0x0209	1 word	CH0 Read AI Scaling Value Low (float)
30523	0x020A	1 word	CH1 Read AI Scaling Value Hi (float)
30524	0x020B	1 word	CH1 Read AI Scaling Value Low (float)
30525	0x020C	1 word	CH2 Read AI Scaling Value Hi (float)
30526	0x020D	1 word	CH2 Read AI Scaling Value Low (float)
30527	0x020E	1 word	CH3 Read AI Scaling Value Hi (float)
30528	0x020F	1 word	CH3 Read AI Scaling Value Low (float)
30529	0x0210	1 word	CH4 Read AI Scaling Value Hi (float)
30530	0x0211	1 word	CH4 Read AI Scaling Value Low (float)
31537	0x0600	1 word	CH0 RTD Value <R> 0~65535, Unit:0.1 (Ohm, Celsius, Fahrenheit)
31538	0x0601	1 word	CH1 RTD Value <R> 0~65535, Unit:0.1 (Ohm, Celsius, Fahrenheit)
31539	0x0602	1 word	CH2 RTD Value <R> 0~65535, Unit:0.1 (Ohm, Celsius, Fahrenheit)
34097	0x1000	1 word	DIO0 direction (1: DO ,0:DI)
34098	0x1001	1 word	DIO0 direction (1: DO ,0:DI)
34099	0x1002	1 word	DIO0 direction (1: DO ,0:DI)
34100	0x1003	1 word	DIO0 direction (1: DO ,0:DI)
34101	0x1004	1 word	DIO0 direction (1: DO ,0:DI)
34102	0x1005	1 word	DIO0 direction (1: DO ,0:DI)
34103	0x1006	1 word	DIO0 direction (1: DO ,0:DI)
34104	0x1007	1 word	DIO0 direction (1: DO ,0:DI)
34105	0x1008	1 word	DIO0 direction (1: DO ,0:DI)
34106	0x1009	1 word	DIO0 direction (1: DO ,0:DI)
34107	0x100A	1 word	DIO0 direction (1: DO ,0:DI)
34108	0x100B	1 word	DIO0 direction (1: DO ,0:DI)
34609	0x1200	1 word	CH0 AI Mode 1: current(mA) , 0: Voltage(mV) (R)
34610	0x1200	1 word	CH1 AI Mode 1: current(mA) , 0: Voltage(mV) (R)
34611	0x1200	1 word	CH2 AI Mode 1: current(mA) , 0: Voltage(mV) (R)
34612	0x1200	1 word	CH3 AI Mode 1: current(mA) , 0: Voltage(mV) (R)
34613	0x1200	1 word	CH4 AI Mode 1: current(mA) , 0: Voltage(mV) (R)
34617	0x1208	1 word	CH0 Read AI Min Value
34618	0x1209	1 word	CH1 Read AI Min Value
34619	0x120A	1 word	CH2 Read AI Min Value
34620	0x120B	1 word	CH3 Read AI Min Value
34621	0x120C	1 word	CH4 Read AI Min Value
34625	0x1210	1 word	CH0 Read AI Max Value
34626	0x1211	1 word	CH1 Read AI Max Value
34627	0x1212	1 word	CH2 Read AI Max Value
34628	0x1213	1 word	CH3 Read AI Max Value
34629	0x1214	1 word	CH4 Read AI Max Value
34641	0x1220	1 word	CH0 Read AI Min Scaling Value Hi (float)
34642	0x1221	1 word	CH0 Read AI Min Scaling Value Low (float)
34643	0x1222	1 word	CH1 Read AI Min Scaling Value Hi (float)
34644	0x1223	1 word	CH1 Read AI Min Scaling Value Low (float)

34645	0x1224	1 word	CH2 Read AI Min Scaling Value Hi (float)
34646	0x1225	1 word	CH2 Read AI Min Scaling Value Low (float)
34647	0x1226	1 word	CH3 Read AI Min Scaling Value Hi (float)
34648	0x1227	1 word	CH3 Read AI Min Scaling Value Low (float)
34649	0x1228	1 word	CH4 Read AI Min Scaling Value Hi (float)
34650	0x1229	1 word	CH4 Read AI Min Scaling Value Low (float)
34657	0x1230	1 word	CH0 Read AI Max Scaling Value Hi (float)
34658	0x1231	1 word	CH0 Read AI Max Scaling Value Low (float)
34659	0x1232	1 word	CH1 Read AI Max Scaling Value Hi (float)
34660	0x1233	1 word	CH1 Read AI Max Scaling Value Low (float)
34661	0x1234	1 word	CH2 Read AI Max Scaling Value Hi (float)
34662	0x1235	1 word	CH2 Read AI Max Scaling Value Low (float)
34663	0x1236	1 word	CH3 Read AI Max Scaling Value Hi (float)
34664	0x1237	1 word	CH3 Read AI Max Scaling Value Low (float)
34665	0x1238	1 word	CH4 Read AI Max Scaling Value Hi (float)
34666	0x1239	1 word	CH4 Read AI Max Scaling Value Low (float)
35633	0x1600	1 word	CH0 RTD Minimum Value <R> 0~65535, Unit:0.1 (Ohm, Celsius, Fahrenheit)
35634	0x1601	1 word	CH1 RTD Minimum Value <R> 0~65535, Unit:0.1 (Ohm, Celsius, Fahrenheit)
35635	0x1602	1 word	CH2 RTD Minimum Value <R> 0~65535, Unit:0.1 (Ohm, Celsius, Fahrenheit)
35645	0x160C	1 word	CH0 RTD Maximum Value <R> 0~65535, Unit:0.1 (Ohm, Celsius, Fahrenheit)
35646	0x160D	1 word	CH1 RTD Maximum Value <R> 0~65535, Unit:0.1 (Ohm, Celsius, Fahrenheit)
35647	0x160E	1 word	CH2 RTD Maximum Value <R> 0~65535, Unit:0.1 (Ohm, Celsius, Fahrenheit)

4xxxx Read/Write Registers (Support function 3,6,16)

Reference	Address	Data Type	Description
40001	0x0000	1 word	CH0 DO Value 0: Off 1: On
40002	0x0001	1 word	CH1 DO Value 0: Off 1: On
40003	0x0002	1 word	CH2 DO Value 0: Off 1: On
40004	0x0003	1 word	CH3 DO Value 0: Off 1: On
40005	0x0004	1 word	CH4 DO Value 0: Off 1: On
40006	0x0005	1 word	CH5 DO Value 0: Off 1: On
40007	0x0006	1 word	CH6 DO Value 0: Off 1: On
40008	0x0007	1 word	CH7 DO Value 0: Off 1: On
40009	0x0008	1 word	CH8 DO Value 0: Off 1: On
40010	0x0009	1 word	CH9 DO Value 0: Off 1: On
40011	0x000A	1 word	CH10 DO Value 0: Off 1: On
40012	0x000B	1 word	CH11 DO Value 0: Off 1: On

40017	0x0010	1 word	CH0 DO Pulse Operate Status 0: Off 1: On
40018	0x0011	1 word	CH1 DO Pulse Operate Status 0: Off 1: On
40019	0x0012	1 word	CH2 DO Pulse Operate Status 0: Off 1: On
40020	0x0013	1 word	CH3 DO Pulse Operate Status 0: Off 1: On
40021	0x0014	1 word	CH4 DO Pulse Operate Status 0: Off 1: On
40022	0x0015	1 word	CH5 DO Pulse Operate Status 0: Off 1: On
40023	0x0016	1 word	CH6 DO Pulse Operate Status 0: Off 1: On
40024	0x0017	1 word	CH7 DO Pulse Operate Status 0: Off 1: On
40025	0x0018	1 word	CH8 DO Pulse Operate Status 0: Off 1: On
40026	0x0019	1 word	CH9 DO Pulse Operate Status 0: Off 1: On
40027	0x001A	1 word	CH10 DO Pulse Operate Status 0: Off 1: On
40028	0x001B	1 word	CH11 DO Pulse Operate Status 0: Off 1: On

B

Network Port Numbers

ioLogik E1261W-T Network Port Usage

Port	Type	Usage
80	TCP	Web console service
502	TCP	Modbus/TCP communication
68	UDP	BOOTP/DHCP
4800	UDP	Auto search
69	UDP	Export/import configuration file
9900	TCP	Active OPC Server
9950	TCP	Active OPC Server

Factory Default Settings

ioLogik E1261W-T series products are configured with the following factory default settings:

Default IP address	192.168.127.254
Default Netmask	255.255.255.0
Default Gateway	0.0.0.0
Communication watchdog	Disable
Modbus/TCP Alive Check	On
Modbus/TCP Timeout Interval	60 sec
DI Mode	DI
Filter time	100 ms
Trigger for counter	Lo to Hi
Counter status	Stop
DO Mode	DO
DO Safe Status	Disable
Power on status	Disable
Low width for pulse	1 ms (1.5 s for relay)
Hi width for pulse	1 ms (1.5 s for relay)
Output pulses	0 (continuous)
DIO Mode	DO
AI Mode	Voltage
Scaling and Slop-Intercept	Disable
Password	N/A
Server Name	N/A
Server Location	N/A
AO Mode	Voltage
Scaling	Disable

D

FCC Interference Statement

Federal Communication Commission Warning!

This equipment has been tested and found to comply with the limits for a Class A digital device, pursuant to part 15 of the FCC Rules. Operation is subject to the following two conditions: (1) This device may not cause harmful interference, and (2) this device must accept any interference received, including interference that may cause undesired operation.

These limits are designed to provide reasonable protection against harmful interference when the equipment is operated in a commercial environment. This equipment generates, uses, and can radiate radio frequency energy and, if not installed and used in accordance with the instruction manual, may cause harmful interference to radio communications. Operation of this equipment in a residential area is likely to cause harmful interference in which case the user will be required to correct the interference at his own expense.

E

European Community (CE)

This is a Class A product. In a domestic environment, this product may cause radio interference in which case the user may be required to take adequate measures.