

MGate 5103 User's Manual

Edition 1.0, December 2017

www.moxa.com/product

MOXA[®]

© 2017 Moxa Inc. All rights reserved.

MGate 5103 User's Manual

The software described in this manual is furnished under a license agreement and may be used only in accordance with the terms of that agreement.

Copyright Notice

© 2017 Moxa Inc. All rights reserved.

Trademarks

The MOXA logo is a registered trademark of Moxa Inc.
All other trademarks or registered marks in this manual belong to their respective manufacturers.

Disclaimer

Information in this document is subject to change without notice and does not represent a commitment on the part of Moxa.

Moxa provides this document as is, without warranty of any kind, either expressed or implied, including, but not limited to, its particular purpose. Moxa reserves the right to make improvements and/or changes to this manual, or to the products and/or the programs described in this manual, at any time.

Information provided in this manual is intended to be accurate and reliable. However, Moxa assumes no responsibility for its use, or for any infringements on the rights of third parties that may result from its use.

This product might include unintentional technical or typographical errors. Changes are periodically made to the information herein to correct such errors, and these changes are incorporated into new editions of the publication.

Technical Support Contact Information

www.moxa.com/support

Moxa Americas

Toll-free: 1-888-669-2872
Tel: +1-714-528-6777
Fax: +1-714-528-6778

Moxa Europe

Tel: +49-89-3 70 03 99-0
Fax: +49-89-3 70 03 99-99

Moxa India

Tel: +91-80-4172-9088
Fax: +91-80-4132-1045

Moxa China (Shanghai office)

Toll-free: 800-820-5036
Tel: +86-21-5258-9955
Fax: +86-21-5258-5505

Moxa Asia-Pacific

Tel: +886-2-8919-1230
Fax: +886-2-8919-1231

Table of Contents

1. Introduction	1-1
Overview	1-2
Package Checklist	1-2
Product Features	1-2
2. Hardware	2-1
Power Input and Relay Output Pinouts	2-2
LED Indicators	2-2
Dimensions	2-3
Pin Assignments	2-3
Mounting the Unit	2-4
Specifications	2-4
Reset Button	2-6
Pull-Up, Pull-Down, and Terminator for RS-485	2-7
MicroSD	2-7
3. Getting Started	3-1
Connecting the Power	3-2
Connecting Serial Devices	3-2
Connecting to a Network	3-2
Installing DSU Software	3-2
Logging in to the Web Console	3-3
Quick Setup	3-4
Quick Setup—System Setting	3-4
Quick Setup—Select Protocol	3-5
Quick Setup—Role 1 and Role 2 of MGate 5103	3-5
Quick Setup—Finish	3-7
4. Web Console Configuration and Troubleshooting	4-1
Overview	4-2
Basic Settings	4-2
Network Settings	4-3
Serial Settings	4-3
Protocol Settings (Agent Mode)	4-4
Protocol Settings—Protocol Conversion	4-4
Protocol Settings - Modbus TCP Client (Master) Settings	4-6
Protocol Settings - Modbus RTU/ASCII Master Settings	4-8
Protocol Settings - Modbus TCP Server (Slave) Settings	4-9
Protocol Settings - Modbus RTU/ASCII Slave Settings	4-10
Protocol Settings - PROFINET IO Device Settings	4-10
Protocol Settings - EtherNet/IP Adapter Settings	4-11
Protocol Settings—I/O Data Mapping	4-12
System Management	4-13
System Management—Accessible IP List	4-13
System Management—DoS Defense	4-14
System Management—System Log Settings	4-14
System Management—Auto Warning Settings	4-15
System Management—Email Alert	4-16
System Management—SNMP Trap	4-16
System Management—SNMP Agent	4-17
System Management—LLDP Settings	4-17
System Management—Certificate	4-18
System Management—Misc. Settings	4-18
System Management—Maintenance	4-21
System Monitoring (Troubleshooting)	4-23
System Monitoring—System Status	4-23
System Monitoring—Protocol Status	4-25
Status Monitoring	4-27
5. Configuration (Text Mode Console)	5-1
6. Network Management Tool (MXstudio)	6-1
A. SNMP Agents with MIB II and RS-232-Like Groups	A-1
RFC1213 MIB-II Supported SNMP Variables	A-2
RFC1317 RS-232-Like Groups	A-3

Introduction

Welcome to the MGate 5103 line of Modbus/EtherNet/IP-to-PROFINET gateways. All models feature easy protocol conversion between Modbus RTU/ASCII/TCP, EtherNet/IP, and PROFINET protocols. This chapter is an introduction to the MGate 5103.

The following topics are covered in this chapter:

- **Overview**
- **Package Checklist**
- **Product Features**

Overview

The MGate 5103 is an industrial Ethernet gateway for Modbus RTU/ASCII/TCP, EtherNet/IP, and PROFINET network communications. To integrate existing Modbus devices and an EtherNet/IP control system into a PROFINET network, use the MGate 5103 as a Modbus master/slave or EtherNet/IP adapter to collect data and exchange data with PROFINET devices. The latest exchange data will be stored in the gateway. The gateway converts stored Modbus or EtherNet/IP data into PROFINET packets so the PROFINET IO controller can control or monitor field devices.

Package Checklist

All models of the MGate 5103 Series are shipped with the following items:

Standard Accessories:

- MGate 5103 gateway
- Serial cable: DBL-RJ45F9-150
- Quick installation guide (printed)
- Warranty card

Please notify your sales representative if any of the above items are missing or damaged.

Optional Accessories (can be purchased separately)

- CBL-F9M9-150: DB9-female-to-DB9-male serial cable, 150 cm
- CBL-F9M9-20: DB9-female-to-DB9-male serial cable, 20 cm
- CBL-RJ45SF9-150: RJ45-to-DB9-female shielded serial cable, 150 cm
- ADP-RJ458P-DB9F: DB9-female-to-RJ45 connector
- ADP-RJ458P-DB9F-ABC01: DB9-female-to-RJ45 connector
- Mini DB9F-to-TB: DB9-female-to-terminal-block connector

Product Features

- Supports PROFINET IO devices
- Supports Modbus RTU/ASCII/TCP client/master/server/slave
- Supports an EtherNet/IP adapter
- Step-by-step guide with wizard configuration
- Complete packet analysis and diagnostic information for maintenance
- Embedded Modbus RTU/ASCII/TCP traffic monitoring
- microSD card for configuration backup and event logs
- -40 to 75°C wide operating temperature models available
- Serial port with 2 kV built-in isolation protection
- Built-in Ethernet cascading for easy wiring
- Security features based on IEC-62443 standards

2

Hardware

The following topics are covered in this chapter:

- ❑ **Power Input and Relay Output Pinouts**
- ❑ **LED Indicators**
- ❑ **Dimensions**
- ❑ **Pin Assignments**
- ❑ **Mounting the Unit**
- ❑ **Specifications**
- ❑ **Reset Button**
- ❑ **Pull-Up, Pull-Down, and Terminator for RS-485**
- ❑ **MicroSD**

Power Input and Relay Output Pinouts



	V2+	V2-				V1+	V1-
Shielded Ground	DC Power Input 2	DC Power Input 2	N.O.	Common	N.C.	DC Power Input 1	DC Power Input 1

LED Indicators

Agent Mode:

LED	Color	Description
Ready	Off	Power is off or a fault condition exists
	Green	Steady: Power is on, and the MGate is functioning normally
	Red	Steady: Power is on, and the MGate is booting up
		Blinking slowly: Indicates an IP conflict, or the DHCP or BOOTP server is not responding properly
MB/EIP	Off	Modbus: No communication with Modbus device EtherNet/IP: No I/O data exchange
	Green (Blinking)	Modbus: Communication is in progress EtherNet/IP: I/O data is exchanging
	Red (Blinking)	Communication error When the MGate 5103 acts as a Modbus Client/Master: <ol style="list-style-type: none"> Slave device returned an error (exception) Received a frame error (parity error, checksum error) Timeout (slave device is not responding or the TCP connection timed out) When the MGate 5103 acts as a Modbus Server/Slave: <ol style="list-style-type: none"> Received invalid function code Master accessed invalid register address or coil addresses Received frame error (parity error, checksum error) When the MGate 5103 acts as an EtherNet/IP adapter: <ol style="list-style-type: none"> Refuses connection due to incorrect configuration
PN	Off	No connection with the PROFINET IO controller
	Green (Blinking)	The PROFINET IO is connected, and the controller is in RUN mode
	Red (Blinking)	The PROFINET IO is connected, but the controller is in STOP mode

Dimensions

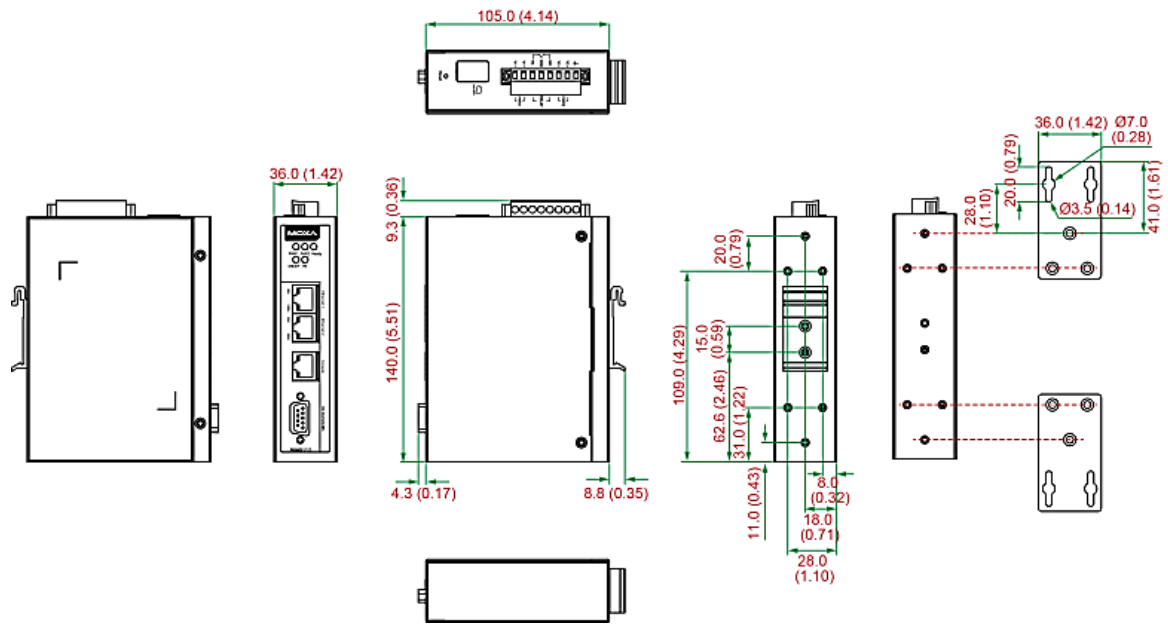

Unit: mm (inch)

Pin Assignments

Serial Port (Male DB9)

Pin	RS-232	RS-422/RS-485 (4W)	RS-485 (2W)
1	DCD	TxD-(A)	-
2	RXD	TxD+(B)	-
3	TXD	RxD+(B)	Data+(B)
4	DTR	RxD-(A)	Data-(A)
5*	GND	GND	GND
6	DSR	-	-
7	RTS	-	-
8	CTS	-	-
9	-	-	-

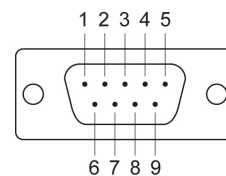

*Signal ground

Ethernet Port (RJ45)

Pin	Signal
1	Tx+
2	Tx-
3	Rx+
6	Rx-

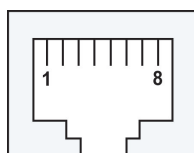

Console Port (RS-232)

The MGate 5103 Series can use an RJ45 serial port to connect to a PC for device configuration.

Pin	RS-232
1	DSR
2	RTS
3	GND
4	TXD
5	RXD
6	DCD
7	CTS
8	DTR

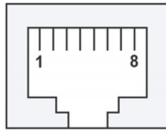

Mounting the Unit

1. Connect the power adapter. Connect the 12-48 VDC power line or DIN-rail power supply to the MGate 5103's terminal block.
2. Use a serial cable to connect the MGate to the Modbus device.
3. Use an Ethernet cable to connect the MGate to the Modbus, PROFINET or EtherNet/IP device.
4. The MGate 5103 is designed to be attached to a DIN rail or mounted on a wall. For DIN-rail mounting, push down the spring and properly attach it to the DIN rail until it snaps into place. For wall mounting, install the wall-mounting kit (optional) first and then screw the device onto the wall.

The following figure illustrates the two mounting options:

Wall-Mount Installation

DIN-Rail Installation

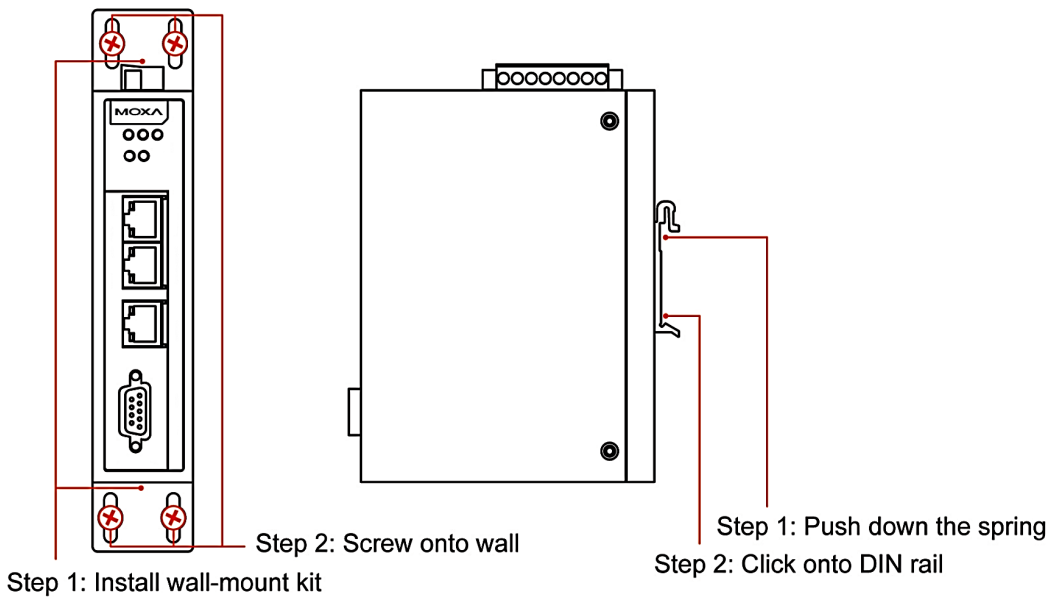

Specifications

Ethernet Interface

Protocols: Modbus TCP, PROFINET RT, EtherNet/IP

Number of Ports: 2 (1 IP, Ethernet cascade)

Speed: 10/100 Mbps, Auto MDI/MDIX

Connector: 8-pin RJ45

Magnetic Isolation Protection: 1.5 kV (built-in)

PROFINET:

- Type: IO device (slave)
- Max. data size per IO transmission:
 - Input: 512 bytes
 - Output: 512 bytes
- Max. number of connections:
 - MGate as PROFINET IO device: 1 connection for read/write

EtherNet/IP:

- Class: adapter (slave)
- CIP Objects Supported: Identity, Message Router, Assembly, Connection Manager, TCP/IP interface, Ethernet link, Port
- Max. number of connections:
 - MGate as an adapter: 1 connection for read-only, 1 connection for read/write
- Max. total of I/O data size:
 - Input: 496 bytes
 - Output: 496 bytes

Modbus TCP:

- Mode: client (master), server (slave)
- Functions supported: 1, 2, 3, 4, 5, 6, 15, 16, 23
- Max. number of commands: 128
- Max. number of connections:
 - MGate as Modbus TCP Client: 32
 - MGate as Modbus TCP Server: 16
- Max. Total of data size:
 - Input: 512 bytes
 - Output: 512 bytes

Serial Interface**Protocols:** Modbus RTU/ASCII**Number of Ports:** 1**Serial Standards:** RS-232/422/485, software selectable**Connectors:** DB9 male**RS-485 Data Direction Control:** ADDC® (automatic data direction control)**Pull Up/Down Resistor for RS-485:** 1 k Ω , 150 k Ω **Terminator for RS-485:** 120 Ω **Isolation:** 2 kV (built-in)**Modbus RTU/ASCII:**

- Mode: master, slave
- Functions supported: 1, 2, 3, 4, 5, 6, 15, 16, 23
- Max. number of commands: 128
- Max. total for I/O Data Size:
 - Input: 512 bytes
 - Output: 512 bytes

Serial Communication Parameters**Data Bits:** 7, 8**Stop Bits:** 1, 2**Parity:** None, Even, Odd, Space, Mark**Flow Control:** RTS/CTS, RTS Toggle (RS-232 only)**Baudrate:** 50 bps to 921.6 kbps**Serial Signals****RS-232:** TxD, RxD, RTS, CTS, DTR, DSR, DCD, GND**RS-422:** Tx+, Tx-, Rx+, Rx-, GND**RS-485-4w:** Tx+, Tx-, Rx+, Rx-, GND**RS-485-2w:** Data+, Data-, GND

Software

Configuration Options: Web Console, Serial Console

Configuration: MXconfig, MXview, SNMP (v1, v2c, v3), Private MIB

Physical Characteristics

Housing: Metal, IP30

Weight: 507 g (1.12 lb)

Dimensions: 36 x 105 x 140 mm (1.42 x 4.14 x 5.51 in)

Storage Card Slot: 1 microSD (SDHC) card slot supports up to 32 GB

Relay Alarm Circuit: 3-pin circuit with current carrying capacity of 2 A @ 30 VDC

Environmental Limits

Operating Temperature:

Standard Models: 0 to 60°C (32 to 140°F)

Wide Temp. Models: -40 to 75°C (-40 to 167°F)

Storage Temperature: -40 to 85°C (-40 to 185°F)

Ambient Relative Humidity: 5 to 95% (non-condensing)

Vibration: IEC 60068-2-6, IEC 60068-2-64

Shock: IEC 60068-2-27

Drop: IEC 60068-2-32

Power Requirements

Input Voltage: 12 to 48 VDC

Input Current: 455 mA @ 12 VDC; 125 mA @ 48 VDC

Power Connector: Terminal block

Standards and Certifications

Safety: UL 508, EN 60950-1

Hazardous Location: Class 1 Division 2, ATEX, IECEx

EMC: EN 55022/24

EMI: CISPR 22, FCC Part 15B Class B

EMS:

IEC 61000-4-2 ESD: Contact: 8 kV; Air: 15 kV

IEC 61000-4-3 RS: 80 MHz to 1 GHz: 10 V/m

IEC 61000-4-4 EFT: Power: 4 kV; Signal: 2 kV

IEC 61000-4-5 Surge: Power: 2 kV; Signal: 2 kV

IEC 61000-4-6 CS: 150 kHz to 80 MHz: 10 V/m

IEC 61000-4-8 PFMF

MTBF (mean time between failures)

Time: 859,422 hrs

Standard: Telcordia SR332

Warranty

Warranty Period: 5 years

Details: See www.moxa.com/warranty

Reset Button

Reset Button

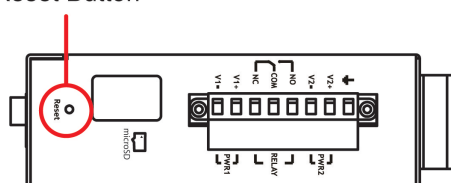

Restore the MGate to factory default settings by using a pointed object (such as a straightened paper clip) to hold the reset button down until the Ready LED stops blinking (approx. five seconds).

Pull-Up, Pull-Down, and Terminator for RS-485

Remove the MGate 5103's top cover, and you will find DIP switches to adjust each serial port's pull-up resistor, pull-down resistor, and terminator.

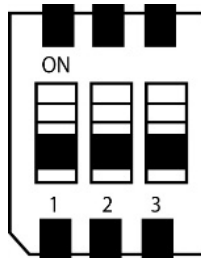

SW	1	2	3
	Pull-up resistor	Pull-down resistor	Terminator
ON	1 kΩ	1 kΩ	120 Ω
OFF	150 kΩ*	150 kΩ*	—*

*Default

MicroSD

The MGate 5103 provides users with an easy way to backup, copy, replace, or deploy. The MGate is equipped with a microSD card slot. Users can plug in a microSD card to backup data, including the system configuration setting, and system data log.

First time using the MGate gateway with a new microSD card

1. Format the microSD card as FAT file system through a PC.
2. Power off the MGate and insert the microSD card (ensure that the microSD card is empty).
3. Power on the MGate. The default settings will be copied to the microSD card.
4. Manually configure the MGate via web console, and all the stored changes will copy to the microSD card for synchronization.

First time using the MGate with a microSD card containing a configuration file

1. Power off the MGate and insert the microSD card.
2. Power on the MGate.
3. The configuration file stored in the microSD card will automatically copy to the MGate.

Duplicating current configurations to another MGate gateway

1. Power off the MGate and insert a new microSD card.
2. Power on the MGate.
3. The configuration will be copied from the MGate to the microSD card.
4. Power off the MGate and insert the microSD card to the other MGate.
5. Power on the second MGate.
6. The configuration file stored in the microSD card will automatically copy to the MGate.

Malfunctioning MGate replacement

1. Replace the malfunctioning MGate with a new MGate.
2. Insert the microSD card into the new MGate.
3. Power on the MGate.
4. The configuration file stored on the microSD card will automatically copy to the MGate.

MicroSD card writing failure

The following circumstances may cause the microSD card to experience a writing failure:

1. The microSD card has less than 20 Mbytes of free space remaining.

2. The microSD card is write-protected.
3. The file system is corrupted.
4. The microSD card is damaged.

The MGate will stop working in case of the above events, accompanied by a flashing Ready LED and beeping alarm. When you replace the MGate gateway's microSD card, the microSD card will synchronize the configurations stored on the MGate gateway. Note that the replacement microSD card should not contain any configuration files on it; otherwise, the out-of-date configuration will copy to the MGate device.

The following topics are covered in this chapter:

- ❑ **Connecting the Power**
- ❑ **Connecting Serial Devices**
- ❑ **Connecting to a Network**
- ❑ **Installing DSU Software**
- ❑ **Logging in to the Web Console**
- ❑ **Quick Setup**
 - Quick Setup—System Setting
 - Quick Setup—Select Protocol
 - Quick Setup—Role 1 and Role 2 of MGate 5103
 - Quick Setup—Finish

Connecting the Power

The unit can be powered by connecting a power source to the terminal block:

1. Loosen or remove the screws on the terminal block.
2. Turn off the power source and then connect a 12–48 VDC power line to the terminal block.
3. Tighten the connections, using the screws on the terminal block.
4. Turn on the power source.

Note that the unit does not have an on/off switch. It automatically turns on when it receives power. The PWR LED on the top panel will glow to indicate that the unit is receiving power. For power terminal block pin assignments, refer to the **Power Input and Relay Output Pinout** section in *chapter 2*.

Connecting Serial Devices

The MGate 5103 supports Modbus serial devices. Before connecting or removing the serial connection, first make sure the power is turned off. For the serial port pin assignments, see the *Pin Assignments* section in *chapter 2*.

Connecting to a Network

Connect one end of the Ethernet cable to the MGate's 10/100M Ethernet port and the other end of the cable to the Ethernet network. The MGate will indicate a valid connection to the Ethernet in the following ways:

- The Ethernet LED maintains a solid green color when connected to a 100 Mbps Ethernet network.
- The Ethernet LED maintains a solid orange color when connected to a 10 Mbps Ethernet network.
- The Ethernet LED will flash when Ethernet packets are being transmitted or received.

Installing DSU Software

If you do not know the MGate gateway's IP address when setting it up for the first time (default IP is *192.168.127.254*); use an Ethernet cable to connect the host PC and MGate gateway directly. If you connect the gateway and host PC through the same Ethernet switch, make sure there is no router between them. You can then use the **Device Search Utility (DSU)** to detect the MGate gateways on your network.

The following instructions explain how to install the DSU, a utility to search for MGate 5103 units on a network.

1. Insert the Document and Software CD into the CD-ROM drive. Locate and run the following setup program to begin the installation process:

dsu_setup_[Version]_Build_[DateTime].exe

This version might be named **dsu_setup_Ver2.x_Build_xxxxxxx.exe**

2. You will be greeted by the Welcome window. Click **Next** to continue.
3. When the **Select Destination Location** window appears, click **Next** to continue. You may change the destination directory by first clicking on **Browse...**
4. When the **Select Additional Tasks** window appears, click **Next** to continue. You may select **Create a desktop icon** if you would like a shortcut to the DSU on your desktop.
5. Click **Install** to start copying the software files.
6. A progress bar will appear. The procedure should take only a few seconds to complete.
7. A message will indicate that the DSU is successfully installed. You may choose to run it immediately by selecting **Launch DSU**.
8. You may also open the DSU through **Start → Programs → MOXA → DSU**.

The DSU window should appear as shown below.

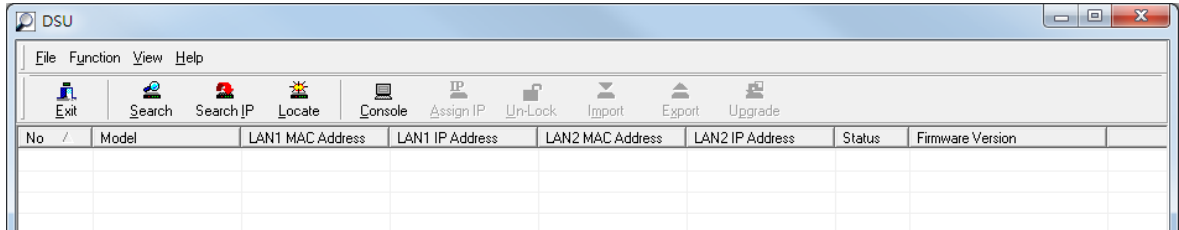

Click **Search** and a new Search window will pop up.

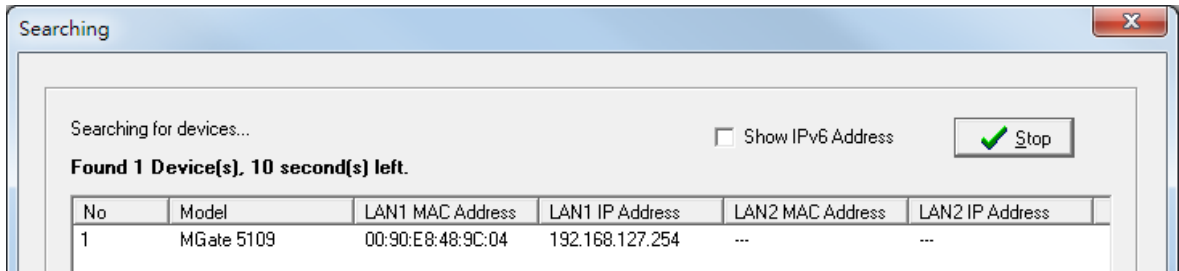

Logging in to the Web Console

Use the Web console to configure the MGate through Ethernet or verify the MGate’s status. Use a web browser, such as Microsoft Internet Explorer or Google Chrome to connect to the MGate, using the HTTP/HTTPS protocol.

When the MGate gateway appears on the DSU device list, select the gateway and use the right-click the mouse button to open a web console to configure the gateway.

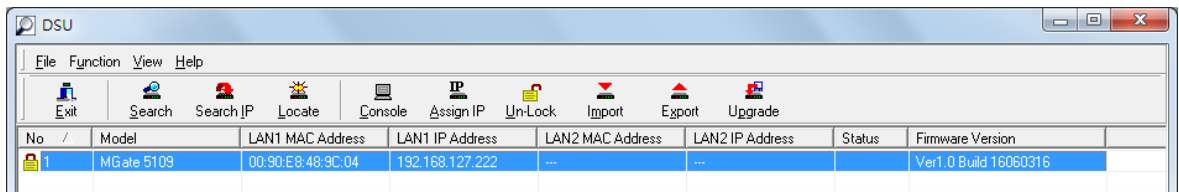

On the first page of the web console, enter **admin** for the default Account name and **moxa** for the default Password.

Account

Password

Login

When you log in the web console for the first time, a message will pop up. Emphasizing a higher security level, we suggest you to change the password. The password can be changed in the following path:

System Management>Misc. Settings>Account Management

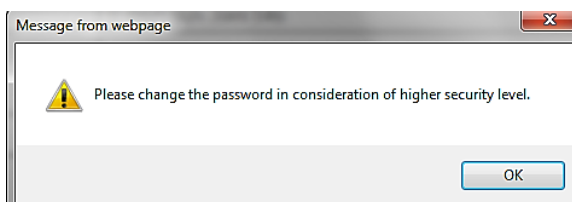

Quick Setup

The MGate series now provides a Quick Setup wizard, an illustrated guide specifically designed to make the configuration process easy. The Quick Setup wizard takes you through the configuration process from start to finish so that you do not miss any step. The following agent modes are supported in the Quick Setup:

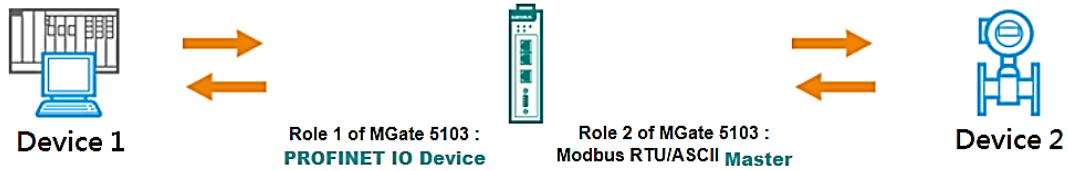

Device 1	Device 2
PROFINET IO controller	Modbus RTU/ASCII slave
PROFINET IO controller	Modbus RTU/ASCII master
PROFINET IO controller	Modbus TCP client
PROFINET IO controller	Modbus TCP server
PROFINET IO controller	EtherNet/IP scanner

Quick Setup—System Setting

First, configure the **Server Settings** to identify the units and **Network Settings** of the MGate.

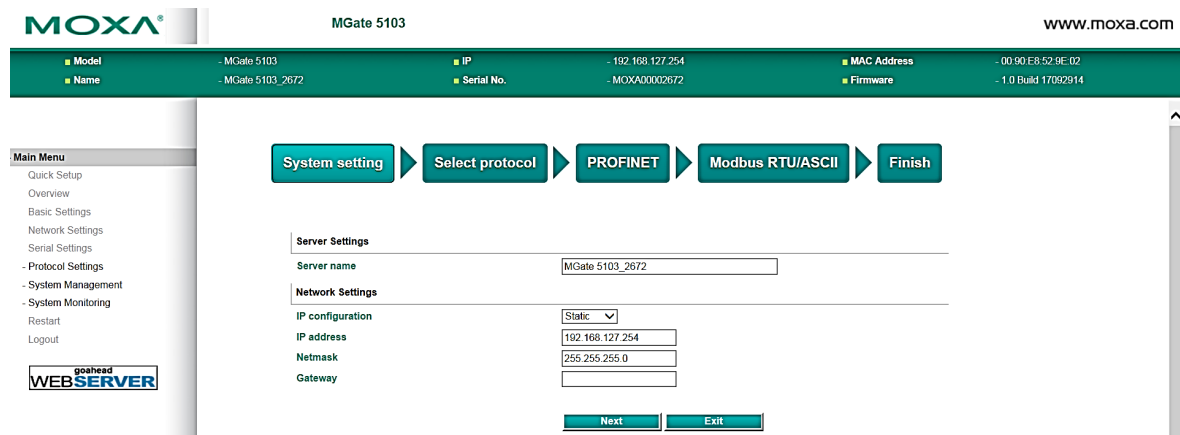

Quick Setup—Select Protocol

Then, you should select your devices' protocols on each side. After selection, the MGate will change its role to the correct one. For example, if the device is set as a PROFINET IO controller, the MGate will then automatically configure as a PROFINET IO device by itself. Regarding protocol configuration, refer to *chapter 4*.

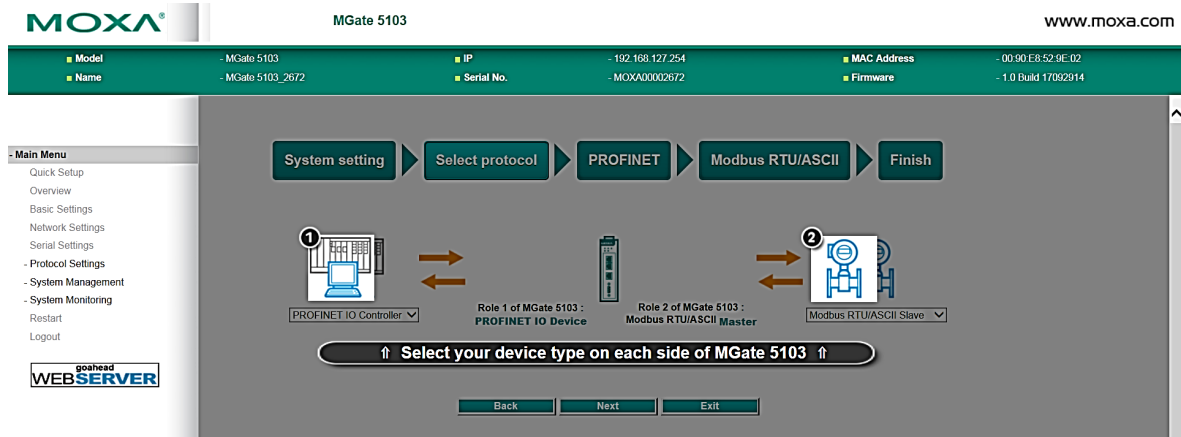

Quick Setup—Role 1 and Role 2 of MGate 5103

After finishing the device protocol selection, Role 1 and Role 2 of MGate will be confirmed. You will need to configure the roles on each side by the following steps. Here is an example of Role 1 as a PROFINET IO controller, and Role 2 as a Modbus RTU/ASCII Slave.

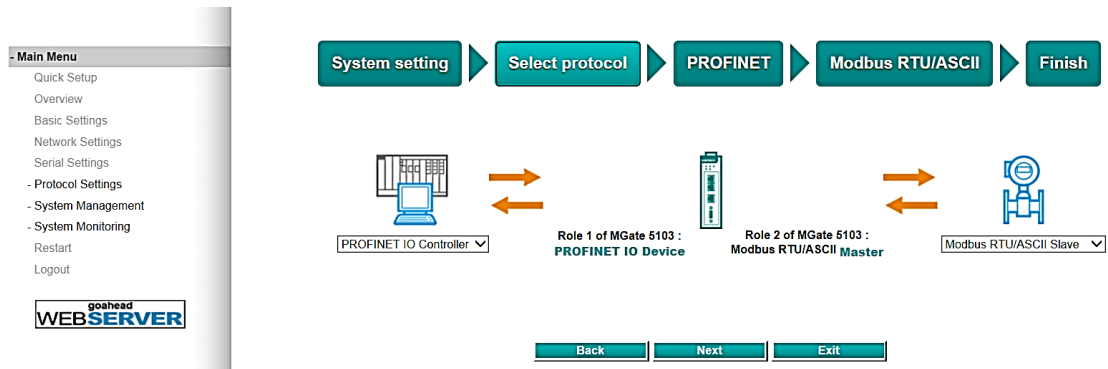

PROFINET settings: Set MGate Unit ID and TCP port.

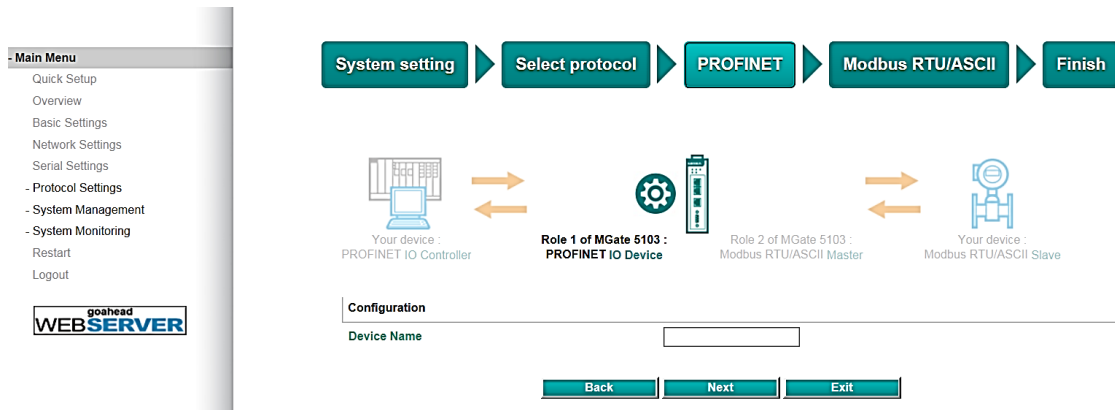

Modbus RTU/ASCII settings: Set Mode selection, Serial Parameters Settings and Modbus Commands.

System setting → **Select protocol** → **PROFINET** → **Modbus RTU/ASCII** → **Finish**

Your device: PROFINET IO Controller Role 1 of MGate 5103: PROFINET IO Device Role 2 of MGate 5103: Modbus RTU/ASCII Master Your device: Modbus RTU/ASCII Slave

Modbus Mode
 Mode selection: Modbus RTU

Serial Parameter Settings

Baud rate	Parity	Data bit	Stop bit	Flow control	Interface	RTS on delay	RTS off delay
115200	Even	8	1	None	RS-232	0	0

Modbus Commands

*press ctrl key to multi-select | Add | Edit | Clone | Delete | Move

Index	Name	Slave ID	Function	Address / Quantity
-------	------	----------	----------	--------------------

Back Next Exit

Modbus Command settings: For configuration details, refer to Chapter 4.

System setting → **Select protocol** → **PROFINET** → **Modbus RTU/ASCII** → **Finish**

Your device: PROFINET IO Controller

Modbus Mode
 Mode selection: Modbus RTU

Serial Parameter Settings

Baud rate	Parity	Data bit	Stop bit	Flow control	Interface	RTS on delay	RTS off delay
115200	Even	8	1	None	RS-232	0	0

Modbus Commands

*press ctrl key to multi-select | Add | Edit | Clone | Delete | Move

Index	Name	Slave ID	Function	Address / Quantity
-------	------	----------	----------	--------------------

Name: Command1
 Slave ID: 1
 Function: 03 - Read Holding Registers
 Read starting address: 0 (0 - 65535)
 Read quantity: 10

OK Cancel

Quick Setup—Finish

Once all the configurations are done, you can check if the parameters are correct on this webpage. Click **Save** to make the parameters effective. To view PROFINET and Modbus mapping data, click I/O data mapping. To export GSDML for PLC use, click PROFINET IO Settings, and go to the **Protocol Settings > I/O Data Mapping** page. For additional details, refer to *chapter 4, Protocol Settings—I/O Data Mapping*.

MGate 5103 www.moxa.com

Model: MGate 5103 | IP: 192.168.127.254 | MAC Address: 00:90:E8:52:9E:02
 Name: MGate 5103_2672 | Serial No.: MOXA00002672 | Firmware: 1.0 Build 17/101722

System setting > Select protocol > **PROFINET** > Modbus RTU/ASCII > Finish

MGate name: MGate 5103_2672
 MGate IP config: 192.168.127.254
 Netmask: 255.255.255.0
 Gateway: -

Your device: PROFINET IO Controller ↔ Role 1 of MGate 5103: PROFINET IO Device ↔ Role 2 of MGate 5103: Modbus RTU/ASCII Master ↔ Your device: Modbus RTU/ASCII Slave

MGate Protocol1 Settings		MGate Protocol2 Settings	
Protocol type	PROFINET IO Device	Protocol type	Modbus serial master
Device name		Mode	Modbus RTU
IO size	Go to "I/O data mapping" after "Save"	Serial parameter	115200 Even,8,1 RS-232
		Total commands	1

Back Save Exit

MGate Protocol1 Settings		MGate Protocol2 Settings	
Protocol type	Modbus TCP Server	Protocol type	Dnp3 Serial Master
Unit ID	1	Outstation 1 Name	Outstation1
TCP port	502	DNP3 Address	2
		BI points index	0-10
		BO points index	0,1,2,3,4
		Counter points index	2,5
		AI points index	0-2,10
		AO points index	1,3,10

MGate 5103 www.moxa.com

Model: MGate 5103 | IP: 192.168.127.254 | MAC Address: 00:90:E8:52:9E:02
 Name: MGate 5103_2672 | Serial No.: MOXA00002672 | Firmware: 1.0 Build 17/101722

Wizard Settings OK!

Home PROFINET I/O Settings I/O data mapping

Web Console Configuration and Troubleshooting

This chapter provides a quick overview of how to configure the MGate 5103 by web console.

The following topics are covered in this chapter:

- ❑ **Overview**
- ❑ **Basic Settings**
- ❑ **Network Settings**
- ❑ **Serial Settings**
- ❑ **Protocol Settings (Agent Mode)**
 - Protocol Settings—Protocol Conversion
 - Protocol Settings - Modbus TCP Client (Master) Settings
 - Protocol Settings - Modbus RTU/ASCII Master Settings
 - Protocol Settings - Modbus TCP Server (Slave) Settings
 - Protocol Settings - Modbus RTU/ASCII Slave Settings
 - Protocol Settings - PROFINET IO Device Settings
 - Protocol Settings - EtherNet/IP Adapter Settings
 - Protocol Settings—I/O Data Mapping
- ❑ **System Management**
 - System Management—Accessible IP List
 - System Management—DoS Defense
 - System Management—System Log Settings
 - System Management—Auto Warning Settings
 - System Management—Email Alert
 - System Management—SNMP Trap
 - System Management—SNMP Agent
 - System Management—LLDP Settings
 - System Management—Certificate
 - System Management—Misc. Settings
 - System Management—Maintenance
- ❑ **System Monitoring (Troubleshooting)**
 - System Monitoring—System Status
 - System Monitoring—Protocol Status
- ❑ **Status Monitoring**

Overview

This section gives an overview of the MGate 5103 status.

❖ Welcome to MGate 5103

Model name	MGate 5103
Serial No.	MOXA00002672
Firmware version	1.0 Build 17092914
Ethernet IP address	192.168.127.254
Ethernet MAC address	00:90:E8:52:9E:02
Up time	0 days 01h:29m:06s
Power 1	On
Power 2	Off
microSD	Not Detected

Basic Settings

On this webpage, you can change the name of the device and time zone settings.

❖ Basic Settings

Server Settings	
Server name	<input type="text" value="MGate 5103_2672"/>
Server location	<input type="text"/>
Time Settings	
Time zone	(GMT)Greenwich Mean Time: Dublin, Edinburgh, Lisbon, London ▾
Local time	<input type="text" value="2000"/> / <input type="text" value="01"/> / <input type="text" value="01"/> <input type="text" value="06"/> : <input type="text" value="27"/> : <input type="text" value="18"/>
Time server	<input type="text"/>
<input type="button" value="Submit"/>	

Server Setting

Parameter	Value	Description
Server Name	(an alphanumeric string)	You can enter a name to help you identify the unit, such as the function, etc.
Server Location	(an alphanumeric string)	You can enter a name to help you identify the unit location. Such as "Cabinet A001."

Time Settings

The MGate 5103 has a built-in Real-Time Clock for time calibration functions. Functions such as the log function can add real-time information to the message.



ATTENTION

First-time users should select the time zone first. The console will display the "real time" according to the time zone relative to GMT. If you would like to modify the real-time clock, select **Local time**. MGate's firmware will modify the GMT time according to the Time Zone.

Parameter	Value	Description
Time Zone	User's selectable time zone	This field shows the currently selected time zone and allows you to select a different time zone.
Local Time	User's adjustable time.	(1900/1/1-2037/12/31)
Time Server	IP or Domain address (e.g., 192.168.1.1 or time.stdtime.gov.tw)	This optional field specifies your time server's IP address or domain name if a time server is used on your network. The module supports SNTP (RFC-1769) for automatic time calibration. The MGate will request time information from the specified time server every 10 minutes.



ATTENTION

If the dispersion of the time server is higher than the client (MGate), the client will not accept NTP messages from the time server. MGate's dispersion is 1 second. You must configure your time server with a dispersion value lower than 1 sec for the NTP process to complete.

Network Settings

The Network Settings is where the unit's network settings are configured. You can modify the IP Configuration, IP Address, Netmask, Default Gateway, and DNS.

⚙️ Network Settings

Network Settings

IP configuration

IP address

Netmask

Gateway

DNS server 1

DNS server 2

Parameter	Value	Description
IP Configuration	Static IP, DHCP, BOOTP	Select Static IP if you are using a fixed IP address. Select one of the other options if the IP address is set dynamically.
IP Address	192.168.127.254 (or other 32-bit number)	The IP (Internet Protocol) address identifies the server on the TCP/IP network.
Netmask	255.255.255.0 (or other 32-bit number)	This identifies the server as belonging to a Class A, B, or C network.
Gateway	0.0.0.0 (or other 32-bit number)	This is the IP address of the router that provides network access outside the server's LAN.
DNS Server 1	0.0.0.0 (or other 32-bit number)	This is the IP address of the primary domain name server.
DNS Server 2	0.0.0.0 (or other 32-bit number)	This is the IP address of the secondary domain name server.

Serial Settings

The MGate 5103's serial interface supports RS-232, RS-422, and RS-485 interfaces. You must configure the baudrate, parity, data bits, and stop bits before using the serial interface with Modbus RTU/ASCII protocol. Incorrect settings will result in communication failures.

⚙️ Serial Settings

Port Baud rate Parity Data bit Stop bit Flow control FIFO Interface RTS on delay RTS off delay

Parameter	Value	Description
Baudrate	50 bps to 921600 bps	
Parity	None, Odd, Even, Mark, Space	
Data bits	7,8	
Stop bits	1, 2	

Parameter	Value	Description
Flow control	None, RTS/CTS, RTS Toggle	The RTS Toggle will turn off RTS signal when there is no data to be sent. If there is data to be sent, the RTS toggle will turn on the RTS signal before a data transmission and off after the transmission is completed.
FIFO	Enable, Disable	The internal buffer of UART. Disabling FIFO can reduce the latency time when receiving data from serial communications, but this will also slow down the throughput.
Interface	RS-232, RS-422, RS-485 2 wire, RS-485 4 wire	
RTS on delay	0-100 ms	Only available for RTS Toggle
RTS off delay	0-100 ms	Only available for RTS Toggle

RTS Toggle

The RTS Toggle function is used for **RS-232** mode only. This flow-control mechanism is achieved by toggling the RTS pin in the transmission direction. When activated, data will be sent after the RTS pin is toggled ON for the specified time interval. After the data transmission is finished, the RTS pin will toggle OFF for the specified time interval.

Protocol Settings (Agent Mode)

A typical MGate 5103 application consists of a SCADA/PLC as a client/master and a field device as a server/slave. Both these components use different protocols and hence need a gateway in between to exchange data. The MGate can do the role of a gateway by acting as the server/slave when it is connected to SCADA/PLC and the client/master when it is connected to a field device. Therefore, to configure an MGate, you must:

1. Select the correct protocols in the **Protocol Conversion** setting after which the details of both *sides* of the MGate’s role is shown below the selection.
2. Configure MGate’s roles for both sides. Configure the master side first followed by the slave side.
3. After the MGate configuration is completed, click **I/O data mapping** to view details on exchanging data with the SCADA/PLC.

The following sections contain detailed MGate configuration instructions organized as per the above outline.

Protocol Settings—Protocol Conversion

The MGate 5103 supports Modbus RTU/ASCII, Modbus TCP, EtherNet/IP, and PROFINET protocols. The MGate fulfills a different role on each of its sides. Each role is determined by your device’s settings. Therefore, set the role of each of your devices correctly. PROFINET IO controller, Modbus RTU/ASCII Master/Slave, Modbus TCP Client/Server, EtherNet/IP Scanner can be selected.

Below is the selection table of the MGate 5103.

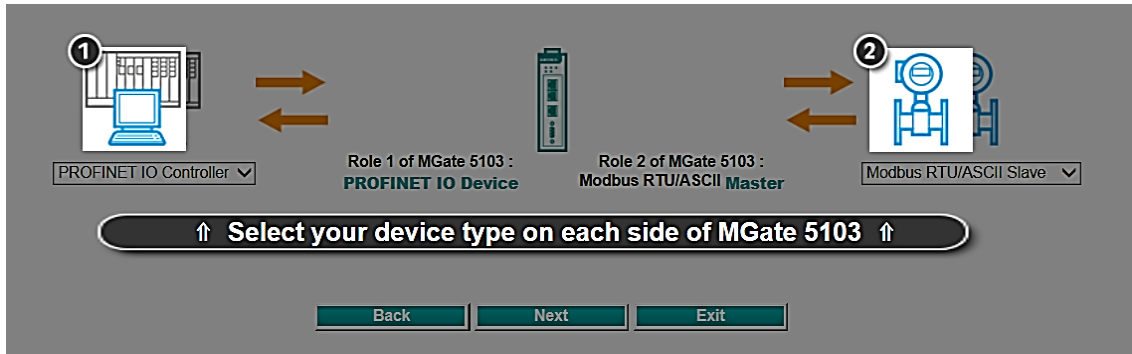

Device 1	Device 2
PROFINET IO controller	Modbus TCP client
PROFINET IO controller	Modbus TCP server
PROFINET IO controller	Modbus RTU/ASCII master
PROFINET IO controller	Modbus RTU/ASCII slave
PROFINET IO controller	EtherNet/IP scanner

The MGate 5103 runs agent mode when it is used for various different protocol conversions. In agent mode, the MGate 5103 uses an internal memory to exchange data.

The MGate’s internal memory is divided into two parts—one for input and the other for output as shown in the illustration below. The internal memory concept is shown in the figure below:

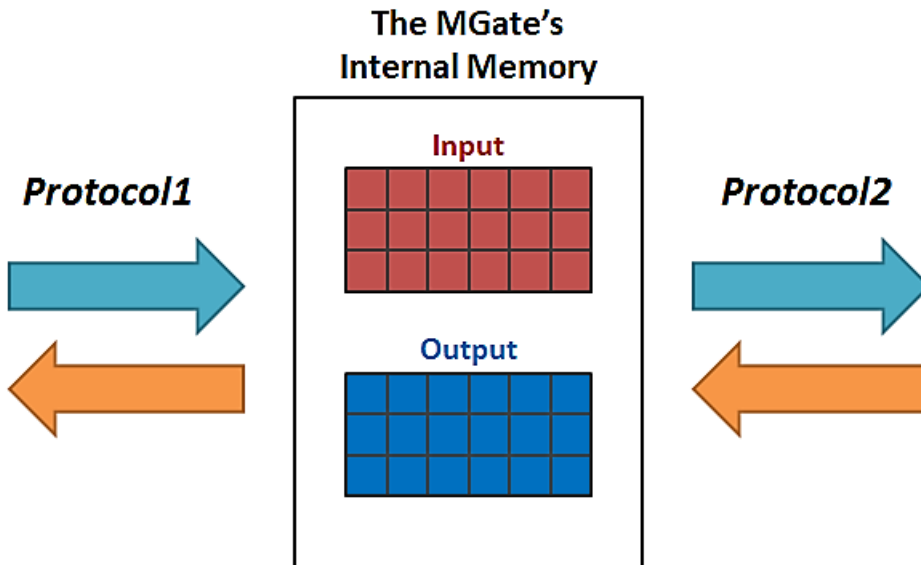

To learn more about MGate’s internal memory, refer to **Protocol Settings- I/O Data Mapping**.

After protocol selection, we have to configure each side of MGate’s role. In a typical application, one side of MGate will be set as a server/slave and the other side will be set as a client/master. The following configuration settings are possible:

- A1. Modbus TCP Client (Master) Settings
- A2. Modbus RTU/ASCII Master Settings
- A3. Modbus TCP Server (Slave) Settings
- A4. Modbus RTU/ASCII Slave Settings
- A5. PROFINET IO Device Settings

A6. EtherNet/IP Adapter Settings

Protocol Settings - Modbus TCP Client (Master) Settings

Modbus TCP Settings

Role Client

Client Settings

Initial delay: 0 (0 - 30000 ms)

Max. retry: 3 (0 - 5)

Response timeout: 1000 (10 - 120000 ms)

Modbus Commands

Buttons: Add, Edit, Clone, Delete, Move

Index	Name	Slave IP Address	Slave ID	Function	Address / Quantity	Trigger	Poll Interval	Endian Swap
-------	------	------------------	----------	----------	--------------------	---------	---------------	-------------

Client Settings

Parameter	Value	Default	Description
Initial delay	0-30000 ms	0	Some Modbus slaves may take more time to boot up than other devices. In some environments, this may cause the entire system to suffer from repeated exceptions during the initial boot-up. After booting up, you can force the MGate to wait before sending the first request with the Initial Delay setting.
Max. retry	0-5	3	This is used to configure how many times the MGate will try to communicate with the Modbus slave.
Response timeout	10-120000 ms	1000	The time taken by a slave device to respond to a request is defined by the device manufacturer based on the Modbus standard. A Modbus master can be configured to wait a certain amount of time for a slave's response. If no response is received within the specified time, the master will disregard the request and continue operation. This allows the Modbus system to continue the operation even if a slave device is disconnected or faulty. On the MGate 5103, the Response timeout field is used to configure how long the gateway will wait for a response from a Modbus slave. Refer to your device manufacturer's documentation to manually set the response timeout

Add Modbus Commands

Role Client Settings

Initial delay

Max. retry

Response timeout

Modbus Commands

Buttons: OK, Cancel

Index	Name	Slave IP Address	Slave ID	Function	Address / Quantity	Trigger	Poll Interval	Endian Swap
-------	------	------------------	----------	----------	--------------------	---------	---------------	-------------

Parameter	Value	Default	Description
Name	(an alphanumeric string)	Command1	Max. 32 characters
Slave IP address	0.0.0.0 - 255.255.255.255	0.0.0.0	The IP address of a remote slave device.
Port	1-65535	502	The TCP port number of a remote slave device.
Slave ID	1-255	1	The Modbus slave ID
Function	1 – Read Coils 2 – Read Discrete Inputs 3 – Read Holding Registers 4 – Read Inputs Registers 5 – Write Single Coil 6 – Write Single Register 15 – Write Multiple Coils 16 – Write Multiple Registers 23 – Read/Write Multiple Registers		When a message is sent from a Client to a Server device, the function code field tells the server what kind of action to perform.
Trigger	Cyclic Data Change Disable		Disable: The command is never sent Cyclic: The command is sent cyclically at the interval specified in the Poll Interval parameter. Data change: The data area is polled for changes at the time interval defined by Poll Interval. A command is issued when a change in data is detected.
Poll interval	100-1200000 ms	1000	Polling intervals are in milliseconds. Since the module sends all requests in turns, the actual polling interval also depends on the number of requests in the queue and their parameters. The range is from 100 to 1,200,000 ms.
Endian swap	None Byte Word Byte and Word	None	Data Byte Swapping None: Don't need to swap Byte: 0x0A, 0x0B, 0x0C, 0x0D becomes 0x0B, 0x0A, 0x0D, 0x0C Word: 0x0A, 0x0B, 0x0C, 0x0D becomes 0x0C, 0x0D, 0x0A, 0x0B. ByteWord: 0x0A, 0x0B, 0x0C, 0x0D becomes 0x0D, 0x0C, 0x0B, 0x0A. There are two phases in changing ByteWord: 1) 0x0A, 0x0B, 0x0C, 0x0D becomes 0x0B, 0x0A, 0x0D, 0x0C 2) 0x0B, 0x0A, 0x0D, 0x0C becomes 0x0D, 0x0C, 0x0B, 0x0A
Read starting address	0-65535	0	Modbus register address.
Read quantity	Read Coils: 1 - 2000 Read Discrete Inputs: 1 - 2000 Read Inputs Registers: 1 - 125 Read Holding Registers: 1 - 125 Read/Write Multiple Registers:	10	Specifying how many items to read.

Parameter	Value	Default	Description
	1 - 125		
Write starting address	0-65535	0	Modbus register address.
Write quantity	Write Multiple Coils: 1 - 1968 Write Multiple Registers: 1 - 123 Read/Write Multiple Registers: 1 - 123	1	Specifying how many items to write into.
Fault protection	Keep latest data Clear all data bits to 0 Set to user defined value		If MGate’s connection to the other side (server/slave) fails, the gateway will not be able to receive data, but the gateway will continuously send output data to the Modbus TCP server device. To avoid problems in this case, the MGate 5103 can be configured to react in one the following three ways: Keep latest data, clear data to zero, set the data bits to user-defined values.
Fault value		00 00	The user-defined values to write into the data bits when the Set to user defined value option is selected.
Fault timeout	1-86400 s	3600	Defines the communication timeout for the opposite side.

Protocol Settings - Modbus RTU/ASCII Master Settings

⚙️ Modbus RTU/ASCII Settings

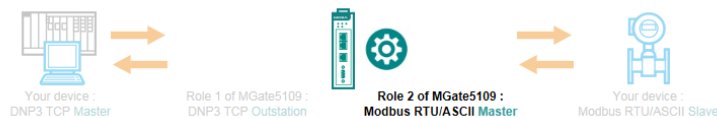

Role: Master
 Mode:

Master Settings

Initial delay: (0 - 30000 ms)
 Max. retry: (0 - 5)
 Response timeout: (10 - 120000 ms)
 Inter-frame delay: (10 - 500 ms, 0: default)
 Inter-character timeout: (10 - 500 ms, 0: default)

Modbus Commands

Master Settings

Parameter	Value	Default	Description
Mode	RTU or ASCII	RTU	The Modbus protocol type
Initial delay	0-30000 ms	0	Some Modbus slaves may take more time to boot up than other devices. In some environments, this may cause the entire system to suffer from repeated exceptions during the initial boot-up. After booting up, you can force the MGate to wait before sending the first request with the Initial Delay setting.
Max. retry	0-5	3	The number of times the master will retry the same

Parameter	Value	Default	Description
			request when the response times out.
Response timeout	10-120000 ms	1000	According to the Modbus standard, the time it takes for a slave device to respond to a request is defined by the device manufacturer. Based on this response time, a master can be configured to wait a certain amount of time for a slave's response. If no response is received within the specified time, the master will disregard the request and continue operation. This allows the Modbus system to continue operations even if a slave device is disconnected or faulty. On the MGate 5103, the Response timeout field is used to configure how long the gateway will wait for a response from a Modbus ASCII or RTU slave. Refer to your device manufacturer's documentation to manually set the response time.
Inter-frame delay (only for Modbus RTU)	10-500 ms	0	Use this function to determine the timeout interval between characters for Modbus devices that cannot receive Rx signals within an expected time interval. If the response is timed out, all received data will be discarded. The MGate 5103 will automatically determine the timeout interval if the timeout value is set to 0.
Inter-character timeout (only for Modbus RTU)	10-500 ms	0	The users can determine the time delay to transmit the data frame received from the slave device to the upstream. The MGate 5103 will automatically determine the time interval if it is set to 0.

Add Modbus Commands

Refer to *Modbus TCP Client (Master) Settings*.

Protocol Settings - Modbus TCP Server (Slave) Settings

⚙️ **Modbus TCP Settings**

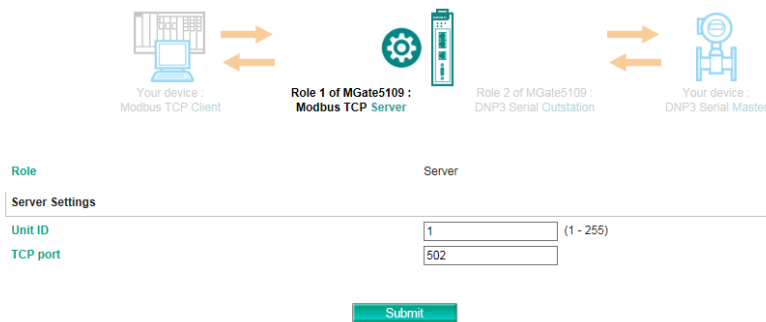

Server Settings

Parameter	Value	Default	Description
Unit ID	1-255	1	The Modbus slave ID that this slave module will accept.
TCP port	1-65535	502	The TCP port number.

Protocol Settings - Modbus RTU/ASCII Slave Settings

⚙️ Modbus RTU/ASCII Settings

Your device : DNP3 TCP Master ↔ Role 1 of MGate5109 : DNP3 TCP Outstation
 Role 2 of MGate5109 : Modbus RTU/ASCII Slave ↔ Your device : Modbus RTU/ASCII Master

Role: Slave
 Mode: RTU
 Slave Settings
 Slave ID: (1 - 255)
 Submit

Slave Settings

Parameter	Value	Default	Description
Mode	RTU or ASCII	RTU	The Modbus protocol type
Slave ID	1-255	2	The Modbus slave ID that this slave module will accept.

Protocol Settings - PROFINET IO Device Settings

The PROFINET IO Device settings are very simple. For PROFINET IO communication, the IO controller only needs to input the **Device Name** to exchange data.

⚙️ PROFINET Settings

Your device : PROFINET IO Controller ↔ Role 1 of MGate 5103 : PROFINET IO Device
 Role 2 of MGate 5103 : Modbus RTU/ASCII Master ↔ Your device : Modbus RTU/ASCII Slave

Configuration
 Device Name:
 Export GSDML:
 submit

Parameter	Value	Description
Device Name	<alphanumeric string>	Enter the PROFINET server name (if you type the name incorrectly, the connection will fail).

The function of **Export GSDML** is used for easy configuration when setting the PROFINET IO controller system. Typically, users waste lots of time in importing MGate 5103 general GSDML files and then setting the IO modules, respectively. If we import the specified GSDML, which is based on Modbus settings, we just need to pull the module to the PROFINET system. Then the IO modules will be set, and you can run the communication.

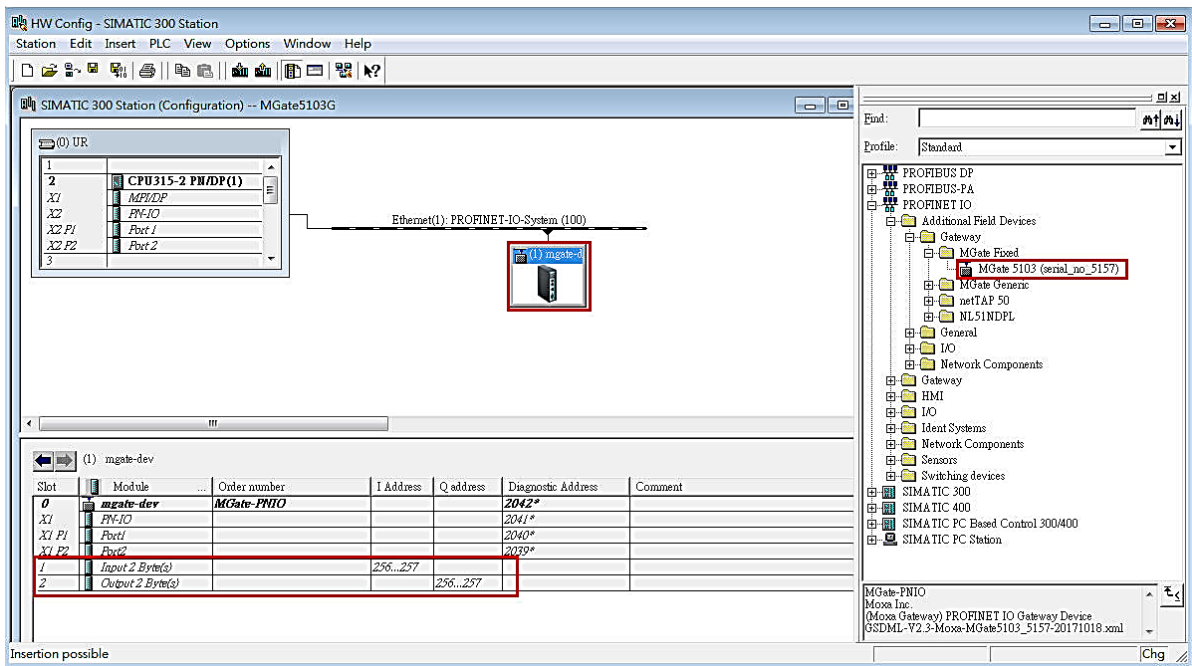

Protocol Settings - EtherNet/IP Adapter Settings

The MGate 5103 supports Adapter mode for EtherNet/IP protocol. In Adapter mode, you should configure **O->T (Originator to Target)** and **T->O (Target to Originator)** data sizes to exchange data with the PROFINET IO controller.

⚙️ EtherNet/IP

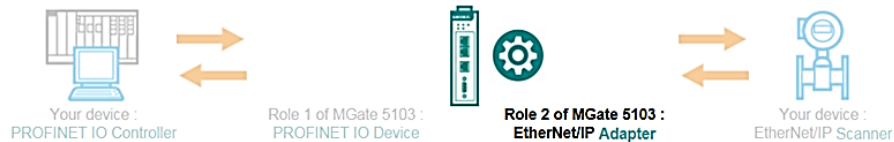

Mode selection Adapter

EIP encapsulation inactivity timeout (0 - 3600 sec, 0 for disable)

Connection1 Adapter Settings

O → T instance 100

T → O instance 110

I/O data size configuration

O → T (Output) data size (0 - 496 bytes)

T → O (Input) data size (0 - 496 bytes)

Parameter	Value	Default	Description
EIP encapsulation inactivity timeout	0 – 300 sec, 0 for disable	120	
O → T instance (Output) data size	0 – 496 bytes	0	The O → T (output size) should the same as EtherNet/IP Scanner
T → O instance (Input) data size	0 – 496 bytes	0	The T → O (Input size) should the same as EtherNet/IP Scanner

Protocol Settings—I/O Data Mapping

After you have configured Role 1 and Role 2 (client/master and server/slave) of the MGate settings, the PLC/SCADA in the master role will start monitoring and controlling the remote slave device. MGate uses its internal memory to facilitate data exchange. The **I/O Data Mapping** page shows the complete mapping status.

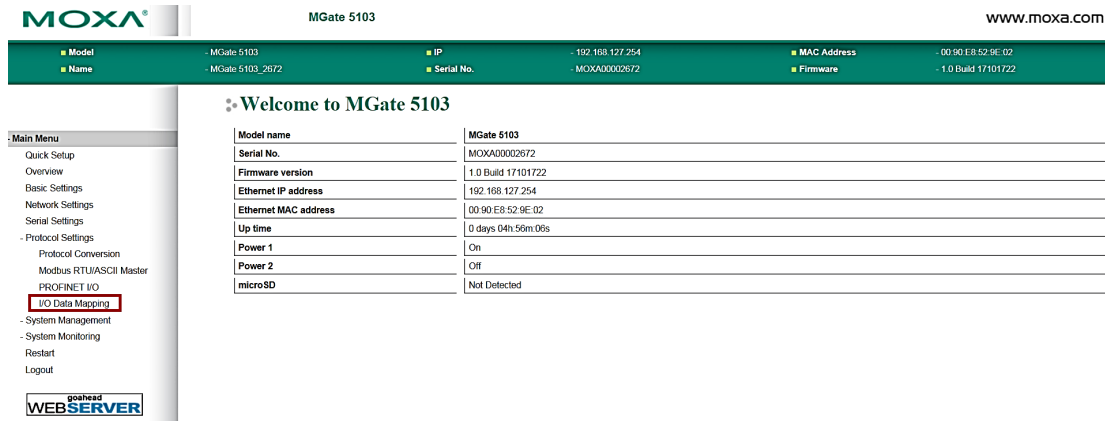

The following examples illustrate Role 1 and Role 2 configurations of MGate:

Example - MGate 5103 as PROFINET IO Device (Role 1) and Modbus RTU/ASCII Master (Role 2)

If the PROFINET IO controller wants to set the Modbus RTU command, *Room1_Breaker2*, the PROFINET IO controller must use the second byte to do the changes. The MGate will then trigger a Room1_Breaker2 write request to the Modbus RTU slave device.

⚙️ I/O Data Mapping

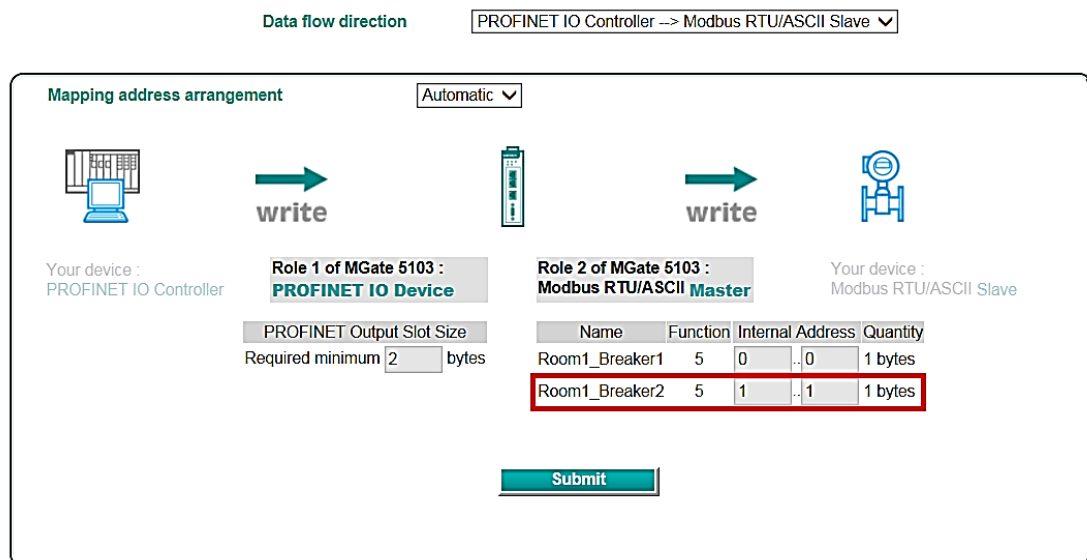

Likewise, if the PROFINET IO controller wants to read the Modbus RTU command, *Room1_Voltage1*, the PROFINET IO controller must use the first two bytes to collect the data. The other side of the MGate will periodically update the value in the internal memory through cyclic polling to the Modbus RTU slave device.

I/O Data Mapping

Data flow direction PROFINET IO Controller <-- Modbus RTU/ASCII Slave

Mapping address arrangement Automatic ▾



read

Your device :
PROFINET IO Controller





read

Your device :
Modbus RTU/ASCII Slave

Role 1 of MGate 5103 :
PROFINET IO Device

PROFINET Input Slot Size
Required minimum bytes

Name	Function	Internal Address	Quantity
Room1_Voltage1	3	0 .. 1	2 bytes
Room1_Voltage2	3	2 .. 3	2 bytes

Submit

System Management

System Management—Accessible IP List

Accessible IP List

Enable the accessible IP list. ("Disable" will allow all IP's connection request.)

No.	Active	IP	Netmask
1	<input checked="" type="checkbox"/>	<input type="text" value="192.168.127.11"/>	<input style="border: 1px solid gray;" type="text" value="255.255.255.0"/> x
2	<input type="checkbox"/>	<input type="text"/>	<input type="text"/>
3	<input type="checkbox"/>	<input type="text"/>	<input type="text"/>
4	<input type="checkbox"/>	<input type="text"/>	<input type="text"/>
5	<input type="checkbox"/>	<input type="text"/>	<input type="text"/>
6	<input type="checkbox"/>	<input type="text"/>	<input type="text"/>
7	<input type="checkbox"/>	<input type="text"/>	<input type="text"/>
8	<input type="checkbox"/>	<input type="text"/>	<input type="text"/>

These settings are used to restrict access to the module by the IP address. Only IP addresses on the list will be allowed access to the device. You may add a specific address or range of addresses by using a combination of an IP address and a netmask as follows:

To allow access to a specific IP address: Enter the IP address in the corresponding field; enter 255.255.255.255 for the netmask.

To allow access to hosts on a specific subnet: For both the IP address and netmask, use 0 for the last digit (e.g., "192.168.1.0" and "255.255.255.0").

To allow access to all IP addresses: Make sure that **Enable** the accessible IP list is not checked.

Additional configuration examples are shown in the following table:

Allowed hosts	Entered IP address/Netmask
Any host	Disable "Accessible IP List" function
192.168.1.120	192.168.1.120 / 255.255.255.255
192.168.1.1 to 192.168.1.254	192.168.1.0 / 255.255.255.0
192.168.0.1 to 192.168.255.254	192.168.0.0 / 255.255.0.0
192.168.1.1 to 192.168.1.126	192.168.1.0 / 255.255.255.128
192.168.1.129 to 192.168.1.254	192.168.1.128 / 255.255.255.128

System Management—DoS Defense

Users can select from several options to enable DoS Defense in order to fend off cybersecurity attacks. A denial-of-service (DoS) attack is an attempt to make a machine or a network resource unavailable. Users can select from the following options to counter DoS attacks.

⚙️ DoS Defense

Configuration

Null Scan

NMAP-Xmas Scan

SYN/FIN Scan

FIN Scan

NMAP-ID Scan

SYN-Flood

Enable

Limit (pkt/s)

ICMP-Death

Enable

Limit (pkt/s)

Submit

System Management—System Log Settings

The system log settings enable the MGate firmware to record important events, which can be record in two ways: Syslog and Local Log (stored in the MGate).

⚙️ System Log Settings

Event Group	Syslog	Local Log	Summary
System	<input type="checkbox"/>	<input type="checkbox"/>	System cold start, System warm start
Network	<input type="checkbox"/>	<input type="checkbox"/>	DHCP/BOOTP get IP/renew, NTP connect fail, IP conflict, Network link down
Configuration	<input type="checkbox"/>	<input type="checkbox"/>	Login fail, IP changed, Password changed, Firmware upgrade, SSL certificate import, Config import, Config export, Configuration change, Clear event log
PROFINET	<input type="checkbox"/>	<input type="checkbox"/>	PROFINET communication logs
Modbus TCP	<input type="checkbox"/>	<input type="checkbox"/>	Modbus TCP communication logs
EtherNet/IP	<input type="checkbox"/>	<input type="checkbox"/>	EtherNet/IP communication logs

Local Log Settings

Enable log capacity warning at (%)

Warning by: SNMP Trap Email

Event log oversize action:

Syslog Settings

Syslog server IP

Syslog server port

submit

The available information that can be recorded includes the following events:

Event Group	Description
System	System Cold Start, System Warm Start
Network	DHCP/BOOTP Get IP/Renew, NTP Connect Fail, IP Conflict, Network Link Down
Configuration	Login Fail, IP Changed, Password Changed, Firmware Upgrade, SSL Certificate Import, Configuration Import/Export, Configuration Change, Clear Event Log
PROFINET	PROFINET communication logs
Modbus TCP	Modbus TCP communication logs
EtherNet/IP	EtherNet/IP communication logs

Local Log Settings	Description
Enable log capacity warning (%)	When the log amount exceeds the warning percentage, it will trigger an event to SNMP Trap or Email.
Warning by	SNMP Trap Email
Event log oversize action	Overwrites the oldest event log Stops recording event log

Syslog Settings	Description
Syslog server IP	IP address of a server which will record the log data
Syslog server port	514

System Management—Auto Warning Settings

• ~~Auto Warning Settings~~ Auto warning settings

System Event			
<input type="checkbox"/>		Cold start	Mail <input type="checkbox"/> Trap <input type="checkbox"/>
<input type="checkbox"/>		Warm start	Mail <input type="checkbox"/> Trap <input type="checkbox"/>
<input type="checkbox"/>	Relay <input type="checkbox"/>	Power input 1 failure	Mail <input type="checkbox"/> Trap <input type="checkbox"/>
<input type="checkbox"/>	Relay <input type="checkbox"/>	Power input 2 failure	Mail <input type="checkbox"/> Trap <input type="checkbox"/>
<input type="checkbox"/>	Relay <input type="checkbox"/>	Ethernet 1 link down	Mail <input type="checkbox"/> Trap <input type="checkbox"/>
<input type="checkbox"/>	Relay <input type="checkbox"/>	Ethernet 2 link down	Mail <input type="checkbox"/> Trap <input type="checkbox"/>
Config Event			
<input type="checkbox"/>		Console login fail	Mail <input type="checkbox"/> Trap <input type="checkbox"/>
		IP changed	Mail <input type="checkbox"/>
		Password changed	Mail <input type="checkbox"/>

Auto Warning is triggered by different events. When a checked trigger condition occurs, the MGate can send email alerts, SNMP Trap messages, or open/close the circuit of the relay output and trigger the Fault LED to start blinking. To enable an email alert, configure the email address on the **Email Alert** page. Likewise, to enable SNMP trap alerts, configure SNMP trap server on the **SNMP Trap** page.

System Management—Email Alert

⚙️ Email Alert

Mail Settings

Mail server (SMTP)

My server requires authentication

User name

Password

From email address

To email address 1

To email address 2

To email address 3

To email address 4

Parameters	Description
Mail server (SMTP)	The mail server's domain name or IP address.
User name	This field is for your mail server's user name, if required.
Password	This field is for your mail server's password, if required.
From email address	This is the email address from which automatic email warnings will be sent.
To email address 1 to 4	Email addresses to which automatic email warnings will be sent.

System Management—SNMP Trap

⚙️ SNMP Trap

SNMP Trap

SNMP trap server IP or domain name

Trap version v1 v2c

Trap community

Parameters	Description
SNMP trap server IP	Use this field to indicate the IP address to use for receiving SNMP traps.
Trap version	Use this field to select the SNMP trap version.
Trap community	Use this field to designate the SNMP trap community.

System Management—SNMP Agent

⚙️ SNMP Agent Settings

Configuration	
SNMP	Enable ▾
Contact name	<input type="text"/>
Read community string	public
Write community string	private
SNMP agent version	V1, V2c ▾
Read only user name	rouser
Read only authentication mode	Disable ▾
Read only password	<input type="text"/>
Read only privacy mode	Disable ▾
Read only privacy	<input type="text"/>
Read/write user name	rwuser
Read/write authentication mode	Disable ▾
Read/write password	<input type="text"/>
Read/write privacy mode	Disable ▾
Read/write privacy	<input type="text"/>

Parameters	Description
SNMP	To enable the SNMP Agent function, select the Enable option, and enter a community name (e.g., public).
Contact name	The optional SNMP contact information usually includes an emergency contact name and telephone number.
Read community string	This is a text password mechanism that is used to weakly authenticate queries to agents of managed network devices.
Write community string	This is a text password mechanism that is used to weakly authenticate changes to agents of managed network devices.
SNMP agent version	The MGate 5103 supports SNMP V1, V2c, and V3.

Read-only and Read/write access control

The following fields allow you to define user names, passwords, and authentication parameters for two levels of access: read-only and read/write. The name of the field will indicate which level of access it refers to. For example, **Read-only** authentication mode allows you to configure the authentication mode for read-only access, whereas **Read/write** authentication mode allows you to configure the authentication mode for read/write access. For each level of access, you may configure the following:

Parameters	Description
User name	Use this optional field to identify the user name for the specified level of access.
Authentication mode	Use this field to select MD5 or SHA as the method of password encryption for the specified level of access, or to disable authentication.
Privacy mode	Use this field to enable or disable DES_CBC data encryption for the specified level of access.
Password	Use this field to set the password for the specified level of access.
Privacy	Use this field to define the encryption key for the specified level of access.

System Management—LLDP Settings

The Link Layer Discovery Protocol (LLDP) standardizes the method that devices on a network use to periodically send information on their configuration and status. This self-identification method keeps all LLDP devices on a network informed of each other's status and configuration. You can use SNMP protocol to then send the LLDP

information on the network devices to Moxa's MXview to create auto network topology and for network visualization.

The MGate web interface lets you enable or disable LLDP, and set the LLDP transmit interval. In addition, you can go to **System Monitoring—System Status—LLDP Table** to view the MGate's neighbor-list, which is created based on the information reported by neighboring devices on the network.

⚙️ LLDP Settings

Configuration

LLDP

Message transmit interval (5 - 16383 secs)

Parameters	Values	Description
Message transmit interval	5-16383 secs (Default:30 secs)	MGate will send information on the configuration and status of devices in a network at regular intervals based on the value configured here.

System Management—Certificate

⚙️ Certificate

SSL Certificate

Issued to 192.168.127.254

Issued by 192.168.127.254

Valid from 2000/1/1 to 2009/12/29

Select SSL certificate file

Delete SSL certificate file

Use this function to load the Ethernet SSL certificate. Select or browse for the certificate file in the Select SSL certificate/key file field. This function is only available in the web console

System Management—Misc. Settings

This page includes console settings, password and relay output.

System Management—Misc. Settings—Console Settings

Console Settings

Configurations

HTTP console	<input type="text" value="Enable"/>
HTTPS console	<input type="text" value="Enable"/>
Telnet console	<input type="text" value="Enable"/>
SSH console	<input type="text" value="Enable"/>
Serial console	<input type="text" value="Enable"/>
Reset button	<input type="text" value="Always enable"/>
MOXA command	<input type="text" value="Enable"/>

Session Settings

Maximum login user for HTTP+HTTPS	<input type="text" value="5"/>	(1 ~ 10)
Auto logout setting	<input type="text" value="5"/>	(1 ~ 1440 min)

Configuration	Value	Description
HTTP/HTTPS	Enable/Disable	This setting is to enable/disable the web console. For security issues, users can only enable the HTTPS or just disable all settings.
Telnet/SSH	Enable/Disable	The MGate telnet/SSH function can be enabled or disabled.
Serial console	Enable/Disable	The MGate serial console function can be enabled or disabled.
Reset button protect	Disable after 60 sec, Always enable	MGate provides the reset button to clear password or load factory default settings. But for security issues, users can disable this function. In disabled mode, MGate will still enable this function within 60 seconds after boot-up, just in case users really need to reset this function.
MOXA command	Enable/Disable	The MGate can be searched by the DSU. If you have any security concerns, you can choose Disable to deny the DSU the right to access.

Session Settings	Value	Description
Maximum Login Users for HTTP+HTTPS	1-10	The number of users that can access the MGate at the same time.
Auto Logout Setting	0-1440 min.	Sets the auto logout time period.

System Management—Misc. Settings—Notification Message

Notification Message

Notification Message

Login message

0 character/Maximum 240 character

Login authentication failure message

The account or password you entered is incorrect.
(Your account will be temporarily locked if excessive tried.)

111 character/Maximum 240 character

Users can input a message for Login or for Login authentication failure message.

System Management—Misc. Settings—Account Management

Account Management

Add Account Settings

+ Add
✎ Edit
🗑 Delete

Account Name	Group
admin	admin
user	user

Submit

Parameters	Value	Description
Account	admin, user	Users can modify the password for different accounts. MGate provides two different level accounts: admin and user . Admin account can access and modify all the settings through the web console. User account can only view the setting and can't change anything.

System Management—Misc. Settings—Login Password Policy

⚙️ Login Password Policy

Account Password Policy

Minimum length (4 ~ 16)

Enable password complexity strength check

- At least one digit(0~9)
- Mixed upper and lower case letters(A~Z, a~z)
- At least one special character: ~!@#\$\$%^&*~_!;:~<>{}()

Password lifetime (90 ~ 180 days)

Account Login Failure Lockout

Enable

Retry failure threshold (1 ~ 10 time)

Lockout time (1 ~ 60 min)

Account Password Policy	Value	Description
Minimum length	4-16	The minimum password length
Enable password complexity strength check		Select how the MGate checks the password's strength
Password lifetime	90-180 days	Set the password's lifetime period.

Account Login Failure Lockout	Value	Description
Retry failure threshold	1-10 time	Indicates the number of login failures before the MGate locks out.
Lockout time	1-60 min	When the number of login failures exceeds the threshold, the MGate will lock out for a period of time.

System Management—Maintenance

System Management—Maintenance—Ping

This network testing function is available only in the web console. The MGate gateway will send an ICMP packet through the network to a specified host, and the result can be viewed in the web console immediately.

⚙️ Ping Test

Ping Destination

Destination

System Management—Maintenance—Firmware Upgrade

Firmware updates for the MGate 5103 are located at www.moxa.com. After you have downloaded the new firmware onto your PC, you can use the web console to write it onto your MGate 5103. Select the desired unit from the list in the web console and click **Submit** to begin the process.

⚙️ Firmware Upgrade

!!! Warning !!!

Upgrading firmware may cause MGate devices to reset to factory default.
We suggest you back up the configuration of all MGate devices.

Select firmware file



ATTENTION

DO NOT turn off the MGate power before the firmware upgrade process is completed. The MGate will be erasing the old firmware to make room for the new firmware to flash memory. If you power off the MGate and terminate the progress, the flash memory will contain corrupted firmware and the MGate will fail to boot. If this happens, call Moxa RMA services.

System Management—Maintenance—Configuration Import/Export

There are three main reasons for using the Import and Export functions:

- **Applying the same configuration to multiple units.** The Import/Export configuration function is a convenient way to apply the same settings to units located in different sites. You can export the configuration as a file and then import the configuration file onto other units at any time.
- **Backing up configurations for system recovery.** The export function allows you to export configuration files that can be imported onto other gateways to restore malfunctioning systems within minutes.
- **Troubleshooting.** Exported configuration files can help administrators to identify system problems that provide useful information for Moxa’s Technical Service Team when maintenance visits are requested.

⚙️ Configuration Import/Export

Configuration Import

Select configuration file

Keep IP settings

Configuration Export

System Management—Maintenance—Load Factory Default

To clear all the settings on the unit, use the Load Factory Default to reset the unit to its initial factory default values.

⚙️ Load Factory Default

Click on **Submit** to reset all settings, including the console password, to the factory default values. To leave the IP address, netmask and gateway settings unchanged, make sure that **Keep IP settings** is enabled.

Reset to Factory Default

Keep IP settings

submit



ATTENTION

Load Default will completely reset the configuration of the unit, and all of the parameters you have saved will be discarded. Do not use this function unless you are sure you want to completely reset your unit.

System Monitoring (Troubleshooting)

MGate 5103 provides easy-to-use and useful troubleshooting tools. If a communication issue occurs, we suggest that you first check the **Protocol Status > Diagnosis** page for the status of the protocol. To analyze the Modbus RTU/ACSII/TCP traffic in detail, view the network logs available at **Protocol Status > Traffic**.

System Monitoring—System Status

System Monitoring—System Status—Network Connections

Go to **Network Connections** under **System Status** to view network connection information.

⚙️ Network Connections

Auto refresh

Protocol	Recv-Q	Send-Q	Local Address	Foreign Address	State
TCP	0	0	*:4900	*:0	LISTEN
TCP	0	0	*:80	*:0	LISTEN
TCP	0	0	*:502	*:0	LISTEN
TCP	0	0	*:22	*:0	LISTEN
TCP	0	0	*:23	*:0	LISTEN
TCP	0	0	*:443	*:0	LISTEN
TCP	0	0	192.168.127.254:80	192.168.127.222:5980	ESTABLISHED
UDP	0	0	*:161	*:0	
UDP	0	0	*:4800	*:0	

System Monitoring—System Status—System Log

Go to **Network Connections** under **System Status** to view network connection information.

⚙️ System Log

System Log

Export
Clear log
Refresh

System Monitoring—System Status—Relay State

The MGate gateway includes a built-in relay circuit that is triggered in the event of a power failure or if the Ethernet link is down. You can view the relay status on this page.

⚙️ Relay State

Auto refresh

Power input 1 failure	N/A	Acknowledge Event
Power input 2 failure	N/A	Acknowledge Event
Ethernet 1 link down	N/A	Acknowledge Event
Ethernet 2 link down	N/A	Acknowledge Event

System Monitoring—System Status—LLDP Table

You can see LLDP related information, including Port, Neighbor ID, Neighbor Port, Neighbor Port Description, and Neighbor System.

⚙️ LLDP Table

Port	Neighbor ID	Neighbor Port	Neighbor Port Description	Neighbor System
sw0	ks-hsu01	port-001		KS-HSU01

System Monitoring—Protocol Status

System Monitoring—Protocol Status—I/O Data View

This page displays the internal memory information for input and output data transfers. View updated values for communication verification here. This function is only available in the web console.

⚙️ I/O Data View

Auto refresh

Data flow direction: PROFINET IO Controller → EtherNet/IP Scanner

Start address(Hex): 0

Length: 128

Format: Hex

Internal Address	00	01	02	03	04	05	06	07	08	09	0A	0B	0C	0D	0E	0F
0000h	00	00	00	00	00	00	00	00	00	00	00	00	00	00	00	00
0010h	00	00	00	00	00	00	00	00	00	00	00	00	00	00	00	00
0020h	00	00	00	00	00	00	00	00	00	00	00	00	00	00	00	00
0030h	00	00	00	00	00	00	00	00	00	00	00	00	00	00	00	00
0040h	00	00	00	00	00	00	00	00	00	00	00	00	00	00	00	00
0050h	00	00	00	00	00	00	00	00	00	00	00	00	00	00	00	00
0060h	00	00	00	00	00	00	00	00	00	00	00	00	00	00	00	00
0070h	00	00	00	00	00	00	00	00	00	00	00	00	00	00	00	00

System Monitoring—Protocol Status—Diagnose

The MGate provides status information for Modbus RTU/ASCII/TCP, EtherNet/IP, and PROFINET troubleshooting. Verify data or packet counters to make sure the communications are running smoothly.

Modbus RTU/ASCII Diagnose (Master)

⚙️ Modbus RTU/ASCII Diagnose

Auto refresh

Category	Item	Value
Modbus	Mode	RTU Master
	Sent request	0
	Received valid response	0
	Received invalid response	0
	Received CRC/LRC Error	0
	Received exception	0
	Timeout	0
	Serial Port	Port is not opened.

Modbus RTU/ASCII Diagnose (Slave)

⚙️ Modbus RTU/ASCII Diagnose

Auto refresh

Category	Item	Value
Modbus	Mode	RTU Slave
	Slave ID	2
	Received valid request	0
	Received invalid request	0
	Received CRC/LRC error	0
	Sent response	0
	Sent exception	0
	Serial Port	Port number: 1
	Break: 0	
	Frame error: 0	
	Parity error: 0	
	Overrun error: 0	

Modbus TCP Diagnose (Client/Master)

⚙️ Modbus TCP Diagnose

Auto refresh

Category	Item	Value
Modbus	Mode	Master
	Number of connection	0
	Sent request	0
	Received valid response	0
	Received invalid response	0
	Received exception	0
	Timeout	0
Connections		

Modbus TCP Diagnose (Slave/Server)

⚙️ Modbus TCP Diagnose

Auto refresh

Category	Item	Value
Modbus	Mode	Slave
	Number of connection	0
	Received valid request	0
	Received invalid request	0
	Sent response	0
	Sent exceptions	0
Connections		

PROFINET Diagnose (IO Device)

⚙️ PROFINET Diagnose

Auto refresh

Category	Item	Value
PLC Status		
	Connected PLC MAC Address	Not Connected
	PLC Operation Mode	N/A
Parameters		
	Sender clock (packet interval)	0 ms
	Device name	
I/O Slot		

EtherNet/IP Diagnose (Adapter)

⚙️ EtherNet/IP Diagnose

Auto refresh

Overview		I/O Connection List	
Current TCP connections	0		
Maximum TCP connections observed	0		
Current I/O connections	0		
Total TCP transmit packets	0		
Total TCP receive packets	0		
Total TCP receive invalid packets	0		
Total UDP transmit packets	0		
Total UDP receive packets	0		
Total UDP receive invalid packets	0		
Connection1 Parameters		Connection Information	
O → T instance (exclusive owner)	100		
O → T instance (input only)	120		
T → O instance	110		
O → T data size	0		
T → O data size	0		

System Monitoring—Protocol Status—Traffic

Modbus RTU/ASCII/TCP Traffic

In order to troubleshoot efficiently, the MGate provides a traffic monitoring function that can capture both Modbus RTU/ASCII and Modbus TCP communication logs, respectively. These logs present the data in an intelligent, easy-to-understand format with clearly designated fields, including source, destination, function code, and data. The complete log can be saved in a file by clicking **Export** for later analysis.

⚙️ Modbus RTU/ASCII Traffic

Auto scroll

Capturing ...

No.	Time	Send/Receive	Slave ID	Function Code	Data
1	0.591	Send	1	3	01 03 00 01 00 01 D5 CA
2	0.632	Receive	1	3	01 03 02 00 00 B8 44
3	0.659	Send	1	3	01 03 00 00 00 01 84 0A
4	0.692	Receive	1	3	01 03 02 00 00 B8 44
5	1.590	Send	1	3	01 03 00 01 00 01 D5 CA
6	1.618	Receive	1	3	01 03 02 00 00 B8 44
7	1.659	Send	1	3	01 03 00 00 00 01 84 0A
8	1.700	Receive	1	3	01 03 02 00 00 B8 44
9	2.590	Send	1	3	01 03 00 01 00 01 D5 CA
10	2.630	Receive	1	3	01 03 02 00 00 B8 44
11	2.659	Send	1	3	01 03 00 00 00 01 84 0A
12	2.709	Receive	1	3	01 03 02 00 00 B8 44
13	3.615	Send	1	3	01 03 00 01 00 01 D5 CA
14	3.650	Receive	1	3	01 03 02 00 00 B8 44
15	3.657	Send	1	3	01 03 00 00 00 01 84 0A
16	3.690	Receive	1	3	01 03 02 00 00 B8 44

Status Monitoring

For gateways in agent mode, if a slave device fails or a cable comes loose, generally the gateway won't be able to receive up-to-date data from the slave device. The out-of-date data will be stored in the gateway's memory and will be retrieved by the PROFINET IO controller, which will not be aware that the slave device is not providing up-to-date data. The 5103 supports the Status Monitoring function, which provides a warning mechanism to report the list of slave devices that are still active

The MGate can set up to 128 Modbus commands. The MGate 5103 allocates one bit of the gateway's specified memory address to indicate the status of each Modbus command as being normal or abnormal. In other words, the MGate allocates 128 bits of memory to indicate the status of all Modbus commands. If a command has run

successfully, the status value will continue to be 1. On the contrary, if a command has failed, the status will be set to 0. These statuses can be monitored by the PROFINET IO controller, using the way of acyclic read. On how to monitor the status, we take SIMATIC STEP 7 Engineering Software as an example.

Step1: If we have set eight Modbus commands in the MGate 5103.

Modbus Commands							
Index	Name	Slave ID	Function	Address / Quantity	Trigger	Poll Interval	Endian Swap
1	Room1_Voltage1	1	3	Read address 1, Quantity 1	Cyclic	1000	None
2	Room1_Voltage1	2	3	Read address 1, Quantity 1	Cyclic	1000	None
3	Room1_Voltage1	3	3	Read address 1, Quantity 1	Cyclic	1000	None
4	Room1_Voltage1	4	3	Read address 1, Quantity 1	Cyclic	1000	None
5	Room1_Voltage1	5	3	Read address 1, Quantity 1	Cyclic	1000	None
6	Room1_Voltage1	6	3	Read address 1, Quantity 1	Cyclic	1000	None
7	Room1_Voltage1	7	3	Read address 1, Quantity 1	Cyclic	1000	None
8	Room1_Voltage1	8	3	Read address 1, Quantity 1	Cyclic	1000	None

Step2: We want to monitor the command status through STEP 7. In STEP 7 OB1, we use SFB52 to read the status of the Modbus commands as below.

The screenshot shows the SFB52 configuration in the HW Config window. The SFB52 block is connected to M1.0 (EN), M1.0 (REQ), M1.1 (VALID), M1.2 (BUSY), MD10 (STATUS), and DB128 (RECORD). The ID field is set to 30000 and the INDEX to 16. A red arrow points from the ID field to the hardware rack table below.

Slot	Module	Order number	I Address	Q address	Diagnostic Address
0	mgate-dev	6ES7-315-1CG0-0-0			2042*
X1	PN-IO	6ES7-315-1CG0-0-0			2041*
X1 P1	Port 1				2040*
X1 P2	Port 2				2039*
1					
2					

Step3: Create **Variable Table** to monitor "DB128". Then, set **M1.0** as true. It would trigger SFB52 to read the Modbus command status. *DB128.DBB 0* indicates the first to eighth commands status.

If the value is **0xFF**, it means the status of all commands is normal.

If the value is **0x7F**, it means the status of the eighth command is abnormal. Then, you have to resort to troubleshooting.

#	Address	Symbol	Display format	Status value	Modify value
1	M 1.0		BOOL		true
2	DB128.DBB 0		HEX		
3	DB128.DBB 1		HEX		
4	DB128.DBB 2		HEX		
5	DB128.DBB 3		HEX		
6	DB128.DBB 4		HEX		
7	DB128.DBB 5		HEX		
8	DB128.DBB 6		HEX		
9	DB128.DBB 7		HEX		
10	DB128.DBB 8		HEX		
11	DB128.DBB 9		HEX		
12	DB128.DBB 10		HEX		
13	DB128.DBB 11		HEX		
14	DB128.DBB 12		HEX		
15	DB128.DBB 13		HEX		
16	DB128.DBB 14		HEX		
17	DB128.DBB 15		HEX		

Configuration (Text Mode Console)

The MGate 5103 supports a text-mode console with serial interface, telnet, and SSH protocol. The user interface is the same in all text mode consoles. Note that the text mode console does not support all configuration items. Some parameters must be configured through the web console.

You must use a DB9-to-RJ45 cable to connect the serial console port on the MGate gateway's front panel to the serial port on the host. The serial console parameters are 115.2 kbps; parity: none; 8 data bits; and one stop bit.

For telnet and SSH, use HyperTerminal or PuTTY to connect to the MGate. Note that the telnet protocol will transfer the account and password information over the Internet using plain text, so telnet is essentially obsolete and should be replaced by the SSH protocol.

To connect to the MGate telnet/SSH console, load the telnet/SSH program and connect to the MGate IP address.

For the serial interface, use a null modem (crossover) cable to connect the serial port on the host to the serial console port on the MGate's front of panel. The serial console parameters are 115.2kbps, none for parity, 8 data bits, and one stop bit. You can use a terminal program such as PComm Terminal Emulator or PuTTY to connect to the MGate serial console.

On the first page, input the account and password. The account supports two types of users: **admin** and **user**. An "admin" account can modify all of the settings, but a "user" account can only review the settings. A "user" account cannot modify the configuration. The default password for **admin** is **moxa**.

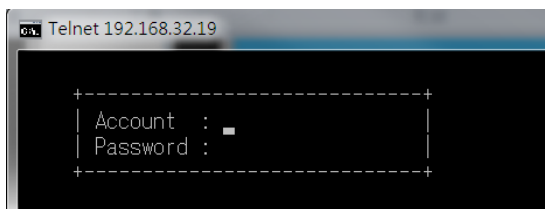

The text mode console will display the menu driven interface. Users can use arrow key to move the menu bar. To select the option, press the "Enter" key to go next level menu. To go previous level menu, press "Esc" key to quit. If necessary, MGate will need to restart to activate the setting.

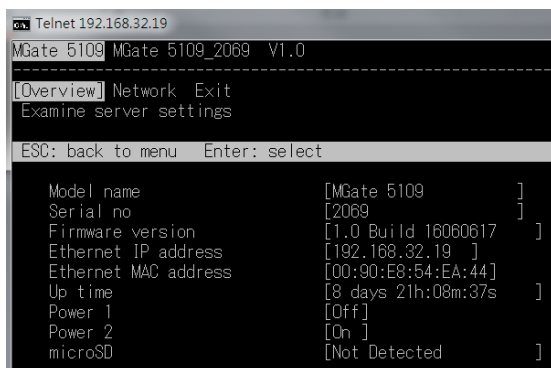

Network Management Tool (MXstudio)

Moxa's MXstudio industrial network management suite includes tools such as MXconfig, MXview and N-Snap. MXconfig is for industrial network configuration; MXview is for industrial management software; and N-Snap is for industrial network snapshot. The MXstudio suite in MGate 5103 includes MXconfig and MXview, which are used for mass configuration of network devices and monitoring network topology, respectively. The following functions are supported:

Tool	Function Support
MXconfig	<ol style="list-style-type: none">1. System name and login password modification2. Network settings3. Configuration import/export4. Firmware upgrade
MXview	<ol style="list-style-type: none">1. Configuration import/export2. LLDP for topology analysis3. Security View**

** Security View can check the security level of devices in accordance with the IEC62443-4-2 standard. MGate 5103 supports Level 2 of the IEC-62443-4-2 standard.

A

SNMP Agents with MIB II and RS-232-Like Groups

The MGate 5103 has built-in Simple Network Management Protocol (SNMP) agent software that supports SNMP Trap, RFC1317 and RS-232-like groups, and RFC 1213 MIB-II.

The following topics are covered in this Appendix:

- **RFC1213 MIB-II Supported SNMP Variables**
- **RFC1317 RS-232-Like Groups**

RFC1213 MIB-II Supported SNMP Variables

System MIB	Interfaces MIB	IP MIB	ICMP MIB
sysDescr	ifNumber	ipForwarding	icmpInMsgs
sysObjectID	ifIndex	ipDefaultTTL	icmpInErrors
sysUpTime	ifDescr	ipInReceives	icmpInDestUnreachs
sysContact	ifType	ipInHdrErrors	icmpInTimeExcds
sysName	ifMtu	ipInAddrErrors	icmpInParmProbs
sysLocation	ifSpeed	ipForwDatagrams	icmpInSrcQuenchs
sysServices	ifPhysAddress	ipInUnknownProtos	icmpInRedirects
	ifAdminStatus	ipInDiscards	icmpInEchos
	ifOperStatus	ipInDelivers	icmpInEchoReps
	ifLastChange	ipOutRequests	icmpInTimestamps
	ifInOctets	ipOutDiscards	icmpTimestampReps
	ifInUcastPkts	ipOutNoRoutes	icmpInAddrMasks
	ifInNUcastPkts	ipReasmTimeout	icmpInAddrMaskReps
	ifInDiscards	ipReasmReqds	icmpOutMsgs
	ifInErrors	ipReasmOKs	icmpOutErrors
	ifInUnknownProtos	ipReasmFails	icmpOutDestUnreachs
	ifOutOctets	ipFragOKs	icmpOutTimeExcds
	ifOutUcastPkts	ipFragFails	icmpOutParmProbs
	ifOutNUcastPkts	ipFragCreates	icmpOutSrcQuenchs
	ifOutDiscards	ipAdEntAddr	icmpOutRedirects
	ifOutErrors	ipAdEntIfIndex	icmpOutEchos
	ifOutQLen	ipAdEntNetMask	icmpOutEchoReps
	ifSpecific	ipAdEntBcastAddr	icmpOutTimestamps
		ipAdEntReasmMaxSize	icmpOutTimestampReps
		ipRouteDest	icmpOutAddrMasks
		ipRouteIfIndex	icmpOutAddrMaskReps
		ipRouteMetric1	
		ipRouteMetric2	
		ipRouteMetric3	
		ipRouteMetric4	
		ipRouteNextHop	
		ipRouteType	
		ipRouteProto	
		ipRouteAge	
		ipRouteMask	
		ipRouteMetric5	
		ipRouteInfo	
		ipNetToMediaIfIndex	
		ipNetToMediaPhysAddress	
		ipNetToMediaNetAddress	
		ipNetToMediaType	
		ipRoutingDiscards	

Address Translation MIB	TCP MIB	UDP MIB	SNMP MIB
atIfIndex	tcpRtoAlgorithm	udpInDatagrams	snmpInPkts
atPhysAddress	tcpRtoMin	udpNoPorts	snmpOutPkts
atNetAddress	tcpRtoMax	udpInErrors	snmpInBadVersions
	tcpMaxConn	udpOutDatagrams	snmpInBadCommunityNames
	tcpActiveOpens	udpLocalAddress	snmpInBadCommunityUses
	tcpPassiveOpens	udpLocalPort	snmpInASNParseErrs
	tcpAttemptFails		snmpInTooBig
	tcpEstabResets		snmpInNoSuchNames
	tcpCurrEstab		snmpInBadValues
	tcpInSegs		snmpInReadOnly
	tcpOutSegs		snmpInGenErrs
	tcpRetransSegs		snmpInTotalReqVars
	tcpConnState		snmpInTotalSetVars
	tcpConnLocalAddress		snmpInGetRequests
	tcpConnLocalPort		snmpInGetNexts
	tcpConnRemAddress		snmpInSetRequests
	tcpConnRemPort		snmpInGetResponses
	tcpInErrs		snmpInTraps
	tcpOutRsts		snmpOutTooBig
			snmpOutNoSuchNames
			snmpOutBadValues
			snmpOutGenErrs
			snmpOutGetRequests
			snmpOutGetNexts
			snmpOutSetRequests
			snmpOutGetResponses
			snmpOutTraps
			snmpEnableAuthenTraps
			snmpSilentDrops
			snmpProxyDrops

RFC1317 RS-232-Like Groups

RS-232 MIB	Async Port MIB
rs232Number	rs232AsyncPortIndex
rs232PortIndex	rs232AsyncPortBits
rs232PortType	rs232AsyncPortStopBits
rs232PortInSigNumber	rs232AsyncPortParity
rs232PortOutSigNumber	
rs232PortInSpeed	
rs232PortOutSpeed	

Input Signal MIB	Output Signal MIB
rs232InSigPortIndex	rs232OutSigPortIndex
rs232InSigName	rs232OutSigName
rs232InSigState	rs232OutSigState