

Moxa Remote Connect Gateway User's Manual

Edition 1.0, December 2017

www.moxa.com/product

MOXA®

© 2017 Moxa Inc. All rights reserved.

Moxa Remote Connect Gateway User's Manual

The software described in this manual is furnished under a license agreement and may be used only in accordance with the terms of that agreement.

Copyright Notice

© 2017 Moxa Inc. All rights reserved.

Trademarks

The MOXA logo is a registered trademark of Moxa Inc.
All other trademarks or registered marks in this manual belong to their respective manufacturers.

Disclaimer

Information in this document is subject to change without notice and does not represent a commitment on the part of Moxa.

Moxa provides this document as is, without warranty of any kind, either expressed or implied, including, but not limited to, its particular purpose. Moxa reserves the right to make improvements and/or changes to this manual, or to the products and/or the programs described in this manual, at any time.

Information provided in this manual is intended to be accurate and reliable. However, Moxa assumes no responsibility for its use, or for any infringements on the rights of third parties that may result from its use.

This product might include unintentional technical or typographical errors. Changes are periodically made to the information herein to correct such errors, and these changes are incorporated into new editions of the publication.

Technical Support Contact Information

www.moxa.com/support

Moxa Americas

Toll-free: 1-888-669-2872
Tel: +1-714-528-6777
Fax: +1-714-528-6778

Moxa Europe

Tel: +49-89-3 70 03 99-0
Fax: +49-89-3 70 03 99-99

Moxa India

Tel: +91-80-4172-9088
Fax: +91-80-4132-1045

Moxa China (Shanghai office)

Toll-free: 800-820-5036
Tel: +86-21-5258-9955
Fax: +86-21-5258-5505

Moxa Asia-Pacific

Tel: +886-2-8919-1230
Fax: +886-2-8919-1231

Table of Contents

1. Introduction	1-1
2. Installation	2-1
3. LED Indicators	3-1
4. Interfaces	4-1
RESET Button.....	4-2
WAN/LAN Ethernet Ports.....	4-2
USB Interface.....	4-3
Digital Input and Digital Output	4-3
5. Management	5-1
6. Activation Wizard	6-1
Activate a Gateway	6-2
Activation Option #1	6-2
Activation Option #2	6-4
Activation Option #3	6-5
7. Gateway	7-1
Activation Status	7-2
Tunnel Control.....	7-2
8. Network	8-1
Scenario Setting	8-2
9. Local Device	9-1
Local Device.....	9-2
10. Service	10-1
Service.....	10-2
11. System	11-1

Introduction

The MRC gateway is a 2-port Ethernet device that creates a connection between Ethernet equipment installed at a remote site and the Moxa Remote Connect Platform. The remote connection normally occurs between a SCADA server and a device that belongs to a service engineer.

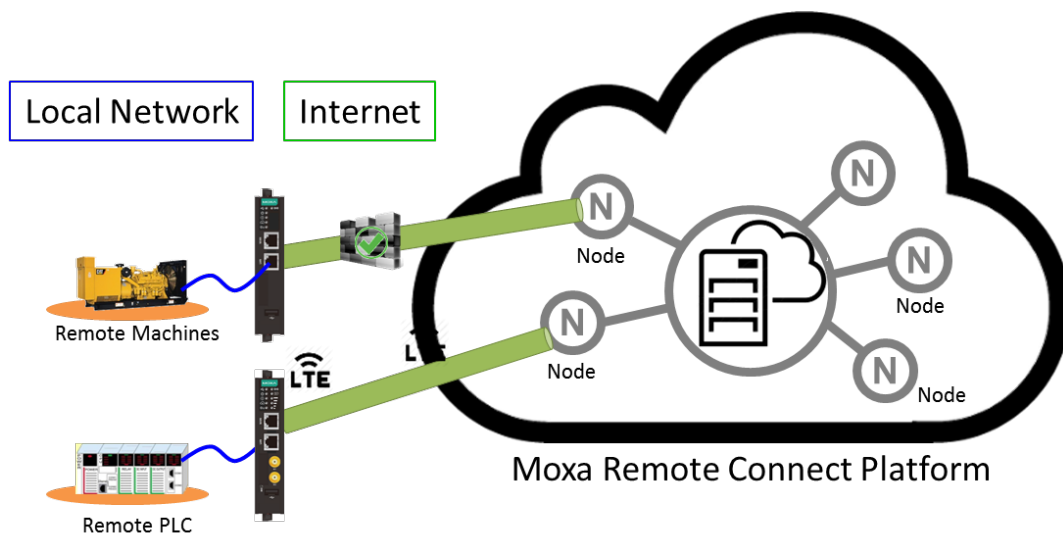

2

Installation

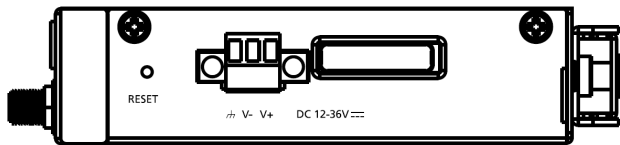

The MRC gateway supports a power input range from 12 to 36 VDC. Please ensure you use the correct power supply to power on the gateway. The MRC gateway also has an embedded DIN-rail mounting kit to allow the device to be mounted on a DIN-rail.

LED Indicators

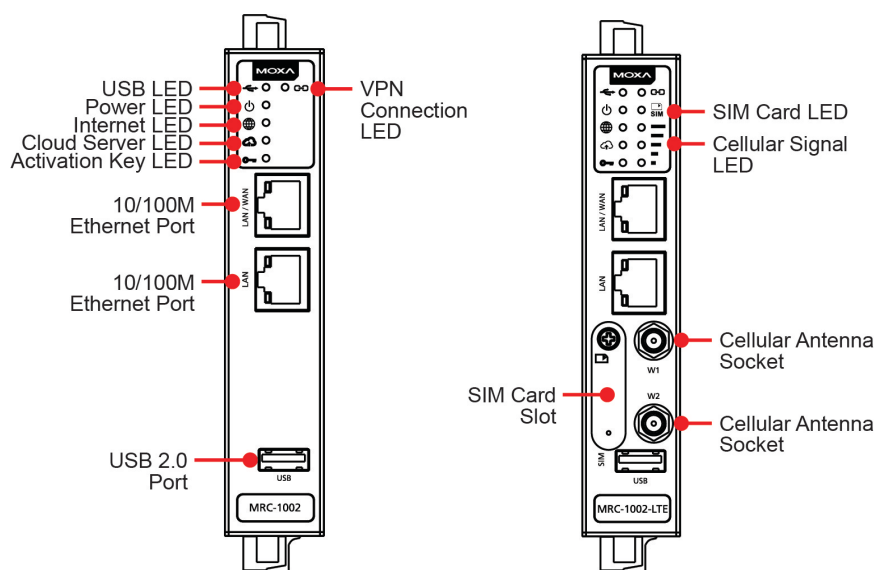

LED Symbol	LED Name	Color	Function
	USB	Green	Steady On: USB device is connected and working Off: USB device is not connected
	Power	Green	Steady On: The gateway is powered on Off: The gateway is powered off
	Internet	Green	Off: WAN interface is not ready (DHCP failure, PPPoE failure, etc.) Blinking: Testing the Internet connection Steady On: Internet is available
	Cloud Server	Green	Off: Not connected to the MRC Server Blinking: Gateway is testing the MRC Server connectivity Steady On: MRC Server is connected
	Activation Key	Green	Off: There is no activation key inside the gateway Blinking: The activation key is invalid Steady On: The activation key is valid and the gateway is activated
	VPN Tunnel	Green	Off: The VPN tunnel is down and remote access is not supported Blinking: The gateway is trying to establish a VPN tunnel Steady On: The gateway has successfully established a VPN tunnel
	SIM Card	Green	Off: No SIM card Blinking: SIM card error Steady On: SIM card is ready
	Cellular Signal	Green	There are three LEDs that display the signal strength of the cellular device. 3 LEDs On: Best signal quality

LED Symbol	LED Name	Color	Function
			2 LEDs On: Normal signal quality 1 LED On: Bad signal quality (may cause no Internet connection) 0 LED On: Very bad signal quality (no Internet connection)
	Ethernet Speed		Ethernet port is connected at 10M speed (amber) or 100M speed (green) speed

4

Interfaces

The following topics are covered in this chapter:

- ❑ **RESET Button**
- ❑ **WAN/LAN Ethernet Ports**
- ❑ **USB Interface**
- ❑ **Digital Input and Digital Output**

RESET Button

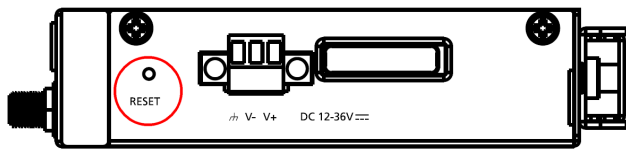

The RESET button can perform three functions depending on how long the button is depressed for.

Operation	LED Behavior	Action
Press and release between 1 to 5 seconds	One LED is blinking (🌐)	Reboot the MRC gateway
Press and release between 6 to 10 seconds	Two LEDs are blinking (🌐 and ☁)	Reset the login account and password to factory default (admin/moxa) Reset to default LAN interface: 192.168.127.254
Press and release between 11 to 15 seconds	Three LEDs are blinking (🌐 , ☁ , and 🔑)	Reset all configurations and remove the activation key. Note: If the RESET button is depressed for longer than 15 seconds, the MRC gateway will reboot without changing any settings.

WAN/LAN Ethernet Ports

There are two Ethernet ports, WAN and LAN, on the MRC gateway. The WAN connects to the network that provides Internet access to the MRC Server and the LAN connects to the field devices that require monitoring or connections. Users can expand the number of LAN connections by adding a switch that provides more Ethernet ports.

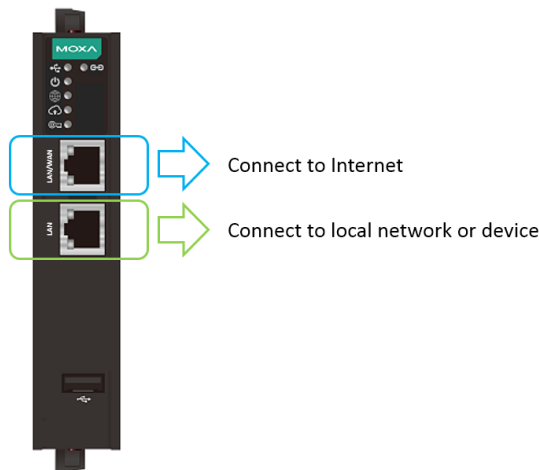

USB Interface

The USB interface supports FAT/FAT32/NTFS-formatted USB dongles for key activation and tunnel connectivity control.

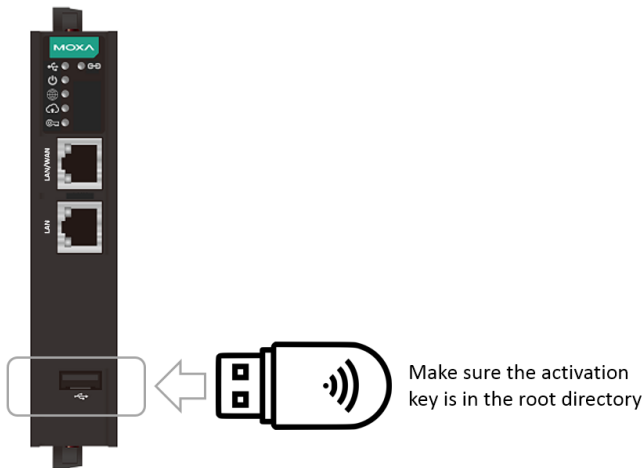

Digital Input and Digital Output

There is one DI and one DO on the bottom of the MRC gateway. The DI is used to control the connection for the tunnel to the MRC Server. The DO can be used as an alarm when the remote access tunnel is active.

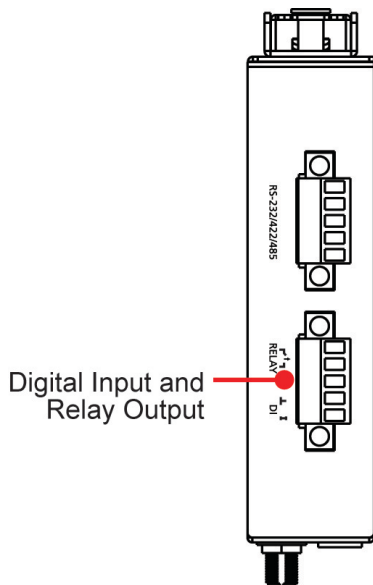

5

Management

The MRC gateway provides a secure web console to perform configurations. After you have connected a laptop to the LAN port, open your browser and type in the default web console address to access the web GUI:
<http://192.168.127.254>

Default username: admin

Default password: moxa

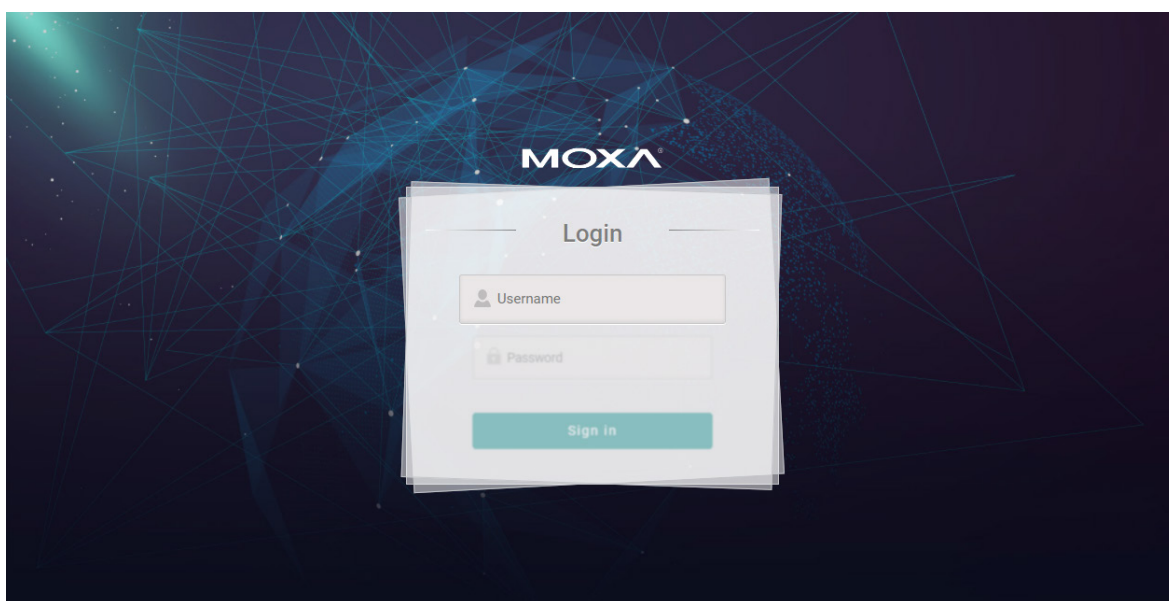

After you successfully login to the web console, you will see the management portal of the MRC gateway.

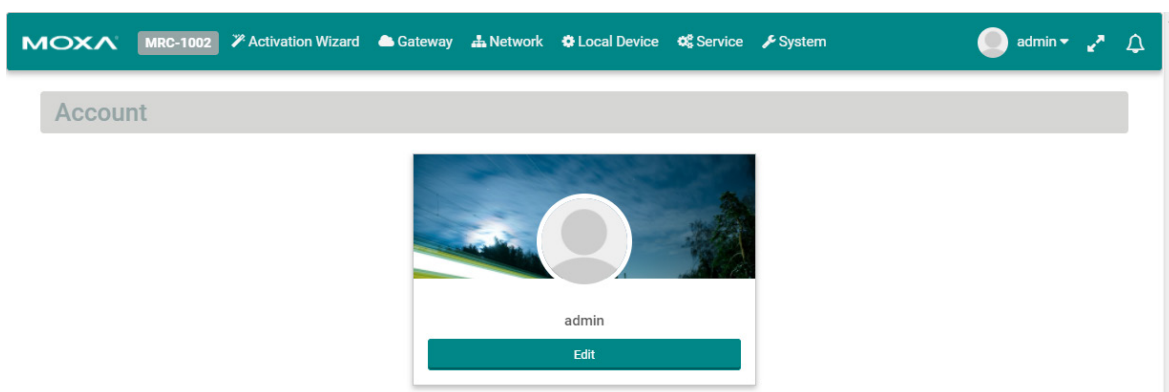

Click "Edit" to change the password.

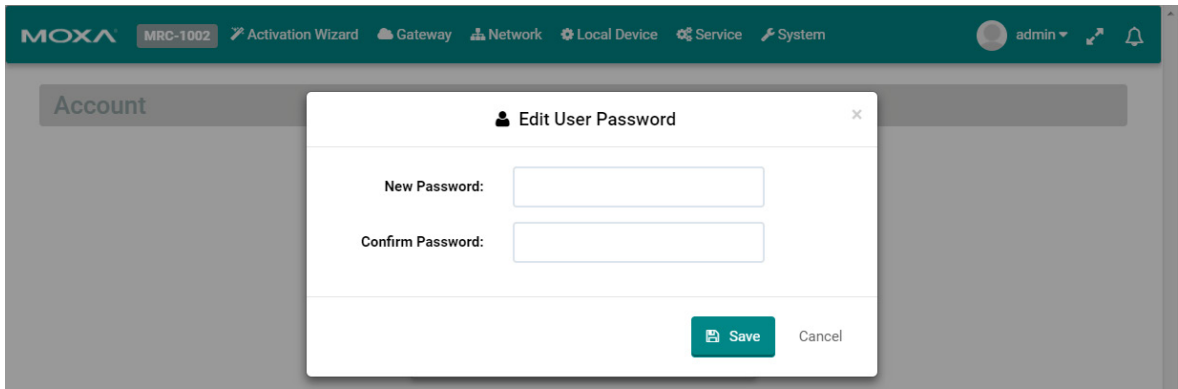

6

Activation Wizard

The following topics are covered in this chapter:

- **Activate a Gateway**
- **Activation Option #1**
- **Activation Option #2**
- **Activation Option #3**

The MRC gateway has a wizard to assist users complete the configuration settings. There are three ways to connect your MRC gateway to the MRC server.

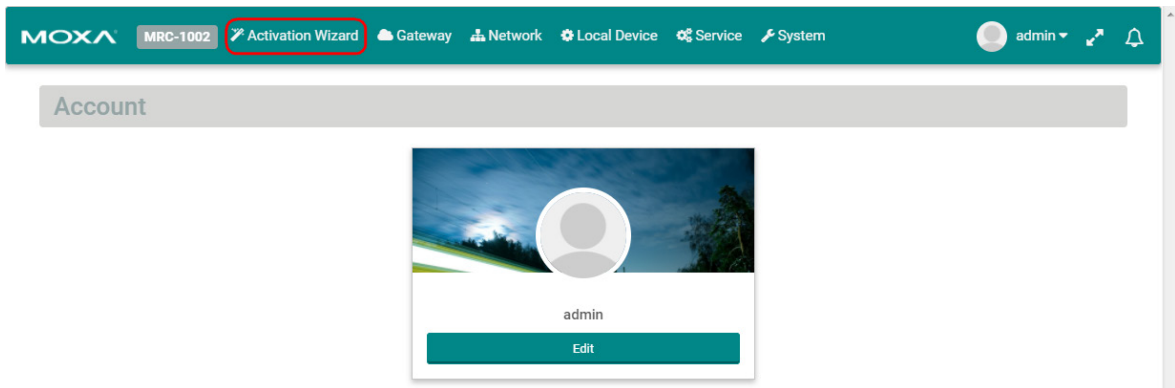

Activate a Gateway

Below are the three options to register the MRC gateway.

Option	Scenario
#1: I have an activation key	You get a string from the MRC server administrator in order to activate your gateway.
#2: I have an activation key in a USB storage device	You get a file from the MRC server administrator in order to activate your gateway.
#3: I do not have an activation key	You get activating information from the MRC server administrator to manually activate your gateway.

Activation Option #1

When choosing option 1, users need to copy the string (activation key) and paste it into the MRC gateway.

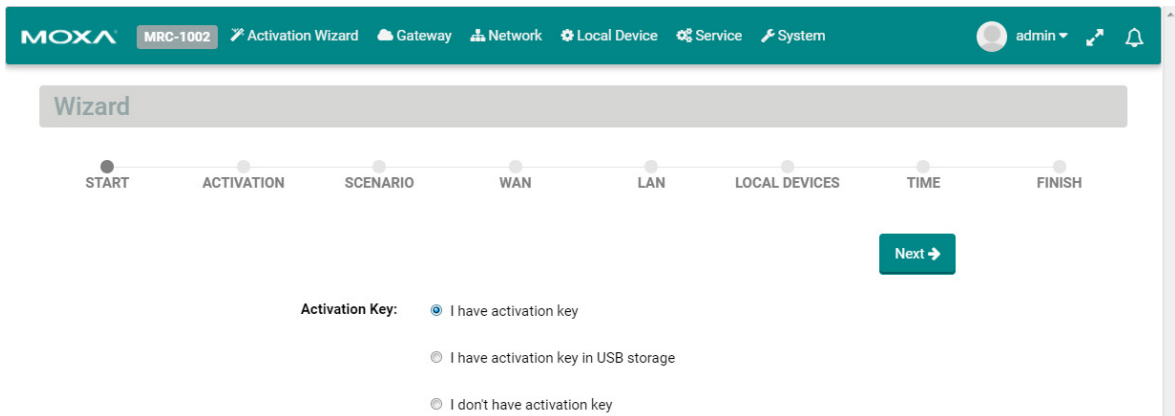

When choosing Option #1, follow the wizard to finish the gateway activation.

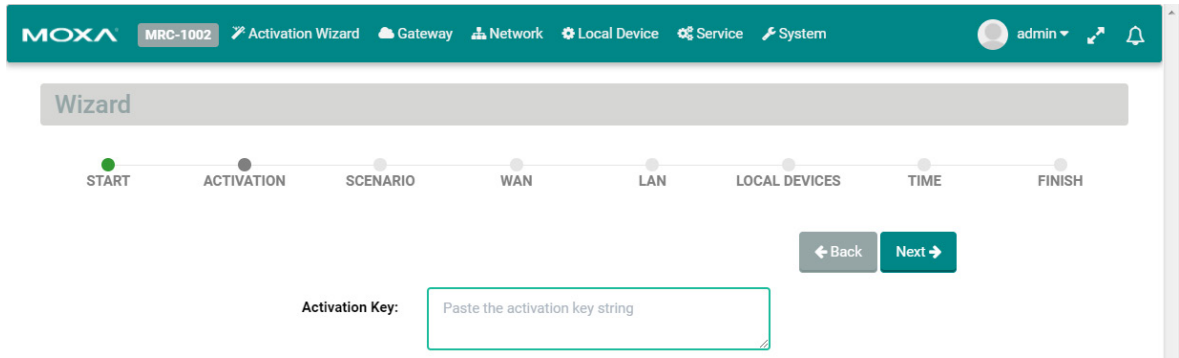

Input the activation key.

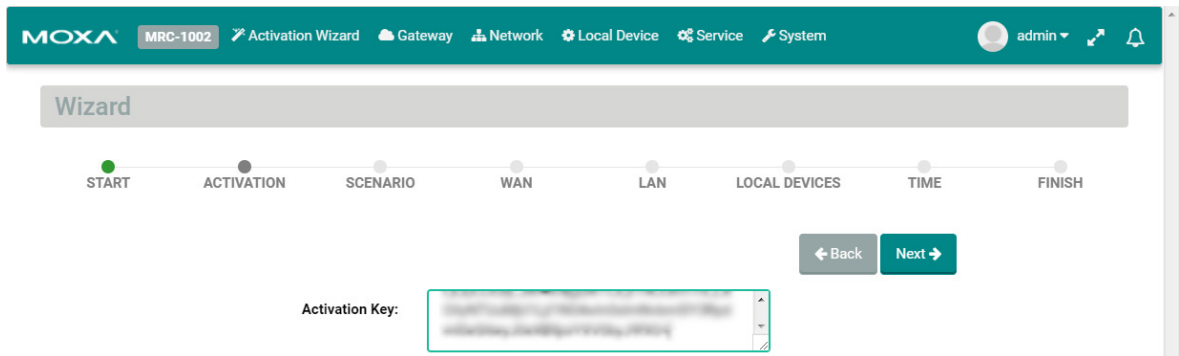

Select the time zone where you will install the gateway.

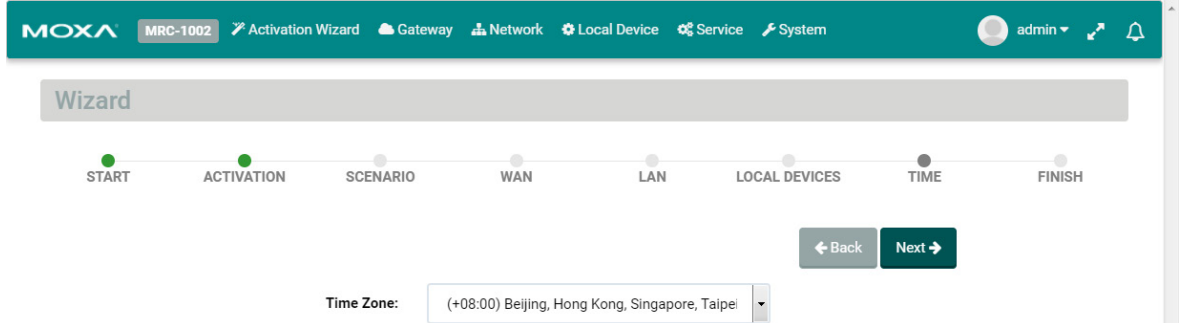

On the last step, please click "Initialize Now" to activate your gateway. (Remember to first connect your gateway to the Internet.)

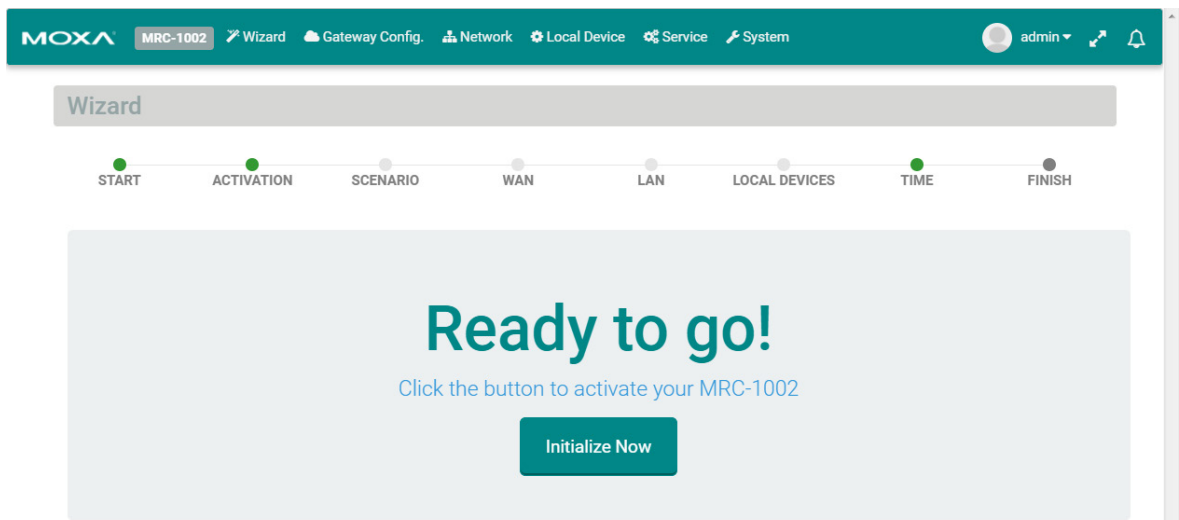

Activation Option #2

When choosing Option #2, the MRC gateway will execute the auto configuration exchange with the MRC server. Users should insert the USB drive that has the activation file stored on it. Then, follow the wizard to finish activating your gateway.

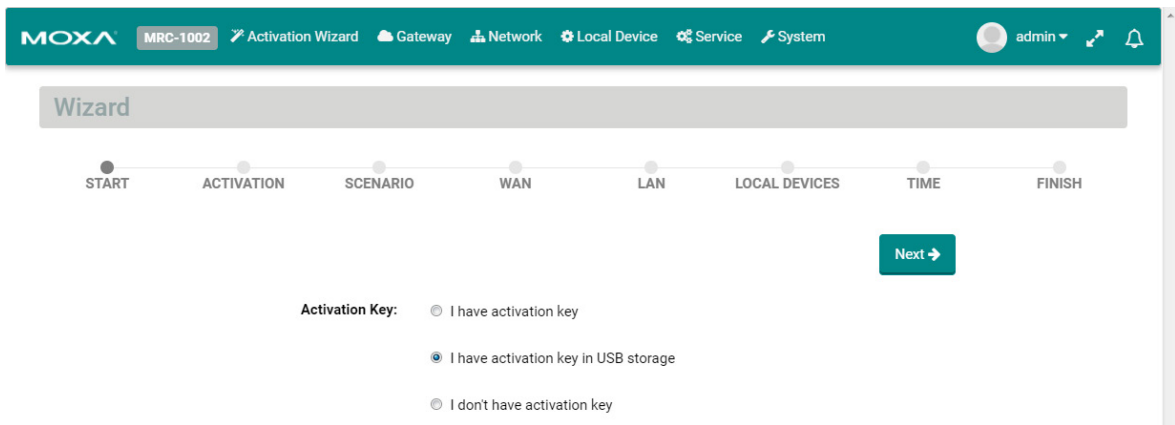

Confirm your USB dongle has the correct activation key installed.

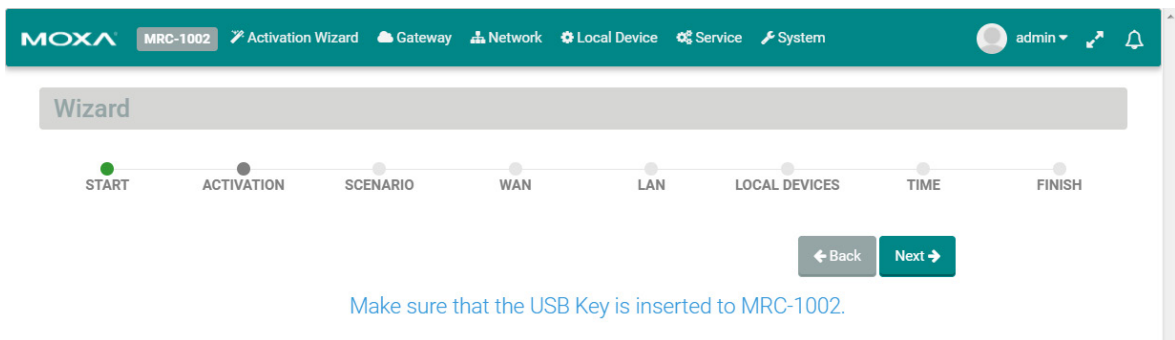

Select the time zone where you will install the gateway.

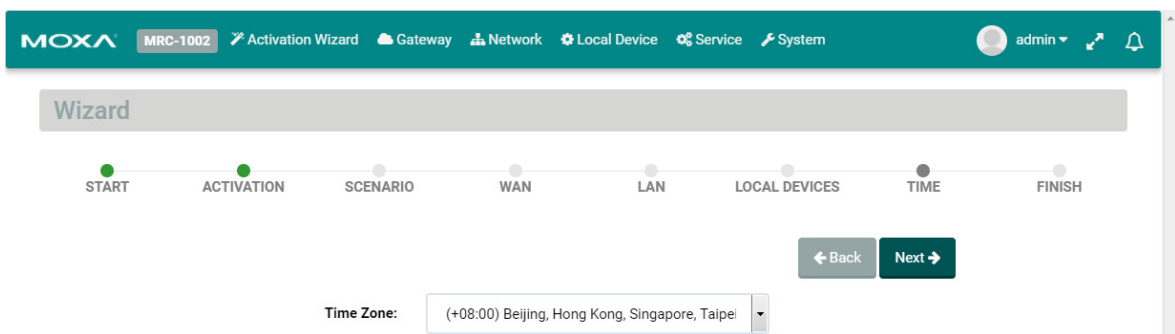

On the last step, please click "Initialize Now" to activate your gateway. (Remember to first connect your gateway to the Internet.)

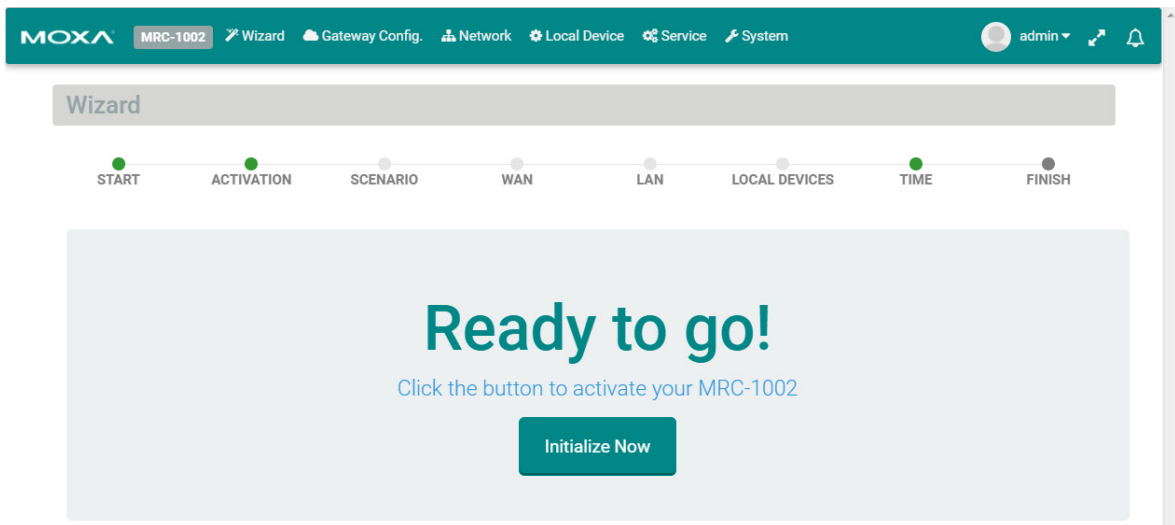

Activation Option #3

When choosing option #3, you need to fill in all the necessary information retrieved **from the MRC Server administrator** step by step.

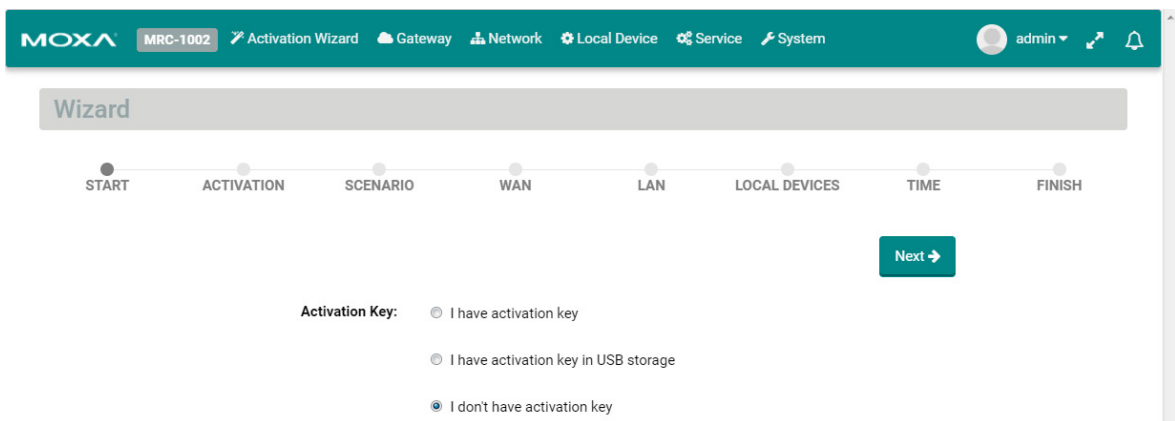

Step 1:

Input the MRC server IP address or domain name, service port, the Group Code, and a user-defined gateway name. The gateway name must be unique in the MRC server. If activation is not successful, it is possible that you registered your gateway with an existing name already stored in the MRC server. If you have any further issues please contact your MRC server administrator.

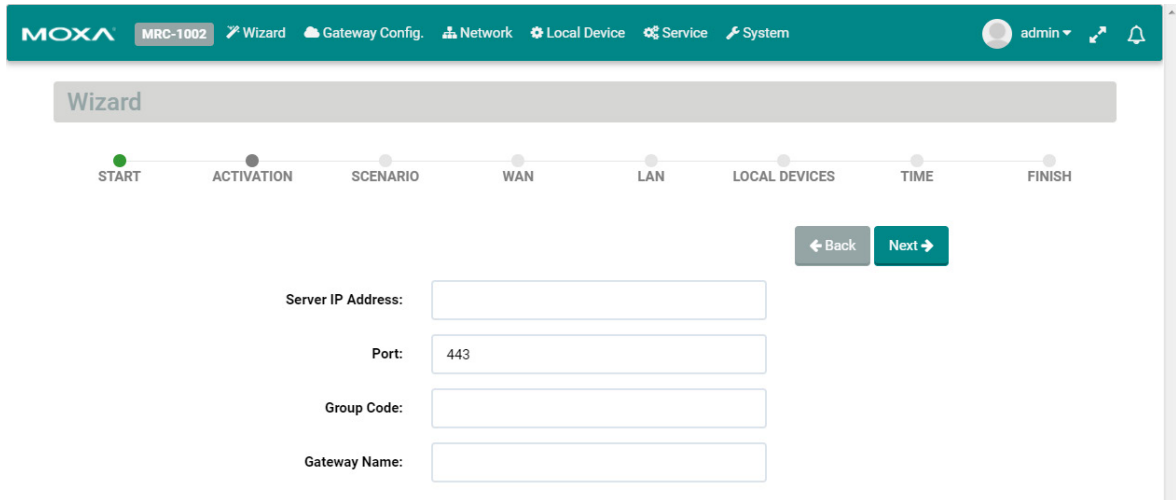

Item	Description
Server IP Address/Port	The IP Address or the host domain name and the service port of the MRC server.
Group Code	The unique code to register the MRC gateway to the device group in the MRC server.
Gateway Name	The unique name of the MRC gateway within the same device group in the MRC Server.

NOTE The Group Code is provided by your MRC Server administrator. If you are the MRC Server administrator, please check "Group Code" in the MRC Server.

Step 2:

Choose the network scenario for your gateway's Internet installation.

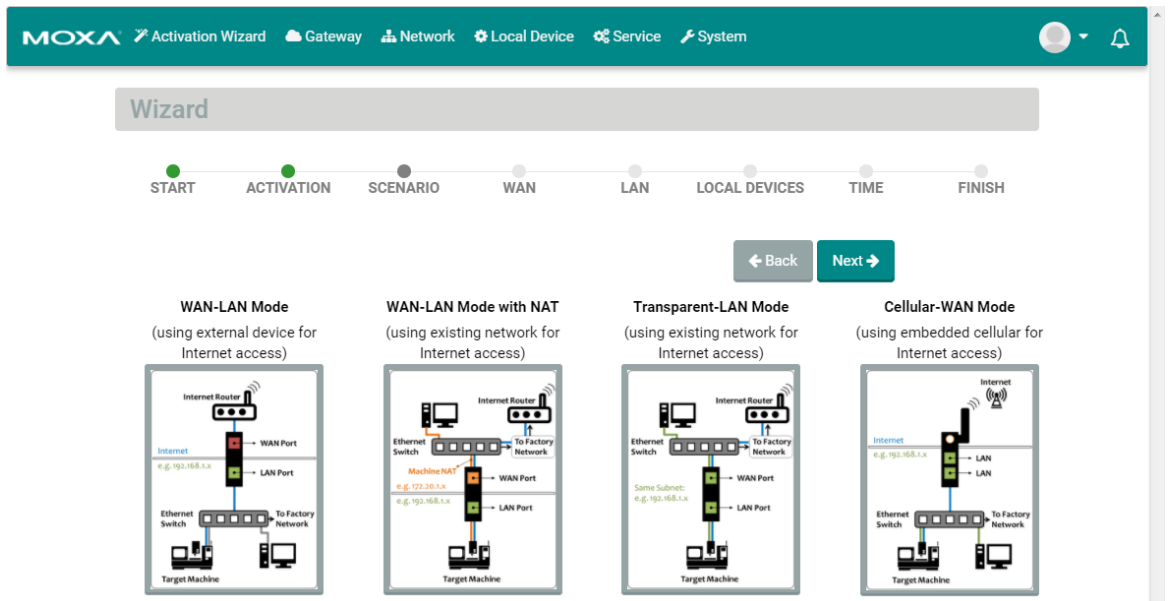

Mode	Scenario
WAN-LAN Mode	Connect an external ADSL modem, cable modem, or Internet WIFI router to establish remote access.
WAN-LAN Mode with NAT	Use the existing factory network to access the Internet in order to establish remote access. Keep the device communicating to the factory network by using NAT.
Transparent-LAN Mode	Use the existing factory network to access the Internet in order to establish remote access. Keep the LAN device communication transparent to the factory network.
Cellular-WAN Mode	Use cellular as Internet access. The two Ethernet ports are both LAN ports that can be used for connecting to local devices.

Step 3:

Select the Internet Access method for your MRC gateway.

WAN-LAN Mode, WAN-LAN Mode with NAT, Transparent-LAN Mode:

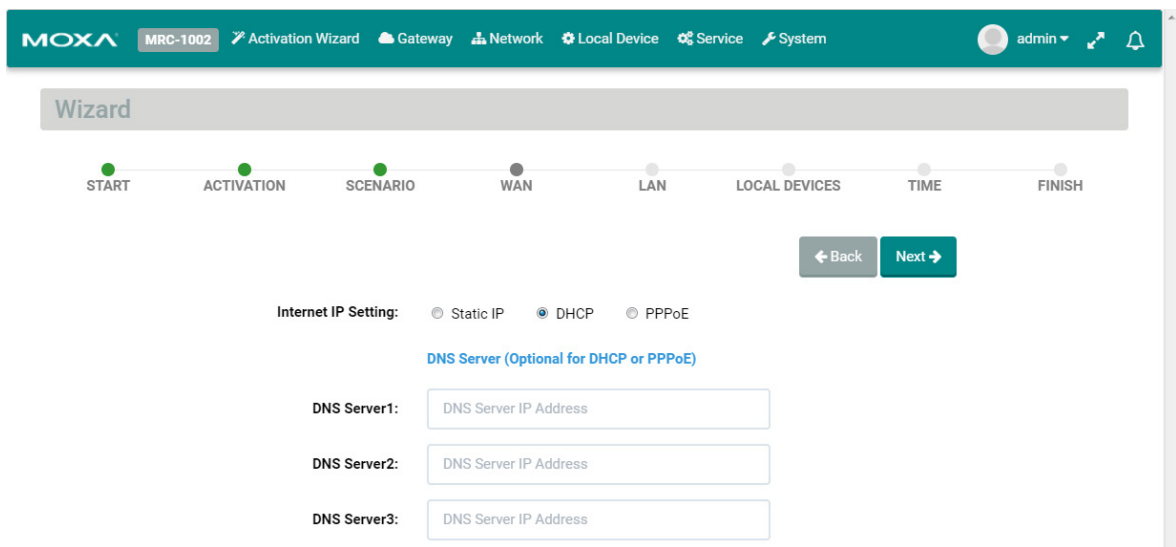

Setting Static IP

Internet IP Setting: Static IP DHCP PPPoE

IP Address:

IP Address

Subnet Mask:

Subnet Mask

Gateway:

IP Address

DNS Server (Optional for DHCP or PPPoE)

DNS Server1:

DNS Server IP Address

DNS Server2:

DNS Server IP Address

DNS Server3:

DNS Server IP Address

Setting DHCP

Internet IP Setting: Static IP DHCP PPPoE

DNS Server (Optional for DHCP or PPPoE)

DNS Server1:

DNS Server IP Address

DNS Server2:

DNS Server IP Address

DNS Server3:

DNS Server IP Address

Setting PPPoE

Internet IP Setting: Static IP DHCP PPPoE

User Name:

Password:

Host Name:

DNS Server (Optional for DHCP or PPPoE)

DNS Server1:

DNS Server2:

DNS Server3:

Cellular-WAN Mode:

The screenshot shows the Moxa MRC-1002 Activation Wizard interface. The top navigation bar includes the Moxa logo, the device model 'MRC-1002', and menu items for 'Activation Wizard', 'Gateway', 'Network', 'Local Device', 'Service', and 'System'. The user is logged in as 'admin'. The wizard progress bar shows steps: START, ACTIVATION, SCENARIO, WAN, LAN, LOCAL DEVICES, TIME, and FINISH. The 'WAN' step is currently active. Below the progress bar are 'Back' and 'Next' buttons. The main configuration area is titled 'Internet IP Setting:' and has a radio button selected for 'Cellular'. It includes the following fields: 'Carrier:' (a dropdown menu showing 'AT&T'), 'APN:', 'PIN:', 'Username:', and 'Password:'. There are also two toggle switches: 'Cellular Keep Alive:' (set to 'On') and 'Cellular Watchdog:' (set to 'Off'). Below these are three optional fields for 'DNS Server1:', 'DNS Server2:', and 'DNS Server3:', each with a placeholder 'DNS Server IP Address'. A 'BACK' button with an upward arrow is located on the left side of the form.

NOTE To ensure the stability of cellular connection, please enable "Cellular Keep Alive" and "Cellular Watchdog"

- 1) "Cellular Keep Alive" keeps checking the cellular availability and once it fails, the MRC gateway will try to reconnect to the cellular base station.
- 2) "Cellular Watchdog" keeps monitoring the internal cellular module status and once the module is abnormal, the MRC gateway will reset the module.

Step 4:

Input the LAN settings and the management IP for your MRC gateway. The MRC gateway's management IP and subnet must be the same as the network where your local devices are located.

The screenshot shows the Moxa MRC-1002 Activation Wizard interface at the 'LAN' step. The top navigation bar is the same as in the previous screenshot. The wizard progress bar shows 'LAN' as the active step. Below the progress bar are 'Back' and 'Next' buttons. The main configuration area has two input fields: 'Management IP Address:' with the value '192.168.127.254' and 'Subnet Mask:' with the value '255.255.255.0'.

Step 5:

Configure your local devices for remote access. Click "+" to add a local device.

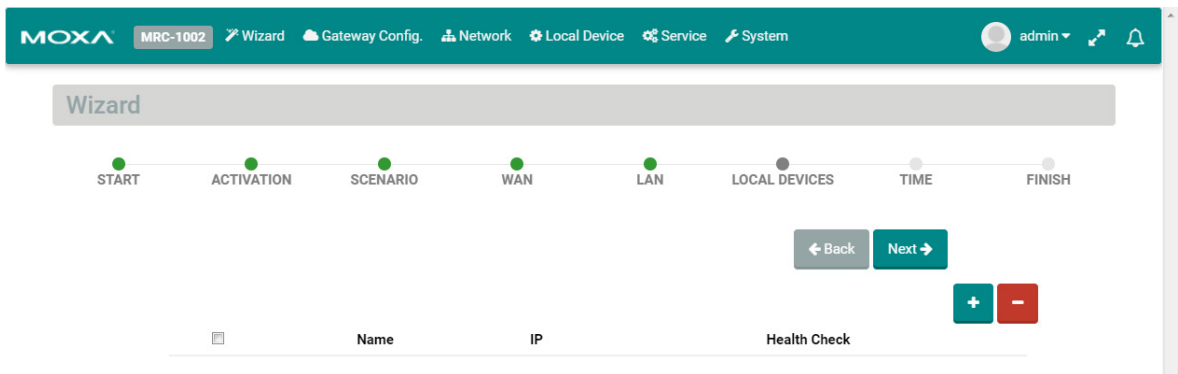

Input the name of a local device and its IP address. Select "Ping Check" or "Port Link" for the MRC gateway to check the health status of your device by PING or Port Link On/Off events. You can disable the Health Check function if you want.

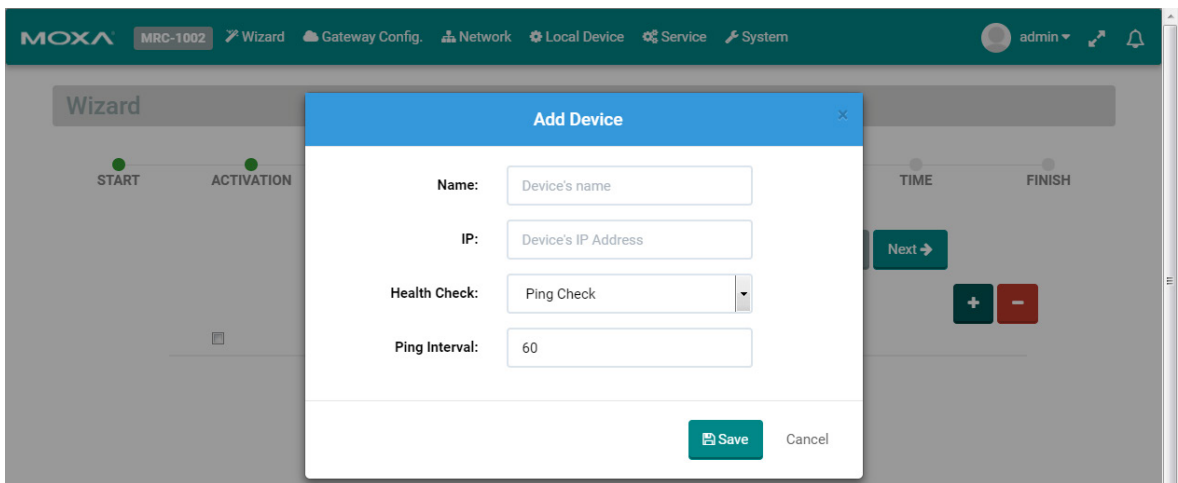

Users can configure a maximum of 25 local devices for remote access through the MRC Suite.

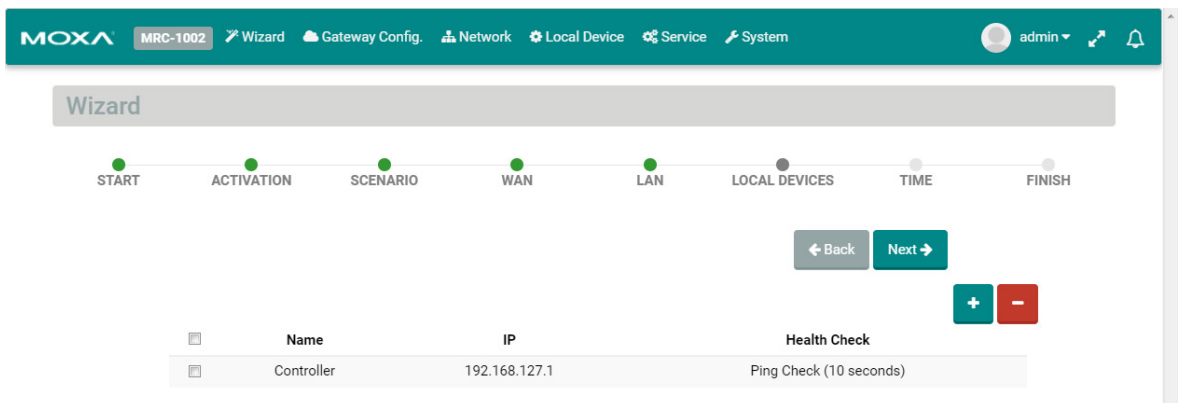

Step 6:

Select the time zone where you will install the gateway.

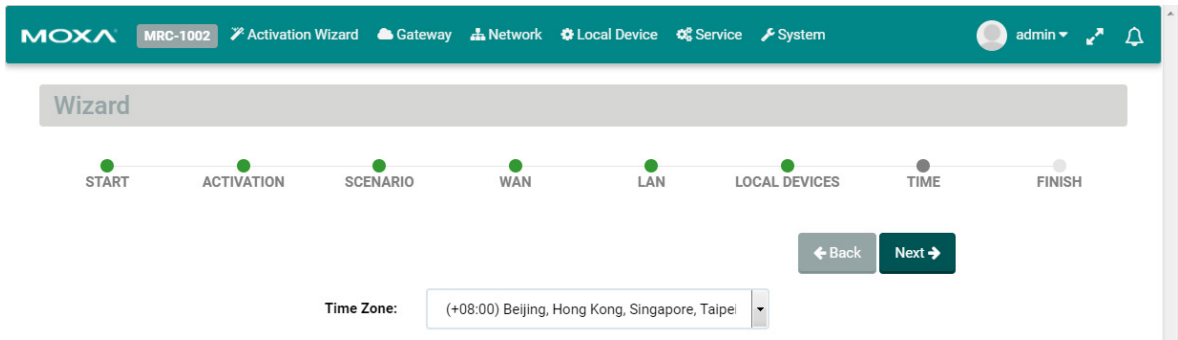

On the last step, please click "Initialize Now" to activate your gateway. (Remember to first connect your gateway to the Internet.)

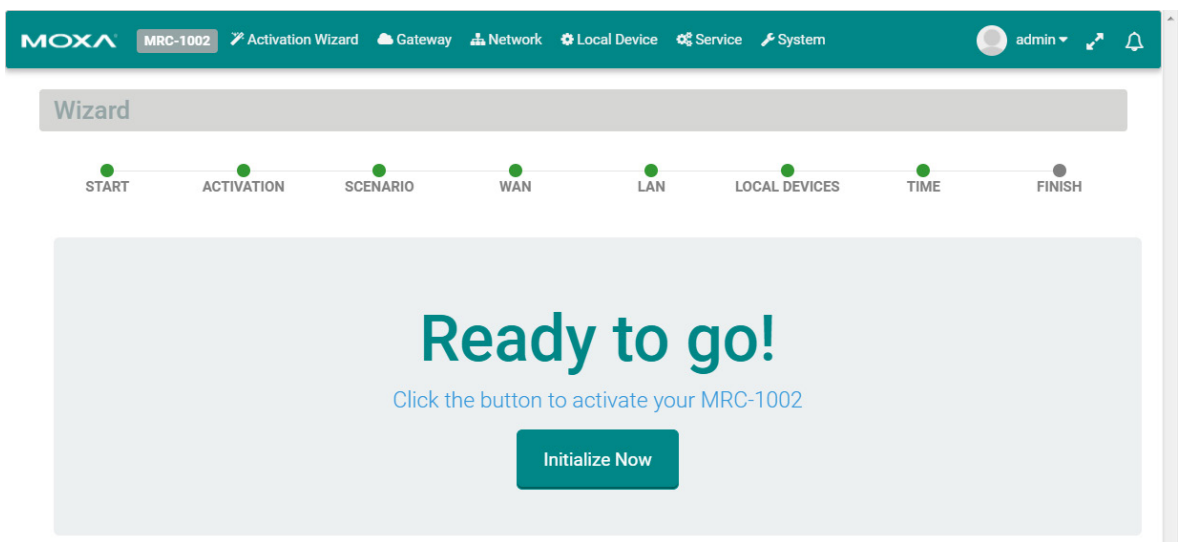

7

Gateway

The following topics are covered in this chapter:

- ❑ **Activation Status**
- ❑ **Tunnel Control**

Activation Status

On the "Gateway" settings page, you can check the activation status of your MRC gateway. You can also configure the remote access capability of your MRC gateway.

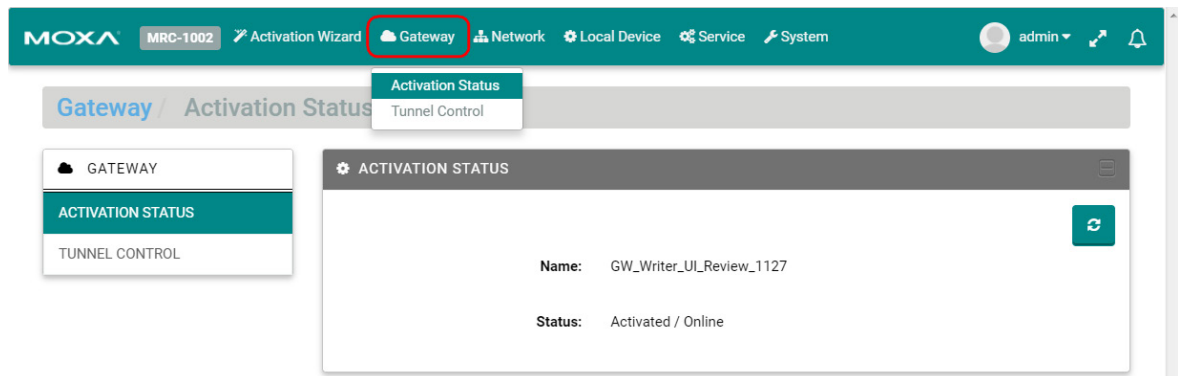

Tunnel Control

Users can configure the method for how the MRC gateway establishes a tunnel for remote access.

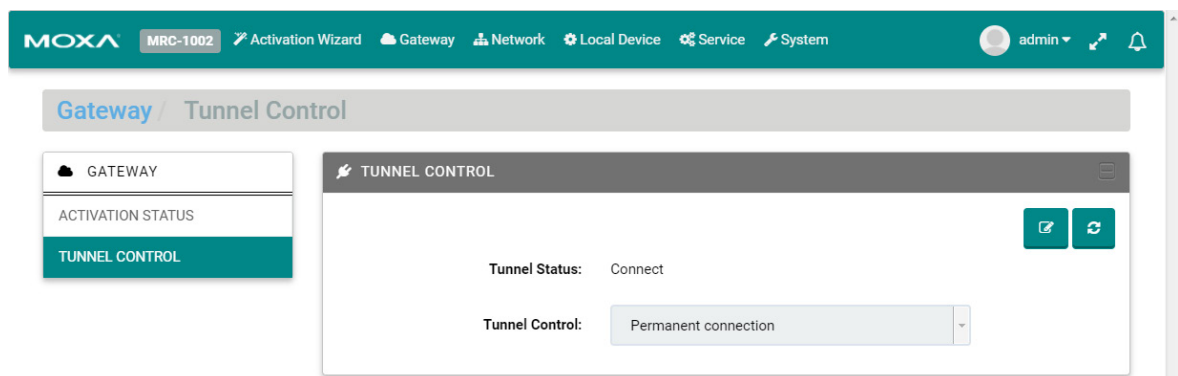

Click on "ⓘ" to change the tunnel control settings. There are three tunnel control options:

Option	Description
Permanent Connection	The MRC gateway automatically establishes the tunnel for remote access whenever a connection to the Internet is available.
Controlled by USB key	The MRC gateway initializes the tunnel for remote access only when a USB dongle (loaded with the gateway's activation key) is inserted into the gateway.
Controlled by DI ON	The MRC gateway initializes the tunnel for remote access only when a DI (digital input) has been detected.

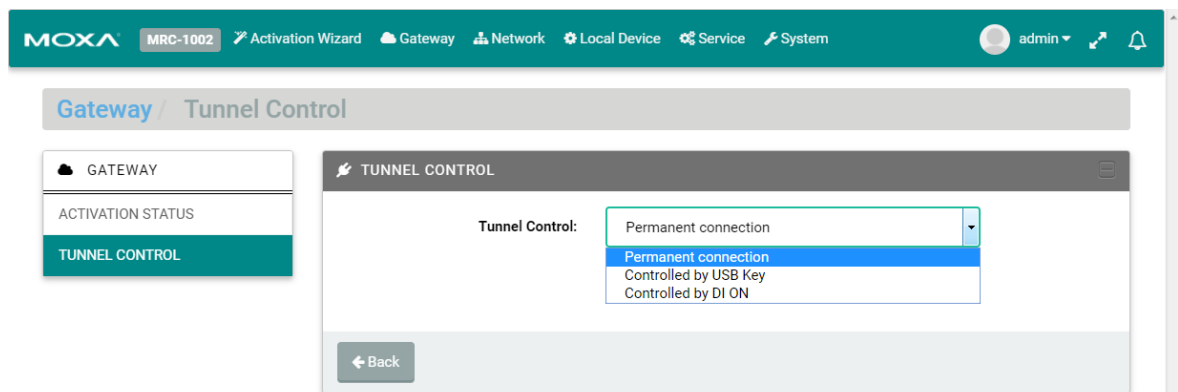

8

Network

The following topic is covered in this chapter:

- **Scenario Setting**

Users can change the network scenario settings and check the WAN/LAN status from the Network settings page.

Scenario Setting

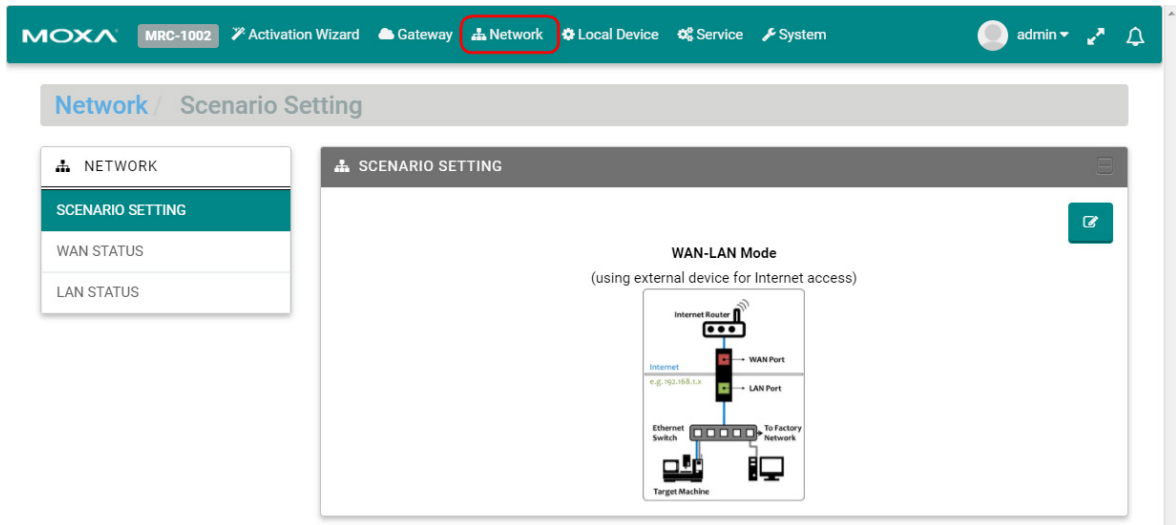

Click “” to change the tunnel control settings and click “Next” to continue inputting settings.

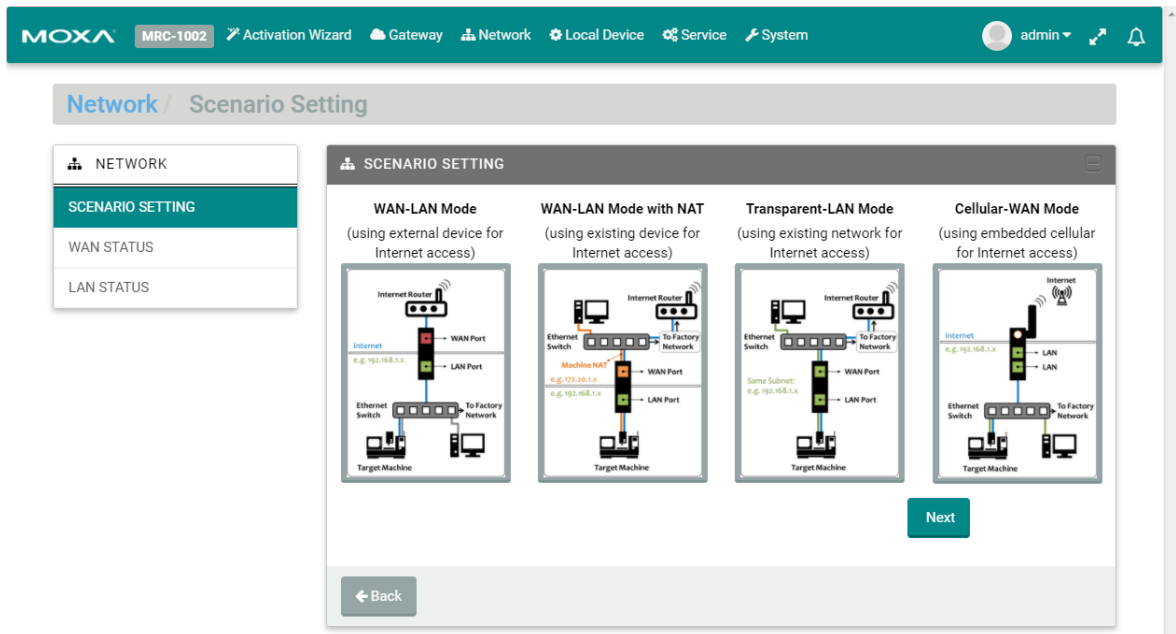

Mode	Scenario
WAN-LAN Mode	Connect an external ADSL modem, cable modem, or Internet WIFI router to establish remote access.
WAN-LAN Mode with NAT	Use the existing factory network to access the Internet in order to establish remote access. Keep the device communicating to the factory network by using NAT.
Transparent-LAN Mode	Use the existing factory network to access the Internet in order to establish remote access. Keep the LAN device communication transparent to the factory network.
Cellular-WAN Mode	Use cellular as Internet access. The two Ethernet ports are both LAN ports that can be used for connecting to local devices.

WAN-LAN Mode:

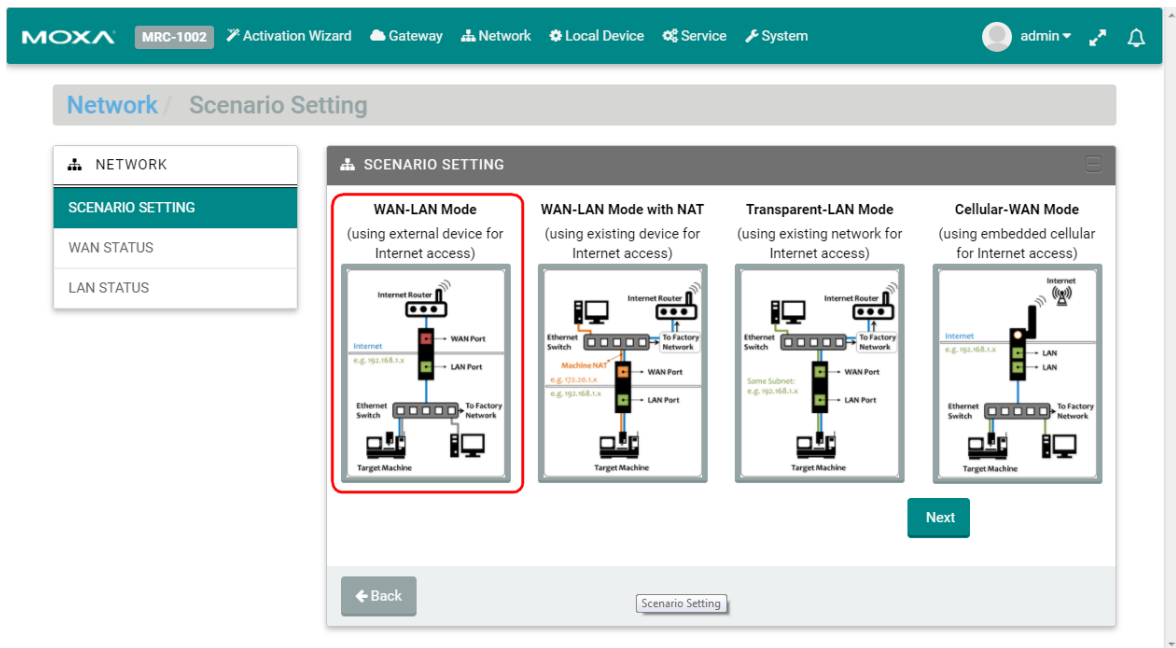

Step 1: Setup Internet access

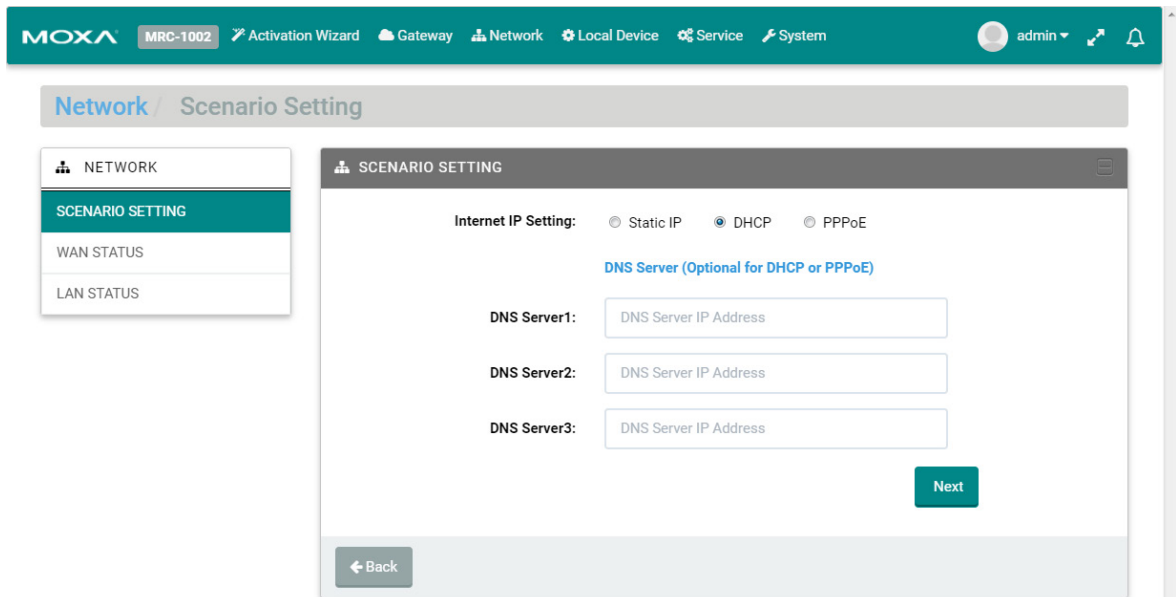

Setting Static IP

Internet IP Setting: Static IP DHCP PPPoE

IP Address:

Subnet Mask:

Gateway:

DNS Server (Optional for DHCP or PPPoE)

DNS Server1:

DNS Server2:

DNS Server3:

Setting DHCP

Internet IP Setting: Static IP DHCP PPPoE

DNS Server (Optional for DHCP or PPPoE)

DNS Server1:

DNS Server2:

DNS Server3:

Setting PPPoE

Internet IP Setting: Static IP DHCP PPPoE

User Name:

Password:

Host Name:

DNS Server (Optional for DHCP or PPPoE)

DNS Server1:

DNS Server2:

DNS Server3:

Step 2: Setup the management IP address for LAN (must be the same subnet as the local network devices).

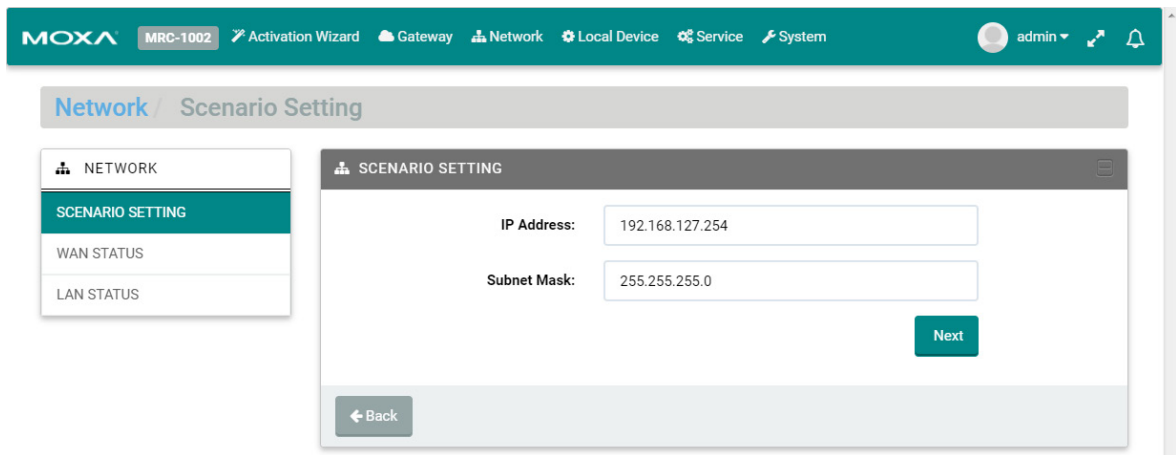

Click "Next" and wait for the configurations to change.

WAN-LAN Mode with NAT:

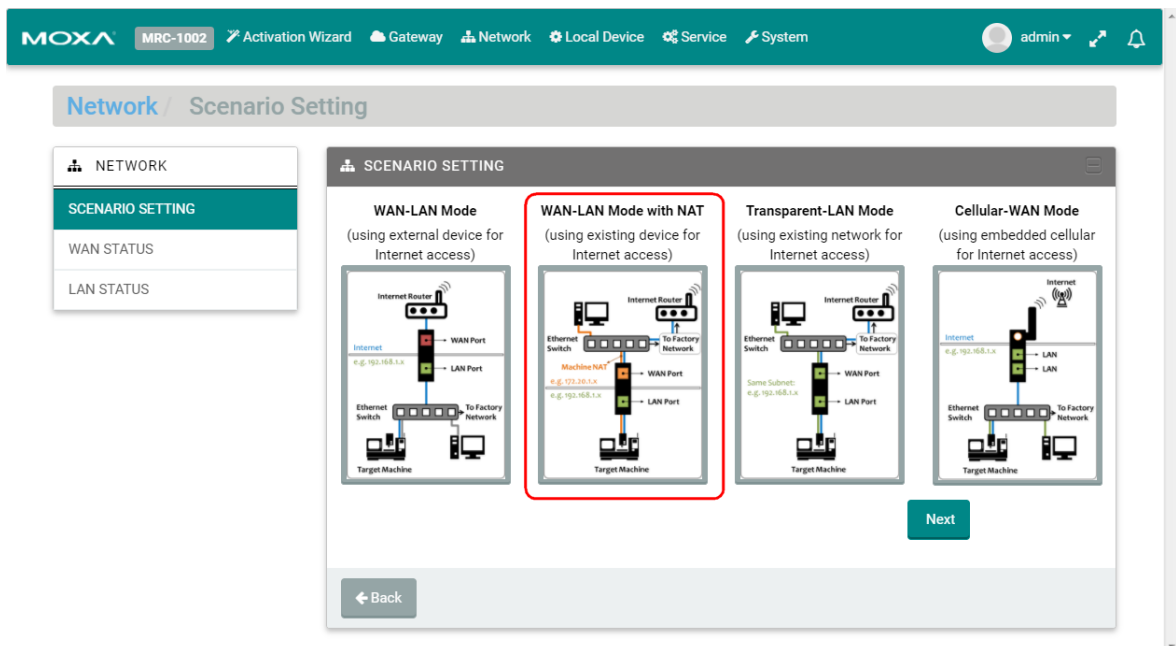

Step 1: Setup Internet access.

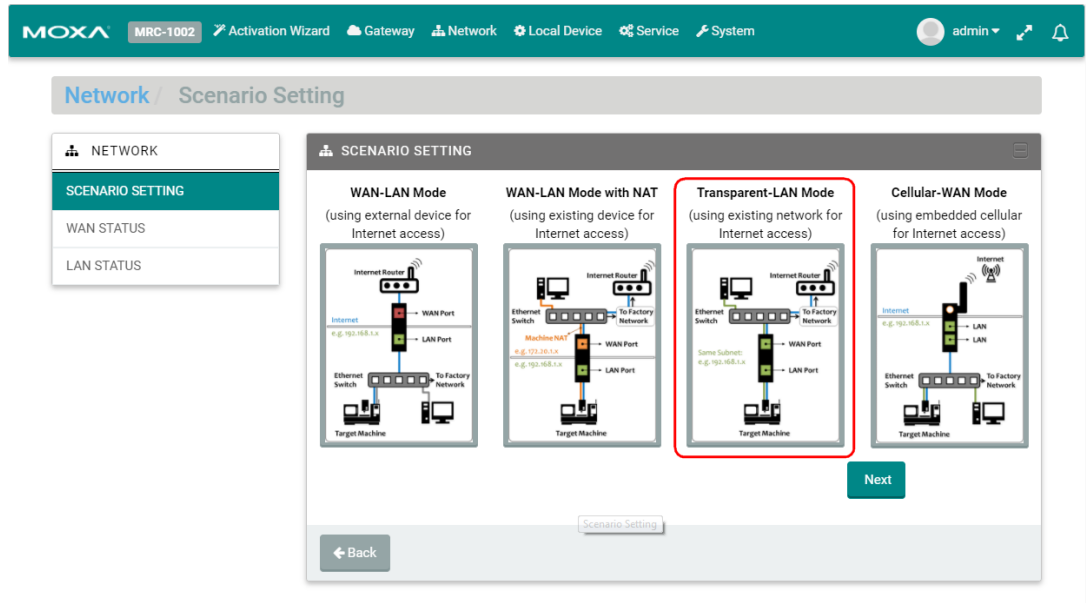

Step 2: Setup management IP address for LAN (must be the same subnet as local network devices).

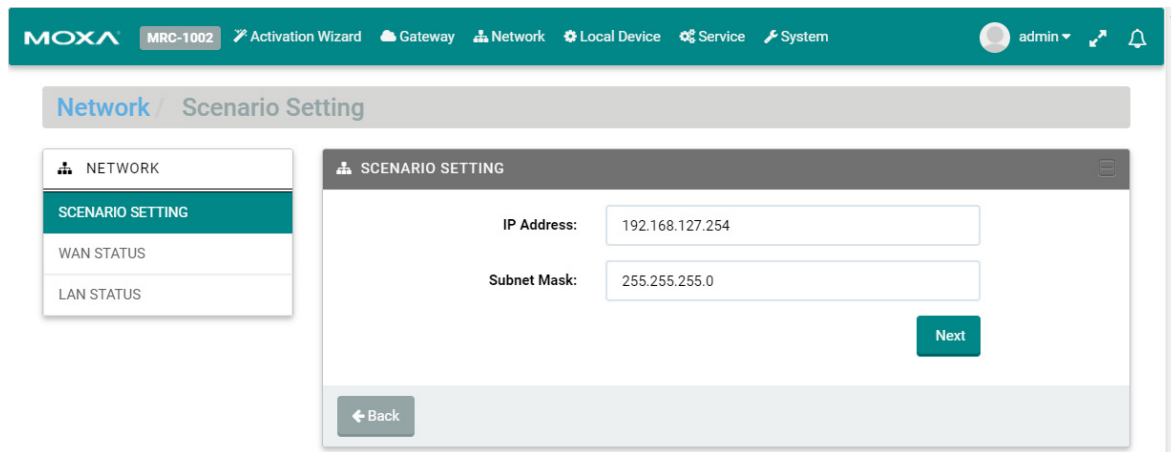

Click "Next" and wait for the configurations to change.

Transparent-LAN Mode:

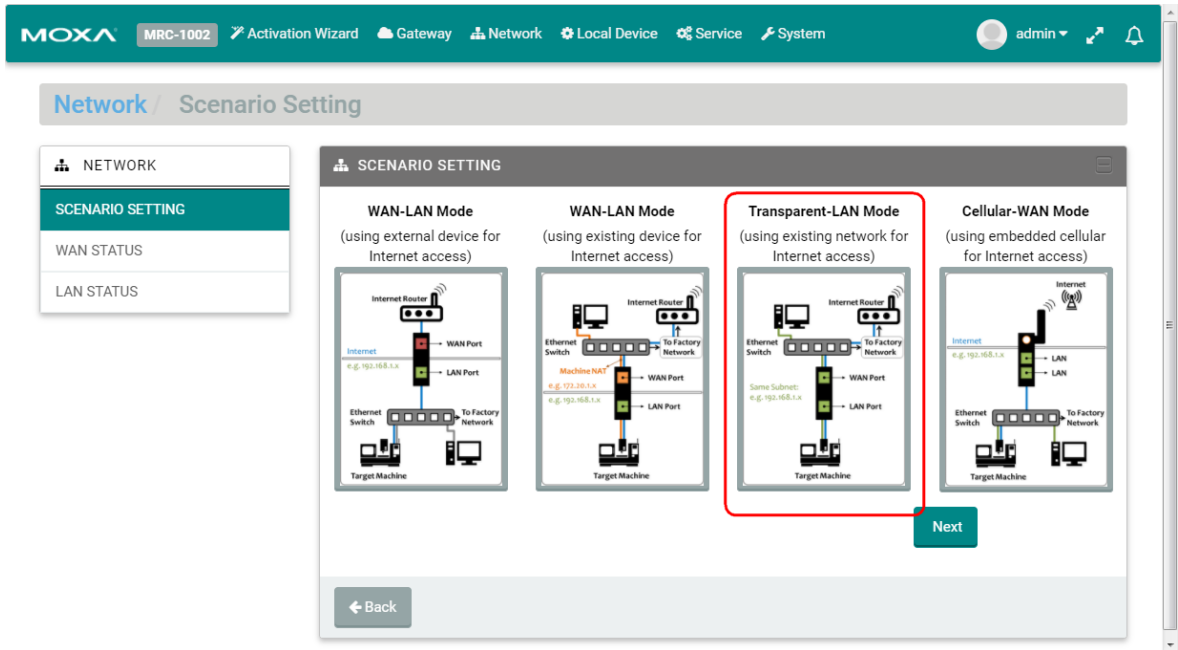

Step 1: Setup the unified interface for Internet access and LAN management IP address (must be the same as local devices' subnet).

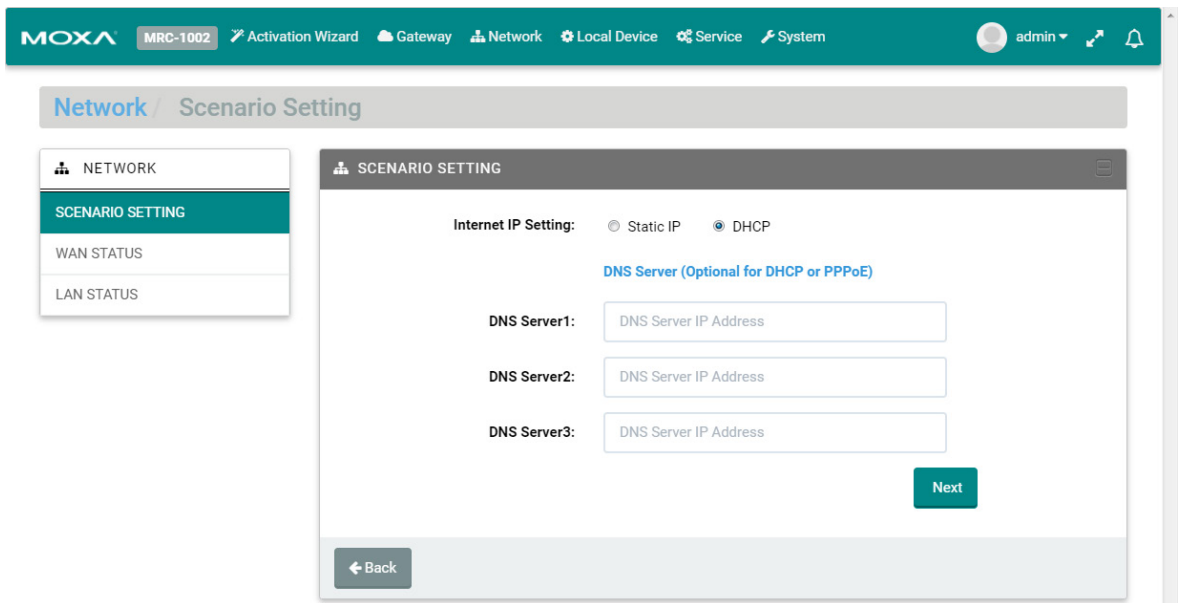

Click "Next" and wait for the configurations to change.

Cellular-WAN Mode:

In this mode, the two Ethernet ports are operating as two LAN ports and your MRC gateway will use cellular to access the Internet.

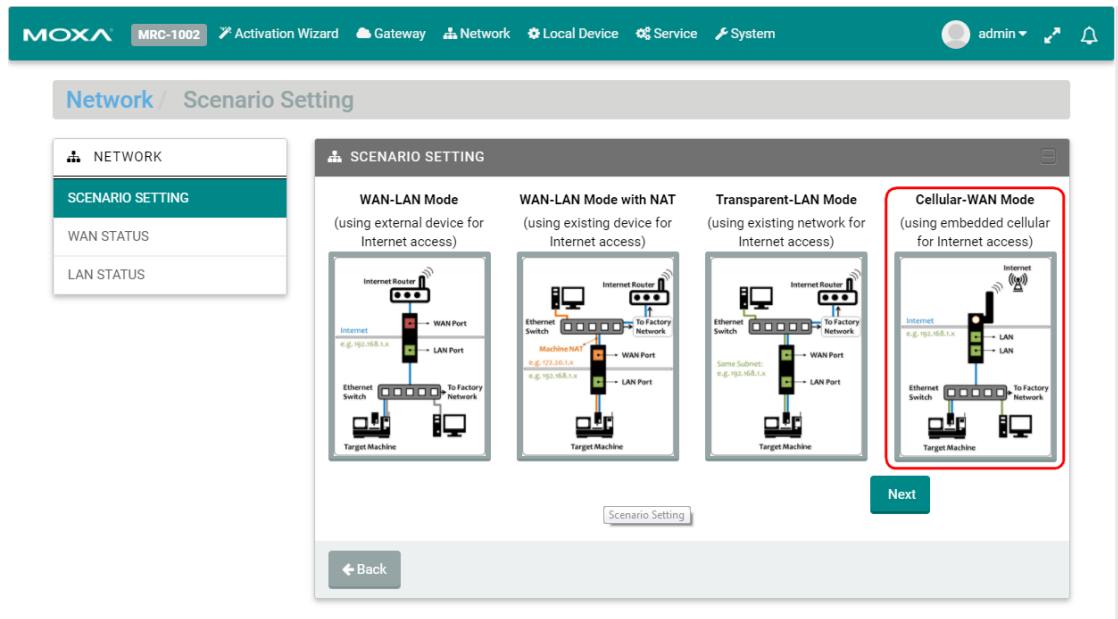

Step 1: Setup cellular for Internet access. There are two pre-defined carriers in the system, "AT&T" and "Verizon". If your cellular provider is not in the list, please choose "Generic".

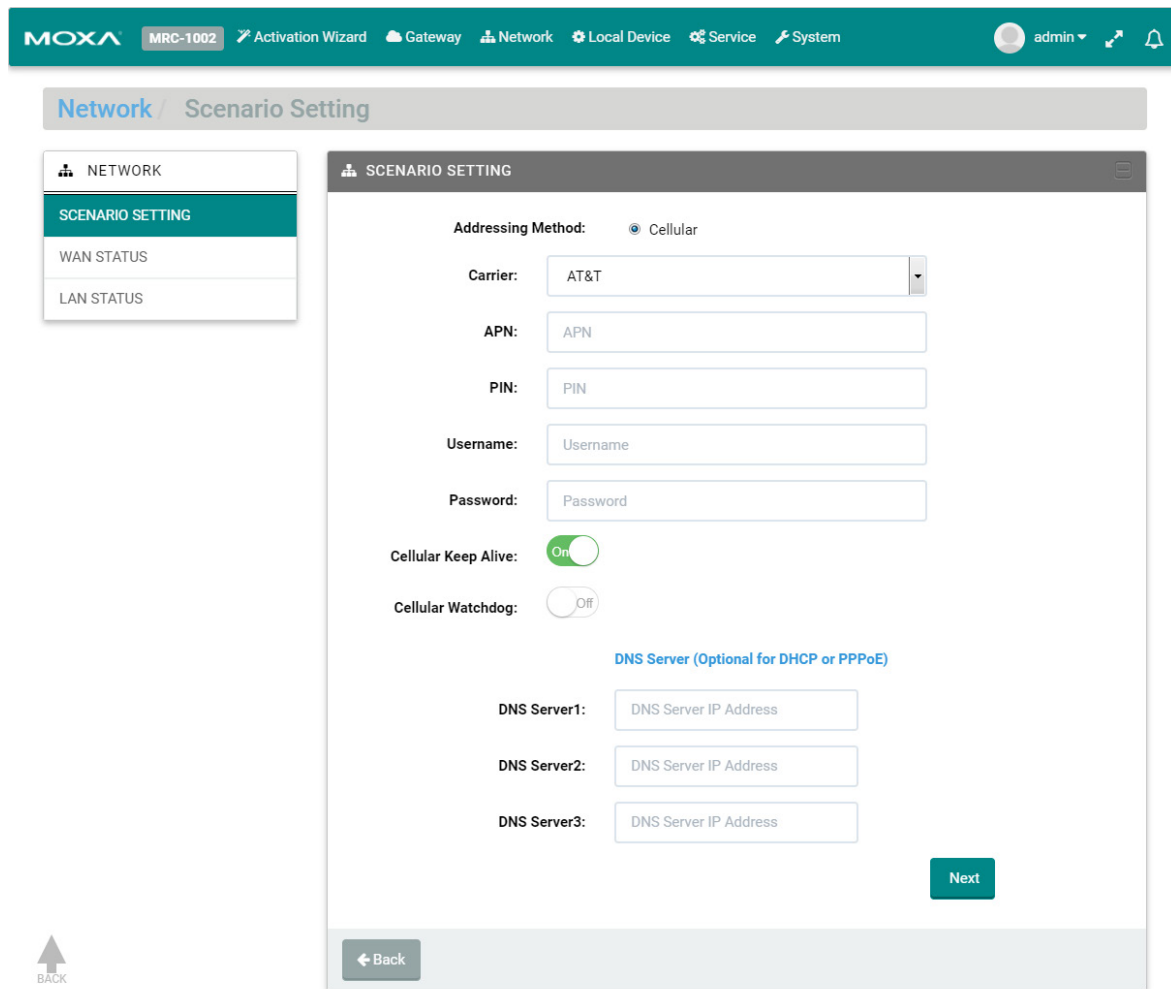

APN: Input the APN Access Point Name. (Provided by your carrier.)

PIN: Input the PIN code to unlock your SIM card. (Provided by your carrier)

Username/Password: Input username and password for Internet access. (Provided by your carrier)

Cellular Keep Alive: When the cellular drops Internet access, the MRC gateway will restart the cellular connection to the carrier.

Cellular Watchdog: When the cellular system stops working, the MRC gateway will restart the cellular hardware to re-initialize the connection.

Step 2: Setup management IP address for LAN (must be the same subnet as local network devices).

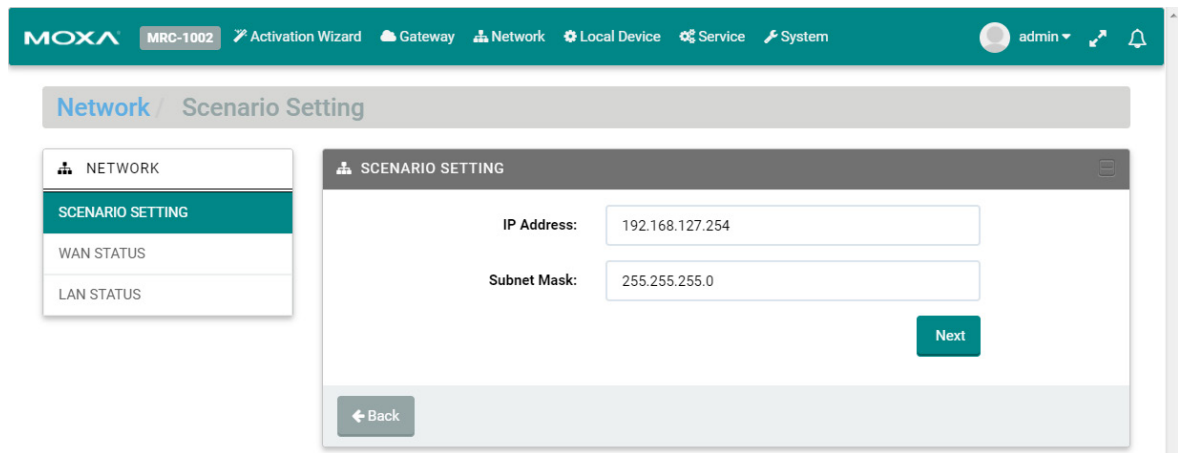

Click "Next" and wait for the configurations to change.

9

Local Device

The following topic is covered in this chapter:

- **Local Device**

Local Device

Users can locally add or remove Ethernet devices that are available for remote access. After modifying the local device list, the MRC gateway will automatically push the configuration back to the MRC server.

NOTE The MRC gateway must have the capability to access the Internet when performing this configuration.

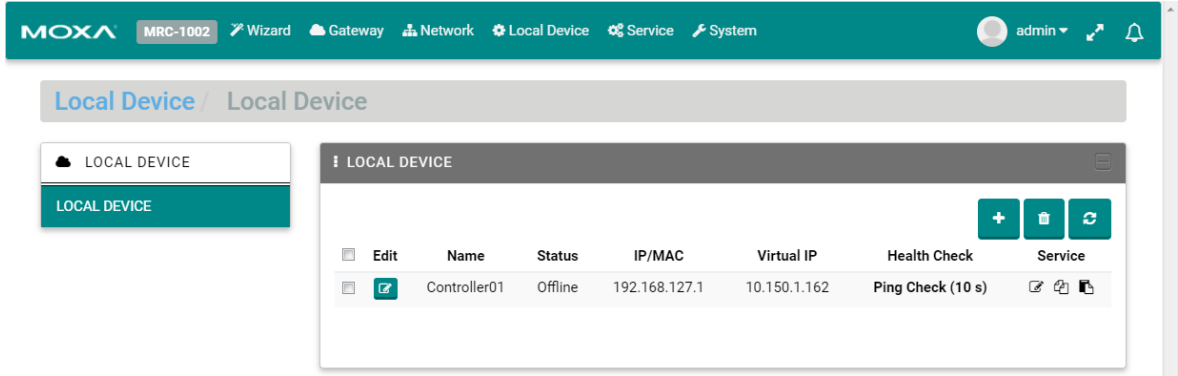

Click "+" to add more devices; click "-" to remove the selected device. After adding a new device and pressing the "Refresh" button, the configurations will automatically update to the configurations on the MRC server.

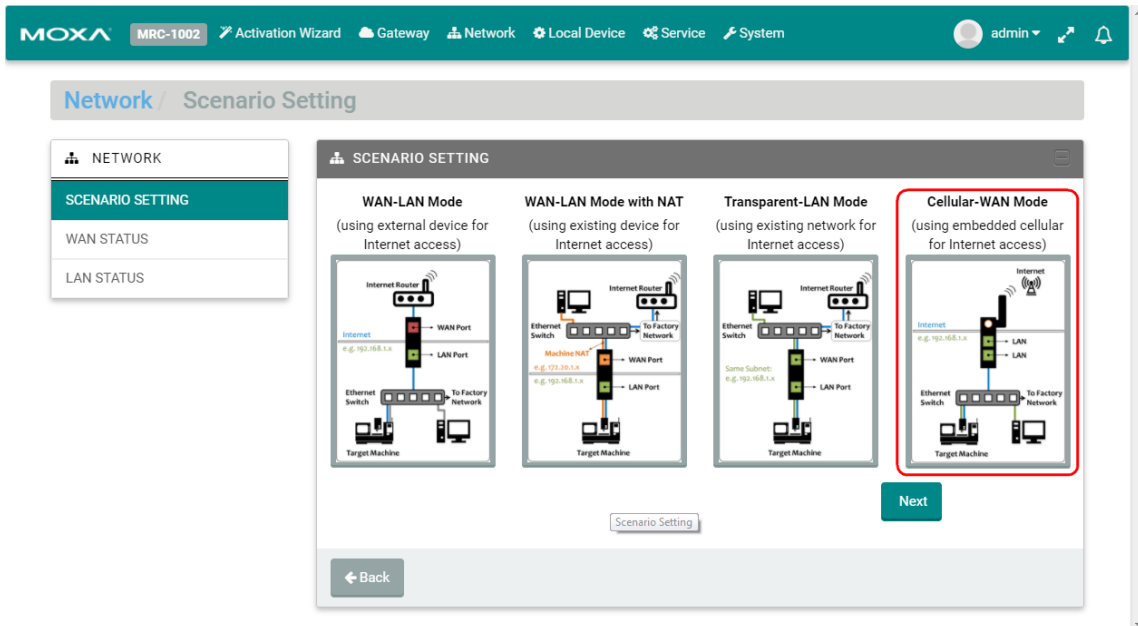

Input the name of the device and select the IP Ethernet device or L2 Ethernet device type. Then, input the IP address or MAC address for your device. If "Auto IP Mapping" configuration is enabled, you can choose any of the IP addresses in the virtual IP list for your IP Ethernet device. For the last step, you can choose "Health Check" function and select PING or port link to check the status of the device.

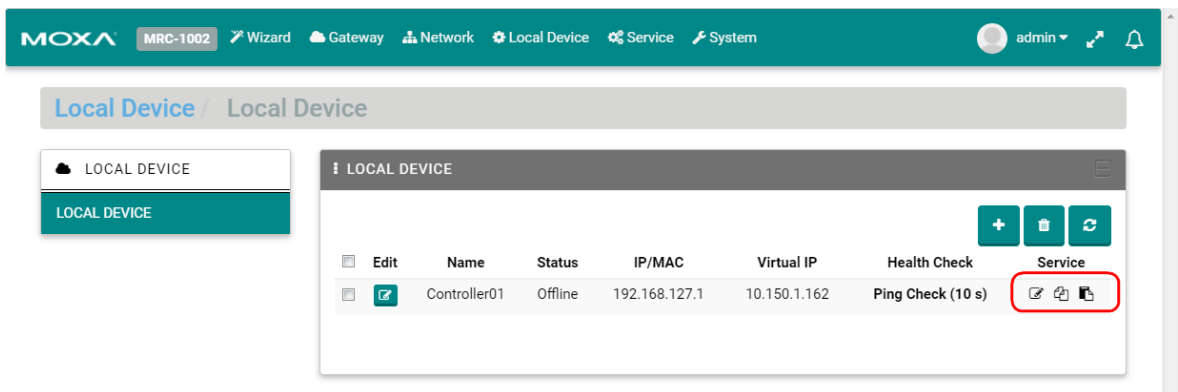

Users can also setup service-based access control of the devices. For example, you can limit the HTTP web service of the local device so that only Engineer A can have access to it. Therefore, other engineers will not be able to access that device’s HTTP web service.

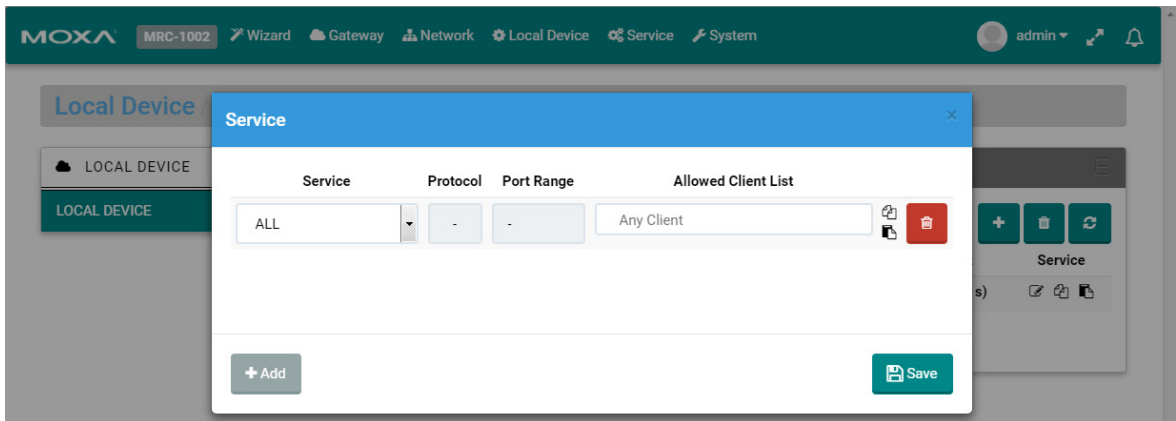

NOTE The allowed client list is referring to the client list in the client management page.

10

Service

The following topic is covered in this chapter:

- **Service**

Service

Users can change the time zone if the gateway was moved to a location in a different time zone. This will reflect the local time when auditing the event logs.

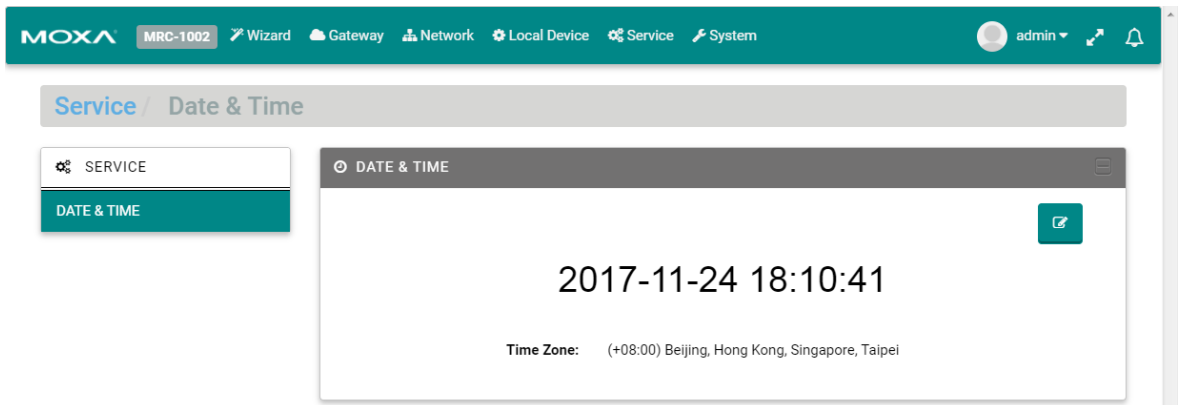

Click "✎" to change the settings.

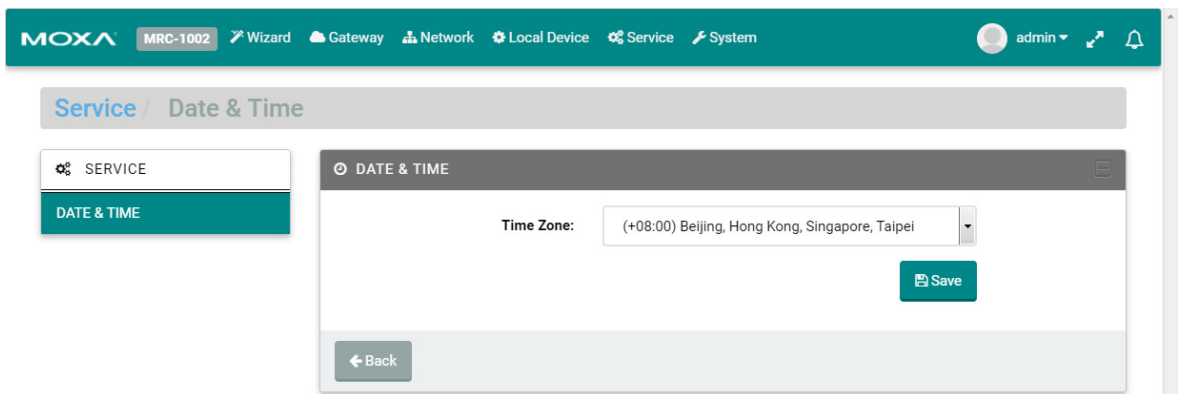

11

System

Users can obtain the system information locally and upgrade the firmware of the gateway.

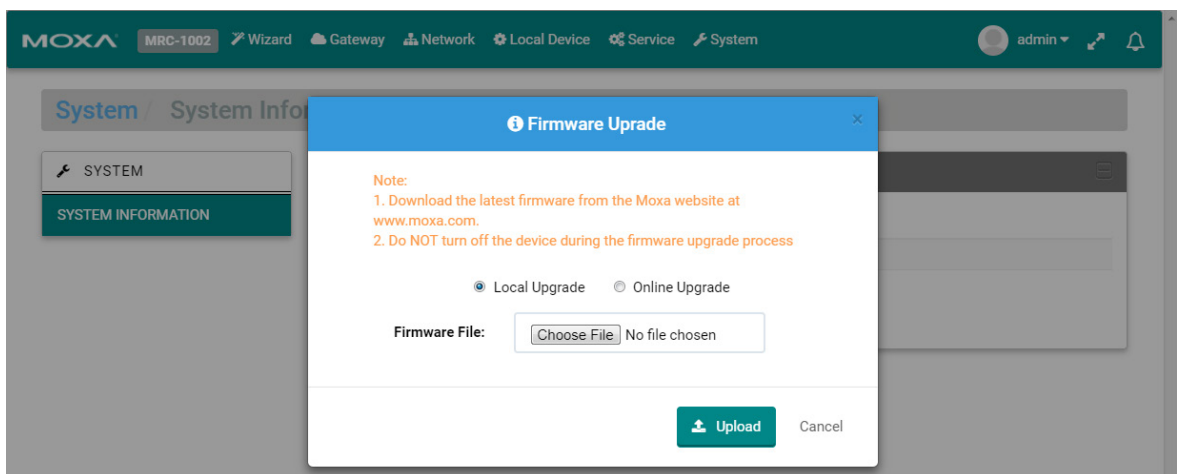
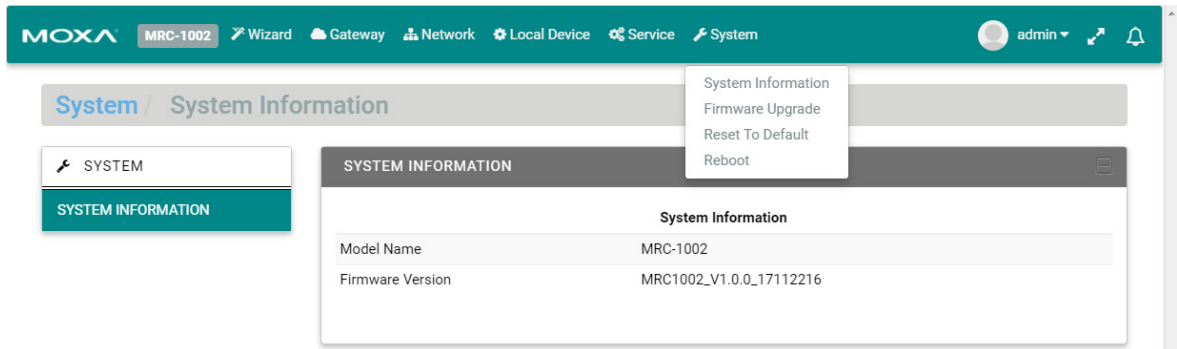

If necessary, users can reset the gateway to default settings or reboot the gateway.

