

NPort® 5200 Series

2-port RS-232/422/485 serial device servers



- > Compact design for easy installation
- > Socket modes: TCP server/TCP client/UDP
- > Easy-to-use Windows utility for configuring multiple device servers
- > Supports 10/100M Ethernet
- > Patented ADDC® (Automatic Data Direction Control) for 2-wire and 4-wire RS-485
- > SNMP MIB-II for network management



Specifications

Ethernet Interface

Number of Ports: 1
Speed: 10/100 Mbps, auto MDI/MDIX
Connector: 8-pin RJ45
Magnetic Isolation Protection: 1.5 kV built-in

Serial Interface

Number of Ports: 2
Serial Standards:
 NPort 5210: RS-232
 NPort 5230: 1 RS-232 port, 1 RS-422/485 port
 NPort 5232/5232I: RS-422/485

Connector:

NPort 5210: RJ45 (8 pins)
 NPort 5230/5232/5232I: Terminal Block (5 contacts per port)

Serial Line Protection: 2 kV isolation protection (NPort 5232I/5232I-T)

RS-485 Data Direction Control: ADDC® (Automatic Data Direction Control)

Serial Communication Parameters

Data Bits: 5, 6, 7, 8
Stop Bits: 1, 1.5, 2
Parity: None, Even, Odd, Space, Mark
Flow Control: RTS/CTS (RS-232 only), DTR/DSR (NPort 5210 only), XON/XOFF
Baudrate: Supports standard baudrates (unit=bps): 110, 134, 150, 300, 600, 1200, 1800, 2400, 4800, 7200, 9600, 19200, 38400, 57600, 115200, 230.4k

Serial Signals

RS-232:
 NPort 5210: TxD, RxD, RTS, CTS, DTR, DSR, DCD, GND
 NPort 5230: TxD, RxD, RTS, CTS, GND
RS-422: Tx+, Tx-, Rx+, Rx-, GND
RS-485-4w: Tx+, Tx-, Rx+, Rx-, GND
RS-485-2w: Data+, Data-, GND

Software

Network Protocols: ICMP, IPv4, TCP, UDP, DHCP, BOOTP, Telnet, DNS, SNMP V1, HTTP, SMTP, SNTP, ARP
Configuration Options: Web Console, Serial Console (NPort 5210/5230 only), Telnet Console, Windows Utility

Windows Real COM Drivers: Windows 95/98/ME/NT/2000, Windows XP/2003/Vista/2008/7/8/8.1/10 (x86/x64), Windows 2008 R2/2012/2012 R2 (x64), Windows Embedded CE 5.0/6.0, Windows XP Embedded

Fixed TTY Drivers: SCO Unix, SCO OpenServer, UnixWare 7, QNX 4.25, QNX 6, Solaris 10, FreeBSD, AIX 5.x, HP-UX 11i, Mac OS X

Linux Real TTY Drivers: Linux 2.4.x, 2.6.x, 3.x, 4.x

Android API: Android 3.1.x and later

Physical Characteristics

Housing: Metal

Weight:

NPort 5210: 340 g (0.75 lb)
 NPort 5230/5232: 360 g (0.79 lb)
 NPort 5232I: 380 g (0.84 lb)

Dimensions:

NPort 5210/5230/5232:
 Without ears: 67 x 100.4 x 22 mm (2.64 x 3.95 x 0.87 in)
 With ears: 90 x 100.4 x 22 mm (3.54 x 3.95 x 0.87 in)
 NPort 5232I:
 Without ears: 67 x 100.4 x 35 mm (2.64 x 3.95 x 1.37 in)
 With ears: 90 x 100.4 x 35 mm (3.54 x 3.95 x 1.37 in)

Environmental Limits

Operating Temperature:

Standard Models: 0 to 55°C (32 to 131°F)
 Wide Temp. Models: -40 to 75°C (-40 to 167°F)

Storage Temperature: -40 to 75°C (-40 to 167°F)

Ambient Relative Humidity: 5 to 95% (non-condensing)

Power Requirements

Input Voltage: 12 to 48 VDC

Input Current:

NPort 5210: 325 mA @ 12 VDC
 NPort 5230: 325 mA @ 12 VDC
 NPort 5232: 280 mA @ 12 VDC
 NPort 5232I: 365 mA @ 12 VDC

Standards and Certifications

Safety: UL 60950-1
EMC: EN 55032/24
EMI: CISPR 32, FCC Part 15B Class A
EMS:
 IEC 61000-4-2 ESD: Contact: 4 kV; Air: 8 kV
 IEC 61000-4-3 RS: 80 MHz to 1 GHz: 3 V/m
 IEC 61000-4-4 EFT: Power: 1 kV; Signal: 0.5 kV
 IEC 61000-4-5 Surge: Power: 1 kV
 IEC 61000-4-6 CS: 150 kHz to 80 MHz: 3 V/m; Signal: 3 V/m
 IEC 61000-4-8 PFMF
 IEC 61000-4-11 DIPs
Marine: DNV (excluding the NPort 5210)
Medical: (NPort 5210 only) EN 60601-1-2 Class B, EN55011

Reliability

Alert Tools: Built-in buzzer and RTC (real-time clock)
Automatic Reboot Trigger: Built-in WDT (watchdog timer)
MTBF (mean time between failures)
Time:
 NPort 5210: 381,342 hrs
 NPort 5230: 377,937 hrs
 NPort 5232/5232I: 309,383 hrs
Standard: Telcordia (Bellcore) Standard TR/SR
Warranty
Warranty Period: 5 years
Details: See www.moxa.com/warranty

Appearance

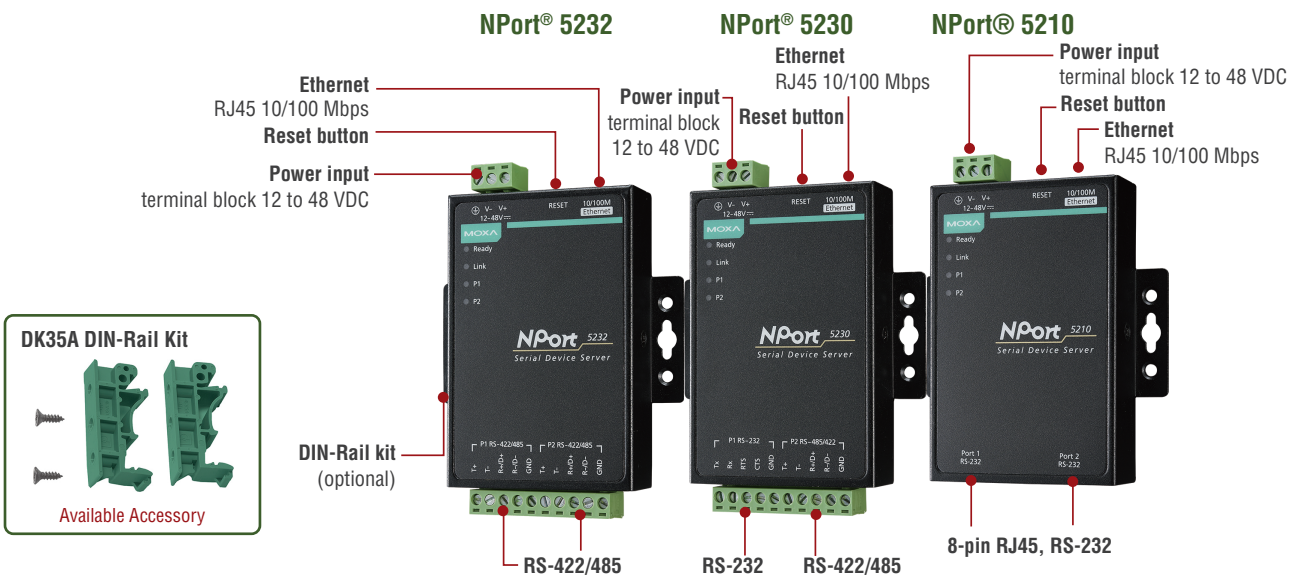

Dimensions

NPort® 5210

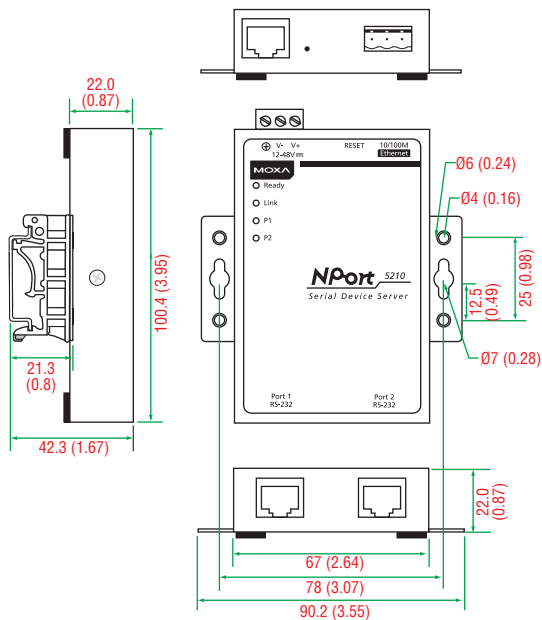

NPort® 5230

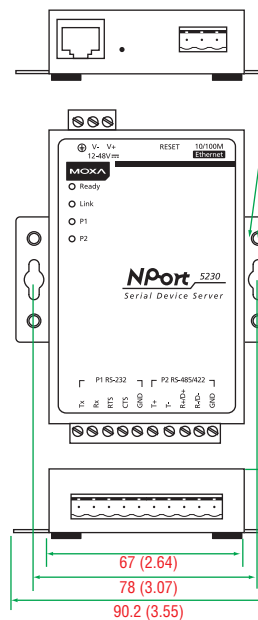

Dimensions

NPort® 5232

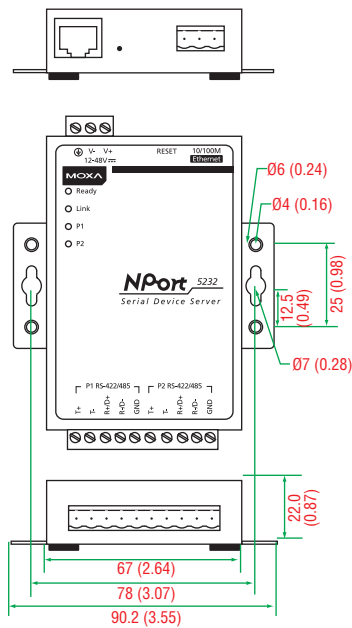

NPort® 5232I

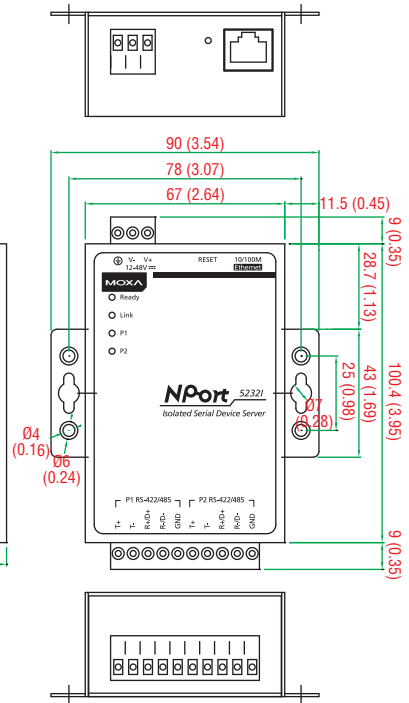

Unit: mm (inch)

Pin Assignment

8-pin RJ45 connector

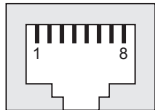

NPort® 5210/5210-T (RS-232)

PIN	RS-232
1	DSR (in)
2	RTS (out)
3	GND
4	TxD (out)
5	RxD (in)
6	DCD (in)
7	CTS (in)
8	DTR (out)

Ordering Information

Available Models

- NPort 5210:** 2-port RS-232 device server, 0 to 55°C operating temperature
- NPort 5230:** 2-port device server with 1 RS-232 port and 1 RS-422/485 port, 0 to 55°C operating temperature
- NPort 5232:** 2-port RS-422/485 device server, 0 to 55°C operating temperature
- NPort 5232I:** 2-port RS-422/485 device server with 2 kV optical isolation, 0 to 55°C operating temperature
- NPort 5210-T:** 2-port RS-232 device server, -40 to 75°C operating temperature
- NPort 5230-T:** 2-port device server with 1 RS-232 port and 1 RS-422/485 port, -40 to 75°C operating temperature
- NPort 5232-T:** 2-port RS-422/485 device server, -40 to 75°C operating temperature
- NPort 5232I-T:** 2-port RS-422/485 device server with 2 kV optical isolation, -40 to 75°C operating temperature

Optional Accessories (can be purchased separately)

- DK35A:** DIN-rail mounting clips, 35 mm, 2 DIN-rail plates with 4 screws
 - CBL-PJTB-10:** Non-locking barrel plug to bare wires cable
 - Mini DB9F-to-TB:** DB9 female to terminal block adapter for RS-422/485 applications
- Note: Additional power adapters can be purchased separately. Please refer to the Power Accessory Selection Guide for details.

Package Checklist





- 1 NPort 5200 device server
- 1 power wiring adapter: CBL-PJTB-10
- Documentation and software CD
- Quick installation guide (printed)
- Warranty card







Power Accessory Selection Guide

Barrel Plug Type		Locking Barrel Plug				
O/P		12 VDC 0.5 A, 100 to 240 VAC (Switch-Mode)				
Plug Type		US/JP	EU	AU	UK	CN
Appearance						
Model Name		PWR-12050-WPUSJP-S1	PWR-12050-WPEU-S1	PWR-12050-WPAU-S1	PWR-12050-WPUK-S1	PWR-12050-WPCN-S1
1 Port	NPort 5110	-	-	-	-	-
	NPort 5130	-	-	-	-	-
	NPort 5150	-	-	-	-	-
	NPort 5110A	✓	✓	✓	✓	✓
	NPort 5130A	✓	✓	✓	✓	✓
	NPort 5150A	✓	✓	✓	✓	✓
	DE-211	-	-	-	-	-
	DE-311	-	-	-	-	-
	NPort P5150A	✓	✓	✓	✓	✓
	NPort W2150A	✓	✓	✓	✓	✓
NPort Z2150/Z3150	✓	✓	✓	✓	✓	
2 Ports	NPort 5210	-	-	-	-	-
	NPort 5230	-	-	-	-	-
	NPort 5232	-	-	-	-	-
	NPort 5232I	-	-	-	-	-
	NPort 5210A	✓	✓	✓	✓	✓
	NPort 5230A	✓	✓	✓	✓	✓
	NPort 5250A	✓	✓	✓	✓	✓
	NPort W2250A	✓	✓	✓	✓	✓

Barrel Plug Type		Non-Locking Barrel Plug				
O/P		12 VDC 0.5 A, 100 to 240 VAC (Switch-Mode)				
Plug Type		US/JP	EU	AU	UK	CN
Appearance						
Model Name		PWR-12050-WPUSJP-S2	PWR-12050-WPEU-S2	PWR-12050-WPAU-S2	PWR-12050-WPUK-S2	PWR-12050-WPCN-S2
1 Port	NPort 5110	✓	✓	✓	✓	✓
	NPort 5130	✓	✓	✓	✓	✓
	NPort 5150	✓	✓	✓	✓	✓
	NPort 5110A	-	-	-	-	-
	NPort 5130A	-	-	-	-	-
	NPort 5150A	-	-	-	-	-
	DE-211	✓	✓	✓	✓	✓
	DE-311	✓	✓	✓	✓	✓
	NPort P5150A	-	-	-	-	-
	NPort W2150A	-	-	-	-	-
NPort Z2150/Z3150	-	-	-	-	-	
2 Ports	NPort 5210	✓	✓	✓	✓	✓
	NPort 5230	✓	✓	✓	✓	✓
	NPort 5232	✓	✓	✓	✓	✓
	NPort 5232I	✓	✓	✓	✓	✓
	NPort 5210A	-	-	-	-	-
	NPort 5230A	-	-	-	-	-
	NPort 5250A	-	-	-	-	-
	NPort W2250A	-	-	-	-	-

Power Accessory Selection Guide

Barrel Plug Type		Non-Locking Barrel Plug				
O/P		12 VDC 1.25/1.5 A, 100 to 240 VAC				
Plug Type		US/JP	EU	AU	UK	CN
Appearance						
Model Name		PWR-12125-WPUSJP-S1	PWR-12125-WPEU-S1	PWR-12125-WPAU-S1	PWR-12125-WPUK-S1	PWR-12125-WPCN-S1
4 Ports	NPort 5410	✓	✓	✓	✓	✓
	NPort 5430	✓	✓	✓	✓	✓
	NPort 5430I	✓	✓	✓	✓	✓
	NPort 5450	✓	✓	✓	✓	✓
	NPort 5450I	✓	✓	✓	✓	✓
8 Ports	NPort 5610-8	-	-	-	-	-
	NPort 5630-8	-	-	-	-	-
	NPort 5650-8	-	-	-	-	-
	NPort 5650-8-M-SC	-	-	-	-	-
	NPort 5650-8-S-SC	-	-	-	-	-
	NPort 5610-8-DT	-	-	-	-	-
	NPort 5610-8-DT-J	-	-	-	-	-
	NPort 5650-8-DT	-	-	-	-	-
	NPort 5650-8-DT-J	-	-	-	-	-
	NPort 5650I-8-DT	-	-	-	-	-
NPort 5610-8-DTL	-	-	-	-	-	
16 Ports	NPort 5610-16	-	-	-	-	-
	NPort 5630-16	-	-	-	-	-
	NPort 5650-16	-	-	-	-	-

Barrel Plug Type		Locking Barrel Plug						
O/P		12 VDC 2 A, 100 to 240 VAC (desktop type)	10A/250V Power Cord, 183 cm					
Plug Type		Requires 1 power cord (US/JP/EU/AU/UK/CN)	US	JP	EU	AU	UK	CN
Appearance								
Model Name		PWR-12200-DT-S1	PWC-C13US-3B-183	PWC-C13JP-3B-183	PWC-C13EU-3B-183	PWC-C13AU-3B-183	PWC-C13UK-3B-183	PWC-C13CN-3B-183
4 Ports	NPort 5410	-	-	-	-	-	-	-
	NPort 5430	-	-	-	-	-	-	-
	NPort 5430I	-	-	-	-	-	-	-
	NPort 5450	-	-	-	-	-	-	-
	NPort 5450I	-	-	-	-	-	-	-
8 Ports	NPort 5610-8	-	✓	✓	✓	✓	✓	✓
	NPort 5630-8	-	✓	✓	✓	✓	✓	✓
	NPort 5650-8	-	✓	✓	✓	✓	✓	✓
	NPort 5650-8-M-SC	-	✓	✓	✓	✓	✓	✓
	NPort 5650-8-S-SC	-	✓	✓	✓	✓	✓	✓
	NPort 5610-8-DT	✓	✓	✓	✓	✓	✓	✓
	NPort 5610-8-DT-J	✓	✓	✓	✓	✓	✓	✓
	NPort 5650-8-DT	✓	✓	✓	✓	✓	✓	✓
	NPort 5650-8-DT-J	✓	✓	✓	✓	✓	✓	✓
	NPort 5650I-8-DT	✓	✓	✓	✓	✓	✓	✓
16 Ports	NPort 5610-16	-	✓	✓	✓	✓	✓	✓
	NPort 5630-16	-	✓	✓	✓	✓	✓	✓
	NPort 5650-16	-	✓	✓	✓	✓	✓	✓