

# NPort 5200 Series Quick Installation Guide

---

Edition 8.0, February 2017

## Technical Support Contact Information [www.moxa.com/support](http://www.moxa.com/support)

### Moxa Americas:

Toll-free: 1-888-669-2872

Tel: 1-714-528-6777

Fax: 1-714-528-6778

### Moxa China (Shanghai office):

Toll-free: 800-820-5036

Tel: +86-21-5258-9955

Fax: +86-21-5258-5505

### Moxa Europe:

Tel: +49-89-3 70 03 99-0

Fax: +49-89-3 70 03 99-99

### Moxa Asia-Pacific:

Tel: +886-2-8919-1230

Fax: +886-2-8919-1231

### Moxa India:

Tel: +91-80-4172-9088

Fax: +91-80-4132-1045



© 2017 Moxa Inc. All rights reserved.

P/N: 1802052000313



## Overview

The NPort 5200 compact palm-sized device servers are used to control RS-232 (NPort 5210/5230/5210-T/5230-T) or RS-422/485 (NPort 5230/5232/5232I/5230-T/5232-T/5232I-T) serial devices over a TCP/IP-based Ethernet.

**NOTE** “-T” indicates an extended operating temperature model.

## Package Checklist

Before installing your NPort 5200, verify that the package contains the following items:

- 1 NPort 5200 2-port Serial Device Server
- Documentation & Software CD
- Quick Installation Guide (printed)
- Warranty card

### Optional Accessories

- DK-35A: DIN-Rail Mounting Kit (35 mm)
- CBL-RJ45M9-150: RJ45 (8-pin) to DB9 (M) cable, 150 cm
- CBL-RJ45F9-150: RJ45 (8-pin) to DB9 (F) cable, 150 cm
- CBL-RJ45M25-150: RJ45 (8-pin) to DB25 (M) cable, 150 cm
- CBL-RJ45F25-150: RJ45 (8-pin) to DB25 (F) cable, 150 cm
- DIN-Rail Power Supply and Adapter

*Note: Notify your sales representative if any of the above items are missing or damaged.*

## Hardware Introduction

The NPort 5200 device servers are used to control RS-232/422/485 devices. The NPort 5210/5210-T has two 8-pin RJ45 ports, both for the RS-232 interface. The NPort 5230/5230-T has one 10-pin terminal block, with 5 pins used for one RS-232 port, and 5 pins used for one RS-422/485 port. The NPort 5232/5232I/5232-T/5232I-T have one 10-pin terminal block, with 5 pins used for one RS-422/485 port, and 5 pins used for another RS-422/485 port.

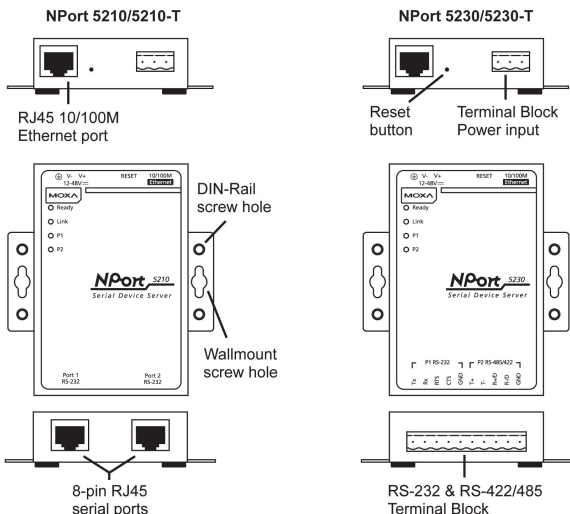

**NPort 5232/5232-T**

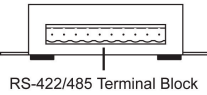
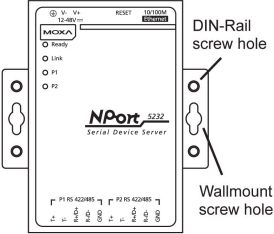
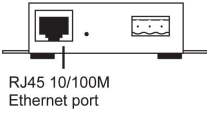

**NPort 5232I/5232I-T**

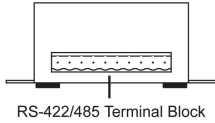
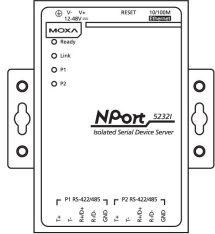
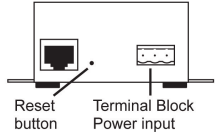

**Reset Button**—Press the *Reset button* continuously for 5 sec to load factory defaults: Use a pointed object, such as a straightened paper clip or toothpick, to press the reset button. This will cause the Ready LED to blink on and off. The factory defaults will be loaded once the Ready LED stops blinking (after about 5 seconds). At this point, you should release the reset button.

**NPort 5200 LED Indicators (top panel)**

LED Name	LED Color	LED Function
Ready	Red	Steady on: Power is on and the NPort 5200 is booting up.
		Blinking: Indicates an IP conflict, or DHCP or BOOTP server did not respond properly.
	Green	Steady on: Power is on and the NPort 5200 is functioning normally.
		Blinking: The device server has been located by Administrator's Location function
	Off	Power is off, or power error condition exists.
Ethernet	Orange	10 Mbps Ethernet connection.
	Green	100 Mbps Ethernet connection.
	Off	Ethernet cable is disconnected, or has a short.
P1, P2	Orange	Serial port is receiving data.
	Green	Serial port is transmitting data.
	Off	No data is being transmitted or received through the serial port.

## Hardware Installation Procedure

**STEP 1:** After removing the NPort 5200 from the box, the first thing you should do is connect the power adapter. Connect the 12-30 VDC power line with the NPort 5200's terminal block, or connect the DIN-rail power supply with the NPort 5200's terminal block.

**STEP 2:** Connect the NPort 5200 to a network. Use a standard straight-through Ethernet cable to connect to a hub or switch. When setting up or testing the NPort 5200, you might find it convenient to connect directly to your computer's Ethernet port. In this case, use a cross-over Ethernet cable.

**STEP 3:** Connect the NPort 5200's serial port to a serial device.

### STEP 4: Placement Options

In addition to placing the NPort 5200 on a desktop or other horizontal surface, you may also make use of the DIN-rail or wall mount options, as illustrated here.

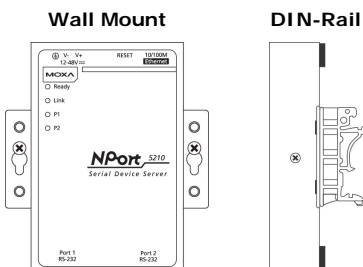

## Software Installation Information

To install **NPort Administration Suite**, insert the **NPort Document & Software CD** into your computer's CD-ROM drive. Once the **NPort Installation CD** window opens, click on the Installation button, and then follow the instructions on the screen. To view detailed information about **NPort 5200 Administration Suite**, click on the **Documents** button, and then select "NPort 5200 Series User's Guide" to open the pdf version of this user's guide. The **PComm Lite** program is also included in the **Documentation & Software CD** free of charge. Install **PComm Lite** to use the **Serial Console** for configuring the IP address for the first time.

## Pin Assignments and Cable Wiring—

### NPort 5230/5230-T

#### Terminal Block Wiring

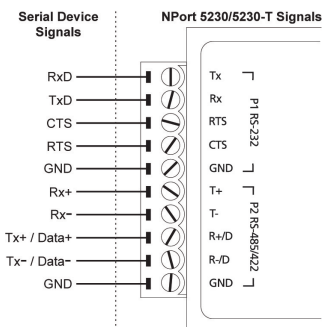

**NOTE** The NPort 5232/5232I/5232-T/5232I-T have 2 RS-422/485 ports. The pin assignments are the same as the NPort 5230/5230-T's port 2. Refer to the "NPort 5200 Series User's Manual" for more details.

## Pin Assignments and Cable Wiring— NPort 5210/5210-T

### RJ45 (8-pin) Connector Pinouts

8-Pin	Signal
1	DSR
2	RTS
3	GND
4	TxD
5	RxD
6	DCD
7	CTS
8	DTR

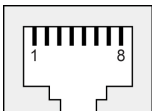

### Cable Wiring (RS-232)

Four cables are available as optional accessories to connect the NPort 5210/5210-T to RS-232 serial devices. For your convenience, we show precise cable wiring diagrams for each of the four cables.

#### RJ45 (8-pin) to DB25 Female (Cable Name: CBL-RJ45F25-150)

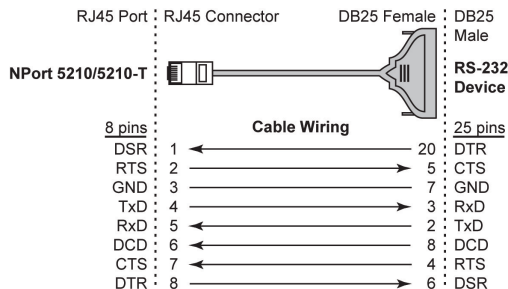

#### RJ45 (8-pin) to DB25 Male (Cable Name: CBL-RJ45M25-150)

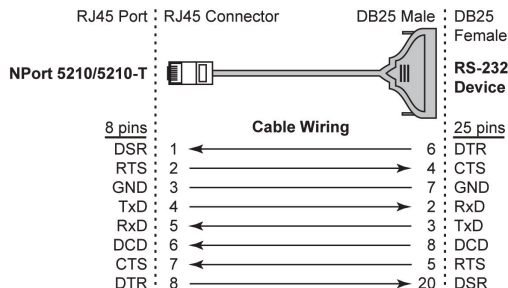

## **RJ45 (8-pin) to DB9 Female** (Cable Name: CBL-RJ45F9-150)

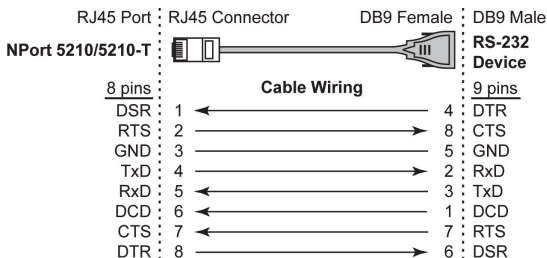

## **RJ45 (8-pin) to DB9 Male** (Cable Name: CBL-RJ45M9-150)

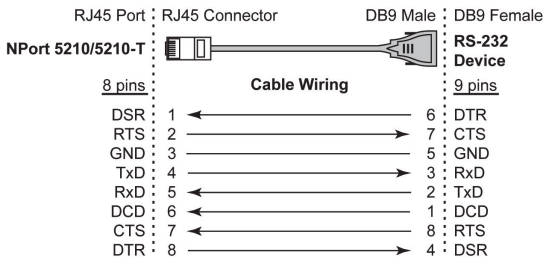

## **Specifications**

### **Power Requirements**

NPort 5210/5210-T: 12 to 48 VDC, 325 mA at 12V (max.)

NPort 5230/5230-T: 12 to 48 VDC, 325 mA at 12V (max.)

NPort 5232/5232-T: 12 to 48 VDC, 280 mA at 12V (max.)

NPort 5232I/5232I-T: 12 to 48 VDC, 365 mA at 12V (max.)

### **Operating Temp.**

Standard models: 0 to 55°C (32 to 131°F)

T models: -40 to 75°C (-40 to 167°F)

Operating humidity: 5 to 95% RH

### **Dimensions**

NPort 5210/5230/5232/5210-T/5230-T/5232-T (including ears):

90 × 100.4 × 22 mm (3.54 × 3.95 × 0.87 in)

NPort 5210/5230/5232/5210-T/5230-T/5232-T (without ears):

67 × 100.4 × 22 mm (2.64 × 3.95 × 0.87 in)

NPort 5232I/5232I-T (including ears):

90 × 100.4 × 35 mm (3.54 × 3.95 × 1.37 in)

NPort 5232I/5232I-T (without ears):

67 × 100.4 × 35 mm (2.64 × 3.95 × 1.37 in)

<b>Regulatory Approvals</b>	
Safety	UL 60950-1
EMC	EN 55032/24
EMI	CISPR 32, FCC Part 15B Class A
EMS	IEC 61000-4-2 ESD: Contact: 4 kV; Air: 8 kV IEC 61000-4-3 RS: 80 MHz to 1 GHz: 3 V/m IEC 61000-4-4 EFT: Power: 1 kV; Signal: 0.5 kV IEC 61000-4-5 Surge: Power: 1 kV IEC 61000-4-6 CS: 150 kHz to 80 MHz: 3 V/m; Signal: 3 V/m IEC 61000-4-8 PFMF IEC 61000-4-11 DIPs
Marine	DNV (excluding the NPort 5210)
Medical	(NPort 5210 only) EN 60601-1-2 Class B, EN55011