



NPort DE-211

Quick Installation Guide

Eighth Edition, June 2014

Overview

Welcome to Moxa's NPort Express DE-211, a compact palm-sized data communication device that allows you to control RS-232/422/485 serial devices over a TCP/IP based Ethernet network.

Package Checklist

Before installing the NPort Express DE-211, verify that the package contains the following items:

- 1 NPort Express DE-211
- NPort DE-211 quick installation guide
- Documentation and software CD
- Warranty card

Optional Accessories

- **NP21101:** RS-232 cable: DB25 (M) to DB9 (F), 30 cm
- **NP21102:** RS-232 cable: DB25 (M) to DB9 (M), 30 cm
- **NP21103:** DB25 Terminal Block Kit for RS-422/485
- **DK-35A:** DIN-Rail Mounting Kit (35 mm)

Notify your sales representative if any of the above items are missing or damaged.

Hardware Introduction

The NPort DE-211 device server has one female DB25 serial port. The four DIP switches located on the rear panel are used to select RS-232 COM mode, and one of four data modes: RS-232, RS-422, 4-wire RS-485, and 2-wire RS-485. See the "DIP Switch Settings and Explanation" section for details.

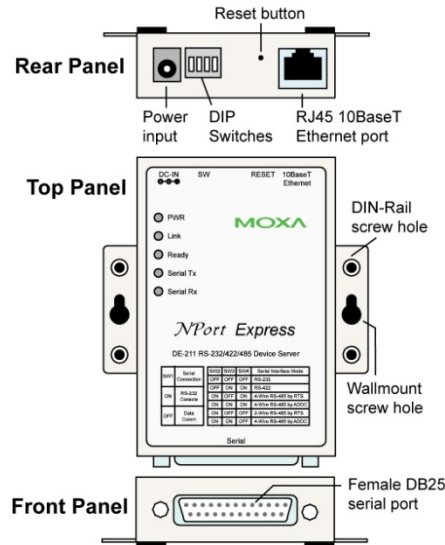
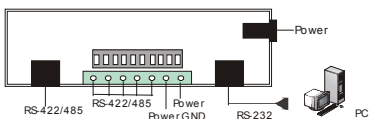

Reset Button

- Press the Reset button continuously for 3 sec to erase the password. After 3 sec, the Ready LED will flash on/off every half second. Release the reset button at this time to erase the password.
- Press the Reset button continuously for 10 sec to load factory defaults. After 10 sec, the Ready LED will flash on/off every half second. Release the reset button at this time to load factory defaults.

LED Indicators (top panel)

LED Name	LED Color	LED Function
PWR	red	Power is on
	off	Power is off, or power error condition exists
Link	orange	10 Mbps Ethernet connection
	off	Ethernet cable is disconnected, or has a short
Ready	green	NPort Server system is ready
	off	NPort Server has malfunctioned
Serial Tx	green	Serial data is being transmitted
	off	Serial data is not being transmitted
Serial Rx	orange	Serial data is being received
	off	Serial data is not being received

Hardware Installation Procedure

Placement Options

In addition to placing the DE-211 unit on a desktop or other horizontal surface, you may also make use of the DIN-Rail or Wall Mount options, as illustrated here.

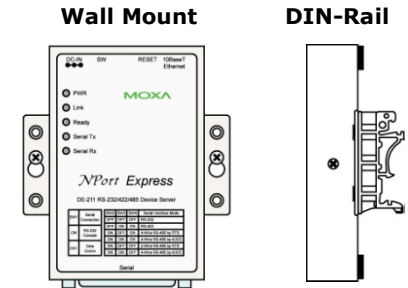

DIP Switch Settings and Explanation

The top panel of the DE-211 contains the following table, which describes how to set up the serial port using the four DIP switches located on DE-211's rear panel.

SW1	Serial Connection	SW2	SW3	SW4	Serial Interface Mode
ON	RS-232 Console	OFF	OFF	OFF	RS-232
		OFF	ON	ON	RS-422
OFF	Data Comm	ON	OFF	ON	4-wire RS-485 by RTS
		ON	ON	ON	4-wire RS-485 by ADDC
		ON	OFF	OFF	2-wire RS-485 by RTS
		ON	ON	OFF	2-wire RS-485 by ADDC

Switch SW1 controls the function of the serial port. Note that after changing the setting of SW1, the DE-211 will reboot to initialize the new setting. You must wait a few seconds for the green Ready light to blink off and then on again, indicating that the function of the serial port has been changed. Switches SW2, SW3, and SW4 control the serial port's data communication Interface Mode. (RTS stands for Ready To Send and ADDC stands for Automatic Data Direction Control.)

Keep the following points in mind when setting the DIP switches:

- To use the serial port as an RS-232 console connection, such as when using MOXA PComm Terminal Emulator or HyperTerminal, set SW1 to the ON position.
- Some setup procedures can be carried out through a Telnet connection, in which case data is transmitted through the DE-211's Ethernet port. However, you must set SW1 to the OFF position to establish a Telnet connection.

Software Installation Information

Detailed information about installing the software that comes with the DE-211 can be found on the NPort Documentation and Software CD in the "NPort Family Software Installation Guide".

Pin Assignments and Cable Wiring

Female DB25 Connector Pinouts

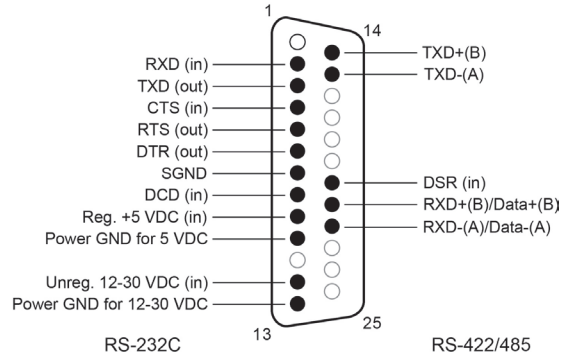

WARNING

Pin 1 is reserved for debugging. Connecting this pin yourself could result in irreparable damage to your device.

RS-232 Wiring

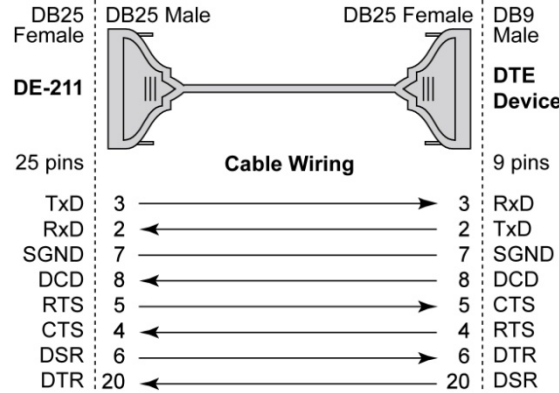
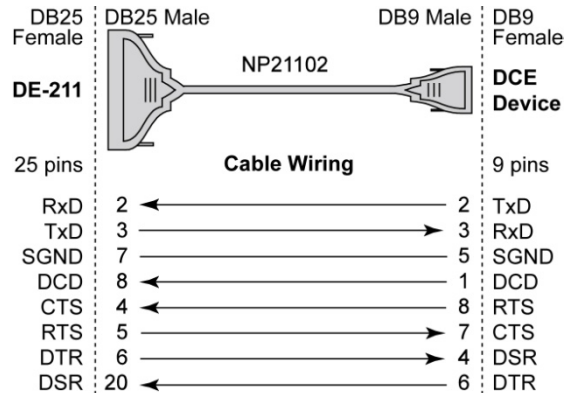

RS-422 Wiring

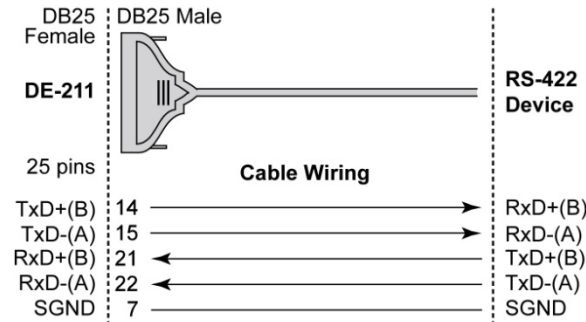

RS-485 Wiring

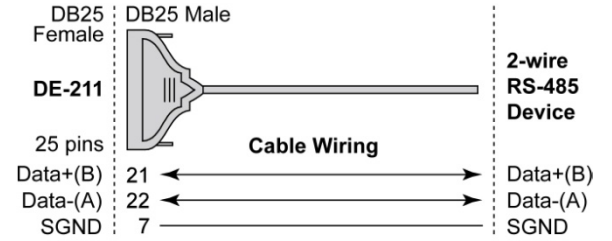
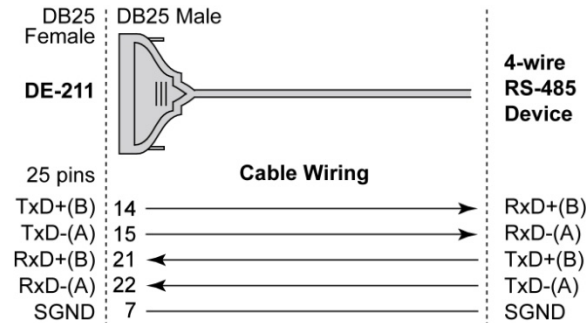

DB25 Terminal Block Kit (RS-422, RS-485-2W/4W)

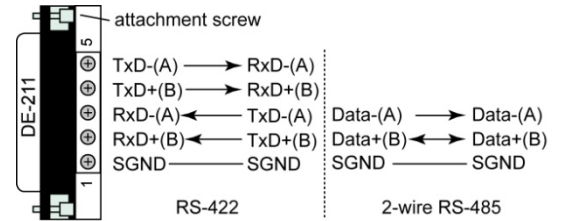

Environmental Specifications

Power requirements	12 to 30 VDC 150 mA (max.) at 12 V 92 mA (max.) at 24 V
Operating Temp.	0 to 55°C
Ambient Relative Humidity	5 to 95% (non-condensing)
Dimensions	Including ears: 90.2 × 100.4 × 22 mm (3.55 × 3.95 × 0.87 in) Without ears: 67 × 100.4 × 22 mm (2.64 × 3.95 × 0.87 in)
Surge Protection	15 KV ESD for the serial port
Magnetic Isolation Protection	1.5 KV for the Ethernet port
Regulatory Approvals	FCC Class B, CE Class B, UL 60950-1, EN 60950-1

MOXA® www.moxa.com/support

The Americas: +1-714-528-6777 (toll-free: 1-888-669-2872)
Europe: +49-89-3 70 03 99-0
Asia-Pacific: +886-2-8919-1230
China: +86-21-5258-9955 (toll-free: 800-820-5036)

© 2014 Moxa Inc. All rights reserved.