

# **TN-5508/5510 Series Hardware Installation Guide**

---

**Moxa ToughNet Switch**

**Fourth Edition, September 2014**



© 2014 Moxa Inc. All rights reserved.

**P/N: 1802055080013**

## Overview

The ToughNet TN-5508/5510 series M12 managed Ethernet switches are designed for industrial applications in harsh environments. The TN series switches use M12 connectors to ensure tight, robust connections, and guarantee reliable operation against environmental disturbances, such as vibration and shock. The wide selection of 12/24/36/48 VDC, 72/96/110 VDC, or 110/220 VDC/VAC dual redundant power supplies increases the reliability of your communications. TN-5508 switches provide up to 8 fast Ethernet M12 ports.

TN-5510 switches provide up to 8 fast Ethernet M12 ports, and 2 Gigabit Ethernet ports on the bottom panel which provide an optional bypass relay function. Models with an extended operating temperature range of -40 to 75°C are also available. The TN-5508/5510 series Ethernet switches are compliant with EN50155/50121-3-2/50121-4 (railway applications), NEMA TS2 (traffic control systems), and e-Mark (vehicles) requirements, making the switches suitable for a variety of industrial applications.

## Package Checklist

Your ToughNet TN-5508/5510 switch is shipped with the following items. If any of these items is missing or damaged, please contact your customer service representative for assistance.

- 1 Moxa ToughNet switch.
- Hardware installation guide.
- CD-ROM with user's manual, Windows utility, and SNMP MIB file.
- Moxa product warranty statement.
- M12 to DB9 console port cable.
- 2 protective caps for console and relay output ports.
- Panel mounting kit.

## Features

### ***Anti-Vibration Circular Connectors for Robust Links***

- M12 D-coding 4 pins female connectors for Fast Ethernet 10/100BaseT(X) ports.
- M12 connectors for Gigabit Ethernet 10/100/1000BaseT(X) ports.
- M12 A-coding 5 pins male connectors for console and relay output.
- M23 6 pins male connector for power input.

### ***Dual, Isolated Redundant Power Inputs***

- 2 Gigabit Ethernet ports for flexibility with high bandwidth requirements.
- Bypass relay function on the 2 Gigabit Ethernet ports to ensure data communications even if an individual device fails.
- Supports 12/24/36/48 VDC (8.4–60 VDC).
- Supports 72/110 VDC (50.4–54 VDC), isolated.
- Supports 110/220 VDC/VAC (88–300VDC, 85–264 VAC), isolated.
- Dual redundant, parallel load-sharing power supplies.

### ***High Performance Network Switching Technology***

- IPv6 Ready logo awarded (IPv6 Logo Committee certified).
- IEEE 1588 PTP (Precision Time Protocol) for precise time synchronization of networks.
- DHCP Option 82 for IP address assignment with different policies.

- Modbus/TCP industrial Ethernet protocol.
- Turbo Ring, Turbo Chain, and RSTP/STP (IEEE802.1w/D).
- IGMP Snooping and GMRP for filtering multicast traffic from industrial Ethernet protocols.
- Port-based VLAN, IEEE802.1Q VLAN, and GVRP protocol to ease network planning.
- QoS (IEEE802.1p/1Q and TOS/DiffServ) to increase determinism.
- 802.3ad, LACP for optimum bandwidth utilization.
- IEEE802.1X and https/SSL to enhance network security.
- SNMP v1/v2c/v3 for different levels of network management.
- RMON for efficient network monitoring and proactive capability.
- Bandwidth management prevents unpredictable network status.
- Lock port allows access by only authorized MAC addresses.
- Port mirroring for online debugging.
- Automatic warning by exception through email, relay output.
- Automatic recovery of connected device's IP addresses.
- Line-swap fast recovery.
- LLDP for automatic topology discovery in network management software.
- Configurable through Web browser, Telnet/Serial console, and Windows utility.

### ***Designed for Industrial-Specific Applications***

- Three rotary switches for setting the last 3 digits of the IP address makes maintenance even easier.
- EN 50155/50121-3-2/50121-4, NEMA TS2, and e-Mark compliant.
- -40 to 75°C operating temperature range (for "-T" models).
- IP54/IP67, rugged high-strength case.
- Panel mounting or DIN-Rail mounting installation capability.

### **Recommended Optional Accessories**

- CBL-M23(FF6P)Open-BK-100-IP67: 1-meter M23 to 6-pin power cable with IP67-rated female 6-pin M23 connector.
- CBL-M12D(MM4P)/RJ45-100 IP67: 1-meter M12-to-RJ45 Cat-5E UTP Ethernet cable with IP67-rated male 4-pin M12 D-coded connector.
- CBL-M12(FF5P)/OPEN-100 IP67: 1-meter M12-to-5-pin power cable with IP67-rated female 5-pin M12 A-coded connector.
- M12D-4P-IP68: Field-installable M12 D-coded screw-in connector, male 4-pin, IP68-rated..
- M12A-5P-IP68: Field-installable M12 A-coded screw-in connector, female 5-pin, IP68-rated..
- CAP-M12F-M: Metal cap for M12 female connector.
- DK-DC50131: DIN-Rail mounting kit, 50 x 131 mm.
- PLG-WPRJ-02: Field-installable circular connector kit for RJ45 twisted-pair cable, IP67-rated.

# TN-5508 Panel Layouts

Top View

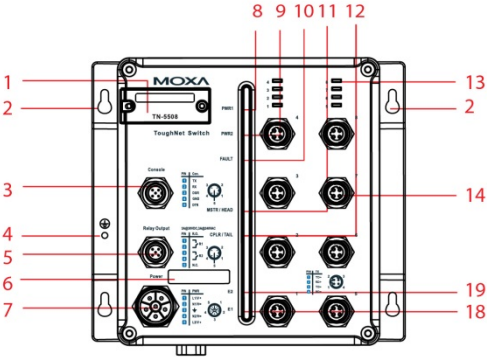
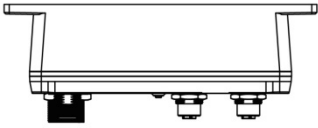

Front View

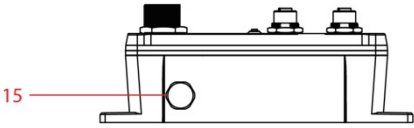

Bottom View

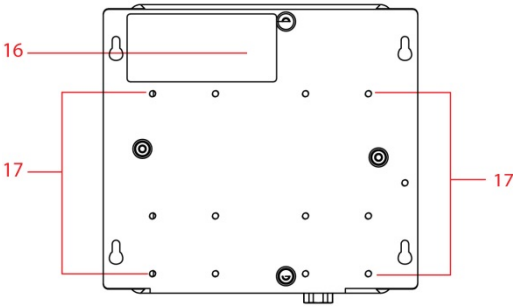

Rear View

1. 3 Rotary switches and protective cover with Model name.
2. Screw holes for panel mounting kit.
3. Console port.
4. Grounding screw.
5. Relay output port.
6. Power input voltage range indication.
7. Power input port (male 6-pin shielded M23 connector).

8. PWR1 LED: for power input 1.
9. PWR2 LED: for power input 2.
10. FAULT LED.
11. MSTR/HEAD LED: for ring master or chain head.
12. CPLR/TAIL LED: for ring coupler or chain tail.
13. TP port's 10/100 Mbps LED.
14. 10/100BaseT(X) port (female 4-pin shielded M12 connector with D coding).
15. Waterproof vent.
16. Product label.
17. 12 Screw holes for DIN-Rail mounting kit.
18. E1 LED: Not used by the TN-5508 series.
19. E2 LED: Not used by the TN-5508 series.

# TN-5510 Panel Layouts

Top View

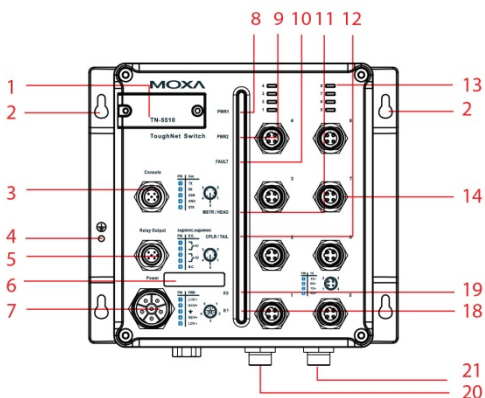
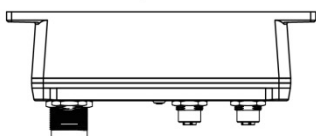

Front View

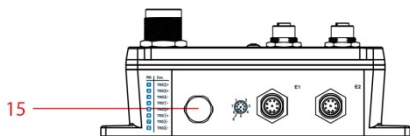

Bottom View

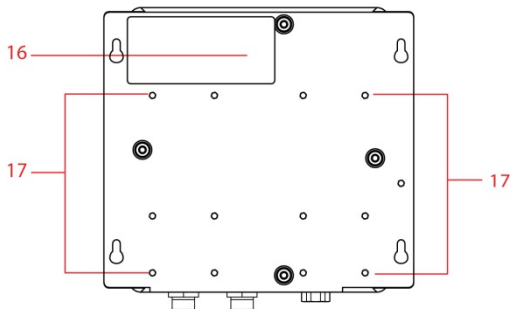

Rear View

1. 3 Rotary switches and protective cover with Model name.
2. Screw holes for panel mounting kit.
3. Console port.
4. Grounding screw.
5. Relay output port.
6. Power input voltage range indication.
7. Power input port (male 6-pin shielded M23 connector).

8. PWR1 LED: for power input 1.
9. PWR2 LED: for power input 2.
10. FAULT LED.
11. MSTR/HEAD LED: for ring master or chain head.
12. CPLR/TAIL LED: for ring coupler or chain tail.
13. TP port's 10/100 Mbps LED.
14. 10/100BaseT(X) port (female 4-pin shielded M12 connector with D coding).
15. Waterproof vent.
16. Product label.
17. 12 Screw holes for DIN-Rail mounting kit.
18. E1 LED: Down-side E1 Gigabit port's 10/100/1000 Mbps LED.
19. E2 LED: Down-side E2 Gigabit port's 10/100/1000 Mbps LED.
20. Gigabit Ethernet port E1 (corresponding to port 9 in the TN-5510 User's Manual).
21. Gigabit Ethernet port E2 (corresponding to port 10 in the TN-5510 User's Manual).



## ATTENTION

Please DO NOT open or remove vent **15**. The warranty will be invalid if the seal is removed.

All exposed connectors, including **3, 5, 7, and 14**, should be tightly covered by protective caps when they are not in use to ensure for IP54/IP67 protection.

After setting rotary switch **1**, the protective cover must be fixed properly to ensure IP54/IP67 protection.

# Mounting Dimensions (unit = mm)

## TN-5508 Series

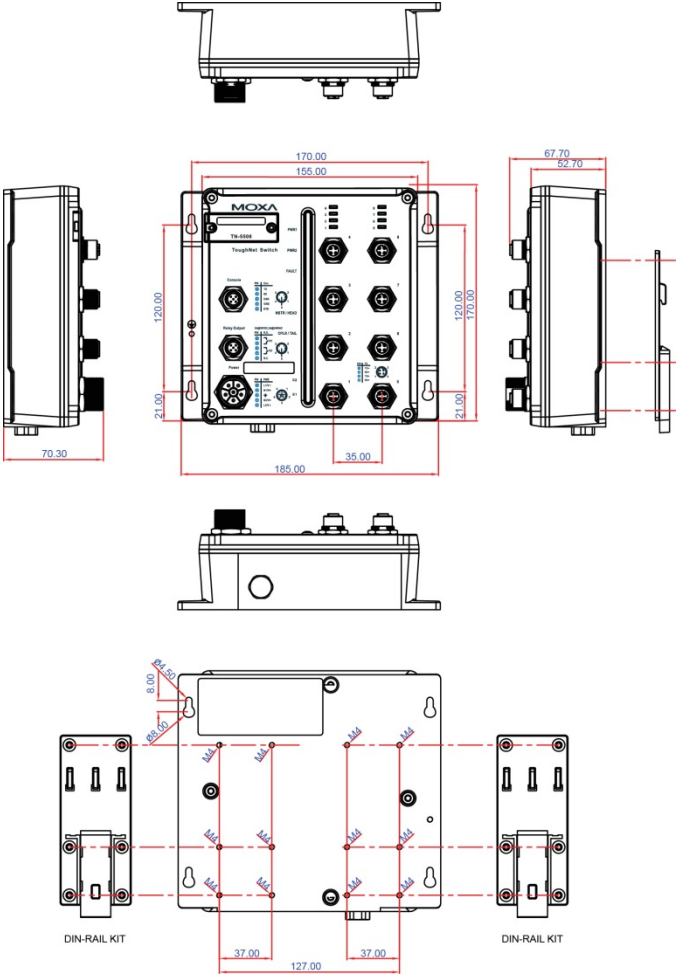





## Panel/Wall Mounting

### STEP 1:

Mounting the TN-5508/5510 to a wall requires 4 screws. Use the ToughNet switch as a guide to mark the correct positions of the 4 screws.

### STEP 2:

Use the 4 screws in the panel mounting kit. If you would like to use your own screws, make sure the screw head is **between 6.0 mm and 7.0 mm** in diameter and the shaft is less than **4.0 mm** in diameter, as shown at the right.

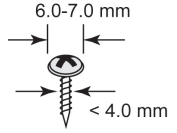

Do not screw the screws in all the way—leave a space of about 2 mm to allow room for sliding the ToughNet switch between the wall and the screws.

**NOTE** Before tightening the screws into the wall, make sure the screw head and shaft size are suitable by inserting the screw through one of the keyhole-shaped apertures of the ToughNet switch.

### STEP 3:

Once the screws are fixed in the wall, hang the ToughNet switch on the 4 screws through the large opening of the keyhole-shaped apertures, and then slide the switch downwards. Tighten the four screws for added stability.

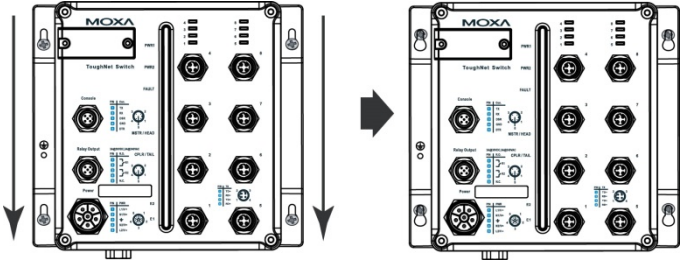

**NOTE** To provide greater protection from vibrations and shocks, use screws with shaft diameter between 6.0 mm and 7.0 mm, and fix the ToughNet switch onto the wall directly through the large opening of the keyhole-shaped apertures.

## DIN-Rail Mounting (optional)

Use a pair of optional DK-DC50131 DIN-Rail mounting kits (must be purchased separately) to mount the TN-5508/5510 on a 35 mm DIN-Rail.

### STEP 1:

Use 12 screws (6 screws per plate) to attach the two DIN-Rail attachment plates to the rear panel of the switch

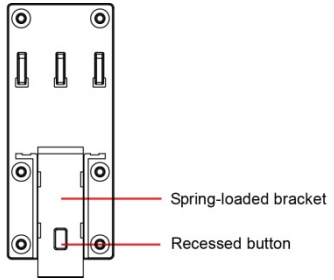

### STEP 2:

If the spring-loaded bracket is locked in place, push the recessed button to release it. Once released, you should feel some resistance from the spring as you slide the bracket up and down a few millimeters in each direction.

### STEP 3:

Insert the top of the DIN-Rail into the top slot of the DIN-Rail attachment plates.

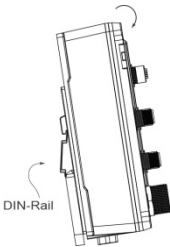

### STEP 4:

The DIN-Rail attachment plates will snap into position, as shown in the figure below.

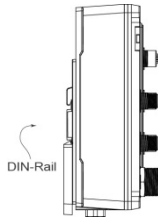

To remove the Moxa ToughNet Switch from the DIN-Rail, use a screwdriver to pull down the bottom parts of the two spring-loaded brackets until they are fixed in the "locked" position, and then reverse Steps 3 and 4 above.

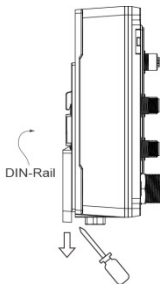

## Wiring Requirements



### WARNING

Turn the power off before disconnecting modules or wires. The correct power supply voltage is listed on the product label. Check the voltage of your power source to make sure you are using the correct voltage. Do NOT use a voltage greater than what is specified on the product label.

These devices must be supplied by a SELV source as defined in the Low Voltage Directive 2006/95/EC and 2004/108/EC.



### ATTENTION

#### **Safety First!**

Observe all electrical codes dictating the maximum current allowable for each wire size. If the current goes above the maximum ratings, the wiring could overheat, causing serious damage to your equipment.



### ATTENTION

#### **Safety First!**

Be sure to disconnect the power cord before installing and/or wiring your Moxa switch.

This device has UL508 approval. Use copper conductors only, 60/75°C, and tighten to 4.5 pound-inches. For use in pollution degree 2 environments.

Please read and follow these guidelines:

- Use separate paths to route wiring for power and devices. If power wiring and device wiring paths must cross, make sure the wires are perpendicular at the intersection point.

**NOTE** Do not run signal or communications wiring and power wiring through the same wire conduit. To avoid interference, wires with different signal characteristics should be routed separately.

- You can use the type of signal transmitted through a wire to determine which wires should be kept separate. The rule of thumb is that wiring that shares similar electrical characteristics can be bundled together.
- Keep input wiring and output wiring separated.
- It is strongly advised that you label wiring for all devices in the system when necessary.

## Grounding the ToughNet Switch

Grounding and wire routing help limit the effects of noise due to electromagnetic interference (EMI). Run the ground connection from the grounding screw to the grounding surface prior to connecting devices.

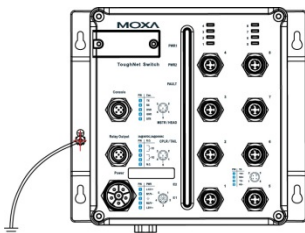

## ATTENTION

This product is intended to be mounted to a well-grounded mounting surface such as a metal panel.

## Connecting the Power Supplies

The ToughNet TN-5508/5510 switches support two sets of power supplies—power input 1 and power input 2. The M23 6-pin male connector on the TN-5508's front panel is used for the dual power inputs. Use a power cord with an M23 6-pin female connector to connect the power inputs to the switch.

### Pinouts for the power input port on the TN-5508/5510

PIN	PWR
1	L1/V+
2	N1/V-
3	⏏
4	N2/V-
5	L2/V+



### Pinouts for the power input port on the TN-5508/5510.

Pin	Description	Usage
1	PWR1 Live / DC +	Connect "PWR1 Live / DC +" to the Live terminal when using an AC power source or to the positive (+) terminal when using a DC power source.
2	PWR1 Neutral / DC -	Connect "PWR1 Neutral / DC -" to the Neutral terminal when using an AC power source or to the negative (-) terminal when using a DC power source.
3	Chassis Ground	Connect the "Chassis Ground" to the safety ground terminal for AC inputs or to the equipment ground bus for DC inputs.
4	PWR2 Neutral / DC -	Connect "PWR2 Neutral / DC -" to the Neutral terminal when using an AC power source or to the negative (-) terminal when using a DC power source.
5	PWR2 Live / DC +	Connect "PWR2 Live / DC +" to the (Live) terminal when using an AC power source or to the positive (+) terminal when using a DC power source.

**STEP 1:**

Plug your power cord's M23 connector to the power input port of the TN-5508/5510 switch.

**STEP 2:**

Screw the nut on your power cord connector to the power input connector on the switch to ensure a tight connection.

**ATTENTION**

Before connecting the TN-5508/5510 to the power input, make sure the power source voltage is stable.

**Connecting the Relay Outputs**

Each TN-5508/5510 switch has two sets of relay outputs—relay output 1 and relay output 2. The M12 A-coded 5-pin male connector on the TN-5508/5510's front panel is used for the two relay outputs. Use a power cord with an M12 A-coded 5-pin female connector to connect the relay contacts from the switch. You may purchase an M12 power cable from Moxa. The model number of the cable, which must be purchased separately, is CBL-M12 (FF5P)/OPEN-100 IP67.

**Pinouts for the relay output port on TN-5508/5510.**

PIN	R.O.
1	R1
2	
3	R2
4	
5	N.C.

*N.C.:* Not connected

**FAULT:**

The two sets of relay contacts of the M12 A-coded 5-pin male connector are used to detect user-configured events. The two wires attached to the fault contacts form an open circuit when a user-configured event is triggered. If a user-configured event does not occur, the fault circuit remains closed.

**RS-232 Connection**

The TN switch has one RS-232 (M12 5pin) console port, located on the front panel. Use M12 to DB9 console cable to connect the TN switch console port to your PC's COM port. you may than use a console terminal program, such as Moxa PComm Terminal Emulator to access the TN switch's configuration utility.

**M12 Console Port Pinouts**

PIN	Con.
1	TX
2	RX
3	DSR
4	GND
5	DTR

## Connecting the Data Lines

### 10/100BaseT(X) Ethernet Port Connection

All TN-5508/5510 models have 8 10/100BaseT(X) Ethernet ports (4-pin shielded M12 connector with D coding). The 10/100TX ports located on the TN-5508/5510 front panel are used to connect to Ethernet-enabled devices. Most users configure these ports for Auto MDI/MDI-X mode, in which case the port's pinouts are adjusted automatically depending on the type of Ethernet cable used (straight-through or cross-over), and the type of device (NIC-type or HUB/Switch-type) connected to the port.

In what follows, we give pinouts for both MDI (NIC-type) ports and MDI-X (HUB/Switch-type) ports. We also give cable wiring diagrams for straight-through and cross-over Ethernet cables.

#### Pinouts for the 10/100BaseT(X) Ports on the TN-5508/5510.

PIN	TX
1	TD+
2	RD+
3	TD-
4	RD-



#### Pinouts for the 10/100/1000BaseT(X) M12 (8-pin) Port

PIN	Con.
1	TRD <sup>3</sup> +
2	TRD <sup>4</sup> +
3	TRD <sup>4</sup> -
4	TRD <sup>1</sup> -
5	TRD <sup>2</sup> +
6	TRD <sup>1</sup> +
7	TRD <sup>3</sup> -
8	TRD <sup>2</sup> -

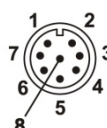

#### M12 (4-pin, M) to M12 (4-pin, M) Cross-Over Cable Wiring

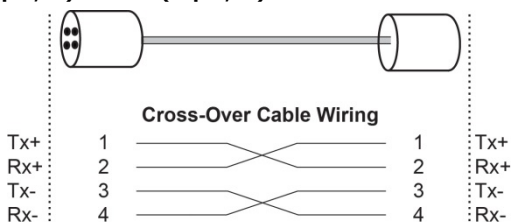

### M12 (4-pin, M) to M12 (4-pin, M) Straight-Through Cable Wiring

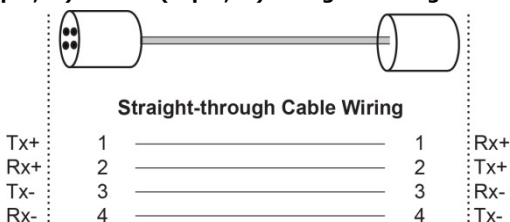

### M12 (4-pin, M) to RJ45 (8-pin) Cross-Over Cable Wiring

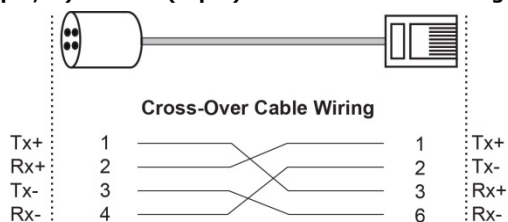

### M12 (4-pin, M) to RJ45 (8-pin) Straight-Through Cable Wiring

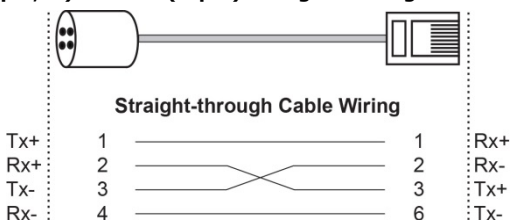

## Rotary Switch IP Address Settings

The ToughNet TN-5508/5510 switches have 3 rotary switches on the front panel for configuring the IP address without using a PC, making onsite configuration extremely convenient. This can be especially helpful when you need to replace a faulty switch quickly.

**STEP 1:** Remove the protective cover by unscrewing the 2 screws with an Allen wrench (also called an Allen key or hex key).

**STEP 2:** Use a flat-bladed screwdriver to rotate the 3 rotary switches to point to the chosen numbers.

**STEP 3:** Replace the protective cover and then tighten the screws to the proper torque.

**STEP 4:** Restart the ToughNet switch to enable the newly configured IP address.



- NOTE**
1. "Hardware-based IP configuration" only supports IPv4 address settings.
  2. "Hardware-based IP configuration" is enabled only when the 3 rotary switches are set to values ranging from 001 to 254. The ToughNet switch's IP address will be configured as "192.168.127.xxx", where "xxx" are valid value numbers set by the rotary switches.
  3. When enabled, "Hardware-based IP configuration" overrides the "Auto IP Configuration" described in the "IP Settings" section in the user's manual.
  4. Disable "Hardware-based IP configuration" by setting the 3 rotary switches to 000 (the factory default).
  5. If the rotary switch numbers are set to an invalid combination (255 to 999), the ToughNet switch will use the fixed IP address 192.168.127.253 by default.



## ATTENTION

The protective cover must be fixed properly to ensure IP54/IP67 protection. Use a torque wrench set to a torque of 4 kgf-m when tightening the screws. Note that applying a larger torque may damage the plastic protective cover.

## Bypass Relay Function

The TN-5510-2GTXBP models' two Gigabit Ethernet ports are equipped with a bypass relay function. When the switch is operating normally, these two Gigabit ports work in the same way as the other ports. That is, frame ingressions are processed and then forwarded. In the event the switch stops working due to a power failure, the bypass relay function will be triggered to ensure non-stop data communication.

The figure below illustrates the bypass relay function. For example, if Switch B loses power, then the two Gigabit ports will be bypassed through the relay circuit and the transmission line from Switch A to B and the transmission line from Switch B to C will interconnect automatically; this way there is no stoppage.

The bypass relay function helps the network recover from single-node failures in a linear topology.

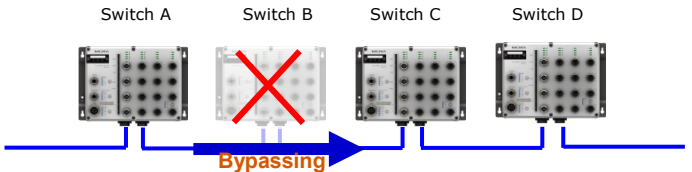

With the maximum segment length of category 5 twisted-pair cable being 100 meters, cable length must be considered when designing a network that utilizes this function. For example, the total length of the cables from Switch A to B and from B to C must be no more than 100 meters. This way, if the two adjacent nodes (switch B and C for example) encounter a power

failure, there will be no stoppage, provided that the total length of the cables A-to-B, B-to-C, and C-to-D are no more than 100 meters.

The bypass relay function works best for networks with linear topologies. ToughNet™ switches with bypass relay function are not recommended to be used in networks that employ ring topologies because network loops may occur when redundancy protocols such as RSTP or TurboRing™ are applied.

## LED Indicators

Several LED indicators are located on the ToughNet switch's front panel. The function of each LED is described in the table below.

LED	Color	State	Description
<b>System LEDs</b>			
PWR1	AMBER	ON	Power is being supplied to power input PWR1.
		OFF	Power is not being supplied to power input PWR1
PWR2	AMBER	ON	Power is being supplied to power input PWR2.
		OFF	Power is not being supplied to power input PWR2.
FAULT	RED	ON	When the corresponding PORT alarm is enabled, and a user-configured event is triggered.
		OFF	When the corresponding PORT alarm is enabled and a user-configured event is not triggered, or when the corresponding PORT alarm is disabled.
MSTR/ HEAD	GREEN	ON	When the TN switch is either the Master of this Turbo Ring, or the Head of this Turbo Chain.
		Blinking	When the TN switch is Ring Master of this Turbo Ring and the Turbo Ring is broken, or it is Chain Head of this Turbo Chain and the Turbo Chain is broken.
		OFF	When the TN switch is neither the Master of this Turbo Ring, nor the Head of this Turbo Chain.
CPLR/ TAIL	GREEN	ON	When the TN switch enables the coupling function to form a back-up path in this Turbo Ring, or it is the Tail of this Turbo Chain.
		Blinking	When the Turbo Chain is down.
		OFF	When the TN switch disables the coupling function of Turbo Ring, or it is not the Tail of the Turbo Chain.

### Ports LEDs

TP (10/100M)	AMBER	ON	TP port's 10 Mbps link is active.
		Blinking	Data is being transmitted at 10 Mbps.
		Off	TP port's 10 Mbps link is inactive.
	GREEN	On	TP port's 100 Mbps link is active.
		Blinking	Data is being transmitted at 100 Mbps.
		off	TP port's 100 Mbps link is inactive.
E1/E2 (10/100/ 1000M)	AMBER	On	TP port's 10 or 100 Mbps link is active.
		Blinking	Data is being transmitted at 10 or 100 Mbps.
		off	TP port's 10 or 100 Mbps link is inactive.
	GREEN	On	TP port's 1000 Mbps link is active.
		Blinking	Data is being transmitted at 1000 Mbps.
		off	TP port's 1000 Mbps link is inactive.

## Specifications

Technology	
Standards	IEEE 802.3 for 10BaseT IEEE 802.3u for 100BaseT(X) IEEE 802.3ab for 1000BaseT(X) (TN-5510 series only) IEEE 802.3x for Flow Control IEEE 802.1D for Spanning Tree Protocol IEEE 802.1w for Rapid STP IEEE 802.1Q for VLAN Tagging IEEE 802.1p for Class of Service IEEE 802.1X for Authentication IEEE 802.3ad for Port Trunk with LACP
Protocols	IGMP v1/v2 device, GMRP, GVRP, SNMP v1/v2C/v3, DHCP Server/Client, DHCP Option 66/67/82, BootP, TFTP, SNTP, SMTP, RARP, RMON, HTTP, HTTPS, Telnet, SSH, Syslog, LLDP, IEEE 1588 PTP, Modbus/TCP, IPv6
MIB	MIB-II, Ethernet-like MIB, P-BRIDGE MIB, Q-BRIDGE MIB, Bridge MIB, RSTP MIB, RMON MIB Group 1, 2, 3, 9
Flow Control	IEEE802.3x flow control, back pressure flow control
Switch Properties	
Priority Queues	4
Max. Number of Available VLANs	64
VLAN ID Range	VID 1 to 4094
IGMP Groups	256

<b>Interface</b>	
Fast Ethernet	Front cabling, M12 connector, 10/100BaseT(X) auto negotiation speed, F/H duplex mode, and auto MDI/MDI-X connection
Gigabit Ethernet	Down cabling, M12 connector, 10/100/1000BaseT(X) auto negotiation speed, F/H duplex mode, auto MDI/MDI-X connection, with or without bypass relay function
Console Port	M12 A-coding 5-pin male connector
System LED Indicators	PWR1, PWR2, FAULT, MSTR/HEAD, CPLR/TAIL
Port LED Indicators	10/100M (fast Ethernet port), 10/100/1000M (Gigabit Ethernet port)
Alarm Contact	Two relay outputs in one M12 A-coding 5-pin male connector with current carrying capacity of 3 A @ 30 VDC or 3 A @ 240 VAC
Rotary Switches	For setting the last 3 digits of the IP address
<b>Power Requirements</b>	
Input Voltage	LV: 12/24/36/48 VDC (8.4 to 60 VDC) MV: 72/96/110 VDC (50.4 to 154 VDC) HV: 110/220 VDC/VAC (88 to 300 VDC, 85 to 264 VAC)
Input Current	TN-5508 Series: 0.234 A @ 24 VDC, 0.104 A @ 72 VDC, 0.072 A @ 110 VDC, 0.18 A @ 110 VAC, 0.12 A @ 220 VAC TN-5510-2GTX Series: 0.416A@24VDC, 0.187A@72VDC, 0.129A@110VDC, 0.316@A110VAC, 0.208A@220VAC TN-5510-2GTXBP Series: 0.52@24VDC, 0.218A@72VDC, 0.150A@11VDC, 0.369A@110VAC, 0.243A@220VAC
Connection	M23, 6-pin male connector
Overload Current Protection	Present
Reverse Polarity Protection	Present
<b>Physical Characteristics</b>	
Housing	Metal, IP54 protection (with protective caps on unused ports)
Dimensions (W × H × D)	TN-5508 Series: 185 x 170 x 69.8 mm (7.28 x 6.69 x 2.75 in) TN-5510 Series: 185 x 183 x 69.8 mm (7.28 x 7.20 x 2.75 in)
Weight	TN-5508 Series: 1650g TN-5510 Series: 1700g
Installation	Panel mounting, DIN-Rail mounting (with optional kit)
<b>Environmental Limits</b>	
Operating Temperature	Standard Models: -25 to 60°C (-13 to 140°F) Wide Temp. Models: -40 to 75°C (-40 to 167°F)
Storage Temperature	-40 to 85°C (-40 to 185°F)
Operating Humidity	5 to 95% (non-condensing)

<b>Regulatory Approvals</b>	
Safety	UL508
Rail Traffic	EN50155, EN50121-3-2, EN50121-4
Road Traffic	NEMA TS2 (Pending), e-Mark (Pending)
EMI	FCC Part 15, CISPR (EN55022) class A
EMS	EN61000-4-2 (ESD), level 3 EN61000-4-3 (RS), level 4 EN61000-4-4 (EFT), level 3 EN61000-4-5 (Surge), level 3 EN61000-4-6 (CS), level 3 EN61000-4-8 EN61000-4-11 EN61000-4-12
Shock	IEC61373
Freefall	IEC60068-2-32
Vibration	IEC61373
<b>Note:</b> Please check Moxa's website for the most up-to-date certification status.	
WARRANTY	5 years Details: See <a href="http://www.moxa.com/warranty">www.moxa.com/warranty</a>

**Technical Support Contact Information**  
**[www.moxa.com/support](http://www.moxa.com/support)**

Moxa Americas:

Toll-free: 1-888-669-2872

Tel: 1-714-528-6777

Fax: 1-714-528-6778

Moxa China (Shanghai office):

Toll-free: 800-820-5036

Tel: +86-21-5258-9955

Fax: +86-21-5258-5505

Moxa Europe:

Tel: +49-89-3 70 03 99-0

Fax: +49-89-3 70 03 99-99

Moxa Asia-Pacific:

Tel: +886-2-8919-1230

Fax: +886-2-8919-1231