

# UC-8112-ME-T Series Hardware User's Manual

---

Edition 2.1, February 2018

[www.moxa.com/product](http://www.moxa.com/product)



© 2018 Moxa Inc. All rights reserved.

# UC-8112-ME-T Series Hardware User's Manual

The software described in this manual is furnished under a license agreement and may be used only in accordance with the terms of that agreement.

## Copyright Notice

© 2018 Moxa Inc. All rights reserved.

## Trademarks

The MOXA logo is a registered trademark of Moxa Inc.  
All other trademarks or registered marks in this manual belong to their respective manufacturers.

## Disclaimer

Information in this document is subject to change without notice and does not represent a commitment on the part of Moxa.

Moxa provides this document as is, without warranty of any kind, either expressed or implied, including, but not limited to, its particular purpose. Moxa reserves the right to make improvements and/or changes to this manual, or to the products and/or the programs described in this manual, at any time.

Information provided in this manual is intended to be accurate and reliable. However, Moxa assumes no responsibility for its use, or for any infringements on the rights of third parties that may result from its use.

This product might include unintentional technical or typographical errors. Changes are periodically made to the information herein to correct such errors, and these changes are incorporated into new editions of the publication.

## Technical Support Contact Information

[www.moxa.com/support](http://www.moxa.com/support)

### Moxa Americas

Toll-free: 1-888-669-2872  
Tel: +1-714-528-6777  
Fax: +1-714-528-6778

### Moxa Europe

Tel: +49-89-3 70 03 99-0  
Fax: +49-89-3 70 03 99-99

### Moxa India

Tel: +91-80-4172-9088  
Fax: +91-80-4132-1045

### Moxa China (Shanghai office)

Toll-free: 800-820-5036  
Tel: +86-21-5258-9955  
Fax: +86-21-5258-5505

### Moxa Asia-Pacific

Tel: +886-2-8919-1230  
Fax: +886-2-8919-1231

# Table of Contents

<b>1. Introduction</b> .....	<b>1-1</b>
Overview .....	1-2
Model Descriptions.....	1-2
Package Checklist .....	1-2
Product Features .....	1-2
Hardware Specifications .....	1-3
Hardware Block Diagram .....	1-4
<b>2. Hardware Introduction</b> .....	<b>2-1</b>
Appearance.....	2-2
LED Indicators.....	2-3
Default Programmable Button Operations .....	2-3
Diagnosing Device and Subsystem Failures.....	2-4
Reset to Factory Default .....	2-4
Real-Time Clock .....	2-4
Placement Options .....	2-5
DIN-Rail Mounting.....	2-5
Wall Mounting (Optional).....	2-6
<b>3. Hardware Connection Description</b> .....	<b>3-1</b>
Wiring Requirements.....	3-2
Connecting the Power .....	3-2
Grounding the Unit .....	3-2
Connecting to the Console Port.....	3-3
Connecting to the Network.....	3-3
Connecting to a Serial Device.....	3-4
Inserting the SD and SIM Card .....	3-4
USB Port.....	3-4
Installing the Cellular Module .....	3-5
<b>A. Regulatory Approval Statements</b> .....	<b>A-1</b>

# Introduction

---

The UC-8112-ME-T series computing platform is designed for embedded data acquisition applications. The computer comes with two RS-232/422/485 serial ports and dual 10/100 Mbps Ethernet LAN ports, as well as a Mini PCIe socket to support cellular modules. These versatile communication capabilities let users efficiently adapt the UC-8112-ME-T to a variety of complex communications solutions.

The following topics are covered in this chapter:

- ❑ **Overview**
- ❑ **Model Descriptions**
- ❑ **Package Checklist**
- ❑ **Product Features**
- ❑ **Hardware Specifications**
- ❑ **Hardware Block Diagram**

# Overview

The UC-8112-ME-T is built around an ARMv7 Cortex-A8 RISC processor that has been optimized for use in energy monitoring systems, but is widely applicable to a variety of industrial solutions. With flexible interfacing options, this compact embedded computer is a reliable and secure gateway for data acquisition and data processing at field sites as well as a useful communication platform for many other large-scale deployments.

## Model Descriptions

The UC-8112-ME-T series includes the following models:

- **UC-8112-ME-T-LX:** RISC-based platform with 1 GHz CPU, 512 MB RAM, Mini PCIe socket for cellular connectivity, 2 Ethernet ports, 2 serial ports, 4 GB eMMC flash, USB port, SD-card socket, and Debian ARM
- **UC-8112-ME-T-LX1:** RISC-based platform with 1 GHz CPU, 1 GB RAM, Mini PCIe socket for cellular connectivity, 2 Ethernet ports, 2 serial ports, 4 GB eMMC flash, USB port, SD-card socket, and Debian ARM
- **UC-8112-ME-T-LX-US-LTE:** RISC-based platform with 1 GHz CPU, 512 MB RAM, 4 GB eMMC flash, Mini PCIe socket for cellular connectivity (with cellular module for North America built in), 2 Ethernet ports, 2 serial ports, USB port, and Debian ARM
- **UC-8112-ME-T-US-LTE-LX1:** RISC-based platform with 1 GHz CPU, 1 GB RAM, 4 GB eMMC flash, Mini PCIe socket for cellular connectivity (with cellular module for North America built in), 2 Ethernet ports, 2 serial ports, USB port, and Debian ARM

## Package Checklist

Before installing the UC-8112-ME-T, verify that the package contains the following items:

- UC-8112-ME-T embedded computer
- Power jack
- Quick installation guide (printed)
- Warranty card

*NOTE: Notify your sales representative if any of the above items are missing or damaged.*

## Product Features

- ARMv7 Cortex-A8 1000 MHz processor
- Dual auto-sensing 10/100 Mbps Ethernet ports
- SD socket for storage expansion and OS installation
- Programmable LEDs and a programmable button for easy installation and maintenance
- Mini PCIe socket for cellular module
- -40°C to 70°C wide temperature range with LTE enabled

# Hardware Specifications

## Computer

**CPU:** ARMv7 Cortex-A8 1000 MHz

**USB:** USB 2.0 host x 1 (type A connector)

**DRAM:** 512 MB DDR3 SDRAM

## Storage

### Storage Expansion:

- SDHC/SDXC socket for storing OS and storage expansion
- 4 GB eMMC flash with OS pre-installed

## Ethernet Interface

**LAN:** 2 auto-sensing 10/100 Mbps ports (RJ45)

**Magnetic Isolation Protection:** 1.5 kV built-in

## Serial Interface

**Serial Standards:** 2 RS-232/422/485 ports, software-selectable (5-pin terminal block connector)

**Console Port:** RS-232 (TxD, RxD, GND), 4-pin pin header output (115200, n, 8, 1)

## Serial Communication Parameters

**Data Bits:** 5, 6, 7, 8

**Stop Bits:** 1, 1.5, 2

**Parity:** None, Even, Odd, Space, Mark

**Flow Control:** XON/XOFF, ADDC® (automatic data direction control) for RS-485

**Baudrate:** Max. 921600 bps

## Serial Signals

**RS-232:** TxD, RxD, RTS, CTS, GND

**RS-422:** TxD+, TxD-, RxD+, RxD-, GND

**RS-485-4w:** TxD+, TxD-, RxD+, RxD-, GND

**RS-485-2w:** Data+, Data-, GND

## LEDs

**System:** Power x 1, USB x 1, SD x 1, and signal strength x 3

**LAN:** 10M/100M on connector

**Programmable:** Diagnosis x 3

## Switches and Buttons

**Push Button:** Initially configured to return a diagnostic report, and to reset the device to factory defaults

## Physical Characteristics

**Housing:** Metal

### Weight:

- UC-8112-ME-T-LX: 530 g (1.18 lb)
- UC-8112-ME-T-LX-US: 590 g (1.31 lb)

**Dimensions:** 141 x 119.9 x 36 mm (5.56 x 4.72 x 1.42 in)

**Mounting:** DIN rail, wall mount (optional)

## Environmental Limits

### Operating Temperature:

Wide Temp. Models: -40 to 85°C (-40 to 185°F)

Wide Temp. models (with LTE accessory): -40 to 70°C (-40 to 158°F)

**Storage Temperature:** -40 to 85°C (-40 to 185°F)

**Ambient Relative Humidity:** 5 to 95% (non-condensing)

**Anti-Vibration:** 2 Grms @ IEC 60068-2-64, random wave, 5-500 Hz, 1 hr per axis (without any USB devices attached)

**Anti-Shock:** 20 g @ IEC 60068-2-27, half sine wave, 30 ms

**Power Requirements**

**Input Voltage:** 12 to 36 VDC (3-pin terminal block, V+, V-, SG)

**Input Current:** 500 mA @ 12 VDC

**Power Consumption:** 6 W (without cellular module and external USB device attached)

**Standards and Certifications**

**Safety:** UL 60950-1

**EMC:** EN 55032/24

**Green Product:** RoHS, CRoHS, WEEE

**Reliability**

**Alert Tools:** External RTC (real-time clock)

**Automatic Reboot Trigger:** External WDT (watchdog timer)

**Warranty**

**Warranty Period:** 5 years

**Details:** See [www.moxa.com/warranty](http://www.moxa.com/warranty)

## Hardware Block Diagram

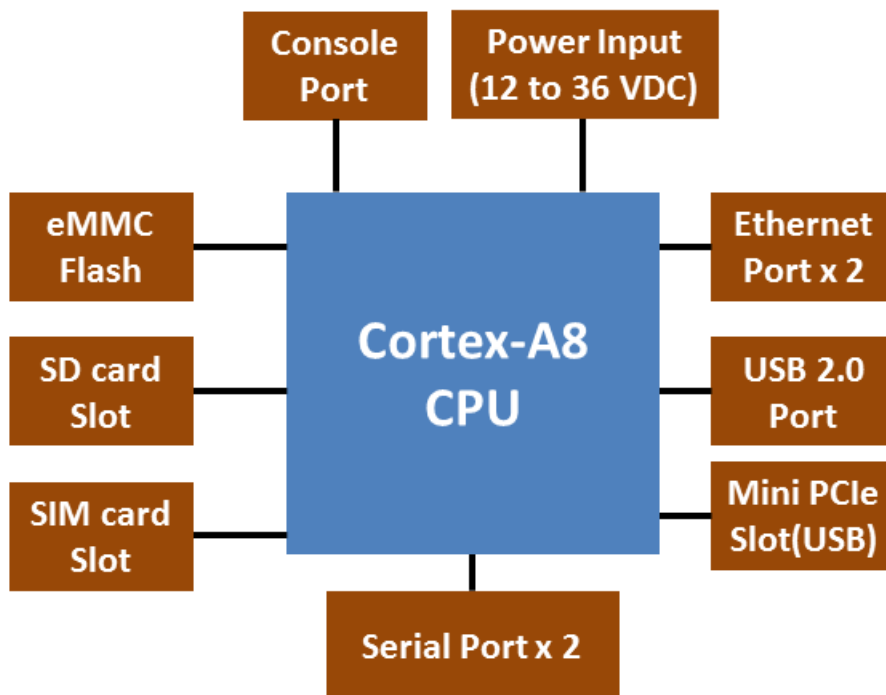

## Hardware Introduction

---

The UC-8112-ME-T embedded computers are compact and rugged making them suitable for industrial applications. The LED indicators help in monitoring performance and troubleshooting issues. The multiple ports provided on the computer can be used to connect to a variety of devices. The UC-8112-ME-T comes with a reliable and stable hardware platform that lets you devote the bulk of your time to application development. In this chapter, we provide basic information about the embedded computer's hardware and its various components.

The following topics are covered in this chapter:

- ❑ **Appearance**
- ❑ **LED Indicators**
- ❑ **Default Programmable Button Operations**
  - Diagnosing Device and Subsystem Failures
- ❑ **Reset to Factory Default**
- ❑ **Real-Time Clock**
- ❑ **Placement Options**
  - DIN-Rail Mounting
  - Wall Mounting (Optional)



# Appearance

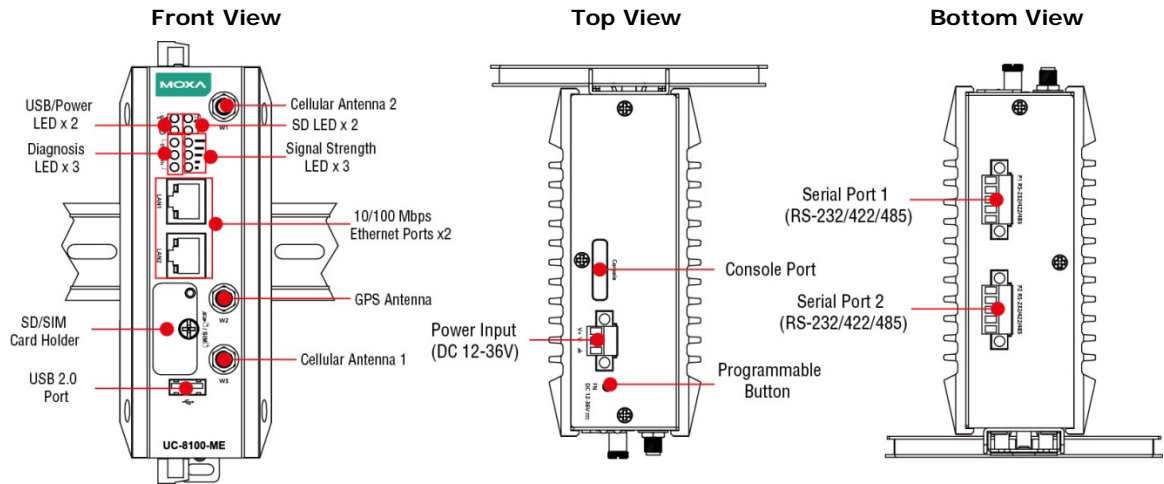



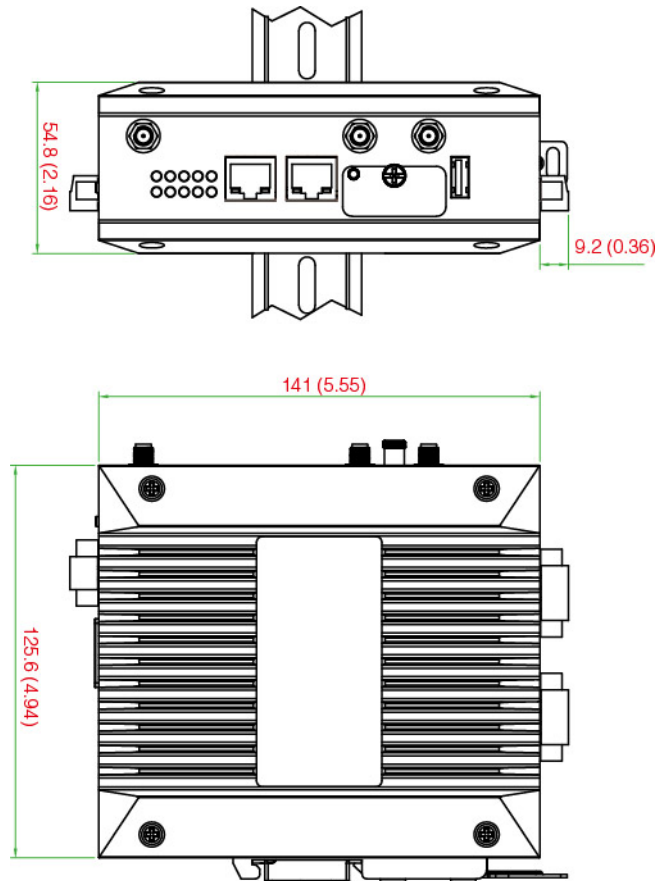



## Dimensions [units: mm (in)]



# LED Indicators

Refer to the following table for information about each LED.

LED Name		Color	Function	
	USB	Green	Steady On	USB device is connected and working normally.
			Off	USB device is not connected.
	SD	Green	Steady On	SD Card inserted and working normally.
			Off	SD Card is not detected.
	Power	Green	Power is on and the computer is working normally.	
		Off	Power is off.	
	LAN1/2 (On RJ45 connector)	Green	Steady On	100 Mbps Ethernet link
			Blinking	Data transmission in progress.
		Yellow	Steady On	10 Mbps Ethernet link
			Blinking	Data transmission in progress.
	Wireless Signal Strength	Green	The number of glowing LEDs indicates the signal strength 3 (Green + Yellow + Red): Excellent 2 (Yellow + Red) : Good 1 (Red) : Poor	
		Yellow		
Red				
Off	Wireless module is not detected.			
	Programmable Diagnostic LEDs	Green Yellow Red	These 3 LEDs are programmable. Refer to the "Default Programmable Button Operations" section for details.	

## Default Programmable Button Operations

The function button (FN) located on the top panel is used to diagnose device failure or to perform firmware restoration. After pressing the button, release it at the appropriate time to enter the required mode to either troubleshoot issues in your computer or restore your computer to the default configuration. Refer to the following illustration for detailed instructions:

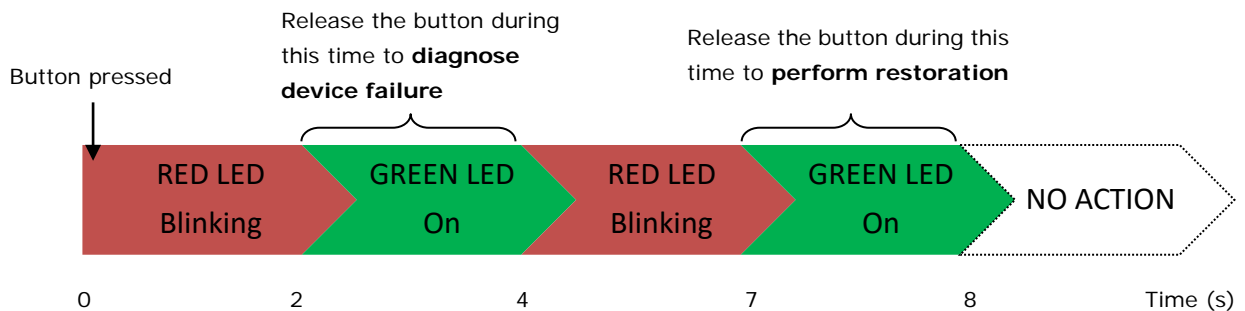

The LED indicators behave differently when diagnosing a device failure compared to performing a firmware restoration. See the following table for details:

Status	Red LED	Yellow LED	Green LED
Executing diagnostics program	Blinking	Off	On
Resetting to default configuration	Blinking	Blinking	On

## Diagnosing Device and Subsystem Failures

The red LED will start blinking once you press the function button (**FN**). Keep the button pressed until the green LED is lit for the first time and then release the button to enter diagnostic mode to check which peripherals are available on the UC-8112-ME-T-LX. When the diagnostic program is running, the red LED will blink.

Status	Red LED	Yellow LED	Green LED
Diagnostics program is executing	Blinking	Off	On

The following two tables describe the diagnostics results related to hardware defects and system operation.

### Hardware Defects

If you observe any of these hardware issues, contact Moxa Support for further instructions.

Status	Red LED	Yellow LED	Green LED
UART1 device issue	On	On	Off
UART2 device issue	On	On	Blinking
LAN 1 device issue	On	Off	Off
LAN 2 device issue	On	Off	Blinking
Button device issue	On	Blinking	Off
TPM device issue	On	Blinking	Blinking
LED device issue	On	Off	Off

### System Operation

If you observe any of the following issues, check the item indicated by the LEDs.

Status	Red LED	Yellow LED	Green LED
CPU usage (over 90%)	Blinking	On	Off
RAM usage (over 90%)	Off	On	Off
Disk usage (over 90%)	Off	On	Blinking
File system corrupted	Blinking	On	Blinking

## Reset to Factory Default

Press and hold the function button (**FN**) continuously for at least 5 seconds to load the factory default configuration. After the factory default configuration has been loaded, the system will reboot automatically. The **Power** LED will blink on and off for the first 5 seconds, and then maintain a steady glow once the system has rebooted.

We recommend that you only use this function if the software is not working properly and you want to load factory default settings. The **Reset to Default** functionality is not designed to hard reboot the UC-8112-ME-T.



### ATTENTION

**Reset to Default will erase all the data stored on the boot storage**

Please back up your files before resetting the system to the factory default configuration. All the data stored in the UC-8112-ME-T's boot storage will be erased when it is reset to the factory default configuration.

## Real-Time Clock

The UC-8112-ME-T's real-time clock is powered by a lithium battery. We strongly recommend that you do not replace the lithium battery without help from a qualified Moxa support engineer. If you need to change the battery, contact the Moxa RMA service team.

**WARNING**

There is a risk of explosion if the battery is replaced with an incorrect battery type.

## Placement Options

There are two sliders on the back of the unit for DIN rail and wall mounting.

### DIN-Rail Mounting

1. The DIN-rail mounting kit is mounted by default as shown in the figure below.

**NOTE** Test the screw head and shank size by inserting the screw into one of the keyhole shaped apertures of the wall-mounting plates before attaching the plate to the wall.

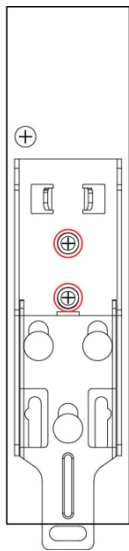

2. Pull down the bottom slider of the DIN-rail bracket located at the back of the unit
3. Insert the top of the DIN rail into the slot just below the upper hook of the DIN-rail bracket.
4. Latch the unit firmly on to the DIN rail as shown in the illustrations below.
5. Push the slider back into place.

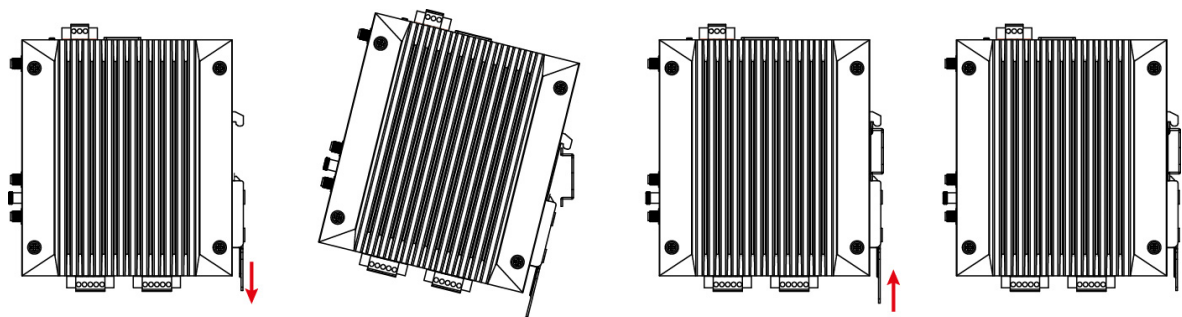

## Wall Mounting (Optional)

1. Remove the four screws on the side-panel silver cover of the device



2. Place the wall-mount brackets on the silver cover and fasten the screws as shown below. Use only the screws provided in the wall-mounting kit package.



### ATTENTION

The wall-mounting kit is not included in the package and must be purchased separately.

# Hardware Connection Description

---

This section describes how to connect the UC-8112-ME-T to a network and connect various devices to the UC-8112-ME-T.

The following topics are covered in this chapter:

- ❑ **Wiring Requirements**
  - Connecting the Power
  - Grounding the Unit
- ❑ **Connecting to the Console Port**
- ❑ **Connecting to the Network**
- ❑ **Connecting to a Serial Device**
- ❑ **Inserting the SD and SIM Card**
- ❑ **USB Port**
- ❑ **Installing the Cellular Module**

## Wiring Requirements

In this section, we describe how to connect various devices to the embedded computer. You must pay attention to the following common safety precautions, before proceeding with the installation of any electronic device:

- Use separate paths to route wiring for power and devices. If power wiring and device wiring paths must cross, make sure the wires are perpendicular at the intersection point.  
**NOTE:** Do not run the wires for signal or communication and power wiring in the same wire conduit. To avoid interference, wires with different signal characteristics should be routed separately.
- You can use the type of signal transmitted through a wire to determine which wires should be kept separate. The rule of thumb is that wiring that shares similar electrical characteristics can be bundled together.
- Keep input wiring and output wiring separate.
- We strongly advise that you label wiring to all devices in the system for easy identification.



### ATTENTION

#### Safety First!

Be sure to disconnect the power cord before installing and/or wiring the computer.

#### Electrical Current Caution!

Calculate the maximum possible current in each power wire and common wire. Observe all electrical codes dictating the maximum current allowable for each wire size.

If the current goes above the maximum ratings, the wiring could overheat, causing serious damage to your equipment.

#### Temperature Caution!

Be careful when handling the unit. When the unit is plugged in, the internal components generate heat, and consequently the outer casing may be hot to touch by hand.

## Connecting the Power

### Terminal Block

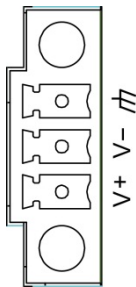

The UC-8112-ME-T has a 3-pin terminal block for a 12 to 36 VDC power input.

The figure shows how the power input interface connects to external power sources. If the power is properly supplied, the Power LED will light up. The Power LED will glow a solid green color when the operating system is ready (it may take 30 to 60 seconds for the operating system to boot up).



### ATTENTION

This product is intended to be supplied by a Listed Power Supply Unit that is rated to deliver 12 to 36 VDC at a minimum of 500 mA @ 12 VDCC.

## Grounding the Unit

Grounding and wire routing help limit the effects of noise due to electromagnetic interference (EMI). Run the ground connection from the ground screw to the grounding surface prior to connecting devices to the computer.



**ATTENTION**

This product is intended to be mounted to a well-grounded mounting surface, such as a metal panel.

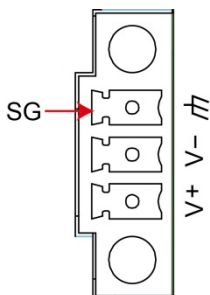

SG: The Shielded Ground (sometimes called Protected Ground) contact is the bottom contact of the 3-pin power terminal block connector when viewed from the angle shown here. Connect the SG wire to an appropriate grounded metal surface.



**ATTENTION**

A shielded power cord is required to meet FCC emission limits and also to prevent interference with nearby radio and television reception. It is essential that only the supplied power cord be used.

You are cautioned that changes or modifications not expressly approved by the party responsible for compliance could void your authority to operate the equipment.

## Connecting to the Console Port

The UC-8112-ME-T is provided with a 4-pin pin-header RS-232 console port, which is located on the top panel. This port is designed for connecting serial console terminals, which you can use to view the boot up messages, and to troubleshoot when the system does not boot up.

Serial Console Port & Pinouts		Serial Console Cable										
	<table border="1"> <thead> <tr> <th>Pin</th> <th>Signal</th> </tr> </thead> <tbody> <tr> <td>1</td> <td>TxD</td> </tr> <tr> <td>2</td> <td>RxD</td> </tr> <tr> <td>3</td> <td>NC</td> </tr> <tr> <td>4</td> <td>GND</td> </tr> </tbody> </table>	Pin	Signal	1	TxD	2	RxD	3	NC	4	GND	
Pin	Signal											
1	TxD											
2	RxD											
3	NC											
4	GND											

## Connecting to the Network

Connect one end of the Ethernet cable to one of the UC-8112-ME-T's 10/100M Ethernet ports (8-pin RJ45) and the other end of the cable to the Ethernet network. If the cable is properly connected, the UC-8112-ME-T will indicate a valid connection to the Ethernet in the following ways:

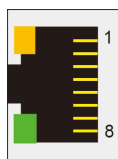

The LED indicator in the lower right corner glows a solid green color when the cable is properly connected to a 100 Mbps Ethernet network. The LED will flash on and off when Ethernet packets are being transmitted or received.

The LED indicator in the upper right corner glows a solid orange color when the cable is properly connected to a 10 Mbps Ethernet network. The LED will flash on and off when Ethernet packets are being transmitted or received.

Pin	Signal
1	ETx+
2	ETx-
3	ERx+
4	–
5	–
6	ERx-
7	–
8	–



# Connecting to a Serial Device

Use certified serial cables to connect the UC-8112-ME-T to serial devices. The serial ports of the UC-8112-ME-T use the 5-pin terminal block. The ports can be configured by software for RS-232, RS-422, or 2-wire RS-485. The pin assignments are shown in the following table:

Terminal Block

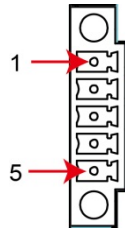

RS-232/422/485 Pinouts

Pin	RS-232	RS-422	RS-485
1	TXD	TXD+	–
2	RXD	TXD-	–
3	RTS	RXD+	D+
4	CTS	RXD-	D-
5	GND	GND	GND

# Inserting the SD and SIM Card

The UC-8112-ME-T comes with an SD-card socket for storage expansion, and a SIM-card socket that can be used to install a SIM card for cellular communication. The SD card/SIM card sockets are located on the lower part of the front panel. To install the cards, remove the screw and the protection cover to access the sockets, and then plug the SD card and the SIM card into the sockets directly. Remember to push in on the SD card or SIM card first if you want to remove them.

The SD card will be mounted at: `/mnt/sd`

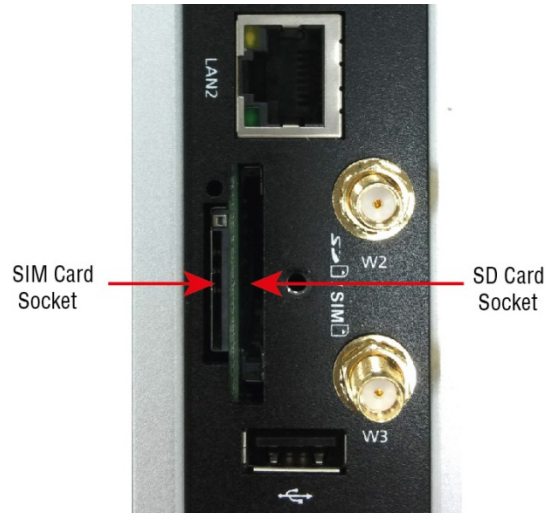



**ATTENTION**

The UC-8112-ME-T does not support SD-card hot swap or PnP (Plug and Play) functionality. You must disconnect the power source to the computer before you insert or remove the SD card.

# USB Port

The UC-8112-ME-T is provided with 1 USB 2.0 full speed port (OHCI), type A connector, which supports a keyboard or mouse, as well as an external flash disk for storing data.

# Installing the Cellular Module

The UC-8112-ME-T is provided with a PCIe socket for installing a cellular module. To install the cellular module, do the following:

1. Remove the four screws on the DIN-rail mounting kit.
2. Remove the two screws on the rear panel kit.



3. Remove the four screws on the silver cover on the right panel and take off the cover.
4. Remove the screw on metal cover.

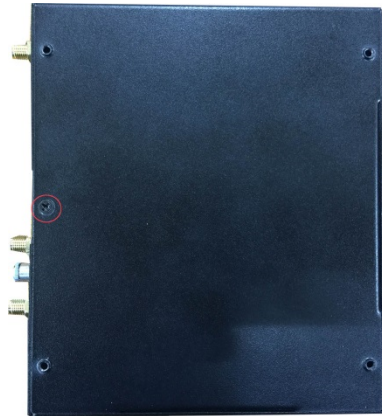

5. Remove the three screws on the top panel.
6. Remove the two screws on the bottom panel.



7. Check the contents of the cellular module package. The package should contain the items shown below:

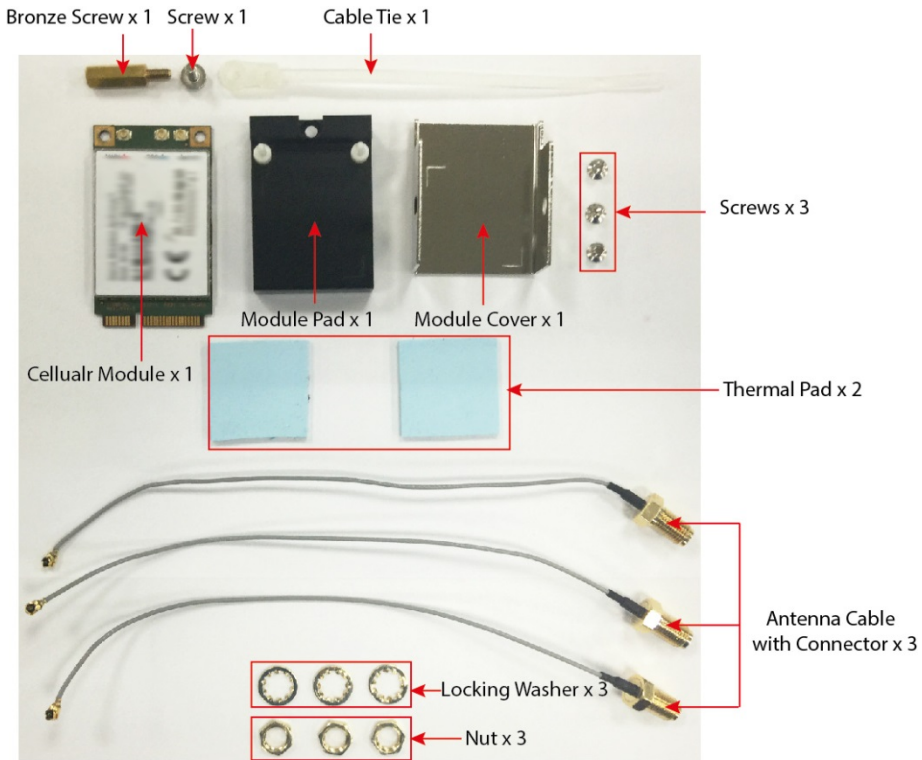

8. Remove the metal cover of the computer and locate the cellular module socket.

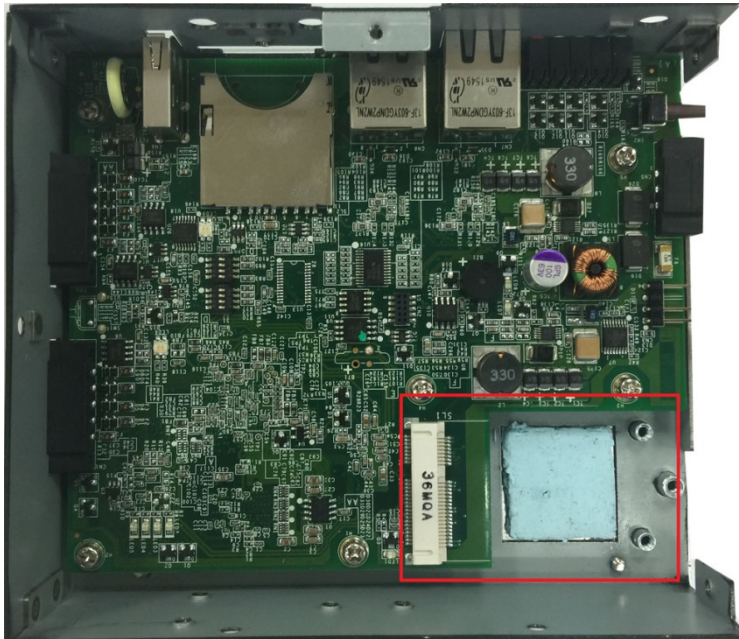

9. Remove the screw next to the socket and replace it with the bronze screw (in the package) as shown below:

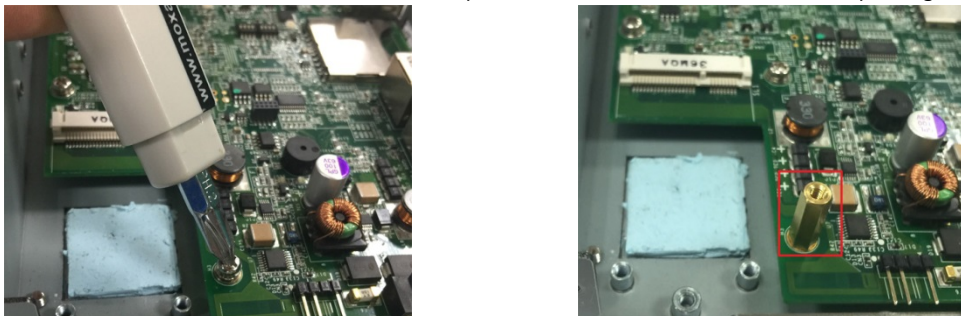

10. Attach one thermal pad to the cellular module cover and the other thermal pad to the module pad.

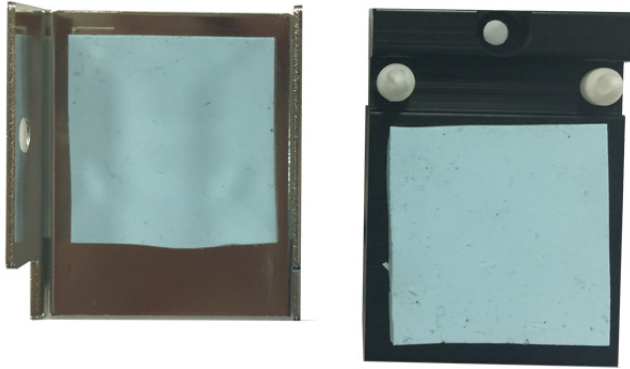

11. Attach the cellular module to the module pad.

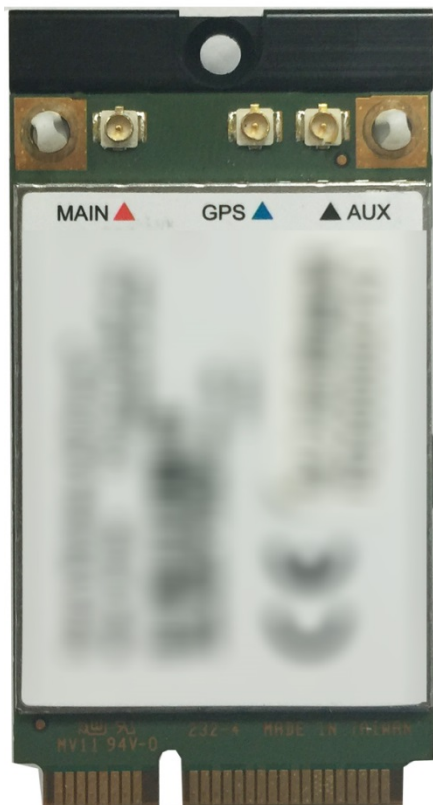

12. Mount the module cover on the cellular module and use screws on both sides to secure the cover.



- 13. Insert the module into the socket and secure it using a screw from the package.

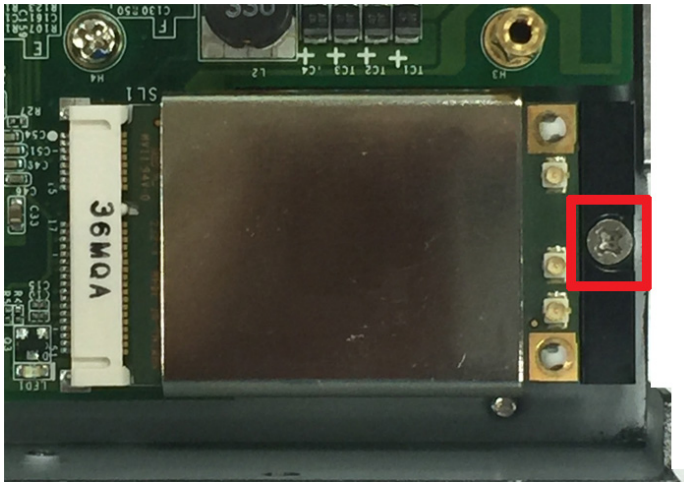

- 14. Connect antenna cables to the cellular module. There are three antenna connectors on the cellular module: W1 and W3 are for cellular antennas and W2 is for GPS antenna.



- 15. Insert the antenna connectors through the antenna cable holes on the front panel of the cover as shown below:

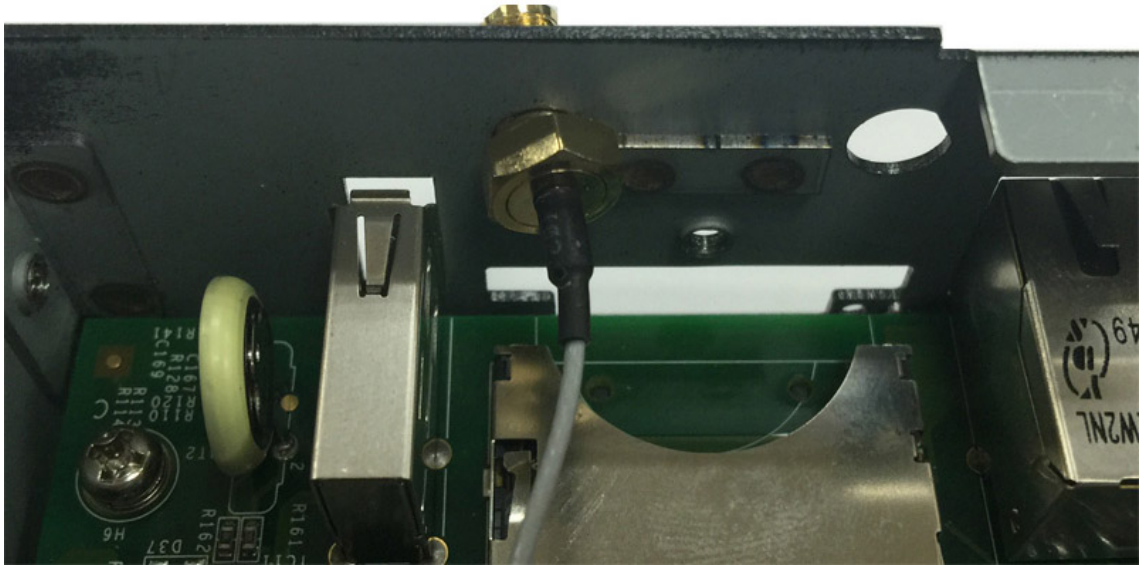

- 16. Secure the antenna connectors to the cover using a locking washer and nut as shown below:

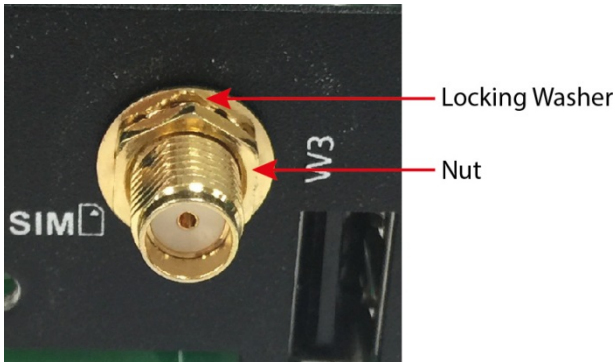

- 17. Arrange the antenna cables and use a cable tie to attach the cables to the bronze screw. You may cut the cable tie if it is too long.

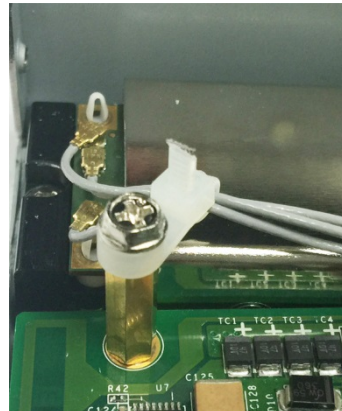
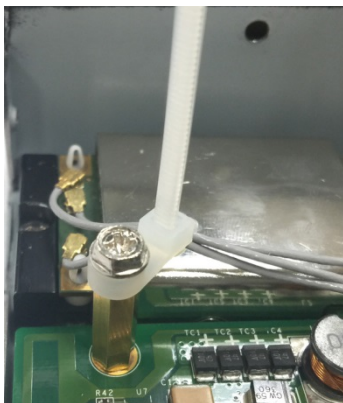

18. Plug the antenna onto the connector.



19. Replace the cover of the computer and fasten the screws to secure the cover.

# A

## Regulatory Approval Statements

---



This device complies with part 15 of the FCC Rules. Operation is subject to the following two conditions: (1) This device may not cause harmful interference, and (2) this device must accept any interference received, including interference that may cause undesired operation.

**Class A:** FCC Warning! This equipment has been tested and found to comply with the limits for a Class A digital device, pursuant to part 15 of the FCC Rules. These limits are designed to provide reasonable protection against harmful interference when the equipment is operated in a commercial environment. This equipment generates, uses, and can radiate radio frequency energy and, if not installed and used in accordance with the instruction manual, may cause harmful interference to radio communications. Operation of this equipment in a residential area is likely to cause harmful interference in which case the users will be required to correct the interference at their own expense.



European Community



### WARNING

This is a class A product. In a domestic environment this product may cause radio interference in which case the user may be required to take adequate measures.