

UC-8410A Series Linux Software User's Manual

Edition 2.0, July 2018

www.moxa.com/product



© 2018 Moxa Inc. All rights reserved.

UC-8410A Series Linux Software User's Manual

The software described in this manual is furnished under a license agreement and may be used only in accordance with the terms of that agreement.

Copyright Notice

© 2018 Moxa Inc. All rights reserved.

Trademarks

The MOXA logo is a registered trademark of Moxa Inc.
All other trademarks or registered marks in this manual belong to their respective manufacturers.

Disclaimer

Information in this document is subject to change without notice and does not represent a commitment on the part of Moxa.

Moxa provides this document as is, without warranty of any kind, either expressed or implied, including, but not limited to, its particular purpose. Moxa reserves the right to make improvements and/or changes to this manual, or to the products and/or the programs described in this manual, at any time.

Information provided in this manual is intended to be accurate and reliable. However, Moxa assumes no responsibility for its use, or for any infringements on the rights of third parties that may result from its use.

This product might include unintentional technical or typographical errors. Changes are periodically made to the information herein to correct such errors, and these changes are incorporated into new editions of the publication.

Technical Support Contact Information

www.moxa.com/support

Moxa Americas

Toll-free: 1-888-669-2872
Tel: +1-714-528-6777
Fax: +1-714-528-6778

Moxa Europe

Tel: +49-89-3 70 03 99-0
Fax: +49-89-3 70 03 99-99

Moxa India

Tel: +91-80-4172-9088
Fax: +91-80-4132-1045

Moxa China (Shanghai office)

Toll-free: 800-820-5036
Tel: +86-21-5258-9955
Fax: +86-21-5258-5505

Moxa Asia-Pacific

Tel: +886-2-8919-1230
Fax: +886-2-8919-1231

Table of Contents

1. Introduction.....	1-1
2. Getting Started.....	2-1
Software Architecture.....	2-2
Software Packages.....	2-2
Connecting to the UC-8410A-LX	2-2
Connecting Through the Serial Console	2-3
SSH Console.....	2-5
User Account Management.....	2-7
Switching to the Root Account	2-7
Creating and Deleting User Accounts.....	2-7
Disabling the Default User Account	2-7
Network Settings	2-8
Configuring Ethernet Interfaces.....	2-8
Connecting to a Cellular Network.....	2-9
System Administration	2-9
Querying the Firmware Version	2-9
Adjusting the Time	2-10
Setting the Time Zone	2-10
Determining Available Drive Space.....	2-12
Enabling and Disabling Daemons	2-12
Package Management.....	2-13
Reboot/Shutdown of the UC-8410A-LX.....	2-14
3. Advanced Configuration of Peripherals	3-1
Serial Ports	3-2
stty	3-2
USB Port.....	3-3
Disabling the USB Port.....	3-3
USB Automount	3-4
SD Slot.....	3-4
Firmware Update	3-4
Firmware Update via the Network.....	3-4
Firmware Update via USB Disk.....	3-6
Booting up the UC-8410A-LX for the First Time	3-7
File System Resizing	3-7
Reset Button and LED indicators.....	3-7
Diagnosing Device and Subsystem Failures.....	3-7
Restoring the Firmware to Factory Default Settings.....	3-8
Using Cellular Modules	3-9
Cellular Signal Strength	3-9
Cellular Dial-Up Mode	3-9
Cellular GPS Port.....	3-9
Dial-Up Connections	3-9
Disconnecting from a Dial-Up Network	3-10
GPS	3-10
Power on/off Module.....	3-10
Configuring the Wireless LAN	3-10
Configuring WPA2 Settings	3-11
Connecting to an AP Using WEP Authentication	3-11
Connecting to an AP Using WPA/WPA2 PSK Authentication	3-12
Using wpa_cli.....	3-13
4. Securing the UC-8410A-LX.....	4-1
Sudo Mechanism	4-2
5. Using the General Debian Package.....	5-1
NTP Client.....	5-3
Execute Scheduled Commands with cron	5-3
Updating System Time and RTC	5-4
Log Processing Using rsyslog.....	5-4
Rsyslog's Configuration File	5-5
Syntax of the Selector	5-5
OpenSSL	5-6
Ciphers	5-7
Cryptographic Hash Functions.....	5-7
Public-key cryptography.....	5-7
The Apache Web Server	5-7
Edit ServerName in Apache Configuration File.....	5-7
SFTP	5-8
DNS.....	5-9

/etc/hosts	5-9
/etc/resolv.conf.....	5-9
/etc/nsswitch.conf	5-9
IPTABLES	5-9
Observing and Erasing Chain Rules.....	5-13
Defining a Policy for Chain Rules	5-13
Append or Delete Rules	5-14
rsync.....	5-15
Using rsync for External Backups.....	5-15
Automating rsync Backups	5-15
NAT	5-16
NAT Example	5-16
Enabling NAT at Bootup	5-17
NFS (Network File System)	5-18
Setting Up the UC-8410A-LX as an NFS Client.....	5-18
SNMP	5-19
OpenVPN	5-20
Static-Key VPN.....	5-20
Package Management.....	5-21
apt-get	5-21
apt-cache.....	5-21
List All Available Packages	5-21
Find Package Name and Software Description	5-21
Check Package Information	5-22
Check Dependencies for Specific Packages	5-22
Check Cache Statistics	5-22
Update System Packages	5-22
Install or Upgrade Specific Packages.....	5-22
Upgrade All Software Packages	5-22
Install Multiple Packages	5-22
Install Packages Without Upgrading.....	5-23
Upgrade Specific Packages	5-23
Install Specific Package Version	5-23
Remove Packages Without Configuration.....	5-23
Completely Remove Packages.....	5-23
Clean Up Disk Space.....	5-23
Download Only Source Code of Package.....	5-23
Download and Unpack a Package	5-23
Download, Unpack, and Compile a Package	5-24
Download a Package Without Installing	5-24
Check Broken Dependencies	5-24
Search and Build Dependencies.....	5-24
Auto Clean Apt-Get Cache	5-24
Auto Remove Installed Packages.....	5-24
6. Programmer's Guide	6-1
Linux Tool Chain Introduction.....	6-2
Native Compilation	6-2
Cross Compilation	6-3
Obtaining Help	6-5
Test Program—Developing Hello.c.....	6-5
Compiling Hello.c with Native Compilation	6-5
Compiling Hello.c with Cross Compilation	6-6
Makefile Example.....	6-7
Modbus	6-7
RTC (Real Time Clock).....	6-7
WDT (Watch Dog Timer).....	6-9
Cryptographic Hardware Accelerator	6-10
Buzzer and LEDs.....	6-10
Configuring the Cellular Connection	6-11
Using Cell_mgmt.....	6-11
Dial-Up Step-by-Step.....	6-14
Dial-Up	6-14
Cellular Module	6-16
GPS	6-19
Configuring the Wi-Fi Connection.....	6-19
Configuring WPA2 Settings	6-19
A. Extending the Lifetime of the SD Card.....	A-1
Overview	A-2
SD Flash Types	A-2
B. Copying Images on an SD Card	B-1
Using the Win32 Disk Imager	B-2

Using the dd Command	B-3
Enabling the mSATA Storage Device	B-3
Creating a New Partition.....	B-4
Deleting an Existing Partition	B-4
Creating a File System On the mSATA Drive	B-5
Mounting the mSATA Drive.....	B-5
Unmounting the mSATA Drive.....	B-5

Introduction

Thank you for purchasing the Moxa UC-8410A Series of RISC embedded computers. This is the programming and software operation manual for the Linux OS models of the UC-8410A Series of embedded computers. Linux is an open, scalable operating system that helps you build a wide range of innovative, small footprint devices. Software written for desktop PCs can be easily ported to the embedded computer with a GNU cross compiler and minimum source code modifications. A typical Linux-based device is designed for a specific use, and is often not connected to other computers. In some cases, a number of such devices could be connected to a centralized, front-end host. Examples include enterprise tools such as industrial controllers, communications hubs, point-of-sale terminals, and display devices, which include HMIs, advertisement appliances, and interactive panels. The wireless-enablement of the UC-8410A makes it the most suitable choice for Industrial IoT applications.

Getting Started

In this chapter, we describe how to configure the UC-8410A's basic settings.

The following topics are covered in this chapter:

- ❑ **Software Architecture**
- ❑ **Software Packages**
- ❑ **Connecting to the UC-8410A-LX**
 - Connecting Through the Serial Console
 - SSH Console
- ❑ **User Account Management**
 - Switching to the Root Account
- ❑ **Creating and Deleting User Accounts**
- ❑ **Disabling the Default User Account**
- ❑ **Network Settings**
 - Configuring Ethernet Interfaces
 - Connecting to a Cellular Network
- ❑ **System Administration**
 - Querying the Firmware Version
 - Adjusting the Time
 - Setting the Time Zone
- ❑ **Determining Available Drive Space**
- ❑ **Enabling and Disabling Daemons**
- ❑ **Package Management**
- ❑ **Reboot/Shutdown of the UC-8410A-LX**

Software Architecture

The Linux operating system that is pre-installed on the UC-8410A-LX Series computers follows standard Linux architecture, making it easy to run any program that follows the POSIX standard. This computer uses the Debian 8 so that users can enjoy the full range of Debian software, and benefit from its strong community of developers and shared documentation. With Debian 8, the UC-8410A-LX supports both native and cross compilation, making programming on the computer easier and more straightforward.

The UC-8410A-LX Series image is partitioned into bootloader and Linux kernel, backup root file system, and root file system. Refer to the following image partition table for details:

Partition	System Content	Partition Format	Partition Size
1	Bootloader and Linux kernel	W95 FAT32	32 MB
2	Backup root file system	EXT4	128 MB
3	Root file system	EXT4	Rest of the capacity

The default file system format of the UC-8410A Series is EXT4, which is a journaling file system for Linux, developed as the successor to EXT3. A journaling file system keeps track of the changes before committing them to the main file system. In the event of a system crash or power failure, journaling file systems are quicker at bringing back the computer online and less likely to get corrupted.

NOTE Click on the following links for more information on EXT4:

<https://wiki.debian.org/Ext4>

https://ext4.wiki.kernel.org/index.php/Ext4_Howto

Software Packages

Most of the software packages come from the Debian community, whereas the unique features of the UC-8410A-LX Series, such as the diagnostic LED and wireless connection, are supported by Moxa. Refer to *Appendix A* for software packages installed by default and the *Package Management* section for information on managing the software packages installed on your UC-8410A-LX computer.

Connecting to the UC-8410A-LX

You will need access to a notebook computer or a PC to connect to the UC-8410A-LX and log on to the command line interface. There are two ways to connect to the UC-8410A-LX: through a serial console cable or through an Ethernet cable. Refer to the *UC-8410A Hardware User's Manual* for instructions to set up the physical connections for your computer.

The default login username and password are:

Username: moxa

Password: moxa

The username and password are the same for all serial console and SSH remote log in actions. The `root` account login is disabled until you manually create a password for the account. The user `moxa` is in the `sudo` group, which means that this user can use the `sudo` command to run system-level commands. Additional details on using the `sudo` command are available in the *Sudo Mechanism* section.



ATTENTION

For security reasons, we recommend that you disable the default user account after the initial set up is complete and create your own user accounts.

Connecting Through the Serial Console

This method is particularly useful for accessing the console when using the computer for the first time. Instead of knowing UC-8410A-LX's IP addresses, the signal is transmitted over a direct serial connection. To connect through the serial console, configure your PC's terminal software using the following settings.

Serial Console Port Settings	
Baudrate	115200 bps
Parity	None
Data bits	8
Stop bits	1
Flow Control	None
Terminal	VT100

The procedure to use the terminal software to connect to the UC-8410A-LX in a Linux environment and in a Windows environment is described in the following two sections:

Linux Users



WARNING

DO NOT apply these steps to the UC-8410A-LX. These steps are to be applied to the Linux PC that you use to connect to the UC-8410A-LX.

Take the following steps to connect to the UC-8410A-LX from your Linux PC.

1. Install **minicom** from the package repository of your operating system.

For Centos and Fedora:

```
user@PC1:~# yum -y install minicom
```

For Ubuntu and Debian:

```
user@PC2:~# apt-get install minicom
```

2. Use the **minicom -s** command to enter the configuration menu and set up the serial port settings.

```
user@PC1:~# minicom -s
```

3. Select **Serial port setup**.

```
+-----[configuration]-----+
| Filenames and paths          |
| File transfer protocols      |
| Serial port setup            |
| Modem and dialing           |
| Screen and keyboard         |
| Save setup as dfl           |
| Save setup as..             |
| Exit                         |
| Exit from Minicom           |
+-----+-----+
+-----+-----+
```

4. Select **A** to change the serial device.

Note: You need to know which device node is connected to the UC-8410A-LX to configure this setting.

```

+-----+
| A -   Serial Device       : /dev/ttyMI0
| B -   Lockfile Location  : /var/lock
| C -   Callin Program     :
| D -   Callout Program    :
| E -   Bps/Par/Bits       : 115200 8N1
| F -   Hardware Flow Control : Yes
| G -   Software Flow Control : No
|
|       Change which setting?
+-----+
|
|       Screen and keyboard |
|       Save setup as dfl   |
|       Save setup as..    |
|       Exit                |
|       Exit from Minicom  |
+-----+

```

5. Select **E** to configure the port settings according to the **Serial Console Port Settings** table provided above.
6. Select **Save setup as dfl** (from the main configuration menu) to use default values.
7. Select **Exit from minicom** (from the configuration menu) to leave the configuration menu.
8. Execute **minicom** after completing the above configurations.

```
user@PC1:~# minicom
```

```

Welcome to minicom 2.6.1

OPTIONS: I18n
Compiled on Feb 11 2012, 18:56:01.
Port /dev/tty8

Press CTRL-A Z for help on special keys

```

Windows Users



WARNING

DO NOT apply these steps to the UC-8410A-LX. These steps are to be applied to the Windows PC that you use to connect to the UC-8410A-LX.

Take the following steps to connect to the UC-8410A-LX from your Windows PC:

1. Download **PuTTY** (<http://www.chiark.greenend.org.uk/~sgtatham/putty/download.html>), the free SSH and telnet client for Windows.
2. Run the PuTTY application (**putty.exe**) on the Windows PC.

3. Enter the details of the serial connection in the configuration window.
See the example below for the configuration settings required:

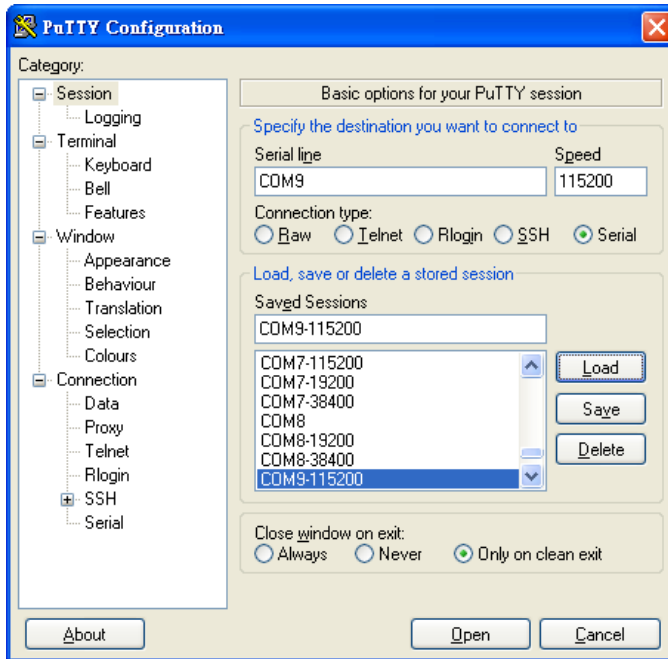

4. Click **Open**.
5. Type in the **username** and **password** in the console that opens up to establish a serial connection with the UC-8410A-LX.

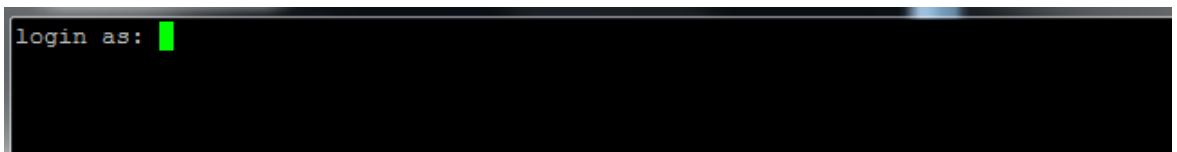

SSH Console

The UC-8410A-LX supports SSH connections over an Ethernet network. Use the following default IP addresses to connect to the UC-8410A-LX:

Port	Default IP
LAN 1	192.168.3.127
LAN 2	192.168.4.127
LAN 3	192.168.5.127

Linux Users

NOTE Do NOT apply these steps to the UC-8410A-LX itself. These steps are to be applied to the Linux PC that you use to connect to the UC-8410A-LX.

Use the **ssh** command to access the UC-8410A-LX’s LAN1 port from a Linux computer.

```
user@PC1:~ ssh moxa@192.168.3.127
```

Type **yes** to complete the connection.

```
The authenticity of host '192.168.3.127 (192.168.4.127)' can't be established.
RSA key fingerprint is 8b:ee:ff:84:41:25:fc:cd:2a:f2:92:8f:cb:1f:6b:2f.
Are you sure you want to continue connection (yes/no)? yes_
```



ATTENTION

Rekey SSHD regularly

In order to secure your system, we suggest doing a regular SSH-rekey, as shown in the following steps.

```
cd /etc/ssh
sudo rm -rf
ssh_host_dsa_key      ssh_host_ecdsa_key      ssh_host_rsa_key
ssh_host_dsa_key.pub  ssh_host_ecdsa_key.pub  ssh_host_rsa_key.pub
sudo ssh-keygen -t rsa -f /etc/ssh/ssh_host_rsa_key
sudo ssh-keygen -t dsa -f /etc/ssh/ssh_host_dsa_key
sudo ssh-keygen -t ecdsa -f. /etc/ssh/ssh_host_ecdsa_key
```

When prompted for a passphrase, leave the passphrase empty and press **Enter**.

```
Restart SSH
moxa@moxa:~$ sudo /etc/init.d/ssh restart
```

For more information about SSH, refer to the following link.

<https://wiki.debian.org/SSH>

Windows Users

NOTE Do NOT apply these steps to the UC-8410A-LX itself. These steps are to be applied to the Windows PC you are using to connect to the UC-8410A-LX.

Take the following steps from your Windows PC.

Click on the link, <http://www.chiark.greenend.org.uk/~sgtatham/putty/download.html> to download PuTTY (free software) to set up an SSH console for the UC-8410A-LX in a Windows environment. The following figure shows a simple example of the configuration that is required:

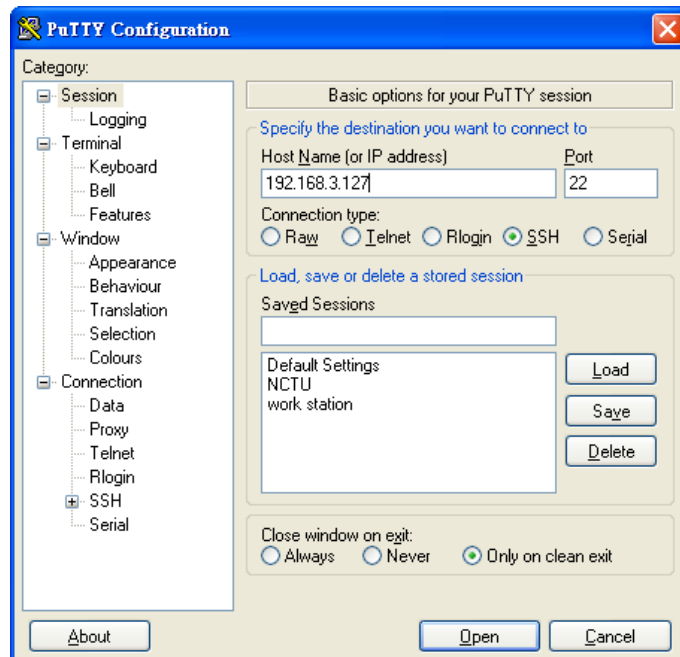

Type in the **username** and **password** in the console that opens up to establish an SSH connection with the UC-8410A-LX.

User Account Management

Switching to the Root Account

You can switch to the `root` user account using `sudo -i` (or `sudo su`). command. For security reasons, do not operate the “`all`” commands from the `root` account.

NOTE Click the following link for more information on the `sudo` command:
<https://wiki.debian.org/sudo>



ATTENTION

You might get a **permission denied** message when you use pipe or redirect behavior with a non-root account. You must use `'sudo su -c'` to run the command instead of using `>`, `<`, `>>`, `<<`, etc.

Note: The single quotes around the full command are required.

Creating and Deleting User Accounts

You can use the commands `useradd` and `userdel` to create and delete user accounts. Refer to the main page of these commands to set relevant access privileges for the account. The following example shows how you can create a user, `test1` in the `sudo` group. The default login shell for the user is `bash` and the home directory is `/home/test1`.

```
moxa@Moxa:~# sudo useradd -m -G sudo -s /bin/bash test1
```

To change the password of `test1`, use the `passwd` command and enter the new password twice to confirm the change as shown below:

```
moxa@Moxa:~# sudo passwd test1
Enter new UNIX password:
Retype new UNIX password:
passwd: password updated successfully
```

To delete the `test1` user, use the `userdel` command as follows:

```
moxa@Moxa:# sudo userdel test1
```

Disabling the Default User Account



ATTENTION

You should first create a user account before you disable the default account.

Use the `passwd` command to lock the default user account so the user, `moxa` cannot log in.

```
root@Moxa:# passwd -l moxa
```

To unlock the user account `moxa`, use the following command:

```
root@Moxa:# passwd -u moxa
```

Network Settings

Configuring Ethernet Interfaces

After the first login, you can configure the UC-8410A-LX's network settings to better fit your application. A serial console makes it more convenient for you to manipulate the network interface settings to avoid frequent disconnections as compared with an SSH.

Modifying Network Settings via the Serial Console

In this section, we use the serial console to configure the UC-8410A-LX's network settings. Follow the instructions given in the *Connecting to the UC-8410A-LX* section to access the console utility of the target UC-8410A via the serial console port, and then type `Moxa:~# cd /etc/network` to change directories.

```
moxa@Moxa:~$ cd /etc/network/  
moxa@Moxa:/etc/network/~$
```

Type `Moxa:~# sudo vi interfaces` to edit the network configuration file with the `vi` editor. You can configure the UC-8410A-LX's Ethernet ports to use either `static` or `dynamic` (DHCP) IP addresses.

Setting a Static IP Address

To set a static IP address for the UC-8410A-LX, use the `iface` command to modify the `address`, `network`, `netmask`, and `broadcast` parameters of the Ethernet interface.

```
# interfaces(5) file used by ifup(8) and ifdown(8)  
auto eth0 eth1 lo  
iface lo inet loopback  
  
# embedded ethernet LAN1  
#iface eth0 inet dhcp  
iface eth0 inet static  
    address 192.168.3.127  
    network 192.168.3.0  
    netmask 255.255.255.0  
    broadcast 192.168.3.255  
  
# embedded ethernet LAN2  
iface eth1 inet static  
    address 192.168.4.127  
    network 192.168.4.0  
    netmask 255.255.255.0  
    broadcast 192.168.4.255~
```

Setting Dynamic IP Addresses

To configure one or both LAN ports to request an IP address dynamically use the `dhcp` option in place of the `static` in the `iface` command as follows:

Default Setting for LAN1	Dynamic Setting using DHCP
<pre>iface eth0 inet static address 192.168.3.127 network: 192.168.3.0 netmask 255.255.255.0 broadcast 192.168.3.255</pre>	<pre>iface eth0 inet dhcp</pre>

```
# embedded ethernet LAN1
iface eth0 inet dhcp
```

Connecting to a Cellular Network

You can install a cellular module on the UC-8410A-LX. For a list of compatible cellular modules, refer to the Moxa website (www.moxa.com).

After you have installed the cellular module and have inserted the SIM card, use the cellular connection utility `cell_mgmt` to connect to UC-8410A-LX to the cellular network.

The `cell_mgmt` configuration file is `/etc/qmi-network.conf`. The file contains the cellular parameters `APN`, `USERNAME`, `PASSWORD`, and `PIN`. When you use the `cell_mgmt` command for the first time, you can type the following instructions directly in the console without editing the `/etc/qmi-network.conf` file. The parameters and their values will be automatically recorded in the configuration file.

```
moxa@Moxa:~$ sudo cell_mgmt start APN=internet USERNAME=moxa PASSWORD=moxa PIN=123
```

Next, use the `cell_mgmt start` command directly with valid configuration information as follows:

```
moxa@Moxa:~$ sudo cell_mgmt start
```

NOTE The configuration will be saved when the module reboots.

System Administration

Querying the Firmware Version

To check the UC-8410A-LX's firmware version, type:

```
moxa@Moxa:~$ kversion
UC-8410A-LX version 3.0
```

Add the `-a` option to the command to view the build number:

```
moxa@Moxa:~$ kversion -a
UC-8410A-LX version 3.0 Build 18041711
```

Adjusting the Time

NOTE The UC-8410A Series uses a rechargeable battery that provides power for about one week. Be sure to sync with a time server each time you recharge the battery to ensure that the UC-8410A is using the correct time.

The UC-8410A-LX has two time settings. One is the system time, and the other is the RTC (Real-Time Clock) time maintained by the UC-8410A-LX hardware. Use the `#date` command to query the current system time or set a new system time. Use the `#hwclock` command to query the current RTC time or set a new RTC time.

Use the `date MMDDhhmmYYYY` command to set the system time:

MM = Month
DD = Date
hhmm = hour and minute
YYYY =year

```
moxa@Moxa:~$ sudo date 071123192014
Mon Jul 11 23:19:00 UTC 2014
```

Use the following command to set the RTC time using the system time:

```
moxa@Moxa:~$ sudo hwclock -w
moxa@Moxa:~$ sudo hwclock
Fri 11 Jul 2014 11:19:38 PM UTC -1.006862 seconds
```

NOTE Click the following links for more information on date and time:
<https://www.debian.org/doc/manuals/system-administrator/ch-sysadmin-time.html>
<https://wiki.debian.org/DateTime>

Setting the Time Zone

There are two ways to configure the Moxa embedded computer's time zone. One is using the `TZ` variable. The other is using `/etc/localtime` file.

Using the TZ Variable

The format of the TZ environment variable format looks like this:

```
TZ=<Value>HH[:MM[:SS]][daylight[HH[:MM[:SS]]][,start date[/starttime], enddate[/endtime]]]
```

Here are some possible TZ settings for the North American Eastern time zone:

1. `TZ=EST5EDT`
2. `TZ=EST0EDT`
3. `TZ=EST0`

In the first case, the reference time is GMT and the stored time values are correct worldwide. A simple change of the TZ variable can print the local time correctly in any time zone.

In the second case, the reference time is Eastern Standard Time and the only conversion performed is for Daylight Saving Time. Therefore, there is no need to adjust the hardware clock for Daylight Saving Time twice per year.

In the third case, the reference time is always the time reported. You can use this option if the hardware clock on your machine automatically adjusts the Daylight Saving Time or you would like to manually adjust the hardware time twice a year.

```
moxa@moxa:~$ TZ= EST5EDT
moxa@moxa:~$ export TZ
```

You must include the TZ setting in the `/etc/rc.d/rc.local` file. The timezone setting will be activated when you restart the computer.

The following table lists other possible values for the TZ environment variable:

Hours From Greenwich Mean Time (GMT)	Value	Description
0	GMT	Greenwich Mean Time
+1	ECT	European Central Time
+2	EET	European Eastern Time
+2	ART	
+3	EAT	Saudi Arabia
+3.5	MET	Iran
+4	NET	
+5	PLT	West Asia
+5.5	IST	India
+6	BST	Central Asia
+7	VST	Bangkok
+8	CTT	China
+9	JST	Japan
+9.5	ACT	Central Australia
+10	AET	Eastern Australia
+11	SST	Central Pacific
+12	NST	New Zealand
-11	MIT	Samoa
-10	HST	Hawaii
-9	AST	Alaska
-8	PST	Pacific Standard Time
-7	PNT	Arizona
-7	MST	Mountain Standard Time
-6	CST	Central Standard Time
-5	EST	Eastern Standard Time
-5	IET	Indiana East
-4	PRT	Atlantic Standard Time
-3.5	CNT	Newfoundland
-3	AGT	Eastern South America
-3	BET	Eastern South America
-1	CAT	Azores

Using the `/etc/localtime` File

The local timezone is stored in the `/etc/localtime` file and is used by GNU Library for C (glibc) if no value has been set for the TZ environment variable. This file is either a copy of the `/usr/share/zoneinfo/` file or a symbolic link to it. The UC-8410A-LX does not provide `/usr/share/zoneinfo/` files. You should find a suitable time zone information file and write over the original local time file in the UC-8410A-LX.

Determining Available Drive Space

To determine the amount of available drive space, use the **df** command with the **-h** tag. The system will return the amount of drive space broken down by file system. Here is an example:

```
moxa@Moxa:~$ df -h
Filesystem      Size  Used Avail Use% Mounted on
rootfs          803M  238M  524M  32% /
/dev/root       803M  238M  524M  32% /
tmpfs           25M   188K   25M   1% /run
tmpfs           5.0M    0   5.0M   0% /run/lock
tmpfs           10M    0   10M   0% /dev
tmpfs           50M    0   50M   0% /run/shm
```

Enabling and Disabling Daemons

By default, only the following daemons are enabled in the UC-8410A-LX:

- sftpd** SFTP server / client daemon
- sshd** Secure shell server daemon

You can use the **insserv** command to manage which services will run in the background. The following example shows how to add the Apache daemon to the current *run level*.

```
moxa@Moxa:~$ sudo insserv -d apache2
```

The Apache daemon will not get activated in the current boot session, but will be running in the background from the next boot session.

To disable the Apache daemon, use the following command:

```
moxa@Moxa:~$ sudo insserv -r apache2
```

You can also write your own script to start and stop a daemon during the system "init" stage:

```
### BEGIN INIT INFO
# Provides:          scriptname
# Required-Start:    $remote_fs $syslog
# Required-Stop:     $remote_fs $syslog
# Default-Start:     2 3 4 5
# Default-Stop:      0 1 6
# Short-Description: Start daemon at boot time
# Description:       Enable service provided by daemon.
### END INIT INFO

YOUR SCRIPT
```

Linux daemons can be started or stopped in a current boot session by using the scripts in the **/etc/init.d** file.

To start the apache daemon, use:

```
moxa@Moxa:~$ sudo /etc/init.d/apache2 start
```

To stop the apache daemon, use:

```
moxa@Moxa:~$ sudo /etc/init.d/apache2 stop
```

In comparison to **insserv**, scripts in **/etc/init.d/** will only start or stop the services in the current boot session. Once you reboot the UC-8410A-LX, it will go back to the default settings managed by **insserv**.

Package Management

Most of the software Debian packages are maintained by the Debian community in the official Debian **apt** repository. The features that are exclusively supported by the UC-8410A-LX are maintained by Moxa. You must add the Moxa repository to the **/etc/apt/sources.list** file to keep your system up-to-date with the newest UC-8410A-LX packages.

```
moxa@moxa:~$ cat /etc/apt/sources.list
deb http://debian.moxa.com/debian jessie main

deb http://ftp.us.debian.org/debian/ jessie main contrib non-free
deb-src http://ftp.us.debian.org/debian/ jessie main contrib non-free

deb http://ftp.us.debian.org/debian/ jessie-updates main contrib non-free
deb-src http://ftp.us.debian.org/debian/ jessie-updates main contrib non-free

deb http://security.debian.org/ jessie/updates main contrib non-free
deb-src http://security.debian.org/ jessie/updates main contrib non-free

deb http://ftp.debian.org/debian jessie-backports main contrib non-free
deb-src http://ftp.debian.org/debian jessie-backports main contrib non-free
```

The following packages are maintained in Moxa's official repository.

Package Name	Version	Architecture	Description
libssl1.0.0:armhf	1.0.1k-3+deb8u1+moxa	armhf	Secure Sockets Layer toolkit shared libraries
openssl	1.0.1k-3+deb8u1+moxa	armhf	Secure Socket Layer (SSL) binary
moxa-cellular-utils	1.0.0	armhf	Cellular-related utility on the Moxa computer. (libqmi: v1.12.6)
uc8410a-diag	1.0.0	armhf	Self-diagnostic utility on a UC-8400A Series embedded computer
uc8410a-push-btn	1.0.0	armhf	Push-button utility on a UC-8400A Series embedded computer
uc8410a-setinterface	1.0.0	armhf	Adjust UART mode utility on a UC-8400A Series embedded computer
moxa-snmpd	1.0.0	armhf	SNMP (Simple Network Management Protocol)
uc8410a-system	1.0.0	armhf	System files on a UC-8400A Series embedded computer
moxa-wifi-utils	1.0.0	armhf	Wi-Fi related utility on the Moxa computer.

Reboot/Shutdown of the UC-8410A-LX

IMPORTANT Do NOT use the reset switch on the front or back of the UC-8410A-LX to shut down a running Debian GNU/Linux system. Do NOT also turn off the UC-8410A-LX when the Debian GNU/Linux OS is running on the computer.

Debian GNU/Linux should be shut down in a controlled manner; otherwise, files might get lost and/or disk damage might occur. If you run a desktop environment, a **log out** option is usually available from the application menu. The **log out** option provides the proper means of shutting down (or rebooting) the system.

To reboot the UC-8410A-LX, use the following command:

```
moxa@moxa:~$ sudo reboot -i -f -d
```

To shut down the UC-8410A-LX, use the following command:

```
moxa@moxa:~$ sudo shutdown -h "now"
```

Advanced Configuration of Peripherals

In this chapter, we include more information on the UC-8410A-LX's peripherals, such as the serial interface, storage, diagnostic LEDs, and the cellular module.

The following topics are covered in this chapter:

- ❑ **Serial Ports**
 - stty
- ❑ **USB Port**
 - Disabling the USB Port
 - USB Automount
- ❑ **SD Slot**
- ❑ **Firmware Update**
 - Firmware Update via the Network
 - Firmware Update via USB Disk
- ❑ **Bootup the UC-8410A-LX for the First Time**
 - File System Resizing
- ❑ **Reset Button and LED indicators**
 - Diagnosing Device and Subsystem Failures
- ❑ **Restoring the Firmware to Factory Default Settings**
- ❑ **Using Cellular Modules**
 - Cellular Signal Strength
 - Cellular Dial-Up Mode
 - Cellular GPS Port
 - Dial-Up Connections
 - Disconnecting from a Dial-Up Network
 - GPS
 - Power on/off Module
- ❑ **Configuring the Wireless LAN**
 - Configuring WPA2 Settings
 - Connecting to an AP Using WEP Authentication
 - Connecting to an AP Using WPA/WPA2 PSK Authentication
 - Using wpa_cli

Serial Ports

The serial ports support RS-232, RS-422, and RS-485 2-wire operation modes with flexible baudrate settings.

The default operation mode is set to **RS-232**. Use the `setinterface` command to change the operation mode as follows:

Usage: `setinterface device-node [interface-no]`
Device-node: `/dev/ttyMIn; n = 0,1,2,...`
Interface-no: *Refer to the following table*

Interface Number	Operation Mode
None	Display current setting
0	RS-232
1	RS-485 2-wire
2	RS-422
3	RS-485 4-wire

For example, to set `/dev/ttyMI0` to RS-485 2-wire (**RS485-2W**) mode, use the following command:

```
moxa@moxa:~# sudo setinterface /dev/ttyMI0 1
moxa@moxa:~# sudo setinterface /dev/ttyMI0
```

stty

The `stty` command is used to manipulate the serial terminal settings. You can view and modify the serial terminal settings with this command as described below:

Displaying All Serial Terminal Settings

The following text shows how to display all settings:

```
moxa@moxa:~$ sudo stty -a -F ttyMI0
speed 9600 baud; rows 0; columns 0; line = 0;
intr = ^C; quit = ^\; erase = ^?; kill = ^U; eof = ^D; eol = <undef>;
eol2 = <undef>; swtch = <undef>; start = ^Q; stop = ^S; susp = ^Z; rprnt = ^R;
werase = ^W; lnext = ^V; flush = ^O; min = 1; time = 0;
-parenb -parodd cs8 hupcl -cstopb cread clocal -crtcts
-ignbrk -brkint -ignpar -parmrk -inpck -istrip -inlcr -igncr icrnl ixon -ixoff
-iuclc -ixany -imaxbel -iutf8
opost -olcuc -ocrnl onlcr -onocr -onlret -ofill -ofdel nl0 cr0 tab0 bs0 vt0 ff0
isig icanon iexten echo echoe echok -echonl -noflsh -xcase -tostop -echoprt
echoctl echoke
```

Configuring the Serial Terminal Settings

The following example changes the **baudrate** to 115200.

```
moxa@moxa:~$ sudo stty 115200 -F ttyMI0
```

After you run this command, the **baudrate** will be changed to 115200.

```
moxa@moxa:~$ sudo stty -a -F ttyMI0
speed 115200 baud; rows 0; columns 0; line = 0;
intr = ^C; quit = ^\; erase = ^?; kill = ^U; eof = ^D; eol = <undef>;
eol2 = <undef>; swtch = <undef>; start = ^Q; stop = ^S; susp = ^Z; rprnt = ^R;
werase = ^W; lnext = ^V; flush = ^O; min = 1; time = 0;
-parenb -parodd cs8 hupcl -cstopb cread clocal -crtcts
-ignbrk -brkint -ignpar -parmrk -inpck -istrip -inlcr -igncr icrnl ixon -ixoff
-iuclc -ixany -imaxbel -iutf8
opost -olcuc -ocrnl onlcr -onocr -onlret -ofill -ofdel n10 cr0 tab0 bs0 vt0 ff0
isig icanon iexten echo echoe echok -echonl -noflsh -xcase -tostop -echoprt
echoctl echoke
```

NOTE Refer to the following link for additional details on the **stty** command:
<http://www.gnu.org/software/coreutils/manual/coreutils.html#stty-invocation>

USB Port

The UC-8410A-LX Series has a USB port that you can use to expand the storage capacity of the computer.

Disabling the USB Port

USB ports on the UC-8410A-LX can be disabled. This is done via the bootloader, before booting up. To disable a USB port, take the following steps:

1. After powering on the UC-8410A computer, press **DEL** to enter the BIOS configuration settings.

```
-----
Model: UC-8410A-LX
  Boot Loader Version 2.0.0S02
  Build date: Dec 15 2017 - 11:14:04   Serial Number: IMOXA1234567
  LAN1 MAC: 00:90:e8:00:00:40         LAN2 MAC: 00:90:e8:00:00:50
  LAN3 MAC: 00:90:e8:00:00:60
-----
(0) TPM Setting                      (1) Extend USB Port Control
(2) Fastboot mode                    (3) Firmware Update by USB Disk
(4) Firmware Update by Tftp
-----
Command>>1
```

2. Enter **1** to Extend USB Port Control.

```
Current Extend USB Port is ON.

Change to ,0 - ON, 1 - OFF (0-1,enter for abort):
```

3. Enter **1** to disable the USB port.

```
Change to ,0 - ON, 1 - OFF (0-1,enter for abort): 1
Saving Environment to EEPROM...
```

4. Reboot the UC-8410A-LX computer.

You need to reboot the UC-8410A-LX computer for the changes to take effect. Also, during the boot up process, you will see the following message on the console, which confirms that the USB port has been disabled.

```
[60.268951] hub 2-0:1.0: unable to enumerate USB device on port 1
```



ATTENTION

No USB devices can be mounted on a port that is disabled.

This includes USB block storage devices and dongles. You will not be able to mount any device on a disabled port.

USB Automount

The UC-8410A-LX supports the hot plug function for connecting USB/SD mass storage devices. However, by default, the automount utility (udev) only supports automounting of one partition. Use the `mount` command to view details about all partitions.



ATTENTION

Remember to type the `#sync` command before you disconnect the USB mass storage device to prevent loss of data.

Exit the `/media/usb*` directory before you disconnect the storage device. If you stay in this directory, the auto un-mount process for the device will fail. If that happens, you can type `#umount /media/usb*` to unmount the device manually.

SD Slot

The SD slot supports the SD, SDHC, and SDXC formats, and can be used to expand the storage capacity in the UC-8410A-LX Series.

Firmware Update

There are two ways to update the firmware of UC-8410A Series computer, please refer to following sections for more detail.

Firmware Update via the Network

Preparing the TFTP Server

1. Set up a TFTP server.
2. Make sure the image (*.img) file is in your TFTP server directory.

Updating the Firmware

1. To update the firmware, log in to the product through the serial console. Instructions on how to connect to the serial console can be found in the Hardware user's manual for your RISC computer.
2. After powering on the Hardware user's manual for your RISC computer, press to enter the bootloader configuration settings.

If you cannot enter the bootloader menu by pressing , replace the PuTTY tool with the Tera Term terminal console tool. (Detailed information is available on the following website:
<https://tssh2.osdn.jp/index.html.en>)

```
-----
Model: UC-8410A-LX
Boot Loader Version 2.0.0S02
Build date: Dec 15 2017 - 11:14:04   Serial Number: IMOXA1234567
LAN1 MAC: 00:90:e8:00:00:40         LAN2 MAC: 00:90:e8:00:00:50
LAN3 MAC: 00:90:e8:00:00:60
-----
(0) TPM Setting                    (1) Extend USB Port Control
(2) Fastboot mode                 (3) Firmware Update by USB Disk
(4) Firmware Update by Tftp
-----
Command>>
```

3. Enter 4 to update the firmware by Tftp server. If you want to set up the TFTP IP address, enter 1 to set up the target machine's IP address and the Tftp server IP address and then choose an img file.

```
Command>> 4
Current IP Address
Local IP Address : ipaddr=192.168.31.134
Server IP Address : serverip=192.168.31.132
Do you set your ip address?
0 - No, 1 - Yes (0-1,enter for abort): 1
Local IP Address : 192.168.31.134
Server IP Address : 192.168.31.132
Saving Environment to SPI Flash...
SF: Detected MX25L6405D with page size 64 KiB, total 8 MiB
Erasing SPI flash...Writing to SPI flash...done
Firmware File Name (firmware.img):
FWR_UC-8410A-LX_V1.0.0_Build_17030911.img
```

Firmware Update via USB Disk

Preparing the USB

Prepare a USB disk and make sure the image (*.img) file is in it.

Updating the Firmware

1. To update the firmware, log in to the product through the serial console. Instructions on how to connect to the serial console can be found in the Hardware user's manual for your RISC computer.
2. After powering on the Hardware user's manual for your RISC computer, press to enter the bootloader configuration settings.

If you cannot enter the bootloader menu by pressing , replace the PuTTY tool with the Tera Term terminal console tool. (Detailed information is available at: <https://ttssh2.osdn.jp/index.html.en>)

```
-----  
--  
Model: UC-8410A-LX  
Boot Loader Version 2.0.0S02  
Build date: Dec 15 2017 - 11:14:04   Serial Number: IMOXA1234567  
LAN1 MAC: 00:90:e8:00:00:40         LAN2 MAC: 00:90:e8:00:00:50  
LAN3 MAC: 00:90:e8:00:00:60  
-----  
--  
(0) TPM Setting                      (1) Extend USB Port Control  
(2) Fastboot mode                    (3) Firmware Update by USB Disk  
(4) Firmware Update by Tftp  
-----  
-  
Command>>
```

3. Enter 3 to update the firmware from USB disk. And then enter the firmware file name (firmware.img)

```
Command>> 3  
Firmware File Name (firmware.img): fwr_uc-8410A-LX_v3.0_build_18032703.img  
switch to partitions #0, OK  
mmc0(part 0) is current device  
reading fwr_uc-8410a-lx_v3.0_build_18032703.img  
201326592 bytes read in 114882 ms (1.7 MiB/s)  
  
MMC write: dev # 0, block # 0, count 393216 ... 393216 blocks written: OK  
switch to partitions #0, OK  
mmc0(part 0) is current device  
reading fwr_uc-8410a-lx_v3.0_build_18032703.img
```

Booting up the UC-8410A-LX for the First Time

We suggest using the serial console to log in for the first time. See the *UC-8410A Hardware User's Manual* for instructions on how to connect to the serial console.

File System Resizing

Connect the UC-8410A-LX to a 12-48 VDC power source; the computer will immediately boot up. First the power LED will light up followed by the storage LED. You will also see messages printed out from the serial console. During the first boot up, you will notice that the root filesystem is being resized and initialized, as indicated by the example shown below:

```
[...] Starting resize2fs_once...It will take some time to finish this action!:resize2fs 1.42.5 (29-Jul-2012)
Filesystem at /dev/root is mounted on /; on-line resizing required
old_desc_blocks = 4, new_desc_blocks = 29
[ 9.563018] PHY: 0:10 - Link is Up - 100/Full
[ 9.567718] ADDRCONF(NETDEV_CHANGE): eth0: link becomes ready
Performing an on-line resize of /dev/root to 7550976 (1k) blocks.
[ ok ] Starting OpenBSD Secure Shell server: sshd.
[ ok ] Starting Trusted Computing daemon: tcsd.
```

The procedure could take a few minutes, with the actual time required depending on the capacity of the SD card.

Reset Button and LED indicators

The push button is used to diagnose device failure or to perform firmware restoration. Pay attention to the indicators and release the button at the appropriate time to enter the correct mode to either diagnose your device or restore your device to the default configuration. See the figure and description for the indications.

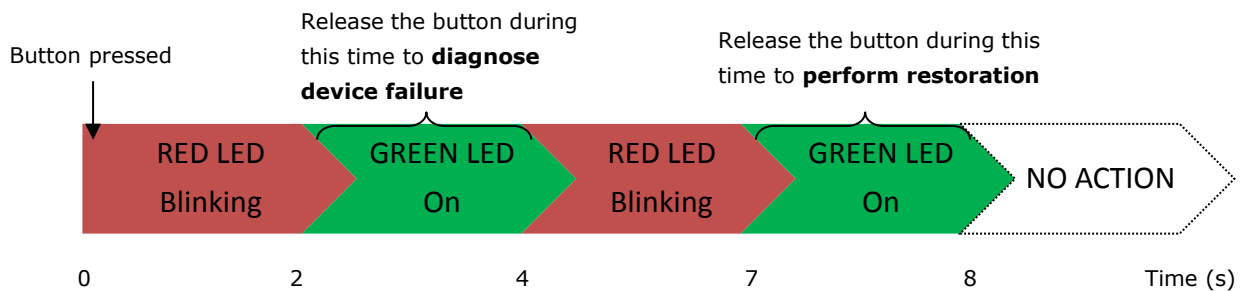

The LED indicators have different behaviors when diagnosing for device failure and for performing firmware restoration. See the following table for details.

Status	Red LED	Yellow LED	Green LED
Executing diagnostic program	Blink	Off	On
Resetting to default configuration	Blink	Blink	On

Diagnosing Device and Subsystem Failures

The red LED will start blinking once you press the push button. Keep the button pressed until the green LED is lit for the first time and then release the button to enter diagnostic mode to check which peripherals are available on the UC-8410A-LX. When diagnostic program is running, the red LED will be blinking.

Status	Green LED	Red LED	Yellow LED
Execution of diagnostic program	On	Blinking	Off

The following two tables describe the diagnostic results related to hardware defects and system operation.

Hardware Defects

If you observe any of these hardware issues, contact Moxa for further instructions.

Priority	Status Description	Green LED	Yellow LED	Red LED
1	Proceeding with self-diagnosis	On	Off	Blinking
2	LAN1 Ethernet Error – LAN1 Ethernet controller malfunction	Off	Off	On
3	LAN2 Ethernet Error – LAN2 Ethernet controller malfunction	Blinking	Off	On
4	LAN3 Ethernet Error – LAN3 Ethernet controller malfunction	On	Off	On
5	UART Interface Error – Any one of UART interfaces is malfunctioning	Off	On	On
6	LED device issue	Blinking	Blinking	Blinking
7	Button device issue	Off	Blinking	On
8	Ready for reset to factory default	On	Blinking	Blinking
9	CPU usage (over 90%)	Off	On	Blinking
10	RAM usage (over 90%)	Off	On	Off
11	Disk usage (over 90%)	Blinking	On	Off
12	File system corrupted	Blinking	On	Blinking
13	Device without TPM	Blinking	Blinking	On

Restoring the Firmware to Factory Default Settings

Keep the push button pressed until the green LED lights up for the second time and then release the button. The UC-8410A-LX will enter the restoration process and reset the computer to factory defaults. The green LED will light up, and the red and yellow LED indicators will blink as the root filesystem is reset to default values.

Status	Green LED	Red LED	Yellow LED
Resetting to defaults	On	Blinking	Blinking

You can also use the OS's **setdef** command to restore the computer to factory defaults:

```
moxa@moxa:~$ sudo setdef
```



ATTENTION

Reset-to-default will erase all the data stored on the boot storage

Please back up your files before resetting the system to factory defaults. All the data stored in the UC-8410A-LX's boot storage will be destroyed after resetting to factory defaults.

Using Cellular Modules

UC-8410A-LX computers have a mini PCIe socket for installing a cellular module. Contact your sales representative for more information about available modules.

Cellular Signal Strength

The following table shows how cellular signal strength is indicated by the signal indicators.

Signal Indicator	Value	RSSI dbm	Condition
3 LEDs on (red, yellow, green)	20 to 30	-73 to -53	Excellent
2 LEDs on (red, yellow)	10 to 19	-93 to -74	Good
1 LED on (red)	2 to 9	-109 to -94	Marginal
No LED on	Else	Else	No signal

Cellular Dial-Up Mode

For the modules provided, we suggest dialing up from QMI interface with QMI commands instead of using AT commands from the AT ports.

Module	LE910
Dial Up mode	QMI /dev/cdc-wdm0
AT Port	/dev/ttyUSB2 /dev/ttyUSB3

Cellular GPS Port

Module	LE910
Device node	/dev/ttyUSB1

Dial-Up Connections

You can customize the APN name for your connection by modifying the `/etc/qmi-network.conf` file. Consult your carrier for the correct APN name and insert it into the configuration file as shown below:

```
moxa@moxa:~$ echo "APN=internet" | sudo tee /etc/qmi-network.conf
```

(APN is set to "internet" for this example; the APN value for your connection could be different.)

To dial up with the default configuration, use the following command:

```
moxa@moxa:~$ sudo /usr/sbin/cell_mgmt start
```

cell_mgmt is a Moxa script. If you need to alter any options in making the cellular connection, use the **qmi-network** and **qmi-cli** commands.

```
moxa@moxa:~$ sudo qmi-network /dev/cdc-wdm0 start
Loading profile...
  APN: internet
Starting network with 'qmicli --device-open-flag-net-802-3 -d /dev/cdc-wdm0
--wds-start-network=internet --client-no-release-cid'...
Saving state... (CID: 9)
Saving state... (PDH: 1205295888)
Network started successfully
```

Note that you need to manually start the dhcp client if you use qmi-network to connect. The default interface of the cellular connection is wwan0

```
moxa@Moxa:~$ dhclient wwan0
```

Disconnecting from a Dial-Up Network

Be sure to hang up the connection if you no longer need the service. Use the following command to disconnect:

```
moxa@Moxa:~$ sudo /usr/sbin/cell_mgmt stop
```

You can also use qmi-network:

```
moxa@Moxa:~$ sudo qmi-network /dev/cdc-wdm0 stop
```

GPS

The GPS function of the Telit LE910 is disabled by default. You can get raw GPS data by just listening to the GPS port /dev/ttyUSB1

Power on/off Module

cell_mgmt can be used to re-initialize the module without rebooting the UC-8410A-LX. Issue the following command to power off the module:

```
moxa@Moxa:~# sudo cell_mgmt power_off
```

Issue the following command re-initialize and power on the cellular module:

```
moxa@Moxa:~# sudo cell_mgmt power_on
```

NOTE Additional information about qmi utilities can be found at the following link.
<http://www.freedesktop.org/wiki/Software/libqmi/>

Configuring the Wireless LAN

You can configure the Wi-Fi connection on the UC-8410A using a configuration file or enable wifi_mgmt utility manually by using the `#!/usr/sbin/wifi_mgmt start` command.

NOTE You might encounter compatibility issues if you configure Wi-Fi settings using commands other than `#!/usr/sbin/wifi_mgmt start`.

Use the following command to list the available wireless network IDs:

```
#iwlist wlan0 scanning
```

```
root@Moxa:# iwlist wlan0 scanning
wlan0    Scan completed :
         Cell 01 - Address: 50:67:F0:61:2D:7A
           Protocol:802.11b/g
           ESSID:"MIS-WAP-1"
           Mode:Managed
           Frequency:2.412 GHz (Channel 1)
           Quality=81/100  Signal level=-58 dBm  Noise level=-92 dBm
           Encryption key:on
           Bit Rates:54 Mb/s
```

Configuring WPA2 Settings

The UC-8410A Series computer supports WPA2 security using the **wpa_supplicant** program. Refer to the following table for configuration options. The “**Key required before joining network?**” column describes whether an encryption and/or authentication key must be configured before associating with a network.

Infrastructure mode	Authentication mode	Encryption status	Manual Key required?	IEEE 802.1X enabled?	Key required before joining network?
ESS	Open	None	No	No	No
ESS	Open	WEP	Optional	Optional	Yes
ESS	Shared	None	Yes	No	Yes
ESS	Shared	WEP	Optional	Optional	Yes
ESS	WPA	WEP	No	Yes	No
ESS	WPA	TKIP	No	Yes	No
ESS	WPA	AES	No	Yes	No
ESS	WPA-PSK	WEP	Yes	Yes	No
ESS	WPA-PSK	TKIP	Yes	Yes	No
ESS	WPA-PSK	AES	Yes	Yes	No

Connecting to an AP Using WEP Authentication

1. Edit the `/etc/moxa-wifi-utils/wpa_supplicant.conf` file.

```
##### WEP #####
network={
    ssid="MIS-WAP-1"
    bssid=50:67:F0:61:2D:7A
    key_mgmt=NONE
    wep_key0=CFEE46EED3FA94FAEB92348922
}
#####
```

The following table describes the related parameters.

Parameter	Usage	Function
ssid	{Access Point Name}	Network name (as announced by the access point). An ASCII or hex string enclosed in quotation marks.
bssid	{MAC address of the AP}	Set network bssid, (typically the MAC address of the access point).
key_mgmt	{NONE,WEP,TKIP,AES}	List of acceptable key management protocols;
wep_key0	{wep key}	WEP key in hexadecimal format

2. Type `/usr/sbin/wifi_mgmt start` to enable this function.
To stop the function, use the `/usr/sbin/wifi_mgmt stop` command.

NOTE For more information about `wpa_supplicant.conf`, visit:

- http://www.daemon-systems.org/man/wpa_supplicant.conf.5.html
- http://linux.die.net/man/5/wpa_supplicant.conf

Connecting to an AP Using WPA/WPA2 PSK Authentication

1. Edit the relevant parameters in the `/etc/moxa-wifi-utils/wpa_supplicant.conf` file.

```
##### WPA/WPA2 PSK #####
network={
    ssid="5566"
    proto=WPA WPA2 RSN
    key_mgmt=WPA-PSK
    pairwise=TKIP CCMP
    group=TKIP CCMP
    psk="01234567890"
}
#####
```

2. Type `/usr/sbin/wifi_mgmt start` to enable this function.
To stop the function, type `/usr/sbin/wifi_mgmt stop`.

The following table describes the relevant parameters.

Parameter	Usage	Function
ssid	{Access Point Name}	Network name (as announced by the access point). An ASCII or hex string enclosed in quotation marks.
proto	{WPA WPA2 RSN}	List of acceptable protocols; one or more of: WPA (IEEE802.11i/D3.0) and RSN (IEEE 802.11i). WPA2 is another name for RSN. The default value is "WPA RSN".
key_mgmt	{WPA-PSK or WPA-EAP}	List of acceptable key management protocols; one or more of: WPA-PSK (WPA pre-shared key), WPA-EAP (WPA using EAP authentication), IEEE8021X (IEEE 802.1x using EAP authentication and, optionally, dynamically generated WEP keys). The default value is "WPA-PSK WPA-EAP".
pairwise	{TKIP CCMP, or NONE}	List of acceptable pairwise (unicast) ciphers for WPA; one or more of: CCMP (AES in Counter mode with CBC-MAC, RFC 3610, IEEE802.11i/D7.0), TKIP (Temporal Key Integrity Protocol, IEEE802.11i/D7.0), NONE (deprecated). The default value is "CCMP TKIP".
group	{CCMP, TKIP, WEP104, WEP40}	List of acceptable group (multicast) ciphers for WPA; one or more of: CCMP (AES in Counter mode with CBC-MAC, RFC 3610, IEEE802.11i/D7.0), TKIP (Temporal Key Integrity Protocol, IEEE802.11i/D7.0), WEP104 (WEP with 104-bit key), EP40 (WEP with 40-bit key). The default value is "CCMP TKIP WEP104 WEP40".

Parameter	Usage		Function
psk	{preshared key}		WPA preshared key used in WPA-PSK mode. The key is specified as 64 hex digits or as an 8 to 63 character ASCII passphrase.
mode	# 0 = infrastructure (Managed) mode, i.e., associate with an AP (default) # 1 = IBSS (ad-hoc, peer-to-peer)		IEEE 802.11 operation mode.

Using wpa_cli

wpa_cli is a text-based frontend program for interacting with wpa_supplicant. You can use the wpa_cli command to query the current status, change configuration, trigger events, and request user input.

NOTE Before you use the wpa_cli command, you must run the wpa_supplicant command. For more information on wpa_cli, go to http://linux.die.net/man/8/wpa_cli.

Scanning APs and Viewing Scan Results

To scan for access points in the area, enter the following command:

```
root@Moxa:/home# wpa_cli -i wlan0 scan
```

To display AP scan results, enter the command shown below.

```
root@Moxa:/home# wpa_cli -i wlan0 scan_results
bssid / frequency / signal level / flags / ssid
50:67:f0:61:2d:7a      2412      200      [WEP][ESS]
00:1f:1f:8c:0f:64      2462      210      [WPA2-PSK-CCMP-p
1c:7e:e5:93:ff:2a      2422      222      [WPA-PSK-TKIP+CC
b0:48:7a:a5:9b:70      2427      190      [WPA-PSK-CCMP][W
14:e6:e4:f0:57:5a      2442      182      [WPA-PSK-CCMP][W
54:04:a6:de:ce:dc      2412      186      [WPA2-PSK-CCMP][
c8:6c:87:78:af:7d      2412      174      [WPA2-PSK-TKIP+G
10:6f:3f:4c:af:e3      2462      166      [WPA-PSK-CCMP][E
```

Adding WEP Settings in a Configuration File

The relevant commands you can enter to add WEP configuration information in the `/etc/moxa-wifi-utils/wpa_supplicant.conf` file are shown below:

```
root@Moxa:/home# wpa_cli -i wlan0 add_network
0
root@Moxa:/home# wpa_cli -i wlan0 set_network 0 key_mgmt NONE
OK
root@Moxa:/home# wpa_cli -i wlan0 set_network 0 ssid "MOXA-AP-1"
OK
root@Moxa:/home# wpa_cli -i wlan0 set_network 0 bssid 50:67:F0:61:2D:7A
OK
root@Moxa:/home# wpa_cli -i wlan0 set_network 0 wep_key0 AAEE431ED3FVV4FAEB923443C4
OK
root@Moxa:/home# wpa_cli -i wlan0 enable_network 0
OK
```

```

root@moxa:/home# wpa_cli -iwlan0 select_network 0
OK
root@moxa:/home# wpa_cli -i wlan0 save_config

```

Adding WPA/WPA2 Settings in a Configuration File

The relevant commands you can enter to add WPA/WPA2 configuration information in the `/etc/moxa-wifi-utils/wpa_supplicant.conf` file are shown below.

```

root@moxa:/home# wpa_cli -i wlan0 add_network
1
root@moxa:/home# wpa_cli -i wlan0 set_network 1 ssid '"MOXA-AP"'
OK
root@moxa:/home# wpa_cli -i wlan0 set_network 1 proto 'WPA WPA2 RSN'
OK
root@moxa:/home# wpa_cli -i wlan0 set_network 1 key_mgmt 'WPA-PSK'
OK
root@moxa:/home# wpa_cli -i wlan0 set_network 1 pairwise 'TKIP CCMP'
OK
root@moxa:/home# wpa_cli -i wlan0 set_network 1 group 'TKIP CCMP'
OK
root@moxa:/home# wpa_cli -i wlan0 set_network 1 psk '"01234567890"'
'SET_NETWORK 1 psk "01234567890" command timed out.
root@moxa:/home# wpa_cli -i wlan0 enable_network 1
OK
root@moxa:/home# wpa_cli -iwlan0 select_network 1
OK
root@moxa:/home# wpa_cli -i wlan0 save_config
OK

```

The following table lists the `wpa_cli` commands:

Command	Function
<code>wpa_cli -i wlan0 status</code>	Get current WEP/WPA/EAPOL/EAP status.
<code>wpa_cli -i wlan0 help</code>	Show this usage help.
<code>wpa_cli -i wlan0 terminate</code>	Terminate <code>wpa_supplicant</code> .
<code>wpa_cli -i wlan0 interface</code>	Show interfaces or select an interface.
<code>wpa_cli -i wlan0 list_networks</code>	List configured networks in <code>wpa_supplicant.conf</code> .
<code>wpa_cli -i wlan0 select_network</code>	Set network variables. Network id can be received from the <code>LIST_NETWORKS</code> command output. This command uses the same variables and data formats as the configuration file.
<code>wpa_cli -i wlan0 enable_network</code>	Enable a network. Network id can be received from the <code>LIST_NETWORKS</code> command output.
<code>wpa_cli -i wlan0 disable_network</code>	Disable a network. Network id can be received from the <code>LIST_NETWORKS</code> command output. Special network id "all" can be used to disable all networks.
<code>wpa_cli -i wlan0 remove_network</code>	Remove a network. Network id can be received from the <code>LIST_NETWORKS</code> command output. Special network id "all" can be used to remove all networks.
<code>wpa_cli -i wlan0 reconfigure</code>	Force <code>wpa_supplicant</code> to re-read its configuration file.
<code>wpa_cli -i wlan0 save_config</code>	Save the current configuration. Replace original <code>/etc/moxa-wifi-utils/wpa_supplicant.conf</code> .
<code>wpa_cli -i wlan0 scan</code>	Scan available networks.
<code>wpa_cli -i wlan0 scan_results</code>	Get scanning results.

Securing the UC-8410A-LX

The UC-8410A-LX Series offers better security and solid protection for your computing platform by integrating a Trusted Platform Module (available in the customized version)

The following topics are covered in this chapter:

- **Sudo Mechanism**

Sudo Mechanism

In the UC-8410A-LX, the root account is disabled for better security. **Sudo** is a program designed to let system administrators allow some users to execute some commands as root (or another user). The basic philosophy is to give as few privileges as possible but still allow people to get their work done. Using sudo is better (safer) than opening a session as root for a number of reasons, including:

- Nobody needs to know the root password (sudo prompts for the current user's password). Extra privileges can be granted to individual users temporarily, and then taken away without the need for a password change.
- It is easy to run only the commands that require special privileges via sudo; the rest of the time, you work as an unprivileged user, which reduces the damage that mistakes can cause.
- The code below shows that some system level commands are not available to the user **moxa** directly.

```
moxa@Moxa:~$ ifconfig
-bash: ifconfig: command not found

moxa@Moxa:~$ sudo ifconfig
eth0      Link encap:Ethernet  HWaddr 00:90:e8:00:00:07
          inet addr:192.168.3.127  Bcast:192.168.3.255  Mask:255.255.255.0
          UP BROADCAST ALLMULTI MULTICAST  MTU:1500  Metric:1
          RX packets:0 errors:0 dropped:0 overruns:0 frame:0
          TX packets:0 errors:0 dropped:0 overruns:0 carrier:0
          collisions:0 txqueuelen:1000
          RX bytes:0 (0.0 B)  TX bytes:0 (0.0 B)

eth1      Link encap:Ethernet  HWaddr 00:90:e8:00:00:08
          inet addr:192.168.4.127  Bcast:192.168.4.255  Mask:255.255.255.0
          UP BROADCAST ALLMULTI MULTICAST  MTU:1500  Metric:1
          RX packets:0 errors:0 dropped:0 overruns:0 frame:0
          TX packets:0 errors:0 dropped:0 overruns:0 carrier:0
          collisions:0 txqueuelen:1000
          RX bytes:0 (0.0 B)  TX bytes:0 (0.0 B)

lo        Link encap:Local Loopback
          inet addr:127.0.0.1  Mask:255.0.0.0
          inet6 addr: ::1/128 Scope:Host
          UP LOOPBACK RUNNING  MTU:16436  Metric:1
          RX packets:32 errors:0 dropped:0 overruns:0 frame:0
          TX packets:32 errors:0 dropped:0 overruns:0 carrier:0
          collisions:0 txqueuelen:0
          RX bytes:2592 (2.5 KiB)  TX bytes:2592 (2.5 KiB)
```

Using the General Debian Package

In this chapter, we explain how to configure the UC-8410A-LX's functions.

The following topics are covered in this chapter:

- ❑ **NTP Client**
- ❑ **Execute Scheduled Commands with cron**
 - Updating System Time and RTC
- ❑ **Log Processing Using rsyslog**
 - Rsyslog's Configuration File
 - Syntax of the Selector
- ❑ **OpenSSL**
 - Ciphers
 - Cryptographic Hash Functions
 - Public-key cryptography
- ❑ **The Apache Web Server**
 - Edit ServerName in Apache Configuration File
- ❑ **SFTP**
- ❑ **DNS**
 - /etc/hosts
 - /etc/resolv.conf
 - /etc/nsswitch.conf
- ❑ **IPTABLES**
 - Observing and Erasing Chain Rules
 - Defining a Policy for Chain Rules
 - Append or Delete Rules
- ❑ **rsync**
 - Using rsync for External Backups
 - Automating rsync Backups
- ❑ **NAT**
 - NAT Example
 - Enabling NAT at Bootup
- ❑ **NFS (Network File System)**
 - Setting Up the UC-8410A-LX as an NFS Client
- ❑ **SNMP**
- ❑ **OpenVPN**
 - Static-Key VPN
- ❑ **Package Management**
 - apt-get
 - apt-cache

- List All Available Packages
- Find Package Name and Software Description
- Check Package Information
- Check Dependencies for Specific Packages
- Check Cache Statistics
- Update System Packages
- Install or Upgrade Specific Packages
- Upgrade All Software Packages
- Install Multiple Packages
- Install Packages Without Upgrading
- Upgrade Specific Packages
- Install Specific Package Version
- Remove Packages Without Configuration
- Completely Remove Packages
- Clean Up Disk Space
- Download Only Source Code of Package
- Download and Unpack a Package
- Download, Unpack, and Compile a Package
- Download a Package Without Installing
- Check Broken Dependencies
- Search and Build Dependencies
- Auto Clean Apt-Get Cache
- Auto Remove Installed Packages

NTP Client

The UC-8410A-LX has a built-in NTP (Network Time Protocol) client that is used to initialize a time request to a remote NTP server. Use `#ntpdate <this client utility>` to update the system time.

ntpdate-debian 192.168.1.97

hwclock -w

Visit <http://www.ntp.org> for more information about NTP and NTP server addresses.

```
192.168.4.127 - PuTTY
moxa@moxa:~$ sudo ntpdate 192.168.50.33
6 May 03:55:10 ntpdate[4511]: step time server 192.168.50.33 offset 78338115.278119
sec
moxa@moxa:~$ sudo hwclock -w
moxa@moxa:~$ sudo hwclock
Tue 06 May 2014 03:56:14 AM UTC -0.846314 seconds
```

NOTE Before using the NTP client utility, check your IP and DNS settings to make sure that an Internet connection is available. Refer to Chapter 2 for instructions on how to configure the Ethernet interface, and see Chapter 4 for DNS setting information.

Execute Scheduled Commands with cron

The cron daemon reads `/etc/crontab` to retrieve scripts and other commands to be run at regularly scheduled times.

The cron daemon wakes up every minute and checks each command listed in the crontab file to see if it should be run at that time. Whenever cron executes a command, a report is automatically mailed to the owner of the crontab (or to the user named in the MAILTO environment variable in the crontab, if such a user exists).

Modify the file `/etc/crontab` to schedule an application. Crontab entries follow the format below:

mm	h	dom	mon	dow	user	command
minute	hour	date	month	week	user	Command
0-59	0-23	1-31	1-12	0-6 (0 is Sunday)		

For example, issue the following command if you want to launch a program at 8:00 every day:

```
# /etc/crontab: system-wide crontab
# Unlike any other crontab you don't have to run the `crontab'
# command to install the new version when you edit this file
# and files in /etc/cron.d. These files also have username fields,
# that none of the other crontabs do.

SHELL=/bin/sh
PATH=/usr/local/sbin:/usr/local/bin:/sbin:/bin:/usr/sbin:/usr/bin

# m h dom mon dow user  command
17 * * * * root    cd / && run-parts --report /etc/cron.hourly
25 6 * * * root    test -x /usr/sbin/anacron || ( cd / && run-parts --report
/etc/cron.daily )
47 6 * * 7 root    test -x /usr/sbin/anacron || ( cd / && run-parts --report
/etc/cron.weekly )
52 6 1 * * root    test -x /usr/sbin/anacron || ( cd / && run-parts --report
/etc/cron.monthly )
#
```

Every column in a crontab entry must be marked with a character. The asterisk indicates “every possible unit,” so that setting an asterisk in the day-of-week column will configure cron to run the command on every day of the week. If you wish to run a command “every X minutes” or “every X hours”, then use the format */X.

Updating System Time and RTC

Take the following steps to use cron to update the system time and RTC:

1. Write a shell script named `fixtime.sh` and save it to the `/home` directory.

```
#!/bin/sh
ntpdate time.stdtime.gov.tw
hwclock -w
exit 0
```

2. Reset the access permissions for `fixtime.sh`

```
moxa@moxa:~# chmod 755 fixtime.sh
```

3. Modify the `/etc/crontab` file to run `fixtime.sh` every 10 minutes (i.e.: */10) by adding this line:

```
*/10 * * * * root /home/fixtime.sh
```

NOTE Click the following link for more information on cron.

<http://www.debian-administration.org/articles/56>

Log Processing Using rsyslog

Rsyslog is an enhanced, multi-threaded log reporting utility with a focus on security and reliability. It offers support for on-demand disk buffering, log reports and alarms delivered over TCP, SSL, TLS, and RELP, writing to databases, and email alerting. It is a drop-in replacement for `syslogd`.

Rsyslog is installed but disabled by default.

Enable rsyslog manually	<code>/etc/init.d/rsyslog start</code>
Disable rsyslog manually	<code>/etc/init.d/rsyslog stop</code>
Enable rsyslog	<code>systemctl enable rsyslog.service</code>
Disable rsyslog	<code>systemctl disable rsyslog.service</code>

Rsyslog's Configuration File

The syntax of the `/etc/rsyslog.conf` file is detailed in the `rsyslog.conf(5)` manual page, but there is also HTML documentation available in the `rsyslog-doc` package (`/usr/share/doc/rsyslog-doc/html/index.html`). The overall principle is to write "selector" and "action" pairs. The selector defines all relevant messages, and the action describes how to deal with them.

Each message is associated with an application called a facility in rsyslog documentation:	
auth and authpriv	For authentication
cron	Comes from task scheduling services cron and atd
daemon	Affects a daemon without any special classification (DNS, NTP, etc.)
ftp	Concerns the FTP server
kern	Message coming from the kernel
lpr	Comes from the printing subsystem
mail	Comes from the e-mail subsystem
news	Usenet subsystem message (especially from an NNTP — Network News Transfer Protocol — server that manages newsgroups)
syslog	Messages from the syslogd server, itself
user	User messages (generic)
uucp	Messages from the UUCP server (Unix to Unix Copy Program, an old protocol notably used to distribute e-mail messages)
local0 to local7	Reserved for local use
Each message is also associated with a priority level. Here is the list in decreasing order:	
emerg	Help! There's an emergency, the system is probably unusable.
alert	Hurry up, any delay can be dangerous, action must be taken immediately
crit	Conditions that are critical
err	Error
warn	Warning (potential error)
notice	Conditions that are normal, but the message is important
info	Informative message
debug	Debugging message

Syntax of the Selector

The selector is a semicolon-separated list of *subsystem.priority* pairs (example: **auth.notice;mail.info**). An asterisk represents all subsystems or all priorities (examples: ***.alert** or **mail.***). Several subsystems can be grouped, by separating them with a comma (example: **auth,mail.info**). The priority indicated also covers messages of equal or higher priority; thus **auth.alert** indicates the auth subsystem messages of alert or emergency priority. Prefixed with an exclamation point (!), it indicates the opposite, in other words the strictly lower priorities; **auth.!notice**, thus, indicates messages issued from auth, with info or debug priority. Prefixed with an equal sign (=), it corresponds to precisely and only the priority indicated (**auth.=notice** only concerns messages from auth with notice priority).

Each element in the list on the selector overrides previous elements. It is thus possible to restrict a set or to exclude certain elements from it. For example, **kern.info;kern.!err** means messages from the kernel with priority between info and warn. The **none** priority indicates the empty set (no priorities), and serves to exclude a subsystem from a set of messages. Thus, ***.crit;kern.none** indicates all the messages of priority equal to or higher than critical not coming from the kernel.

NOTE Click the following link for more information on rsyslog.

<https://wiki.debian.org/Rsyslog>

<http://www.rsyslog.com/doc/>

OpenSSL

The UC-8410A supports hardware accelerator with OpenSSL. Type **lsmod** to make sure the **cryptodev** module is loaded.

```
Module                Size Used by
cryptodev             30504  1
```

Check the version of openssl; it should indicate that it was modified by Moxa.

```
moxa@Moxa:~$ dpkg -l | grep openssl
ii  openssl                1.0.1e-2+deb7u7+uc8410A armhf      Secure Socket
Layer (SSL) Secure Sockets Layer toolkit - cryptographic utility on Moxa uc8410A
```

Before enabling hardware accelerator:

```
root@Moxa:/home# openssl speed -evp aes-128-cbc
Doing aes-128-cbc for 3s on 16 size blocks: 5625719 aes-128-cbc's in 2.95s
Doing aes-128-cbc for 3s on 64 size blocks: 1769561 aes-128-cbc's in 2.94s
Doing aes-128-cbc for 3s on 256 size blocks: 498367 aes-128-cbc's in 2.99s
Doing aes-128-cbc for 3s on 1024 size blocks: 125670 aes-128-cbc's in 2.95s
Doing aes-128-cbc for 3s on 8192 size blocks: 16023 aes-128-cbc's in 2.99s
OpenSSL 1.0.1e 11 Feb 2013
built on: Mon Apr 7 03:26:32 UTC 2014
options:bn(64,32) rc4(ptr,char) des(idx,cisc,16,long) aes(partial) idea(int) blowfish(ptr)

compiler: gcc -fPIC -DOPENSSL_PIC -DOPENSSL_THREADS -D_REENTRANT -DDSO_DLFCN -DHAVE_DLFCN_
H -DHAVE_CRYPTODEV -DUSE_CRYPTDEV_DIGESTS -march=armv7-a -Wa,--noexecstack -DTERMIO -O3 -W
all -DOPENSSL_BN_ASM_MONT -DOPENSSL_BN_ASM_GF2m -DSHA1_ASM -DSHA256_ASM -DSHA512_ASM -DAES
_ASM -DGHASH_ASM
The 'numbers' are in 1000s of bytes per second processed.
type                16 bytes    64 bytes    256 bytes    1024 bytes    8192 bytes
aes-128-cbc         30512.37k   38521.06k   42669.55k   43622.40k     43899.80k
```

After enabling hardware accelerator:

```
moxa@Moxa:~$ sudo openssl speed -evp aes-128-cbc
[sudo] password for moxa:
Doing aes-128-cbc for 3s on 16 size blocks: 261302 aes-128-cbc's in 0.14s
Doing aes-128-cbc for 3s on 64 size blocks: 222033 aes-128-cbc's in 0.13s
Doing aes-128-cbc for 3s on 256 size blocks: 139516 aes-128-cbc's in 0.16s
Doing aes-128-cbc for 3s on 1024 size blocks: 48524 aes-128-cbc's in 0.09s
Doing aes-128-cbc for 3s on 8192 size blocks: 8126 aes-128-cbc's in 0.00s
OpenSSL 1.0.1e 11 Feb 2013
built on: Mon Apr 21 06:14:54 UTC 2014
options:bn(64,32) rc4(ptr,char) des(idx,cisc,16,long) aes(partial) idea(int)
blowfish(ptr)

compiler: gcc -fPIC -DOPENSSL_PIC -DOPENSSL_THREADS -D_REENTRANT -DDSO_DLFCN
-DHAVE_DLFCN_H -DHAVE_CRYPTODEV -DUSE_CRYPTDEV_DIGESTS -march=armv7-a
-Wa,--noexecstack -DTERMIO -O3 -Wall -DOPENSSL_BN_ASM_MONT -DOPENSSL_BN_ASM_GF2m
-DSHA1_ASM -DSHA256_ASM -DSHA512_ASM -DAES_ASM -DGHASH_ASM
The 'numbers' are in 1000s of bytes per second processed.
type                16 bytes    64 bytes    256 bytes    1024 bytes    8192 bytes
aes-128-cbc         29863.09k   109308.55k   223225.60k   552095.29k     infk
```

OpenSSL supports a number of different cryptographic algorithms, described in the following subsections.

Ciphers

Ciphers support the following cryptographic methods:

AES, Blowfish, Camellia, SEED, CAST-128, DES, IDEA, RC2, RC4, RC5, Triple DES, GOST 28147-89

Cryptographic Hash Functions

MD5, MD4, MD2, SHA-1, SHA-2, RIPEMD-160, MDC-2, GOST R 34.11-94

Public-key cryptography

RSA, DSA, Diffie–Hellman key exchange, Elliptic curve, GOST R 34.10-2001

NOTE Make sure the version of openssl was built by Moxa, or the hardware accelerator function will not work with other versions.

The Apache Web Server

The Apache HTTP Server Project is an effort to develop and maintain an open-source HTTP server for modern operating systems, including UNIX and Windows NT. The goal of this project is to provide a secure, efficient, and extensible server that provides HTTP services in sync with the current HTTP standards.

APACHE is installed but disabled by default.

Enable apache manually	systemctl enable apache2
Disable apache manually	systemctl disable apache2
Enable apache	inserv -d apache2
Disable apache	inserv -r apache2

Edit ServerName in Apache Configuration File

Edit apache2.conf.

```
moxa@Moxa:~$ sudo vi /etc/apache2/apache2.conf
```

Add an entry in the apache2.conf file for the server name of this device.

```
ServerName xxx
```

Restart apache2.

```
moxa@Moxa:~$ sudo /etc/init.d/apache2 restart
```

NOTE Click the following links for more information on apache.

<https://wiki.debian.org/Apache>

<http://httpd.apache.org/>

SFTP

The default SFTP daemon will start when the system boots up. The login and password used are the same as the system login and password (**moxa/moxa**). You can also configure the SFTP account using the following steps.

1. Create a user & group for SFTP access, without a shell.

```
moxa@Moxa:~$ sudo adduser sftp
[sudo] password for moxa:
Adding user `sftp' ...
Adding new group `sftp' (1003) ...
Adding new user `sftp' (1001) with group `sftp' ...
Creating home directory `/home/sftp' ...
Copying files from `/etc/skel' ...
Enter new UNIX password:
Retype new UNIX password:
passwd: password updated successfully
Changing the user information for sftp
Enter the new value, or press ENTER for the default
  Full Name []:
  Room Number []:
  Work Phone []:
  Home Phone []:
  Other []:
Is the information correct? [Y/n]
```

To block the user account "sftp" from being used for normal Linux logins, and only available for sftp programs, we need to assign a special shell for the account. In the example shown below, we assign the shell "/bin/false" to the user account "sftp" and change account's folder and owner.

```
moxa@Moxa:~$ sudo usermod -s /bin/false sftp
```

```
moxa@Moxa:~$ sudo mkdir /home/sftp/upload/
moxa@Moxa:~$ sudo chown root:root /home/sftp
moxa@Moxa:~$ sudo chown sftp:sftp /home/sftp/upload/
```

2. Use the following command to append SSHD-related configuration to the file "/etc/ssh/sshd_config".

```
Subsystem sftp internal-sftp
#Subsystem sftp /usr/lib/openssh/sftp-server
```

```
Match User sftp
ChrootDirectory /home/%u
ForceCommand internal-sftp
```

3. Restart SSHD Daemon:

```
moxa@Moxa:~$ sudo /usr/sbin/sshd restart
```

4. At this point, the account and its default path should be configured.

NOTE Click the following link for more information on SSH.

<https://wiki.debian.org/SSH>

DNS

The UC-8410A-LX supports DNS client (but not DNS server). To set up DNS client, you need to edit three configuration files: `/etc/hosts`, `/etc/resolv.conf`, and `/etc/nsswitch.conf`.

`/etc/hosts`

This is the first file that the Linux system reads to resolve the host name and IP address.

`/etc/resolv.conf`

This is the most important file that you need to edit when using DNS for the other programs. For example, before using `#ntpdate time.nist.gov` to update the system time, you will need to add the DNS server address to the file. Ask your network administrator which DNS server address you should use. The DNS server's IP address is specified with the `nameserver` command. For example, add the following line to `/etc/resolv.conf` file if the DNS server's IP address is 168.95.1.1:

```
nameserver 168.95.1.1
```

A terminal window screenshot showing the command `sudo cat /etc/resolv.conf` and its output. The output lists several nameserver entries, including the one specified in the text above.

```
10.120.53.100 - PuTTY
moxa@moxa:~$ sudo cat /etc/resolv.conf
#
# resolv.conf This file is the resolver configuration file
# See resolver(5).
#
#nameserver 192.168.1.16
nameserver 168.95.1.1
nameserver 140.115.1.31
nameserver 140.115.236.10
```

`/etc/nsswitch.conf`

This file defines the sequence to resolve the IP address by using `/etc/hosts` file or `/etc/resolv.conf`.

IPTABLES

IPTABLES is an administrative tool for setting up, maintaining, and inspecting the Linux kernel's IP packet filter rule tables. Several different tables are defined, with each table containing built-in chains and user-defined chains.

Each chain is a list of rules that apply to a certain type of packet. Each rule specifies what to do with a matching packet. A rule (such as a jump to a user-defined chain in the same table) is called a **target**.

The UC-8410A-LX supports three types of IPTABLES table: **Filter** tables, **NAT** tables, and **Mangle** tables:

Filter Table—includes three chains:

- INPUT chain
- OUTPUT chain
- FORWARD chain

NAT Table—includes three chains:

PREROUTING chain—transfers the destination IP address (DNAT)

POSTROUTING chain—works after the routing process and before the Ethernet device process to transfer the source IP address (SNAT)

OUTPUT chain—produces local packets

sub-tables

Source NAT (SNAT)—changes the first source packet IP address

Destination NAT (DNAT)—changes the first destination packet IP address

MASQUERADE—a special form for SNAT. If one host can connect to internet, then other computers that connect to this host can connect to the Internet when it the computer does not have an actual IP address.

REDIRECT—a special form of DNAT that re-sends packets to a local host independent of the destination IP address.

Mangle Table—includes two chains, and it has three extensions—TTL, MARK, TOS.

PREROUTING chain—pre-processes packets before the routing process.

OUTPUT chain—processes packets after the routing process.

The following figure shows the IPTABLES hierarchy.

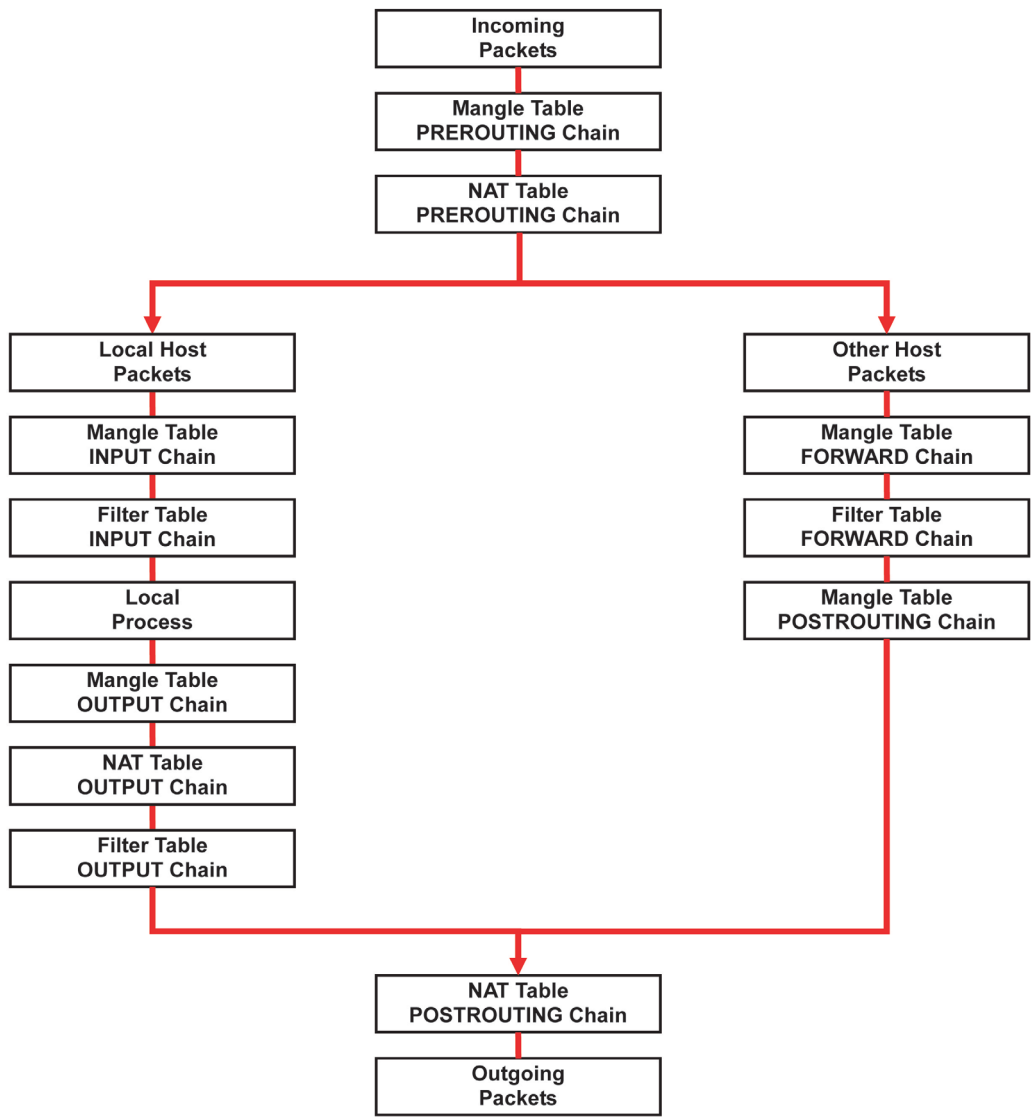
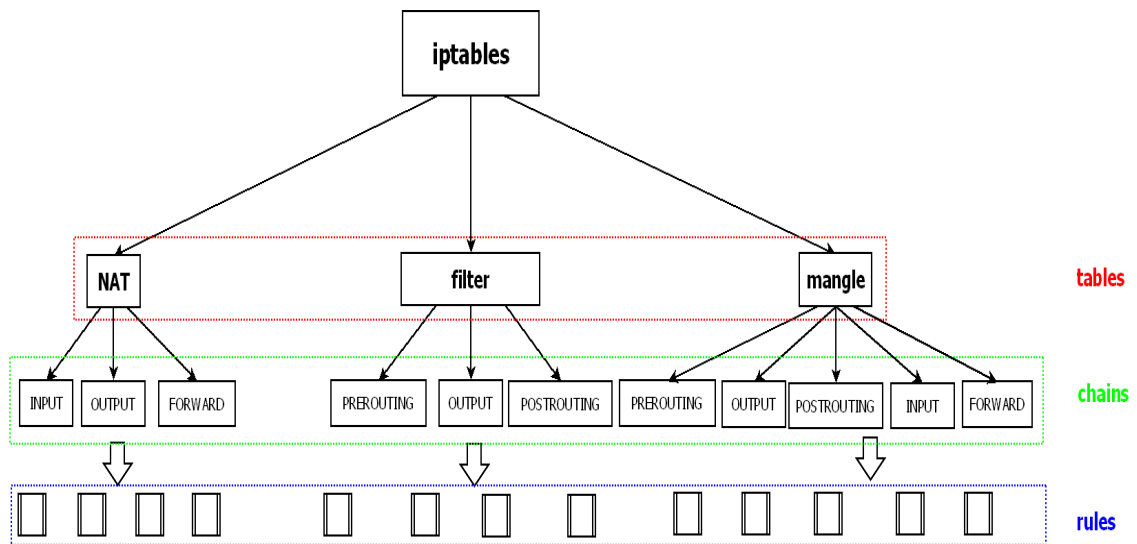

Table	Chain	Rule
NAT (Network translation translation)	PREROUTING	Types of rule <ul style="list-style-type: none"> • Policy • Self-defined
	POSTROUTING	
	OUTPUT	
Filter (Default) (Packet filtering)	INPUT	Targets of rule <ul style="list-style-type: none"> • ACCEPT • DROP • REJECT • LOG • SNAT • DNAT • MASQUERADE
	OUTPUT	
	FORWARD	
Mangle (Packet header modification)	PREROUTING	
	INPUT	
	FORWARD	
	OUTPUT	
	POSTROUTING	



The UC-8410A-LX supports the following sub-modules. Be sure to use the module that matches your application.

The most common modules are already built in to the kernel:

ip6t_eui64.ko	ip6t_ipv6header.ko	nf_contrack_ipv6.ko	xfrm4_mode_tunnel.ko
ip6t_rt.ko	ip6t_LOG.ko	xfrm6_mode_beet.ko	ah4.ko
ip6table_security.ko	ip6t_ah.ko	sit.ko	xfrm4_mode_beet.ko
ip6table_filter.ko	ip6_tables.ko	ipv6.ko	xfrm4_mode_transport.ko
ip6t_frag.ko	ip6table_raw.ko	xfrm6_mode_tunnel.ko	esp4.ko
ip6t_hbh.ko	nf_defrag_ipv6.ko	xfrm6_mode_transport.ko	ipcomp.ko
ip6t_REJECT.ko	ip6t_mh.ko	xfrm_ipcomp.ko	tcp_diag.ko
inet_lro.ko	xfrm4_tunnel.ko	inet_diag.ko	

The basic syntax to enable and load an IPTABLES module is as follows:

Use `lsmod` to check if the `ip_tables` module has already been loaded in the UC-8410A-LX Series. Use `modprobe` to insert and enable the module.

Use the following command to load the modules (`iptable_filter`, `iptable_mangle`, `iptable_nat`):

```
#modprobe iptable_filter
```

Use `iptables`, `iptables-restore`, and `iptables-save` commands to maintain the database.

NOTE IPTABLES plays the role of packet filtering or NAT. Take care when setting up the IPTABLES rules. If the rules are not correct, remote hosts that connect via a LAN or PPP might be denied access. We recommend using the serial console to set up the IPTABLES.

Click on the following links for more information on iptables:

<http://www.linuxguruz.com/iptables/>

<http://www.netfilter.org/documentation/HOWTO//packet-filtering-HOWTO.html>

<https://wiki.debian.org/DebianFirewall>

<https://wiki.debian.org/iptables>

Since the IPTABLES command is very complex, to illustrate the IPTABLES syntax we have divided our discussion of the various rules into three categories: **Observe and erase chain rules**, **Define policy rules**, and **Append or delete rules**.

Observing and Erasing Chain Rules

Usage:

```
# iptables [-t tables] [-I] [-n]
-t tables:      Table to manipulate (default: 'filter'); example: nat or filter.
-L [chain]:     List all rules in selected chains. If no chain is selected, all chains are listed.
-n:            Numeric output of addresses and ports.
```

```
# iptables [-t tables] [-FXZ]
```

```
-F:           Flush the selected chain (all the chains in the table if none is listed).
-X:           Delete the specified user-defined chain.
-Z:           Set the packet and byte counters in all chains to zero.
```

Examples:

```
# iptables -L -n
```

In this example, since we do not use the `-t` parameter, the system uses the default `'filter'` table. Three chains are included: `INPUT`, `OUTPUT`, and `FORWARD`. `INPUT` chains are accepted automatically, and all connections are accepted without being filtered.

```
#iptables -F
#iptables -X
#iptables -Z
```

Defining a Policy for Chain Rules

Usage:

```
# iptables [-t tables] [-P] [INPUT, OUTPUT, FORWARD, PREROUTING, OUTPUT, POSTROUTING]
[ACCEPT, DROP]
```

```
-P:           Set the policy for the chain to the given target.
INPUT:       For packets coming into the UC-8410A-LX Series.
OUTPUT:      For locally-generated packets.
FORWARD:     For packets routed out through the UC-8410A-LX Series.
PREROUTING:  To alter packets as soon as they come in.
POSTROUTING: To alter packets as they are about to be sent out.
```

Examples:

```
#iptables -P INPUT DROP
#iptables -P OUTPUT ACCEPT
#iptables -P FORWARD ACCEPT
# modprobe iptable_nat
#iptables -t nat -P PREROUTING ACCEPT
#iptables -t nat -P OUTPUT ACCEPT
#iptables -t nat -P POSTROUTING ACCEPT
```

In this example, the policy accepts outgoing packets and denies incoming packets.

Append or Delete Rules

Usage:

```
# iptables [-t table] [-AI] [INPUT, OUTPUT, FORWARD] [-io interface] [-p tcp, udp,
icmp, all] [-s IP/network] [--sport ports] [-d IP/network] [--dport ports] -j [ACCEPT.
DROP]
```

-A: Append one or more rules to the end of the selected chain.
-I: Insert one or more rules in the selected chain as the given rule number.
-i: Name of an interface via which a packet is going to be received.
-o: Name of an interface via which a packet is going to be sent.
-p: The protocol of the rule or of the packet to check.
-s: Source address (network name, host name, network IP address, or plain IP address).
--sport: Source port number.
-d: Destination address.
--dport: Destination port number.
-j: Jump target. Specifies the target of the rules; i.e., how to handle matched packets.
For example, ACCEPT the packet, DROP the packet, or LOG the packet.

Examples:

Example 1: Accept all packets from lo interface.

```
# iptables -A INPUT -i lo -j ACCEPT
```

Example 2: Accept TCP packets from 192.168.0.1.

```
# iptables -A INPUT -i eth0 -p tcp -s 192.168.0.1 -j ACCEPT
```

Example 3: Accept TCP packets from Class C network 192.168.1.0/24.

```
# iptables -A INPUT -i eth0 -p tcp -s 192.168.1.0/24 -j ACCEPT
```

Example 4: Drop TCP packets from 192.168.1.25.

```
# iptables -A INPUT -i eth0 -p tcp -s 192.168.1.25 -j DROP
```

Example 5: Drop TCP packets addressed for port 21.

```
# modprobe xt_tcpudp
# iptables -A INPUT -i eth0 -p tcp --dport 21 -j DROP
```

Example 6: Accept TCP packets from 192.168.0.24 to UC-8410A Series's port 137, 138, 139

```
# iptables -A INPUT -i eth0 -p tcp -s 192.168.0.24 --dport 137:139 -j ACCEPT
```

Example 7: Log TCP packets that visit UC-8410A Series's port 25.

```
# iptables -A INPUT -i eth0 -p tcp --dport 25 -j LOG
```

Example 8: Drop all packets from MAC address 01:02:03:04:05:06.

```
# modprobe xt_mac
# iptables -A INPUT -i eth0 -p all -m mac --mac-source 01:02:03:04:05:06 -j DROP
```

NOTE: In Example 8, remember to issue the command `#modprobe ipt_mac` first to load module `ipt_mac`.

rsync

rsync is a utility software and network protocol that synchronizes files and directories from one location to another while minimizing data transfer by using delta encoding when appropriate. It also has the option to provide encrypted transfer by use of SSH. SSL encrypted transfer can be done via Stunnel wrapping. rsync uses the 'rsync algorithm', which provides a very fast method for bringing remote files into sync. rsync can copy or display directory contents and copy files, optionally using compression and recursion.

The **rsync** command can be used to back up data to the destination location with encryption. The following example illustrates how to back up data from directory1 to directory2:

```
moxa@moxa:~$ sudo rsync -avP /Directory1/ /Directory2/
```

-v, --verbose	increase verbosity
-a, --archive	archive mode; equals -rlptgoD (no -H,-A,-X)
-P --progress	show progress during transfer
--partial	keep partially transferred files

Using rsync for External Backups

rsync can be configured in several different ways for external backups, but we will go over the most practical (also the easiest and most secure) method of tunneling rsync through SSH. Most servers and even many clients already have SSH, and it can be used for your rsync backups. We will show you the process to get one Linux machine to back up to another on a local network. The process would be exactly the same if one host was somewhere on the Internet; just note that port 22 (or whatever port you have SSH configured on), would need to be forwarded on any network equipment on the server's side of things.

Other than installing SSH and rsync on the server, all that really needs to be done is to set up the repositories on the server where you would like the files backed up, and make sure that SSH is locked down. Make sure the user you plan on using has a complex password. You might also want to switch the port (default port is 22) that SSH listens on for added security.

We will run the same command that we did for using rsync on a local computer, but include the necessary additions for tunneling rsync through SSH to a server on my local network. For user "user" connecting to "192.168.1.1" and using the same switches as above (-avP) we will run the following:

```
moxa@moxa:~$ sudo rsync -avP -e ssh /Directory1/ user@192.168.1.1:/Directory2/
```

Automating rsync Backups

Cron can be used on Linux to automate the execution of commands, such as rsync. Using Cron, we can have our Linux system run nightly backups, or however often you would like them to run.

To edit the cron table file for the user you are logged in as, run:

```
moxa@moxa:~$ sudo crontab -e
```

You will need to be familiar with vi in order to edit this file. Type "I" for insert, and then begin editing the cron table file.

Cron uses the following syntax: minute of the hour, hour of the day, day of the month, month of the year, day of the week, command.

It can be a little confusing at first, so let me give you an example. The following command will run the rsync command every night at 10 PM:

```
0 22 * * * rsync -avP /Directory1/ /Directory2/
```

The first "0" specifies the minute of the hour, and "22" specifies 10 PM. Since we want this command to run daily, we will leave the rest of the fields with asterisks and then paste the rsync command.

NOTE Click the following link for more information on iptables and rsync.
<http://rsync.samba.org/>

NAT

The NAT (Network Address Translation) protocol translates IP addresses used on one network into IP addresses used on a connecting network. One network is designated the inside network and the other is the outside network. Typically, the DA-682A-LX connects several devices on a network and maps local inside network addresses to one or more global outside IP addresses, and un-maps the global IP addresses on incoming packets back into local IP addresses.



ATTENTION

Click on the following link for more information about NAT:
<http://www.netfilter.org/documentation/HOWTO//packet-filtering-HOWTO.html>

NAT Example

In this example, the IP address of all packets leaving LAN1 are changed to **192.168.3.127** (you will need to load the module `ipt_MASQUERADE`):

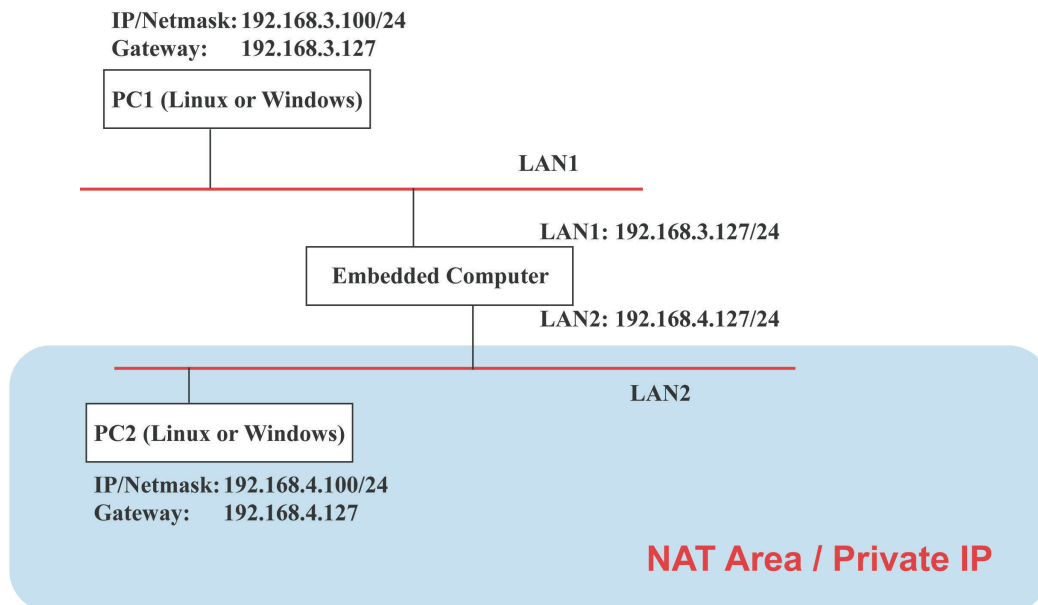

Enabling NAT at Bootup

In most real world situations, you will want to use a simple shell script to enable NAT when the DA-682A-LX boots up. The following script is an example.

```
#!/bin/bash
# If you put this shell script in the /home/nat.sh
# Remember to chmod 744 /home/nat.sh
# Edit the rc.local file to make this shell startup automatically
# vi /etc/rc.local
# Add a line in the end of rc.local /home/nat.sh
EXIF= "eth0" #This is an external interface for setting up a valid IP address.
EXNET= "192.168.4.0/24" #This is an internal network address.
# Step 1. Insert modules.
# Here 2> /dev/null means the standard error messages will be dump to null device.
modprobe ip_tables 2> /dev/null
modprobe ip_nat_ftp 2> /dev/null
modprobe ip_nat_irc 2> /dev/null
modprobe ip_conntrack 2> /dev/null
modprobe ip_conntrack_ftp 2> /dev/null
modprobe ip_conntrack_irc 2> /dev/null
# Step 2. Define variables, enable routing and erase default rules.
PATH=/bin:/sbin:/usr/bin:/usr/sbin:/usr/local/bin:/usr/local/sbin
export PATH
echo "1" > /proc/sys/net/ipv4/ip_forward
/sbin/iptables -F
/sbin/iptables -X
/sbin/iptables -Z
/sbin/iptables -F -t nat
/sbin/iptables -X -t nat
/sbin/iptables -Z -t nat
/sbin/iptables -P INPUT ACCEPT
/sbin/iptables -P OUTPUT ACCEPT
/sbin/iptables -P FORWARD ACCEPT
/sbin/iptables -t nat -P PREROUTING ACCEPT
/sbin/iptables -t nat -P POSTROUTING ACCEPT
/sbin/iptables -t nat -P OUTPUT ACCEPT
# Step 3. Enable IP masquerade.
#ehco 1 > /proc/sys/net/ipv4/ip_forward#modprobe ipt_MASQUERADE#iptables -t nat -
A POSTROUTING -o eth0 -j MASQUERADE
```

NFS (Network File System)

The Network File System (NFS) is used to mount a disk partition on a remote machine, as if it were on a local hard drive, allowing fast, seamless sharing of files across a network. NFS allows users to develop applications for the UC-8410A Series, without worrying about the amount of disk space that will be available. The UC-8410A Series supports NFS protocol for client.

NFS has been installed but disabled by default. Check the following table for details.

Enable nfs manually	<pre>sudo /etc/init.d/nfs-common start sudo /etc/init.d/nfs-kernel-server start sudo /etc/init.d/rpcbind start</pre>
Disable nfs manually	<pre>sudo /etc/init.d/nfs-common stop sudo /etc/init.d/nfs-kernel-server stop sudo /etc/init.d/rpcbind stop</pre>
Enable nfs	<pre>insserv -d nfs-common insserv -d nfs-kernel-server insserv -d /etc/init.d/rpcbind</pre>
Disable nfs	<pre>insserv -r nfs-common insserv -r nfs-kernel-server insserv -r /etc/init.d/rpcbind</pre>

Setting Up the UC-8410A-LX as an NFS Client

The following procedure is used to mount a remote NFS Server.

Step 1: Create a folder to link a mount point on the NFS Client site.

```
#mkdir -p /home/nfs/public
```

Step 2: Mount the remote directory to a local directory.

```
#mount -t nfs NFS_Server(IP) : /directory /mount/point
```

Example

```
: #mount -t nfs 192.168.3.100/home/public /home/nfs/public
```

NOTE Click the following links for more information on NFS:

<http://www.tldp.org/HOWTO/NFS-HOWTO/index.html>

<http://nfs.sourceforge.net/nfs-howto/client.html>

<http://nfs.sourceforge.net/nfs-howto/server.html>

SNMP

The UC-8410A Series has SNMP (Simple Network Management Protocol) agent software built in. It supports RFC1317 RS-232 like group and RFC 1213 MIB-II. SNMP daemon is installed but disabled by default. You can activate the daemon manually or set it to be enabled by default.

You will need to start/stop the service with the following commands.

Start snmpd manually	sudo /etc/init.d/snmpd start
Stop snmpd manually	sudo /etc/init.d/snmpd stop
Enable snmpd	insserv -d snmpd
Disable snmpd	insserv -r snmpd

The following simple example shows to use an SNMP browser on the host site to query the UC-8410A Series, which is the SNMP agent. The UC-8410A Series will respond.

```

debian:~# snmpwalk -v 2c -c public -Cc 192.168.27.115
iso.3.6.1.2.1.1.1.0 = STRING: "Linux Moxa 3.2.0_UC81XX #3 Thu Apr 24 10:38:04 CST 2014
armv71"
iso.3.6.1.2.1.1.2.0 = OID: iso.3.6.1.4.1.8691.12.8410
iso.3.6.1.2.1.1.3.0 = Timeticks: (201692) 0:33:36.92
iso.3.6.1.2.1.1.4.0 = STRING: "Moxa Inc., Embedded Computing Business. <www.moxa.com>"
iso.3.6.1.2.1.1.5.0 = STRING: "Moxa"
iso.3.6.1.2.1.1.6.0 = STRING: "Fl.4, No.135, Lane 235, Baoquao Rd., Xindian Dist.,
New Taipei City, Taiwan, R.O.C.\""
iso.3.6.1.2.1.1.7.0 = INTEGER: 72
iso.3.6.1.2.1.1.8.0 = Timeticks: (4) 0:00:00.04
iso.3.6.1.2.1.1.9.1.2.1 = OID: iso.3.6.1.6.3.10.3.1.1
iso.3.6.1.2.1.1.9.1.2.2 = OID: iso.3.6.1.6.3.11.3.1.1
iso.3.6.1.2.1.1.9.1.2.3 = OID: iso.3.6.1.6.3.15.2.1.1
iso.3.6.1.2.1.1.9.1.2.4 = OID: iso.3.6.1.6.3.1
iso.3.6.1.2.1.1.9.1.2.5 = OID: iso.3.6.1.2.1.49
iso.3.6.1.2.1.1.9.1.2.6 = OID: iso.3.6.1.2.1.4
iso.3.6.1.2.1.1.9.1.2.7 = OID: iso.3.6.1.2.1.50
iso.3.6.1.2.1.1.9.1.2.8 = OID: iso.3.6.1.6.3.16.2.2.1
iso.3.6.1.2.1.1.9.1.3.1 = STRING: "The SNMP Management Architecture MIB."
iso.3.6.1.2.1.1.9.1.3.2 = STRING: "The MIB for Message Processing and Dispatching."
iso.3.6.1.2.1.1.9.1.3.3 = STRING: "The management information definitions for the SNMP
User-based Security Model."
iso.3.6.1.2.1.1.9.1.3.4 = STRING: "The MIB module for SNMPv2 entities"
iso.3.6.1.2.1.1.9.1.3.5 = STRING: "The MIB module for managing TCP implementations"
iso.3.6.1.2.1.1.9.1.3.6 = STRING: "The MIB module for managing IP and ICMP
implementations"
iso.3.6.1.2.1.1.9.1.3.7 = STRING: "The MIB module for managing UDP implementations"
iso.3.6.1.2.1.1.9.1.3.8 = STRING: "View-based Access Control Model for SNMP."
iso.3.6.1.2.1.1.9.1.4.1 = Timeticks: (3) 0:00:00.03
iso.3.6.1.2.1.1.9.1.4.2 = Timeticks: (3) 0:00:00.03
iso.3.6.1.2.1.1.9.1.4.3 = Timeticks: (3) 0:00:00.03
iso.3.6.1.2.1.1.9.1.4.4 = Timeticks: (4) 0:00:00.04
iso.3.6.1.2.1.1.9.1.4.5 = Timeticks: (4) 0:00:00.04
iso.3.6.1.2.1.1.9.1.4.6 = Timeticks: (4) 0:00:00.04
iso.3.6.1.2.1.1.9.1.4.7 = Timeticks: (4) 0:00:00.04
iso.3.6.1.2.1.1.9.1.4.8 = Timeticks: (4) 0:00:00.04
iso.3.6.1.2.1.25.1.1.0 = Timeticks: (2866708) 7:57:47.08
iso.3.6.1.2.1.25.1.2.0 = Hex-STRING: 07 DE 05 0D 0A 12 15 00 2B 00 00

```

```
iso.3.6.1.2.1.25.1.3.0 = INTEGER: 1536
iso.3.6.1.2.1.25.1.4.0 = STRING: "mac=00:90:e8:00:00:07 sd=0 ver=1.0.0S11
console=ttyO0,115200n8 root=/dev/mmcblk0p2 rootfstype=ext4 rootwait"
iso.3.6.1.2.1.25.1.5.0 = Gauge32: 1
iso.3.6.1.2.1.25.1.6.0 = Gauge32: 58
iso.3.6.1.2.1.25.1.7.0 = INTEGER: 0
iso.3.6.1.2.1.25.1.7.0 = No more variables left in this MIB View (It is past the end
of the MIB tree)
```

NOTE Click the following links for more information on MIB II.

<http://www.faqs.org/rfcs/rfc1213.html>

<https://wiki.debian.org/SNMP>

OpenVPN

Install OpenVPN, using the `apt-get install openvpn` command. Use the `insserv -d openvpn` command to enable the OpenVPN package at the next bootstrap. To enable the OpenVPN package with immediate effect, you can use the `/etc/init.d/openvpn start` command.

OpenVPN supports user/pass, pre-shared key, certificates, etc., to authenticate users. To begin with, check to make sure that the system has a virtual device `/dev/net/tun`.

An Ethernet bridge is used to connect different Ethernet networks together. The Ethernets are bundled into one bigger, "logical" Ethernet. Each Ethernet corresponds to one physical interface (or port) that is connected to the bridge. Type the following command to load driver "tun".

```
# modprobe tun
```

On each OpenVPN machine, you should generate a working directory, such as `/etc/openvpn`, where script files and key files reside. Once established, all operations will be performed in that directory.

Enable openvpn manually	<code>sudo /etc/init.d/openvpn start</code>
Disable openvpn manually	<code>sudo /etc/init.d/openvpn stop</code>
Enable openvpn	<code>insserv -d openvpn</code>
Disable openvpn	<code>insserv -r openvpn</code>

Static-Key VPN

In the server's `/etc/openvpn` directory, run the following command to generate a static key

```
moxa@Moxa:/etc/openvpn$ sudo openvpn --genkey --secret static.key
```

Copy this static key to the clients `/etc/openvpn` directory using a secure channel like scp or sftp.

On the server, create a new `/etc/openvpn/tun0.conf` file and add the following:

```
dev tun0
ifconfig 10.9.8.1 10.9.8.2
secret /etc/openvpn/static.key
```

This is where 10.9.8.x is your VPN subnetwork, 10.9.8.1 is the IP of the server, and 10.9.8.2 the IP of the client.

On the client, copy `/etc/openvpn/static.key` from the server and create a new `/etc/openvpn/tun0.conf` file, and then add the following to the file:

```
remote your-server.org
dev tun0
ifconfig 10.9.8.2 10.9.8.1
secret /etc/openvpn/static.key
```

Start OpenVPN manually on both sides with the following command:

```
moxa@Moxa:/etc/openvpn$ sudo openvpn --config /etc/openvpn/tun0.conf --verb 6 //
verbose output.
```



ATTENTION

When using an OpenVPN-related application, you need to create a firewall policy.

On the server's firewall, open UDP 1194 (default port). If you are using shorewall on both devices, add a new VPN zone to represent tun0 and create a default policy for it. This means adding something to the following files in /etc/shorewall:

```
zone
interfaces
policy
```

Bear in mind that 90% of all connection problems encountered by new OpenVPN users are firewall-related.

NOTE Click the following links for more information on OpenVPN:

<https://wiki.debian.org/OpenVPN>

<http://openvpn.net/>

Package Management

In this section, we explain how you can quickly learn to install, remove, update, and search for software packages using the `apt-get` and `apt-cache` commands from the command line. Some useful commands that will help you handle package management in Debian/Ubuntu based systems are listed in this section.

apt-get

The `apt-get` utility is a powerful and free package management command line program that is used with Ubuntu's APT (Advanced Packaging Tool) library to install new software packages, remove existing software packages, upgrade existing software packages, and even upgrade the entire operating system.

apt-cache

The `apt-cache` command line tool is used to search for apt software package cache. That is, the tool is used to search for software packages, collect package information, and search for which available packages are ready for installation on Debian or Ubuntu based systems.

List All Available Packages

Use the following command to list all available packages:

```
moxa@Moxa:~$ sudo apt-cache pkgnames
```

Find Package Name and Software Description

To find the package name and description, use the "search" flag. Using "search" with `apt-cache` will display a list of matched packages with short descriptions. For example, if you would like to find the description of package "vim", use the following command:

```
moxa@Moxa:~$ sudo apt-cache search vim
```

To find and list all packages starting with "vim", use the following command:

```
moxa@moxa:~$ sudo apt-cache pkgnames vim
```

Check Package Information

To get more detailed package information (e.g., version number, check sums, size, installed size, category) along with the short description, use the **show** sub-command, as shown below:

```
moxa@moxa:~$ sudo apt-cache show vim
```

Check Dependencies for Specific Packages

Use the **showpkg** sub command to check the dependencies for particular software packages, and whether those dependent packages are installed or not. For example, use the **showpkg** command along with the package name as shown below:

```
moxa@moxa:~$ sudo apt-cache showpkg vim
```

Check Cache Statistics

The **stats** sub command displays the overall statistics of the cache. For example, the following command will show the complete package information of all packages found in the cache:

```
moxa@moxa:~$ sudo apt-cache stats
```

Update System Packages

The **update** command is used to resynchronize the package index files from their sources specified in the **/etc/apt/sources.list** file. The updated commands will fetch the packages from their locations and update the packages to the newer version.

```
moxa@moxa:~$ sudo apt-get update
```

Install or Upgrade Specific Packages

Use the **install** sub command to install or upgrade one or more packages.

```
moxa@moxa:~$ sudo apt-get install vim
```

Upgrade All Software Packages

The **upgrade** command is used to upgrade all software packages currently installed on the system.

```
moxa@moxa:~$ sudo apt-get upgrade
```

Install Multiple Packages

You can add more than one package name along with the command in order to install multiple packages at the same time. For example, the following command will install packages "vim" and "goaccess":

```
moxa@moxa:~$ sudo apt-get install vim goaccess
```

Install Packages Without Upgrading

Use the `--no-upgrade` sub command to prevent the installed packages from being upgraded.

```
moxa@Moxa:~$ sudo apt-get install packageName --no-upgrade
```

Upgrade Specific Packages

Use the `--only-upgrade` sub command to NOT install new packages, but only upgrade already installed packages.

```
moxa@Moxa:~$ sudo apt-get install packageName --only-upgrade
```

Install Specific Package Version

To install a specific version of a package, use "=" with the package name and the version as shown below:.

```
moxa@Moxa:~$ sudo apt-get install wget=1.13.4-3+deb7u1
```

Remove Packages Without Configuration

To un-install software packages without removing their configuration files (for reusing the same configuration later), use the `remove` command:

```
moxa@Moxa:~$ sudo apt-get remove wget
```

Completely Remove Packages

To remove software packages along with their configuration files, use the `purge` sub command:

```
moxa@Moxa:~$ sudo apt-get remove --purge wget
```

Clean Up Disk Space

Use the `clean` command to free up the disk space by cleaning retrieved (downloaded) `.deb` files (packages) from the local repository.

```
moxa@Moxa:~$ sudo apt-get clean
```

Download Only Source Code of Package

To download only the source code of a particular package, use the `--download-only source` option along with the package name as shown below:

```
moxa@Moxa:~$ sudo apt-get --download-only source wget
```

Download and Unpack a Package

To download and unpack the source code of a package to a specific directory, type the following command:

```
moxa@Moxa:~$ sudo apt-get source wget
```

Download, Unpack, and Compile a Package

You can also download, unpack, and compile the source code all at the same time, using the `-compile` option, as shown below:

```
moxa@Moxa:~$ sudo apt-get --compile source wget
```

Download a Package Without Installing

Use the `download` option to download any given package without installing it. For example, the following command will only download the “nethogs” package to the current working directory.

```
moxa@Moxa:~$ sudo apt-get download wget
```

Check Broken Dependencies

The `check` command is a diagnostic tool used to update a package cache and check for broken dependencies.

```
moxa@Moxa:~$ sudo apt-get check
```

Search and Build Dependencies

The `build-dep` command searches the local repositories in the system and installs the build dependencies for a package. If the package does not exist in the local repository, it will return an error code.

```
moxa@Moxa:~$ sudo apt-get build-dep wget
```

Auto Clean Apt-Get Cache

The `autoclean` command deletes all `.deb` files from `/var/cache/apt/archives` to free up a significant volume of disk space:

```
moxa@Moxa:~$ sudo apt-get autoclean
```

Auto Remove Installed Packages

The `autoremove` sub command is used to automatically remove packages that were installed to satisfy dependencies on other packages, but are no longer required. For example, the following command will remove the installed package `wget`, including all its dependent packages:

```
moxa@Moxa:~$ sudo apt-get autoremove wget
```

Programmer's Guide

In this chapter, we briefly introduce the tool-chain and teach you how to program the UC-8410A-LX. The programming example package can be downloaded from Moxa's website.

The following topics are covered in this chapter:

❑ **Linux Tool Chain Introduction**

- Native Compilation
- Cross Compilation
- Obtaining Help

❑ **Test Program—Developing Hello.c**

- Compiling Hello.c with Native Compilation
- Compiling Hello.c with Cross Compilation

❑ **Makefile Example**

❑ **Modbus**

❑ **RTC (Real Time Clock)**

❑ **WDT (Watch Dog Timer)**

❑ **Cryptographic Hardware Accelerator**

❑ **Buzzer and LEDs**

❑ **Configuring the Cellular Connection**

- Using Cell_mgmt
- Dial-Up Step-by-Step
- Dial-Up
- Cellular Module
- GPS

❑ **Configuring the Wi-Fi Connection**

- Configuring WPA2 Settings

Linux Tool Chain Introduction

Linux Tool-Chain contains the necessary libraries and compilers for developing your programs. The UC-8410A Series computers support both native and cross-compiling of code. Native compiling is more straightforward since all the coding and compilation can be done directly on the UC-8410A-LX, but since you will be constrained by the UC-8410A's ARM CPU resources, the compilation speed is slower. On the other hand, cross compiling can be done on any Linux machine with the correct tool-chain, and the compilation speed is much faster.

Native Compilation

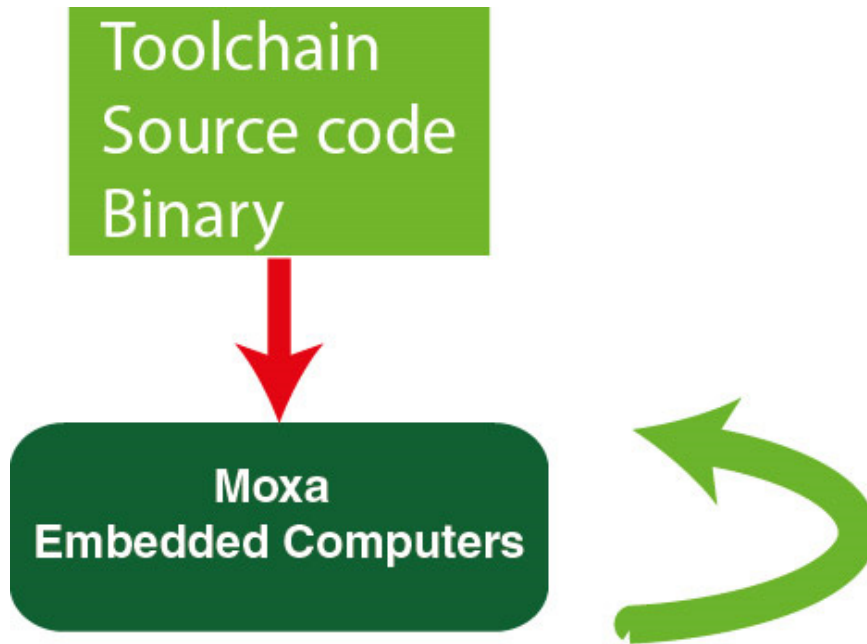

Follow these steps to update the package menu.

1. Make sure network connection is available.
2. Use **apt-get update** to update the Debian package list.

```
moxa@Moxa:~$ sudo apt-get update
```

3. Install the native compiler and necessary packages

```
moxa@Moxa:~$ sudo apt-get install gcc build-essential flex bison automake
```

Cross Compilation

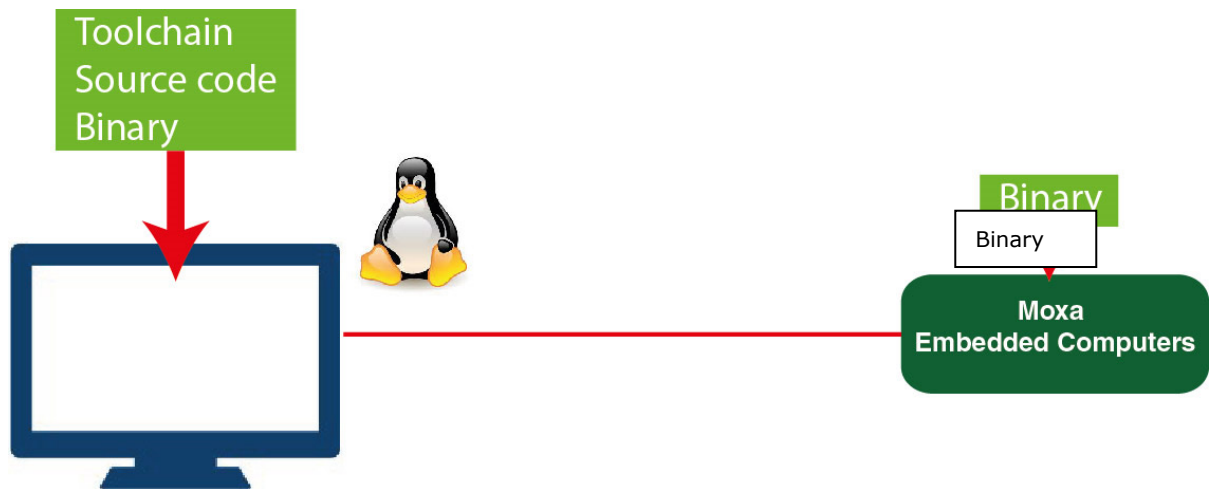

To ensure that an application will be able to run correctly when installed on the UC-8410A-LX, you must ensure that it is compiled and linked to the same libraries that will be present on the UC-8410A-LX computer. This is particularly true when the RISC Cortex processor architecture of the UC-8410A differs from the CISC x86 processor architecture of the host system, but it is also true if the processor architecture is the same.

The host tool chain that comes with the UC-8410A-LX contains a suite of cross compilers and other tools, as well as the libraries and headers that are necessary to compile applications for the UC-8410A. The host environment must be running Linux to install the UC-8410A GNU Tool Chain. We have confirmed that the following Linux distributions can be used to install the tool chain:

Redhat 7.3/8.0/9.0, Fedora core 1 to 20, Debian 7/8/9 32/64 bit platforms.

The Tool Chain will need about 300 MB of hard disk space on your PC. To install the tool-chain, download the tool-chain file from Moxa's website.

After you `untar` the package, run the install script and follow the instructions.

```

user@Linux: /home#sh
arm-linux-gnueabihf_4.7_Build_amd64_16053113.sharm-linux-gnueabihf_4.7_Build_i386
_16062000.sh

Welcome to MOXA ARM Linux platform toolchain installer.
This toolchain built with arm-linux-gnueabihf compiler v4.7.3 and glibc v2.15.
Any problem please contact support@moxa.com

Press the number:
1.Install Linux cross compiler tool.
2.Uninstall Linux cross compiler tool.
3.Exit or CTRL+C
1
usr/local/arm-linux-gnueabihf-4.7-20130415/
usr/local/arm-linux-gnueabihf-4.7-20130415/bin/
usr/local/arm-linux-gnueabihf-4.7-20130415/bin/arm-linux-gnueabihf-gcc-ranlib
usr/local/arm-linux-gnueabihf-4.7-20130415/bin/arm-linux-gnueabihf-ld
usr/local/arm-linux-gnueabihf-4.7-20130415/bin/arm-linux-gnueabihf-objcopy
usr/local/arm-linux-gnueabihf-4.7-20130415/bin/arm-linux-gnueabihf-ld.gold
...
...

usr/local/arm-linux-gnueabihf-4.7-20130415/lib/gcc/arm-linux-gnueabihf/4.7.3/incl
ude/stdbool.h
usr/local/arm-linux-gnueabihf-4.7-20130415/lib/gcc/arm-linux-gnueabihf/4.7.3/incl
ude/mf-runtime.h
usr/local/arm-linux-gnueabihf-4.7-20130415/lib/gcc/arm-linux-gnueabihf/4.7.3/incl
ude/mmintrin.h
usr/local/arm-linux-gnueabihf-4.7-20130415/lib/gcc/arm-linux-gnueabihf/4.7.3/incl
ude/stddef.h
usr/local/arm-linux-gnueabihf-4.7-20130415/20130415-gcc-linaro-arm-linux-gnueabihf
f
-----
arm-linux-gnueabihf install complete
Please export these environment variables before using toolchain:
export PATH=$PATH:/usr/local/arm-linux-gnueabihf-4.7-20130415/bin

```

Wait for a few minutes while the Tool Chain is installed automatically on your Linux PC. Once the host environment has been installed, add the directory `/usr/local/arm-linux-gnueabihf-4.7-20130415//bin` to your path and the directory `/usr/local/arm-linux-gnueabihf-4.7-20130415//man` to your manual path. You can do this temporarily for the current login session by issuing the following commands:

```

#export PATH="/usr/local/arm-linux-gnueabihf-4.7/usr/bin:$PATH"
#export MANPATH="/usr/local/arm-linux-gnueabihf-4.7/usr/man:$MANPATH"

```

Alternatively, you can add the same commands to `$HOME/.bash_profile` to cause it to take effect for all login sessions initiated by this user.

NOTE The toolchain will be installed at `/usr/local/arm-linux-gnueabihf-4.7-20130415/`. This means that the original `/usr/local/arm-linux-gnueabihf-4.7-20130415/` path will be overwritten. The version number, "4.7-20130415" is just an example. The actual version number will differ based on the toolchain that you download.

Obtaining Help

You can use the Linux **man** utility to get help on many of the utilities provided by the tool chain located at `/usr/local/arm-linux-gnueabi4.7-20130415/share/doc/gcc-linaro-arm-linux-gnueabi4.7-20130415/man/`.

Cross Compiling Applications and Libraries

To compile a simple C application, use the cross compiler instead of the regular compiler:

```
#arm-linux-gnueabi4.7-20130415-gcc -o example -Wall -g -O2 example.c
#arm-linux-gnueabi4.7-20130415-strip -s example
#arm-linux-gnueabi4.7-20130415-gcc -ggdb -o example-debug example.c
```

Test Program—Developing Hello.c

In this section, we use the standard “Hello” programming example to illustrate how to develop a program for the UC-8410A-LX.

```
#include <stdio.h>
int main()
{
    printf("Hello World\n");
    return 0;
}
```

The following compiler tools are provided:

ar	Manage archives (static libraries)
as	Assembler
c++, g++	C++ compiler
cpp	C preprocessor
gcc	C compiler
gdb	Debugger
ld	Linker
nm	Lists symbols from object files
objcopy	Copies and translates object files
objdump	Displays information about object files
ranlib	Generates indexes to archives (static libraries)
readelf	Displays information about ELF files
size	Lists object file section sizes
strings	Prints strings of printable characters from files (usually object files)
strip	Removes symbols and sections from object files (usually debugging information)

Compiling Hello.c with Native Compilation

Follow these steps for native compilation.

```
apt-get install build-essential
sudo gcc -o hello-release hello.c
sudo strip -s hello-release
```

After compiling the program, issue the following command to execute the program.

```
moxa@moxa:~$ ./hello-release
Hello World
```

Compiling Hello.c with Cross Compilation

Follow these steps for cross compilation.

1. Connect the UC-8410A-LX Series to a Linux PC.
2. Install Tool Chain (GNU Cross Compiler & glibc).
3. Set the cross compiler and glibc environment variables.
4. Code and compile the program.
5. Download the program to the UC-8410A Series via SFTP, NFS, SCP, or RSYNC.
6. Debug the program
 - If bugs are found, return to Step 4.
 - If no bugs are found, continue with Step 7
7. Back up the user directory (distribute the program to additional UC-8410A Series units if needed).

The CD provided with the UC-8410A contains several example programs. Here we use **Hello.c** as an example to show you how to compile and run your applications. Type the following commands from your PC to copy the files used for this example from the CD to your computer's hard drive:

```
# cd /tmp/  
# mkdir example  
# cp -r /mnt/cdrom/example/* /tmp/example
```

To compile the program, go to the **Hello** subdirectory and issue the following commands:

```
#cd example/hello  
#make
```

You should receive the following response:

```
[root@localhost hello]# make  
arm-linux-gnueabi-gcc -o hello-release hello.c  
arm-linux-gnueabi-strip -s hello-release
```

hello-release—an ARM platform execution file (created specifically to run on the UC-8410A Series).

Uploading and Running the "Hello" Program

The program can be uploaded via SFTP, NFS, SCP, or RSYNC.

Use the following command to upload **hello-release** to the UC-8410A Series via SFTP.

From the PC, type:

```
#ftp 192.168.3.127
```

Use the "put" command to initiate the file transfer:

```
sftp> put hello-release  
Uploading hello-release to /home/moxa/hello-release  
hello-release
```

From the UC-8410A-LX, type:

```
# chmod +x hello-release  
# ./hello-release
```

The word **Hello** will be printed on the screen.

```
moxa@moxa:~$ ./hello-release  
Hello World
```

Makefile Example

The following Makefile is copied from the Hello example on the UC-8410A-LX's example package. It is used for cross compiling.

```
CC = arm-linux-gnueabi-gcc
CPP = arm-linux-gnueabi-g++
SOURCES = hello.c
OBJS = $(SOURCES:.c=.o)
all:    hello
hello:  $(OBJS)
        $(CC) -o $@ $^ $(LDFLAGS) $(LIBS)
clean:
        rm -f $(OBJS) hello core *.gdb
```

For native compiling, change:

```
CC = gcc
CPP = g++
```

Modbus

The Modbus protocol is a messaging structure used to establish master-slave/client-server communication between intelligent devices. It is a de facto standard, truly open, and the most widely used network protocol in industrial manufacturing environments. It has been implemented by hundreds of vendors on thousands of different devices to transfer discrete/analog I/O and register data between control devices.

The libmodbus version in Debian 8 is v3.0.6. We use libmodbus as our modbus package. Download the source and example code from the following link.

<http://libmodbus.org/releases/libmodbus-3.0.6.tar.gz>

NOTE Click the following link for more information about libmodbus:
<http://libmodbus.org/>

RTC (Real Time Clock)

The device node is located at `/dev/rtc0`. The UC-8410A-LX Series supports Linux standard simple RTC control. You must `include <linux/rtc.h>` in your program to use the following functions.

Function	RTC_RD_TIME
Description	Reads time information from the RTC; returns the value of argument 3.
Usage	struct rtc_time rtc_tm; ioctl(fd, RTC_RD_TIME, &rtc_tm);
Function	RTC_SET_TIME
Description	Sets the RTC time. Argument 3 will be passed to the RTC.
Usage	struct rtc_time rtc_tm; ioctl(fd, RTC_SET_TIME, &rtc_tm);
Function	RTC_ALM_SET
Description	Sets the alarm time.
Usage	struct rtc_time rtc_tm; ioctl(fd, RTC_ALM_SET, &rtc_tm);

Function	RTC_ALM_READ
Description	Reads the alarm time.
Usage	struct rtc_time rtc_tm; ioctl(fd, RTC_ALM_READ, &rtc_tm);
Function	RTC_IRQP_SET
Description	Sets the IRQ rate
Usage	unsigned long tmp = 2; int ioctl(fd, RTC_IRQP_SET, tmp); value : {2, 4, 8, 16, 32,64}Hz
Function	RTC_IRQP_READ
Description	Reads the IRQ rate.
Usage	unsigned long tmp; int ioctl(fd, RTC_IRQP_READ, &tmp);
Function	RTC_ALM_SET
Description	Sets the alarm time.
Usage	struct rtc_time rtc_tm; ioctl(fd, RTC_ALM_SET, &rtc_tm);
Function	RTC_PIE_ON
Description	Periodic int. enable on
Usage	int ioctl(fd, RTC_PIE_ON, 0);
Function	RTC_PIE_OFF
Description	Periodic int. enable off.
Usage	int ioctl(fd, RTC_PIE_OFF, 0);
Function	RTC_UIE_ON
Description	Update int. enable on.
Usage	int ioctl(fd, RTC_UIE_ON, 0);
Function	RTC_UIE_OFF
Description	Update int. enable off
Usage	int ioctl(fd, RTC_UIE_OFF, 0);
Function	RTC_AIE_ON
Description	Periodic int. enable on
Usage	int ioctl (fd, RTC_AIE_ON, 0);
Function	RTC_AIE_OFF
Description	Alarm int. enable off
Usage	int ioctl (fd, RTC_AIE_OFF, 0);

Refer to the examples in the example package to see how to use these functions.

WDT (Watch Dog Timer)

The WDT works like a watch dog function. You can enable it or disable it. When the WDT is enabled, but the application does not acknowledge it, the system will reboot. You can set the ack time from a minimum of 1 sec to a maximum of 1 day. The default timer is 60seconds and the NO WAY OUT is enabled by default; there is no way to disable the watchdog once it has been started. For this reason, if the watchdog daemon crashes, the system will reboot after the timeout has passed.

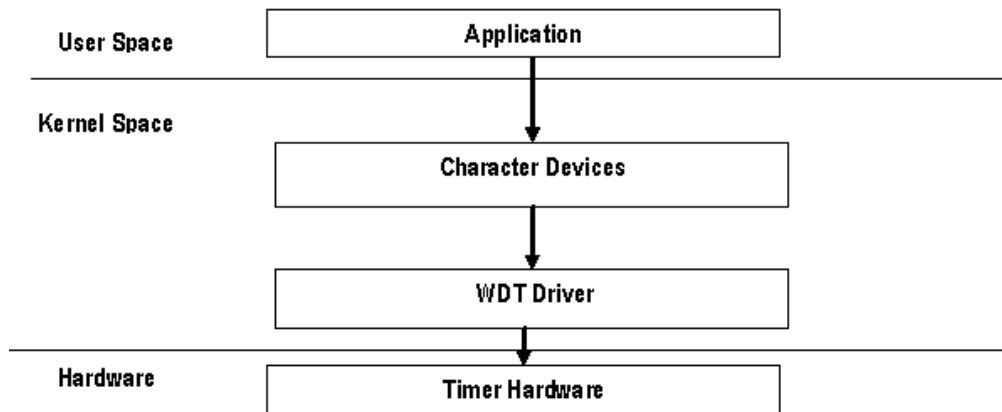

Function	WDIOC_KEEPALIVE
Description	Writes to the watchdog device to keep the watchdog alive.
Usage	<code>int ioctl(fd, WDIOC_KEEPALIVE, 0)</code>
Function	WDIOC_SETTIMEOUT
Description	Modifies the watchdog timeout Min: 1second. Max: 1day; Default: 60seconds
Usage	<code>int timeout = 60;</code> <code>ioctl(fd, WDIOC_SETTIMEOUT, &timeout);</code>
Function	WDIOC_GETTIMEOUT
Description	Queries the current timeout
Usage	<code>int timeout;</code> <code>ioctl(fd, WDIOC_GETTIMEOUT, &timeout);</code>
Function	WDIOC_GETSTATUS
Description	Asks for the current status
Usage	<code>int flags;</code> <code>ioctl(fd, WDIOC_GETSTATUS, &flags);</code>
Function	WDIOC_GETBOOTSTATUS
Description	Asks for the status at the last reboot
Usage	<code>int flags;</code> <code>ioctl(fd, WDIOC_GETBOOTSTATUS, &flags);</code>
Function	WDIOC_GETSUPPORT
Description	Asks what the device can do
Usage	<code>struct watchdog_info ident;</code> <code>ioctl(fd, WDIOC_GETSUPPORT, &ident);</code>

Cryptographic Hardware Accelerator

The purpose of cryptographic hardware accelerator is to load off the intensive encryption/decryption and compression/decompression tasks from CPU. You can use the cryptographic hardware accelerator when your application needs to do cryptographic calculations. To use it, you need to make sure that the cryptodev driver is loaded.

Moxa provides examples to show how to use this cryptographic accelerator. Go to the example/cryptodev/ folder for more information.

NOTE Click the following link for more information about cryptodev:
<http://cryptodev-linux.org/documentation.html/>

Buzzer and LEDs

Source code that you can use to set a specific path for the LEDs is provided. You can, for example, use the code to check all LEDs/buzzer of the UC-8410A.

Checking all LEDs/buzzer of your UC-8410A:

```
ls /sys/class/leds/  
UC8410A:BEEP          UC8410A:GREEN:CEL2    UC8410A:GREEN:SWRDY  
UC8410A:CEL_PWR      UC8410A:GREEN:DIA     UC8410A:RED:DIA  
UC8410A:CEL_RESET    UC8410A:GREEN:PROG0   UC8410A:RED:PROG  
UC8410A:GREEN:CEL0   UC8410A:GREEN:PROG1   UC8410A:YELLOW:DIA  
UC8410A:GREEN:CEL1   UC8410A:GREEN:PROG2
```

Choose the LEDs/Buzzer path which you want to control. For example, the Buzzer path **/sys/class/leds/UC8410A:BEEP/brightness**. Then, modify the BUZZER_PATH in the buzzer_example code as follows:

```
#define BUZZER_PATH "/sys/class/leds/UC8410A:BEEP/brightness"
```

Example: Setting the baud rate

```
#include <termio.h>
#include <fcntl.h>
#include <err.h>
#include <linux/serial.h>
...
struct termios options;
    struct serial_struct serinfo;
int fd;
int speed = 0;
static int rate_to_constant(int baudrate) {
#define B(x) case x: return B##x
    switch(baudrate) {
        B(50);    B(75);    B(110);    B(134);    B(150);
        B(200);   B(300);   B(600);   B(1200);   B(1800);
        B(2400);  B(4800);  B(9600);  B(19200);  B(38400);
        B(57600); B(115200);
        default: return 0;
    }
#undef B
}
...
/* Open and configure serial port */
    if ((fd = open(device,O_RDWR|O_NOCTTY)) == -1)
        return -1;

    fcntl(fd, F_SETFL, 0);
    tcgetattr(fd, &options);
    cfsetispeed(&options, speed ? B115200);
    cfsetospeed(&options, speed ? B115200);
    cfmakeraw(&options);
    options.c_cflag |= (CLOCAL | CREAD);
    options.c_cflag &= ~CRTSCTS;
    if (tcsetattr(fd, TCSANOW, &options) != 0)
return -1;
```

Configuring the Cellular Connection

Using Cell_mgmt

The cell_mgmt utility is used to manage the cellular module in the computer. You must use sudo or run with root permission for the cell_mgmt command.

Manual Page

```
NAME
    cell_mgmt

USAGE
    cell_mgmt [-i <module id>] [options]

HELP
    -i <module id>
        Module identifier, start from 0 and default to 0.
    -s <slot id>
        Slot identifier, start from 1 and default value depends
        on module interface.
        example: module 0 may in slot 2
modules
    Shows module numbers supported.
slot
    Shows module slot id
interface [interface id]
    Switching and checking module interface(s)
start [OPTIONS]
    Start network.

    OPTIONS:
    APN - Access point name
    PIN - PIN code
    Phone - Phone number (especially for AT based modules)
    Auth - Authentication type (CHAP|PAP|BOTH), default=NONE.
    Username
    Password

    example:
        cell_mgmt start
        cell_mgmt start APN=internet
        cell_mgmt start APN=internet PIN=0000
        cell_mgmt start APN=internet PIN=0000 Phone=*99#
        cell_mgmt start APN=internet PIN=0000 Phone=*99# \
            Auth=BOTH Username=moxa Password=moxamoxa

stop
    Stop network.
restart
    Restart network.
power_on
    Power ON.
power_off
    Power OFF.
power_cycle
    Power cycle the module slot.
switch_sim <1|2>
    Switch SIM slot.
gps_on
    GPS ON.
gps_off
```



```

    GPS OFF.
attach_status
    Query network registration status.
status
    Query network connection status.
signal
    Get signal strength.
at <'AT_COMMAND'>
    Input AT Command.
    Must use SINGLE QUOTATION to enclose AT Command.
sim_status
    Query sim card status.
unlock_pin <PIN>
    Unlock PIN code and save to configuration file.
pin_retries
    Get PIN code retry remain times.
pin_protection <enable|disable> <current PIN>
    Set PIN protection in the UIM.
set_flight_mode <0|1>
    Set module into flight mode (1) or online mode (0).
get_profiles
    Get profile list.
    format:
        <id>,<APN>,<PDP Type>
    example:
        1,internet,IPV4V6
set_profile <id> [APN [PDP Type]]
    Update PDP profile.
set_apn <APN>
    Set APN to configuration file.
check_carrier
    Check current carrier.
switch_carrier <Verizon|ATT|Sprint|Generic>
    Switching between US carrier frequency bands.
m_info
    Module/SIM information.
module_info
    Module information.
module_ids
    Get device IDs (ex: IMEI and/or ESN).
iccid
    Get SIM card ID
imsi
    Get IMSI (International Mobile Subscriber Identity).
location_info
    Get cell location information.
operator
    Telecommunication operator.
vzwauto
    Verizon Private Network auto dialup.
version
    Cellular management version.

```

```
EXIT STATUS
```

```
0
```

```

    Success.
1
    Unknown Error.

```

Dial-Up Step-by-Step

Before dialing, APN (Access Point Name) should be set correctly and the module should attach with the base station.

1. Unlock the PIN code if SIM locked by a PIN code
Use `cell_mgmt sim_status` to check SIM card status and use `cell_mgmt unlock_pin <PIN>` to unlock SIM card if "SIM-PIN"

```

moxa@moxa:/home/moxa$ sudo cell_mgmt sim_status
+CPIN: READY

```

2. Set the APN with `cell_mgmt set_apn <APN>`, this command will update the APN in profile ID 1

```

moxa@moxa:/home/moxa$ sudo cell_mgmt set_apn internet
old APN=test, new APN=internet

```

3. Check if the service attached with correct APN

```

moxa@moxa:/home/moxa$ sudo cell_mgmt attach_status
CS: attached
PS: attached

```

PS (packet-switched) should be attached for network connection

4. Dial up with `cell_mgmt start APN=<APN>`

```

moxa@moxa:/home/moxa$ sudo cell_mgmt start APN=internet
PIN code: Disabled or verified
Starting network with '_qmcli --wds-start-network=apn=internet,ip-type=4
--client-no-release-cid --device-open-net=net-802-3|net-no-qos-header'...
Saving state... (CID: 8)
Saving state... (PDH: 1205935456)
Network started successfully

```

The `cell_mgmt` dial-up function will automatically set the DNS and default gateway of the computer.

Dial-Up

cell_mgmt start

To start a network connection, use the default cellular module of the computer (using `cell_mgmt interface` to verify which module is selected by default if the computer supports multiple modules).

If you run the `cell_mgmt start` command with the APN, Username, Password, and PIN, all the configurations will be written into the configuration file `/etc/moxa-cellular-utils/moxa-cellular-utils.conf`.

This information is then used when you run the command without specifying the options.

Usage: `cell_mgmt start APN=[APN] Username=[user] Password=[pass] PIN=[pin_code]`

cell_mgmt stop

Stops/disables the network connection on the cellular module of the computer

```
moxa@moxa:/home/moxa$ sudo cell_mgmt stop
Killed old client process
Stopping network with '_qmicli --wds-stop-network=1205933264 --client-cid=8'...
Network stopped successfully
Clearing state...
```

cell_mgmt restart

Restarts the network connection on the cellular module of the computer.

```
moxa@moxa:/home/moxa$ sudo cell_mgmt restart
Killed old client process
Stopping network with '_qmicli --wds-stop-network=1205935456 --client-cid=8'...
Network stopped successfully
Clearing state...
PIN code: Disabled or verified
Starting network with '_qmicli --wds-start-network=apn=internet,ip-type=4
--client-no-release-cid --device-open-net=net-802-3|net-no-qos-header'...
Saving state... (CID: 8)
Saving state... (PDH: 1205933264)
Network started successfully
```

cell_mgmt status

Provides information on the status of the network connection.

```
moxa@moxa:/home/moxa$ sudo cell_mgmt status
Status: disconnected
```

cell_mgmt signal

Provides the cellular signal strength.

```
moxa@moxa:/home/moxa$ sudo cell_mgmt signal
umts -77 dbm
```

cell_mgmt operator

Provides information on the cellular service provider.

```
moxa@moxa:/home/moxa$ sudo cell_mgmt operator
Chunghwa
```

Cellular Module

cell_mgmt module_info

Provides information of the cellular module (AT port, GPS port, QMI port, and module name, etc.).

```
moxa@moxa:/home/moxa$ sudo cell_mgmt module_info
SLOT: 1
Module: MC7354
WWAN_node: wwan0
AT_port: /dev/ttyUSB2
GPS_port: /dev/ttyUSB1
QMI_port: /dev/cdc-wdm0
Modem_port: NotSupport
```

cell_mgmt interface [id]

Used to view the supported modules and default module on the computer with their IDs. Change the default module by specified the ID.

```
moxa@moxa:/home/moxa$ sudo cell_mgmt interface
[0] wwan0 <Current>
```

cell_mgmt power_cycle

Power cycle the cellular module in the computer. Some kernel message for module reloaded may be popped out.

```
moxa@moxa:/home/moxa$ sudo cell_mgmt power_cycle
Network already stopped
Clearing state...
[232733.202208] usb 1-1: USB disconnect, device number 2
[232733.217132] qcserial ttyUSB0: Qualcomm USB modem converter now disconnected from
ttyUSB0
[232733.225616] qcserial 1-1:1.0: device disconnected
[232733.256738] qcserial ttyUSB1: Qualcomm USB modem converter now disconnected from
ttyUSB1
[232733.265214] qcserial 1-1:1.2: device disconnected
[232733.281566] qcserial ttyUSB2: Qualcomm USB modem converter now disconnected from
ttyUSB2
[232733.290006] qcserial 1-1:1.3: device disconnected
[232733.313572] qmi_wwan 1-1:1.8 wwan0: unregister 'qmi_wwan'
usb-musb-hdrc.0.auto-1, WWAN/QMI device
[232746.879873] usb 1-1: new high-speed USB device number 3 using musb-hdrc
[232747.020358] usb 1-1: config 1 has an invalid interface number: 8 but max is 3
[232747.027639] usb 1-1: config 1 has no interface number 1
[232747.036212] usb 1-1: New USB device found, idVendor=1199, idProduct=68c0
[232747.043185] usb 1-1: New USB device strings: Mfr=1, Product=2, SerialNumber=3
[232747.050473] usb 1-1: Product: MC7354
[232747.054151] usb 1-1: Manufacturer: Sierra Wireless, Incorporated
[232747.068022] qcserial 1-1:1.0: Qualcomm USB modem converter detected
[232747.079525] usb 1-1: Qualcomm USB modem converter now attached to ttyUSB0
[232747.089754] qcserial 1-1:1.2: Qualcomm USB modem converter detected
[232747.099156] usb 1-1: Qualcomm USB modem converter now attached to ttyUSB1
```

```
[232747.109317] qcserial 1-1:1.3: Qualcomm USB modem converter detected
[232747.118581] usb 1-1: Qualcomm USB modem converter now attached to ttyUSB2
[232747.130890] qmi_wwan 1-1:1.8: cdc-wdm0: USB WDM device
[232747.137174] qmi_wwan 1-1:1.8 wwan0: register 'qmi_wwan' at
usb-musb-hdrc.0.auto-1, WWAN/QMI device, 0a:ba:e1:d6:ed:4a
```

cell_mgmt check_carrier

This command helps to check if current carrier matched with the service (SIM card) provider.

```
moxa@moxa:/home/moxa$ sudo cell_mgmt check_carrier
-----Carrier Info-----
preffered firmware=05.05.58.01
preffered carrier name=ATT
preffered carrier config=ATT_005.026_000
firmware=05.05.58.01
carrier name=ATT
carrier config=ATT_005.026_000
-----
```

cell_mgmt switch_carrier <carrier>

Some module provides multiple carrier supports, using this command to switch between provided carriers. It may take some time (depends on module's mechanism) to switch between carriers.

```
moxa@moxa:/home/moxa$ sudo cell_mgmt switch_carrier
-----switch_carrier-----
Usage:
    switch_carrier <Verizon|ATT|Sprint|Generic>
moxa@moxa:/home/moxa$ sudo cell_mgmt switch_carrier Verizon
-----switch_carrier-----
cmd=AT!GOBIIMPREF="05.05.58.01","VZW","VZW_005.029_001"

OK

OK

wait for power cycle...
Network already stopped
Clearing state...
[236362.468977] usb 1-1: USB disconnect, device number 3
[236362.482562] qcserial ttyUSB0: Qualcomm USB modem converter now disconnected from
ttyUSB0
[236362.491019] qcserial 1-1:1.0: device disconnected
[236362.521065] qcserial ttyUSB1: Qualcomm USB modem converter now disconnected from
ttyUSB1
[236362.529430] qcserial 1-1:1.2: device disconnected
[236362.544653] qcserial ttyUSB2: Qualcomm USB modem converter now disconnected from
ttyUSB2
[236362.553133] qcserial 1-1:1.3: device disconnected
[236362.558283] qmi_wwan 1-1:1.8 wwan0: unregister 'qmi_wwan'
usb-musb-hdrc.0.auto-1, WWAN/QMI device
[236376.209868] usb 1-1: new high-speed USB device number 4 using musb-hdrc
[236376.350358] usb 1-1: config 1 has an invalid interface number: 8 but max is 3
```

```

[236376.357639] usb 1-1: config 1 has no interface number 1
[236376.364991] usb 1-1: New USB device found, idVendor=1199, idProduct=68c0
[236376.371925] usb 1-1: New USB device strings: Mfr=1, Product=2, SerialNumber=3
[236376.379217] usb 1-1: Product: MC7354
[236376.382924] usb 1-1: Manufacturer: Sierra Wireless, Incorporated
[236376.400588] qcserial 1-1:1.0: Qualcomm USB modem converter detected
[236376.412010] usb 1-1: Qualcomm USB modem converter now attached to ttyUSB0
[236376.422273] qcserial 1-1:1.2: Qualcomm USB modem converter detected
[236376.429958] usb 1-1: Qualcomm USB modem converter now attached to ttyUSB1
[236376.441031] qcserial 1-1:1.3: Qualcomm USB modem converter detected
[236376.448337] usb 1-1: Qualcomm USB modem converter now attached to ttyUSB2
[236376.461514] qmi_wwan 1-1:1.8: cdc-wdm0: USB WDM device
[236376.467762] qmi_wwan 1-1:1.8 wwan0: register 'qmi_wwan' at
usb-musb-hdrc.0.auto-1, WWAN/QMI device, 0a:ba:e1:d6:ed:4a
[236411.387228] usb 1-1: USB disconnect, device number 4
[236411.393963] qcserial ttyUSB0: Qualcomm USB modem converter now disconnected from
ttyUSB0
[236411.402361] qcserial 1-1:1.0: device disconnected
[236411.422719] qcserial ttyUSB1: Qualcomm USB modem converter now disconnected
[236411.431186] qcserial 1-1:1.2: device disconnected
[236411.446102] qcserial ttyUSB2: Qualcomm USB modem converter now disconnected from
ttyUSB2
[236411.454583] qcserial 1-1:1.3: device disconnected
[236411.459687] qmi_wwan 1-1:1.8 wwan0: unregister 'qmi_wwan'
usb-musb-hdrc.0.auto-1, WWAN/QMI device
[236423.109879] usb 1-1: new high-speed USB device number 5 using musb-hdrc
[236423.250364] usb 1-1: config 1 has an invalid interface number: 8 but max is 3
[236423.257649] usb 1-1: config 1 has no interface number 1
[236423.266064] usb 1-1: New USB device found, idVendor=1199, idProduct=68c0
[236423.273024] usb 1-1: New USB device strings: Mfr=1, Product=2, SerialNumber=3
[236423.280331] usb 1-1: Product: MC7354
[236423.284011] usb 1-1: Manufacturer: Sierra Wireless, Incorporated
[236423.298320] qcserial 1-1:1.0: Qualcomm USB modem converter detected
[236423.310356] usb 1-1: Qualcomm USB modem converter now attached to ttyUSB0
[236423.318614] qcserial 1-1:1.2: Qualcomm USB modem converter detected
[236423.328841] usb 1-1: Qualcomm USB modem converter now attached to ttyUSB1
[236423.338942] qcserial 1-1:1.3: Qualcomm USB modem converter detected
[236423.348418] usb 1-1: Qualcomm USB modem converter now attached to ttyUSB2
[236423.360733] qmi_wwan 1-1:1.8: cdc-wdm0: USB WDM device
[236423.366960] qmi_wwan 1-1:1.8 wwan0: register 'qmi_wwan' at
usb-musb-hdrc.0.auto-1, WWAN/QMI device, 0a:ba:e1:d6:ed:4a
moxa@moxa:/home/moxa$ sudo cell_mgmt check_carrier
-----Carrier Info-----
preffered firmware=05.05.58.01
preffered carrier name=VZW
preffered carrier config=VZW_005.029_001
firmware=05.05.58.01
carrier name=VZW
carrier config=VZW_005.029_001
-----

```

cell_mgmt at <'AT_COMMAND'>

Used to input an AT command. For example, use AT commands like ATI or AT+CSQ:

```
moxa@moxa:/home/moxa$ sudo cell_mgmt at 'ATI'

Manufacturer: Sierra Wireless, Incorporated
Model: MC7354
Revision: SWI9X15C_05.05.58.01 r27044 carmd-fwbuild1 2015/03/05 00:02:40
MEID: 35922505519102
ESN: 12810782898, 80A488B2
IMEI: 359225055191027
IMEI SV: 19
FSN: J8638303130110
+GCAP: +CGSM,+DS,+ES

OK
moxa@moxa:/home/moxa$ sudo cell_mgmt at 'AT+CSQ'

+CSQ: 18,99

OK
```

GPS

Enables or disables GPS, when the module's device node is opened or closed. You can get raw GPS data by listening on the GPS port.

```
# gpsd <GPS Port>
```

Configuring the Wi-Fi Connection

You can configure the Wi-Fi connection on the UC computers using a configuration file or the **wifi_mgmt** utility provided by Moxa. For advanced settings, you could use the **wpa_supplicant** command.

Configuring WPA2 Settings

The UC computers support WPA2 security using the **wpa_supplicant** program. Refer to the following table for configuration options. The **Key required before joining network** column specifies whether an encryption and/or authentication key must be configured before associating with a network.

Infrastructure mode	Authentication mode	Encryption status	Manual Key required?	IEEE 802.1X enabled?	Key required before joining network?
ESS	Open	None	No	No	No
ESS	Open	WEP	Optional	Optional	Yes
ESS	Shared	None	Yes	No	Yes
ESS	Shared	WEP	Optional	Optional	Yes
ESS	WPA	WEP	No	Yes	No
ESS	WPA	TKIP	No	Yes	No
ESS	WPA2	AES	No	Yes	No
ESS	WPA-PSK	WEP	Yes	Yes	No
ESS	WPA-PSK	TKIP	Yes	Yes	No
ESS	WPA2-PSK	AES	Yes	Yes	No

Using wifi_mgmt

Manual Page

The **wifi_mgmt** utility manages the behavior of the Wi-Fi module.

```
moxa@Moxa:~$ sudo wifi_mgmt help
[sudo] password for moxa:
Usage:
/usr/sbin/wifi_mgmt [OPTIONS]
OPTIONS
start Type=[type] SSID=[ssid] Password=[password]
Insert an AP information to the managed AP list and then connect to the AP.
[type] open/wep/wpa/wpa2
[ssid] access point's SSID
[password] access point's password
example:
wifi_mgmt start Type=wpa SSID=moxa_ap Password=moxa
wifi_mgmt start Type=open SSID=moxa_ap
start [num]
Connect to AP by the managed AP list number.
start
Connect to the last time AP that was used.
scan -d
Scan all the access points information and show the detail message.
scan
Scan all the access points information.
signal
Show the AP's signal.
list
Show the managed AP list.
insert Type=[type] SSID=[ssid] Password=[password]
Insert a new AP information to the managed AP list.
[type] open/wep/wpa/wpa2
[ssid] access point's SSID
[password] access point's password
example:
wifi_mgmt insert Type=wpa SSID=moxa_ap Password=moxa
select [num]
Select an AP num to connect which is in the managed AP list.
stop
Stop network.
status
Query network connection status.
interface [num]
Switch to another wlan[num] interface.
[num] interface number
example:
wifi_mgmt interface 0
interface
Get the current setting interface.
reconnect
Reconnect to the access point.
restart
```



```
Stop wpa_supplicant then start it again.
version
Wifi management version.
```

Connecting to an AP

There are three ways to connect to an AP. The DNS and default gateway will be configured automatically. If you want to use the wireless interface's gateway, be sure to clean up your computer's default gateway first.

wifi_mgmt start Type=[type] SSID=[ssid] Password=[password]

Insert the AP information in the managed AP list and then connect to an AP.

```
root@Moxa:~# wifi_mgmt start Type=wpa SSID=moxa_ap Password=moxa
wpa_state=COMPLETED
*** Get DHCP IP address from AP ***
*** Get DHCP IP from AP! ***
```

wifi_mgmt start [num]

Connect to the AP using the managed AP list number. If you have inserted AP information before, some AP information will still be in the managed AP list. Check the managed AP list with the `wifi_mgmt list` command.

```
root@Moxa:~# wifi_mgmt list
network id / ssid / bssid / flags
0 MOXA_AP1 any [LAST USED]
1 MOXA_AP2 any [DISABLED]
2 MOXA_AP3 any [DISABLED]
```

Choose an AP number to start.

```
root@Moxa:~# wifi_mgmt start 1
wpa_state=COMPLETED
*** Get DHCP IP address from AP ***
*** Get DHCP IP from AP! ***
```

wifi_mgmt start

Connect to the previous AP that was used.

```
root@Moxa:~# wifi_mgmt list
network id / ssid / bssid / flags
0 MOXA_AP1 any [LAST USED]
1 MOXA_AP2 any [DISABLED]
2 MOXA_AP3 any [DISABLED]
```

Use the **wifi_mgmt** command to connect to the AP "MOXA_AP1" that was used the previous time.

```
root@Moxa:~# wifi_mgmt start
wpa_state=COMPLETED
*** Get DHCP IP address from AP ***
*** Get DHCP IP from AP! ***
```

Stop or Restart a Network Connection

wifi_mgmt stop

```
root@Moxa:~# wifi_mgmt stop
wpa_supplicant is closed!!
```

wifi_mgmt restart

```
root@Moxa:~# wifi_mgmt restart
wpa_supplicant is closed!!
wpa_state=COMPLETED
*** Get DHCP IP address from AP ***
*** Get DHCP IP from AP! ***
```

Inserting an AP or Choosing Another AP to Connect to

If you want to use another AP to connect, use the **wifi_mgmt select** command to switch to another AP.

```
root@Moxa:~# wifi_mgmt insert Type=wpa2 SSID=MOXA_AP3 Password=moxa
root@Moxa:~# wifi_mgmt list
network id / ssid / bssid / flags
0 MOXA_AP1 any [CURRENT]
1 MOXA_AP2 any [DISABLED]
2 MOXA_AP3 any [DISABLED]
```

If you want to use another AP to connect, use the **wifi_mgmt select** command to switch to another AP.

```
root@Moxa:~# wifi_mgmt list
network id / ssid / bssid / flags
0 MOXA_AP1 any [DISABLED]
1 MOXA_AP2 any [CURRENT]
2 MOXA_AP3 any [DISABLED]
root@Moxa:~# wifi_mgmt select 2
wpa_state=COMPLETED
*** Get DHCP IP address from AP ***
*** Get DHCP IP from AP! ***
```

Other Functions

wifi_mgmt scan

Scan all of the access point information.

```
root@Moxa:~# wifi_mgmt scan
bssid / frequency / signal level / flags / ssid
b0:b2:dc:dd:c9:e4 2462 -57 [WPA-PSK-TKIP][ESS] WES_AP
fc:f5:28:cb:8c:23 2412 -57 [WPA2-EAP-CCMP-preauth][ESS] MHQ-NB
fe:f0:28:cb:8c:23 2412 -59 [WPA2-EAP-CCMP-preauth][ESS] MHQ-Mobile
fc:f5:28:cb:39:08 2437 -79 [WPA2-EAP-CCMP-preauth][ESS] MHQ-NB
fe:f0:28:cb:39:08 2437 -81 [WPA2-EAP-CCMP-preauth][ESS] MHQ-Mobile
fc:f5:28:cb:5d:a8 2462 -83 [WPA2-EAP-CCMP-preauth][ESS] MHQ-NB
2c:54:cf:fd:5a:cf 2437 -83 [WPA-PSK-TKIP][ESS] 5566fans
fe:f0:28:cb:5d:a8 2462 -87 [WPA2-EAP-CCMP-preauth][ESS] MHQ-Mobile
fe:f0:28:cb:5d:78 2462 -89 [WPA2-EAP-CCMP-preauth][ESS] MHQ-Mobile
fe:f0:28:cb:39:11 2437 -89 [WPA2-EAP-CCMP-preauth][ESS] MHQ-Mobile
fc:f5:28:cb:39:11 2437 -91 [WPA2-EAP-CCMP-preauth][ESS] MHQ-NB
fe:f0:28:cb:39:0b 2412 -91 [WPA2-EAP-CCMP-preauth][ESS] MHQ-Mobile
```

```
02:1a:11:f1:dc:a1 2462 -91 [WPA2-PSK-CCMP][ESS] M9 Davidoff
fc:f5:28:cb:5d:78 2462 -93 [WPA2-EAP-CCMP-preauth][ESS] MHQ-NB
fe:f0:28:cb:5d:b7 2462 -93 [WPA2-EAP-CCMP-preauth][ESS] MHQ-Mobile
fc:f5:28:cb:39:0b 2412 -93 [WPA2-EAP-CCMP-preauth][ESS] MHQ-NB
fc:f5:28:cb:5d:b7 2462 -95 [WPA2-EAP-CCMP-preauth][ESS] MHQ-NB
fc:f5:28:cb:5d:93 2462 -97 [WPA2-EAP-CCMP-preauth][ESS] MHQ-NB
```

wifi_mgmt scan -d

Scan all of the access point information and show a detailed message.

```
root@Moxa:~# wifi_mgmt scan -d
wlan0 Scan completed :
Cell 01 - Address: FC:F5:28:CB:8C:23
Channel:1
Frequency:2.412 GHz (Channel 1)
Quality=51/70 Signal level=-59 dBm
Encryption key:on
ESSID:"MHQ-NB"
9 Mb/s; 12 Mb/s; 18 Mb/s
Mode:Master
Group Cipher : CCMP
Pairwise Ciphers (1) : CCMP
Authentication Suites (1) : 802.1x
Preauthentication Supported
Cell 02 - Address: FE:F0:28:CB:5D:A8
Channel:11
Frequency:2.462 GHz (Channel 11)
Quality=25/70 Signal level=-85 dBm
Encryption key:on
ESSID:"MHQ-Mobile"
9 Mb/s; 12 Mb/s; 18 Mb/s
Mode:Master
Group Cipher : CCMP
Pairwise Ciphers (1) : CCMP
Authentication Suites (1) : 802.1x
Preauthentication Supported
More.. ..
```

wifi_mgmt signal

Show the AP's signal.

```
root@Moxa:~# wifi_mgmt signal
level=-59 dBm
```

wifi_mgmt delete

```
root@Moxa:~# wifi_mgmt list
network id / ssid / bssid / flags
0 MOXA_AP1 any [CURRENT]
1 MOXA_AP1 any [DISABLED]
2 MOXA_AP3 any [DISABLED]
root@Moxa:~# wifi_mgmt delete 2
***** WARNING *****
Are you sure that you want to delete network id 2 (y/n)y
network id / ssid / bssid / flags
0 MOXA_AP1 any
1 MOXA_AP2 any [DISABLED]
```

wifi_mgmt status

```

root@Moxa:~# wifi_mgmt status
bssid=b0:b2:dc:dd:c9:e4
ssid=MOXA_AP1
id=0
mode=station
pairwise_cipher=TKIP
group_cipher=TKIP
key_mgmt=WPA-PSK
wpa_state=COMPLETED
ip_address=192.168.1.36
address=00:0e:8e:4c:13:5e

```

wifi_mgmt interface [num]

If there is more than one Wi-Fi interface, you can change the interface.

```

root@Moxa:~# wifi_mgmt interface
There is(are) 2 interface(s):
wlan0 [Current]
wlan1
root@Moxa:~# wifi_mgmt interface 1
Now is setting the interface as wlan1.

```

wifi_mgmt reconnect

```

root@Moxa:~# wifi_mgmt reconnect
wpa_state=SCANNING
wpa_state=SCANNING
wpa_state=COMPLETED
*** Get DHCP IP address from AP ***
*** Get DHCP IP from AP! ***

```

wifi_mgmt version

```

root@Moxa:~# wifi_mgmt version
wifi_mgmt version 1.0 Build 15050223

```

Configuring the Wireless LAN Using the Configuration File

You can edit the `/etc/moxa-wifi-utils/wpa_supplicant.conf` file to configure a Wi-Fi connection. The following is an example of the configuration file for an OPEN/WEP/WPA/WPA2 access point.

```

ctrl_interface=/var/run/wpa_supplicant
ctrl_interface_group=wheel
update_config=1
### Open system ###
#network={
# ssid="Open"
# key_mgmt=NONE
#}
#####
#### WEP ####
#network={
# ssid="WEP-ssid"
# bssid=XX:XX:XX:XX:XX:XX
# key_mgmt=NONE
# wep_key0=KEY
#}

```

```
#####
#### WPA/WPA2 PSK ####
#network={
# ssid="WPA-ssid"
# proto=WPA WPA2 RSN
# key_mgmt=WPA-PSK
# pairwise=TKIP CCMP
# group=TKIP CCMP
# psk="KEY"
#}
#####
```

The basic command to connect to a WPA-supPLICANT is:

```
root@Moxa:~# wpa_supplicant -i <interface> -c <configuration file> -B
```

The **-B** option should be included because it forces the supplicant to run in the background.

1. Connect with the following command after editing `wpa_supplicant.conf`:

```
root@Moxa:~# wpa_supplicant -i wlan0 -c /etc/moxa-wifi-utils/wpa_supplicant.conf
-B
```

2. Use the `iwconfig` command to check the connection status. The response you receive should be similar to the following:

```
wlan0 IEEE 802.11abgn ESSID:"MOXA_AP"
Mode:Managed Frequency:2.462 GHz Access Point: 00:1F:1F:8C:0F:64
Bit Rate=36 Mb/s Tx-Power=27 dBm
Retry min limit:7 RTS thr:off Fragment thr:off
Encryption key:1234-5678-90 Security mode:open
Power Management:off
Link Quality=37/70 Signal level=-73 dBm
Rx invalid nwid:0 Rx invalid crypt:0 Rx invalid frag:0
Tx excessive retries:0 Invalid misc:0 Missed beacon:0
```



WARNING

Moxa strongly advises against using the WEP and WPA encryption standards. Both are now officially deprecated by the Wi-Fi Alliance, and are considered insecure. To guarantee good Wi-Fi encryption and security, use WPA2 with the AES encryption algorithm.

A

Extending the Lifetime of the SD Card

In this appendix, we describe how to extend the lifetime of the SD card.

The following topics are covered in this appendix:

▣ **Overview**

- SD Flash Types

Overview

The UC-8410A-LX comes with an SD socket that can provide storage expansion, and you can even store the operating system on the SD card, making it important to choose the best SD card for the UC-8410A-LX. Here is some general information about SD cards that are currently available on the market.

SD Flash Types

Single-level-cell (SLC)

Single-level-cell (SLC) cards have the simplest operation of all flash type cards, in the sense that there is only one bit per cell, and the firmware does not need to negotiate with the data in different levels and states. SLC cards have a longer lifetime than other flash types.

Multi-level cell (MLC)

Multi-level cell (MLC) cards, as the name suggests, can store multiple bits per cell. The primary benefit of MLC flash memory is the lower cost per unit of storage due to the higher data density.

Triple-level cell (TLC)

TLC flash (triple level cell flash) is a type of solid-state NAND flash memory that stores three bits of data per cell. TLC flash is less expensive than single-level cell (SLC) and multi-level cell (MLC) solid-state flash memory, and is commonly used in various consumer devices that use solid-state storage.

Comparison Table for Flash Types

Flash type	SLC, Single Level Cell (1 bit)	MLC, Multilevel Cell (2 bits)	TLC, Triple Level Cell (3 bits)
Bits per cell	1	2	3
Program/Erase cycles	Generally 100000 write/erase cycles	Anywhere from 3000 to 15000 write/erase cycles	Anywhere from 1000 to 5000 write/erase cycles
Erase time	Erase time: 1.5-2 ms	Erase time: 2.5-3.5 ms	Erase time: 4-5 ms
Operation scenario	Industrial	Commercial	Commercial

We strongly recommend using SLC SD cards in the UC-8410A-LX computer.

B

Copying Images on an SD Card

In this appendix, we show you how to copy an image from an SD card.

The following topics are covered in this appendix:

- ❑ **Using the Win32 Disk Imager**
- ❑ **Using the dd Command**
- ❑ **Enabling the mSATA Storage Device**
 - Creating a New Partition
 - Deleting an Existing Partition
 - Creating a File System On the mSATA Drive
 - Mounting the mSATA Drive
 - Unmounting the mSATA Drive

Using the Win32 Disk Imager

1. Remove the SD card from the UC-8410A and insert it into another computer.
2. Start Win32 Disk imager and complete the following steps:
 - a. From the **Device** drop-down list, select the drive letter for the SD card (for example, L:\).
 - b. In the **Image File** field, enter the location for the image file. Alternatively, you can click the folder icon to locate the image file (for example, D:\Temp\backup.imp).

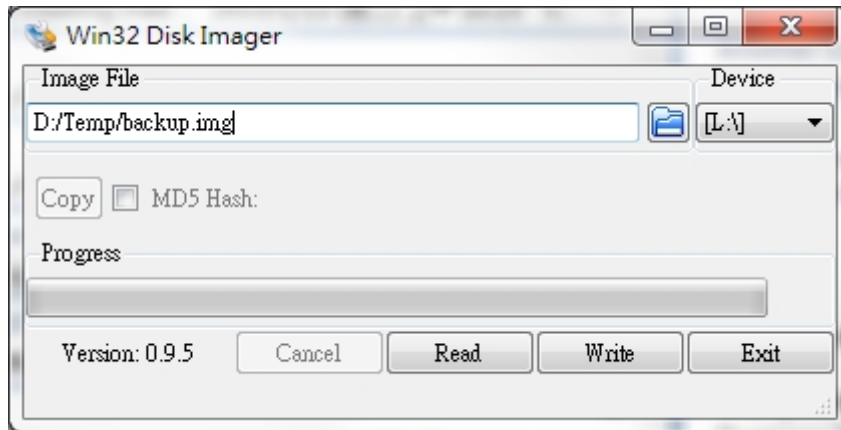

3. Click **Read**.

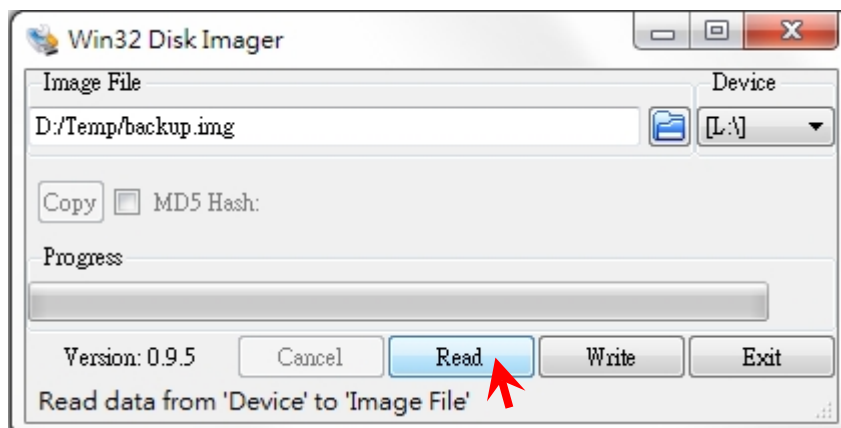

- Wait until the file copy process is complete. Click **OK** to close the window.

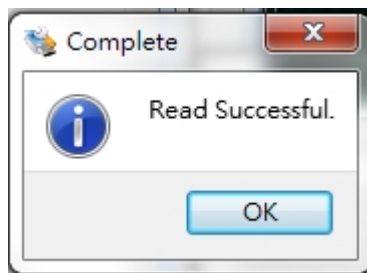
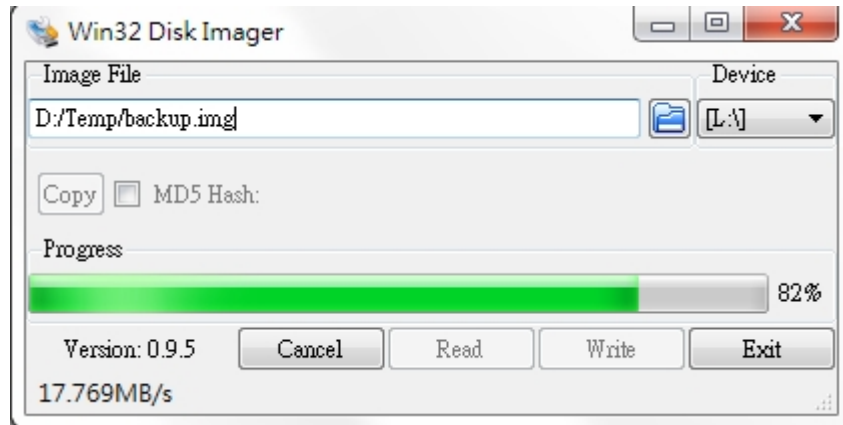

- Click **Exit** to exit the utility.
- Eject the SD card from the computer. At this point, you can start using the image.

Using the dd Command

- Insert the SD card into another computer.
- Check the device folder for the SD card (for example, `/dev/sdd`) and the directory and file name of the image file (for example, `/home/backup.img`).
- Run the `dd` command. For example:

```
#dd if=/dev/sdd of=/home/backup.img bs=512k
```

Enabling the mSATA Storage Device

The UC-8410A provides an mSATA slot for storage expansion. This section provides you with instructions on how to use an mSATA storage device with your UC-8410A.

Type `#fdisk /dev/sda` and then enter `m` to view all commands.

```
#fdisk /dev/sda

Command (m for help): m

Help:

DOS (MBR)
 a toggle a bootable flag
 b edit nested BSD disklabel
 c toggle the dos compatibility flag

Generic
 d delete a partition
```

```

l  list known partition types
n  add a new partition
p  print the partition table
t  change a partition type
v  verify the partition table

Misc
m  print this menu
u  change display/entry units
x  extra functionality (experts only)

Save & Exit
w  write table to disk and exit
q  quit without saving changes

Create a new label
g  create a new empty GPT partition table
G  create a new empty SGI (IRIX) partition table
o  create a new empty DOS partition table
s  create a new empty Sun partition table

```

```
Command (m for help):
```

Creating a New Partition

Use the **n** command to create a new partition for the mSATA storage device. You need to select the partition type and partition number, and then determine where the sector begins and ends as shown in the example below. Alternatively, you can simply use the default values for these parameters.

```

#fdisk /dev/sda
Command (m for help): n
Partition type
   p primary (0 primary, 0 extended, 4 free)
   e extended (container for logical partition)
Select (default p): p
Partition number (1-4, default 1): 1
First sector (2048-35651583, default 2048): 2048
Last sector, +sectors or +size {K,M,G,T,P} (2048-35651583, default: 35651583):
Created a new partition 1 of type 'Linux' and of size 17 GiB.
Command (m for help): w

```

Use the **w** command to save the settings.

Deleting an Existing Partition

If you want to delete an existing partition on the mSATA drive, use the **d** command. Select the partition number for the partition that you want to delete as in the following example:

```

#fdisk /dev/sda
Command (m for help): d
Selected partition 1
Partition 1 has been deleted.
Command (m for help): w

```

Use the `w` command to save the settings.

Creating a File System On the mSATA Drive

To create a file system, use the following command:

```
#mount /dev/sda1
```

Mounting the mSATA Drive

To mount the mSATA drive, use the following command:

```
#mount /dev/sda1 /mnt
```

Unmounting the mSATA Drive

To unmount the mSATA, use the following command.

```
#umount /mnt
```