

# UC-8410A Series

*Highly efficient, security-enabled platform that supports a rich set of interfaces*



- > Freescale LS1021A Cortex-A7 1 GHz dual-core processor
- > 512 MB DDR3 SDRAM
- > 8 RS-232/422/485 serial ports
- > 3 10/100/1000 Mbps Ethernet ports
- > Wireless-enabled with PCIe mini slot
- > 2 USB 2.0 hosts for mass storage devices
- > DIN-rail or wall-mounting installation
- > Robust, fanless design
- > -40 to 75°C wide temperature model available
- > Ready-to-run Debian ARM 8



## Overview

The UC-8410A Series embedded computers support a rich collection of communication interfaces, including 8 RS-232/422/485 serial ports, 3 Ethernet ports, 1 PCIe mini slot for a wireless module, 4 digital input channels, 4 digital output channels, 1 mSATA slot, and 2 USB 2.0 hosts.

The UC-8410A computer uses the Freescale Cortex-A7 dual-core 1 GHz RISC CPU. This powerful computing engine supports several useful communications functions, without generating too much heat. The built-in 1 GB SD card and 512 MB DDR3 SDRAM give you enough memory to run your application software, and the mSATA slot provides the flexibility of adding additional data storage. The UC-8410A comes

with a variety of communication interfaces, including serial ports, Ethernet ports, wireless communication slot, and digital input/output channels, making them ideal as communication platforms for industrial applications that require network and device communications.

The UC-8410A Series comes with Linux Debian 8 pre-installed to provide an open software operating system for software program development. This makes the UC-8410A computer an optimal solution for use with industrial applications, but at minimal cost and effort. In addition to the standard model, a -40 to 75°C wide temperature model is also available for harsh industrial environments.

## Appearance

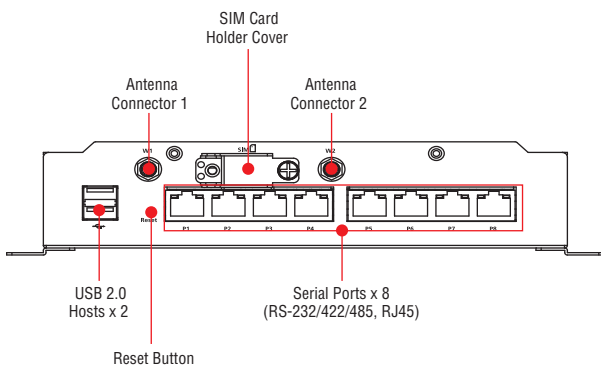

Front View

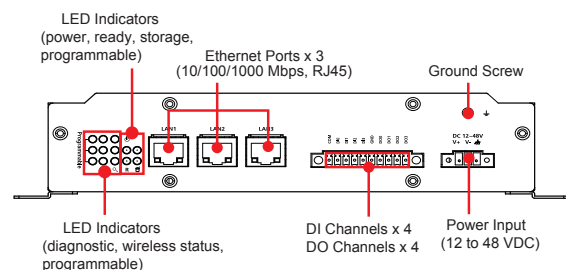

Rear View

## Hardware Specifications

### Computer

**CPU:** ARMv7 Cortex-A7 dual-core 1 GHz

**USB:** USB 2.0 hosts x 2, Type A connector

**DRAM:** 512 MB DDR3 SDRAM onboard (up to 1 GB, by CV request)

**OS (pre-installed):** Debian ARM 8

### Storage

**Main Storage:** 1 GB SD card for OS

**Storage Expansion:** mSATA slot

### Ethernet Interface

**LAN:** Auto-sensing 10/100/1000 Mbps ports (RJ45) x 3

**Magnetic Isolation Protection:** 1.5 kV built-in

### Serial Interface

**Serial Standards:** RS-232/422/485 software-selectable ports (8-pin RJ45) x 8

**Console Port:** RS-232 (TxD, RxD, GND), 4-pin header output (115200, n, 8, 1)

### Serial Communication Parameters

**Data Bits:** 5, 6, 7, 8

**Stop Bits:** 1, 1.5, 2

**Parity:** None, Even, Odd, Space, Mark

**Flow Control:** RTS/CTS, XON/XOFF, ADDC® (automatic data direction control) for RS-485

**Baudrate:** 50 bps to 115.2 kbps (supports nonstandard baudrates; see user's manual for details)

### Serial Signals

**RS-232:** TxD, RxD, DTR, DSR, RTS, CTS, DCD, GND

**RS-422:** TxD+, TxD-, RxD+, RxD-, GND

**RS-485-4w:** TxD+, TxD-, RxD+, RxD-, GND

**RS-485-2w:** Data+, Data-, GND

### Digital Input

**Input Channels:** DI x 4

**Input Voltage:** 0 to 30 VDC

**Digital Input Levels for Dry Contacts:**

- Logic level 0: Close to GND
- Logic level 1: Open

**Digital Input Levels for Wet Contacts:**

- Logic level 0: +10 to +30 V (COM to DI)
- Logic level 1: +3 V max.

**Connector Type:** 10-pin screw terminal block (4 points, COM, GND)

**Isolation:** 3 kV optical isolation

### Digital Output

**Output Channels:** 4, sink type

**Output Current:** Max. 200 mA per channel

**On-State Voltage:** 24 VDC nominal, open-drain to 30 V

**Connector Type:** 10-pin screw terminal block (4 points, GND)

**Isolation:** 3 kV optical isolation

### LEDs

**System:** Power, Ready, Storage, Diagnostic, Wireless signal strength

**LAN:** 100M/Link/Act x 3, 1000M/Link/Act x 3 (on connector)

**Serial:** TxD x 8, RxD x 8 (on connector)

**Reset Button:** Supports "Reset to Factory Default and System diagnostics"

### Physical Characteristics

**Housing:** SECC sheet metal (1 mm)

**Weight:** 1 kg (2.21 lb)

**Dimensions:** 200 x 120 x 48.6 mm (7.87 x 4.72 x 1.91 in)

**Mounting:** DIN-rail, wall

### Environmental Limits

**Operating Temperature:**

Standard Models: -10 to 60°C (14 to 140°F)

Wide Temp. Models: -40 to 75°C (-40 to 167°F)

**Storage Temperature:**

Standard Models: -20 to 75°C (-4 to 167°F)

Wide Temp. Models: -40 to 85°C (-40 to 185°F)

**Ambient Relative Humidity:** 5 to 95% (non-condensing)

**Anti-Vibration:** 2 Grms @ IEC-68-2-34, random wave, 5-500 Hz, 1 hr per axis

**Anti-Shock:** 20 g @ IEC-68-2-27, half sine wave, 11 ms

### Power Requirements

**Input Voltage:** 12 to 48 VDC (3-pin terminal block)

**Input Current:** 12 to 48 VDC, 1.57 to 0.42 A

**Power Consumption:** 19 W

### Standards and Certifications

**Safety:** UL 60950-1

**EMC:**

CISPR 32, FCC Part 15B Class A

EN 55032/24

IEC 61000-4-2 ESD: Contact 4 kV; Air 8 kV

IEC 61000-4-3 RS: 3 V/m (80 MHz to 1 GHz)

IEC 61000-4-4 EFT: Power 0.5 kV; Signal 0.5 kV

IEC 61000-4-5 Surge: Power 0.5 kV; Signal 1 kV

IEC 61000-4-6 CS: 3 V

IEC 61000-4-8

### Reliability

**Alert Tools:** Built-in buzzer and RTC (real-time clock)

**Automatic Reboot Trigger:** Built-in WDT (watchdog timer)

### Warranty

**Warranty Period:** 5 years

**Details:** See [www.moxa.com/warranty](http://www.moxa.com/warranty)

**Note:** The Hardware Specifications apply to the embedded computer unit itself, but not to accessories. In particular, the wide temperature specification does not apply to accessories such as the power adapter and cables.

## Software Specifications

### Linux

**OS:** Debian ARM 8

**Web Server (Apache):** Allows you to create and manage web sites; supports PHP and XML

**Terminal Server (SSH):** SSH allows remote logins to a secure encrypted console from any connected network

**Kernel:**

GNU/Linux 3.12

System Shell: DASH, BASH

Text Editor: vim, nano

**File System:** Ext2, Ext3, Ext4

**Internet Protocol Suite:** TCP, UDP, IPv4, IPv6, SNMPv2, ICMP, ARP, HTTP, CHAP, PAP, DHCP, NTP, NFS, SSH, PPP, SFTP, RSYNC, SSL

**Programming Language Support:** PHP, Perl, Python

**Internet Security:** OpenVPN, iptables

**Cryptographic Hardware Accelerators:** AES, SHA, OpenSSL

**Self Diagnosis:** Check status of system and hardware component via software method

**Linux Board Support Packages (BSP):** GCC C/C++ cross development tool chain  
Bootloader/ Kernel/ filesystem

**Cellular Networking:** Allows Unix machines to connect to the Internetpppd to connect to the Internet.

**Connect talcomm MSM Interface):** Glib-based library for talking to WWAN modems and devices that speak the Qualcomm MSM Interface (QMI) protocol.

**Watchdog:** Features a hardware function to trigger system reset in a user specified time interval (Linux standard provided)

**Application Development Software:**

- Moxa API Library (Watchdog timer, Moxa serial I/O control, Moxa DI/DO API)

- GNU C/C++ cross-compiler

- GNU C library

- GDB source-level debugging server

**Software Protection:** Encryption tool for user executable files (based on patented Moxa technology)

## Dimensions

Unit: mm (inch)

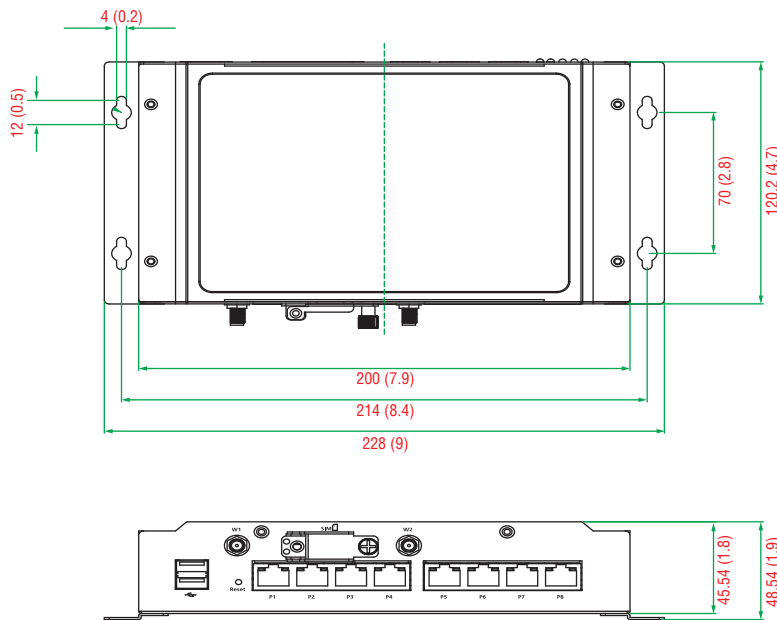

## Ordering Information

### Available Models

**UC-8410A-LX:** Cortex-A7 1 GHz dual-core RISC-based computer, 1 GB SD card, 512 MB DDR3L, serial ports x 8, DIs x 4, DOs x 4, LANs x 3, wireless enabled, mSATA slots x 1, USB, Debian ARM8, -10 to 60°C operating temperature







**UC-8410A-T-LX:** Cortex-A7 1 GHz dual-core RISC-based computer, 1 GB SD card, 512 MB DDR3L, serial ports x 8, DIs x 4, DOs x 4, LANs x 3, wireless enabled, mSATA slots x 1, USB, Debian ARM8, -40 to 75°C operating temperature

**UC-8410A-LX1:** Cortex-A7 1 GHz dual-core RISC-based computer, 1 GB SD card, 512 MB DDR3L, serial ports x 8, DIs x 4, DOs x 4, LANs x 3, wireless enabled, 16 GB mSATA, USB, Debian ARM8, -10 to 60°C operating temperature

### Package Checklist





- UC-8410A embedded computer
- Wall-mounting kit
- DIN-rail mounting kit
- Power jack
- 3-pin terminal block for power
- CBL-4PINDB9F-100: 4-pin pin header to DB9 female console port cable, 100 cm
- Documentation and software CD
- Quick installation guide (printed)
- Warranty card

**Optional Accessories (can be purchased separately)**

Type	Model Name	Description	
Power Adapter, Power Cords, and Console Cable			
	Adapter	PWR-24270-DT-S1	Power adapter, input voltage 90 to 264 VAC, output voltage 24 V with 2.7 A DC load
	Power Cord	PWC-C7US-2B-183	Power cord with 2-pin connector, USA plug
	Power Cord	PWC-C7EU-2B-183	Power cord with 2-pin connector, Euro plug
	Power Cord	PWC-C7UK-2B-183	Power cord with 2-pin connector, British plug
	Power Cord	PWC-C7AU-2B-183	Power cord with 2-pin connector, Australia plug
	Power Cord	PWC-C7CN-2B-183	Power cord with 2-pin connector, China plug
	Console Cable	CBL-F9DPF1x4-BK-100	Console cable with 4-pin connector

## Compatible Wireless Packages

Note: The following packages can be purchased separately without the computer

Type		Model Name	Description
LTE and Wi-Fi			
	Cellular Package	CELLULAR-LTE-EU(LE910)	1 LTE module, 1 antenna with cable and connector, 2 black screws, 1 lock washer, 1 nut, 1 thermal pad
	Wi-Fi Package	Wi-Fi-BGN(252NI)	1 Wi-Fi module, 2 antennas with cable and connector, 2 black screws, 2 lock washers, 2 nuts, 1 thermal pad
	LTE-EU External Antenna	ANT-LTE-ASM-02	LTE-EU external antenna with 1 SMA connector
	Wi-Fi Antenna	ANT-WDB-ARM-02	Wi-Fi external antenna with 1 SMA connector