

# V2403 Series Hardware User's Manual

---

Edition 2.0, February 2017

[www.moxa.com/product](http://www.moxa.com/product)



© 2017 Moxa Inc., All rights reserved.

# V2403 Series Hardware User's Manual

The software described in this manual is furnished under a license agreement and may be used only in accordance with the terms of that agreement.

## Copyright Notice

© 2017 Moxa Inc., All rights reserved.

## Trademarks

The MOXA logo is a registered trademark of Moxa Inc.  
All other trademarks or registered marks in this manual belong to their respective manufacturers.

## Disclaimer

Information in this document is subject to change without notice and does not represent a commitment on the part of Moxa.

Moxa provides this document as is, without warranty of any kind, either expressed or implied, including, but not limited to, its particular purpose. Moxa reserves the right to make improvements and/or changes to this manual, or to the products and/or the programs described in this manual, at any time.

Information provided in this manual is intended to be accurate and reliable. However, Moxa assumes no responsibility for its use, or for any infringements on the rights of third parties that may result from its use.

This product might include unintentional technical or typographical errors. Changes are periodically made to the information herein to correct such errors, and these changes are incorporated into new editions of the publication.

## Technical Support Contact Information

[www.moxa.com/support](http://www.moxa.com/support)

### **Moxa Americas**

Toll-free: 1-888-669-2872  
Tel: +1-714-528-6777  
Fax: +1-714-528-6778

### **Moxa Europe**

Tel: +49-89-3 70 03 99-0  
Fax: +49-89-3 70 03 99-99

### **Moxa India**

Tel: +91-80-4172-9088  
Fax: +91-80-4132-1045

### **Moxa China (Shanghai office)**

Toll-free: 800-820-5036  
Tel: +86-21-5258-9955  
Fax: +86-21-5258-5505

### **Moxa Asia-Pacific**

Tel: +886-2-8919-1230  
Fax: +886-2-8919-1231

# Table of Contents

<b>1. Introduction</b>	<b>1-1</b>
Package Checklist	1-2
Product Features	1-2
V2403 Hardware Specifications	1-2
Hardware Block Diagram	1-5
<b>2. Hardware Introduction</b>	<b>2-1</b>
Appearance	2-2
Dimensions	2-3
LED Indicators	2-3
Reset Button	2-4
Real Time Clock (RTC)	2-4
<b>3. Hardware Connection Description</b>	<b>3-1</b>
Installing the V2403	3-2
Wiring Requirements	3-4
Connecting the Power	3-4
Grounding the Unit	3-5
Connecting Data Transmission Cables	3-5
Installing the Mini-PCIe Modules and USIM Cards	3-5
Connecting to the Network	3-9
Connecting to a Serial Device	3-9
Installing a CFast Card	3-10
Connecting to a USB Device	3-10
DI/DO	3-11
Connecting to a DVI-I Monitor	3-12
HDMI Outputs	3-12
Connecting to a VGA Monitor	3-13
Connecting to a Speaker or a Headphone	3-13
Installing a SATA Hard Disk	3-13
RTC Battery Replacement	3-14
<b>4. BIOS Setup</b>	<b>4-1</b>
Entering the BIOS Setup	4-2
Main Information	4-3
Advanced Settings	4-3
Boot Configuration	4-4
HDC Configuration	4-4
Video Configuration	4-5
Chipset Configuration	4-7
Hardware Monitor	4-8
SMART RECOVERY Info	4-9
Security Settings	4-9
Set Supervisor Password	4-10
Power Settings	4-10
Turbo Mode	4-11
Auto Wake on S5	4-12
Wake on LAN	4-13
Boot Settings	4-13
Boot Type	4-13
PXE Boot to LAN	4-13
Add Boot Options	4-13
USB Boot	4-14
EFI Device First	4-14
Boot Delay Time	4-14
Legacy	4-14
Exit Settings	4-15
Exit Saving Changes	4-16
Save Change Without Exit	4-16
Exit Discarding Changes	4-16
Load Optimal Defaults	4-16
Load Custom Defaults	4-16
Save Custom Defaults	4-16
Discard Changes	4-16
Upgrading the BIOS	4-17
<b>A. Regulatory Approval Statement</b>	<b>A-1</b>





# Introduction

---

The Moxa V2403 series fanless x86 embedded computer is based on the Intel® 3rd gen Core-i™ series processor, features the most reliable I/O design to maximize connectivity, and supports dual wireless modules, making it suitable for a diverse range of communication applications. The computer's thermal design ensures reliable system operation in temperatures ranging from -40 to 70°C with a special purpose Moxa wireless module installed. The V2403 series supports "Moxa Hardware Monitoring" for device I/O status monitoring and alerts, system temperature monitoring and alerts, and system power management. Closely monitoring system status makes it easier to recover from errors and provides the most reliable platform for your applications.

The following topics are covered in this chapter:

- ❑ **Package Checklist**
- ❑ **Product Features**
- ❑ **V2403 Hardware Specifications**
- ❑ **Hardware Block Diagram**

# Package Checklist

Each model is shipped with the following items:

- V2403 series embedded computer
- Wall mounting kit
- Terminal block to power jack converter
- Documentation and software CD or DVD
- Quick installation guide (printed)
- Warranty card

**NOTE:** Please notify your sales representative if any of the above items are missing or damaged.

# Product Features

V2403 embedded computers include the following features:

- Intel Core-i series processor, 3 options for performance
- -40 to 70°C system + LTE operating temperature
- Dual CFast sockets for OS and backup OS storage
- Triple mini-PCIe sockets for storage and wireless modules, supporting mSATA, WiFi, 3G, LTE, GPS, and Bluetooth
- Variety of interfaces: 4 serial ports, 2 Ethernet LAN port, 4 DIs, 4 DOs, USB, HDMI, wireless
- EN 61000-6-2 and EN 61000-6-4 certifications meet EMC standard for heavy industry
- Up to 5 Grms anti-vibration and 50 G anti-shock
- Ready-to-run Debian 8, Windows Embedded Standard 7 platforms
- Moxa Hardware Monitoring utility for system hardware health monitoring
- Moxa SmartRecovery utility to recover system from boot failure (W7E only)

# V2403 Hardware Specifications

## Computer

### CPU:

V2403-C2 Series: Intel® Celeron 1047UE (Dual Core, 512K Cache, 1.40 GHz)

V2403-C3 Series: Intel® Core i3-3217UE (Dual Core, 1M Cache, 1.60 GHz)

V2403-C7 Series: Intel® Core i7-3517UE (Quad Core, 1M Cache, 1.70 GHz)

**OS:** Windows Embedded Standard 7 64-bit or Linux Debian 8 64-bit

**System Memory:** 1 DDR3-1600 SDRAM slot, 8 GB max.

**USB:** 4 bootable USB 2.0 ports (type A)

## Storage

**CFast :** 1 removable CFast socket for OS storage, 1 internal CFast socket for OS backup

**mSATA:** 1 internal mini-PCIe socket for storage expansion

**SSD/HDD:** 1 internal SATA-II connector for 2.5" SSD/HDD

## Audio

**Input:** Line-in interface (audio jack)

**Output:** Line-out interface (audio jack)

## Wireless Peripherals

**Expansion Slot:** 2 Mini-PCIe sockets

- 1 USB signal, for Sierra Wireless 3G/LTE module
- 1 USB + PCIe signal

**USIM:** 2 USIM slots

## Display

**Graphics Controller:** Intel® HD (integrated)

**Connector Type:** 1 HDMI connector (type A), 1 DVI-I connector, 1 VGA connector (CV required)

**Display Interface:** HDMI supports HDMI 1.4b, 1920 x1200 resolution @ 60 Hz

- DVI up to 1920x1200 resolution @ 60 Hz
- VGA up to 1920x1200 resolution @ 60 Hz
- VGA up to 2048x1536 resolution @ 75 Hz

## Ethernet Interface

**LAN:** 2 auto-sensing 10/100/1000 Mbps ports (RJ45)

**Isolation Protection:** 1.5 kV

## Wireless SMA Interface

**Wi-Fi:** 2 SMA connectors

**3G/LTE:** 2 SMA connectors

**GPS:** 1 SMA connector

## Serial Interface

**Serial Standards:** 4 RS-232/422/485 ports, software selectable (DB9 male)

## Serial Communication Parameters

**Data Bits:** 5, 6, 7, 8

**Stop Bits:** 1, 1.5, 2

**Parity:** None, Even, Odd, Space, Mark

**Flow Control:** RTS/CTS, XON/XOFF, ADDC® (automatic data direction control) for RS-485

**Baudrate:** 50 bps to 921.6 kbps

## Serial Signals

**RS-232:** TxD, RxD, DTR, DSR, RTS, CTS, DCD, GND

**RS-422:** TxD+, TxD-, RxD+, RxD-, GND

**RS-485-4w:** TxD+, TxD-, RxD+, RxD-, GND

**RS-485-2w:** Data+, Data-, GND

## Digital Input

**Input Channels:** 4, source type

**Input Voltage:** 0 to 30 VDC at 25 Hz

**Digital Input Levels for Dry Contacts:**

Logic level 0: Close to GND

Logic level 1: Open

**Digital Input Levels for Wet Contacts:**

Logic level 1: +3 V max

Logic level 0: +10 V to +30 V (Source to DI)

**Connector Type:** screw-fastened Euroblock terminal

**Isolation:** 3 kV optical isolation

## Digital Output

**Output Channels:** 4, sink type

**Output Current:** Max. 200 mA per channel

**On-state Voltage:** 24 VDC nominal, open collector to 30 VDC

**Connector Type:** screw-fastened Euroblock terminal

**Isolation:** 3 kV optical isolation

## LEDs

**System:** Power

**Storage:** CFast/SSD/HDD/mSATA

**LAN:** 2 LEDs per port (10/100/1000 Mbps)

**Serial:** 2 LEDs per port (Tx and Rx)

## Switches and Buttons

**Power Switch:** on/off

**Reset Button:** For system reset

### Physical Characteristics

**Housing:** Aluminum

**Weight:**

"-W" Models: 2.247 kg

non "-W" Models: 2.168 kg

**Dimensions:**

Without ears: 250 x 57 x 154 mm (9.84 x 2.23 x 6.06 in)

With ears: 275 x 63 x 154 mm (10.83 x 2.47 x 6.06 in)

**Mounting:** DIN rail, wallmount

### Environmental Limits

**Operating Temperature:**

Standard models: -40 to 70°C (-40 to 158°F), with Moxa recommended wireless modules (3G/LTE + Wi-Fi) installed

**Storage Temperature:** -40 to 85°C (-40 to 185°F)

**Ambient Relative Humidity:** 5 to 95% (non-condensing)

**Anti-Vibration:** IEC 60068-2-27: 5 Grms, 5 Hz to 500 Hz, 1 hr/axis w/ mSATA, CFast, SSD

**Anti-Shock:** IEC 60068-2-27: 50 g/11ms ±X, ±Y, ±Z, 3 shocks each axis w/ mSATA, CFast, SSD

### Power Requirements

**Input Voltage:** 9 to 36 VDC (3-pin terminal block for V+, V-, SG)

**Power Consumption:** 18 W (2 A @ 9 VDC)

### Standards and Certifications

**Safety:** UL 60950-1, CSA C22.2 No. 60950-1-03 (60950-1-07), EN 60950-1, CCC, UL 508

**EMC:** EN 55032 Class A, EN 61000-3-2 Class D, EN 61000-3-3, EN 55024, FCC Part 15 Subpart B Class A, EN 61000-6-2, EN 61000-6-4

**Green Product:** RoHS, CRoHS, WEEE

### Reliability

**Automatic Reboot Trigger:** Software-programmable watchdog timer configurable from 1 to 255 seconds

### Warranty

**Warranty Period:** 3 years

**Details:** See [www.moxa.com/warranty](http://www.moxa.com/warranty)

**Note:** These hardware specifications describe the embedded computer unit itself, but not its official accessories. In particular, the wide temperature specification does not apply to accessories such as power adapters and cables.

# Hardware Block Diagram

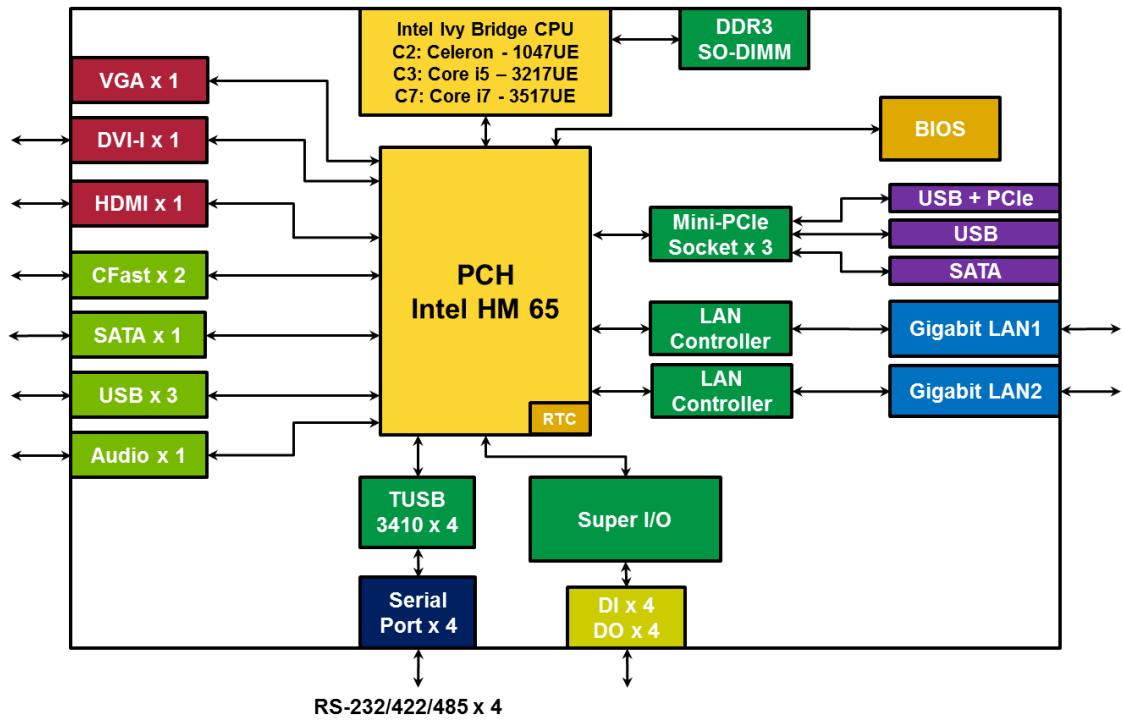

## Hardware Introduction

---

The V2403 series embedded computers are compact, well-designed, and rugged enough for industrial applications. LED indicators help you monitor performance and identify trouble spots, multiple serial ports allow you to connect different devices for wireless operation, and the reliable and stable hardware platform lets you devote your attention to developing your applications.

The following topics are covered in this chapter:

- ❑ **Appearance**
- ❑ **Dimensions**
- ❑ **LED Indicators**
- ❑ **Reset Button**
- ❑ **Real Time Clock (RTC)**

# Appearance

## Front View

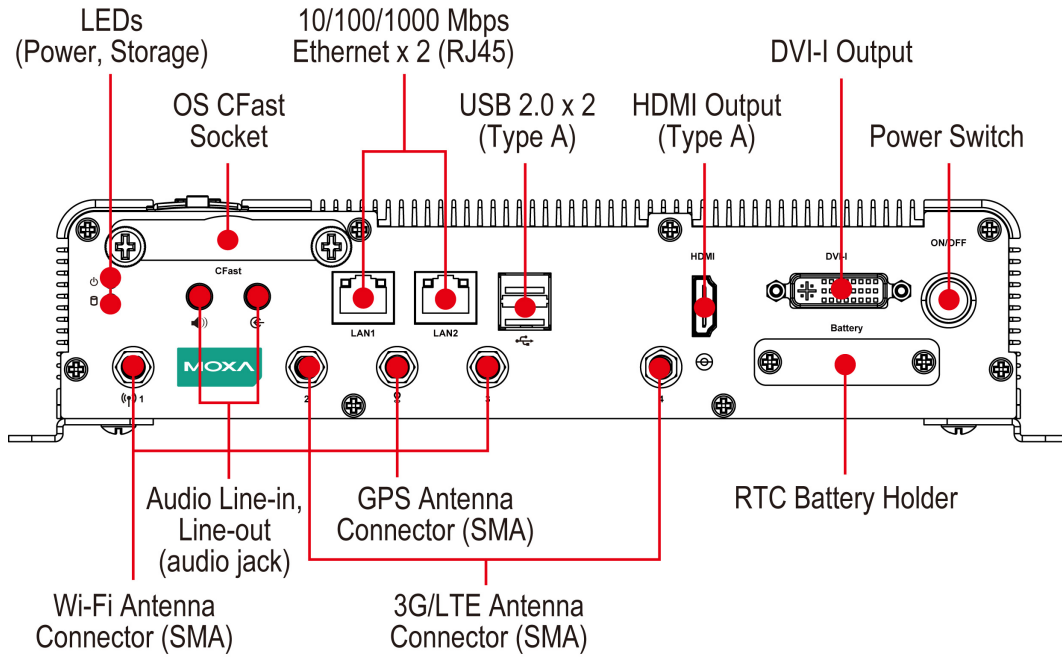

## Rear View

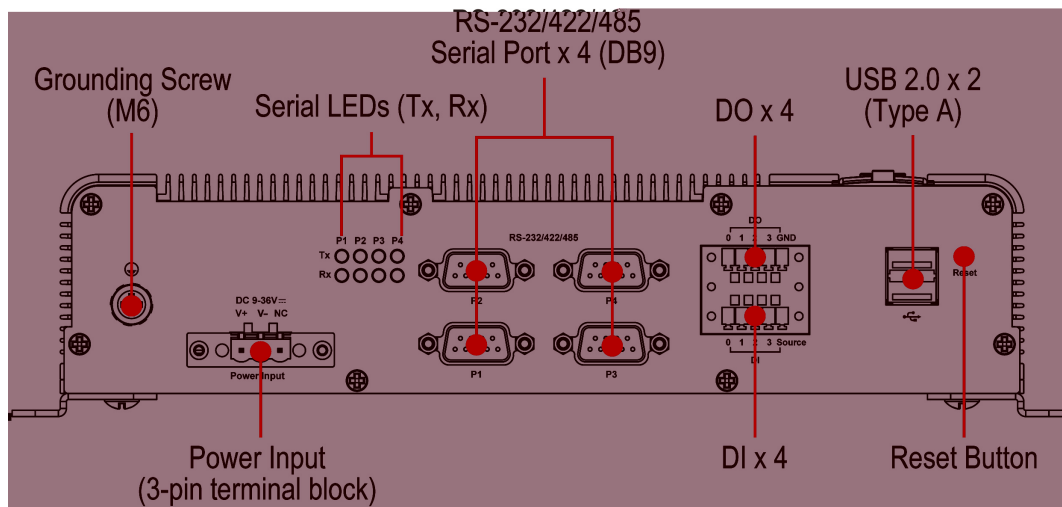

# Dimensions

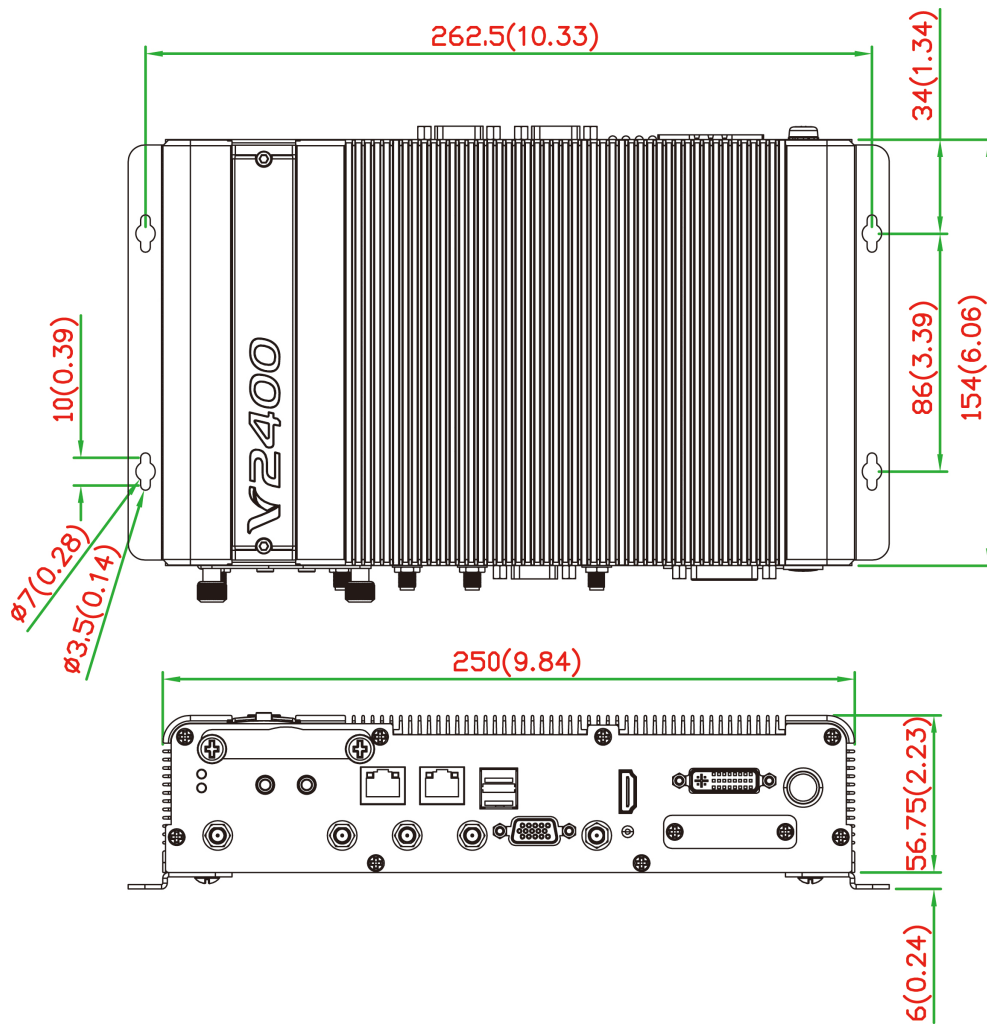

# LED Indicators

LED Name	LED Color	LED Function
Power	Green	Power is on and functioning normally.
	Off	Power is off or power error exists.
Storage	Yellow	CFast card/HDD/SSD/mSATA is transmitting data.
	Off	CFast card/HDD/SSD/mSATA is not transmitting data.
LAN (1 or 2)	Green	100 Mbps Ethernet mode.
	Yellow	1000 Mbps Ethernet mode.
	Off	10 Mbps or no activity.
TX (P1-P4)	Green	Serial port (P1-P4) is transmitting data.
	Off	Serial port (P1-P4) is not transmitting data.
RX (P1-P4)	Yellow	Serial port (P1-P4) is receiving data.
	Off	Serial port (P1-P4) is not receiving data.



## Reset Button

Press the “Reset Button” on the rear panel of the computer to reboot the system automatically. Pushing the reset button will restart the system immediately, and any unsaved data will be lost.

The V2403 does not support a “Reset to Default” function.

## Real Time Clock (RTC)

The V2403's real-time clock is powered by a lithium battery. You can easily replace the battery yourself using an optional battery kit\*. However, please note that there is a risk of explosion if the battery is replaced by an incorrect type of battery. Refer to the V2403 Hardware User's Manual or contact a qualified Moxa support engineer if you have any questions about the RTC battery.

\*Moxa offers an “RTC battery kit” that you can use to easily replace the battery. For details, check the optional accessories section of the V2403 datasheet.



### ATTENTION

There is a risk of explosion if the battery is replaced by a battery of the incorrect type.

# Hardware Connection Description

---

In this chapter, we show how to connect the embedded computers to the network and to various devices.

The following topics are covered in this chapter:

- ❑ **Installing the V2403**
- ❑ **Wiring Requirements**
  - Connecting the Power
  - Grounding the Unit
- ❑ **Connecting Data Transmission Cables**
  - Installing the Mini-PCIe Modules and USIM Cards
  - Connecting to the Network
  - Connecting to a Serial Device
  - Installing a CFast Card
- ❑ **Connecting to a USB Device**
- ❑ **DI/DO**
- ❑ **Connecting to a DVI-I Monitor**
- ❑ **HDMI Outputs**
- ❑ **Connecting to a VGA Monitor**
- ❑ **Connecting to a Speaker or a Headphone**
- ❑ **Installing a SATA Hard Disk**
- ❑ **RTC Battery Replacement**

# Installing the V2403

## Wall or Cabinet Mounting

The V2403 comes with two metal brackets for attaching the device on a wall or to the inside of a cabinet. Complete the following steps to attach the mounting brackets to the V2403.

**Step 1:** Use two screws for each bracket to attach the brackets to the rear of the V2403.

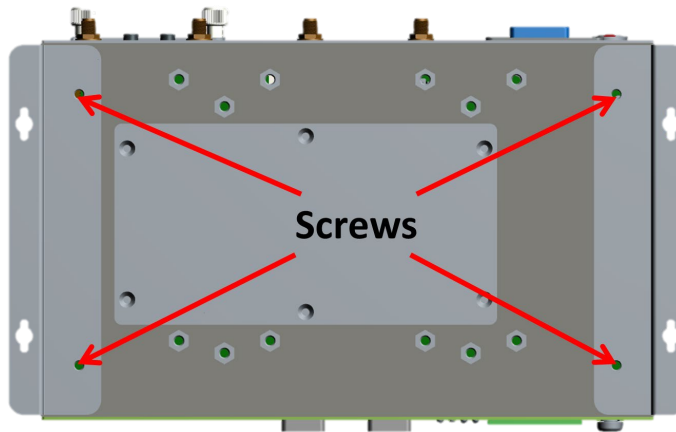

**Step 2:** Use two screws per side to mount the V2403 on a wall or in a cabinet.

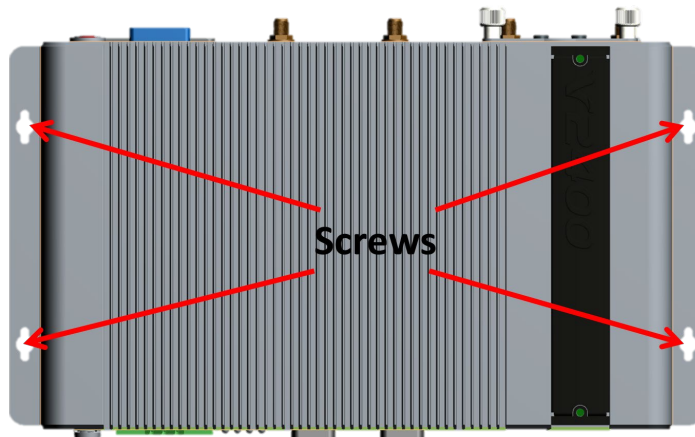

## DIN-Rail Mounting

The V2403 can be installed on a DIN-rail with the optional DIN-rail kit. This DIN-rail kit must be purchased separately. The DIN-rail kit includes two DIN-rail brackets and eight screws.



To attach the DIN-rail kit, complete the following steps:

1. Turn the V2403 over so the bottom is facing up.
2. Locate the screw holes on the bottom of the V2403.

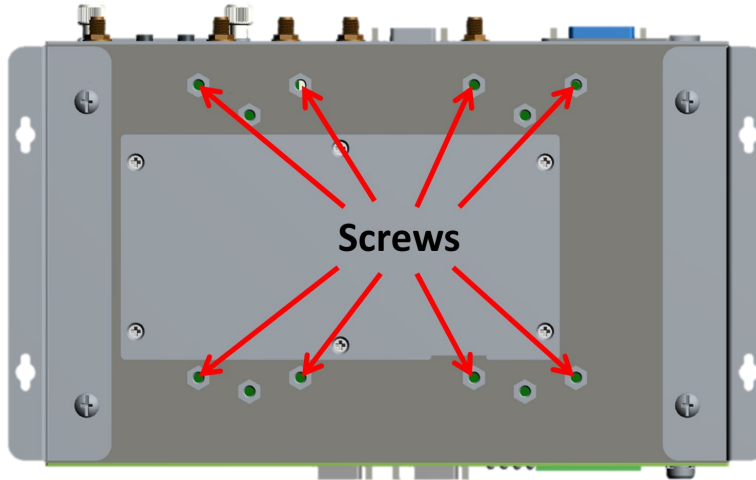

3. Place the brackets on the bottom of the V2403 and align the screw holes on the brackets with the screw holes on the V2403.
4. Insert and tighten the screws into the screw holes.

**NOTE** Use all eight screws to ensure that the V2403 is safely and securely installed on the DIN rail.

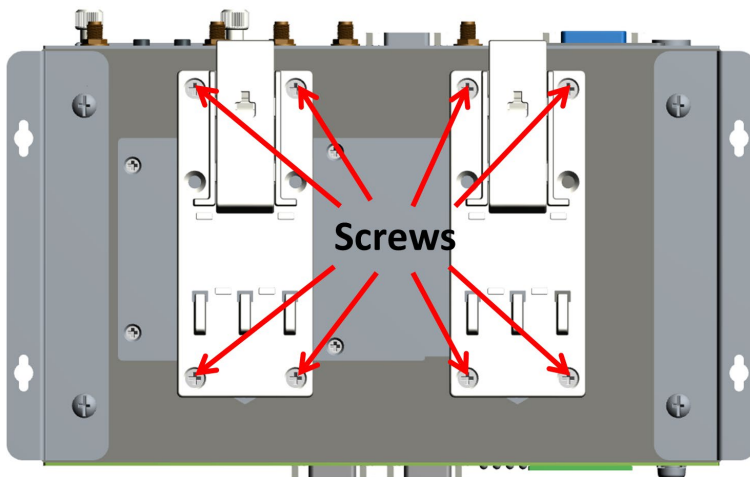

5. When the brackets are firmly attached with the screws, you can install the V2403 onto a DIN-rail.
- To remove the V2403 from the DIN rail, first use a screwdriver to pull down the DIN-rail connector to unlock it.

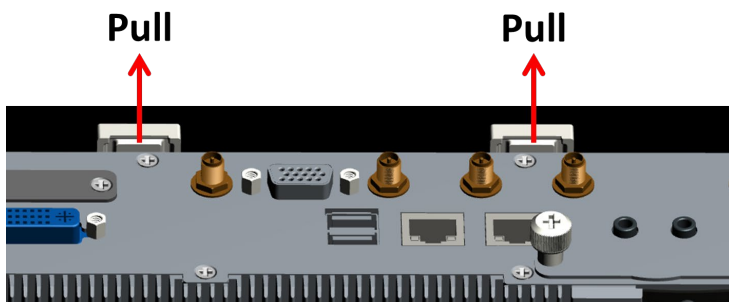

To re-install the V2403 on the DIN rail, use a screwdriver to press the buckle so that it can be released. At this point, it can be re-installed on the DIN rail.

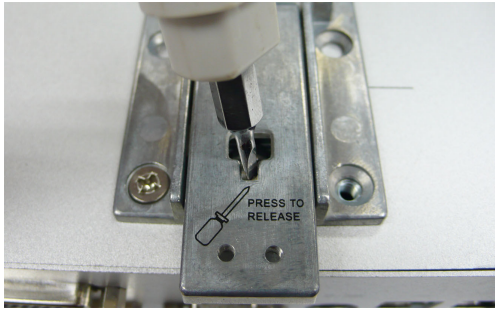

## Wiring Requirements

In this section, we describe how to connect serial devices to the V2403 embedded computer.

Be sure to read and follow these common safety precautions before proceeding with the installation of any electronic device:

- Use separate paths to route wiring for power and devices. If power wiring and device wiring paths must cross, make sure the wires are perpendicular at the intersection point.  
**NOTE:** Do not run signal or communication wiring together with power wiring in the same wire conduit. To avoid interference, wires with different signal characteristics should be routed separately.
- Use the type of signal transmitted through a wire to determine which wires should be kept separate. The rule of thumb is that wiring that shares similar electrical characteristics can be bundled together.
- Keep input wiring and output wiring separate.
- It is advisable to label the wiring to all devices in the system.



### ATTENTION

#### Safety First!

Be sure to disconnect the power cord before installing and/or wiring your V2403.

#### Wiring Caution!

Calculate the maximum possible current in each power wire and common wire. Observe all electrical codes dictating the maximum current allowable for each wire size. If the current goes above the maximum ratings, the wiring could overheat, causing serious damage to your equipment.

#### Temperature Caution!

Be careful when handling the unit. When the unit is plugged in, the internal components generate heat, and consequently the outer casing may feel hot to the touch.

## Connecting the Power

To power on the V2403, connect the “terminal block to power jack converter” to the V2403’s DC terminal block (located on the side panel), and then connect the power adapter. By default, the system turns on automatically when the power is plugged in. If it does not turn on automatically, press the Power Button to turn on the computer. Note that the Shielded Ground wire should be connected to the top pin of the terminal block. It takes about 30 seconds for the system to boot up. Once the system is ready, the Power LED will light up.

## Grounding the Unit

Grounding and wire routing help limit the effects of noise due to electromagnetic interference (EMI). Run the ground connection from the grounding screw (M5) to the grounding surface prior to connecting the power.



### ATTENTION

This product is intended to be mounted on a well-grounded mounting surface, such as a metal panel.

## Connecting Data Transmission Cables

In this section, we describe how to connect the V2403 embedded computer to a network and serial devices.

## Installing the Mini-PCIe Modules and USIM Cards



### ATTENTION

Select "-W" models (e.g., V2403-C2-W-T) when placing V2403 orders for wireless applications. Moxa will add 3 mini-PCIe sockets during production. Note that the internal storage kit cannot be used with "-W" models. To expand the storage of "-W" models, use an mSATA card.

The V2403 features 3 mini-PCIe sockets on the bottom panel.

- **Socket 1:** USB + PCIe signal, for Wi-Fi mini-PCIe card
- **Socket 2:** USB signal, for 3G/LTE mini-PCIe card (Sierra Wireless MC7304, MC7354, MC9090)
- **Socket 3:** SATA signal (for mSATA)

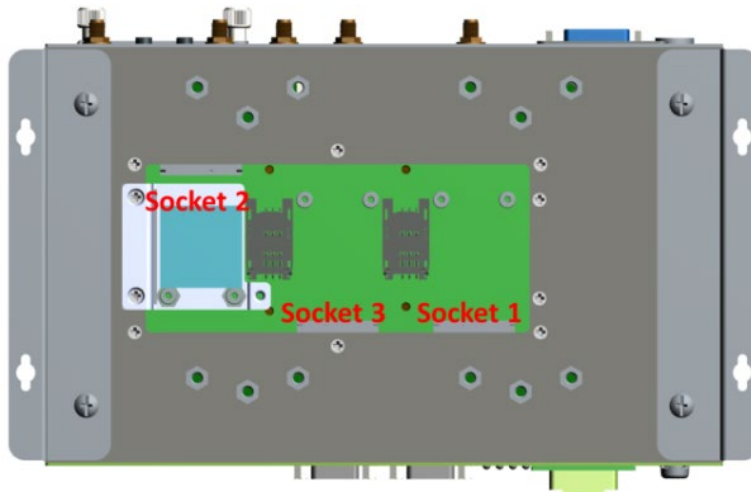

## Installing a mini-PCIe Card in Socket 1 and Socket 3

**STEP 1:** Loosen the 6 screws in the middle of the bottom cover and then open the bottom cover.

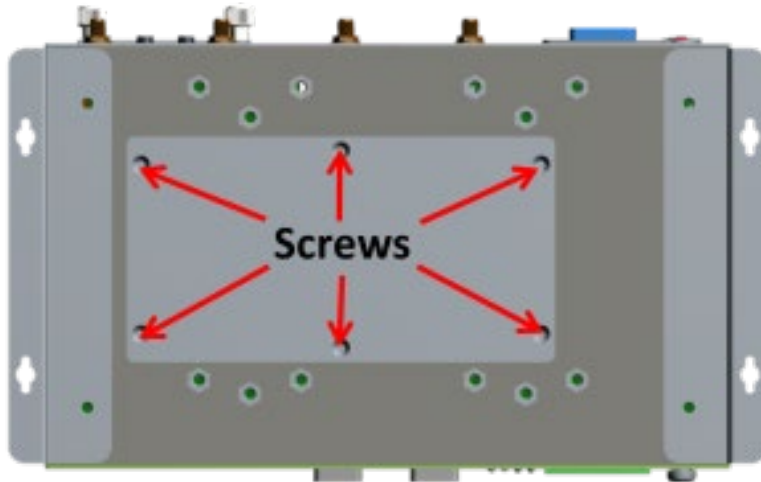

**STEP 2:** Obliquely insert the mini-PCIe module card.

**STEP 3:** Push down the mini-PCIe module card and fasten it with the 2 black screws from the module card package you purchased from Moxa.

**STEP 4:** If you installed a wireless mini-PCIe card, connect the antenna cables with wireless module card.  
No.1 & No.3: Wi-Fi mini-PCIe card.

**STEP 5:** Replace the bottom cover.

## Installing a mini-PCIe Card in Socket 2

**STEP 1:** Loosen the 6 screws in the middle of the bottom cover and open the bottom cover.

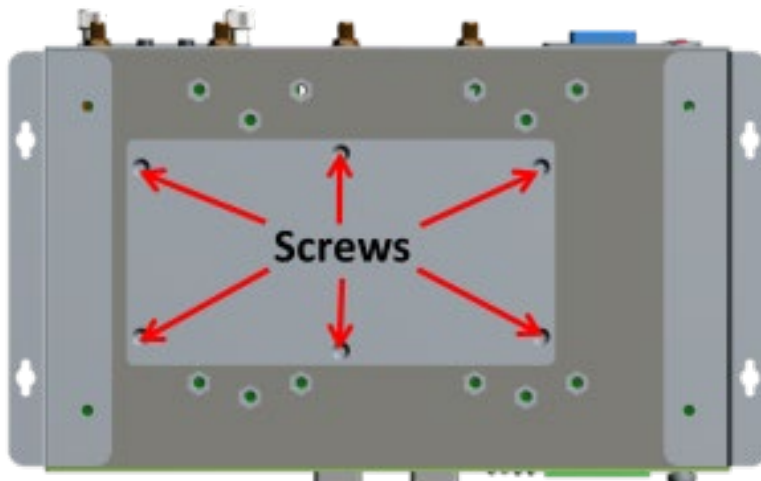

**STEP 2:** Get the upper heat sink cover from the wireless package.



**STEP 3:** Obliquely insert the mini-PCIe module card in socket 2, and fasten it with the 2 black screws from the wireless package.

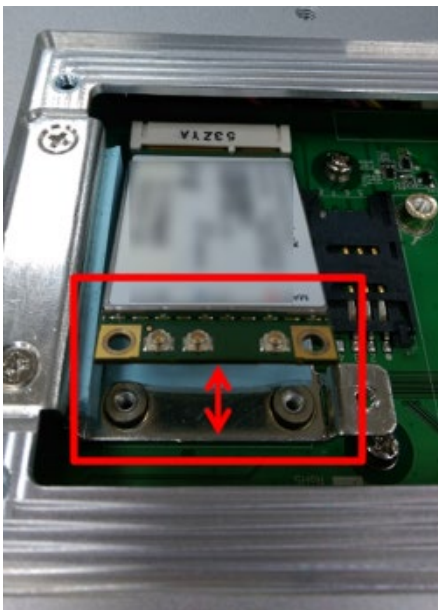

**STEP 4:** Connect the antenna cables to the wireless module card:  
No. 2 & No. 4: 3G/LTE mini-PCIe card, No. 5: GPS





**STEP 5:** Use the fillister to obliquely buckle the heat sink that was already installed inside the V2403 computer, as shown below:

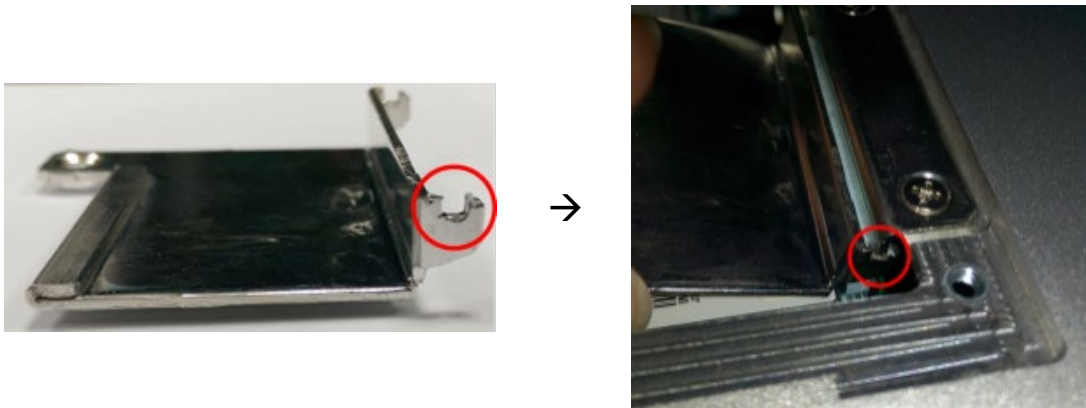

**STEP 6:** Slightly push down the upper heat sink cover and use the silver screw from the wireless package to fasten the upper heat sink cover (outlined in red below).

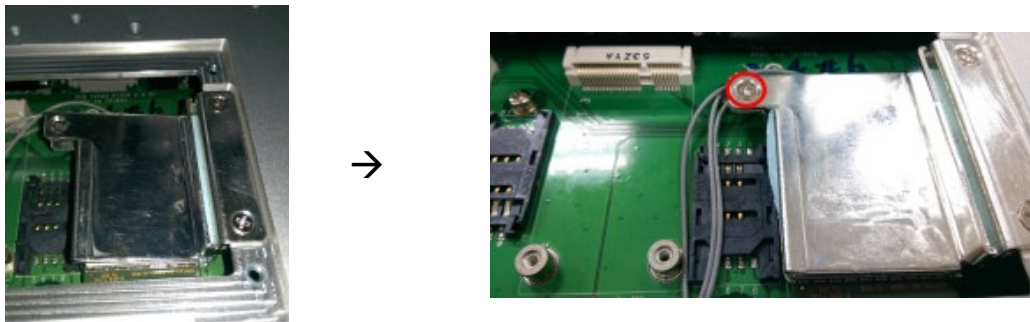

**STEP 7:** Replace the bottom cover.

### Installing the USIM card

The V2403 has 2 USIM slots for 3G/LTE wireless Internet connections. Instructions for installing a USIM card are shown below:

Pull up the USIM card slot and insert the USIM card. When finished, replace the holder and slide the slot towards the catch to fasten the holder.



**NOTE** You may also purchase 3G, 4G, and Wi-Fi external antennas from from Moxa. Please contact Moxa sales representative for your demand.

## Connecting to the Network

Connect your network cable to the embedded computer’s Ethernet port. The other end of the cable should be connected to your Ethernet network. When the cable is properly connected, the LEDs on the embedded computer’s Ethernet port turns on to indicate a valid connection.

Two 10/100/1000 Mbps Ethernet ports using RJ45 connectors are located on the front panel of the embedded computer. See the following figure for the location of the Ethernet ports and the pin assignments.

**NOTE** The pin assignments for the V2403 computer’s Ethernet port are shown in the following figure. If you create your own Ethernet cable, make sure that you match the pin assignments on the connector of the Ethernet cable.

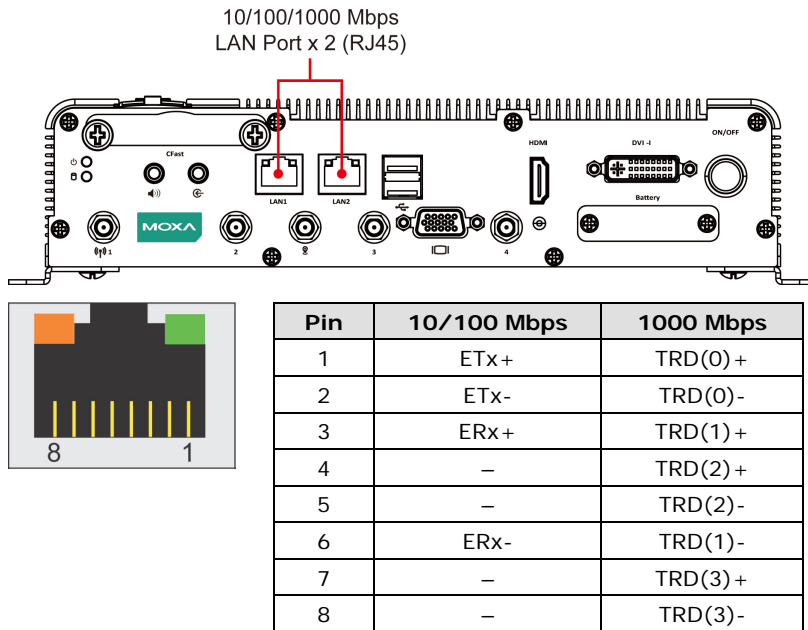

## Connecting to a Serial Device

Use a serial cable to connect your serial device to the embedded computer’s serial port. Serial ports P1 to P4 have male DB9 connectors and can be configured for RS-232, RS-422, or RS-485 communication (refer to the software manual for your operating system version). The pin assignments are shown in the following table:

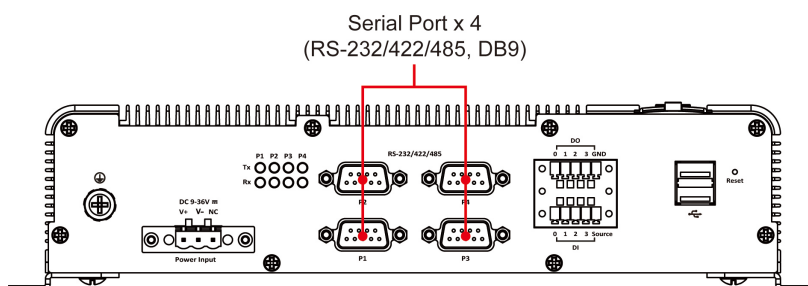

DB9 Male Port

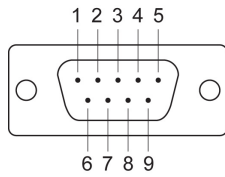

RS-232/422/485 Pinouts

Pin	RS-232	RS-422	RS-485 (4-wire)	RS-485 (2-wire)
1	DCD	TxDA(-)	TxDA(-)	–
2	RxD	TxDB(+)	TxDB(+)	–
3	TxD	RxDB(+)	RxDB(+)	DataB(+)
4	DTR	RxDA(-)	RxDA(-)	DataA(-)
5	GND	GND	GND	GND
6	DSR	–	–	–
7	RTS	–	–	–
8	CTS	–	–	–

## Installing a CFast Card

The V2403 embedded computers come with a CFast socket. To insert a CFast card, follow these instructions:

1. Disconnect the V2403 from its power source.
2. The CFast slot is located on the left side of the front panel. Loosen the screws on the CFast socket cover.

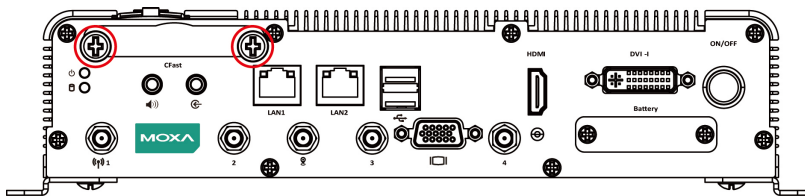

3. Press the CFast card to eject it.  
When you want to insert it back into the CFast slot, slide it into the slot and then push it in with your finger until it latches firmly.

**NOTE** Make sure that you properly orient the the CFast card when installing it; otherwise, you may not be able to insert the card all the way into the slot.

**ATTENTION** Make sure that you orient the CFast card properly before pushing it into the slot. The bottom of the CFast card must be facing up for the card to work properly, and for the CFast socket cover to be installed properly.

4. After the CFast card is installed correctly, fasten the screws on the CFast card socket cover to install it.

**ATTENTION** The V2403 embedded computer does not support the CFast hot swap and PnP (Plug and Play) functions. You must disconnect the power source first, before inserting or removing the CFast card.

## Connecting to a USB Device

The V2403 comes with one USB 2.0 host with Type-A connector on the front panel and two USB 2.0 hosts with type A connectors on the rear panel. These ports can be used for connecting to an external flash disk or hard drive for storing data. You can also use these USB ports to connect to a keyboard or a mouse.

The following figures show the locations of the USB ports.

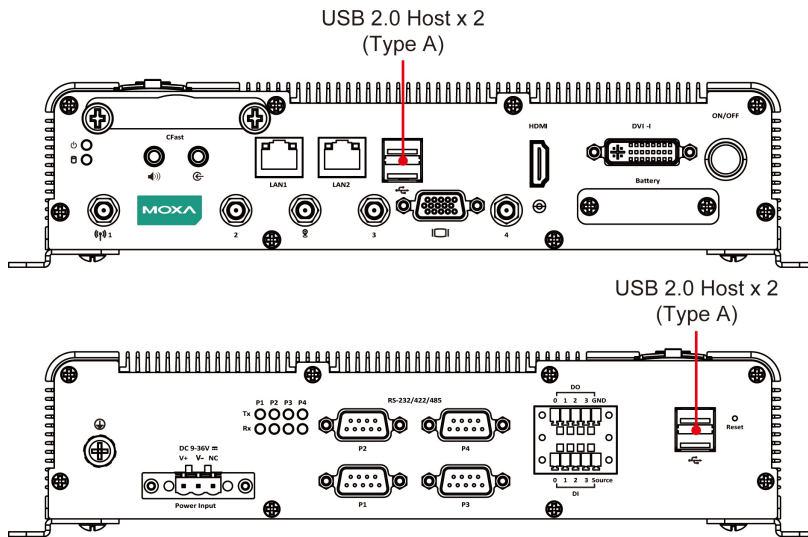

## DI/DO

The V2403 comes with a 4-ch digital input and a 4-ch digital output that connect through a terminal block connector. The pin assignments and wiring methods are shown below.

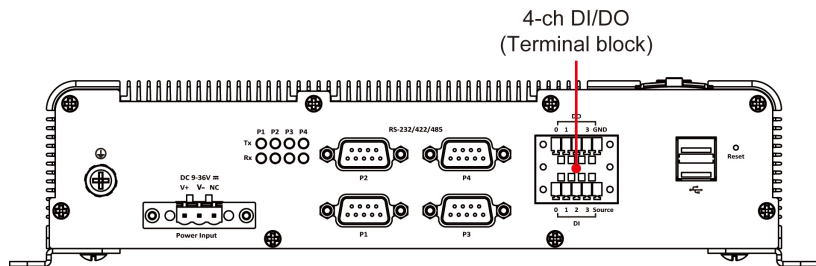
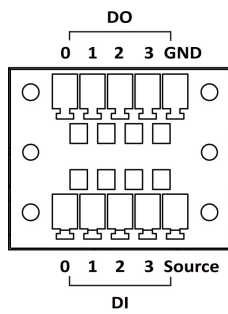

DI Dry Contact

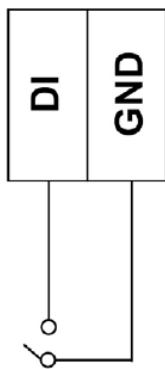

DI Wet Contact

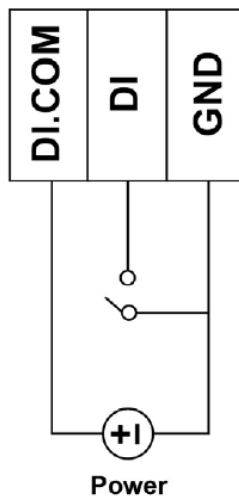

DO Contact

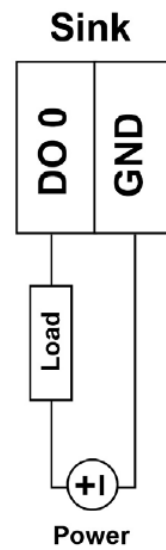

# Connecting to a DVI-I Monitor

The V2403 computers come with a DVI-I connector that you can connect to a DVI monitor. Use the cable to connect one end to the DVI-I connector on the V2403's front panel and the other end to the monitor.

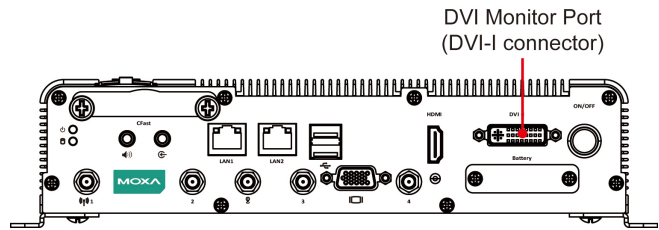

The following table lists the DVI-I connector pin assignments.

## DVI-I Connector

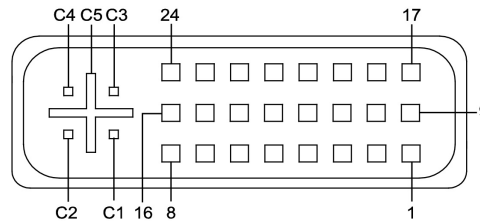

Pin No.	Signal Definition	Pin No.	Signal Definition
1	T.M.D.S. Data2-	16	Hot Plug Detect
2	T.M.D.S. Data2+	17	T.M.D.S. Data0-
3	T.M.D.S. Data2/4 Shield	18	T.M.D.S. Data0+
4	T.M.D.S. Data4-	19	T.M.D.S. Data0/5 Shield
5	T.M.D.S. Data4-	20	T.M.D.S. Data5-
6	DDC Clock	21	T.M.D.S. Data5+
7	DDC Data	22	T.M.D.S. Clock Shield
8	Analog Vertical Sync	23	T.M.D.S. Clock+
9	T.M.D.S. Data1-	24	T.M.D.S. Clock-
10	T.M.D.S. Data1+	C1	Analog Red
11	T.M.D.S. Data1/3 Shield	C2	Analog Green
12	T.M.D.S. Data3-	C3	Analog Blue
13	T.M.D.S. Data3+	C4	Analog Horizontal Sync
14	+5V Power	C5	Analog Ground (analog R, G, B return)
15	Ground (return for +5V, HSync, and VSync)		

# HDMI Outputs

The V2403 comes with a type A HDMI female connector and a DVI-I female connector on the front panel to connect an HDMI or DVI-I supported monitor.

The screw hole above the HDMI connector is used to attach a customized lock to the HDMI connector; a custom lock is needed since the shape of different HDMI connectors are not the same. Contact a Moxa sales representative for details.

The lock appears as shown below:



The lock should appear as follows after it is attached to the V2403:



## Connecting to a VGA Monitor

The V2403 can support VGA output; contact your Moxa sales representative for details.

## Connecting to a Speaker or a Headphone

The V2403 comes with a Line-in audio connector for audio input and a Line-out audio connector for audio output, allowing users to connect a speaker or earphones.

Audio Output/Input  
(Line-in audio connector)

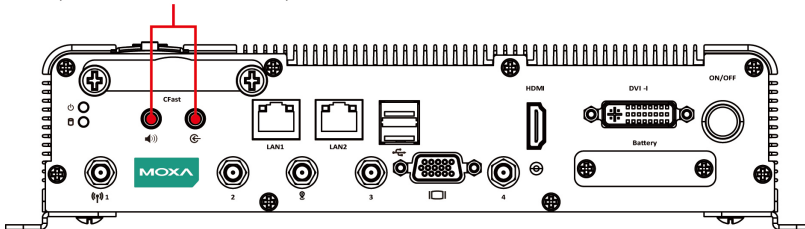

## Installing a SATA Hard Disk

The V2403 has one SATA-I/II connector for 2.5" SSD/HDD storage expansion. To expand storage capacity, purchase an SSD/HDD and an internal storage kit\* through Moxa's CTO\*\* service.

\*This must be purchased separately to install an SSD / HDD. For details, check the optional accessories section of the V2403 datasheet.

\*\*CTO = Configure to order

# RTC Battery Replacement

The V2403 embedded computer has an easy RTC battery replacement design.



## WARNING

There is a risk of explosion if the battery is replaced by an incorrect type of battery. Consult with a qualified Moxa support engineer if you have any questions or are unclear about any these instructions.

Complete the following steps to replace the battery:

1. You will need to use the "RTC Battery Kit," which is listed as an optional accessory in the V2403 datasheet's list of optional accessories.

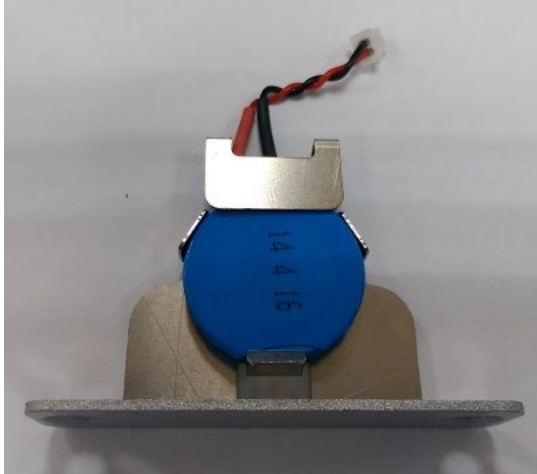

2. Make sure that the V2403 is turned off and is disconnected from its power source.
3. The RTC battery socket is located to the left of the "ON/OFF" power button, below the "DVI-I 2" connector. Loosen two screws used to attach the RTC battery socket cover to the V2403.

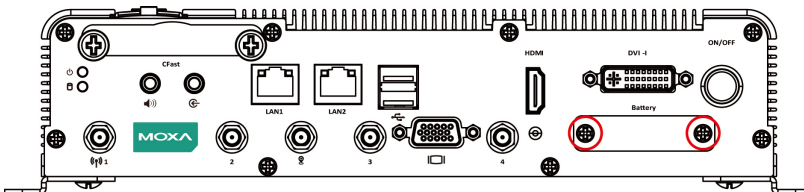

4. Lift up and pull out the RTC battery holder.
5. Disconnect the power cable between the battery and the V2403, and then connect the new RTC Battery Kit to the V2403.

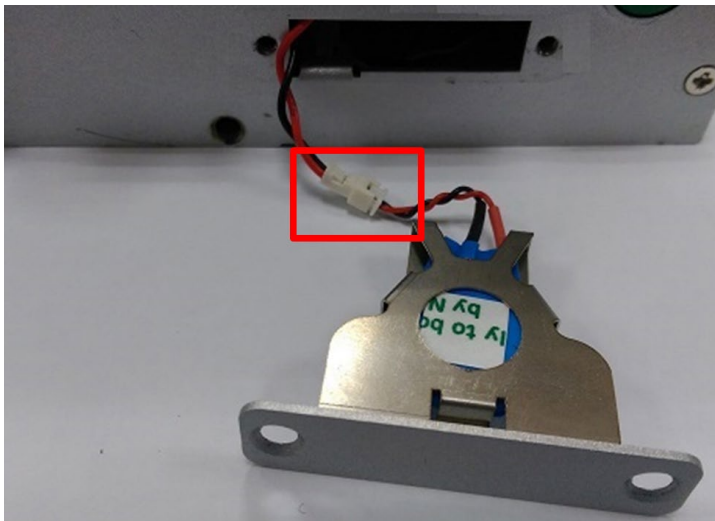

6. Slide the battery holder back into the RTC battery socket and then fasten the socket cover to the V2403 using the screws you removed in Step 3 above.



# BIOS Setup

---

In this chapter, we describe the BIOS settings for the V2403 embedded computer. The BIOS is a set of input/output control routines for peripherals, and is used to initialize basic peripherals and help boot the operating system before the operating system is loaded. The BIOS setup allows the user to modify the system configurations of these basic input/output peripherals. All of the configurations are stored in the CMOS RAM, which has a backup battery power in case the computer is not connected to a power source. Consequently, the data stored in the CMOS RAM is retained when the system is rebooted or the power is disconnected.

The following topics are covered in this chapter:

## ❑ Entering the BIOS Setup

### ❑ Main Information

### ❑ Advanced Settings

- Boot Configuration
- HDC Configuration
- Video Configuration
- Chipset Configuration
- Hardware Monitor
- SMART RECOVERY Info

### ❑ Security Settings

- Set Supervisor Password

### ❑ Power Settings

- Turbo Mode
- Auto Wake on S5
- Wake on LAN

### ❑ Boot Settings

- Boot Type
- PXE Boot to LAN
- Add Boot Options
- USB Boot
- EFI Device First
- Boot Delay Time
- Legacy

### ❑ Exit Settings

- Exit Saving Changes
- Save Change Without Exit
- Exit Discarding Changes
- Load Optimal Defaults
- Load Custom Defaults
- Save Custom Defaults
- Discard Changes

### ❑ Upgrading the BIOS

## Entering the BIOS Setup

To enter the BIOS setup utility, press the **F2** key while the system is booting up. The main **BIOS Setup** screen appears with the following options:

- **Continue:** Continue to boot up
- **Boot Manager:** Select the device to boot up
- **Boot From File:** Select the UEFI boot up file
- **SCU:** Enter the BIOS configuration.

Click **SCU** to enter the **BIOS configuration**.

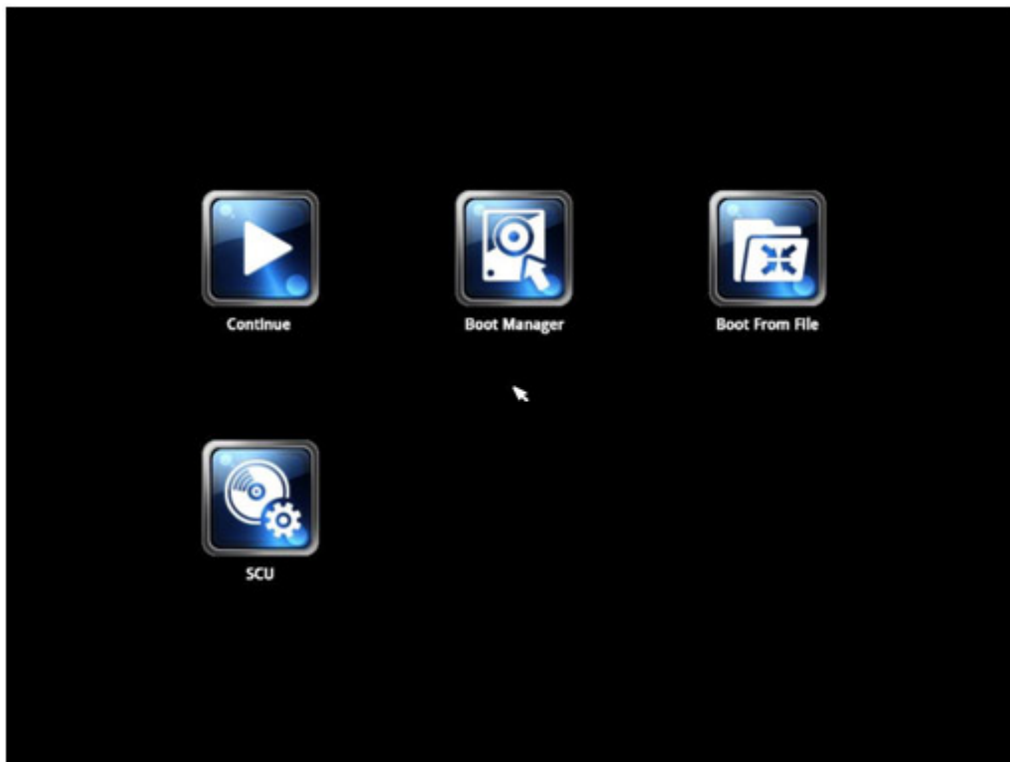

When you click **SCU**, a basic description of each function key is listed at the bottom of the screen. Refer to these descriptions to learn how to use them.

**F1: Help**

**F5/F6: Change Values**

**F9: Setup Defaults**

**F10: Save and Exit**

**↑ ↓: Select Item**

**← →: Select Menu**

**ESC: Exit**

**ENTER: Select or go to Submenu.**

# Main Information

The main page shows basic system information, such as the model name, BIOS version, and CPU type.

**NOTE** The “Processor Type” varies depending on the product model.

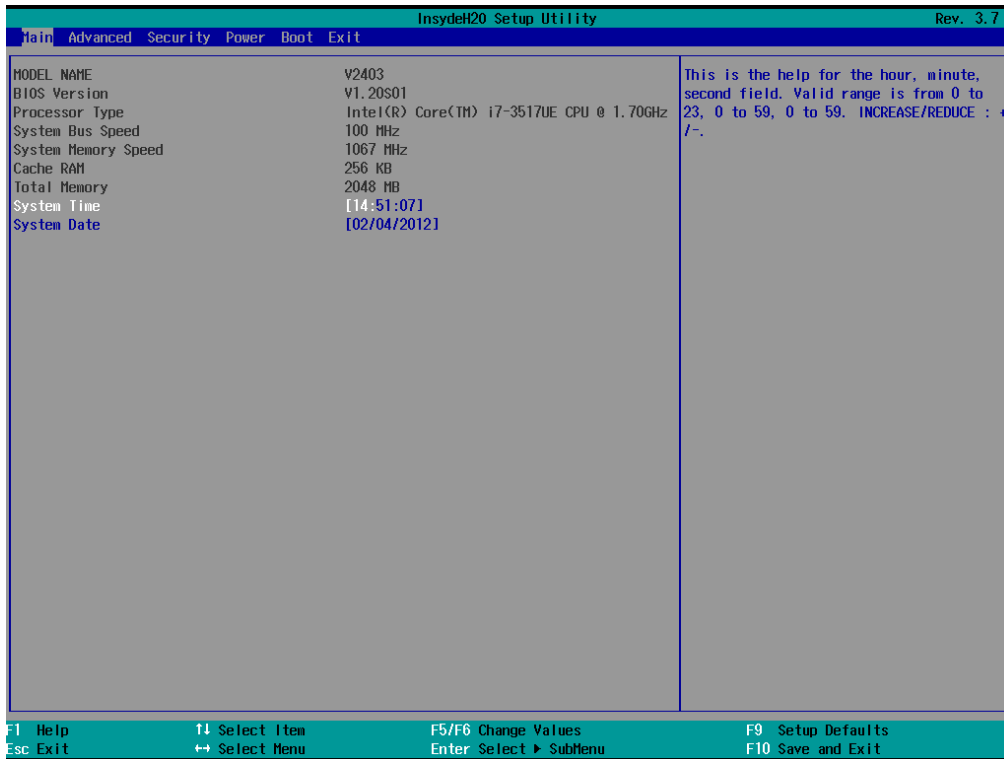

# Advanced Settings

The **Advanced** screen appears when you select “Advanced” from the main menu.

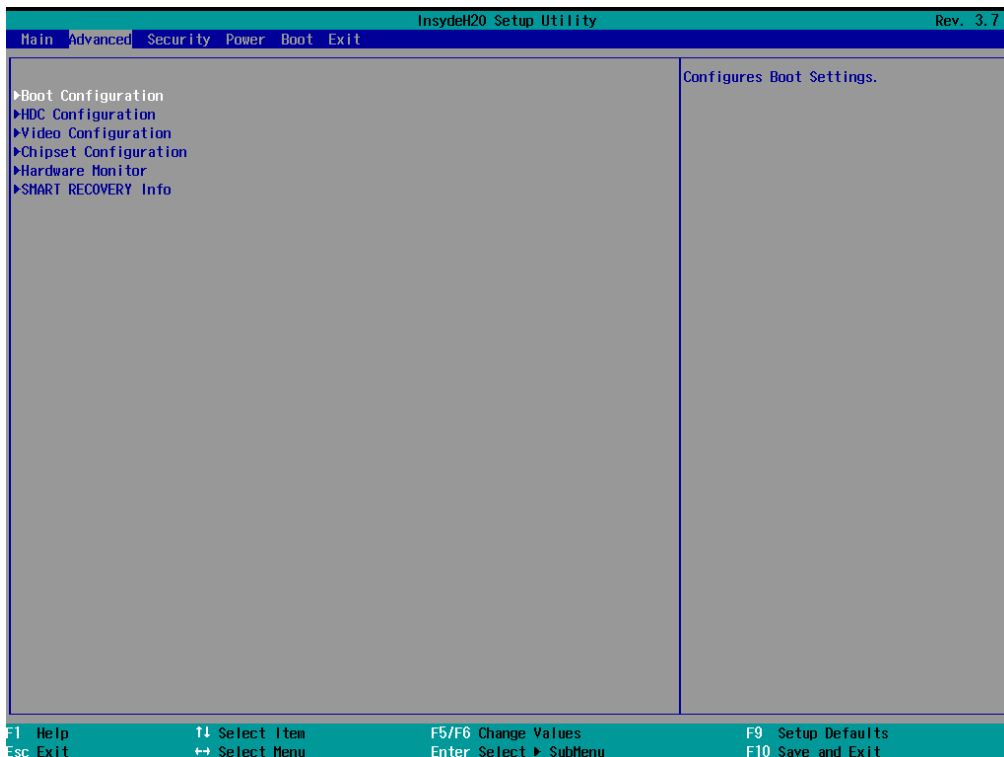

## Boot Configuration

This screen allows you to configure the initial status of the Numlock key when the computer boots up.

Options: On (default), Off

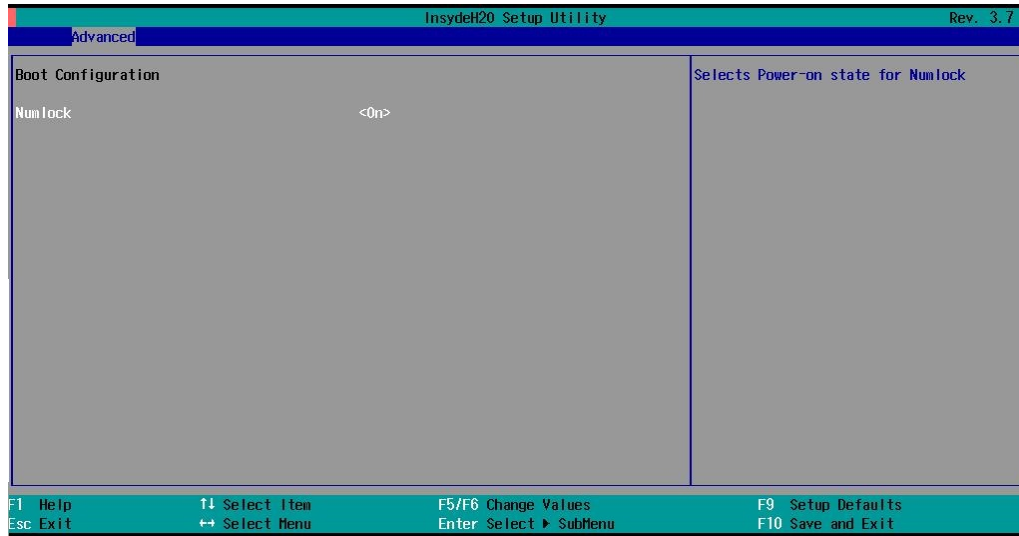

## HDC Configuration

The host drive controller can be configured in IDE or AHCI (default) mode.

When you select the AHCI mode, the following screen appears.

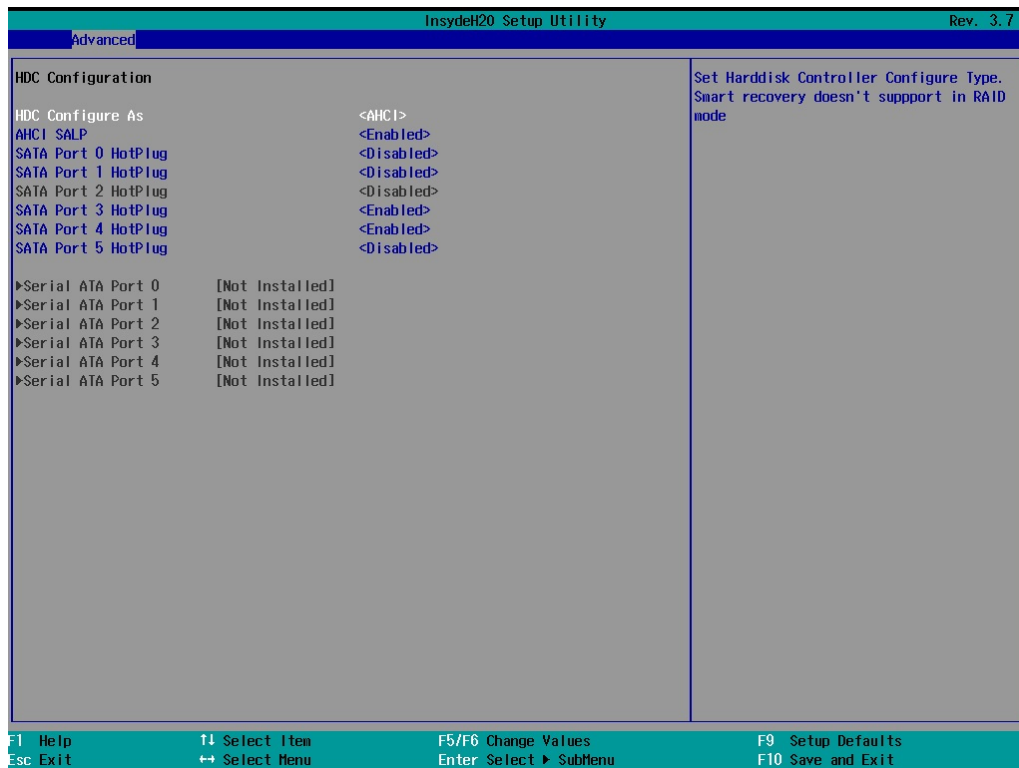

## Serial ATA Port 0 to 5

This setting allows you to display information about the installed drives.

## AHCI SALP

Note that the “AHCI SALP” setting only appears when you select the AHCI mode. This setting allows you to enable aggressive **link power management** (SALP) in AHCI. SALP enables the host bus adapter to conserve power by directly detecting when a SATA drive is no longer processing information and then immediately transition the drive into suspended or sleep mode without waiting for software processes to initiate a power-down process.

Options: Enabled (default), Disabled

## SATA Port 0 to 5—HotPlug

This setting allows you to enable or disable the hotplug feature (the ability to remove the drive while the computer is running) for the installed storage drives.

Options: Disabled (default for Ports 0, 1, 2, and 5), Enabled (default for Ports 3 and 4)

## Video Configuration

This setting allows you to configure the Internal Graphics Device (IGD) settings, such as memory allocation (DVMT).

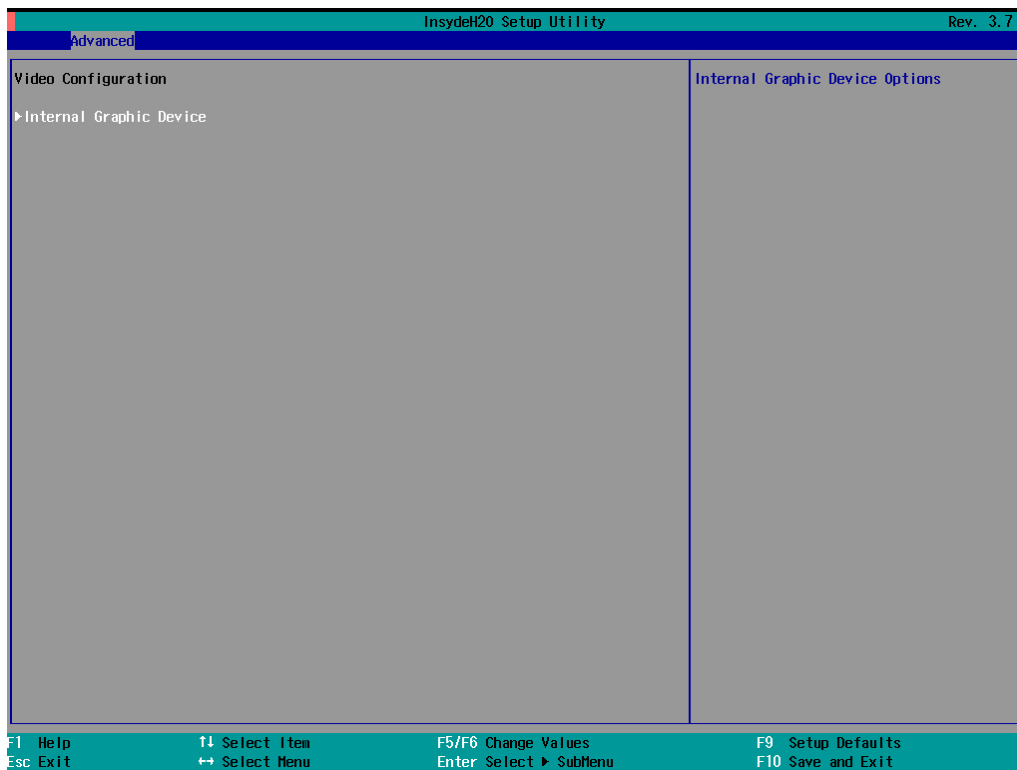

## Internal Graphics Device

This screen allows you to enable or disable the internal graphics device.

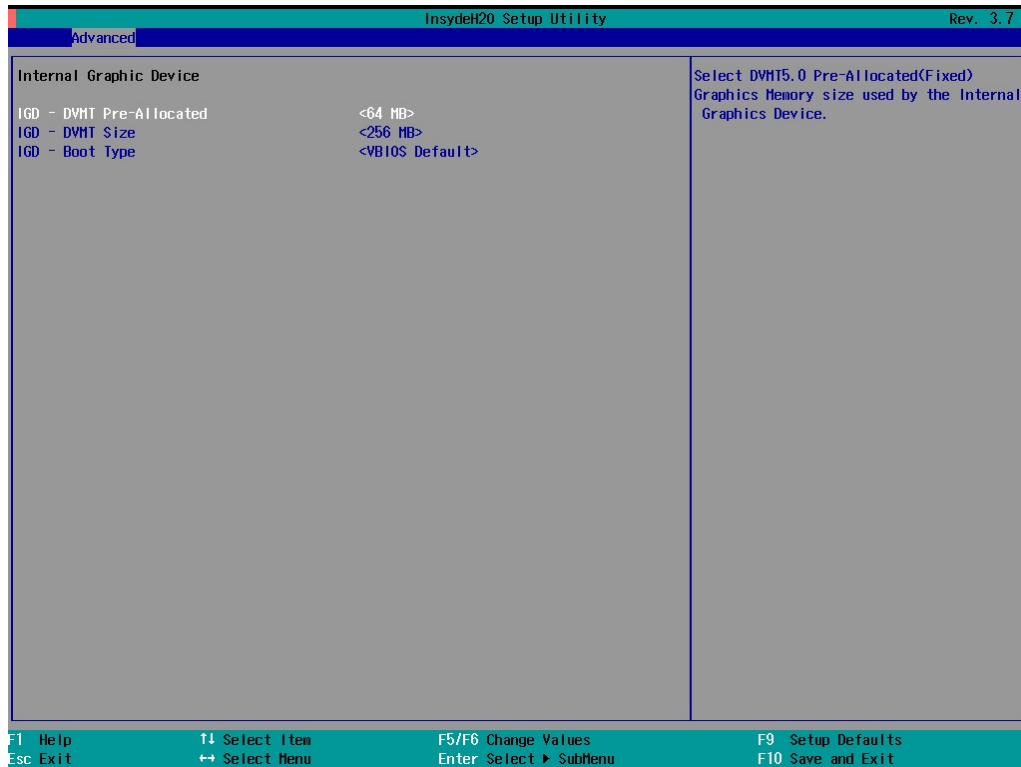

### IGD—DVMT Pre-Allocated

This setting allows you to configure the pre-allocated memory capacity of the IGD. Pre-allocated graphics memory is invisible to the operating system.

Options: 64 MB (default), 32 MB, 96 MB, 128 MB, 256 MB, 512 MB

**DVMT** is a BIOS solution where the optimum amount of memory is dynamically allocated and de-allocated as needed for balanced graphics and system performance, through Intel® Direct AGP and a highly efficient memory utilization scheme. DVMT ensures the most efficient use of available system memory resources for maximum 2D/3D graphics performance.

### IGD—DVMT Size

This setting allows you to configure the maximum amount of memory DVMT uses when allocating additional memory for the IGD.

Options: 256 MB (default), 128 MB, Max

### IGD—Boot Type

This setting allows you to select the video device activated during POST.

Options: VBIOS Default (default), Internal VGA, HDMI, DVI-I Analog, DVI-I Digital

## Chipset Configuration

This screen allows you to configure the chipset settings.

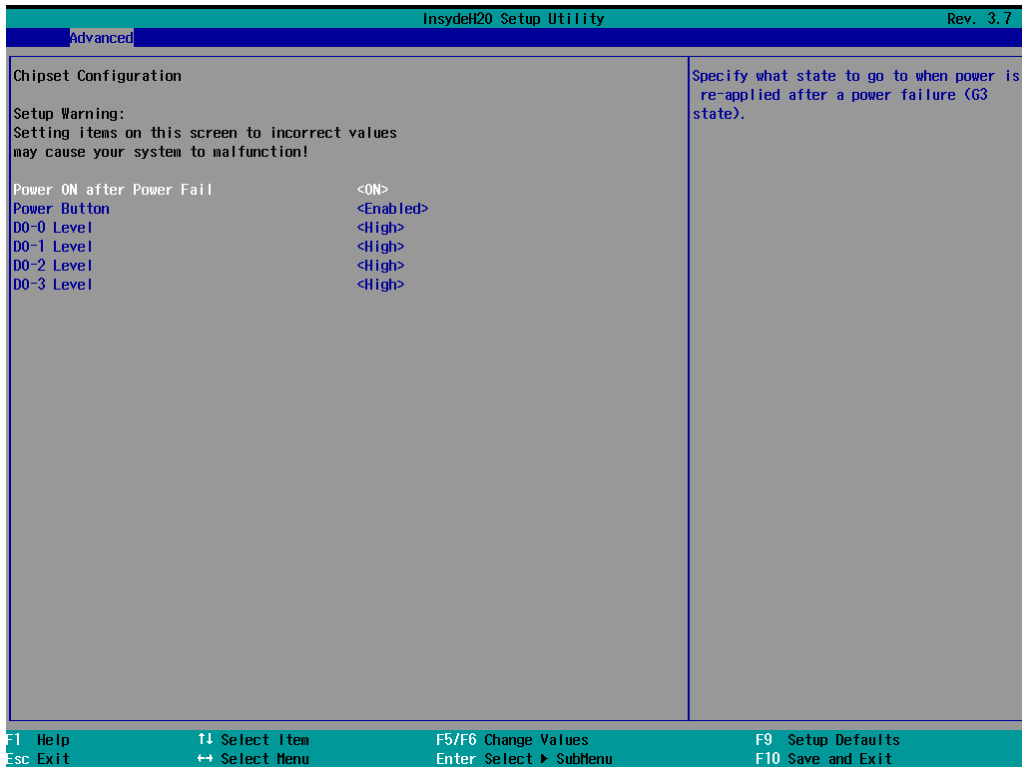

### Power ON after Power Fail

This setting allows you to configure whether or not the computer automatically powers up after a system crash. When set to ON, the computer will automatically power up after a system crash; when set to OFF, it won't automatically power up after a system crash.

Options: ON (default), OFF, Last State

### Power Button

This setting allows you to enable or disable the power button. If the power button is enabled, you can press the power button to power on or power off the computer. If the power button is disabled, you need to press the power button for more than four seconds to power off the computer.

Options: Enabled (default), Disabled

### DO-0 Level

This setting allows you set the DO-0 as high or low.

Options: High (default), Low

### DO-1 Level

This setting allows you set the DO-1 as high or low.

Options: High (default), Low.

## Hardware Monitor

This screen allows you to view voltage levels, system temperature, and CPU temperature.

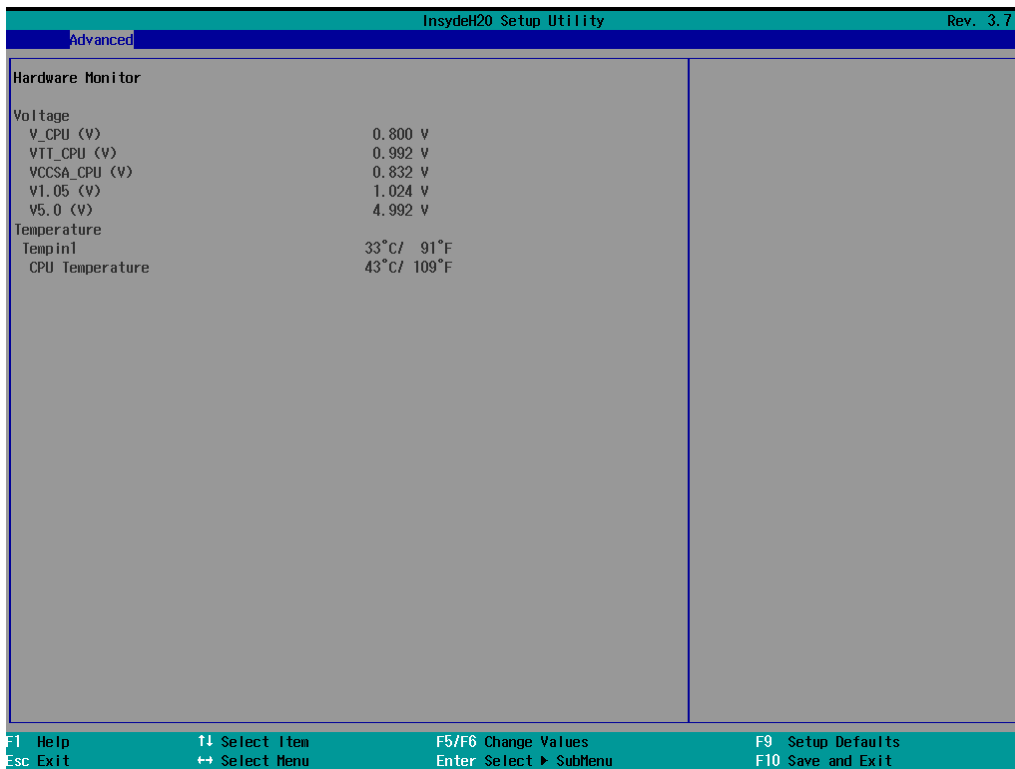

Note that the voltage values vary depending on the model. The temperature readings shown on the screen are within  $\pm 5\%$  of the actual readings. However, the temperature readings are only valid when the ambient temperature is above 0°C.



## SMART RECOVERY Info

This screen allows you to view Smart Recovery information.

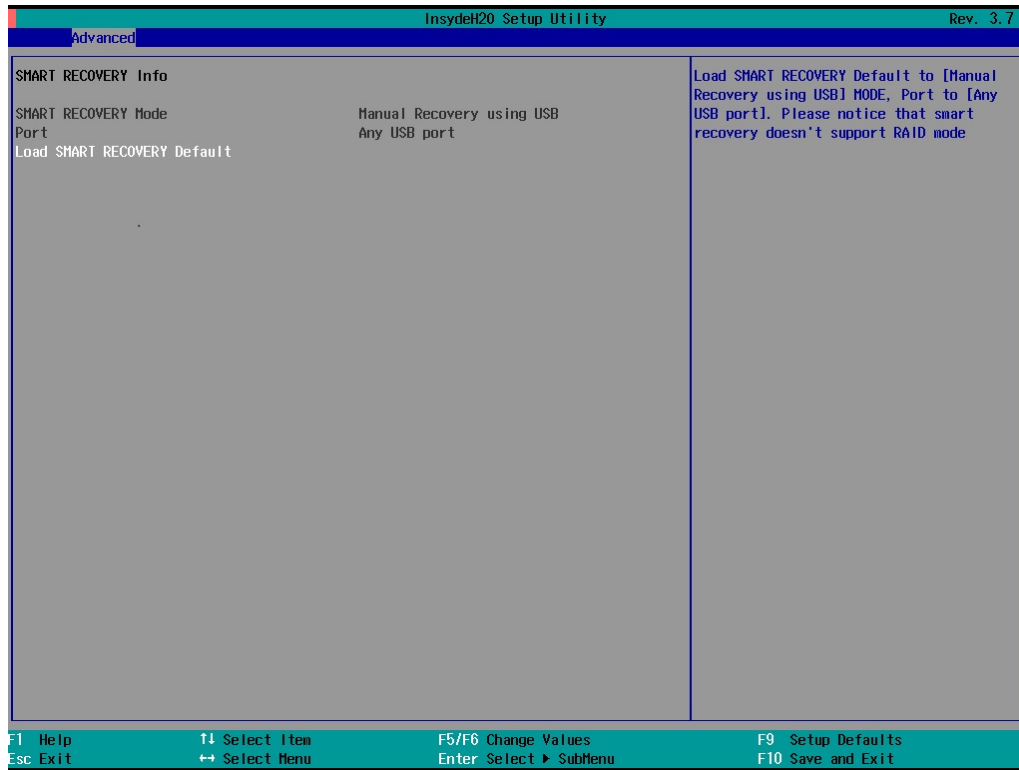

### Load SMART RECOVERY Default

This setting allows you to load the Smart Recovery default value. Refer to the Smart Recovery Website at <http://www.moxa.com/product/Smart-Recovery.htm> for details

Options: Yes (default), No

## Security Settings

This screen allows you to configure a supervisor password.

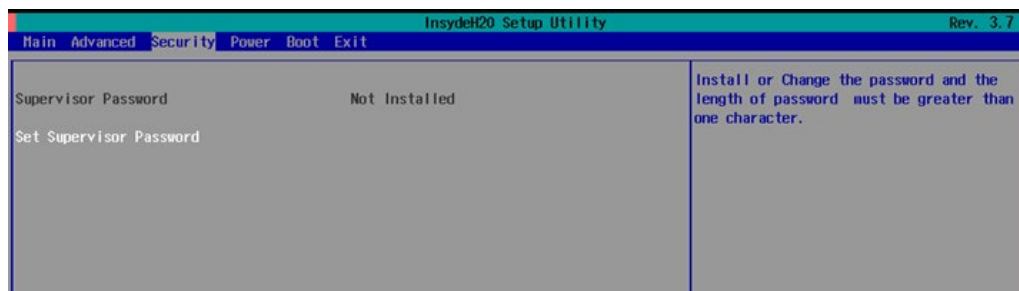

## Set Supervisor Password

This setting allows you set the supervisor password.

Type the new password, and then retype the password again to confirm.

To delete the password, enter the existing password in the **Set Supervisor Password** field and leave the new password fields blank; then, press [Enter].

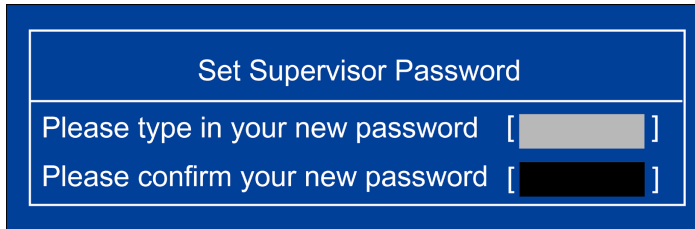

The screenshot shows a blue-bordered window titled "Set Supervisor Password". Inside, there are two input fields. The first field is labeled "Please type in your new password" and contains a greyed-out box. The second field is labeled "Please confirm your new password" and contains a blacked-out box.

## Power Settings

The screen allows you to configure power settings.



## Turbo Mode

This field is only for models with an Intel Core-i7 processor.

This field allows you to determine whether to enable the Intel CPU Turbo Boost technology.

Options: Enabled (default), Disabled.

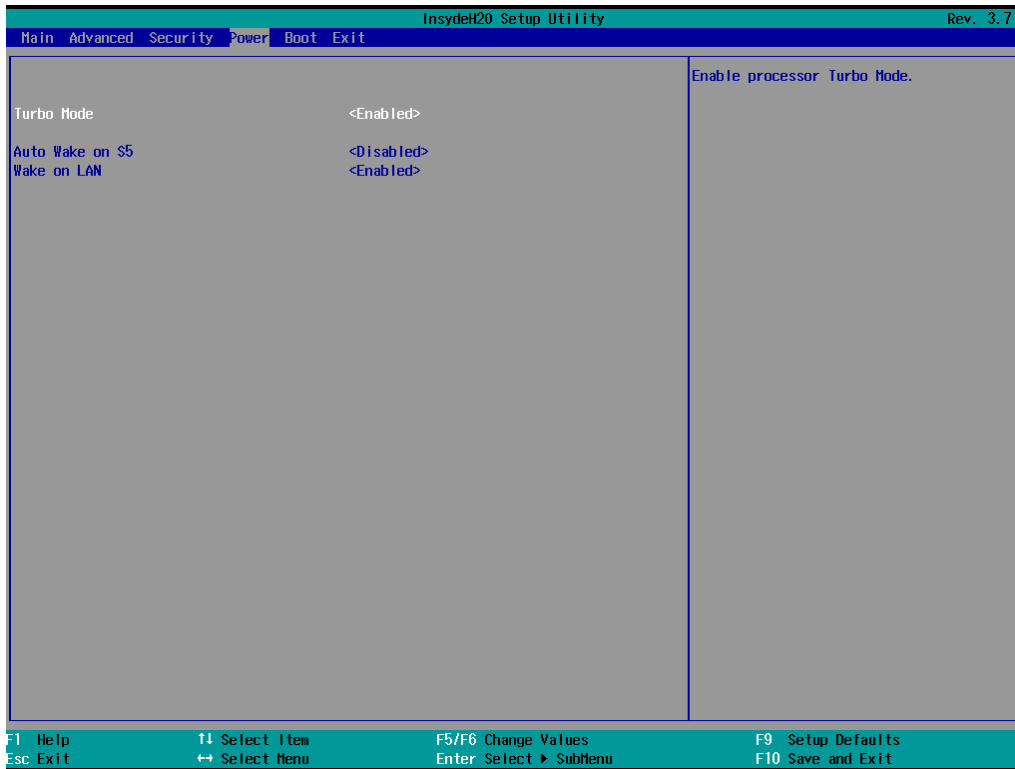

## Auto Wake on S5

This setting allows you to configure the computer to wake from the S5 (Soft Off) state where the power supply remains engaged but is not supplying power to all other parts of the system.

You can set the auto-wake on S5 schedules for the system to perform a soft-reboot at specific times.

Options: Disabled (default); By Every Day (user specifies at what time each day the computer will power up);

By Day of Month (user specifies which day of each month the computer will power up)

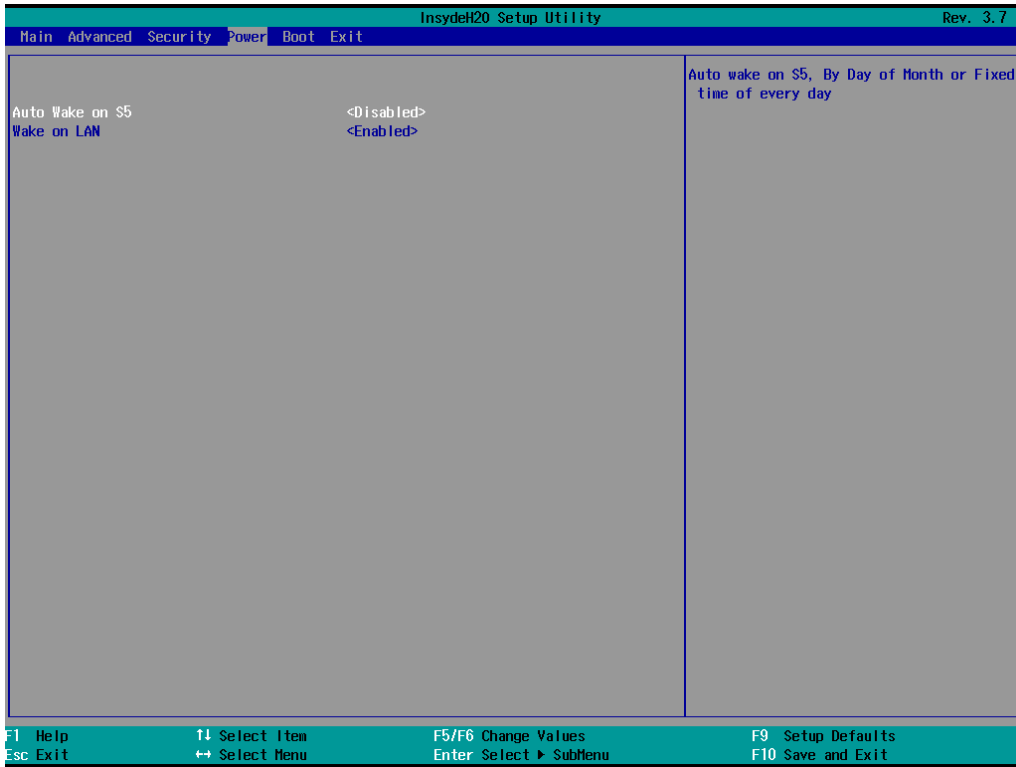

## Wake on LAN

This setting allows you to wake the system over the LAN from a remote host.

Options: Enabled (default), Disabled.

## Boot Settings

The screen allows you to configure boot settings.

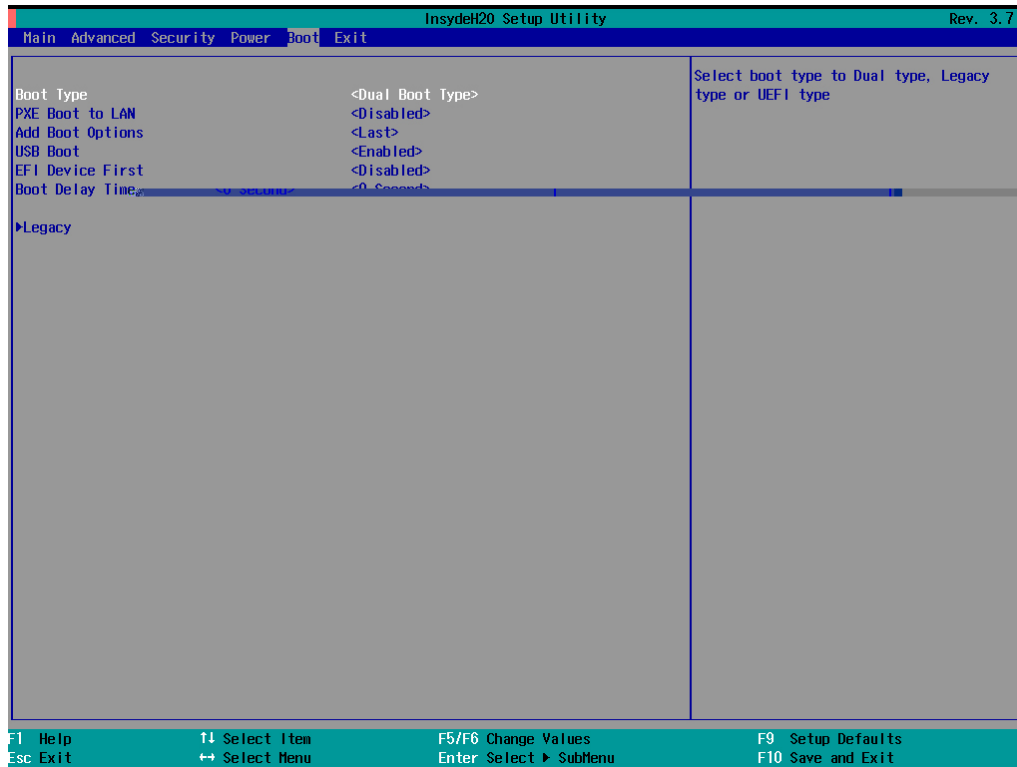

### Boot Type

This setting allows you to enable or disable the quick boot function.

Options: Dual Boot Type (default), Legacy Boot Type, UEFI Boot Type

### PXE Boot to LAN

This setting allows you to enable or disable the PXE boot to LAN function.

Options: Disabled (default), Enabled

### Add Boot Options

This setting allows you to add boot order options for new boot devices and removable devices, such as a USB drive.

Options: Last (default), First

## USB Boot

This setting allows you to enable or disable the USB boot function.

Options: Enabled (default), Disabled

## EFI Device First

This setting allows you to determine the booting priority of the EFI device. If this setting is enabled, the EFI device will boot first; if disabled, the legacy device will boot first.

Options: Disabled (default), Enabled

## Boot Delay Time

This setting allows you to configure the delay time to enter a hot key during POST.

Options: 0 Second (default), 3 Seconds, 5 Seconds, 10 Seconds

## Legacy

### Normal Boot Menu

This setting allows you to configure the boot menu.

Options: Normal (default), Advance

### Boot Type Order

This setting allows you to configure the boot order. To change the boot order, press the "-" or "F5" key to an item move down the list, and the "+" or "F6" key to move up.

Options: Hard Disk Drive (default), CD/DVD-ROM Drive, USB, Others

## Hard Disk Drive/USB Drive

This setting allows you to view the installed devices, such as hard disk drives, USB drives, and CD-ROMs. For example, if you have inserted a USB drive into the computer, the USB drive entry is listed here.

You can view and select the boot order for the same type of storage devices. For example, if you have two hard drives connected to the V2403, you can specify which of the two drives boots first, and which boots second.

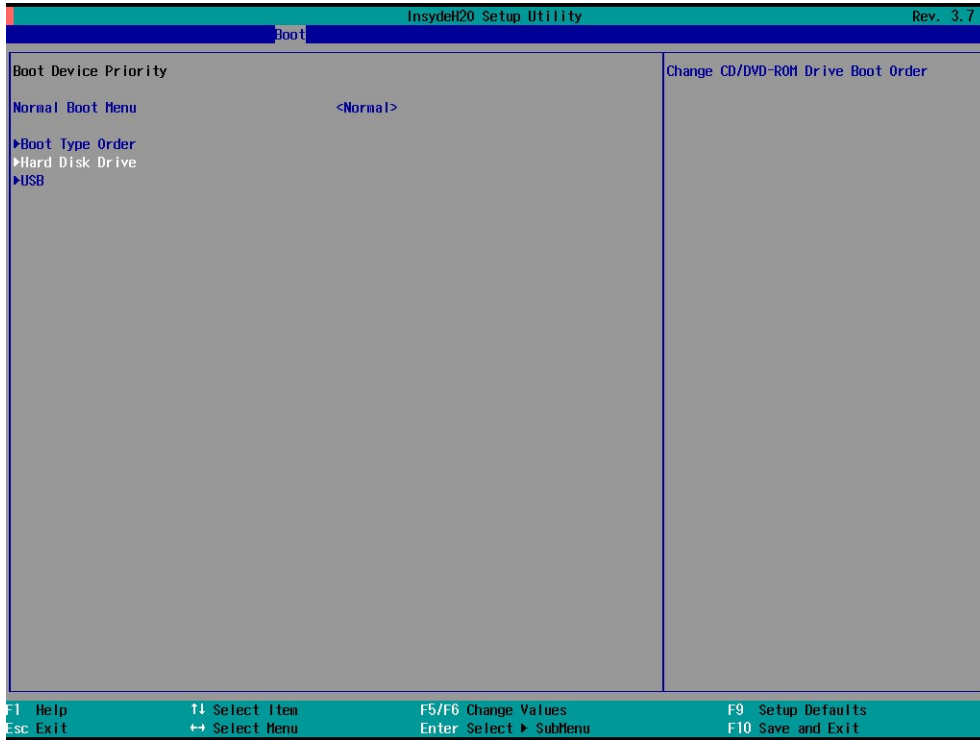

## Exit Settings

The screen shows the various options to exit from the BIOS setup utility.



## Exit Saving Changes

This option allows you to exit the BIOS setup utility and save the values you have just configured.

Options: Yes (default), No

## Save Change Without Exit

This option allows you to save changes without exiting the BIOS setup utility.

Options: Yes (default), No

## Exit Discarding Changes

This option allows you to exit without saving that changes that might have been made to the BIOS.

Options: Yes (default), No

## Load Optimal Defaults

This option allows you to revert to the factory default BIOS values.

Options: Yes (default), No

## Load Custom Defaults

This option allows you to load the custom default BIOS settings.

Options: Yes (default), No

## Save Custom Defaults

This option allows you to save the current BIOS settings as a "custom default" that you can load at any time using the "Load Custom Defaults" option.

Options: Yes (default), No

## Discard Changes

This option allows you to discard all settings you have just configured.

Options: Yes (default), No



# Upgrading the BIOS

This section describes how to upgrade the BIOS.



## WARNING

An improper BIOS upgrade process may permanently damage the computer. We strongly recommend that you contact Moxa technical support for assistance to obtain all the necessary tools and the most up-to-date advice before attempting to upgrade the BIOS on any Moxa device.

## Step 1: Create a Bootable USB Disk

Before upgrading the BIOS, every user should first create a bootable USB drive as a system rescue device.

A useful software suite for creating USB RAM drives can be found by searching for Rufus, which can then be downloaded and used to create a bootable RAM drive.

Complete the following steps to create a bootable USB disk using Rufus:

1. Start Rufus and then in the "Device" drop-down list select the USB device that you want to use as a bootable disk.
2. Select **MBR partition scheme for BIOS or UEFI computers** from the "Partition scheme and target system type" drop-down list so it can boot from a legacy BIOS or UEFI.
3. Select **FAT32 (Default)** from the "File system" drop-down list.
4. Select **4096 bytes (Default)** from the "Cluster size" drop-down list.
5. Enter a drive name in the "New volume label" input box.
6. Select the **Quick format, Create a bootable disk using FreeDOS, and Create extended label and icon files** options.
7. Click **Start** to format and create the bootable USB drive.

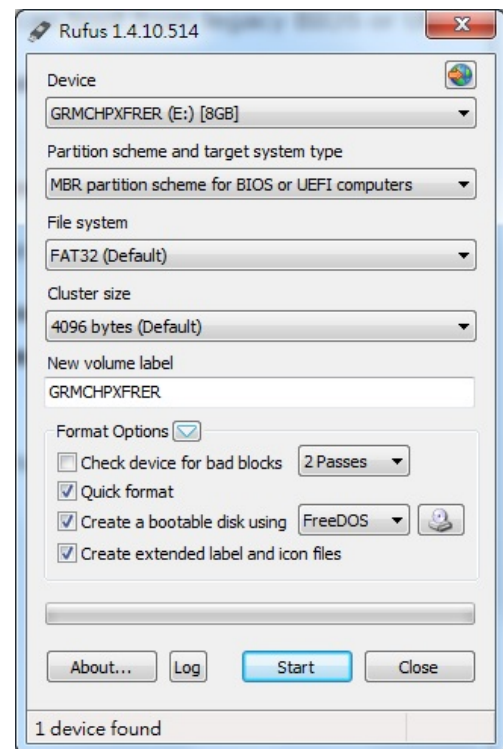

## ATTENTION

When you use a USB drive larger than 4 GB, you will need to convert the file system type to FAT32.

## Step 2: Prepare the Upgrade File

You must use the BIOS upgrade installation file to upgrade the BIOS. Contact Moxa technical support for assistance.

1. Get the BIOS upgrade installation file.  
The file name should be in the format: **24AxxSxx.exe** (where "xx" refers to the version numbers).
2. Copy the file to the bootable USB drive.

### Step 3: Run the Upgrade Program on the V2403 Computer

1. Reboot the computer, and press F2 during the booting process to display the Boot Manager.

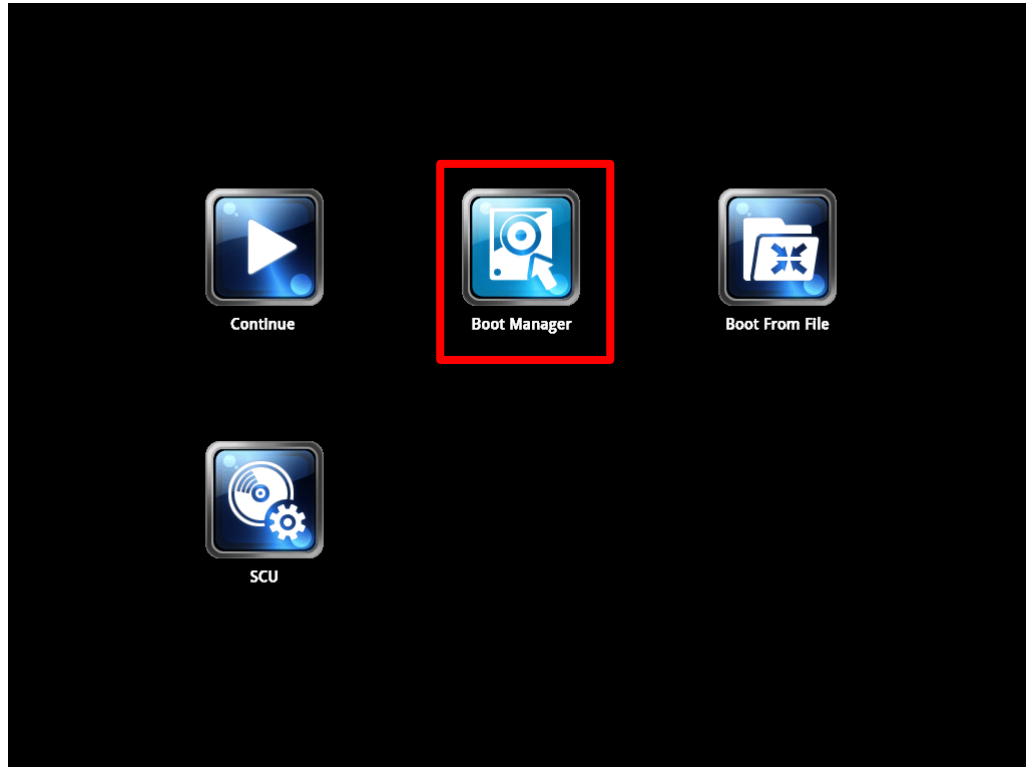

2. Select USB Disk as the first boot source and press [Enter] to continue.

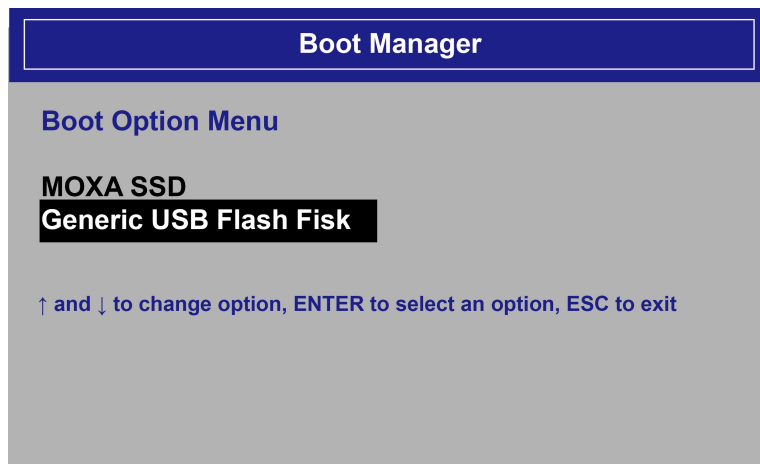

3. When the computer finishes booting up, a command window appears. Go to the directory where the upgrade file is located. For example, if the upgrade file is stored in the V2403 folder, type `cd v2403`.

```
C:\>cd v2403
```

4. Run the upgrade program by typing `24A12S01.exe`.

Note that the filename for the upgrade program may vary depending on the version.

```
C:\v2403> 24A12S01.exe
```

- The upgrade program will run automatically. Wait until the procedure is complete.

**ATTENTION**

Do NOT remove the power supply during a BIOS upgrade.

```
C:\>V2403\ 24A12S01.exe
Reading file...
Flash package mode.
Option: -BIOS -C -Desc -ME

Please do not remove the AC power!

Insyde Flash Utility for InsydeH20
                                Version 1.5t

        Initializing

        Current BIOS Model name: V2403
        New BIOS Model name: V2403

        Current BIOS version: V1.20S01
        New BIOS version: V1.20S01

        Updating Block at FFFFF000
        Flash Complete!
```

- When the upgrade is finished, the computer automatically reboots. You may check the BIOS version on the Main page of the BIOS setup utility.

MODEL NAME	V2403
BIOS Version	V1.20S01

# A

## Regulatory Approval Statement

---



This device complies with part 15 of the FCC Rules. Operation is subject to the following two conditions: (1) This device may not cause harmful interference, and (2) this device must accept any interference received, including interference that may cause undesired operation.

**Class A:** FCC Warning! This equipment has been tested and found to comply with the limits for a Class A digital device, pursuant to part 15 of the FCC Rules. These limits are designed to provide reasonable protection against harmful interference when the equipment is operated in a commercial environment. This equipment generates, uses, and can radiate radio frequency energy and, if not installed and used in accordance with the instruction manual, may cause harmful interference to radio communications. Operation of this equipment in a residential area is likely to cause harmful interference in which case the user will be required to correct the interference at his or her own expense.



**European Community**

**Warning:**

This is a class A product. If used in a domestic environment, this product may cause undesirable radio interference, in which case the user may be required to take adequate measures to prevent the interference from affecting nearby devices.