

# V2403 Series Windows Software User's Manual

---

Edition 1.0, December 2015

[www.moxa.com/product](http://www.moxa.com/product)

**MOXA**<sup>®</sup>

© 2015 Moxa Inc. All rights reserved.

# V2403 Series Windows Software User's Manual

The software described in this manual is furnished under a license agreement and may be used only in accordance with the terms of that agreement.

## Copyright Notice

© 2015 Moxa Inc. All rights reserved.

## Trademarks

The MOXA logo is a registered trademark of Moxa Inc.  
All other trademarks or registered marks in this manual belong to their respective manufacturers.

## Disclaimer

Information in this document is subject to change without notice and does not represent a commitment on the part of Moxa.

Moxa provides this document as is, without warranty of any kind, either expressed or implied, including, but not limited to, its particular purpose. Moxa reserves the right to make improvements and/or changes to this manual, or to the products and/or the programs described in this manual, at any time.

Information provided in this manual is intended to be accurate and reliable. However, Moxa assumes no responsibility for its use, or for any infringements on the rights of third parties that may result from its use.

This product might include unintentional technical or typographical errors. Changes are periodically made to the information herein to correct such errors, and these changes are incorporated into new editions of the publication.

## Technical Support Contact Information

[www.moxa.com/support](http://www.moxa.com/support)

### Moxa Americas

Toll-free: 1-888-669-2872  
Tel: +1-714-528-6777  
Fax: +1-714-528-6778

### Moxa Europe

Tel: +49-89-3 70 03 99-0  
Fax: +49-89-3 70 03 99-99

### Moxa India

Tel: +91-80-4172-9088  
Fax: +91-80-4132-1045

### Moxa China (Shanghai office)

Toll-free: 800-820-5036  
Tel: +86-21-5258-9955  
Fax: +86-21-5258-5505

### Moxa Asia-Pacific

Tel: +886-2-8919-1230  
Fax: +886-2-8919-1231

# Table of Contents

<b>1. Introduction</b> .....	<b>1-1</b>
Software Components .....	1-2
<b>2. System Initialization</b> .....	<b>2-1</b>
Overview .....	2-2
Initializing User Settings.....	2-2
<b>3. Configuring the Serial Interface</b> .....	<b>3-1</b>
Configuring the Serial Interface Mode.....	3-2
Changing a Beginning COM Number.....	3-4
<b>4. Enabling Embedded Filters</b> .....	<b>4-1</b>
Enhanced Write Filter .....	4-2
Overview.....	4-2
Enabling Enhanced Write Filter.....	4-3
Committing Data and/or Disabling EWF.....	4-5
File-Based Write Filter .....	4-7
Configuring File-Based Write Filter.....	4-7
Excluding Files from FBWF Protection.....	4-9
Managing Temporary Files Cached in the Overlay .....	4-10
<b>5. Examples</b> .....	<b>5-1</b>
Serial Interface .....	5-2
Digital Input/Output.....	5-3
Watchdog .....	5-5
Power Control .....	5-5
Power Reset.....	5-7
<b>6. Module Card</b> .....	<b>6-1</b>
Overview .....	6-2
Installing the Cellular Module Driver for the MC-9090, MC-7304, MC-7354.....	6-2
Installing the Cellular Module Dial Utility.....	6-4
Cellular Module Configuration.....	6-6
Installing the WPEA-252NI's WiFi Module Driver .....	6-7
WiFi Module Configuration .....	6-9
Choosing the Gateway when WiFi and Cellular are Connected at the Same Time.....	6-11
<b>7. System Recovery</b> .....	<b>7-1</b>
Overview .....	7-2
Setting Up the Recovery Environment .....	7-2
Recovery Procedure .....	7-2
Saving the System Image to the USB Drive .....	7-10
<b>8. Proactive Monitoring</b> .....	<b>8-1</b>

# Introduction

---

Thank you for purchasing a Moxa V2403 panel computer running the Windows 7 Embedded operating system. The Windows 7 Embedded OS provides a simple and familiar development environment for a variety of industrial applications.

## □ Software Components

# Software Components

The following software components of the Windows Embedded Standard 7 OS come pre-installed on the V2403 computer.

## Windows Embedded Standard 7

### Core OS:

- 64-bit supported
- Remote Client
- Remote Procedure Call

### Applications and Services Development:

- Remote Desktop Protocol 7.1
- COM OLE Application Support
- COM+ Application Support
- MSMQ

### Internet Services:

- Internet Explorer 8
- IIS 7.0

### File Systems and Data Storage:

- Windows Data Access Components
- Windows Backup and Restore

### Diagnostics:

- Common Diagnostic Tools
- Problem Reports and Solutions

**Fonts:** Western, Middle Eastern, South East Asian, and South Asian Fonts

### Graphics and Multimedia:

- MPEG Layer-3 Audio Codecs (MP3)
- MPEG4 Decoders
- DirectX and Windows Device Experience

### Management:

- Group Policy Management
- Windows Management Instrument (WMI)
- Windows Update

### Networking:

- Extensible Authentication Protocol (EAP)
- Internet Authentication Service
- Telnet Server
- Bluetooth
- Domain Services
- Network Access Protection
- Network and Sharing Center
- Quality of Service
- Remote Access Service (RAS)
- Telephony API Client
- Windows Firewall
- Wireless Networking

### Security:

- Credential Roaming Service
- Credentials and Certificate Management
- Windows Authorization Manager (AZMAN)
- Windows Security Center
- Active Directory Rights Management
- Security Base
- Encrypted File System (EFS)

**Embedded Features:**

- Enhanced Write Filter (EWF)
- File-Based Write Filter (FBWF)
- Registry Filter
- WSDAPI for .NET

**Embedded Self-Health Diagnostic Software:** Moxa Proactive Monitoring & Moxa Smart Recovery

# System Initialization

---

In this chapter, we describe how to initialize the system settings on the V2403 embedded computer when booting up for the first time.

The following topic is covered in this chapter:

- **Overview**
- **Initializing User Settings**

## Overview

Similar to using a laptop computer for the first time, you need to specify a user name and create a user account to start using the V2403 embedded computer. Follow the procedure described in the next section.

**NOTE** If you perform a system recovery on the V2403 embedded computer, the system automatically resets to the factory defaults. You must initialize the user settings again.

## Initializing User Settings

1. When you turn on the embedded computer for the first time, enter a user name for the computer.

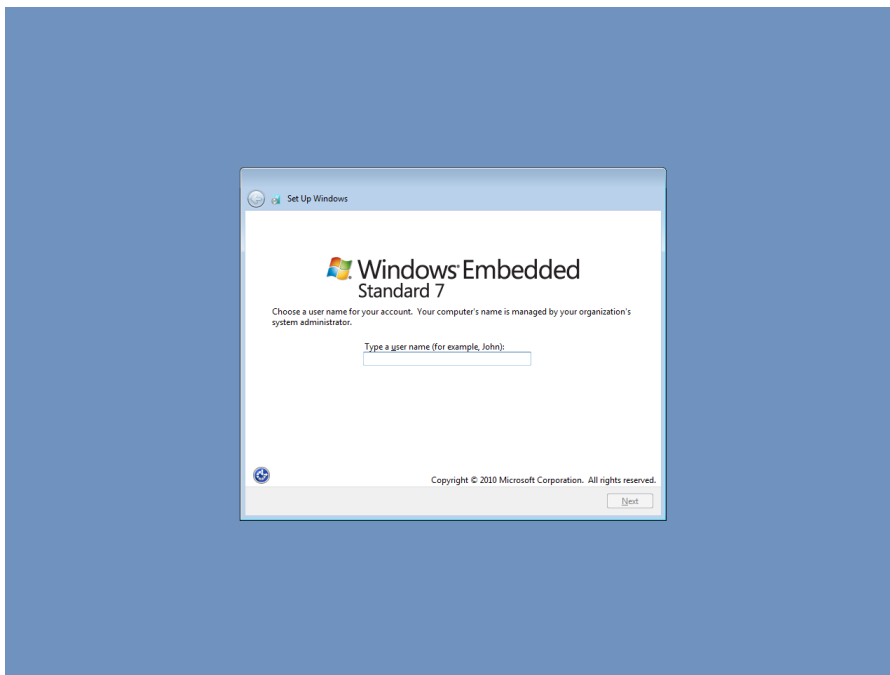



2. Type a password and retype the password to confirm.

You may also type a password hint that you can refer to if you forget your password. If you do not want to set a password, leave all three fields blank. Click **Next** to continue.

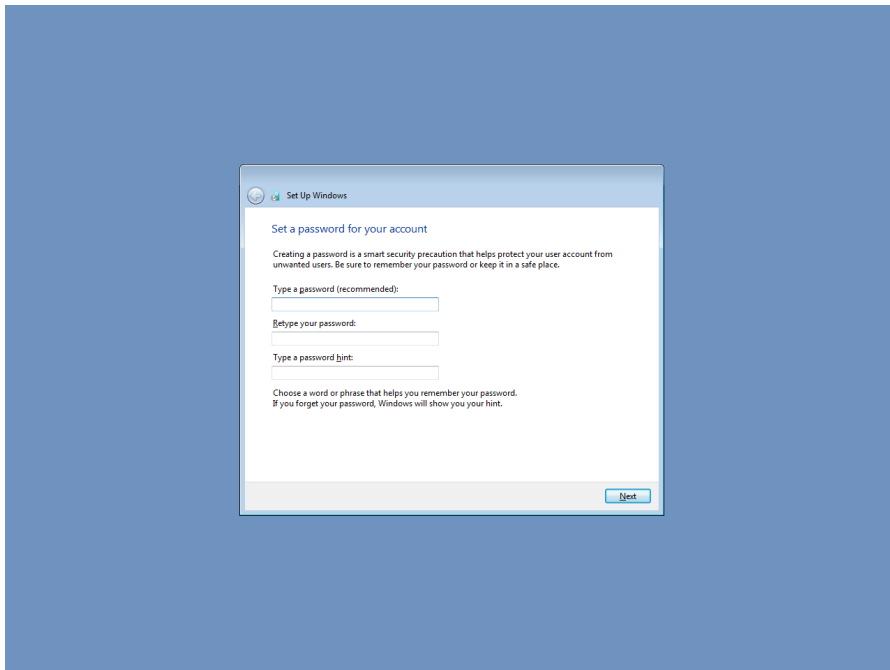

3. Select a Windows update option.

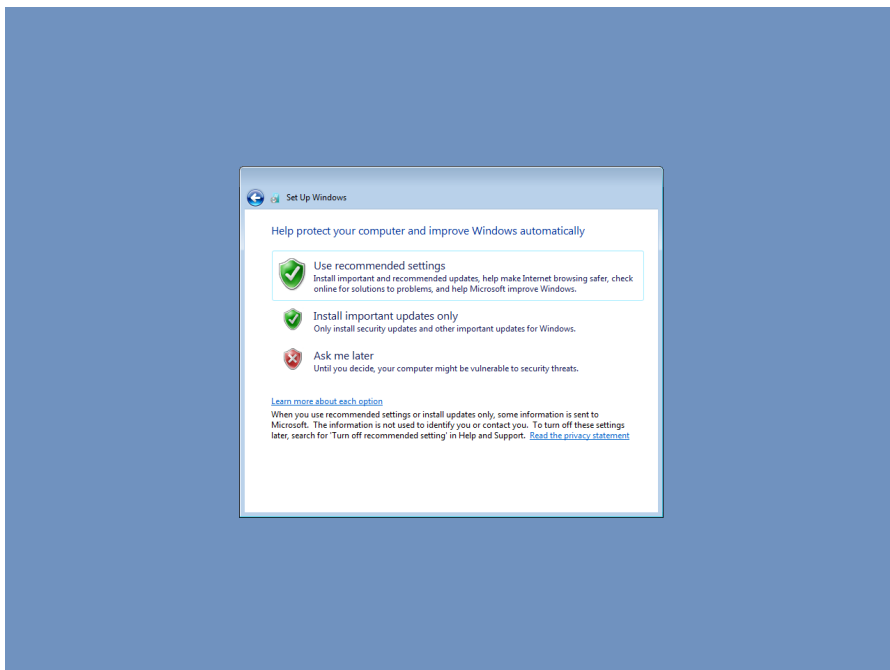

- 4. Select the computer's current location, and review the time and date settings.

Windows automatically applies the appropriate network settings based on the type of network you select.

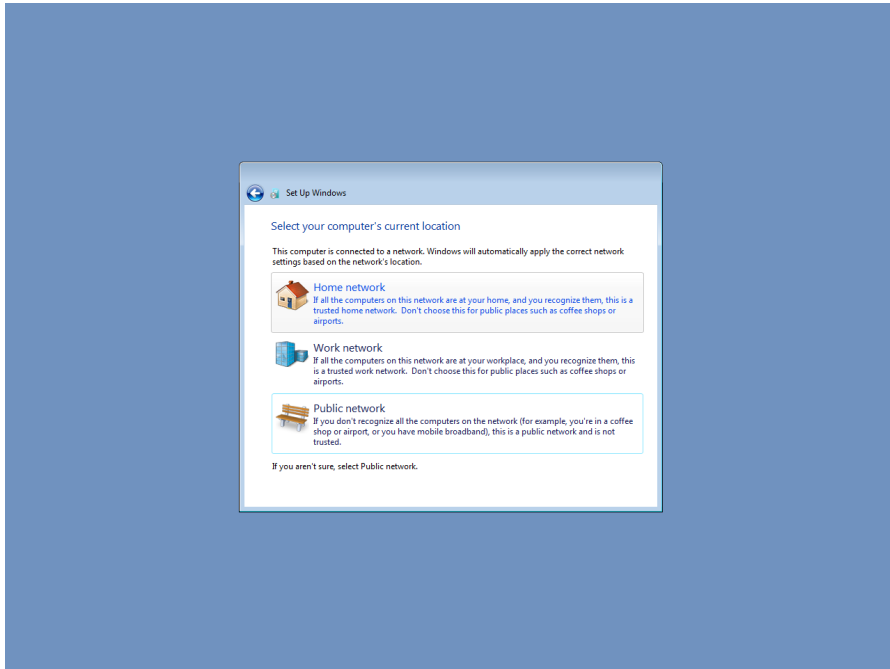

- 5. When the Windows desktop screen appears, you can start using your V2403 embedded computer.



## Configuring the Serial Interface

---

This chapter describes how to configure the serial interface on the V2403 embedded computer.

The following topics are covered in this chapter:

- ❑ **Configuring the Serial Interface Mode**
- ❑ **Changing a Beginning COM Number**

# Configuring the Serial Interface Mode

Complete the following steps to configure the serial interface mode:

1. From the Start menu, right click **Computer** → **Manage**.

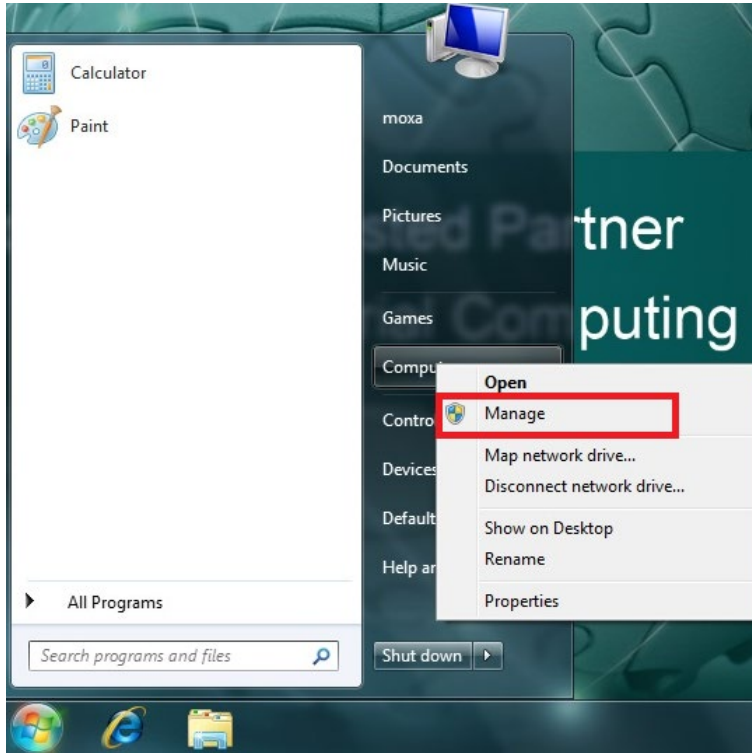

2. In Computer Management, select **Device Manager**, expand **Multi-port serial adapters**, right click the port for which you would like to set the mode, and then click **properties**.

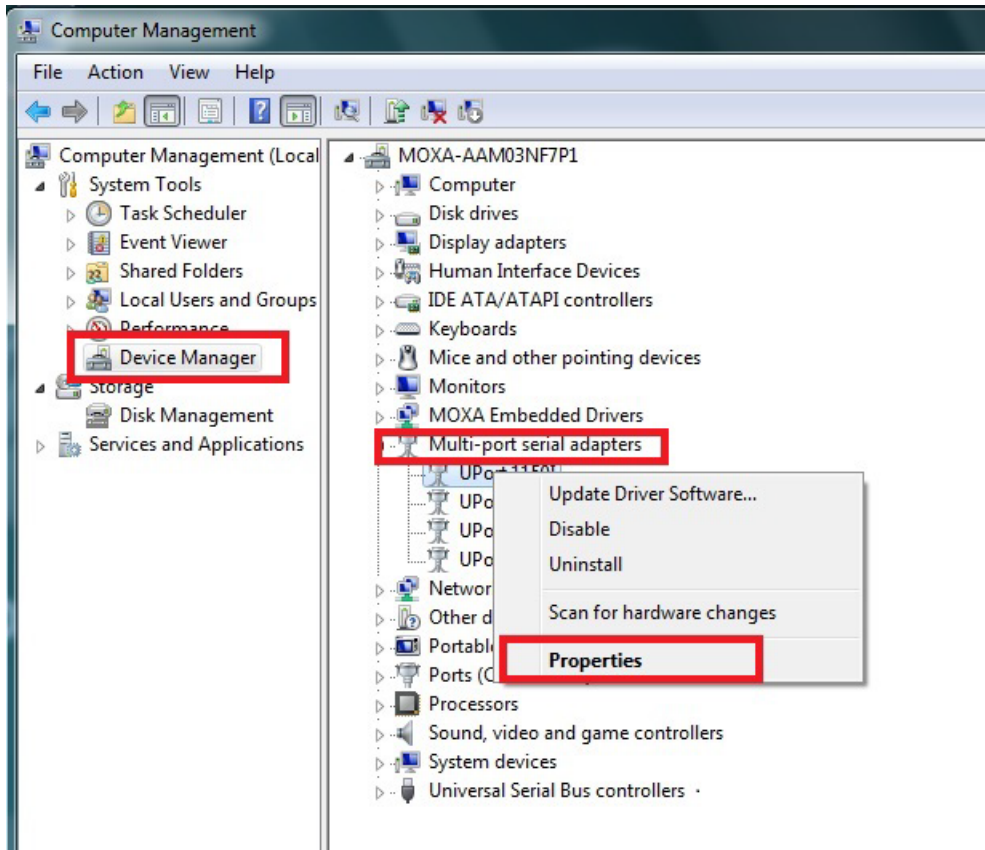

3. Select the **Ports Configuration** folder, and then click **Port Setting**.

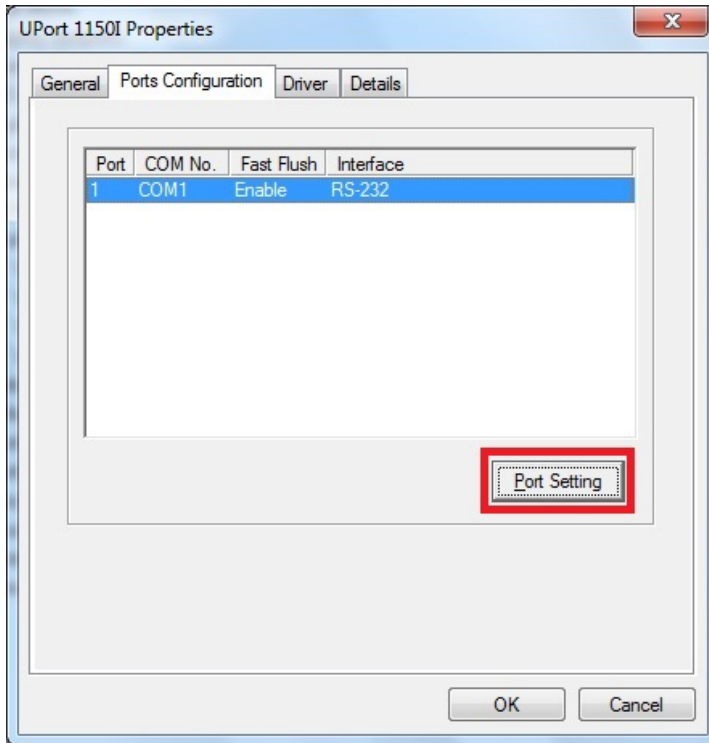

4. Check the Port number and select the mode you want to set. Click **OK** to complete the UART mode setting.

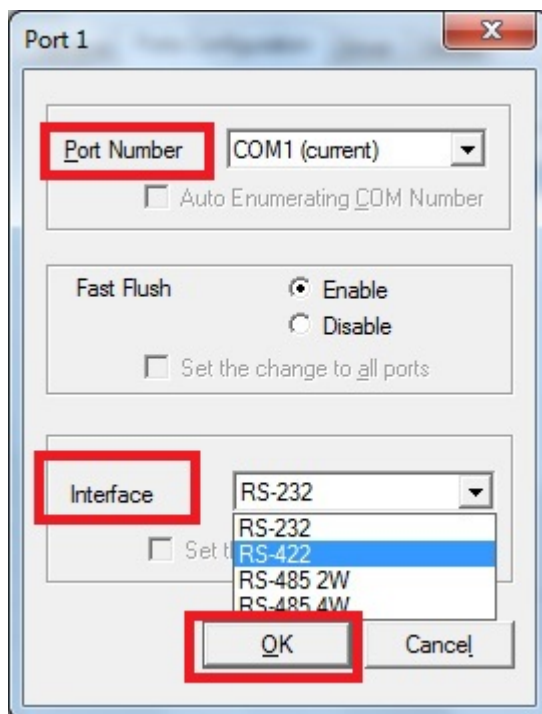

## Changing a Beginning COM Number

Complete the following steps to change a beginning COM number:

1. Open the **Start** menu, and then under **MOXA UPort 1100 Series Windows Driver** click **UPort 1100 Series Configuration Utility**.

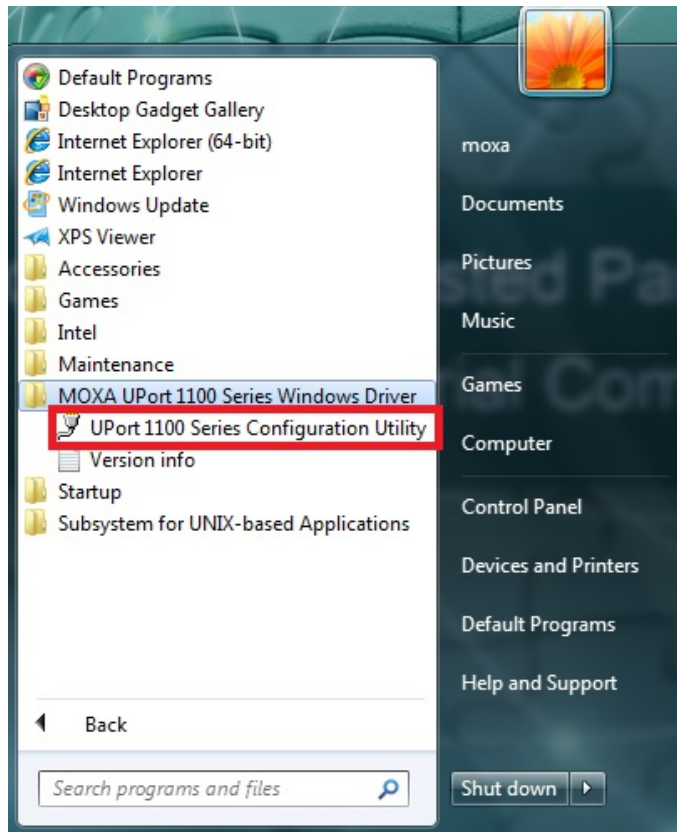

2. Click **View Settings**.

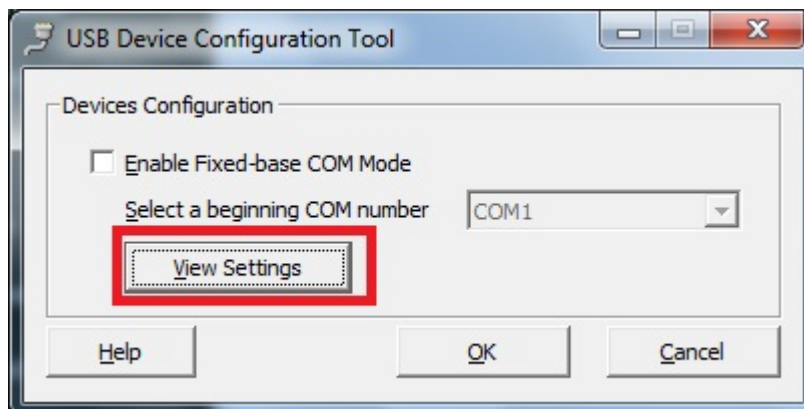

3. In **View Settings**, you can check which ports Windows is using for a **MOXA Serial port**; click **OK** to exit.

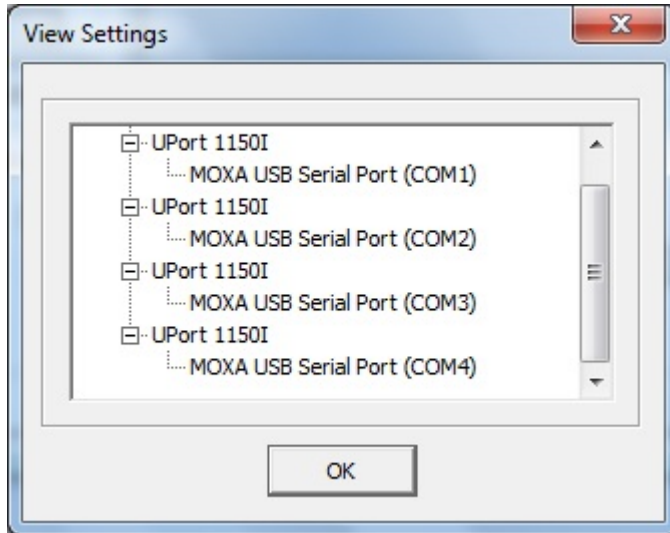

4. Select the **Enable Fixed-base COM Mode** checkbox, select a beginning COM number, and then click **OK** to complete the setting.

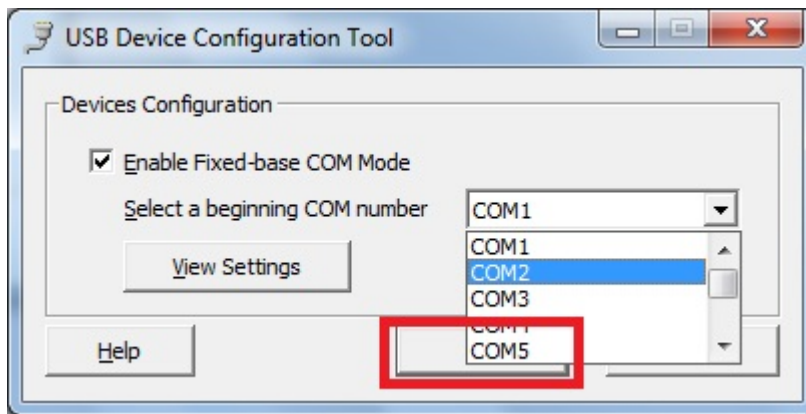

5. Click **View Settings** again to check that the beginning COM number was changed, and then click **OK** to exit.

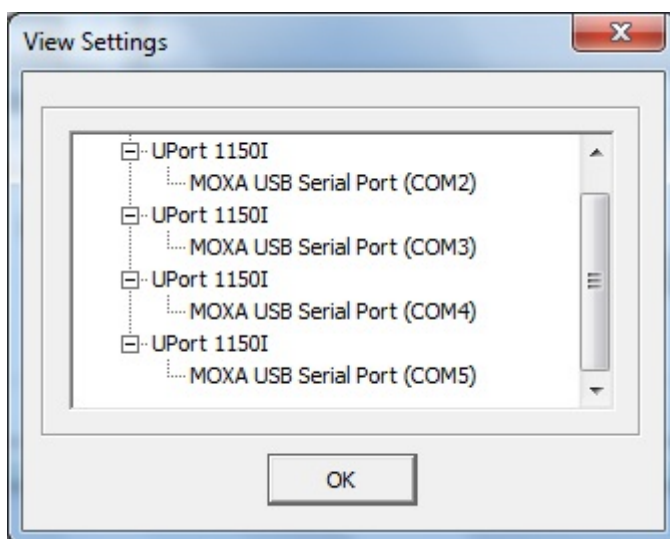

# Enabling Embedded Filters

---

In this chapter, we describe how to enable the V2403's embedded filters.

The following topics are covered in this chapter:

## ❑ **Enhanced Write Filter**

- Overview
- Enabling Enhanced Write Filter
- Committing Data and/or Disabling EWF

## ❑ **File-Based Write Filter**

- Configuring File-Based Write Filter
- Excluding Files from FBWF Protection
- Managing Temporary Files Cached in the Overlay



# Enhanced Write Filter

## Overview

Enhanced Write Filter (EWF) enables you to protect a volume from unauthorized writes by making the main operating system (OS) drive a write-protected volume, effectively making the system a read-only system for most users. This provides much stronger protection against malicious computer attacks (such as trojans, worms, and viruses).

Enhanced Write Filter (EWF) allows Windows 7 users to protect data on their storage drive from permanent changes of any sort, at the lowest level of hardware protection available: the bit level. **EWF** allows the OS to boot from the hard disk, but protects the system by creating a virtual file system called an **overlay**. All writes to a EWF-protected volume (the **hard disk** in the following figure) are only recorded on this virtual overlay (the **EWF Volume** in the following figure), which is stored independently in random access memory (RAM).

Because EWF does not write data directly to the hard disk but instead only records system writes to this virtual RAM overlay, any data that is “written” during system operation will disappear upon the next re-boot. This approach allows the system to operate as if it is writeable when in reality all OS and user-space file systems are stored in a permanent, read-only state.

If required, data written to the overlay can be committed to the protected volume, but this requires additional setup and permissions that can only be granted by the administrator.

The following figure shows an overview of the EWF structure.

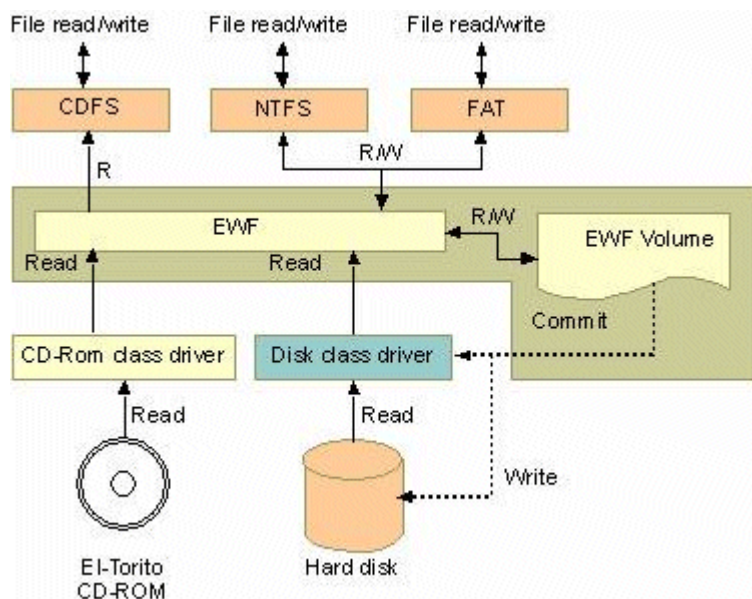

For more detailed information about EWF configuration and usage, refer to the following resources:

- Visit Microsoft's [EWF Volume Configuration](#) help pages.
- See Microsoft's [EWF overview](#) on the official Microsoft EWF help pages.
- See Microsoft's detailed description of [EWF modes](#) on the EWF help pages.
- See Microsoft's detailed description of the [EWF API](#).
- For EWF commands, refer to the MSDN web site:  
<http://msdn.microsoft.com/en-us/library/ms940853%28v=winembedded.5%29.aspx>

## Enabling Enhanced Write Filter

Follow these steps to enable Enhanced Write Filter:

1. To open EWF, double-click the padlock icon in the system tray.  
You may need to show hidden icons in the system tray.

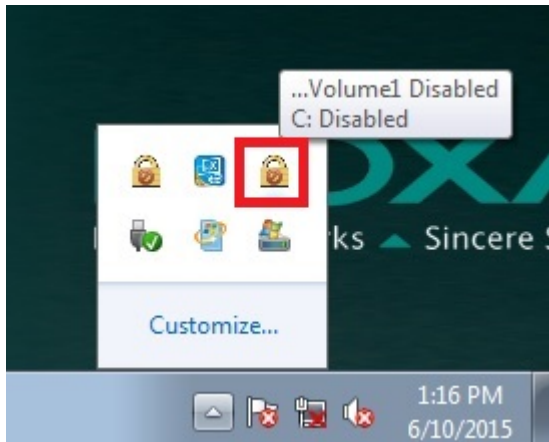

2. In the **Volume Information** area, select the partition you want to enable write-protection on and click **Configure...**

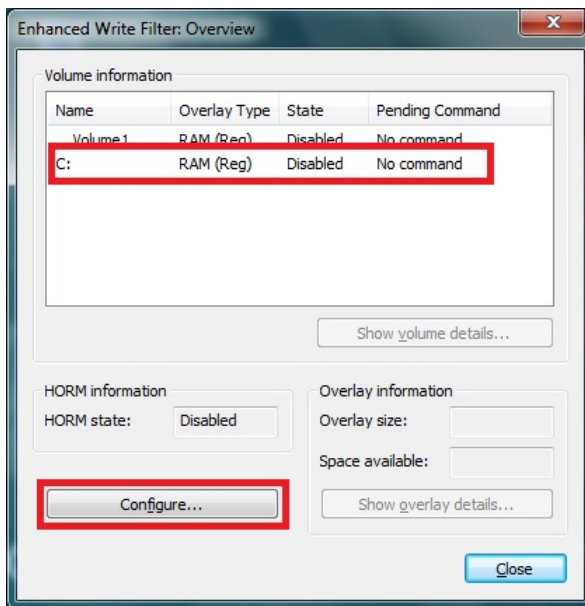

- The Configuration dialog box appears. Select **Enable** from the **Pending command** drop-down list and click **OK**.

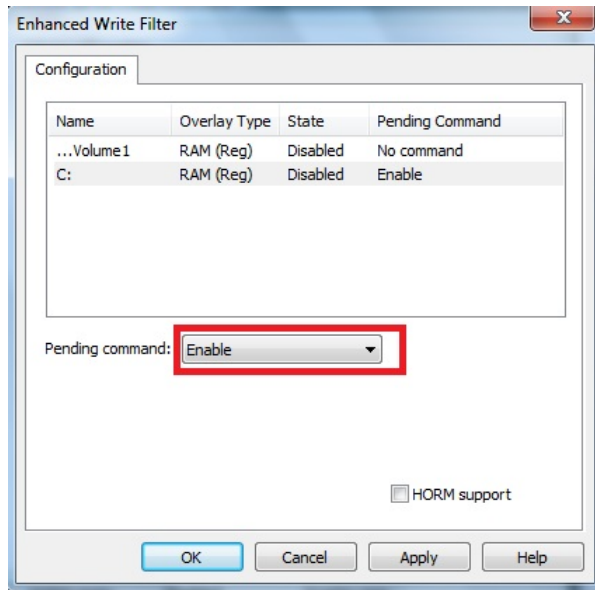

- Reboot the system.
- Log into the system and verify that the padlock icon in the system tray indicates that the drive volume is locked with EWF.

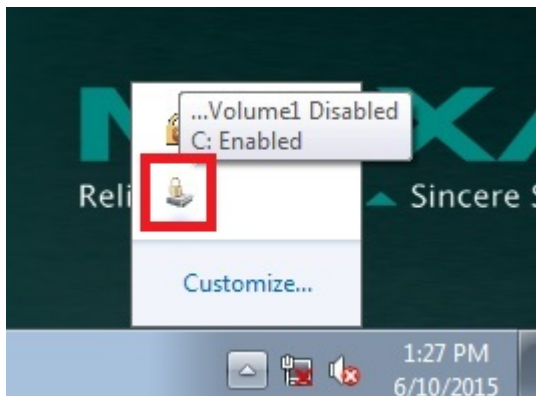

## Committing Data and/or Disabling EWF

Perform the following steps to write (or commit) data to a EWF-enabled drive.

**NOTE** You must have administrator privileges to commit data to the drive.

1. Double-click the padlocked drive in the system tray.  
You may need to show hidden icons in the system tray.

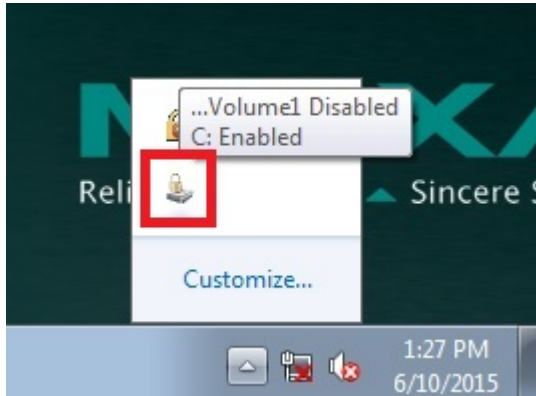

2. In the **Enhanced Write Filter: Overview** dialog box, select the drive you want to configure and click **Configure**.

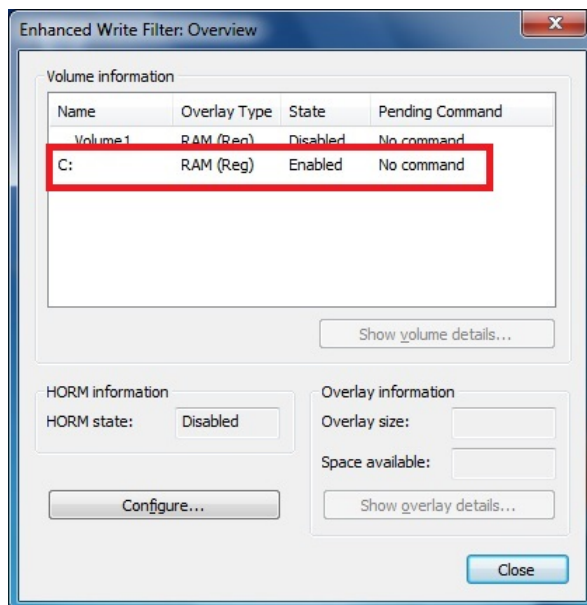

3. In the Enhanced Write Filter Configuration screen, select a drive volume; then, select an option from the **Pending Command** drop-down list:
  - **No Command**
  - **Disable:** Disables EWF on the selected drive. Select the “commit” checkbox and reboot the system for the changes to take effect.
  - **Commit:** Writes all current system changes to the hard drive.

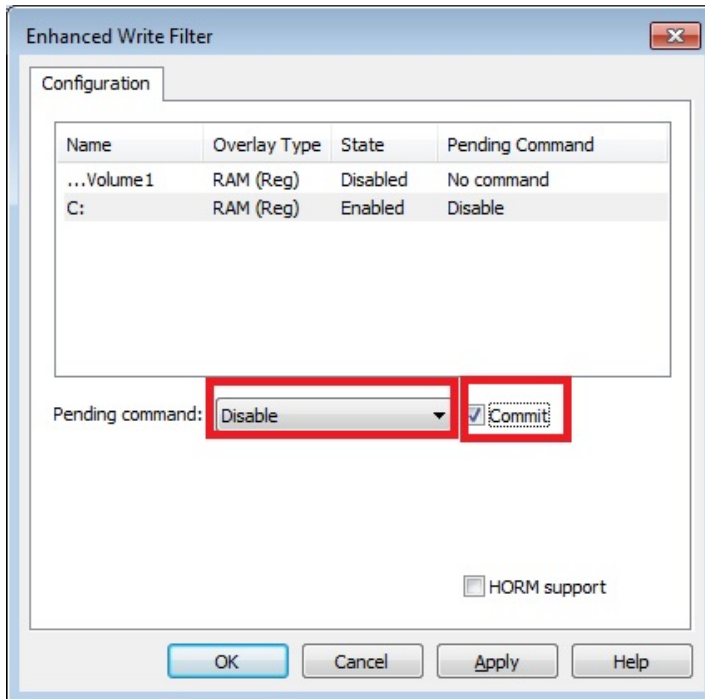

- **Commit and Disable Live:** Writes all current data and changes to the system, and also turns off EWF on the selected drive (so that all future data and system changes will also be committed to the drive). The system does not automatically reboot if you select this option.

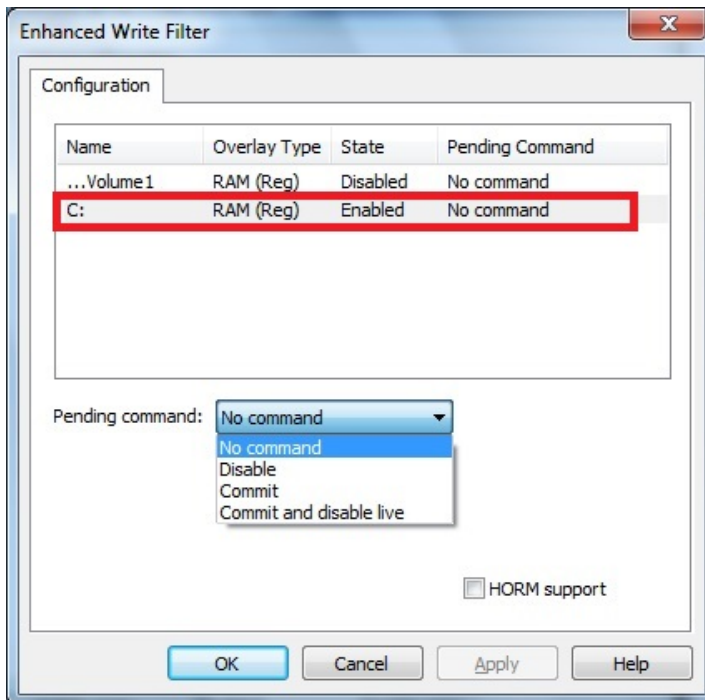

**NOTE** For detailed information, go to the Microsoft website at [http://msdn.microsoft.com/en-us/library/ff794092\(v=winembedded.60\).aspx](http://msdn.microsoft.com/en-us/library/ff794092(v=winembedded.60).aspx).

## File-Based Write Filter

This section describes how to use the File-Based Writer Filter (FBWF). Note that when Enhanced Writer Filter is enabled, the File-Based Writer Filter function will not work.

According to Microsoft:

“File-Based Write Filter (FBWF) allows the Windows Embedded platform to maintain the appearance of read and write access on write-sensitive or read-only storage. FBWF makes read and write access transparent to applications.

Writing to storage media may be undesirable or impossible in embedded devices. FBWF redirects all writes targeted for protected volumes to a RAM cache called an overlay. Used in this context, an overlay is similar to a transparency overlay on an overhead projector. Any change made to the overlay affects the picture as seen in the aggregate, but if the overlay is removed, the underlying picture remains unchanged.”

FBWF supports an advanced ESF feature, which allows users to specify which directory to write data to. The default directory is c:\temp. The advanced feature allows you can read/write data to disk without committing an action.

## Configuring File-Based Write Filter

Complete the following steps to enable the File-Based Write Filter (FBWF) feature. Although you can enable FBWF and EWF on the same computer, FBWF does not protect a volume that is already protected by EWF. Similarly, EWF does not protect a volume that is already protected by FBWF.

**NOTE** Before using FBWF, make sure that you disable EWF.

1. Double-click the padlock icon in the system tray.  
You may need to show hidden icons in the system tray.

**NOTE** When disabled, the EWF and FBWF icons in the system tray look the same. To verify that you have opened the correct writer filter program, check the screen title.



2. In the **File Based Writer Filter: Overview** screen, click **Configure**.

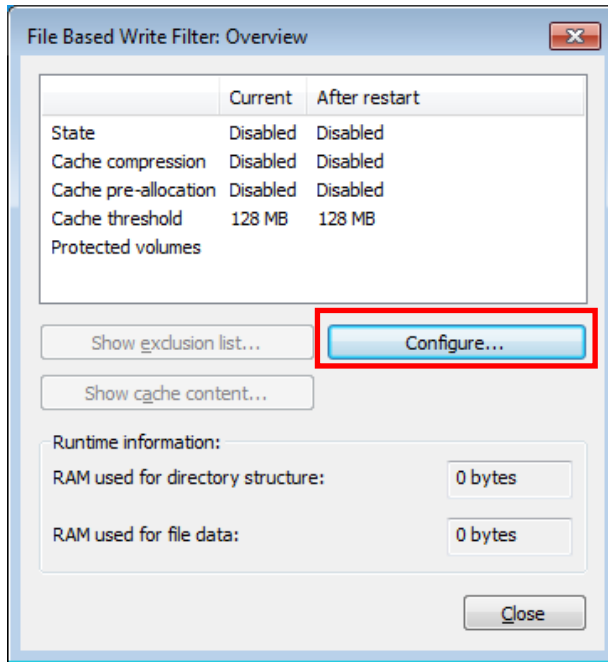

3. To enable FBWF protection on a storage drive, perform the following actions:
  - a. Select **Filter state enabled** and **Cache pre-allocation enabled**.
  - b. In the **Volume Configuration** area, select the storage drive you want to protect and click **Protect**.
  - c. Click **Apply** or **OK**.

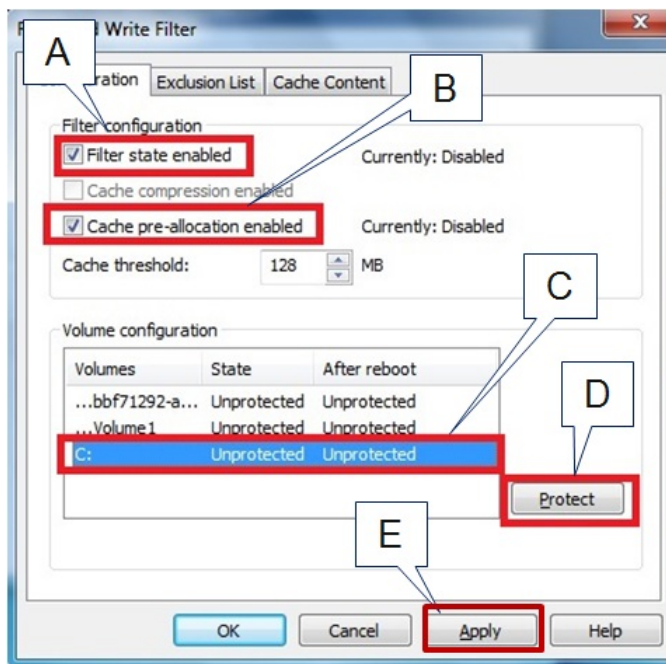

**NOTE** To minimize memory usage on the overlay cache, select **Cache compression enabled**. However, cache compression decreases performance when accessing protected volumes. Select **Cache pre-allocation enable** to set the memory space available for the overlay cache when the system starts up, instead of adjusting it as needed. You cannot enable cache pre-allocation and cache compression at the same time. The **cache threshold** field sets the amount of memory that can be used by the write filter for the overlay cache. The default value and size limits for the overlay cache vary depending on the operating system.

4. Reboot the system.
5. Log into the system and verify that the padlock icon in the system tray displays a number and indicates that FBWF is enabled on a drive. The following figure shows an example.

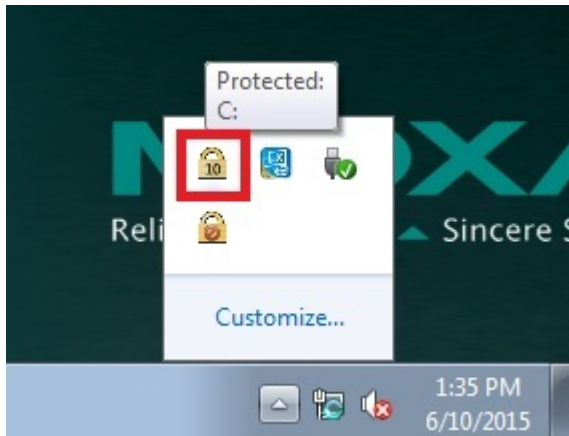

## Excluding Files from FBWF Protection

1. Double-click the FBWF icon in the system tray.  
You may need to show hidden icons in the system tray.
2. In the **File Based Write Filter: Overview** window, click **Configure**.

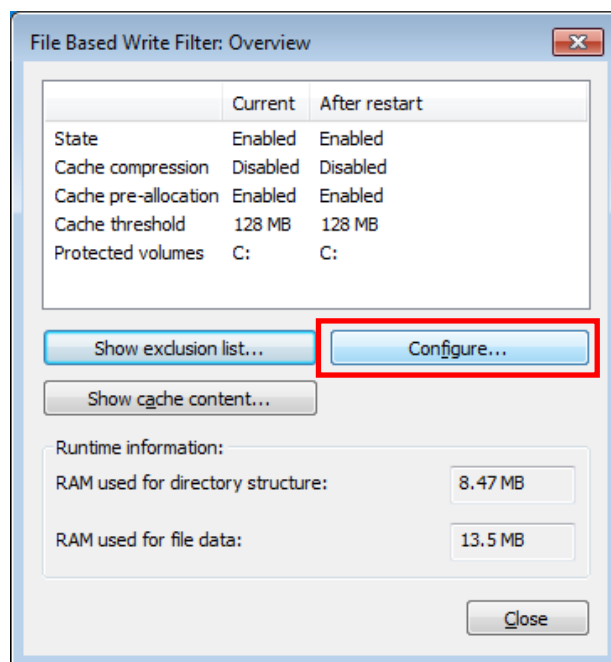



- Click the **Exclusion List** tab and configure the following fields:
  - Volume name** – Select a drive volume from the drop-down list.
  - Add path** – click the ellipsis (...) button to select a directory or file you want to exclude from FBWF protection; then click the + button. The system displays the selected directory or file in the **Path** table.

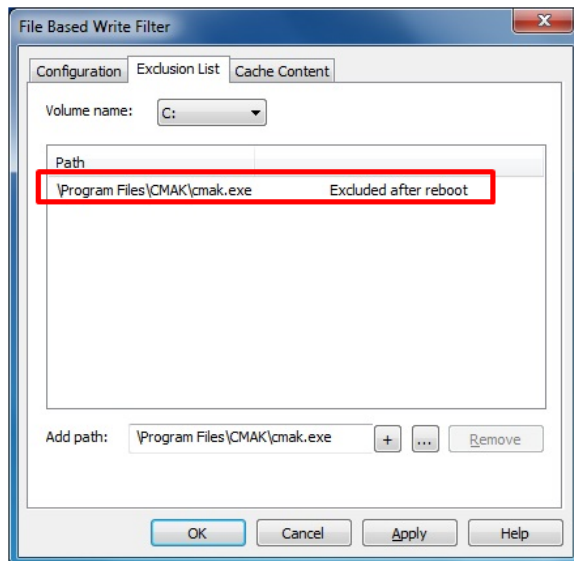

- Click the **Cache Content** tab and click **Apply** and **OK**

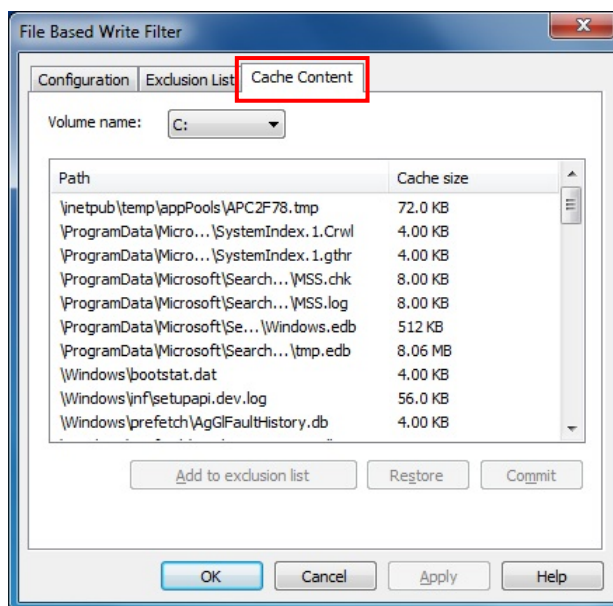

- Reboot the system to make the changes take effect.

## Managing Temporary Files Cached in the Overlay

- On the **Cached Content** tab, you will see all the files currently cached in the RAM overlay. Three commands are available:
  - Commit**: Save a file from the cache to permanent storage, delete the file from the overlay, and overwrite the original file.
  - Restore**: Return the file to its original state, remove the file from the overlay cache and discard the changes that added the file to the cache.

- **Add to exclusion list:** Adds the file to the exclusion list after the next restart. This will delete the file from the cached overlay and replace the current file in permanent storage with the modified cache file.

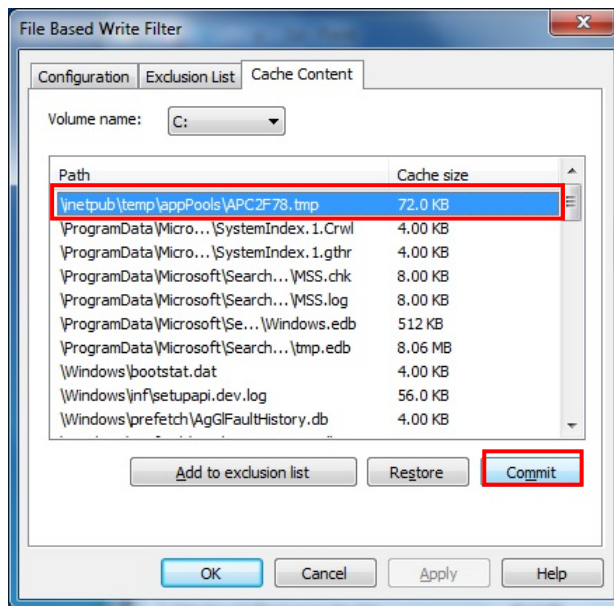

The most common usage of the Cache Content filter will likely be to permanently write content to the hard drive. To do this, select the file you wish to write to permanent memory and click on the **commit** button. This will delete the file from the cached overlay and replace the current file in permanent storage with the modified cache file.

Keep in mind that committing a configuration or application file will permanently alter the setup and/or performance of the application or system.

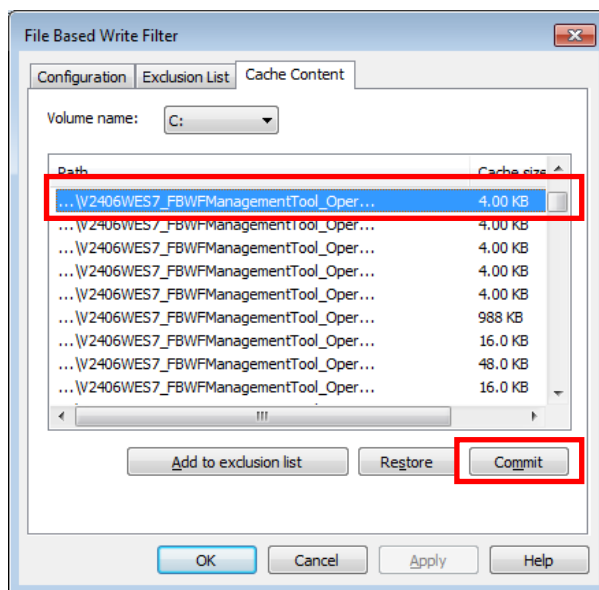

For more details about FBWF configuration and usage, refer to the Microsoft help file that came with your computer, or go to the following websites:

- Microsoft's [FBWF Installation and Configuration](#) help pages.
- Microsoft's [FBWF overview](#) on the official Microsoft FBWF help pages.
- Microsoft's detailed description of [FBWF features](#) on the FBWF help pages.
- Microsoft's detailed description of the [FBWF API](#).

# 5

## Examples

---

This chapter provides examples to illustrate how to use the V2403 computer for a variety of applications.

The following topics are covered in this chapter:

- ❑ **Serial Interface**
- ❑ **Digital Input/Output**
- ❑ **Watchdog**
- ❑ **Power Control**
- ❑ **Power Reset**

# Serial Interface

1. Copy the following files from the software CD/DVD to a folder on the V2403.
  - **mxsp.dll**: Examples\V2403-W7E\_V1.0-Example\3.lib\mxsp\x64\
  - **mxusapi.dll**: Examples\V2403-W7E\_V1.0-Example\3.lib\mxusapi \x64\
  - **UartMode.exe**: Examples\V2403-W7E\_V1.0-Example\Release\x64\
2. Execute **UartMode.exe**.

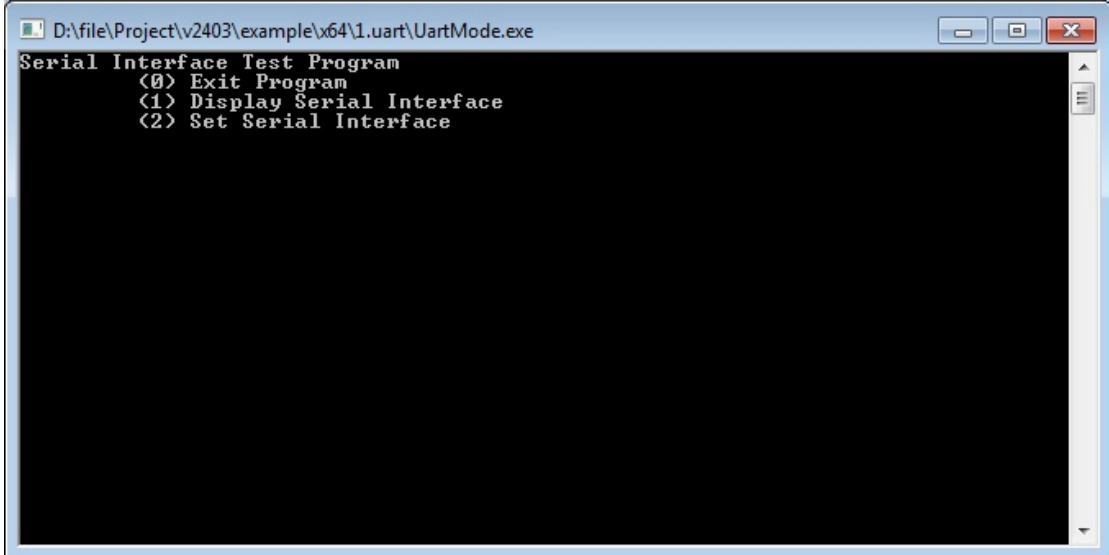

```
D:\file\Project\v2403\example\x64\1.uart\UartMode.exe
Serial Interface Test Program
  <0> Exit Program
  <1> Display Serial Interface
  <2> Set Serial Interface
```

3. Type **2** to set the serial interface, and then follow the on-screen instructions.

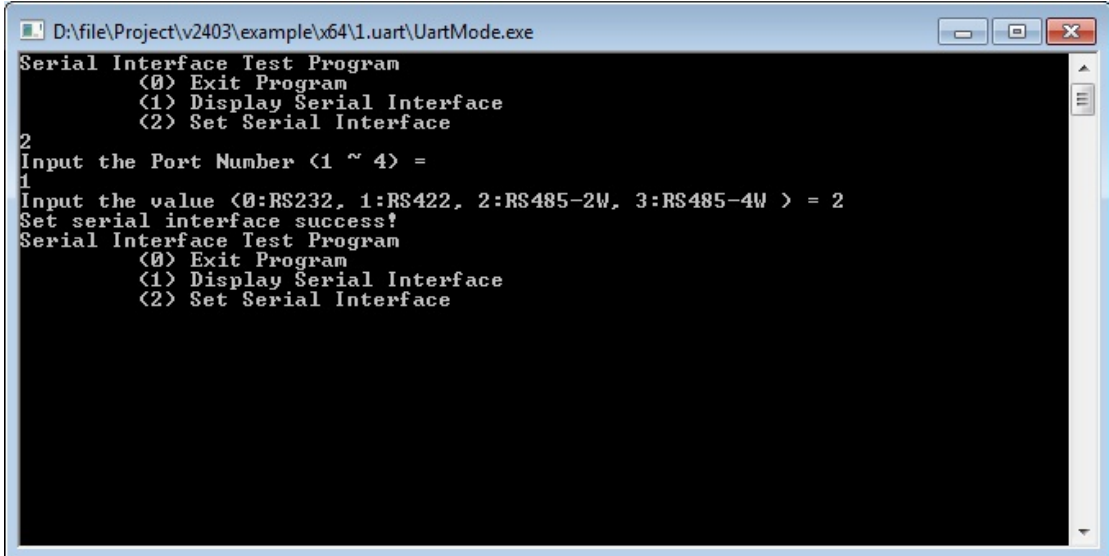

```
D:\file\Project\v2403\example\x64\1.uart\UartMode.exe
Serial Interface Test Program
  <0> Exit Program
  <1> Display Serial Interface
  <2> Set Serial Interface
2
Input the Port Number <1 ~ 4> =
1
Input the value <0:RS232, 1:RS422, 2:RS485-2W, 3:RS485-4W > = 2
Set serial interface success!
Serial Interface Test Program
  <0> Exit Program
  <1> Display Serial Interface
  <2> Set Serial Interface
```

4. Type **1** to display the current serial interface settings.

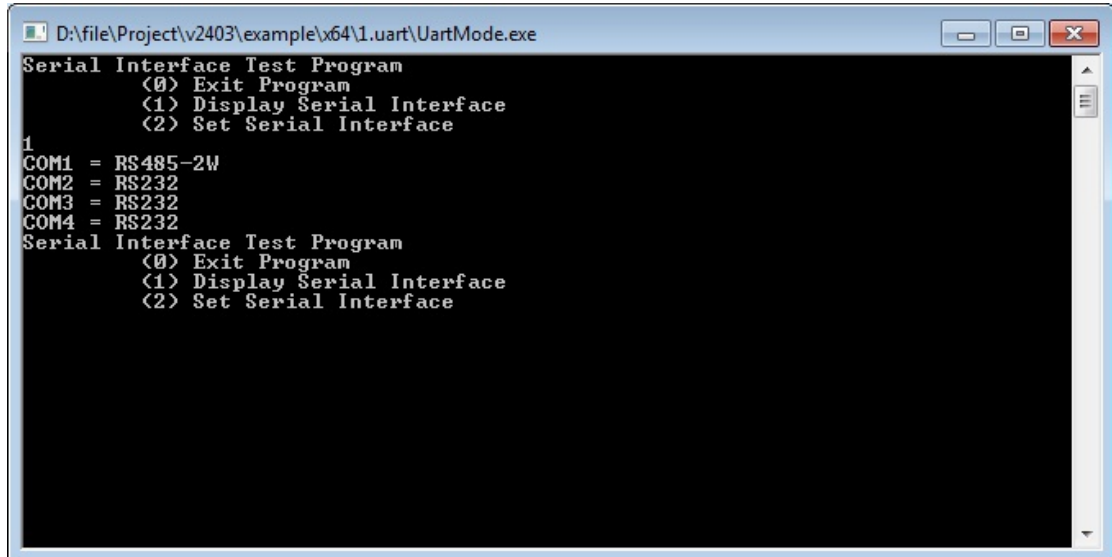

```
D:\file\Project\v2403\example\x64\1.uart\UartMode.exe
Serial Interface Test Program
  (0) Exit Program
  (1) Display Serial Interface
  (2) Set Serial Interface
1
COM1 = RS485-2W
COM2 = RS232
COM3 = RS232
COM4 = RS232
Serial Interface Test Program
  (0) Exit Program
  (1) Display Serial Interface
  (2) Set Serial Interface
```

## Digital Input/Output

1. Copy the following files from the software CD/DVD to a folder on the V2403.
  - **mxdgio.dll**: Examples\V2403-W7E\_V1.0-Example\3.lib\mxdgio\x64\
  - **mxGeneralIo.dll**: Examples\V2403-W7E\_V1.0-Example\3.lib\MxGeneralIo\x64\
  - **DIO.exe**: Examples\V2403-W7E\_V1.0-Example\Release\x64\
2. Execute **DIO.exe**.

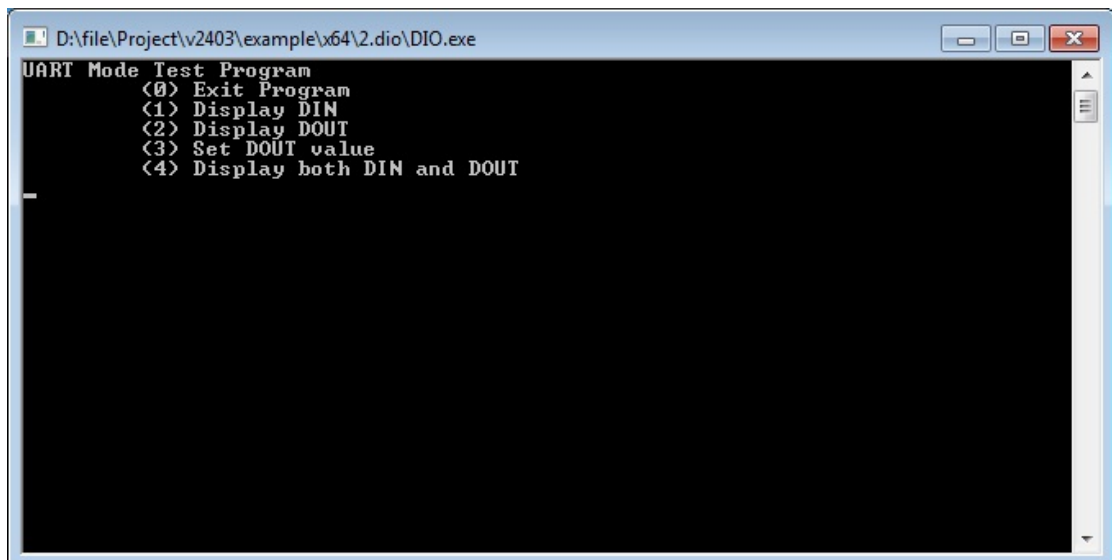

```
D:\file\Project\v2403\example\x64\2.dio\DIO.exe
UART Mode Test Program
  (0) Exit Program
  (1) Display DIN
  (2) Display DOUT
  (3) Set DOUT value
  (4) Display both DIN and DOUT
-
```

3. Type 4 to display the current DI and DO values.

```

D:\file\Project\v2403\example\x64\2.dio\DIO.exe
UART Mode Test Program
  <0> Exit Program
  <1> Display DIN
  <2> Display DOUT
  <3> Set DOUT value
  <4> Display both DIN and DOUT
4
Din0 = 1 , Dout0 = 1
Din1 = 1 , Dout1 = 1
Din2 = 1 , Dout2 = 1
Din3 = 1 , Dout3 = 1
UART Mode Test Program
  <0> Exit Program
  <1> Display DIN
  <2> Display DOUT
  <3> Set DOUT value
  <4> Display both DIN and DOUT
  
```

4. Type 3 to set the DOUT port number, and then follow the on-screen instructions.

```

D:\file\Project\v2403\example\x64\2.dio\DIO.exe
UART Mode Test Program
  <0> Exit Program
  <1> Display DIN
  <2> Display DOUT
  <3> Set DOUT value
  <4> Display both DIN and DOUT
3
Input the Port Number <0 ~ 3> =
0
Input the value <0 or 1> = 0
Set digital output success!
UART Mode Test Program
  <0> Exit Program
  <1> Display DIN
  <2> Display DOUT
  <3> Set DOUT value
  <4> Display both DIN and DOUT
  
```

5. Type 4 to check if the port value was set correctly.

```

D:\file\Project\v2403\example\x64\2.dio\DIO.exe
UART Mode Test Program
  <0> Exit Program
  <1> Display DIN
  <2> Display DOUT
  <3> Set DOUT value
  <4> Display both DIN and DOUT
4
Din0 = 0 , Dout0 = 0
Din1 = 1 , Dout1 = 1
Din2 = 1 , Dout2 = 1
Din3 = 1 , Dout3 = 1
UART Mode Test Program
  <0> Exit Program
  <1> Display DIN
  <2> Display DOUT
  <3> Set DOUT value
  <4> Display both DIN and DOUT
  
```

## Watchdog

- Copy the following files from the software CD/DVD to a folder on the V2403.
  - mxdwg.dll**: Examples\V2403-W7E\_V1.0-Example\3.lib\mxdwg\x64\
  - mxGeneralIo.dll**: Examples\V2403-W7E\_V1.0-Example\3.lib\MxGeneralIo\x64\
  - Watchdog.exe**: Examples\V2403-W7E\_V1.0-Example\Release\X64\
- To prevent the system from rebooting, press [Enter] at least once every 10 seconds; otherwise, the system will reboot automatically.

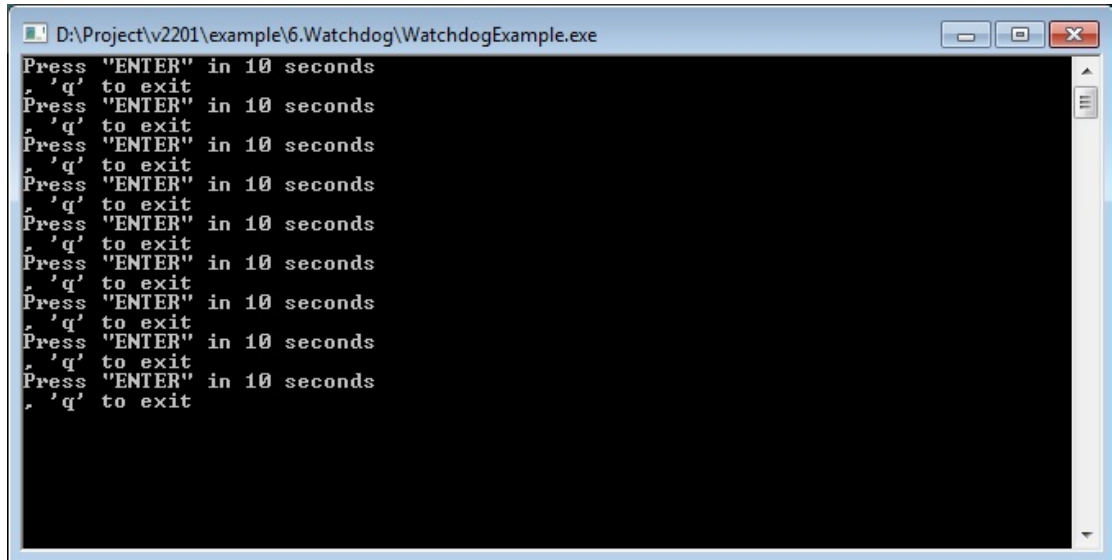

```

D:\Project\v2201\example\6.Watchdog\WatchdogExample.exe
Press "ENTER" in 10 seconds
'q' to exit
Press "ENTER" in 10 seconds
'q' to exit
Press "ENTER" in 10 seconds
'q' to exit
Press "ENTER" in 10 seconds
'q' to exit
Press "ENTER" in 10 seconds
'q' to exit
Press "ENTER" in 10 seconds
'q' to exit
Press "ENTER" in 10 seconds
'q' to exit
Press "ENTER" in 10 seconds
'q' to exit
Press "ENTER" in 10 seconds
'q' to exit

```

- To stop the watchdog, press **q** to exit the program

## Power Control

In this section, we illustrate how to use the test utility to control power through the mini-PCIE interface.

- Copy the following files from the product software DVD.
  - mxgpio.dll**: Examples\V2403-W7E\_V1.0-Example\3.lib\mxgpio\x64\
  - mxGeneralIo.dll**: Examples\V2403-W7E\_V1.0-Example\3.lib\MxGeneralIo\x64\
  - PowerCtrl.exe**: Examples\V2403-W7E\_V1.0-Example\Release\x64\
- Execute **PowerCtrl.exe**.

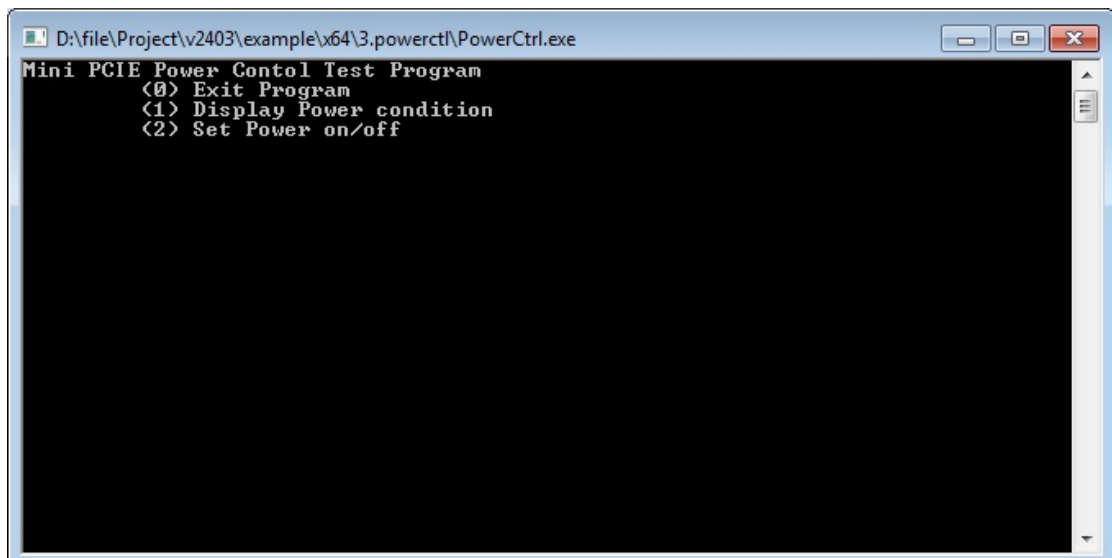

```

D:\file\Project\v2403\example\x64\3.powerctl\PowerCtrl.exe
Mini PCIE Power Control Test Program
<0> Exit Program
<1> Display Power condition
<2> Set Power on/off

```

- 3. Type **1** to display the current power status.

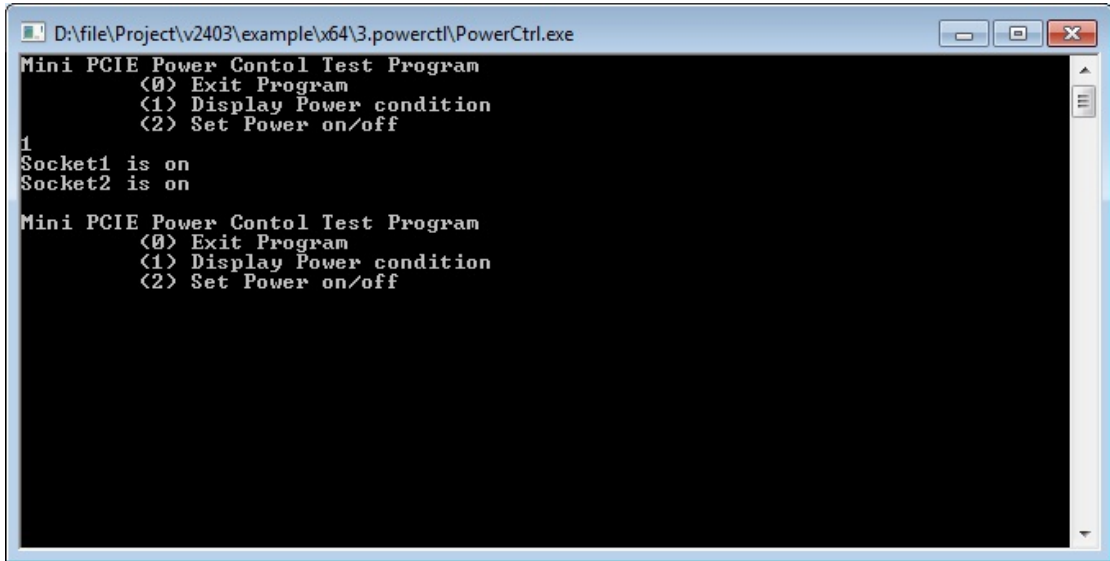

- 4. Type **2** and follow the on-screen instructions to set the power value.

When you set the power value to 0, the power turns off.  
When you set the power value to 1, the power turns on.

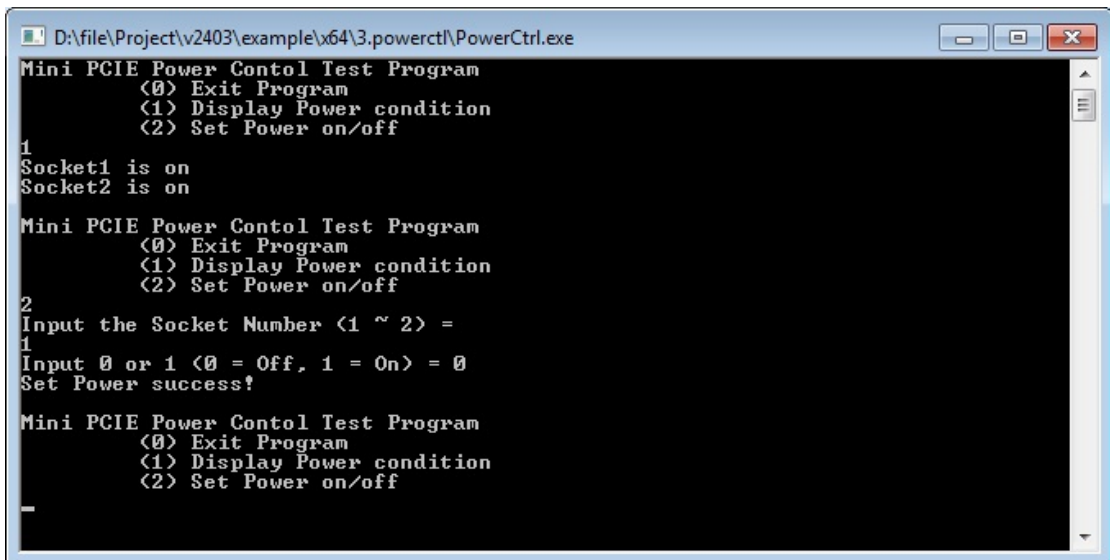



# Power Reset

In this section, we illustrate how to use the test utility to reset the power through the mini-PCIE interface.

1. Copy the following files from the product software DVD.
  - **mxgpio.dll**: Examples\V2403-W7E\_V1.0-Example\3.lib\mxgpio\x64\
  - **mxGeneralIo.dll**: Examples\V2403-W7E\_V1.0-Example\3.lib\MxGeneralIo\x64\
  - **PowerRst.exe**: Examples\V2403-W7E\_V1.0-Example\Release\x64\
2. Execute **PowerRst.exe**.

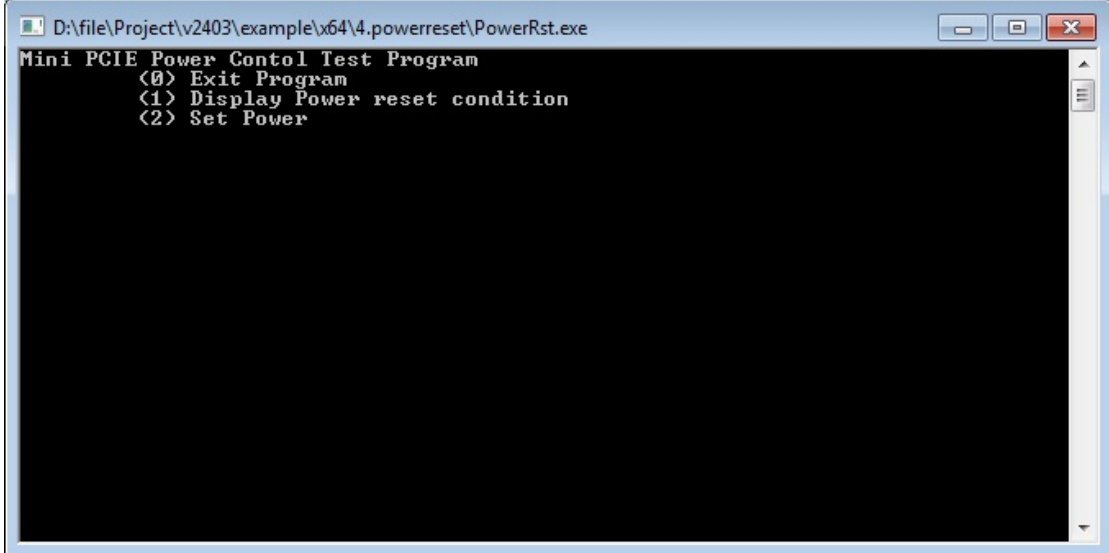

```
D:\file\Project\v2403\example\x64\4.powerreset\PowerRst.exe
Mini PCIE Power Contol Test Program
<0> Exit Program
<1> Display Power reset condition
<2> Set Power
```

3. Type **1** to display the current power reset status

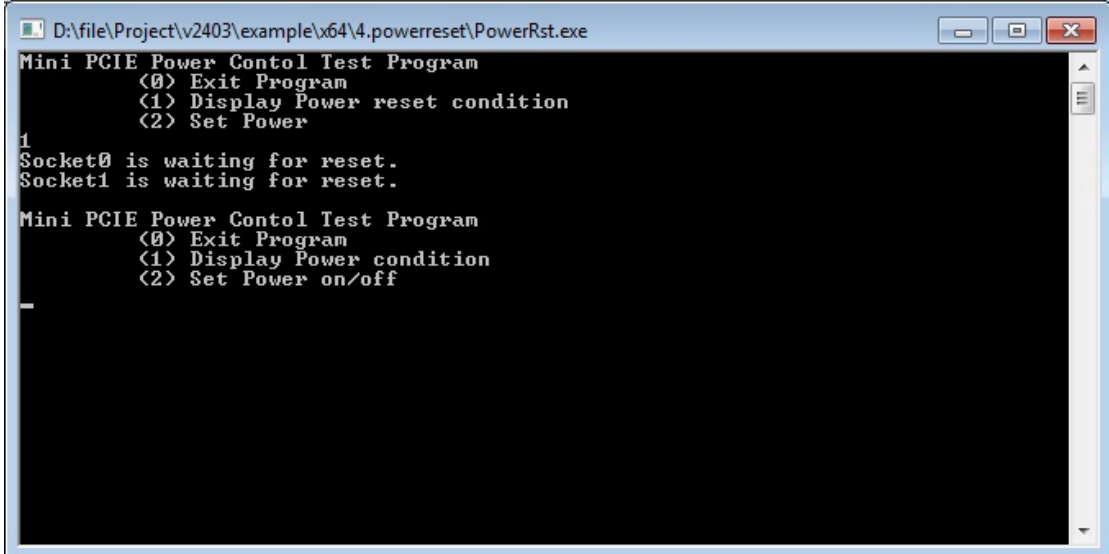

```
D:\file\Project\v2403\example\x64\4.powerreset\PowerRst.exe
Mini PCIE Power Contol Test Program
<0> Exit Program
<1> Display Power reset condition
<2> Set Power
1
Socket0 is waiting for reset.
Socket1 is waiting for reset.
Mini PCIE Power Contol Test Program
<0> Exit Program
<1> Display Power condition
<2> Set Power on/off
-
```

4. Type **2** and follow the on-screen instructions to set the reset pin.

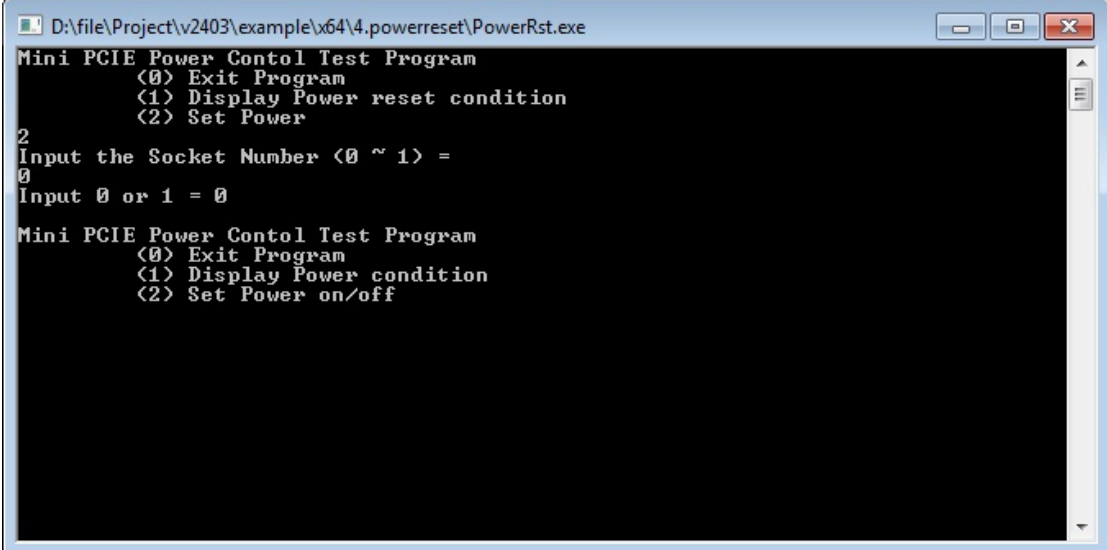

```
D:\file\Project\v2403\example\x64\4.powerreset\PowerRst.exe
Mini PCIE Power Contol Test Program
<0> Exit Program
<1> Display Power reset condition
<2> Set Power
2
Input the Socket Number <0 ~ 1> =
0
Input 0 or 1 = 0
Mini PCIE Power Contol Test Program
<0> Exit Program
<1> Display Power condition
<2> Set Power on/off
```

In this chapter we discuss installation and usage of the software utility.

The following topics are covered in this chapter:

- ❑ **Overview**
- ❑ **Installing the Cellular Module Driver for the MC-9090, MC-7304, MC-7354**
- ❑ **Installing the Cellular Module Dial Utility**
- ❑ **Cellular Module Configuration**
- ❑ **Installing the WPEA-252NI's WiFi Module Driver**
- ❑ **WiFi Module Configuration**
- ❑ **Choosing the Gateway when WiFi and Cellular are Connected at the Same Time**

## Overview

Moxa provides MC-9090, MC-7304, and MC-7354 cellular modules, and WPEA-252NI WiFi modules, all of which are pre-tested with the V2403.

The files that are needed are located in the folder named after the corresponding module, in the \driver\V2403-W7E\_V1.0\_Expansion\_Module\x64\Modules folder

## Installing the Cellular Module Driver for the MC-9090, MC-7304, MC-7354

1. Run `driver\V2403-W7E_V1.0_Expansion_Module\x64\Modules\MC-9090\Build4208.exe` to begin the installation and click **Next**.

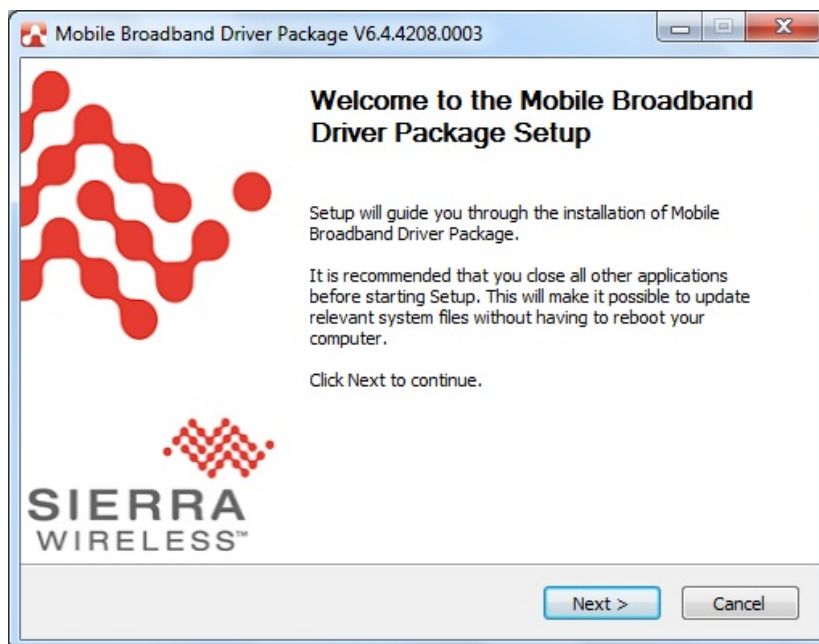

2. Click **I Agree** to accept the license.



3. Click **Finish** to complete the installation.

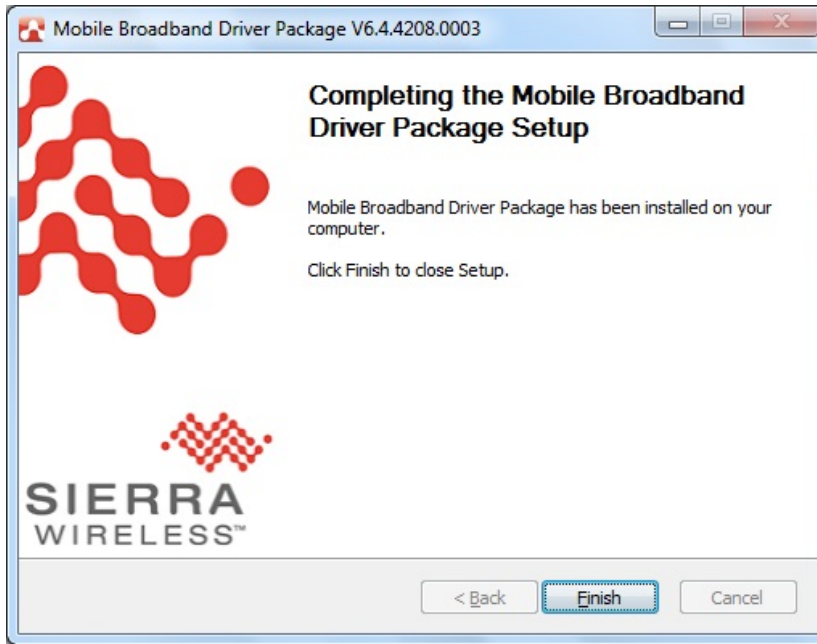

4. The system should locate the new hardware and install the driver automatically. Check the **Windows Device Manager** to verify.

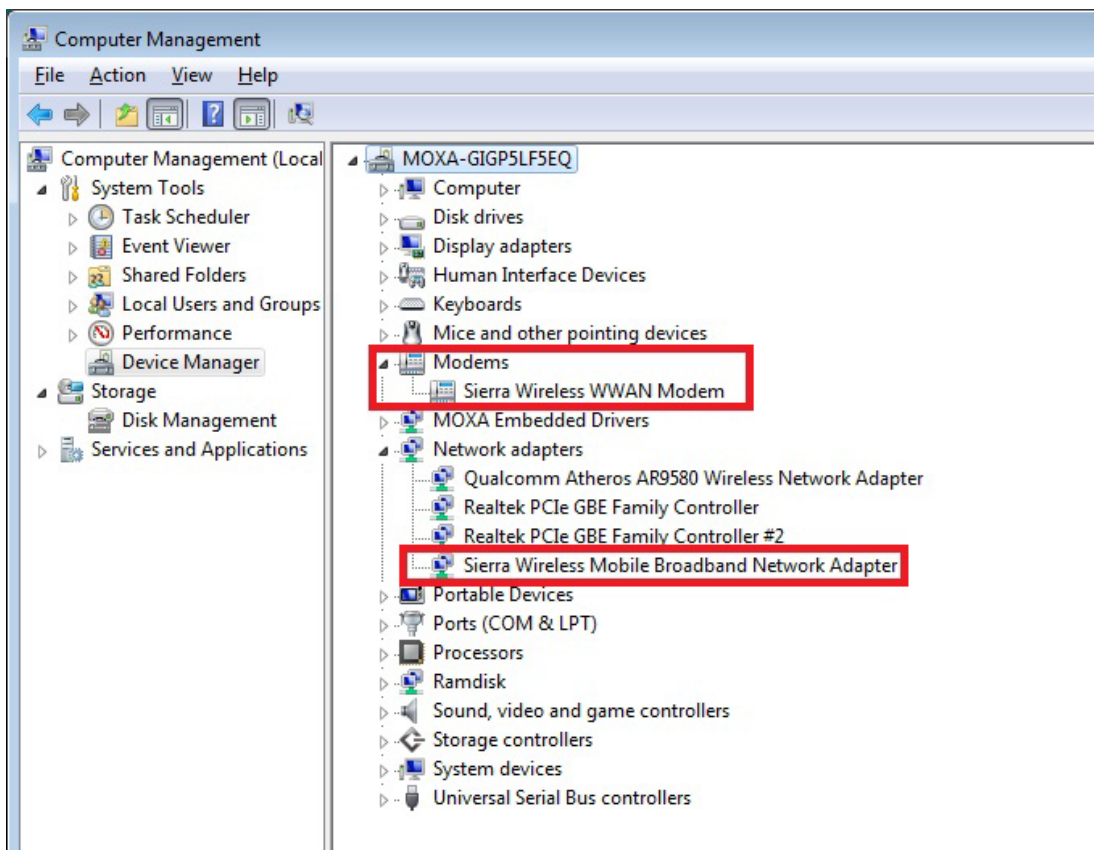

# Installing the Cellular Module Dial Utility

1. Run

driver\V2403-W7E\_V1.0\_Expansion\_Module\x64\Modules\MC-9090\Skylight64\_Generic.msi to begin the installation and then click **Next**.



2. Check **I accept the terms in the license agreement** and click **Next**.



3. Click **Finish** to complete the installation.

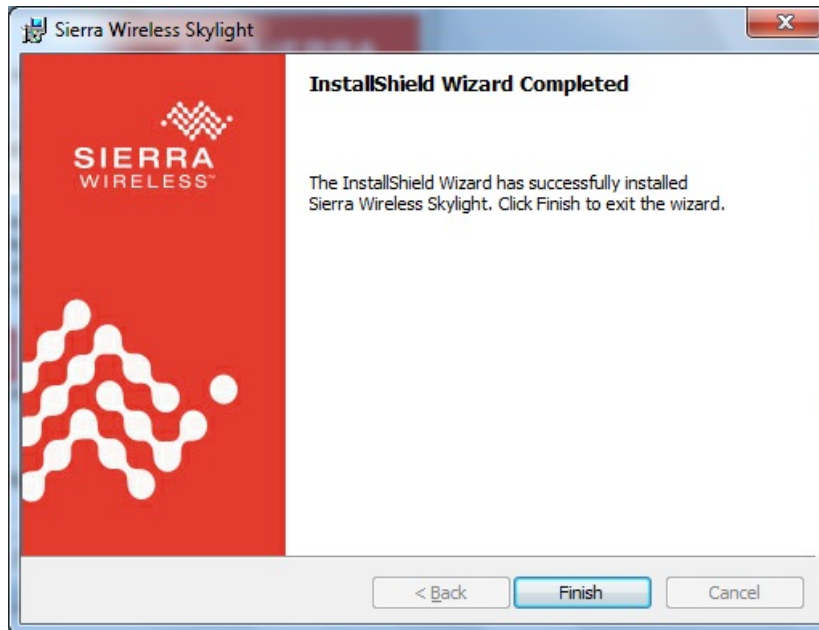

4. The system should locate the new hardware and install the driver automatically. Check the **Skylight** from **Sierra Wireless**.

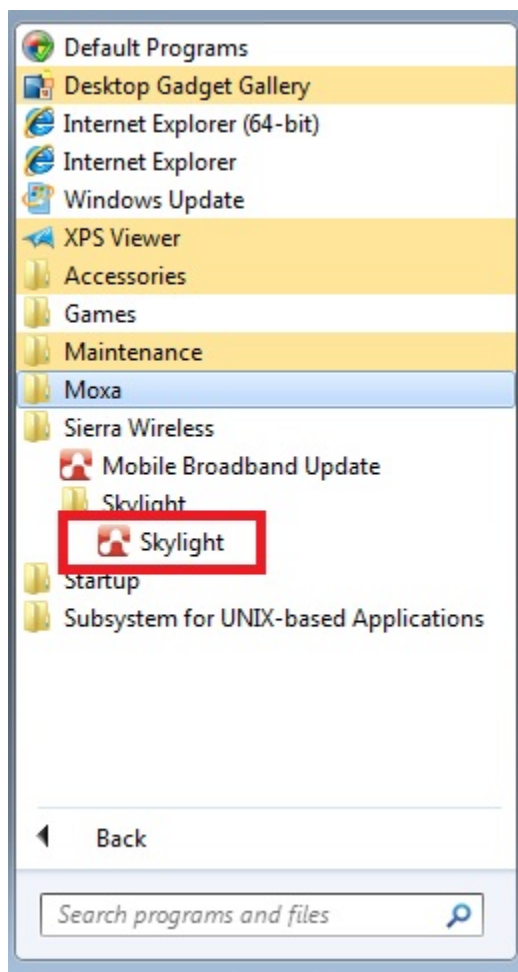

# Cellular Module Configuration

1. After installing cellular module driver and utility, if you want to establish a cellular connection, start **Skylight** and click **Connect**.



2. You can verify the cellular connection by pinging the interface once the connection is established.

```
Administrator: C:\Windows\system32\CMD.exe
Microsoft Windows [Version 6.1.7601]
Copyright (c) 2010 Microsoft Corporation. All rights reserved.

C:\Users\oxa>PIND WWW.MOXA.COM
'PIND' is not recognized as an internal or external command,
operable program or batch file.

C:\Users\oxa>PING WWW.MOXA.COM

Pinging WWW.MOXA.COM [98.129.229.187] with 32 bytes of data:
Reply from 98.129.229.187: bytes=32 time=235ms TTL=47
Reply from 98.129.229.187: bytes=32 time=226ms TTL=47
Reply from 98.129.229.187: bytes=32 time=1105ms TTL=47
Reply from 98.129.229.187: bytes=32 time=241ms TTL=47

Ping statistics for 98.129.229.187:
    Packets: Sent = 4, Received = 4, Lost = 0 (0% loss),
    Approximate round trip times in milli-seconds:
        Minimum = 226ms, Maximum = 1105ms, Average = 451ms

C:\Users\oxa>
```

3. If you want to interrupt the cellular connection, click **Disconnect**.





# Installing the WPEA-252NI's WiFi Module Driver

1. Run `driver\V2403-W7E_V1.0_Expansion_Module\x64\Modules\WPEA-252NI\Install_CD\setup.exe` located in the **Install\_CD** folder to begin the installation.
2. Select language and then click **Next**.

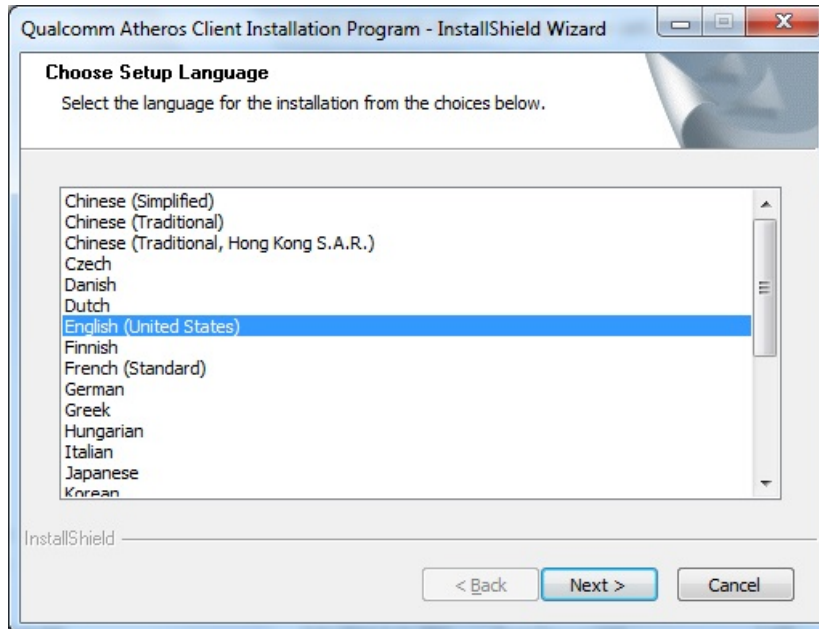

3. Click **Next**.

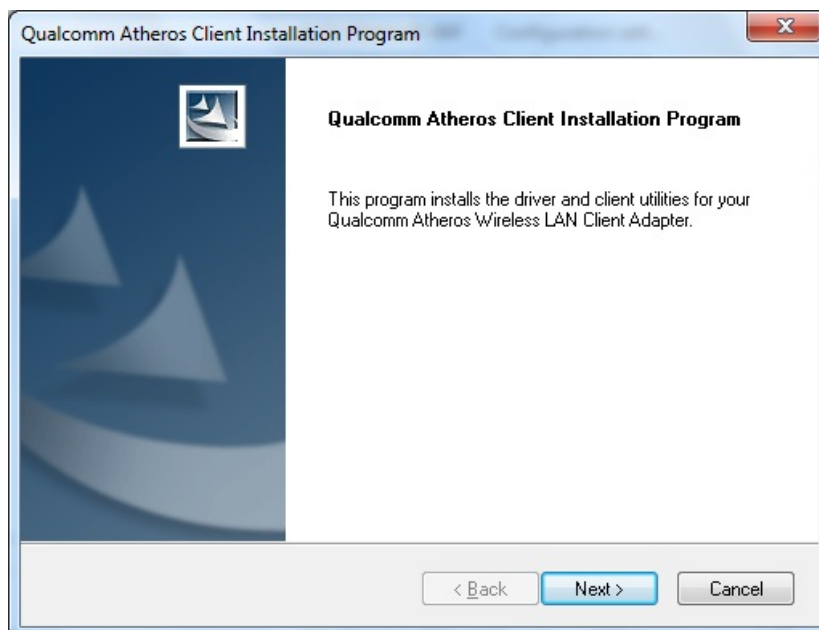

4. Select **I accept the terms of the license agreement** and then click **Next**.

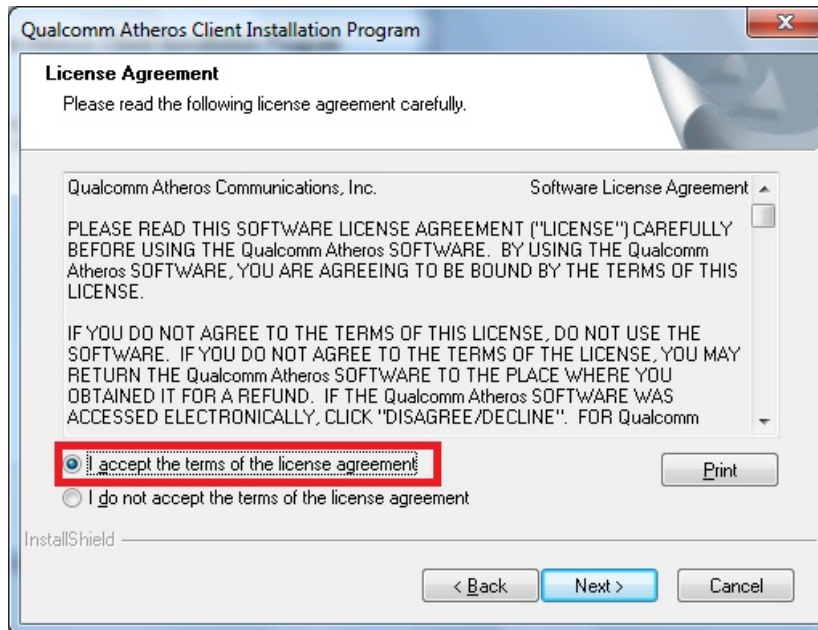

5. Click **Finish** to complete installation.

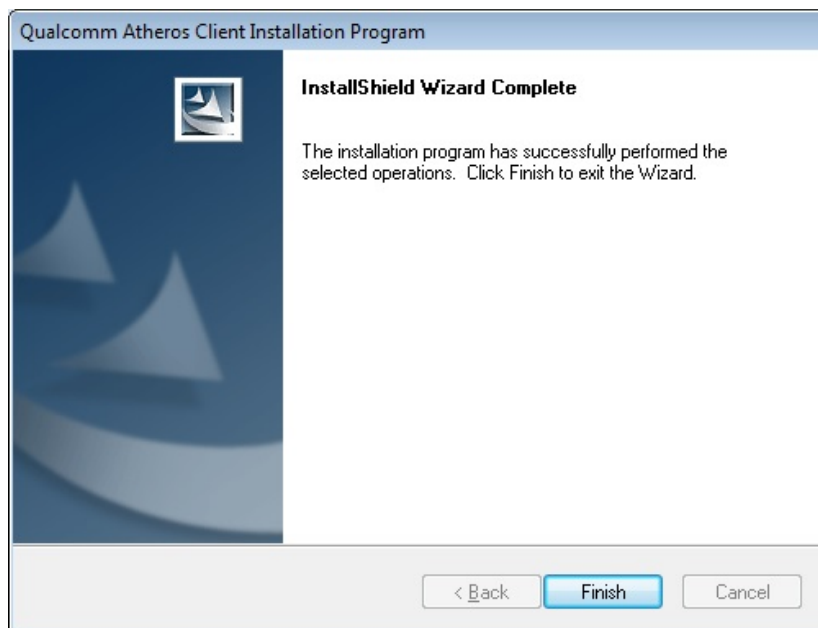

- The system should locate the new hardware and install the driver automatically. Check the **Windows Device Manager** to verify.

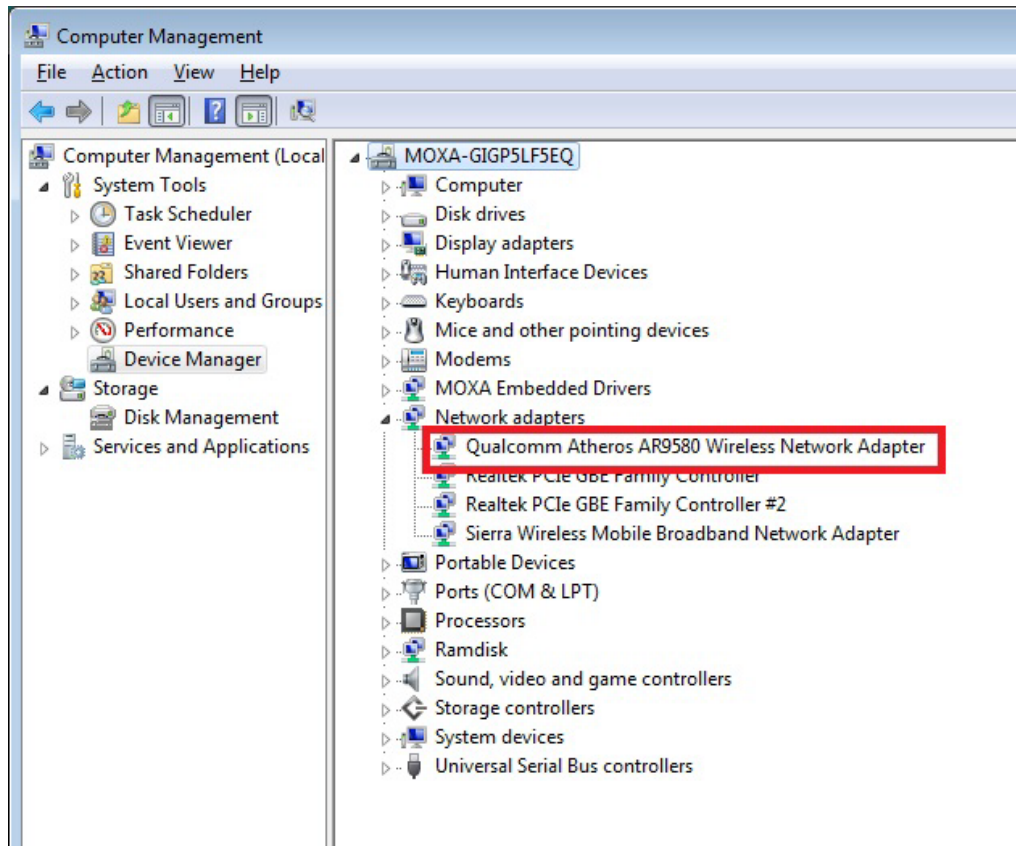

## WiFi Module Configuration

- After installing the WiFi module driver, select the wireless network connection from the taskbar.

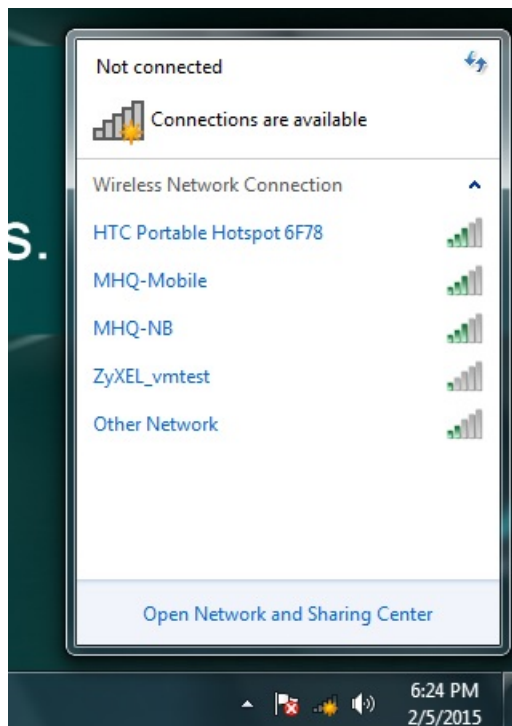

2. Enter the password and then click **OK** to connect to the network.

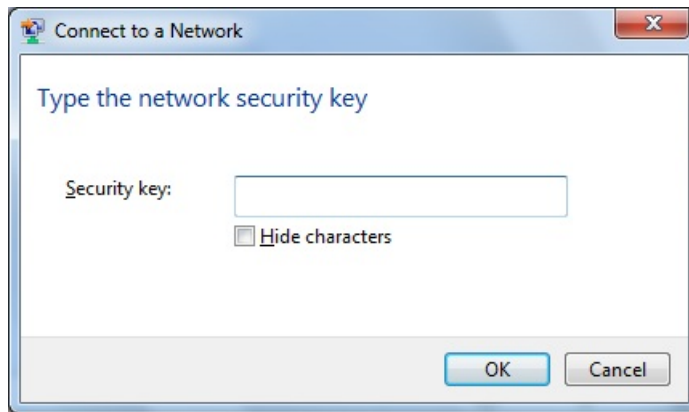

3. You can verify the cellular connection by pinging the interface once the connection is established.

```
Administrator: C:\Windows\system32\CMD.exe
Microsoft Windows [Version 6.1.7601]
Copyright (c) 2010 Microsoft Corporation. All rights reserved.

C:\Users\oxa>PIND WWW.MOXA.COM
'PIND' is not recognized as an internal or external command,
operable program or batch file.

C:\Users\oxa>PING WWW.MOXA.COM

Pinging WWW.MOXA.COM [98.129.229.187] with 32 bytes of data:
Reply from 98.129.229.187: bytes=32 time=235ms TTL=47
Reply from 98.129.229.187: bytes=32 time=226ms TTL=47
Reply from 98.129.229.187: bytes=32 time=1105ms TTL=47
Reply from 98.129.229.187: bytes=32 time=241ms TTL=47

Ping statistics for 98.129.229.187:
    Packets: Sent = 4, Received = 4, Lost = 0 (0% loss),
    Approximate round trip times in milli-seconds:
        Minimum = 226ms, Maximum = 1105ms, Average = 451ms

C:\Users\oxa>
```

# Choosing the Gateway when WiFi and Cellular are Connected at the Same Time

1. Open the **Start Menu** and type **cmd** in the Start Menu search box.
2. Click **cmd** from the search results, which should appear directly under Programs.
3. When the Command Prompt window opens, type **ipconfig** into the command prompt window. You can then get the IP address of the WiFi connection and cellular connection. In this case, the IP address of the WiFi connection is **192.168.0.6**, and the IP address of the cellular connection is **100.73.239.179**.

```
Administrator: C:\Windows\system32\cmd.exe
C:\Users\moxa>ipconfig

Windows IP Configuration

Mobile Broadband adapter Mobile Broadband Connection:
Connection-specific DNS Suffix . : 
IPv4 Address. . . . . : 100.73.239.179
Subnet Mask . . . . . : 255.255.255.0
Default Gateway . . . . . : 100.73.239.177

Wireless LAN adapter Wireless Network Connection:
Connection-specific DNS Suffix . : ThermaLab
Link-local IPv6 Address . . . . . : fe80::f5f6:bad3:ebe7:75d4%15
IPv4 Address. . . . . : 192.168.0.6
Subnet Mask . . . . . : 255.255.255.0
Default Gateway . . . . . : 192.168.0.1

Ethernet adapter Local Area Connection 2:
Connection-specific DNS Suffix . : 
Link-local IPv6 Address . . . . . : fe80::e5ae:1296:2d91:cb2a%13
IPv4 Address. . . . . : 192.168.11.127
Subnet Mask . . . . . : 255.255.255.0
Default Gateway . . . . . : 

Ethernet adapter Local Area Connection:
Connection-specific DNS Suffix . : 
Link-local IPv6 Address . . . . . : fe80::fd63:6acc:ebe2:856b%11
IPv4 Address. . . . . : 192.168.10.127
Subnet Mask . . . . . : 255.255.255.0
Default Gateway . . . . . : 

Tunnel adapter isatap.{DA7E2F68-5B4E-49C1-81FD-A962CFBD174C}:
Media State . . . . . : Media disconnected
Connection-specific DNS Suffix . : 

Tunnel adapter isatap.{5D66CA37-4700-43A4-BA21-051E189B61AA}:
Media State . . . . . : Media disconnected
Connection-specific DNS Suffix . : 

Tunnel adapter Teredo Tunneling Pseudo-Interface:
Media State . . . . . : Media disconnected
Connection-specific DNS Suffix . : 

Tunnel adapter isatap.ThermaLab:
Media State . . . . . : Media disconnected
Connection-specific DNS Suffix . : ThermaLab

Tunnel adapter isatap.{C70A44CE-54B0-4DF5-A909-1A4F5EC92CBD}:
Media State . . . . . : Media disconnected
Connection-specific DNS Suffix . : 

Tunnel adapter 6T04 Adapter:
Connection-specific DNS Suffix . : 
IPv6 Address. . . . . : 2002:6449:efb3::6449:efb3
Default Gateway . . . . . : 

C:\Users\moxa>
```

- Windows 7 will choose the lowest Metric value for the connection interface if several routes are available for the same network destination and netmask. In this case, WiFi interface is the connection interface.

```

Administrator: C:\Windows\system32\cmd.exe
Packets: Sent = 4, Received = 0, Lost = 4 (100% loss),

C:\Users\moxa>route print
=====
Interface List
18...00 a0 c6 00 00 16 .....Sierra Wireless Mobile Broadband Network Adapter
15...00 0e 8e 44 95 03 .....Qualcomm Atheros AR9580 Wireless Network Adapter
13...00 90 e8 00 e9 65 .....Realtek PCIe GBE Family Controller #2
11...00 90 e8 00 e9 64 .....Realtek PCIe GBE Family Controller
1 .....Software Loopback Interface 1
12...00 00 00 00 00 00 e0 Microsoft ISATAP Adapter
16...00 00 00 00 00 00 e0 Microsoft ISATAP Adapter #2
14...00 00 00 00 00 00 e0 Teredo Tunneling Pseudo-Interface
17...00 00 00 00 00 00 e0 Microsoft ISATAP Adapter #3
19...00 00 00 00 00 00 e0 Microsoft ISATAP Adapter #4
31...00 00 00 00 00 00 e0 Microsoft 6to4 Adapter
=====

IPv4 Route Table
=====
Active Routes:
Network Destination        Netmask          Gateway           Interface        Metric
0.0.0.0                    0.0.0.0          100.73.239.177   100.73.239.179   306
0.0.0.0                    0.0.0.0          192.168.0.1      192.168.0.6      25
100.73.239.176             255.255.255.248 On-link          100.73.239.179   306
100.73.239.179            255.255.255.255 On-link          100.73.239.179   306
100.73.239.183            255.255.255.255 On-link          100.73.239.179   306
127.0.0.0                 255.0.0.0        On-link          127.0.0.1         306
127.0.0.1                 255.255.255.255 On-link          127.0.0.1         306
127.255.255.255           255.255.255.255 On-link          127.0.0.1         306
192.168.0.0               255.255.255.0   On-link          192.168.0.6      281
192.168.0.6              255.255.255.255 On-link          192.168.0.6      281
192.168.0.255            255.255.255.255 On-link          192.168.0.6      281
192.168.10.0             255.255.255.0   On-link          192.168.10.127   266
192.168.10.127           255.255.255.255 On-link          192.168.10.127   266
192.168.10.255           255.255.255.255 On-link          192.168.10.127   266
192.168.11.0             255.255.255.0   On-link          192.168.11.127   266
192.168.11.127           255.255.255.255 On-link          192.168.11.127   266
192.168.11.255           255.255.255.255 On-link          192.168.11.127   266
224.0.0.0                240.0.0.0        On-link          127.0.0.1         306
224.0.0.0                240.0.0.0        On-link          192.168.10.127   266
224.0.0.0                240.0.0.0        On-link          192.168.11.127   266
224.0.0.0                240.0.0.0        On-link          192.168.0.6      281
224.0.0.0                240.0.0.0        On-link          100.73.239.179   306
255.255.255.255           255.255.255.255 On-link          127.0.0.1         306
255.255.255.255           255.255.255.255 On-link          192.168.10.127   266
255.255.255.255           255.255.255.255 On-link          192.168.11.127   266
255.255.255.255           255.255.255.255 On-link          192.168.0.6      281
255.255.255.255           255.255.255.255 On-link          100.73.239.179   306
=====

Persistent Routes:
None

IPv6 Route Table
=====
Active Routes:
If Metric Network Destination      Gateway
1 306 ::1/128 On-link
31 1050 2002::/16 On-link
31 306 2002:6449:efb3::6449:efb3/128 On-link
11 266 fe80::/64 On-link
13 266 fe80::/64 On-link
15 281 fe80::/64 On-link
13 266 fe80::e5ae:1296:2d91:cb2a/128 On-link
15 281 fe80::f5f6:bad3:ebe7:75d4/128 On-link
11 266 fe80::fd63:6acc:ebe2:856b/128 On-link
1 306 ff00::/8 On-link
11 266 ff00::/8 On-link
13 266 ff00::/8 On-link
15 281 ff00::/8 On-link
=====

Persistent Routes:
None

C:\Users\moxa>ipconfig

Windows IP Configuration
    
```

- Now, if you want to change to using cellular for the connection interface, just reduce the metric value of the cellular interface; this value must be lower than the WiFi's metric value.

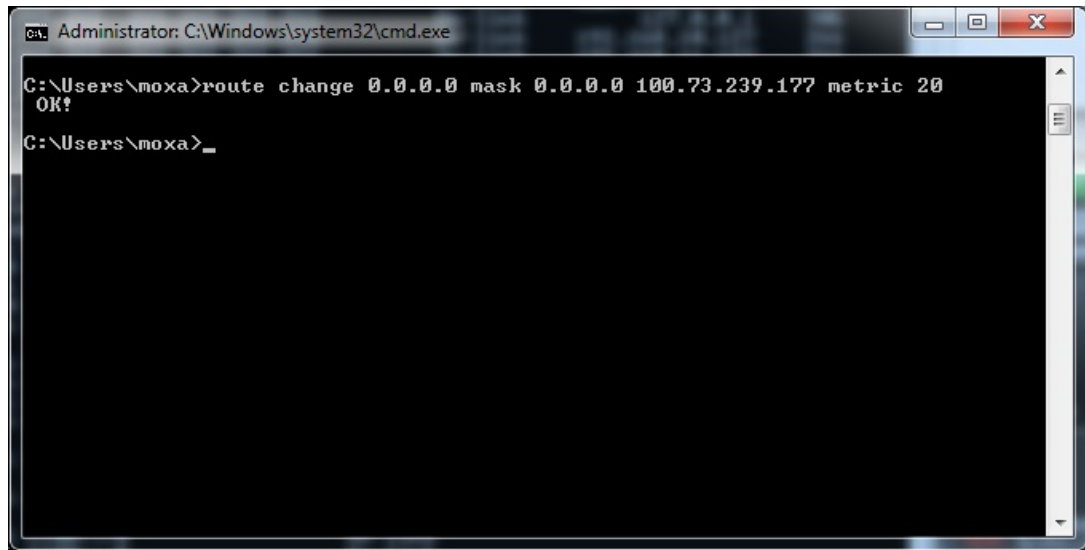

```
C:\Windows\system32\cmd.exe
C:\Users\moxa>route change 0.0.0.0 mask 0.0.0.0 100.73.239.177 metric 20
OK!
C:\Users\moxa>_
```

# System Recovery

---

This chapter describes the system recovery process that you can perform if the system is not functioning properly.

The following topics are covered in this chapter:

- **Overview**
- **Setting Up the Recovery Environment**
- **Recovery Procedure**
- **Saving the System Image to a USB Device**



## Overview

This section describes how to prepare your computer for recovery in the event the system becomes unstable. You can perform a system recovery using one of the following system images:

- A clean factory default image.
- A user-generated image created from a fully configured, fully set up system.

Before you perform a system recovery, set up the system environment.

## Setting Up the Recovery Environment

To set up the recovery environment on a V2403 computer, you will need a USB drive that has at least 4 GB of memory, and a copy of the recovery programs and system image file. To set up the recovery environment, do the following:

1. Copy the recovery programs and system image file on to the USB drive and set up the drive as a live-drive system with an ISO image of the boot environment.
2. Reboot the system and configure the BIOS to boot the recovery system from the USB port.
3. An image of the current software system will be created on the USB drive. The recovery environment will use this image when restoring the system.
4. Reboot the system again and configure the BIOS to its original state.

## Recovery Procedure

### Step 1: Prepare your USB drive

1. Execute **tuxboot-windows-23.exe** from the <Software DVD>\Recovery\ folder on the Software DVD, select **Pre Download**, and then click "..."

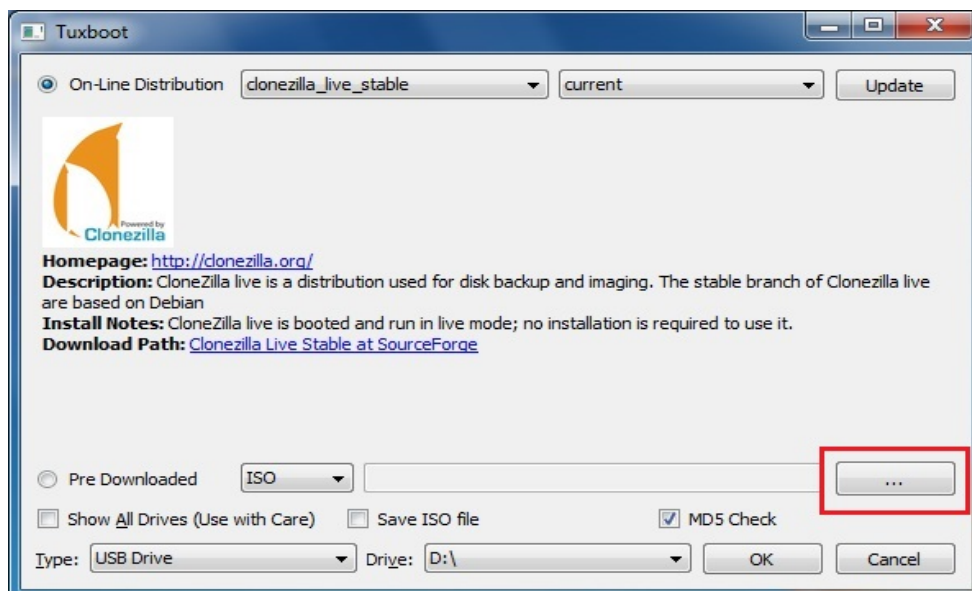

2. Select the ISO file in the directory <Software DVD>\Recovery\

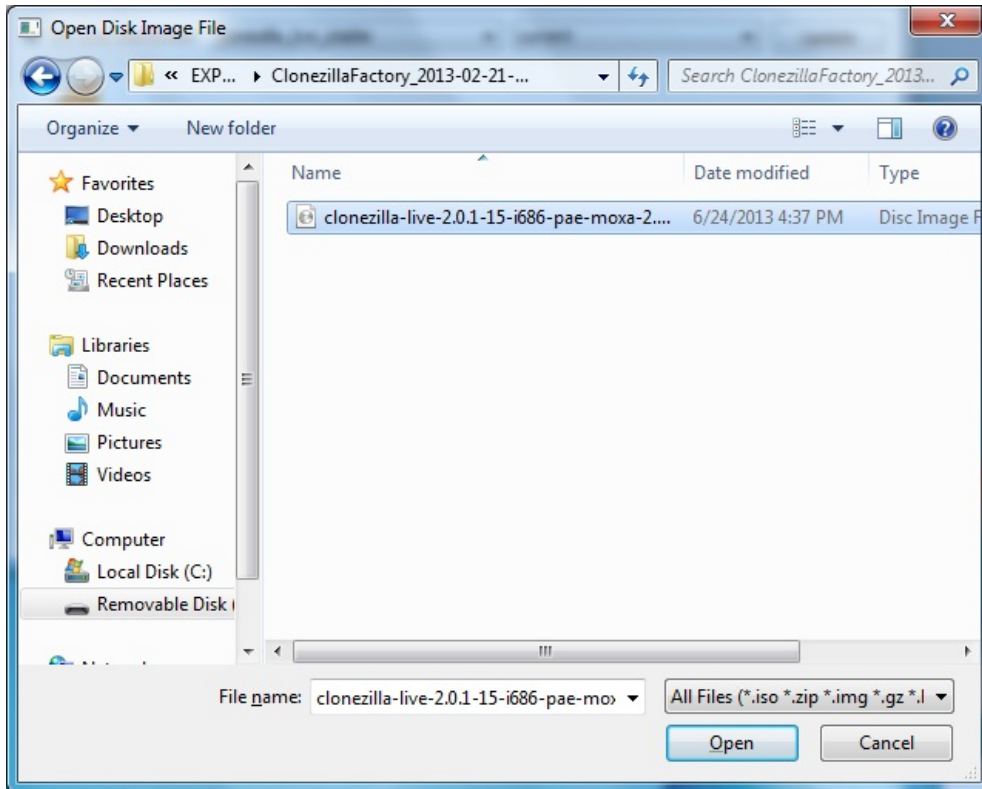

3. Select **USB Drive** type, select a **Drive**, and then click **OK** to continue.

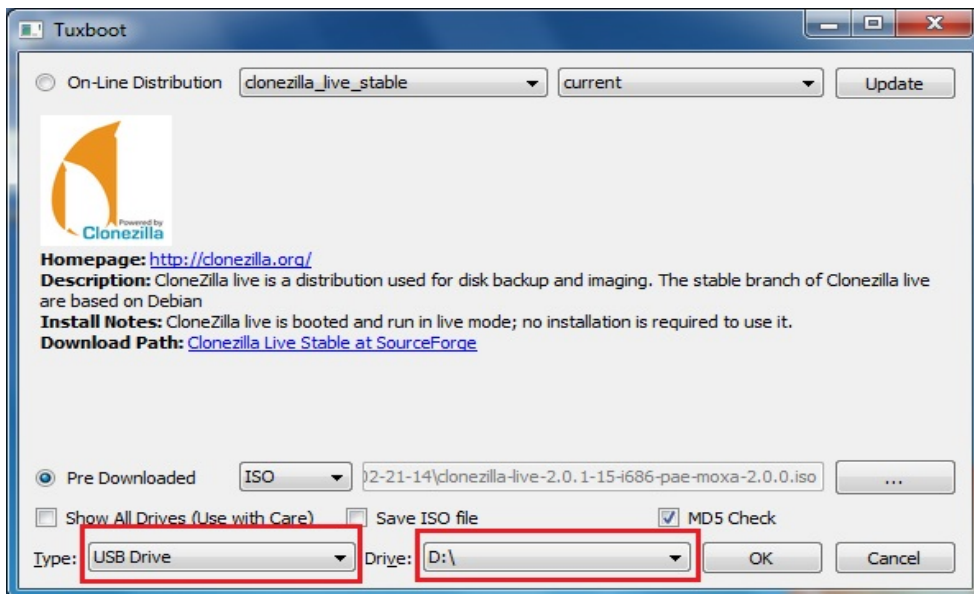

- The boot files will be copied to your USB drive.

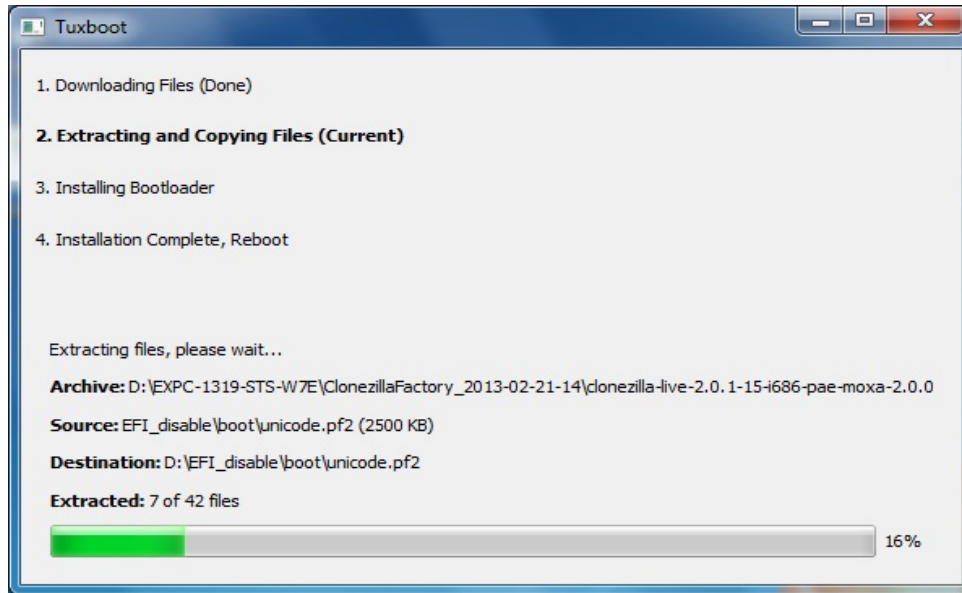

- When finished, click **Exit** to stop the program.



- Manually copy the **os\_image** directory from the <Software DVD>\Recovery\ folder on the Software DVD to \home\partimag\ on the USB drive.

## Step 2: Change the BIOS Settings

You will need to change the BIOS settings to boot from the USB disk.

1. Turn on the computer and press **F2**. Select **SCU** in the following screen.

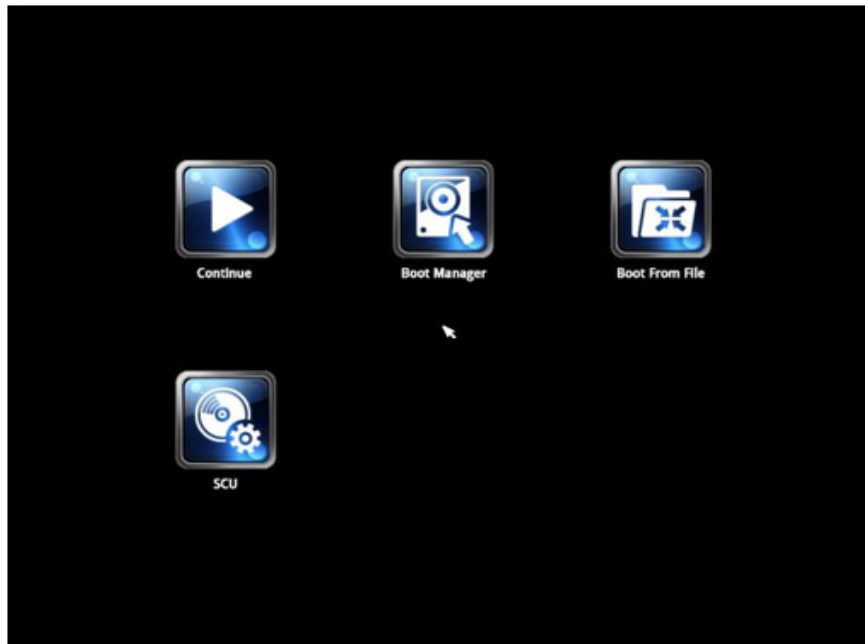

2. Select **Boot** and then select **Legacy**. Press **Enter** to continue.

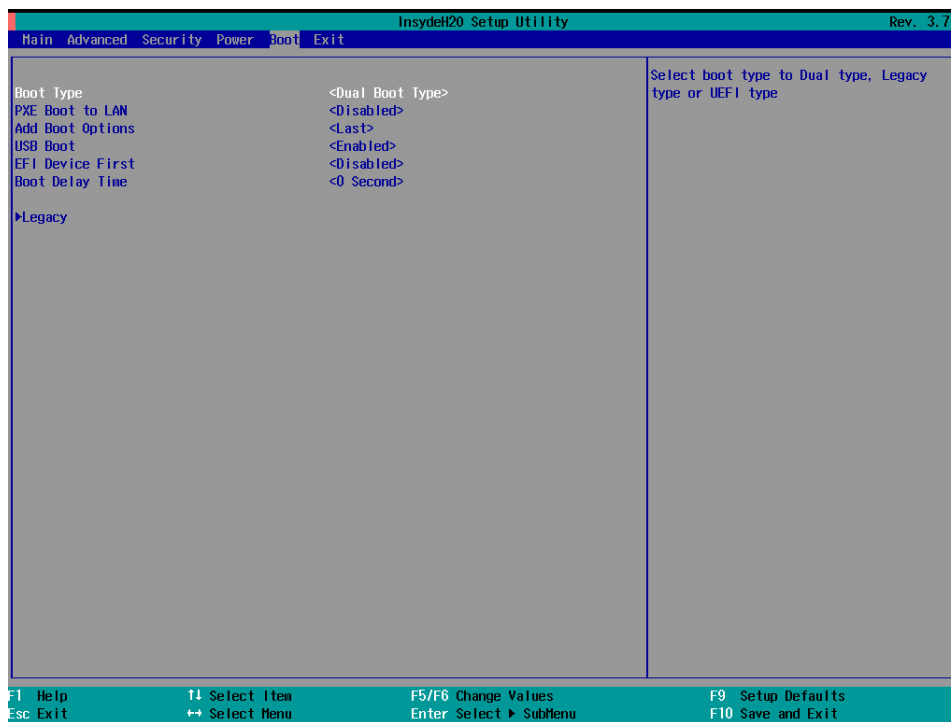

3. Select **Boot Type Order**.

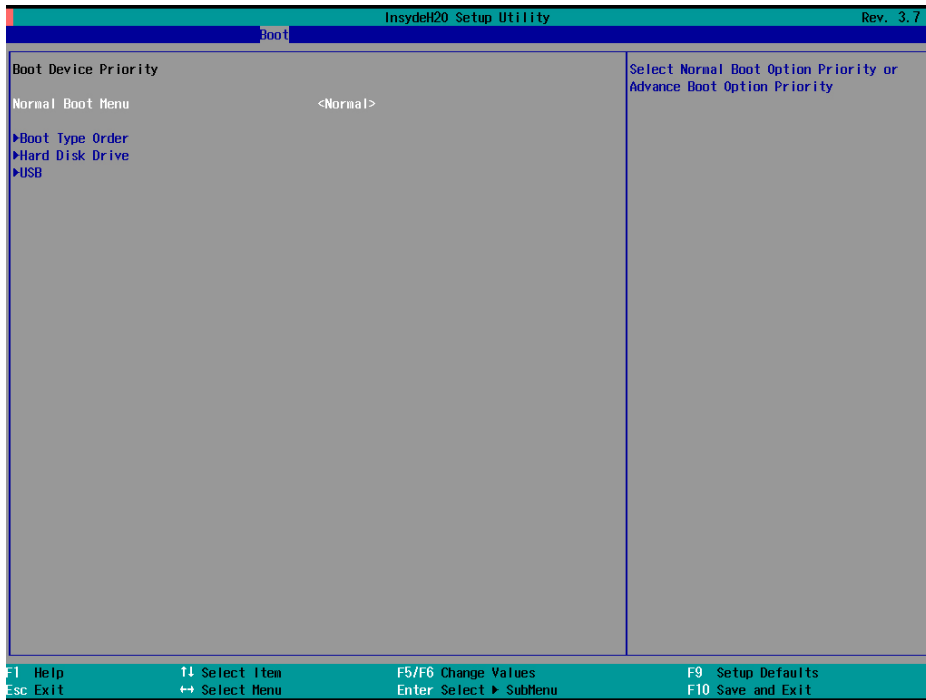

4. Select USB disk and then press "+" to move it to the first boot device position.

**Warning: An incorrect boot priority will lead to recovery failure.**

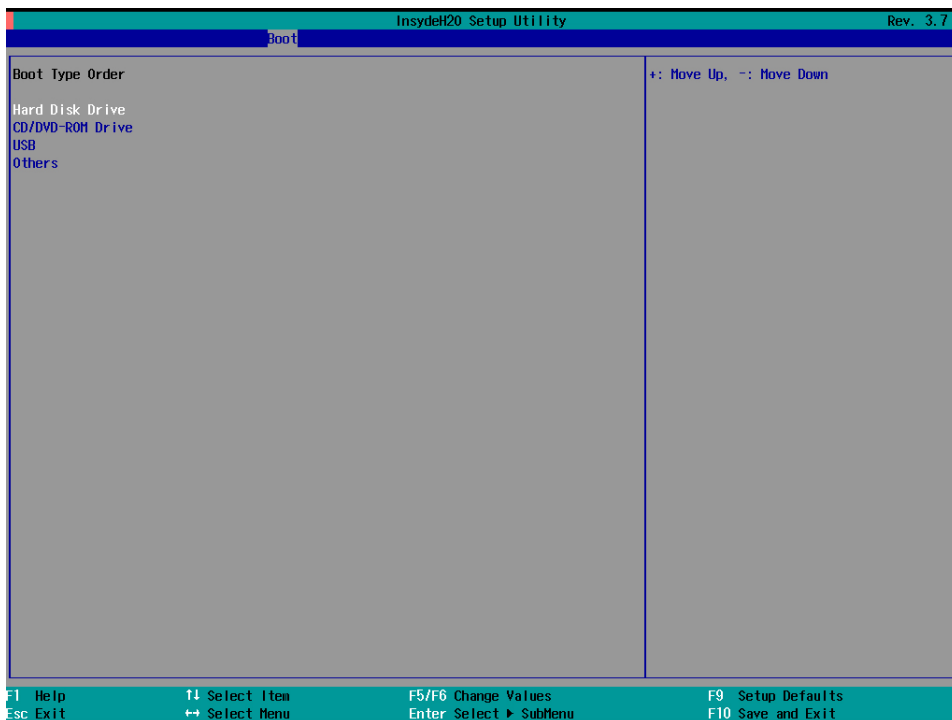

5. Press **F10** and then press **Enter** to save and exit the BIOS setup.

### Step 3: Restore the system from the USB drive

Connect the USB disk to any of the V2403's USB ports and then reboot the computer. The system will boot from the USB disk and the Pre-installation Environment and the recovery utility will appear.

1. Select **clonezilla live restore disk(auto Mode)** option if you want Clonezilla to help you recover the MBR and decompress the image automatically.



2. Wait for the USB drive boot process to finish.

```
[ 5.153522] sd 0:0:0:0: [sda] Attached SCSI disk
[ 5.163726] sd 0:0:1:0: [sdb] Attached SCSI disk
[ 5.287941] sd 0:0:0:0: Attached scsi generic sg0 type 0
[ 5.310750] sd 0:0:1:0: Attached scsi generic sg1 type 0
[ 5.334915] sr 1:0:0:0: Attached scsi generic sg2 type 5
Begin: Loading essential drivers ... [ 5.690577] Atheros(R) L2 Ethernet Driver - version 2.2.3
[ 5.692430] Copyright (c) 2007 Atheros Corporation.
[ 5.776770] Broadcom NetXtreme II 5771x 10Gigabit Ethernet Driver bnx2x 1.62.00-6 (2011/01/30)
[ 5.914014] Btrfs loaded
[ 5.955475] device-mapper: uevent: version 1.0.3
[ 5.961407] device-mapper: ioctl: 4.19.1-ioctl (2011-01-07) initialised: dm-devel@redhat.com
done.
Begin: Running /scripts/init-premount ... done.
Begin: Mounting root file system ... [ 6.178946] Uniform Multi-Platform E-IDE driver
[ 6.186189] ide_generic: please use "probe_mask=0x3f" module parameter for probing all legacy ISA
IDE ports
[ 6.913744] FAT: utf8 is not a recommended IO charset for FAT filesystems, filesystem will be cas
e sensitive!
[ 7.047997] aufs: module is from the staging directory, the quality is unknown, you have been war
ned.
[ 7.072516] aufs 2.1-standalone.tree-38-rcN-20110228
Begin: Running /scripts/live-premount ... done.
[ 7.213433] loop: module loaded
[ 7.509770] squashfs: version 4.0 (2009/01/31) Phillip Lougher
Begin: Running /scripts/live-realpremount ... done.
Begin: Mounting "/live/image/live/filesystem.squashfs" on "//filesystem.squashfs" via "/dev/loop0" .
.. done.
done.
Begin: Running /scripts/live-bottom
... Begin: Configuring fstab ... done.
Begin: Preconfiguring networking ... done.
Begin: Loading preseed file ... done.
Begin: Running /scripts/init-bottom ... done.
INIT: version 2.88 booting
Using makefile-style concurrent boot in runlevel S.
live-config: hostname user-setup sudo locales tzdata keyboard-configuration sysvinit sysv-rc initram
fs-tools util-linux login openssh-server_
```

3. Enter **y** to continue the restore process.

```
The jobs in /etc/ocs/ocs-live.d/ are finished. Start "ocs-live-restore" now.
Setting the TERM as linux
*****
Clonezilla image dir: /home/partimag
*****
Shutting down the Logical Volume Manager
  No volume groups found
  No volume groups found
Finished Shutting down the Logical Volume Manager
*****
Activating the partition info in /proc... done!
*****
The following step is to restore an image to the hard disk/partition(s) on this machine: "/home/part
imag/xpe_savedisk" -> "sda sda1"
WARNING!!! WARNING!!! WARNING!!!
WARNING! THE EXISTING DATA IN THIS HARDDISK/PARTITION(S) WILL BE OVERWRITTEN! ALL EXISTING DATA WILL
BE LOST:
*****
Machine: VirtualBox
sda (2.1GB_VBOX_HARDDISK__ata-VBOX_HARDDISK_VB1c64a0a3-c9f7523d)
*****
Are you sure you want to continue? ?
[y/n] y
```

4. Enter **y** to confirm again.

```
The jobs in /etc/ocs/ocs-live.d/ are finished. Start "ocs-live-restore" now.
Setting the TERM as linux
*****
Clonezilla image dir: /home/partimag
*****
Shutting down the Logical Volume Manager
  No volume groups found
  No volume groups found
Finished Shutting down the Logical Volume Manager
*****
Activating the partition info in /proc... done!
*****
The following step is to restore an image to the hard disk/partition(s) on this machine: "/home/part
imag/xpe_savedisk" -> "sda sda1"
WARNING!!! WARNING!!! WARNING!!!
WARNING! THE EXISTING DATA IN THIS HARDDISK/PARTITION(S) WILL BE OVERWRITTEN! ALL EXISTING DATA WILL
BE LOST:
*****
Machine: VirtualBox
sda (2.1GB_VBOX_HARDDISK__ata-VBOX_HARDDISK_VB1c64a0a3-c9f7523d)
*****
Are you sure you want to continue? ?
[y/n] y
OK, let's do it!!
This program is not started by clonezilla server.
The following step is to restore an image to the hard disk/partition(s) on this machine: "/home/part
imag/xpe_savedisk" -> "sda (sda1)"
WARNING!!! WARNING!!! WARNING!!!
WARNING! THE EXISTING DATA IN THIS HARDDISK/PARTITION(S) WILL BE OVERWRITTEN! ALL EXISTING DATA WILL
BE LOST:
*****
Machine: VirtualBox
sda (2.1GB_VBOX_HARDDISK__ata-VBOX_HARDDISK_VB1c64a0a3-c9f7523d)
*****
Let me ask you again, Are you sure you want to continue? ?
[y/n] _
```

5. Wait for the process to finish.

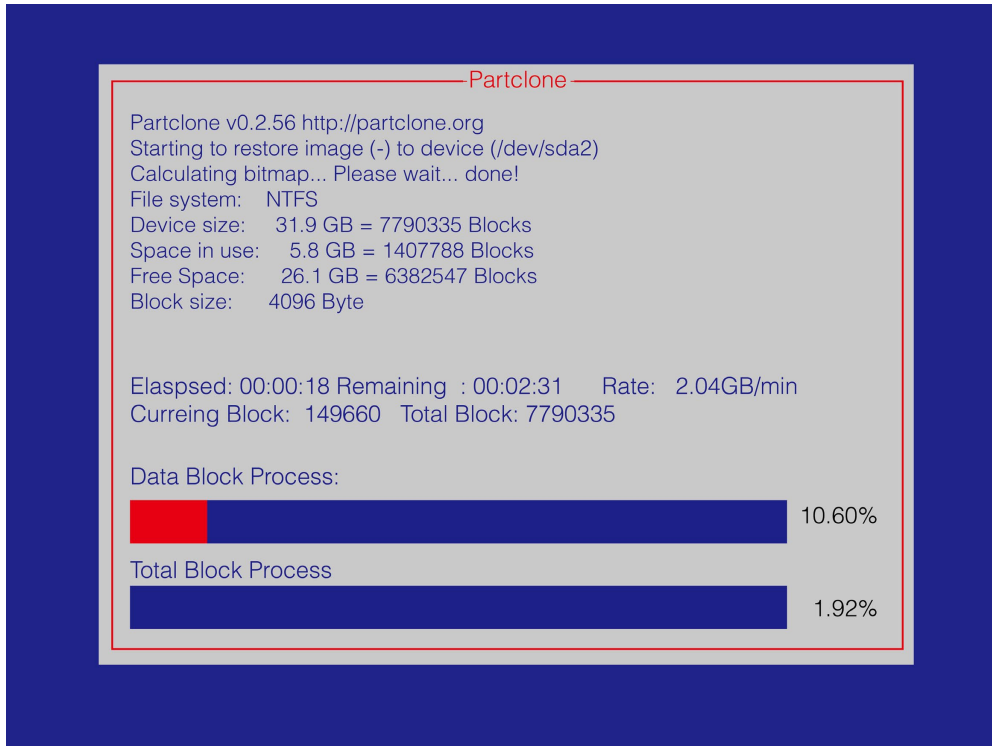

**NOTE** You can press any key or use **CTRL+C** to cancel the recovery process and exit Clonezilla.

6. Select **(0) Poweroff** to power off the computer.

```
Restoring the first 446 bytes of MBR data, i.e. executable code area, for sda... done!
*****
Now resize the partition for sda1
ntfsresize -f /dev/sda1
ntfsresize v2.0.0 (libntfs 10:0:0)
Device name      : /dev/sda1
NTFS volume version: 3.1
Cluster size     : 2048 bytes
Current volume size: 2064511488 bytes (2065 MB)
Current device size: 2064513024 bytes (2065 MB)
New volume size   : 2064511488 bytes (2065 MB)
Nothing to do: NTFS volume size is already OK.
*****
The grub directory is NOT found. Maybe it does not exist (so other boot manager exists) or the file
system is not supported in the kernel. Skip running grub-install.
*****
Found NTFS boot partition among the restored partition(s): /dev/sda1
Head and sector no. of /dev/sda from EDD: 64, 63.
The start sector of NTFS partition /dev/sda1: 63
Adjust filesystem geometry for the NTFS partition: /dev/sda1
Running: partclone.ntfsfixboot -w -h 64 -t 63 -s 63 /dev/sda1
ntfsfixboot version 0.9
done!
*****
*****
*****
This program is not started by Clonezilla server, so skip notifying it the job is done.
Finished!
Now syncing - flush filesystem buffers...

"ocs-live-restore" is finished.
Now you can choose to:
(0) Poweroff
(1) Reboot
(2) Enter command line prompt
(3) Start over
[2]
```

7. Remove the USB drive after the computer has been powered off.



### Step 4: Change the BIOS Settings to Boot from the Original Disk

Now you will need to change the boot priority so that it can boot from the original disk. As the system reboots, press **F2** to enter the BIOS setup menu.

1. Select **Hard Disk Drive** and then press **+** to move to the first boot device position, and then press **Enter**. Make sure the hard disk has first boot priority.

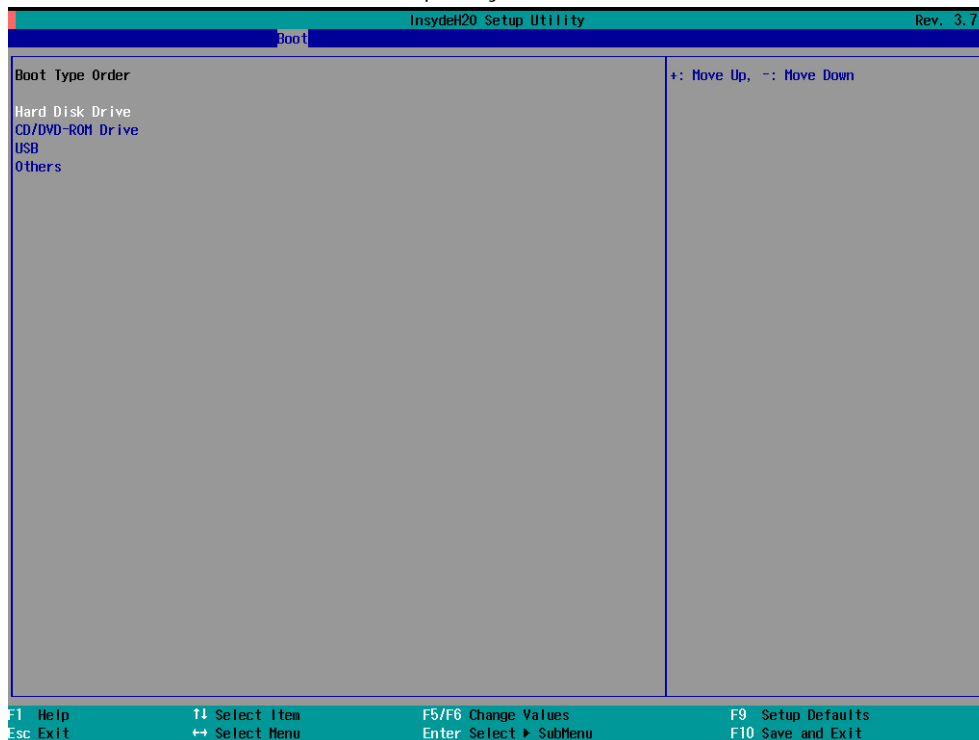

2. Press **F10** and then press **Enter** to save and exit BIOS settings.

## Saving the System Image to a USB Device

You can also save the current system image to a USB device for system recovery in case the system crashes. Before saving the system image to the USB device, we suggest removing all files under `\home\partimag\` on the USB device. Compress the file system on your system before saving the system image to the USB device to ensure smooth completion of the task.

### Compressing the File System on Windows Embedded 7

1. In the **start menu**, right click on **Computer** and select **Manage**. Click on **Disk Management** in the left panel.

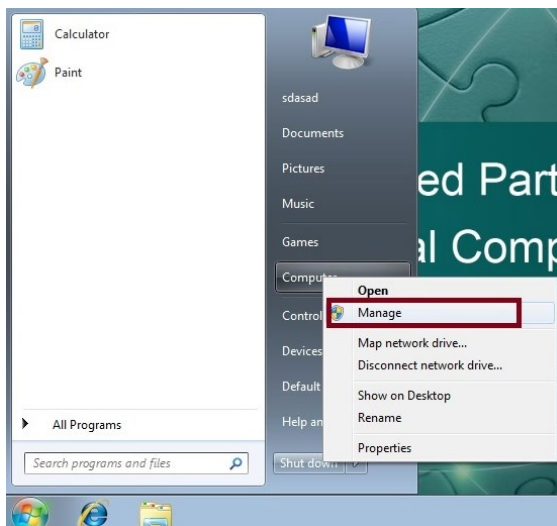

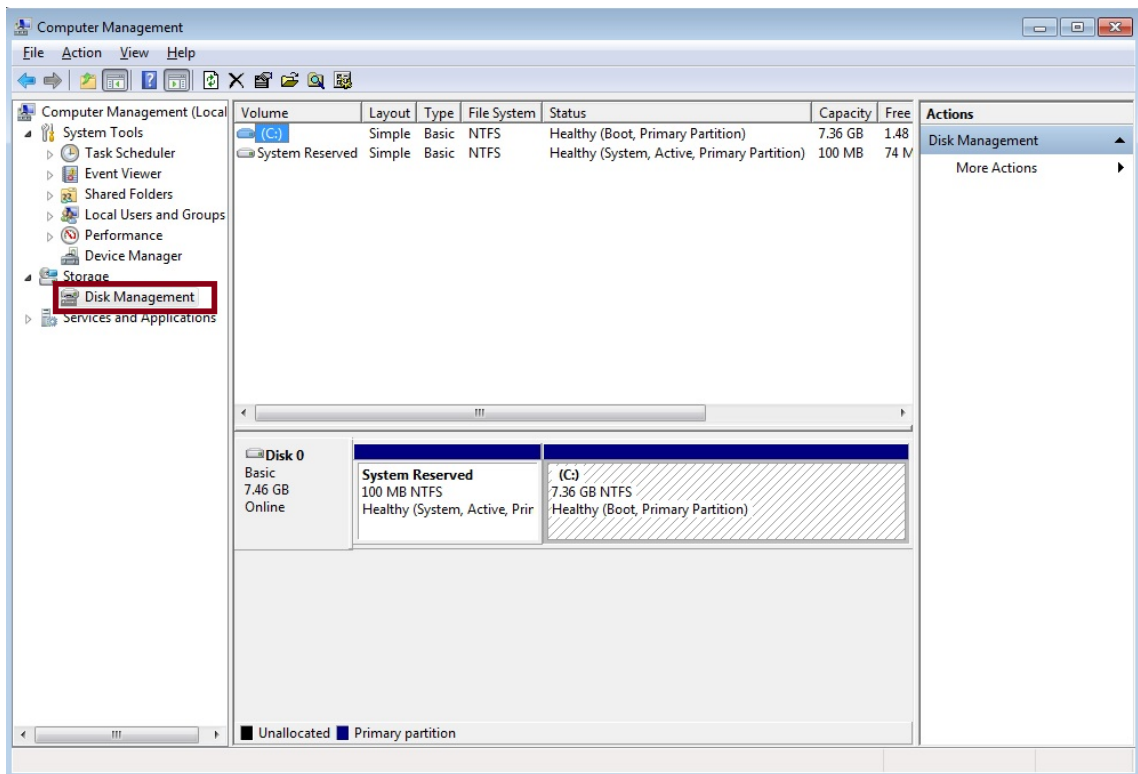

2. Insert the USB device that you want to save the system image to, in the USB port of the system. Click on **Disk Management** to view the size of the file system in **Disk 0** (sum of "System Reserved" and "C:").

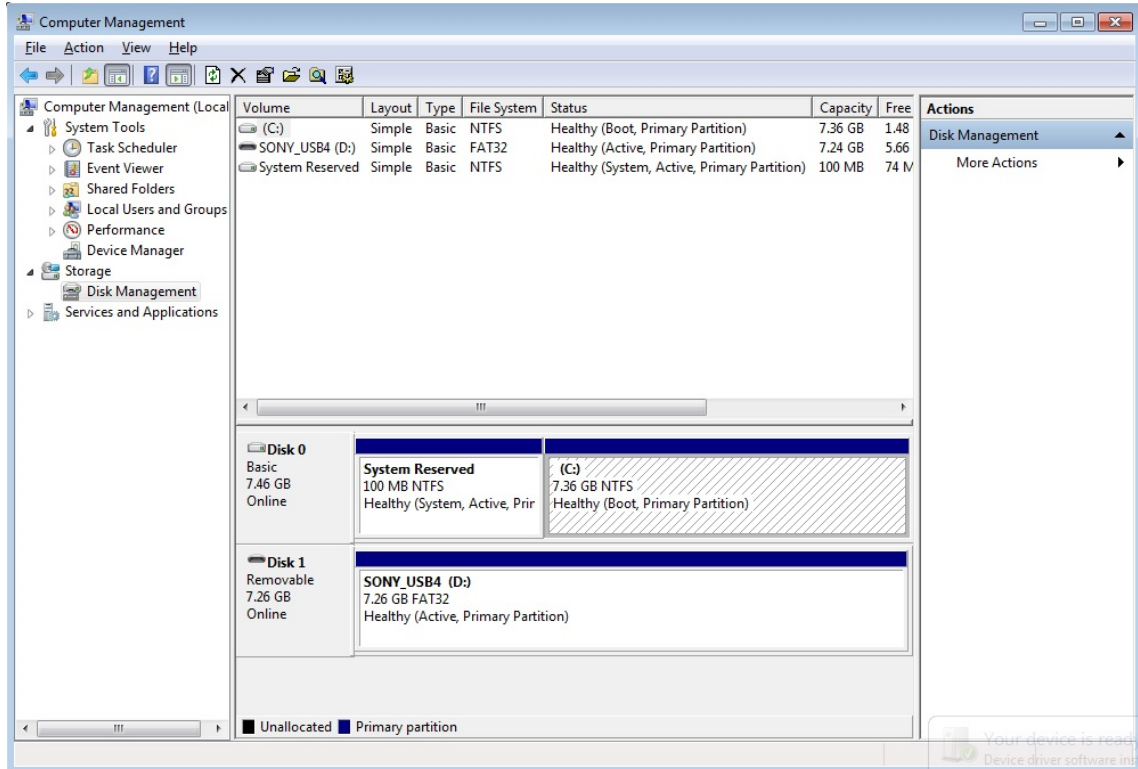

3. Right click on **(C:)** and select **Shrink Volume**.

- Specify a value in **Enter the amount of space to shrink in MB** and click **Shrink**.  
The **Total size after shrink in MB** must be smaller than the size of the USB disk.

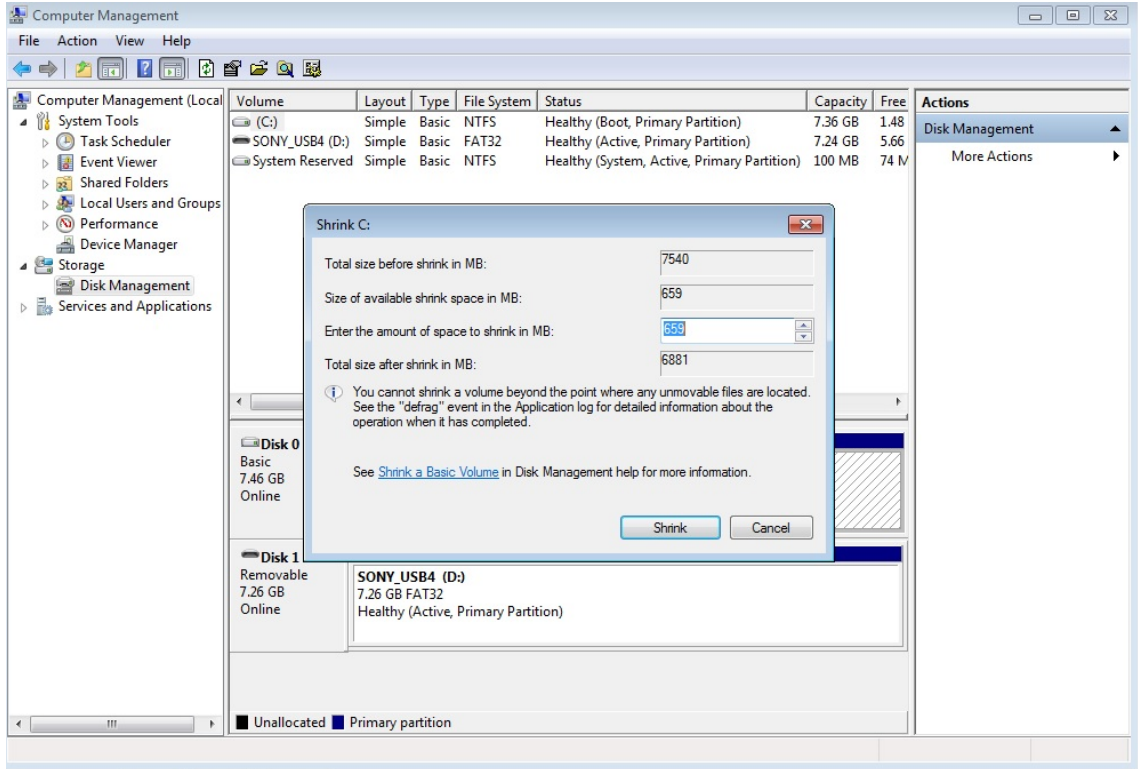

- Make sure that the **Total size after shrink in MB** is smaller than the size of USB disk.

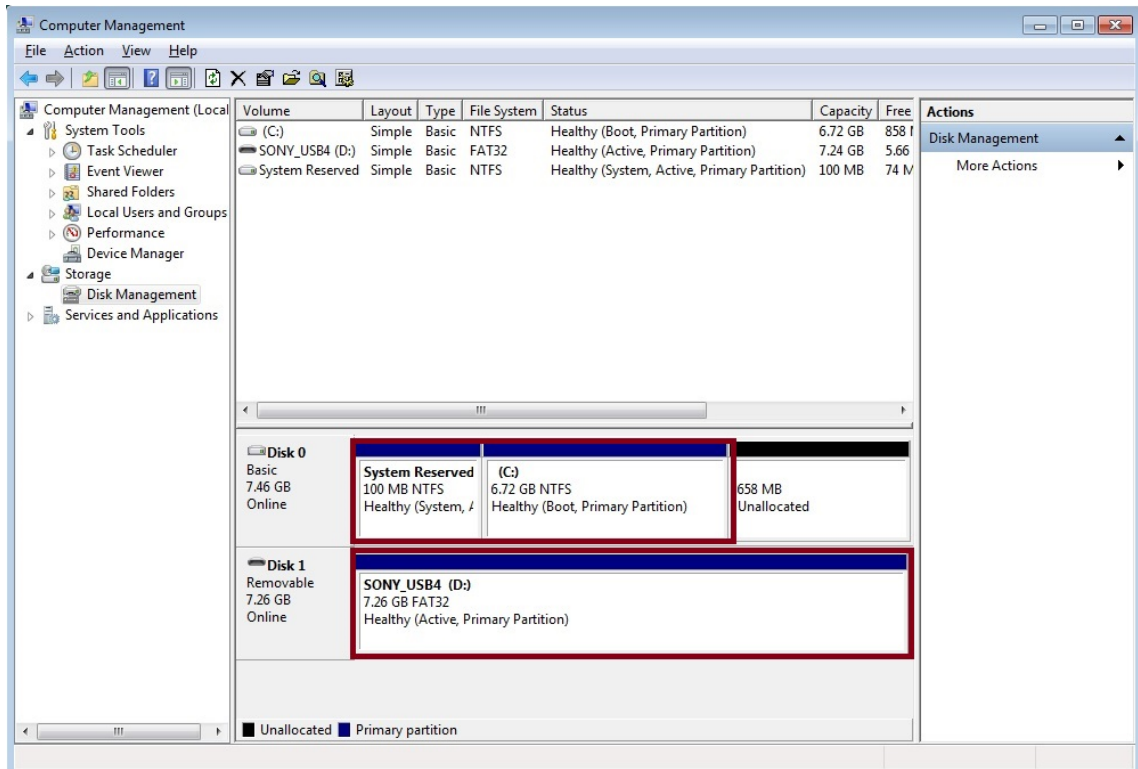

Now reboot the system and change the boot order in the BIOS setting (refer to the "Boot Setting" section of the Hardware Manual) to set the USB device as the first boot priority. Do the following to complete saving the system image to the USB device:

1. Select **clonezilla live save disk**.

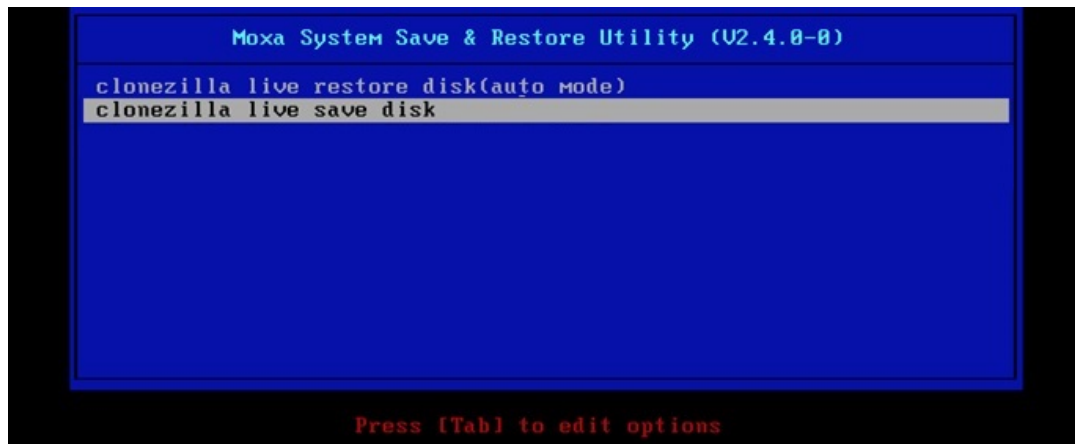

2. Wait for the USB drive boot process to finish.

```
[ 5.141941] sd 0:0:1:0: [sdb] Attached SCSI disk
[ 5.257277] sd 0:0:0:0: Attached scsi generic sg0 type 0
[ 5.269691] sd 0:0:1:0: Attached scsi generic sg1 type 0
[ 5.280668] sr 1:0:0:0: Attached scsi generic sg2 type 5
Begin: Loading essential drivers ... [ 5.772551] Atheros(R) L2 Ethernet Driver - version 2.2.3
[ 5.774561] Copyright (c) 2007 Atheros Corporation.
[ 5.863196] Broadcom NetXtreme II 5771x 10Gigabit Ethernet Driver bnx2x 1.62.00-6 (2011/01/30)
[ 6.005932] Btrfs loaded
[ 6.054095] device-mapper: uevent: version 1.0.3
[ 6.059737] device-mapper: ioctl: 4.19.1-ioctl (2011-01-07) initialised: dm-devel@redhat.com
done.
Begin: Running /scripts/init-premount ... done.
Begin: Mounting root file system ... [ 6.289382] Uniform Multi-Platform E-IDE driver
[ 6.301889] ide_generic: please use "probe_mask=0x3f" module parameter for probing all legacy ISA
IDE ports
[ 6.801141] NTFS driver 2.1.30 [Flags: R/W MODULE].
[ 6.914295] NTFS volume version 3.1.
Begin: Running /scripts/live-premount ... done.
[ 7.331989] FAT: utf8 is not a recommended IO charset for FAT filesystems, filesystem will be cas
e sensitive!
[ 7.453369] aufs: module is from the staging directory, the quality is unknown, you have been war
med.
[ 7.479098] aufs 2.1-standalone.tree-38-rcN-20110228
[ 7.610228] loop: module loaded
[ 7.905144] squashfs: version 4.0 (2009/01/31) Phillip Lougher
Begin: Running /scripts/live-realpremount ... done.
Begin: Mounting "/live/image/live/filesystem.squashfs" on "//filesystem.squashfs" via "/dev/loop0" .
.. done.
done.
Begin: Running /scripts/live-bottom
... Begin: Configuring fstab ... done.
Begin: Preconfiguring networking ... done.
Begin: Loading preseed file ... done.
Begin: Running /scripts/init-bottom ... done.
INIT: version 2.88 booting
Using makefile-style concurrent boot in runlevel S.
```

3. Enter **y** to continue.

```
Setting the TERM as linux
*****
Clonezilla image dir: /home/partimag
*****
Shutting down the Logical Volume Manager
  No volume groups found
  No volume groups found
Finished Shutting down the Logical Volume Manager
Selected device [sda] found!
The selected devices: sda
*****
Activating the partition info in /proc... done!
Selected device [sda] found!
The selected devices: sda
Searching for data partition(s)...
Excluding busy partition or disk...
Unmounted partitions (including extended or swap): sda1
Collecting info.. done!
Searching for swap partition(s)...
Excluding busy partition or disk...
Unmounted partitions (including extended or swap): sda1
Collecting info.. done!
The data partition to be saved:  sda1
The swap partition to be saved:
Activating the partition info in /proc... done!
Selected device [sda1] found!
The selected devices: sda1
Getting /dev/sda1 info...
*****
The following step is to save the hard disk/partition(s) on this machine as an image:
*****
Machine: VirtualBox
sda (2103MB_VBOX_HARDDISK__ata-VBOX_HARDDISK_VB1c64a0a3-c9f7523d)
sda1 (2065MB_ntfs(In_VBOX_HARDDISK_)_ata-VBOX_HARDDISK_VB1c64a0a3-c9f7523d)
*****
-> "/home/partimag/xpe_savedisk".
Are you sure you want to continue? ? (y/n) y
```

4. Wait for the process to finish.

```
/dev/sdb1: read failed after 0 of 2048 at 0: Input/output error
  No volume groups found
  No volume groups found
Finished Shutting down the Logical Volume Manager
Checking the integrity of partition table in the disk /dev/sda...
Reading the partition table for /dev/sda..RETV=0
*****
done!
Saving the MBR data for sda...
1+0 records in
1+0 records out
512 bytes (512 B) copied, 0.00347646 s, 147 kB/s
*****
Starting saving /dev/sda1 as /home/partimag/xpe_savedisk/sda1.XXX...
/dev/sda1 filesystem: ntfs.
*****
Checking NTFS integrity in /dev/sda1... done!
Checking the disk space...
Use ntfsclone with gzip to save the image.
Image file will be split with size limit 1000000 MB.
*****
If this action fails or hangs, check:
* Is the disk full ?
*****
ntfsclone v2.0.0 (libntfs 10:0:0)
NTFS volume version: 3.1
Cluster size      : 2048 bytes
Current volume size: 2064510976 bytes (2065 MB)
Current device size: 2064513024 bytes (2065 MB)
Scanning volume ...
100.00 percent completed
Accounting clusters ...
Space in use      : 1770 MB (85.7%)
Saving NTFS to image ...
_ 0.64 percent completed
```

5. Select **(0) Poweroff** so that the computer will power off when the process is finished.

```
Restoring the first 446 bytes of MBR data, i.e. executable code area, for sda... done!
*****
Now resize the partition for sda1
ntfsresize -f /dev/sda1
ntfsresize v2.0.0 (libntfs 10:0:0)
Device name      : /dev/sda1
NTFS volume version: 3.1
Cluster size     : 2048 bytes
Current volume size: 2064511488 bytes (2065 MB)
Current device size: 2064513024 bytes (2065 MB)
New volume size   : 2064511488 bytes (2065 MB)
Nothing to do: NTFS volume size is already OK.
*****
The grub directory is NOT found. Maybe it does not exist (so other boot manager exists) or the file
system is not supported in the kernel. Skip running grub-install.
*****
Found NTFS boot partition among the restored partition(s): /dev/sda1
Head and sector no. of /dev/sda from EDD: 64, 63.
The start sector of NTFS partition /dev/sda1: 63
Adjust filesystem geometry for the NTFS partition: /dev/sda1
Running: partclone.ntfsfixboot -w -h 64 -t 63 -s 63 /dev/sda1
ntfsfixboot version 0.9
done!
*****
*****
*****
This program is not started by Clonezilla server, so skip notifying it the job is done.
Finished!
Now syncing - flush filesystem buffers...

"ocs-live-restore" is finished.
Now you can choose to:
(0) Poweroff
(1) Reboot
(2) Enter command line prompt
(3) Start over
[2]
```

## Proactive Monitoring

---

The V2403 series supports the "Moxa Proactive Monitoring" utility. See the "Moxa Proactive Monitoring Windows Software User's Manual" for details. The manual can be found on the product CD/DVD or downloaded from Moxa's website. Note that the V2403 does not support hardware relay.