

**7014 Series
Industrial
Gigabit Ethernet Switch**

**User Manual &
Installation
Guide**

7014TX, 7014FX2, and 7014FXE2 Industrial Gigabit Ethernet Switch Installation Guide.....	7
Safety Warnings.....	8
Installation.....	10
Connecting the Unit.....	14
Overview of Advanced Features.....	18
Mode of Operation.....	18
Port Security.....	18
Port Mirroring.....	18
Port Trunking.....	18
Priority Tagging (QoS).....	19
Virtual LAN.....	19
Rapid Spanning Tree Protocol.....	19
SNMP Traps.....	20
IGMP Snooping.....	20
N-Ring.....	20
Web Software Configuration.....	22
Web Management.....	22
Web Management - Home.....	23
Administration – System.....	25
Administration – SNMP.....	26
Administration – Gigabit Ports.....	27
Ports – Configuration.....	28
Ports – Security.....	30
Ports – Intrusion Log.....	32
Ports – Mirroring.....	33
Ports – Trunking.....	34
Statistics – Port Statistics.....	36
Statistics – Port Utilization.....	37
VLAN – Ingress Filter.....	38
VLAN – Port Based.....	40
Bridging – Aging Time.....	44
Bridging – Unicast Addresses.....	45
Bridging – Multicast Addresses.....	47
RSTP – RSTP Configuration.....	49
IGMP – Configuration.....	52
IGMP – Show Group and Show Router.....	55
IGMP – RFilter.....	56
N-View – Configuration.....	58
N-View – Ports.....	59
N-Ring - Configuration.....	61
N-Ring – Status.....	66
Event Log – Log Statistics.....	70
Event Log – Show Events.....	71
Firmware/Config - TFTP.....	72
Firmware/Config - FTP.....	73
Support – Web Site and E-mail.....	74
BPCL – Broadcast Packet Count Limit Configuration.....	75
User Mgmt – Adding Users.....	77
User Mgmt – Removing Users.....	78
LogicalView.....	79
Configuration – Save or Reset.....	80
Help – Administration.....	82
Help – Ports.....	83
Help – Statistics.....	84
Help – VLAN.....	85

Help – BPCL	86
Help – IGMP	87
Help – Bridging	88
Help – RSTP	89
Help – Event Log	90
Help – Firmware/Config	91
Help – Logical View	92
Help – User Mgmt.....	93
Help – N-View	94
Help – N-Ring	95
Help – Others	96
CLI Commands	97
Clear	97
“?” (HELP).....	97
Top	98
Up.....	98
Logout	98
History.....	99
“!”	100
“\$”	101
Whoami	101
Ping	101
System Configuration Commands	102
Set Mode IP config.....	102
Set IP/Subnet/Gateway Addresses of the system	102
Get IP Address of the system	102
Set System Name	102
Get System Name.....	103
Get Gateway Address of the System	103
Get Mac Address of the System	103
Get Netmask of the System	103
Get System Contact	103
Set System Contact	104
Get System Location	104
Set System Location.....	104
Get System Uptime	104
Get Number of Ports present in the System	104
Set System Gigabit.....	104
Set IP Address of the SNMP Manager	105
Set SNMP Get Community name	105
Set SNMP Set Community name	105
Set SNMP Trap Community name.....	105
Show all configuration parameters.....	106
Show all configuration parameters related to SNMP manager	106
System Restart.....	106
User Management Commands	107
Show System Users	107
Add a System User.....	107
Modify a User’s Access Permissions	107
Modify a User’s Password	108
Remove a System User	108
Image Loader Commands	108
Download Image through COM port	108
TFTP Commands	109
Set the TFTP configuration parameter	109
Show TFTP configuration parameters.....	109
Download file from TFTP server	109
FTP Commands.....	110

Set Username	110
Set Password	110
Set IP Address of FTP server	110
Set Name of the Remote File	110
Display FTP related configuration parameters	111
Perform the configuration file transfer action	111
Perform the image file transfer action	111
Port Manager Commands.....	112
Get the link state of a given port	112
Get admin status of the port	112
Set admin status of a port	112
Show port statistics	113
Get total number of good frames received	113
Get port speed	113
Set Port Speed	114
Get the port duplex mode	114
Set the port duplex mode.....	114
Set the Lockstate of a given port	114
Get Lock State.....	115
Get Auto-negotiation State	115
Set Auto-negotiation State	115
Set Priority State	115
Set Flow Control	116
Set Name	116
Set PVID	116
Set Backpressure	116
Set Intruderstate	116
Set Priority Level	117
Show Configuration	117
Show Intruders	117
Show Link Utilization	117
Get Flow Control.....	117
Get Name	117
Get State Of Priority.....	118
Get Intruder State	118
Get Priority Level.....	118
Get STP Status	118
Get Back Pressure	118
Get PVID.....	119
Clear Counters.....	119
Clear Intruder Log.....	119
Trunk related commands.....	120
Enable or disableTrunking	120
Modify Trunk	120
Create Trunk.....	120
Delete Trunk.....	120
Show Trunk Information.....	121
Mirroring related commands.....	122
Set Mirror config.....	122
Enable or Disable Port Mirroring	122
Show Mirror config.....	122
VLAN Related Commands	123
Add VLAN Entry	123
Show List of Configured VLANs	123
Display Information of a particular VLAN	124
Modify an existing VLAN	124
Delete VLAN	125
Set VLAN as management VLAN	125

Set VLAN to defaults	125
Set VLAN Ingress Filter	125
Get VLAN Ingress Filter	125
Get VLAN info	126
Eventlog Related Commands	127
Get Eventlog count	127
Get Eventlog level	127
Get Eventlog size	127
Set Eventlog level	127
Set Eventlog size	127
Show Eventlog events	128
Bridging Related Commands	129
Add Multicast MAC Address	129
Delete Multicast MAC Address	129
Add a Unicast MAC Address	129
Delete Unicast MAC Address	129
Display List of Configured Static MAC Addresses	130
Set Aging Time	130
Display Current Aging Time	130
Display Mac Address by port	130
Display port by Mac Address	130
Display Mac count	131
IGMP Related Commands	132
Enable IGMP	132
Disable IGMP	132
Show IGMP config	132
Show IGMP group	132
Show IGMP router	133
Set IGMP query mode	133
Set IGMP router port	133
Set IGMP router mode	133
Show IGMP rfilter mode	133
Set IGMP rfilter mode	134
N-Ring Related Commands	135
N-Ring get agingtime	135
N-Ring set agingtime	135
N-Ring get webfault	135
N-Ring set webfault	135
N-Ring get interval	136
N-Ring set interval	136
N-Ring get mode	136
N-Ring set mode	136
N-Ring show status	137
N-Ring show switch	138
N-Ring set keepalive	138
N-Ring get keepalive	138
Configuration Related Commands	139
Save Configuration	139
Load Default Configuration	139
Configuration Upload	139
Server-IpAddress	139
File-Name	139
Configuration Download	139
Server-IpAddress	139
File-Name	139
Rapid Spanning Tree Protocol Related Commands	140
Set RSTP Admin Edge	140

Get RSTP Admin Edge	140
Set RSTP Auto Edge	140
Get RSTP Auto Edge	140
Set RSTP Bridge Admin Status.....	141
Get RSTP Bridge Admin Status	141
Set RSTP Bridge Forward Delay	141
Get RSTP Bridge Forward Delay.....	141
Set RSTP Bridge Hello Time	142
Get RSTP Bridge Hello Time	142
Set RSTP Bridge Max Age	142
Get RSTP Bridge Max Age.....	142
Set RSTP Bridge Priority	143
Get RSTP Bridge Priority	143
Set RSTP Port Path Cost	143
Get RSTP Port Path Cost	143
Set RSTP Port Priority	144
Get RSTP Port Priority.....	144
Broadcast Packet Count Limit Commands	145
Get the Broadcast Packet Count Limit for one port	145
Get the Broadcast Packet Count Limit for all ports.....	145
Set the Broadcast Packet Count Limit.....	145
VLAN Configuration Examples	146
Example 1 – Basic understanding of port based VLANs	146
Example 2 – Basic understanding of tagged VLANs (Admit – Tagged Only)	146
Example 3 – Basic understanding of tagged VLANs (Admit – All)	147
Example 4 – Basic understanding of Hybrid VLANs	147
Example 5 – Basic understanding of Overlapping VLANs.....	148
Example 6 – Basic understanding of VLANs with Multicast Filtering.....	149
N-TRON Limited Warranty.....	152

7014TX, 7014FX2, and 7014FXE2 Industrial Gigabit Ethernet Switch Installation Guide



The N-TRON 7014 Series Gigabit compatible Industrial Ethernet Switch offers outstanding performance and ease of use. It is ideally suited for connecting Ethernet enabled industrial and or security equipment and is a fully managed switch.

PRODUCT FEATURES

- Full IEEE 802.3 Compliance
- Ten 10/100 BaseTX RJ-45 Ports
- Twelve 10/100 BaseTX RJ-45 Ports (7014TX model only)
- Two Optional Gigabit ports:
 - 1000BaseSX/LX Ports, LC style, and/or
 - 1000BaseT Ports, RJ45 style
- Two Optional 100BaseFX(E) Ports (7014FX2 and 7014 FXE2 models only)
- Extended Environmental Specifications
- Autosensing 10/100BaseTX, Duplex, and MDIX
- Offers Rapid Spanning Tree Protocol
- Trunk with other N-Tron trunking capable switches
- Store & Forward Technology
- Plug and Play IGMP Support
- Rugged Din-Rail Enclosure
- Redundant Power Inputs (10-30 VDC)
- Full SNMP
- Web Browsing and N-View Switch Monitoring

PRODUCT CONFIGURATIONS

- 7014TX – Twelve 10/100 Base-TX RJ45 Copper Ports, and two optional SFP transceivers
- 7014FX2 – Ten 10/100 Base-TX RJ45 Copper Ports, two multimode 100BaseFX Ports (SC or ST), and two optional SFP transceivers
- 7014FXE2 – Ten 10/100 Base-TX RJ45 Copper Ports, two singlemode 100BaseFX Ports (ST or SC) (15, 40, or 80 km) and two optional SFP transceivers

MANAGEMENT FEATURES

- IGMP Snooping
- VLAN
- QoS
- Trunking
- Mirroring
- 802.1D-2004 Rapid Spanning Tree
- N-RING™ (N-Tron proprietary Ring Management)



All rights reserved. Reproduction, adaptation, or translation without prior written permission from N-Tron Corp. is prohibited, except as allowed under copyright laws.

Ethernet is a registered trademark of Xerox Corporation. All other product names, company names, logos or other designations mentioned herein are trademarks of their respective owners.

The information contained in this document is subject to change without notice. N-Tron Corp. makes no warranty of any kind with regard to this material, including, but not limited to, the implied warranties of merchantability or fitness for a particular purpose. In no event shall N-Tron Corp. be liable for any incidental, special, indirect, or consequential damages whatsoever included but not limited to lost profits arising out of errors or omissions in this manual or the information contained herein.

Warning

Do not perform any services on the unit unless qualified to do so. Do not substitute unauthorized parts or make unauthorized modifications to the unit.

Do not operate the unit with the top cover removed, as this could create a shock or fire hazard.

Do not block the air vents on the sides or the top of the unit.

Do not operate the equipment in the presence of flammable gasses or fumes. Operating electrical equipment in such an environment constitutes a definite safety hazard.

Do not operate the equipment in a manner not specified by this manual.

Safety Warnings

GENERAL SAFETY

WARNING: If the equipment is used in the manner not specified by N-Tron Corp., the protection provided by the equipment may be impaired.

LASER SAFETY (FXE Models -40, -80 and optional SFP-LX -40, -70 and -80)



CAUTION: CLASS 1 LASER PRODUCT. Do not stare into the laser!

Contact Information

N-Tron Corp.
820 South University Blvd.
Suite 4E
Mobile, AL 36609
TEL: (251) 342-2164
FAX: (251) 342-6353
WEBSITE: www.n-tron.com
E-MAIL: N-TRON_Support@n-tron.com

ENVIRONMENTAL SAFETY



WARNING: Disconnect the power and allow to cool 5 minutes before touching.

ELECTRICAL SAFETY



WARNING: Disconnect the power cable before removing any modules, or any enclosure panel.

WARNING: Do not operate the unit with the any cover removed.

WARNING: Properly ground the unit before connecting anything else to the unit. Units not properly grounded may result in a safety risk and could be hazardous and may void the warranty. See the grounding technique section of this user manual for proper ways to ground the unit.

WARNING: Do not work on equipment or cables during periods of lightning activity.

WARNING: Do not perform any services on the unit unless qualified to do so.

WARNING: Do not block the air vents.

WARNING: Observe proper DC Voltage polarity when installing power input cables. Reversing voltage polarity can cause permanent damage to the unit and void the warranty.

7014 Series Hazardous Location Installation Requirements

1. **WARNING:** Explosion Hazard, do not disconnect while circuit is live, unless area is known to be non-hazardous.
2. **WARNING:** Explosion Hazard - do not replace the device unless power has been switched off or the area is know to be non-hazardous.
3. **WARNING:** Input and output wiring must be in accordance with Class I, Div 2, and in accordance with Local & National Codes of Authorities Having Jurisdiction.
4. **WARNING:** Explosion Hazard – Substitution of components may impair suitability For Class I, Div. 2.
5. This equipment is suitable for use in Class I, Div. 2, Groups A, B, C, D or non-hazardous locations only.
6. Power must be supplied by an isolating source, and a 3.0 A max rated UL recognized fuse must be installed immediately before the unit.
7. Class I, Div 2 installations require that all devices connected to this product must be UL listed for the area in which it is installed.
8. Use 60/75°C rated Copper wire, (0.22Nm) 2 inch-lbs Tightening torque for field installed conductors.

PACKAGE CONTENTS

Please make sure the 7014 Series Gigabit Ethernet Switch package contains the following items:

1. 7014 Series Switch
2. Product CD

Contact your carrier if any items are damaged.

Installation

Read the following warning before beginning the installation:

WARNING

Never install or work on electrical equipment or cabling during periods of lightning activity. Never connect or disconnect power when hazardous gasses are present.



Disconnect the power cable before removing any enclosure panel.

UNPACKING

Remove all the equipment from the packaging, and store the packaging in a safe place. File any damage claims with the carrier.

CLEANING

Clean only with a damp cloth.

DIN RAIL MOUNTING

Install the unit on a standard 35mm Din-Rail. Recess the 7014TX unit to allow at least 3" of horizontal clearance for fiber cable bend radius. Recess the 7014FX2 unit to allow at least 5" of horizontal clearance for fiber cable bend radius.

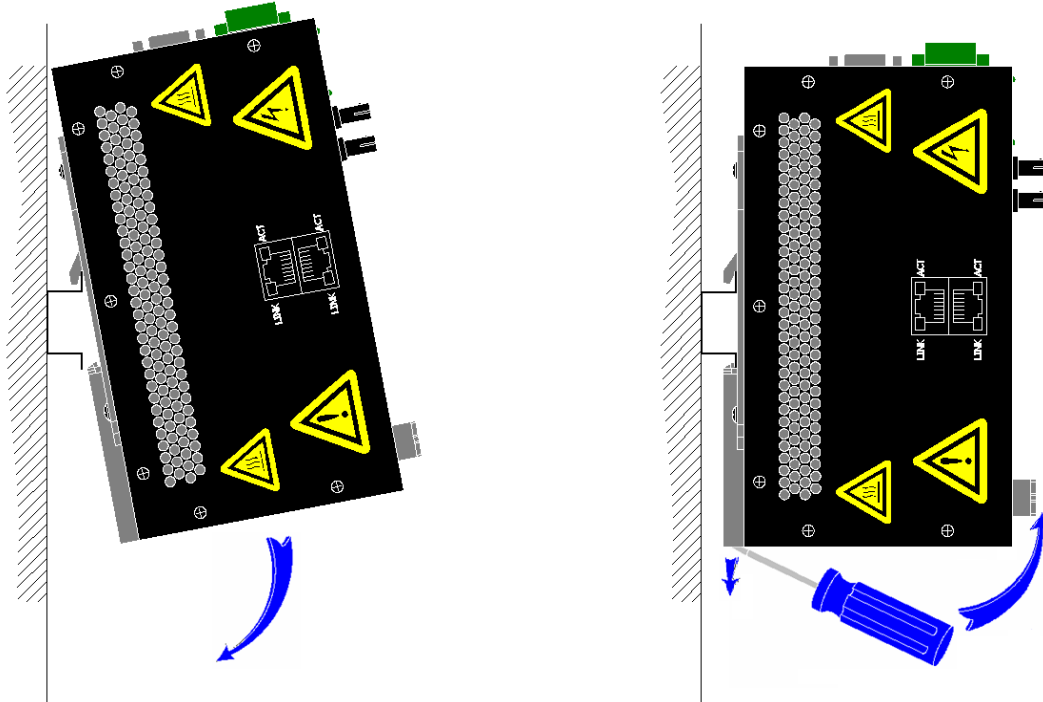

To mount the unit to the 35mm din-rail, place top edge of the bracket on the back of the unit against the din-rail at an upward angle. Lower the bottom of the unit until it snaps into place.

Note: When mounting the switch in the vertical position, you must orientate the power connector to the top as shown above for proper ventilation.

To remove the unit from the 35mm din-rail, place a flat head screwdriver into the release clip at the bottom of the unit, and push down on the clip until it disengages from the bottom of the unit from the din-rail. Lift the bottom of the unit up at an approximate 45° upward angle to completely remove the unit.

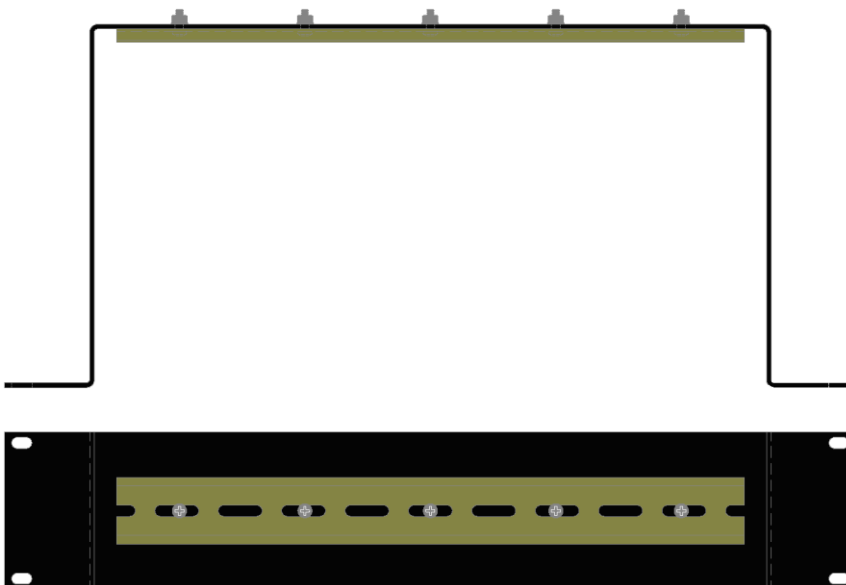

Most N-Tron™ products are designed to be mounted on industry standard 35mm DIN-Rail. However, DIN-Rail mounting may not be suitable for all applications. Our Universal Rack Mount Kit (P/N: URMK) may be used to mount the 7014 Series to standard 19" racks as an option.

FRONT PANEL

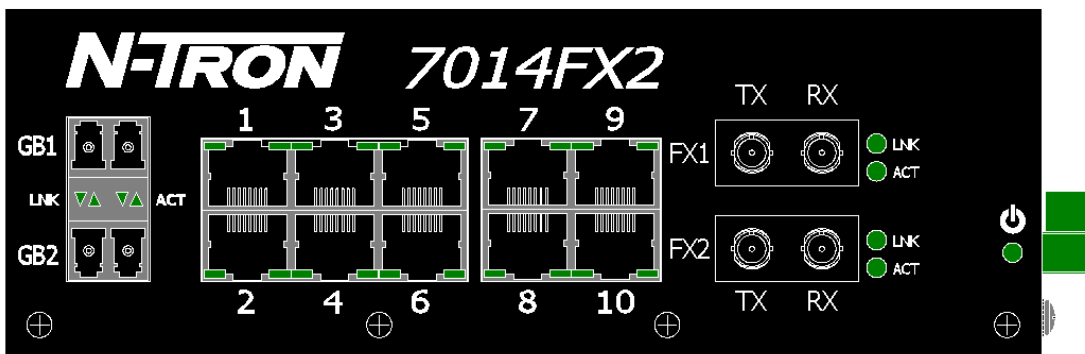
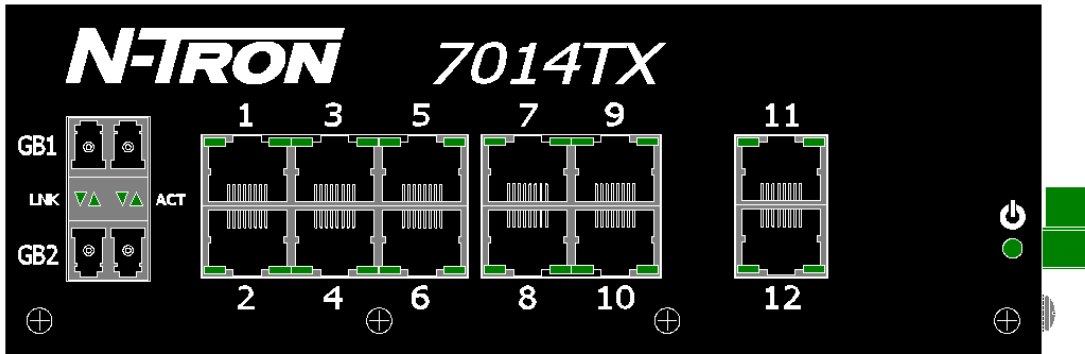

From Top to Left:

Gigabit Ports	1000 Base SFP Copper or Fiber Transceivers (Optional)
RJ45 Ports	Auto Sensing 10/100 Base-TX Connections
Fiber Ports	100 Base-FX Connections (only on 7014FX2 model)
	Green LED lights when Power is supplied to the unit

NOTE: The RJ45 data port has two LED's located on each connector. The left LED indicates LINK status, and the right LED indicates ACTIVITY.

LED's: The table below describes the operating modes:

LED	Color	Description
	GREEN	Power is Applied
	OFF	Power is OFF
LNK	GREEN	10/100/1000Mb Link between ports
	OFF	No Link between ports
ACT	GREEN	Data is active between ports
	OFF	Data is inactive between ports

APPLYING POWER (Side View)

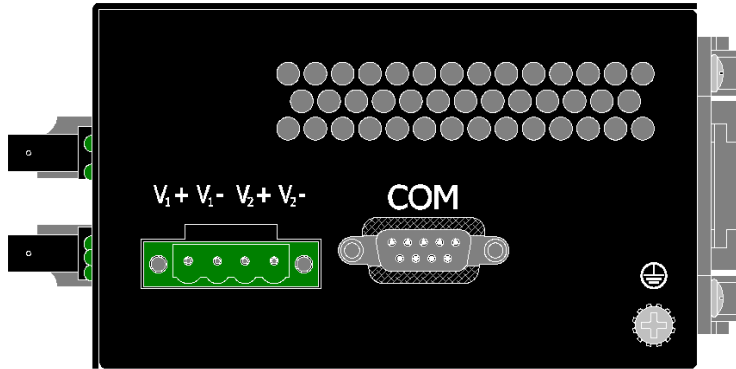

- Unscrew & Remove the DC Voltage Input Plug from the Power Input Header
- Install the DC Power Cables into the Plug (observing polarity).
- **For best results keep the power cable length to a maximum of one (1) meter.**
- Plug the Voltage Input Plug back into the Power Input Header.
- Tightening torque for the terminal block power plug is **0.5 Nm/0.368 Pound Foot.**
- Verify the Power LED stays ON (GREEN).

Note: Only 1 power supply must be connected to power for minimal operation. For redundant power operation, V_1 and V_2 inputs must be connected to separate DC Voltage sources. This device will draw current from both sources simultaneously. Use 16-28 gauge wire when connecting to the power supply.

Recommended 24V DC Power Supplies, similar to: N-Tron's P/N **NTPS-24-3**

- Input AC 115/230V
- Output DC 24-28V
- Output Current 3A @ 24V
2.6A @ 28V
- Power 30W
- 35 mm DIN-Rail Mountable
- Dimensions: 45X75X91 mm

Connecting the Unit

For FX/FXE units, remove the dust cap from the fiber optic connectors and connect the fiber optic cables. The TX port on the FX/FXE models should be connected to the RX port of the far end station. The RX port on the FX/FXE versions should be connected to the TX port of the far end station.

For 10/100 Base-TX ports, plug a Category 5E twisted pair cable into the RJ45 connector. Connect the other end to the far end station. Verify that the LNK LED's are ON once the connection has been completed. To connect any port to another device (end node, Switch or Repeater), use a standard Category 5E straight through or crossover cable with a minimum length of one meter and a maximum length of 100 meters..

N-Tron recommends the use of pre-manufactured Cat5E cables to ensure the best performance. If this is not an option and users must terminate their own ends on the Cat5E cables; one of the two color coded standards shown to the right should be utilized. If a user does not follow one of these two color code standards then the performance and maximum cable distance will be reduced significantly, and may prevent the switch from establishing a link.

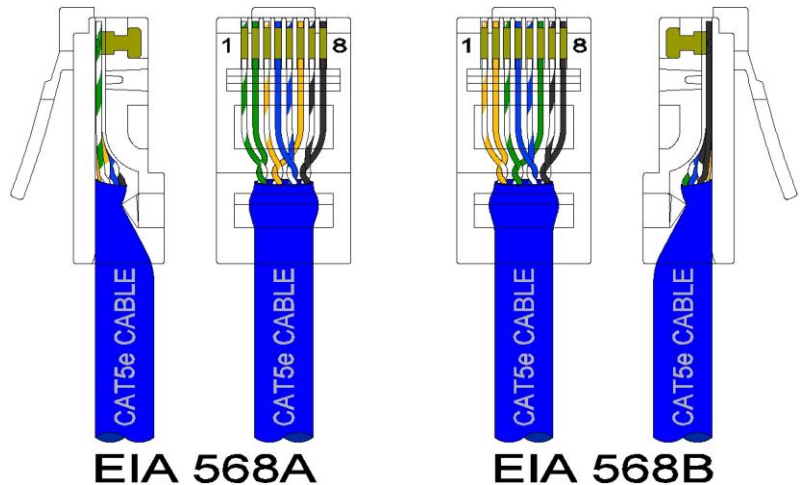

Warning: In absence of RSTP or Proprietary Ring control on the specific ports connected, creating a port to port connection on the same switch (i.e. loop) is an illegal operation and will create a broadcast storm which will crash the network!

N-TRON SWITCH GROUNDING TECHNIQUES

The grounding philosophy of any control system is an integral part of the design. N-Tron switches are designed to be grounded, but the user has been given the flexibility to float the switch when required. The best noise immunity and emissions (i.e. CE) are obtained when the N-Tron switch chassis is connected to earth ground via a drain wire. Some N-Tron switches have metal din-rail brackets that can ground the switch if the din-rail is grounded. In some cases, N-Tron switches with metal brackets can be supplied with optional plastic brackets if isolation is required.

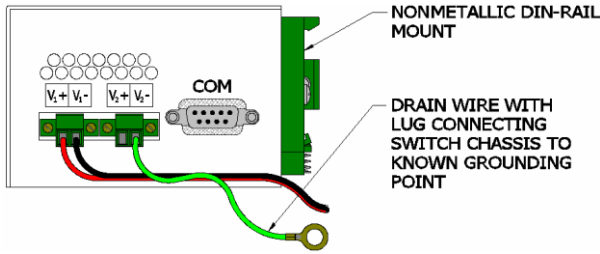

Both V- legs of the power input connector are connected to chassis internally on the PCB. Connecting a drain wire to earth ground from one of the V- terminal plugs as shown here will ground the switch and the chassis. The power leads from the power source should be limited to 3 meters or less in length.

As an alternate, users can run a drain wire & lug from any of the Din-Rail screws or empty PEM nuts on the enclosure. When using an unused PEM nut to connect a ground lug via a machine screw, care should be taken to limit the penetration of the outer skin by less than 1/4 in. Failure to do so may cause irreversible damage to the internal components of the switch.

Note: Before applying power to the grounded switch, you must use a volt meter to verify there is no voltage difference between the power supply's negative output terminal and the switch chassis grounding point.

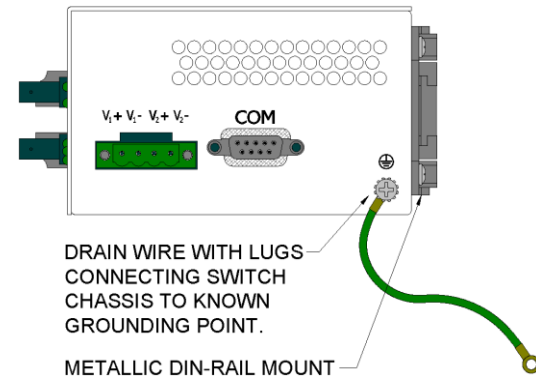

If the use of shielded cables is required, it is generally recommended to only connect the shield at one end to prevent ground loops and interfere with low level signals (i.e. thermocouples, RTD, etc.). Cat5e cables manufactured to EIA-568A or 568B specifications are required for use with N-Tron Switches.



In the event all Cat5e patch cable distances are small (i.e. All Ethernet devices are located the same local cabinet and/or referenced to the same earth ground), it is permissible to use fully shielded cables terminated to chassis ground at both ends in systems void of low level analog signals.

CAT5 CABLE CRIMP SPECIFICATIONS

Please reference the illustration below for your Cat5 cable specifications:

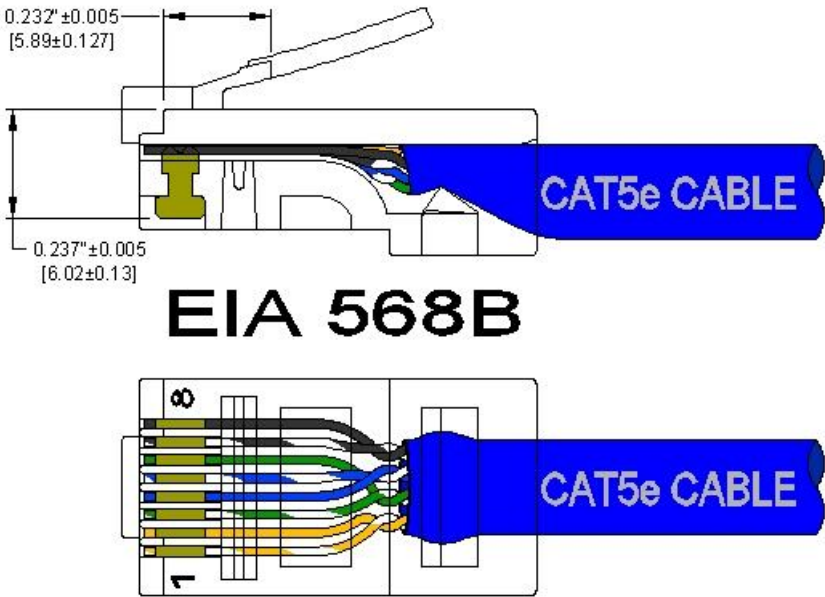

SERIAL INTERFACE

The 7014 Series switches provide an EIA-232 interface accessed via a 9 pin female connector (labeled 'COM' on the unit). This is used to access the Command Line Interpreter (CLI). The pin-outs are shown below:

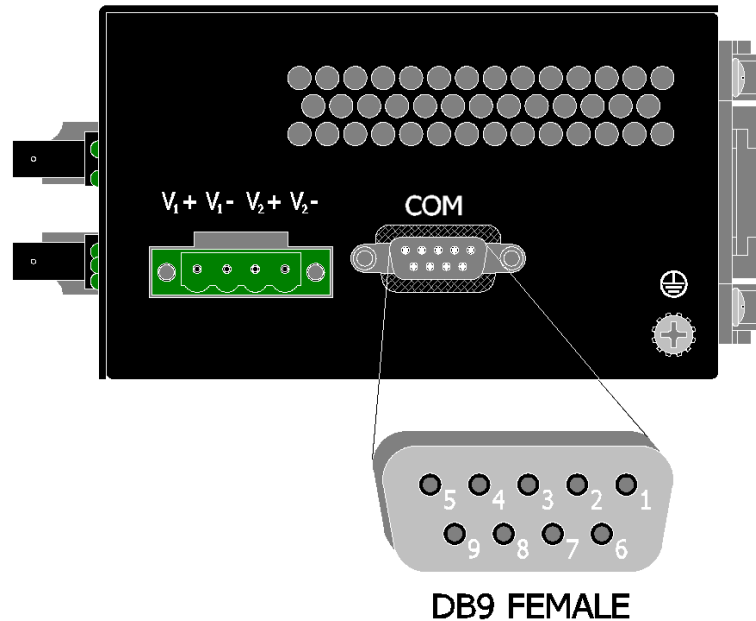

Serial Cable

Connect the serial COM port of your PC and the 7014 Series Switch using a standard straight through cable. You will require a cable with a 9-pin or 25-pin sub-D female connector for the PC end, and a 9-pin male sub-D connector for the 7014 Series end.

The following table shows the pin-out and the connections for both types of cable:

PC Port	25-Pin Female	9-Pin Female	7014 series 9-Pin Male	
Signal Name	Pin #	Pin #	Pin #	Signal Name
TXD	2	3	3	RXD
RXD	3	2	2	TXD
GND	7	5	5	GND

Shielded cables and null modems are readily available from Radio Shack or a variety of computer stores.

HyperTerminal

The following configuration should be used in HyperTerminal:

Port Settings: 115200
 Data Bits: 8
 Parity: None
 Stop bits: 1
 Flow Control: None

Overview of Advanced Features

Mode of Operation

Each port on the switch can be configured into different modes of operation as shown below:

Copper Ports:

- Half Duplex
- Full Duplex
- Auto Negotiation

100Base Fiber Ports:

- Full Duplex

1000Base Copper/Fiber Ports:

- Full Duplex

Half Duplex

In half duplex mode, the CSMA/CD media access method is the means by which two or more stations share a common transmission medium. To transmit, a station waits (defers) for a quiet period on the medium (that is, no other station is transmitting) and then sends the intended message in bit-serial form. If, after initiating a transmission, the message collides with that of another station, then each transmitting station intentionally transmits for an additional predefined period to ensure propagation of the collision throughout the system. The station remains silent for a random amount of time (backoff) before attempting to transmit again.

Full Duplex

Full duplex operation allows simultaneous communication between a pair of stations using point-to-point media (dedicated channel). Full duplex operation does not require that transmitters defer, nor do they monitor or react to receive activity, as there is no contention for a shared medium in this mode.

Auto Negotiation

In Auto Negotiation mode the port / hardware detects the mode of operation of the station that is connected to this port and sets its mode to match the mode that of the station.

Port Security

Port Security provides a mechanism to detect any intruder in the network. When security is enabled on the port, the port stops learning new MAC addresses on that port and if it receives any packet with a source MAC address that is not in the address table, the packet will be discarded.

Port Mirroring

A Mirroring Port is a dedicated port that is configured to receive the copies of Ethernet frames that are being transmitted out and also being received in from any other port that is being monitored.

Port Trunking

Port Trunking is the ability to group two or more network ports to increase the bandwidth between two machines (switch or any work station). This feature allows grouping of high-speed connectivity and provides redundant connection between switches, so that trunk can act as a single link between the switches.

Priority Tagging (QoS)

IEEE 802.1p priority tagging is supported for two classes of services along with bandwidth support per priority level. Transparent mode is supported through configuration wherein if the field is set, the tag bits are ignored. The User can configure up to 8 different priority levels per port. Also priority overriding (overriding the tagged field) can be enabled or disabled by the user.

Virtual LAN

The switch provides support for setting up both tagged Virtual LANs and port based Virtual LANs. A port may belong to any number of Virtual LANs. The VLAN membership of a station is determined by the VLAN(s) that have been defined for the port to which the station is connected. If a station should move from one port to another, it loses its current VLAN membership and inherits that of the new port it is connected to.

A Default Virtual LAN exists to which a port, which is not a member of any other Virtual LAN, will belong. This allows the switch to operate as a 'normal' Bridge when it is used in a network. A port is automatically removed from the Default VLAN when it is reconfigured to belong to another Virtual LAN.

Using Tagged VLANs the switch has the ability to take non-tagged packets in some ports, add a VLAN tag to the packet and send it out tagged ports on the switch. The VLANs can also be configured to accept tagged packets in tagged ports, strip the tags off the packets, and send the packets back out other untagged ports. This allows a network administrator to set up the switch so he can support devices on the network that do not support VLAN Tagged packets. The administrator can also set up the ports to discard any packets that are tagged or to discard any packets that are untagged based on a hybrid VLAN of both tagged and untagged ports, and using the VLAN Ingress Filter on the switch.

The 7014 Series switch also has the ability to allow overlapping VLANs. Overlapping VLANs gives the user the ability to have one or more ports share two or more VLAN groups. For more information and examples on how this could be implemented please see our website's technical documents.

Rapid Spanning Tree Protocol

The rapid spanning tree protocol as specified in IEEE 802.1D-2004 is supported. One Spanning Tree per a unit is supported. Besides a Spanning Tree per VLAN is also supported.

The Rapid Spanning Tree Protocol (RSTP) supersedes the Spanning Tree Protocol (STP) which was described in IEEE 802.1D-1998. The RSTP is used to configure a simply connected active network topology from the arbitrarily connected bridges of a bridged network. Bridges effectively connect just the LANs to which their forwarding ports are attached. Ports that are in a blocking state do not forward frames. The bridges in the network exchange sufficient information to automatically derive a spanning tree. RSTP allows for much quicker learning of network topology changes than the older STP. RSTP supports new and improved features such as rapid transition to forwarding state. RSTP also sends out new BPDUs every hello time instead of just relaying them. RSTP interoperates with older STP switches by falling back to the older STP when the older BPDUs are detected on bridge ports. The user can also manually configure bridge ports to use the older STP when desired.

SNMP Traps

The 7014 Series switch supports up to 5 SNMP Trap Stations to which SNMP Traps will be sent. The switch supports three standard traps; Link Up, Link Down, and Cold Start. SNMP Traps will be sent to all the stations configured on the switch if a port Link goes up or down, and when the switch first powers up.

IGMP Snooping

IGMP Snooping is enabled by default, and the switch is *Plug and Play* for IGMP. IGMP snooping provides intelligent network support for multicast applications. In particular, unneeded traffic is reduced. IGMP Snooping is configured via the console and if enabled, then operates dynamically upon each power up. Also, there can be manual only or manual and dynamic operation. Note that “static multicast group address” can be used whether IGMP Snooping is enabled or not.

IGMP Snooping will function dynamically without user intervention. If some of the devices in the LAN do not understand IGMP, then manual settings are provided to accommodate them. The Internet Group Management Protocol (IGMP) is a protocol that provides a way for a computer to report its multicast group membership to adjacent ‘routers’. In this case N-Tron 7014 series switches provide *router-like functionality*. Multicasting allows one computer to send content to multiple other computers that have identified themselves as interested in receiving the originating computer's content. Multicasting can be used to transmit only to an audience that has joined (and not left) a multicast group membership. IGMP version 2 is formally described in the Internet Engineering Task Force (IETF) Request for Comments (RFC) 2236. IGMP version 1 is formally described in the Internet Engineering Task Force (IETF) Request for Comments (RFC) 1112. The 7014 series supports v1 and v2.

N-Ring

N-Ring is enabled by default, and the switch is *Plug and Play* for N-Ring except that initially one must enable an N-Ring enabled device to be the N-Ring Manager for a given N-Ring. Subsequently, N-Ring operates dynamically upon each power up. Using N-Tron's proprietary N-Ring technology offers expanded ring size capacity, detailed fault diagnostics, and a standard healing time of 30ms. The N-Ring Manager periodically checks the health of the N-Ring via health check packets. If the N-Ring Manager stops receiving the health check packets, it times out and converts the N-Ring to a backbone within 30ms. When using all N-Ring enabled switches in the ring, a detailed ring map and fault location chart is also provided on the N-Ring Manager's web browser. N-Ring status is also sent from the N-Ring Manager to the N-View OPC Server to identify the health status of the ring. Up to 250 N-Ring enabled switches can participate in one N-Ring topology. Switches that do not have N-Ring capability may be used in an N-Ring, however the ring map and fault location chart cannot be as detailed at these locations.

TROUBLESHOOTING

1. Make sure the  (Power LED) is ON.
2. Make sure you are supplying sufficient current for the version chosen. Note: The Inrush current will exceed the steady state current by ~ 2X.
3. Verify that Link LED's are ON for connected ports.
4. Verify cabling used between stations.
5. Verify that cabling is Category 5E or greater for 100Mbit Operation.

SUPPORT

Contact N-Tron Corp. at:
TEL: 251-342-2164
FAX: 251-342-6353
E-MAIL: N-TRON_Support@n-tron.com
WEB: www.n-tron.com

FCC STATEMENT

This product complies with Part 15 of the FCC-A Rules.

Operation is subject to the following conditions:

- (1) This device may not cause harmful Interference
- (2) This device must accept any interference received, including interference that may cause undesired operation.

NOTE: This equipment has been tested and found to comply with the limits for a Class A digital device, pursuant to Part 15 of the FCC Rules. These limits are designed to provide reasonable protection against harmful interference in a residential installation. This equipment generates, uses, and can radiate radio frequency energy and, if not installed and used in accordance with the instructions, may cause harmful interference to radio communications. Operation of this device in a residential area is likely to cause harmful interference in which case the user will be required to correct the interference at his own expense.

INDUSTRY CANADA

This Class A digital apparatus meets all requirements of the Canadian Interference Causing Equipment Regulations. Operation is subject to the following two conditions; (1) this device digital apparatus meets all requirements of the Canadian Interference Causing Equipment Regulations. Operation is subject to the following two conditions; (1) this device may not cause harmful interference, and (2) this device must accept any interference received, including interference that may cause undesired operation.

Cet appareillage numérique de la classe A répond à toutes les exigences de l'interférence canadienne causant des règlements d'équipement. L'opération est sujette aux deux conditions suivantes: (1) ce dispositif peut ne pas causer l'interférence nocive, et (2) ce dispositif doit accepter n'importe quelle interférence reçue, y compris l'interférence qui peut causer l'opération peu désirée.

Web Software Configuration

Web Management

Enter the switch's IP address in any web browser and login to the web management feature of the 7014 Series.

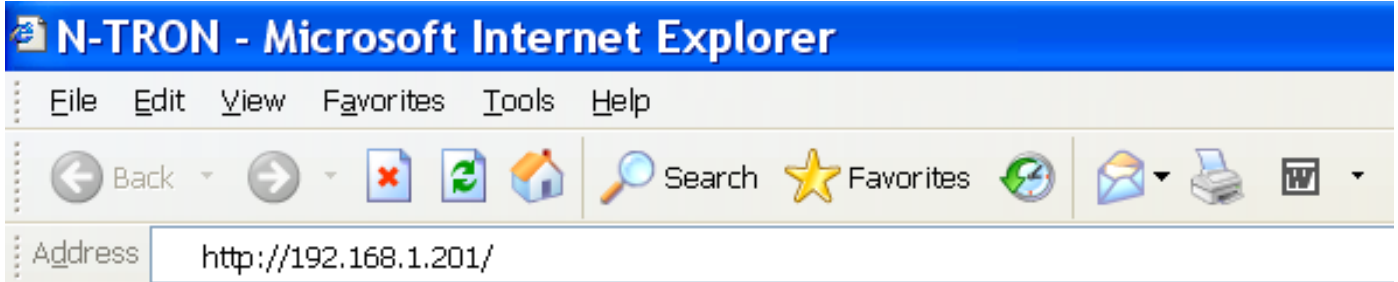

Default:

User Name: *admin*

Password: *admin*

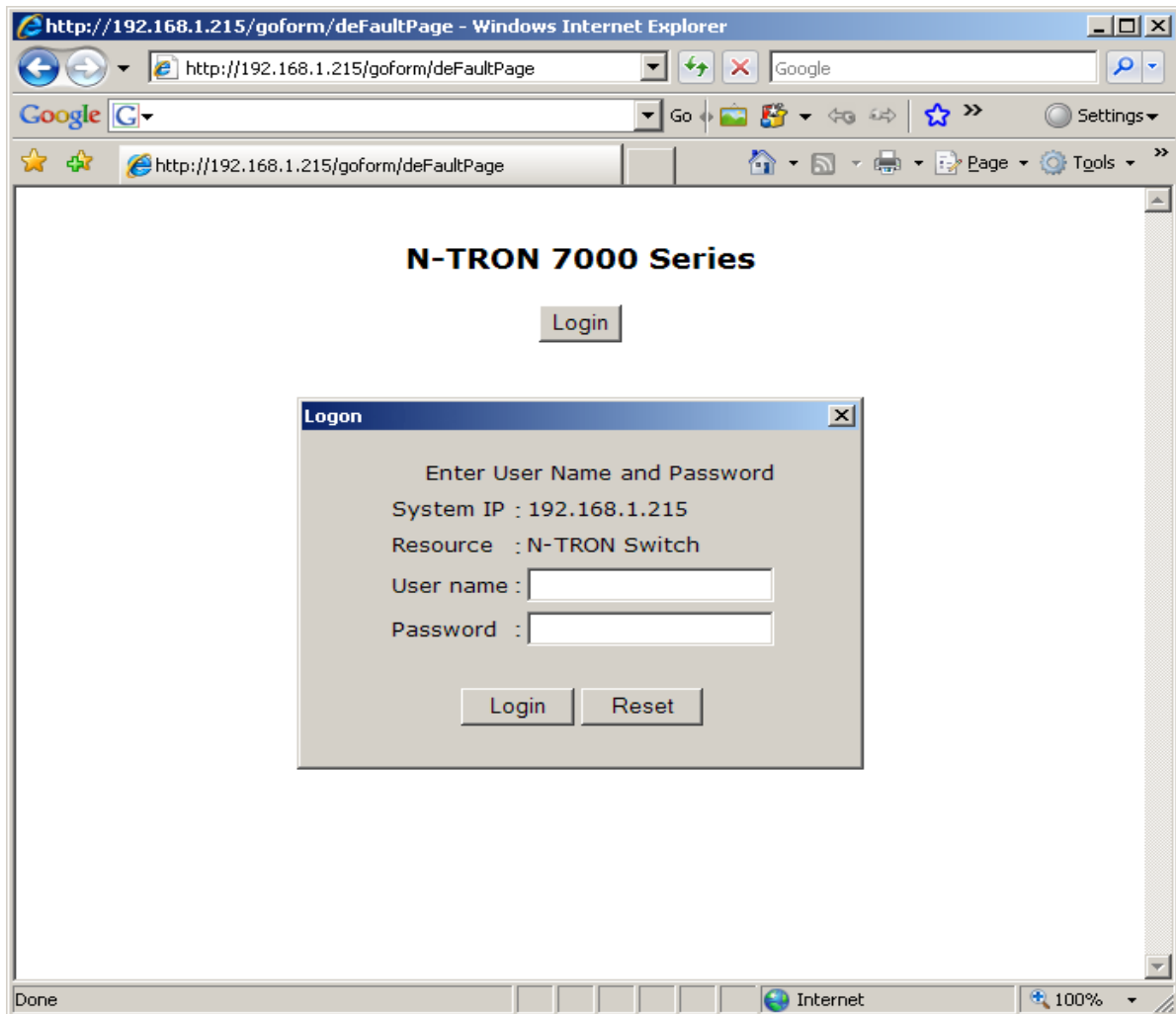

Web Management - Home

When the administrator first logs onto a 7014 Series switch the default home page will be displayed. On the left hand side of the screen there is a list of configurable settings that the 7014 Series switch will support. This section of the manual will go through each and every choice listed on the left hand side of the screen and explain how to configure those settings. In the center of the main home page the administrator can see some basic information like what firmware revision the switch is running. The firmware can be upgraded at a later time in the field using TFTP or FTP.

http://192.168.1.244/goform/successfulValidation - Windows Internet Explorer

http://192.168.1.244/goform/successfulValidation

File Edit View Favorites Tools Help

N-TRON
THE INDUSTRIAL NETWORK COMPANY

- Administration
- Ports
- Statistics
- VLAN
- Bridging
- RSTP
- IGMP
- N-View
- N-Ring
- EventLog
- Firmware/Config
- Support
- BPCL
- User Mgmt
- LogicalView
- Home
- Config
- Help
- Logout

©Copyright 2006-2007
by N-TRON Corp.
<http://www.n-tron.com>

Product Information

Product Name	-- N-TRON 7000 Series
Product Configuration	-- 7014FX2
Product Software Version	-- 1.1.8
Product Build Date	-- Jun 26 2007 at 13:05:31
Product Copyright	-- N-TRON Corp.
Product URL	-- http://www.n-tron.com

Web Management – Menu Structure

To the left, there is a menu which is shown fully opened below. The pages opened by each of the individual selections are described in the rest of this section. The use of each of these pages is also described in this section. In most of the descriptions, only the right side of the page is shown.

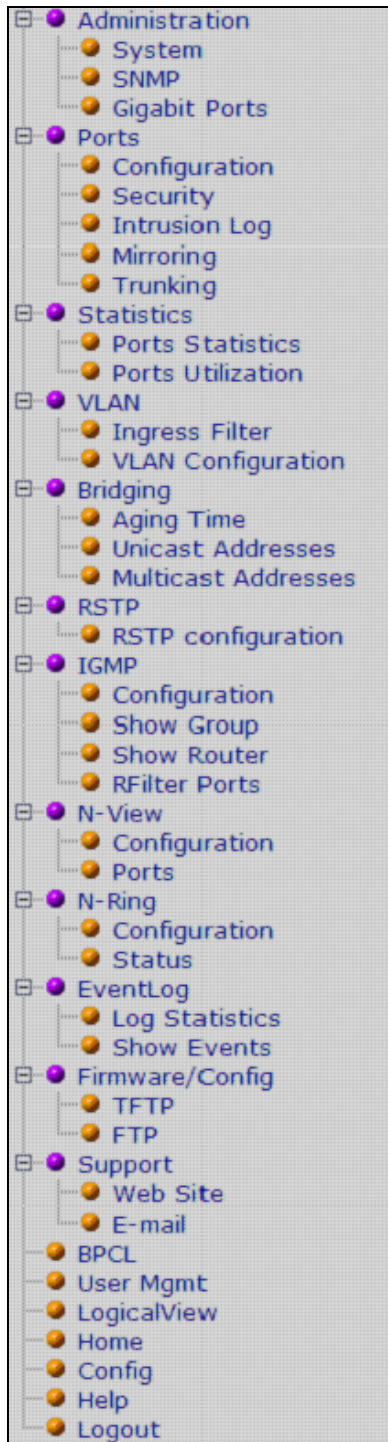

Administration – System

The System tab under the Administration category lists the following information about the switch:

- IP Address
- Subnet Mask
- Default Gateway
- MAC Address
- System Up Time
- Name
- Contact Information
- Location

IP Address	192.168.1.201
Subnet Mask	255.255.255.0
Gateway	192.168.1.1
MAC Address	00:07:af:00:c2:00
Sys Up Time	0 days:1 hours:41 mins:20 secs
Name	N-TRON Switch
Contact	N-TRON Admin
Location	Mobile, AL 36609

By selecting the modify button you will be able to change the switch's IP Address, Subnet Mask, Default Gateway, Name, Contact information, and the Location of the switch through the web management features. It is recommended to change the TCP/IP information through the Command Line Interface (CLI) initially, but it defaults to the following:

- IP Address – 192.168.1.201
- Subnet Mask – 255.255.255.0
- Default Gateway – 192.168.1.1

IP Address	<input type="text" value="192.168.1.201"/>
Net Mask	<input type="text" value="255.255.255.0"/>
Gateway	<input type="text" value="192.168.1.1"/>
Name	<input type="text" value="N-TRON Switch"/>
Contact	<input type="text" value="N-TRON Admin"/>
Location	<input type="text" value="Mobile, AL 36609"/>

NOTE:

The Gateway must belong to the network as described by the IP Address and the Subnet Mask.

Administration – SNMP

The SNMP tab under the administration category shows a list of IP Addresses that act as SNMP Traps. The Get, Set, and Trap Community Names are also shown here.

IP Address - Trap Stn.#1	192.168.1.2
IP Address - Trap Stn.#2	Value Not Configured
IP Address - Trap Stn.#3	Value Not Configured
IP Address - Trap Stn.#4	Value Not Configured
IP Address - Trap Stn.#5	Value Not Configured
Get Community Name	public
Set Community Name	private
Trap Community Name	public

By selecting the modify button you will be able to change any of the fields listed. This allows the user to set an IP address for an SNMP Trap or change the Community Names. Systems that are listed as an SNMP Trap will be sent basic networking changes made to the switch such as ports going down or being linked. To restore a Trap to “Value Not Configured”, enter ‘0.0.0.0’.

IP Address - Trap Stn.#1	<input type="text" value="192.168.1.2"/>
IP Address - Trap Stn.#2	<input type="text" value="Value Not Configured"/>
IP Address - Trap Stn.#3	<input type="text" value="Value Not Configured"/>
IP Address - Trap Stn.#4	<input type="text" value="Value Not Configured"/>
IP Address - Trap Stn.#5	<input type="text" value="Value Not Configured"/>
Get Community Name	<input type="text" value="public"/>
Set Community Name	<input type="text" value="private"/>
Trap Community Name	<input type="text" value="public"/>

Administration – Gigabit Ports

The ‘Gigabits Ports’ tab under the administration category allows users to change the configuration of the gigabit ports. The switch may not operate correctly if the slots are not configured properly. You must click “Update” if you wish to keep the changes.

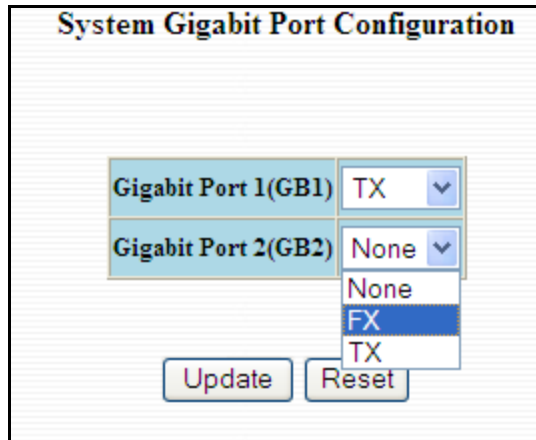

Notes:

1. In order to verify the settings have been configured and saved correctly, you may want to view the Logical View page in the found in the web browser interface. The dynamic illustration displayed on the Logical View page must match the physical switch configuration respectively in order for the switch to function correctly. If not, please repeat the steps listed above.
2. Validation of the configuration and each physical cable segment may be obtained by using N-ViewOPC Server software. The software is freely distributed on the ProductCD and our web site (http://www.n-tron.com/pdf/setup_nviewopc.zip). Once N-ViewOPC is installed, you should view the Ports Counter page view each connected port. You may find it helpful to copy [Alt]+[PrintScreen] the Port Counter information for each port and paste [Control]+[V] into a Windows document for further review. Please consult your N-View OPC Server Manual for additional information.

Following the Update button, the user may be prompted to Save and Restart the switch in order for changes to take effect. The switch will save the running configuration into the NVRAM and then cycle power automatically. Once the switch comes back online the settings will be updated.

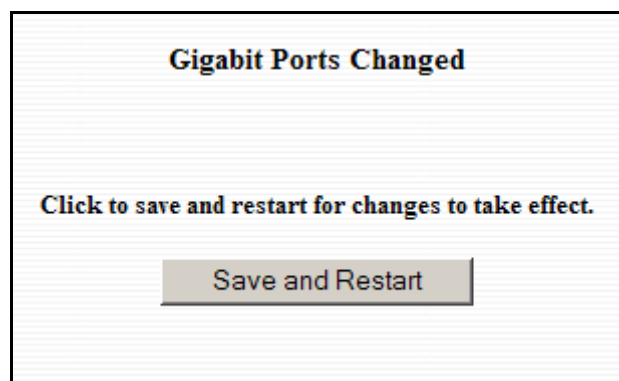

Ports – Configuration

The Configuration tab under the Ports category will show a detailed overview of all the active ports on the switch. The overview will display the following information:

Port Number
 Port Name
 Admin Status
 Link Status
 Auto Negotiation State
 Port Speed
 Duplex Mode
 Flow Control State
 Back Pressure State
 Priority State
 Priority Level
 RSTP State
 PVID

Port No	Port Name	Admin Status	Link Status	Auto Nego	Port Speed	Duplex Mode	Flow Control	Back Pressure	Priority State	Priority Level	RSTP State	PVID
1	P1	Enable	Down	Enable	10	Half	Disable	Disable	Disable	1	Disable	1
2	P2	Enable	Down	Enable	10	Half	Disable	Disable	Disable	1	Disable	1
3	P3	Enable	Down	Enable	10	Half	Disable	Disable	Disable	1	Disable	1
4	P4	Enable	Down	Enable	10	Half	Disable	Disable	Disable	1	Disable	1
5	P5	Enable	Down	Enable	10	Half	Disable	Disable	Disable	1	Disable	1
6	P6	Enable	Down	Enable	10	Half	Disable	Disable	Disable	1	Disable	1
7	P7	Enable	Down	Enable	10	Half	Disable	Disable	Disable	1	Disable	1
8	P8	Enable	Down	Enable	10	Half	Disable	Disable	Disable	1	Disable	1
9	P9	Enable	Down	Enable	10	Half	Disable	Disable	Disable	1	Disable	1
10	P10	Enable	Down	Enable	10	Half	Disable	Disable	Disable	1	Disable	1
11	P11	N-Ring	Up	Enable	100	Full	Disable	Disable	Disable	1	Ring-Forwd	1
12	P12	N-Ring	Up	Enable	100	Full	Disable	Disable	Disable	1	Ring-Forwd	1

Ports – Configuration, Continued...

The User can click on the Port Number to configure each port individually. This will allow the user to change the port's settings for the following fields:

- Admin Status
- Speed and Duplex
- Flow Control
- Back Pressure
- State of Priority
- Priority Level
- PVID

Port Configuration for Port P4

Port Name	:	P4
Admin Status	:	Enable ▾
Speed and Duplex	:	Autonego ▾
Flow control	:	Autonego 10/Half 100/Half
Back Pressure	:	10/Full 100/Full
State of Priority	:	Disable ▾
Priority Level	:	1 ▾
PVID	:	1

Update Cancel

Ports – Security

The Security tab under the Ports category will show a list of all the active ports and the security Lock State for each port.

Port Name	Lock State
P1	Disable
P2	Enable
P3	Disable
P4	Disable
P5	Disable
P6	Disable
P7	Disable
P8	Disable
P9	Disable
P10	Disable
FX1	Disable
FX2	Disable
GB1	Disable
GB2	Disable

Modify Refresh

Ports – Security (Continued)

Administrators can change the Port Security by a per port basis. If the Port is enabled through this the port will be locked and will only allow known MAC addresses to communicate through the port. Unknown MAC addresses will be logged in the Intrusion Log.

Port Security Configuration	
Port Name	State Locked?
P1	<input type="checkbox"/>
P2	<input checked="" type="checkbox"/>
P3	<input type="checkbox"/>
P4	<input type="checkbox"/>
P5	<input type="checkbox"/>
P6	<input type="checkbox"/>
P7	<input type="checkbox"/>
P8	<input type="checkbox"/>
P9	<input type="checkbox"/>
P10	<input type="checkbox"/>
FX1	<input type="checkbox"/>
FX2	<input type="checkbox"/>
GB1	<input type="checkbox"/>
GB2	<input type="checkbox"/>

Ports – Intrusion Log

The Intrusion Log tab under the Ports category will show a list of intruders along with their MAC addresses. The log will show what Port the intruder attempted to access your network on and log the system time when it occurred. The log can be easily cleared.

Intrusion Log		
Port Name	Intruder Address	System Time
P3	00:07:af:00:eb:52	00:00:00:00:00:18

Ports – Mirroring

A mirroring port is a dedicated port that is configured to receive the copies of Ethernet frames that are being transmitted out and also being received in from any other port that is being monitored.

The Mirroring tab under the Ports category displays the status including the list of Source Ports and the Destination Port that the Sources are being mirrored to.

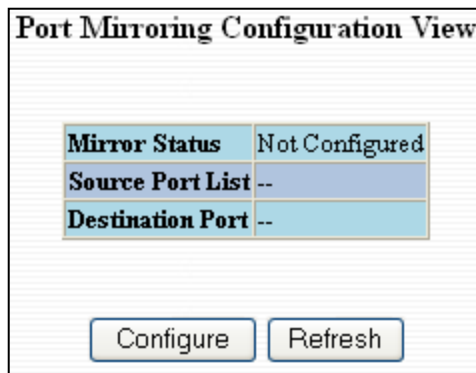

The screenshot shows a window titled "Port Mirroring Configuration View". It contains a table with the following data:

Mirror Status	Not Configured
Source Port List	--
Destination Port	--

Below the table are two buttons: "Configure" and "Refresh".

Following the Configure button, you can enable the status of port mirroring and select source ports and the destination port that the source ports will be mirrored to.

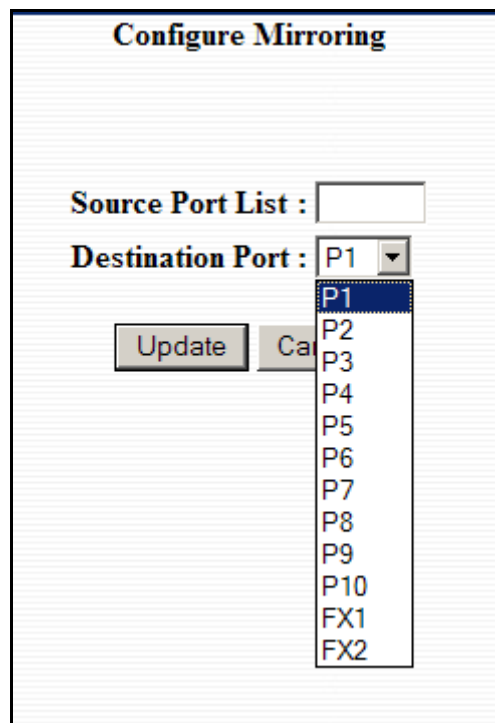

The screenshot shows a window titled "Configure Mirroring". It contains the following fields and controls:

- Source Port List :
- Destination Port : (with a dropdown arrow)
- Update button
- Cancel button (partially visible as "Ca")

The dropdown menu for Destination Port is open, showing the following options: P1, P2, P3, P4, P5, P6, P7, P8, P9, P10, FX1, and FX2.

NOTE: *Since the Gigabit ports cannot be destination ports, they are not available on the pull-down menu.*

Ports – Trunking

The Trunking tab under the Ports category displays a list of trunks configured on the switch and the following details regarding each trunk:

- Trunk Name
- Trunk Ports
- Trunk State

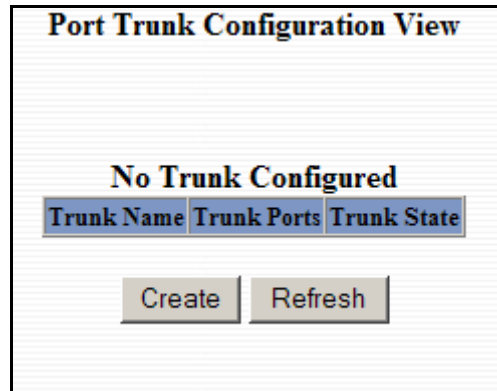

The screenshot shows a window titled "Port Trunk Configuration View". In the center, it says "No Trunk Configured". Below this, there is a table header with three columns: "Trunk Name", "Trunk Ports", and "Trunk State". At the bottom of the window, there are two buttons: "Create" and "Refresh".

By selecting the “Create” button, you can add a trunk group.

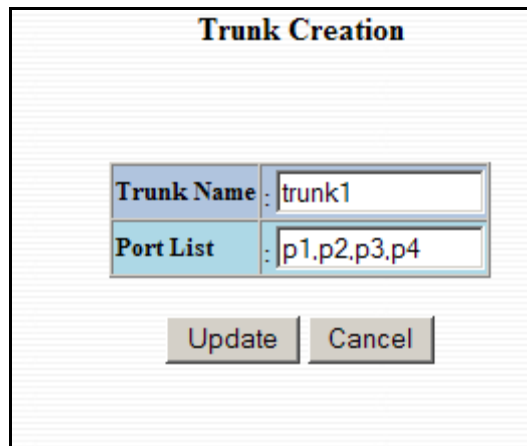

The screenshot shows a dialog box titled "Trunk Creation". It contains two input fields: "Trunk Name" with the value "trunk1" and "Port List" with the value "p1,p2,p3,p4". Below the input fields, there are two buttons: "Update" and "Cancel".

NOTE: RSTP must be disabled in order to use the Trunking Feature.

A maximum of 4 ports of the same speed can constitute a valid trunk.

Only 1 Trunk per switch can be created.

All trunk ports must be at the same speed and duplex mode. If a port is not linked, there could be difficulty as to similar speed and duplex mode. It is best to hard code speed and duplex mode for each trunking link, at both ends.

When trunking the gigabit ports it's best to route switchA GB1 to switchB GB1 and switchA GB2 to switchB GB2.

Do not use Trunking on a switch that is directly in an active N-Ring.

Ports – Trunking, Continued...

Once the Trunk Group is created you will see detailed information for that trunk group, but it should have a disabled state by default.

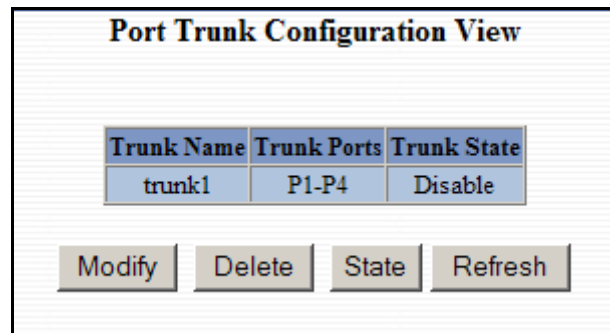

The screenshot shows a window titled "Port Trunk Configuration View". It contains a table with three columns: "Trunk Name", "Trunk Ports", and "Trunk State". The first row of data shows "trunk1", "P1-P4", and "Disable". Below the table are four buttons: "Modify", "Delete", "State", and "Refresh".

Trunk Name	Trunk Ports	Trunk State
trunk1	P1-P4	Disable

Modify Delete State Refresh

In order to enable the Trunk Group you need to click on the State Button above. The following page should load asking for the Trunk ID and what the Trunk State is.

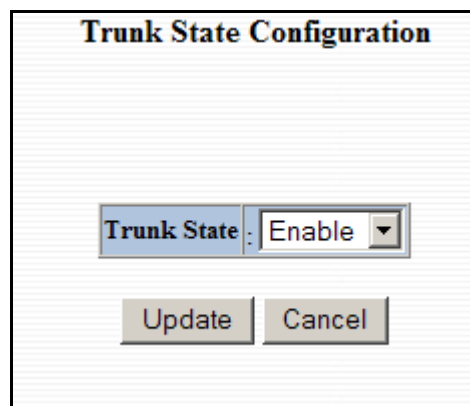

The screenshot shows a window titled "Trunk State Configuration". It contains a label "Trunk State:" followed by a dropdown menu currently set to "Enable". Below this are two buttons: "Update" and "Cancel".

Trunk State : Enable

Update Cancel

NOTE: *RSTP must be disabled in order to use the Trunking Feature.
A maximum of 4 ports of the same speed can constitute a valid trunk.
Only 1 Trunk per switch can be created.*

All trunk ports must be at the same speed and duplex mode. If a port is not linked, there could be difficulty as to similar speed and duplex mode. It is best to hard code speed and duplex mode for each trunking link, at both ends.

Do not use Trunking on a switch that is directly in an active N-Ring.

Statistics – Port Statistics

The Ports Statistics tab under the Statistics category displays a list of MIB Parameters. Each port has a separate counter for each parameter. This gives users the ability to see what kind of packets are going over which ports. At the bottom of each page for each port there are two buttons. Refresh will update the statistics for that port number and Clear will reset all the counters for that port number.

Port

Statistics at Port no: P3

S.No	Counter Type	Value
1	Tx Octets	1100095
2	Tx Dropped Packets	0
3	Tx Broadcast Packets	686
4	Tx Multicast Packets	5454
5	Tx Unicast Packets	452
6	Tx Collisions	0
7	Tx Single Collision	0
8	Tx Multiple Collision	0
9	Tx Deferred Transmit	0
10	Tx Late Collision	0
11	Tx Excessive Collision	0
12	Tx Frame In Disc	0
13	Tx Pause Packets	0
14	64 Packets	670
15	65 to 127 Packets	904
16	128 to 255 Packets	5017
17	256 to 511 Packets	0
18	512 to 1023 Packets	0
19	1024 to 1522 Packets	3
20	Rx Octets	128
21	Rx Dropped Packets	0
22	Rx Broadcast Packets	0
23	Rx Multicast Packets	2
24	Rx Unicast Packets	0
25	Rx Undersize Packets	0
26	Rx Oversize Packets	0
27	Rx Jabbers	0
28	Rx Alignment Errors	0
29	Rx Good Octets	128
30	Rx SA Changes	0
31	Rx FCS Errors	0
32	Rx Pause Packets	0
33	Rx Fragments	0
34	Rx Excessive Disc Size	0
35	Rx Symbol Error	0

Statistics – Port Utilization

The Ports Utilization tab under the Statistics category shows all the ports on the switch and will display a bar graph showing the percentage of bandwidth being used. These figures and bars are for a general feeling of what the bandwidth usage is. N-Tron recommends the use of N-View in order to get a precise bandwidth usage figure.

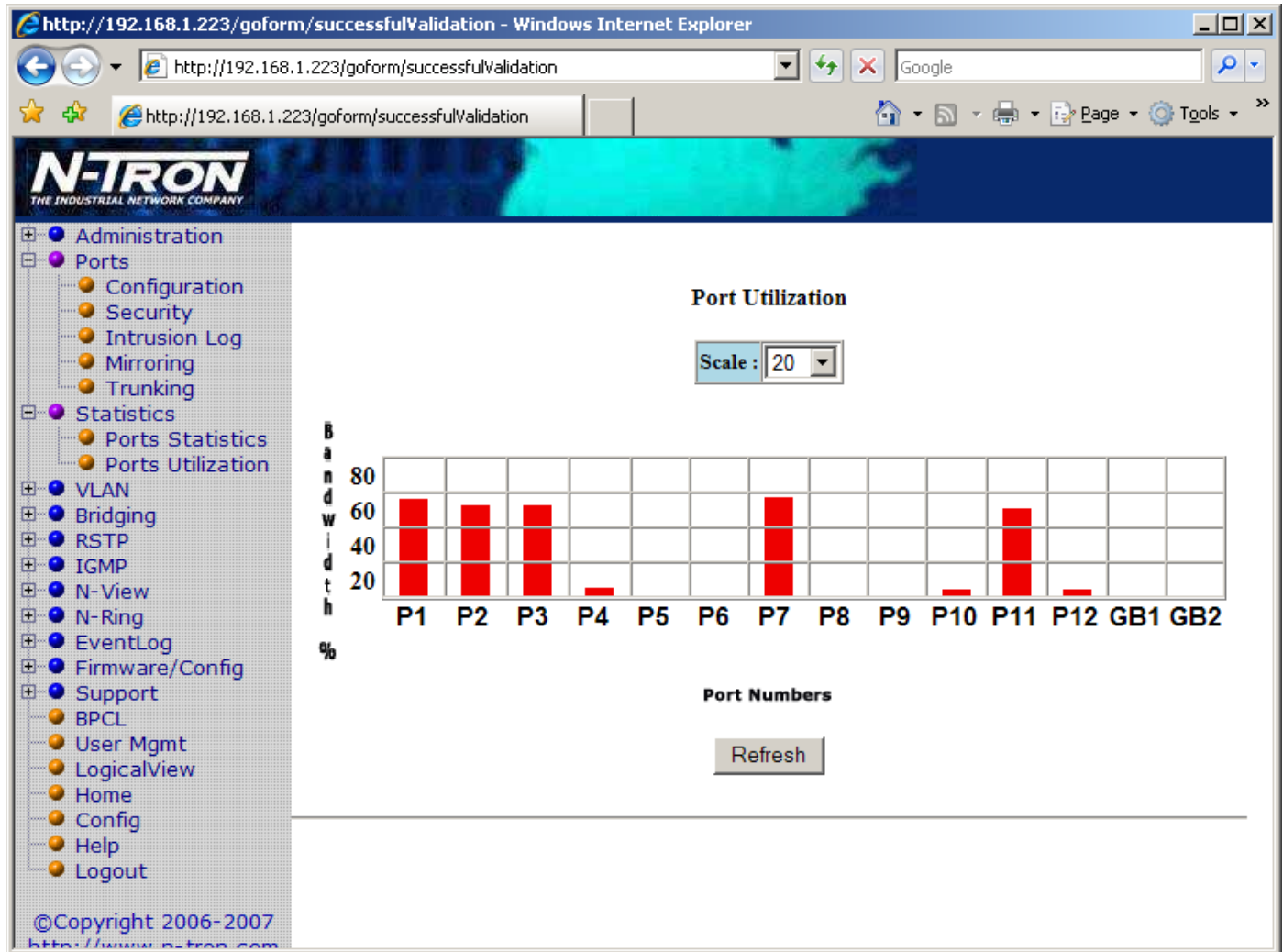

VLAN – Ingress Filter

The Ingress Filter tab under the VLAN category shows all the Ingress Filter Rule enabled or disabled state for each port. Ingress Filtering can be Enabled or Disabled for each port. If enabled, received frames will be discarded if the frame's VID does not match any VLAN IDs associated with the port. This implements IEEE 802.1Q clause 8.6.

VLAN Ingress Filter Configuration View

Port Name	Ingress Filter Rule
P1	Disable
P2	Disable
P3	Disable
P4	Disable
P5	Disable
P6	Enable
P7	Disable
P8	Disable
P9	Disable
P10	Disable
P11	Disable
P12	Disable
GB1	Disable
GB2	Disable

To change the Ingress Filter Rule simply click on the Modify button on the page above, select the port number from the pull-down menu that you wish to modify and then choose to either enable or disable the Ingress Filter Rule.

VLAN Ingress Filter Configuration

Port Name	Ingress Filter Enabled?
P1	<input type="checkbox"/>
P2	<input type="checkbox"/>
P3	<input type="checkbox"/>
P4	<input type="checkbox"/>
P5	<input type="checkbox"/>
P6	<input checked="" type="checkbox"/>
P7	<input type="checkbox"/>
P8	<input type="checkbox"/>
P9	<input type="checkbox"/>
P10	<input type="checkbox"/>
P11	<input type="checkbox"/>
P12	<input type="checkbox"/>
GB1	<input type="checkbox"/>
GB2	<input type="checkbox"/>

NOTE: *The Ingress Filter will automatically be turned on for respective ports when tagged VLANs are created, but may not automatically turn off if you change a tagged VLAN to a port based VLAN.*

VLAN – Port Based

The Port Based tab under the VLAN category shows all the VLANs that are configured on the switch and details about the VLANs such as port numbers and tagged VLAN settings.

VLAN Configuration View

("Click on VLAN ID number to modify the existing values ")

VLAN Status : Enable						
VLAN ID	VLAN Name	Untagged Port(s)	Tagged Port(s)	Mgmt Port	Admit	Mirror Port
1	Default VLAN	P1-P12	--	YES	All	
3333	N-Ring VLAN	--	P11-P12	YES	All	

Total Number of vlans configured : 2

N-Ring is using VLAN ID: 3333

To add a VLAN simply click on the Add button on the page above and fill in the desired fields. The example below would set up a basic port based VLAN for ports P1-P6.

VLAN Creation

VLAN ID	<input type="text" value="2"/>
VLAN Name	<input type="text" value="Two"/>
Untagged Port List	<input type="text" value="P1-P6"/>
Tagged Port List	<input type="text"/>
Management Port	<input type="text" value="YES"/>
Admit	<input type="text" value="All"/>
Mirror Port	<input type="text" value="NA"/>

(See VLAN Configuration Examples section)

Note:

- 1. When implementing overlapping VLANs, RSTP can only be enabled on one of the VLANs that is overlapping others. RSTP can not be implemented on a VLAN that contains other VLANs within that one. Changing anything on a VLAN will turn on RSTP on all VLANs as a precautionary measure.*
- 2. All N-Ring ports must be on the same tagged VLAN.*
- 3. VID=1 has to be Admit=ALL, and cannot be tagged only.*

VLAN – Port Based, Continued...

Now the page will display the new VLAN and moved ports P1-P6 from the default VLAN down to vlan2 that was just created.

VLAN Configuration View

("Click on VLAN ID number to modify the existing values ")

VLAN Status : Enable						
VLAN ID	VLAN Name	Untagged Port(s)	Tagged Port(s)	Mgmt Port	Admit	Mirror Port
1	Default VLAN	P7-P12,GB1-GB2	--	YES	All	
2	Two	P1-P6	--	YES	All	

Total Number of vlans configured : 2

To delete or remove VLANs that are no longer wanted simply click on the Delete button on the main Port Based VLAN page. That button will load the page where the user can enter the VLAN ID that he or she wishes to delete.

VLAN Deletion

VLAN ID

(See VLAN Configuration Examples section)

Note:

- 1. When implementing overlapping VLANs, RSTP can only be enabled on one of the VLANs that is overlapping others. RSTP can not be implemented on a VLAN that contains other VLANs within that one. Changing anything on a VLAN will turn on RSTP on all VLANs as a precautionary measure.*
- 2. All N-Ring ports must be on the same tagged VLAN.*
- 3. VID=1 has to be Admit=ALL, and cannot be tagged only.*

VLAN – Port Based, Continued...

Once the VLAN is deleted it will no longer appear on the main page and all the ports are now back under the default VLAN. When a port based VLAN is created the PVID (Port VLAN ID) will change automatically to be members of the new VLAN they are a part of. If you delete this VLAN the PVIDs will not automatically return to the default VLAN. Users should keep this in mind when removing VLANs, and may need to manually change the PVIDs for any affected ports.

VLAN Configuration View

("Click on VLAN ID number to modify the existing values ")

VLAN Status : Enable						
VLAN ID	VLAN Name	Untagged Port(s)	Tagged Port(s)	Mgmt Port	Admit	Mirror Port
1	Default VLAN	P1-P12	--	YES	All	
3333	N-Ring VLAN	--	P11-P12	YES	All	

Total Number of vlans configured : 2

N-Ring is using VLAN ID: 3333

(See VLAN Configuration Examples section)

Note:

1. *When implementing overlapping VLANs, RSTP can only be enabled on one of the VLANs that is overlapping others. RSTP can not be implemented on a VLAN that contains other VLANs within that one. Changing anything on a VLAN will turn on RSTP on all VLANs as a precautionary measure.*
2. *All N-Ring ports must be on the same tagged VLAN.*
3. *VID=1 has to be Admit=ALL, and cannot be tagged only.*

Bridging – Aging Time

The Aging Time tab under the Bridging category will display the currently configured Aging Time. This page allows users to modify this variable to meet their needs.

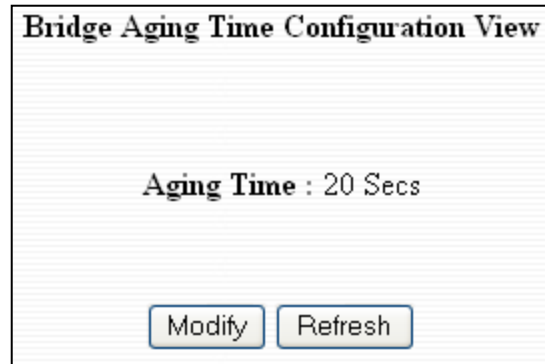

A screenshot of a web interface titled "Bridge Aging Time Configuration View". The page displays the text "Aging Time : 20 Secs" in the center. Below this text are two buttons: "Modify" and "Refresh".

After selecting the Modify button the user will be presented with a page that allows the number to be entered into and updated. The default aging time is 20 seconds.

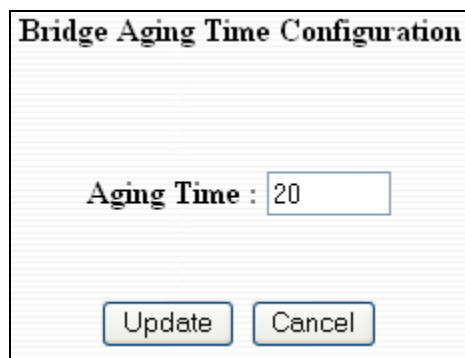

A screenshot of a web interface titled "Bridge Aging Time Configuration". The page displays the text "Aging Time : 20" where the number "20" is inside a text input field. Below this are two buttons: "Update" and "Cancel".

Bridging – Unicast Addresses

The Unicast Addresses tab under the Bridging category will display a list of MAC addresses that are associated with each respective port number. This can be used to statically assign a MAC address access to a single port on the switch.

Display Static Unicast MAC Address(es)

MAC Address	Port Name	Mirroring
-------------	-----------	-----------

Number of Static Unicast MAC Address(es) is **0**

Following the Add button on the page above, the administrator must enter a valid MAC address and associate it with a port number on the switch. Once the administrator hits the Update button the changes will take effect instantly.

Add Static Unicast MAC Address

MAC Address :	<input type="text" value="00:07:AF:00:00:00"/>
Port Name :	<input type="text" value="P1"/>
Mirroring :	<input type="text" value="Enable"/>

Once a static MAC address has been added, it will be displayed in a list on the main page under Unicast MACs tab.

Display Static Unicast MAC Address(es)

MAC Address	Port Name	Mirroring
00:07:af:00:00:00	P1	Enable

Number of Static Unicast MAC Address(es) is **1**

Bridging – Unicast Addresses, Continued...

Following the Delete button on the page above, an administrator can select a static MAC address from the list using a pull-down menu. After selecting the MAC address the administrator needs to press the Delete button on this page to remove the entry

Delete Static Unicast MAC Address

MAC Address : 00:07:af:00:00:00 ▼

Number of MAC Address(es) is 1

Delete Cancel

Bridging – Multicast Addresses

The Multicast Addresses tab under the Bridging category will display a list of Multicast Group Addresses that are associated with respective port numbers. This may be used to statically assign a Multicast Group Address access to a group of ports on the switch. These are egress filters.



The screenshot shows a window titled "Display Static Multicast Group Address(es)". At the top, there are two tabs: "Multicast Address" and "Port List". Below the tabs, the text reads "Total Number of Static Multicast Group Address(es) is 0". At the bottom of the window, there are three buttons: "Add", "Delete", and "Refresh".

Following the Add button on the page above, the administrator must enter a valid Multicast Group Address and associate it with a port number or list on the switch. Once the administrator clicks on the Update button, the changes will take effect instantly.

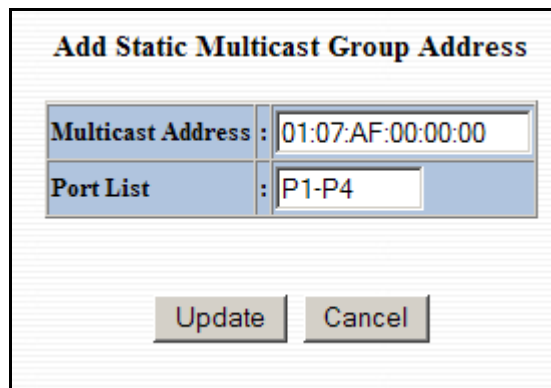

The screenshot shows a form titled "Add Static Multicast Group Address". It contains two input fields: "Multicast Address" with the value "01:07:AF:00:00:00" and "Port List" with the value "P1-P4". Below the form, there are two buttons: "Update" and "Cancel".

Note: *If there are multiple ports on different VLANs, the 7014 will apply the static multicast address to the lowest VLAN-ID that is associated with one of the ports assigned to the static multicast address. So if the lowest VLAN-ID contains all the ports assigned to the static multicast address (an umbrella VLAN), it will function for all those ports with no problems. This can be achieved with overlapping VLANs.*

Bridging – Multicast Addresses, Continued...

After adding a Multicast Group Address it will appear on the main list and will show the associated ports that go along with that address.

Display Static Multicast Group Address(es)

Multicast Address	Port List
01:07:af:00:00:00	P1-P4

Total Number of Static Multicast Group Address(es) is **1**

Following the Delete button on the page above, the administrator will be presented with a list of Multicast Group Addresses that are configured on the switch. Using the pull-down menu the administrator should select the desired port to be removed. Then click on the Delete button at the bottom of the page.

Delete Static Multicast Group Address

MAC Address : 01:07:af:00:00:00

Note: *If there are multiple ports on different VLANs, the 7014 will apply the static multicast address to the lowest VLAN-ID that is associated with one of the ports assigned to the static multicast address. So if the lowest VLAN-ID contains all the ports assigned to the static multicast address (an umbrella VLAN), it will function for all those ports with no problems. This can be achieved with overlapping VLANs.*

RSTP – RSTP Configuration

The RSTP Configuration tab under the RSTP category will display the RSTP information for the first VLAN. Using the pull-down menu at the top of the page an administrator can choose which VLAN to configure RSTP on. Once the VLAN is selected the administrator may configure the bridge by clicking on the Configuration button in the middle of the page.

RSTP on VLAN 1 ▾

RSTP Root Bridge Configuration

Root Priority	Designated Root	Path Cost	Port	Max Age	Hello Time	Forward Delay
32768	80:00:00:07:af:00:c2:07	0	0	16	1	13

This Bridge [Configuration](#)

Hello Time (Sec)	Forward Delay (Sec)	Max Age (Sec)	Priority	RSTP Status	Topology Change	Topology Count
1	13	16	32768	Fast	False	0

Refresh

The configuration screen for the VLAN that was previously selected will look like the example below. Here the administrator can make changes such as the Hello Time, the Forward Delay, the Max Age, the priority, and the Status of RSTP on that VLAN. Following the link for the view RSTP Port Configuration at VLAN# the administrator or user can see the current RSTP status of the ports on that VLAN.

Bridge RSTP Configuration for VLAN 1

Hello Time :
Forward Delay :
Max age :
Priority :
Status : Fast ▾

Click [here](#) to view the RSTP port Configuration at VLAN 1

Update
Cancel

NOTE: *Trunking must be disabled in order to use RSTP.*

RSTP Configuration, Continued...

Following the link for the view RSTP Port Configuration at VLAN# the administrator or user can see the current RSTP status of the ports on that VLAN. This will show information such as the Path Cost and the Port State. If the switch sees a redundant path it will put the port with the highest Path Cost into Blocking mode where it will discard packets coming in on that port. In the below example, P12 is a redundant port with port P2, therefore P2 is forwarding and P12 is discarding.

Port No	Port Name	Port State	Path Cost	Priority	STP BPDU	AutoEdge	AdminEdge	Designated Bridge	Designated Port
1	P1	Forwarding	200000	128	No	Enabled	Disabled	80:00:00:07:aff:e4:41	00:01
2	P2	Forwarding	200000	128	No	Enabled	Disabled	80:00:00:07:aff:e4:41	00:02
3	P3	Forwarding	200000	128	No	Enabled	Disabled	80:00:00:07:aff:e4:41	00:03
4	P4	Forwarding	200000	128	No	Enabled	Disabled	80:00:00:07:aff:e4:41	00:04
7	P7	Forwarding	200000	128	No	Enabled	Disabled	80:00:00:07:aff:e4:41	00:07
8	P8	Disabled	2000000	128	No	Enabled	Disabled	00:00:00:00:00:00:00:00	00:08
9	P9	Disabled	2000000	128	No	Enabled	Disabled	00:00:00:00:00:00:00:00	00:09
10	P10	Forwarding	200000	128	No	Enabled	Disabled	80:00:00:07:aff:e4:41	00:0a
11	P11	Forwarding	200000	128	No	Enabled	Disabled	80:00:00:07:aff:e4:41	00:0b
12	P12	Discarding	200000	128	No	Enabled	Disabled	80:00:00:07:aff:e4:41	00:0c
13	GB1	Disabled	20000	128	No	Enabled	Disabled	00:00:00:00:00:00:00:00	00:19
14	GB2	Disabled	20000	128	No	Enabled	Disabled	00:00:00:00:00:00:00:00	00:1a

RSTP – RSTP Configuration, Continued...

If the administrator selects one of the ports on the previous screen he or she can change the Port's Path Cost, Port's Priority and the status of Admin Edge and Auto Edge.

Port RSTP Configuration for Port P7 on VLAN 1

Port Path Cost :

Port priority :

Admin Edge : ▼

Auto Edge : ▼

IGMP – Configuration

The Configuration tab under the IGMP category will display the IGMP basic configuration settings. By default IGMP is enabled.

IGMP Configuration View

IGMP Status	Enabled
Query Mode	Auto
Router Mode	Auto
Manual Router Ports	

Following the Modify button on the previous page, the administrator will see a list of configurable fields for the IGMP configuration. Once these fields are filled in to meet the needs of the administrator's network the changes may be saved by clicking the Update button at the bottom of the page.

IGMP Configuration

IGMP Status	Enable <input type="button" value="v"/>
Query Mode	Auto <input type="button" value="v"/>
Router Mode	Auto <input type="button" value="v"/>
Manual Router Ports	<input type="text"/>
Router Add/Delete	Add <input type="button" value="v"/>

IGMP – Configuration (continued)

The IGMP Status pull-down allows the user to enable or disable IGMP completely.

IGMP Configuration

IGMP Status	Enable ▾
Query Mode	Enable Disable
Router Mode	Auto ▾
Manual Router Ports	P4
Router Add/Delete	Add ▾

The Query Mode pull-down allows the user to set query mode for Automatic (the default), On (always), or Off (never):

IGMP Configuration

IGMP Status	Enable ▾
Query Mode	Auto ▾
Router Mode	Auto Off On
Manual Router Ports	P4
Router Add/Delete	Add ▾

IGMP – Configuration (continued)

The Router Mode pull-down allows the user to choose router mode. ‘Auto’ allows for dynamically detected and manually set router ports. ‘Manual’ allows only for manually set router ports. ‘None’ allows no router ports.

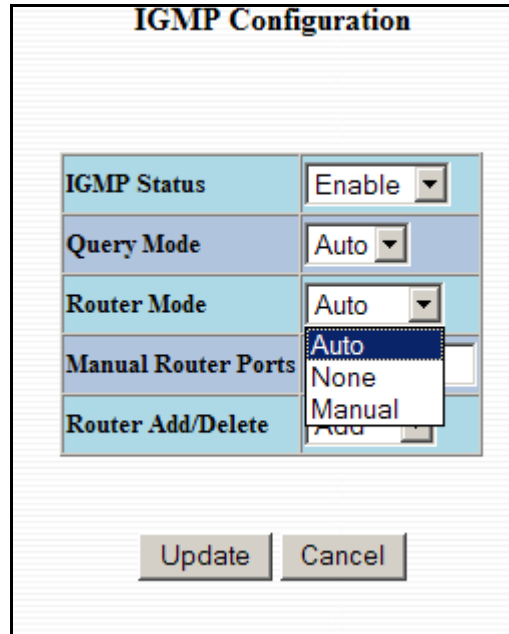

The screenshot shows the 'IGMP Configuration' dialog box. It contains a table with the following fields:

IGMP Status	Enable
Query Mode	Auto
Router Mode	Auto
Manual Router Ports	Auto
Router Add/Delete	Auto

The 'Manual Router Ports' field is currently empty. The 'Router Add/Delete' dropdown menu is open, showing the following options: Auto, None, Manual, and Add. Below the table are two buttons: 'Update' and 'Cancel'.

The user can add or delete manual router ports:

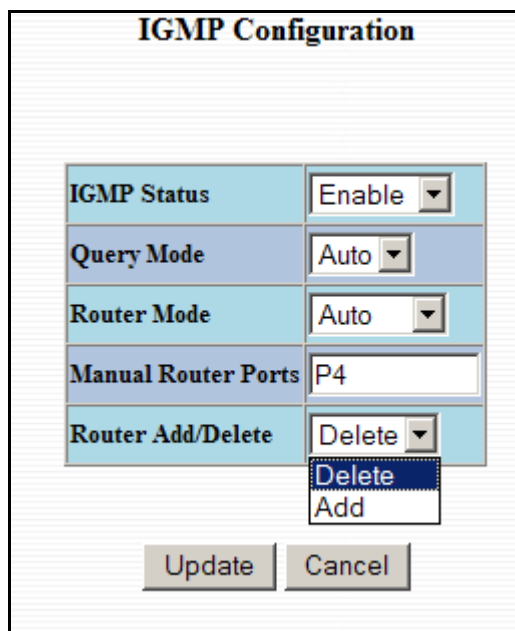

The screenshot shows the 'IGMP Configuration' dialog box. It contains a table with the following fields:

IGMP Status	Enable
Query Mode	Auto
Router Mode	Auto
Manual Router Ports	P4
Router Add/Delete	Delete

The 'Manual Router Ports' field contains the text 'P4'. The 'Router Add/Delete' dropdown menu is open, showing the following options: Delete, Add, and Add. Below the table are two buttons: 'Update' and 'Cancel'.

IGMP – Show Group and Show Router

The Show Group tab under the IGMP category will display a list of IGMP groups based on the Group IP and the port number that it is associated with.

IGMP Group View

Group IP	Port Name	VLAN ID
239.255.255.250	P12	1
224.10.10.10	P7	1
224.10.10.10	P5	1
224.10.10.10	P3	1
224.10.10.10	P12	1
224.10.10.11	P10	1
224.10.10.11	P6	1
224.10.10.20	P12	1

The Show Router tab under the IGMP category will display a list of Auto-detected Router IPs and the port numbers that they are associated with.

Auto-Detected Routers View

Router IP	Port Name
192.9.9.3	P9
192.168.1.118	P12

IGMP – RFilter

The 'rfilter' (**Router Multicast Data Filter**) function allows you to choose whether or not DATA frames with KNOWN group multicast addresses are sent to the 'router' ports (links to other switches). Control packets (Join, Leave) will be sent to the router(s) regardless of this setting. "KNOWN" is known from dynamic IGMP Snooping operations.

The factory default is that the Router Multicast Data Filter is enabled for all ports, so any router ports do NOT get DATA frames with KNOWN multicast destination addresses unless a join to a specific multicast address has been received on that port. **Joins override an rfilter.**

If rfilter is disabled router ports do get DATA frames with KNOWN multicast destination addresses

Rfilter can be set for individual ports: any, all, or none. For each port, rfilter will have an impact only if that port is manually or dynamically chosen as a router port.

Default configuration:

Port Name	RFilter State
P1	Disabled
P2	Disabled
P3	Disabled
P4	Disabled
P5	Disabled
P6	Disabled
P7	Disabled
P8	Disabled
P9	Disabled
P10	Disabled
P11	Disabled
P12	Disabled
GB1	Disabled
GB2	Disabled

IGMP – Rfilter (Continued)

Modifying rfilter port settings:

IGMP RFilter Configuration	
Port Name	RFilter Enabled?
P1	<input type="checkbox"/>
P2	<input type="checkbox"/>
P3	<input checked="" type="checkbox"/>
P4	<input type="checkbox"/>
P5	<input type="checkbox"/>
P6	<input type="checkbox"/>
P7	<input type="checkbox"/>
P8	<input checked="" type="checkbox"/>
P9	<input type="checkbox"/>
P10	<input type="checkbox"/>
P11	<input type="checkbox"/>
P12	<input checked="" type="checkbox"/>
GB1	<input type="checkbox"/>
GB2	<input type="checkbox"/>

N-View – Configuration

The Configuration tab under the N-View category will display two basic variables for N-View, the status and the interval between packets.

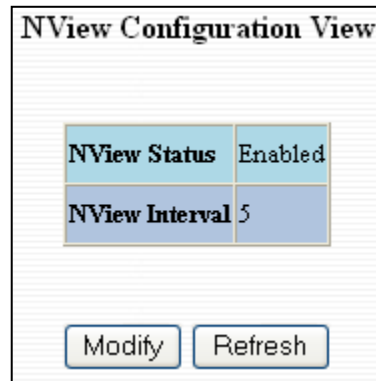

The screenshot shows a window titled "NView Configuration View". It contains a table with two rows. The first row has "NView Status" in the left column and "Enabled" in the right column. The second row has "NView Interval" in the left column and "5" in the right column. Below the table are two buttons: "Modify" and "Refresh".

Variable	Value
NView Status	Enabled
NView Interval	5

Buttons: Modify, Refresh

Following the Modify button on the above example, the administrator can modify the variable to change the frequency with which N-View reports information. Increasing the interval will slow the update rate. Decreasing the interval will allow N-View to report more frequently. Additionally, you may Disable or Enable N-View altogether.

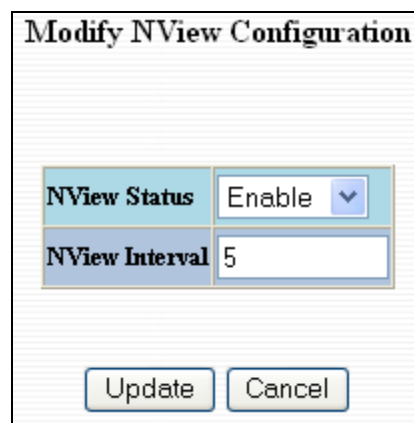

The screenshot shows a window titled "Modify NView Configuration". It contains a table with two rows. The first row has "NView Status" in the left column and a dropdown menu with "Enable" selected in the right column. The second row has "NView Interval" in the left column and a text input field containing "5" in the right column. Below the table are two buttons: "Update" and "Cancel".

Variable	Value
NView Status	Enable
NView Interval	5

Buttons: Update, Cancel

N-View – Ports

The Ports tab under the N-View category will display a list of all the configured ports on the 7014 unit along with the ports transmitting multicast packets and MIB stats respectively.

Port Name	Multicast on Port?	Send MIB Stats?
P1	YES	YES
P2	YES	YES
P3	YES	NO
P4	YES	NO
P5	YES	NO
P6	YES	YES
P7	YES	YES
P8	YES	YES
P9	YES	YES
P10	YES	YES
P11	YES	YES
P12	YES	YES
GB1	YES	YES
GB2	YES	YES

N-View – Ports, Continued...

Following the Modify button on the previous example, the administrator can modify these two variables to enable or disable multicast out of the port and if MIB stats are sent out for those ports.

Modify N-View Ports

Port Name	Multicast on Port?	Send MIB Stats?
P1	<input checked="" type="checkbox"/>	<input checked="" type="checkbox"/>
P2	<input checked="" type="checkbox"/>	<input checked="" type="checkbox"/>
P3	<input checked="" type="checkbox"/>	<input type="checkbox"/>
P4	<input type="checkbox"/>	<input type="checkbox"/>
P5	<input checked="" type="checkbox"/>	<input type="checkbox"/>
P6	<input checked="" type="checkbox"/>	<input checked="" type="checkbox"/>
P7	<input checked="" type="checkbox"/>	<input checked="" type="checkbox"/>
P8	<input checked="" type="checkbox"/>	<input checked="" type="checkbox"/>
P9	<input checked="" type="checkbox"/>	<input checked="" type="checkbox"/>
P10	<input checked="" type="checkbox"/>	<input checked="" type="checkbox"/>
P11	<input checked="" type="checkbox"/>	<input checked="" type="checkbox"/>
P12	<input checked="" type="checkbox"/>	<input checked="" type="checkbox"/>
GB1	<input checked="" type="checkbox"/>	<input checked="" type="checkbox"/>
GB2	<input checked="" type="checkbox"/>	<input checked="" type="checkbox"/>

N-Ring - Configuration

The Configuration tab under the N-Ring category will display the N-Ring basic configuration settings. By default N-Ring is in AutoMember mode and the N-Ring agingtime is 20 seconds.

N-Ring Configuration View

N-Ring Mode	AutoMember
N-Ring Agingtime	20 Seconds

Following the Modify button on the previous page, the administrator will see a list of configurable fields for the N-Ring configuration, as below.

Modify N-Ring Configuration

N-Ring Mode	AutoMember <input type="button" value="v"/>
Port Set	P11/P12 <input type="button" value="v"/>
Show Faults	On N-Ring Pages Only <input type="button" value="v"/>
Agingtime	20
VLAN ID	3333
Tagging	Tagged <input type="button" value="v"/>

The N-Ring Agingtime has a default of 20 seconds and is separate from the Bridging Aging Time. N-Ring Aging time is used for the whole switch if the switch is an N-Ring Manager or becomes an active N-Ring Member, and in either case N-Ring status includes for example:

“Switch is currently using N-Ring Aging Time = 20 Seconds”

Once these fields are filled in to meet the needs of the administrator’s network the changes may be saved by clicking the Update button at the bottom of the page.

NOTES:

1. *N-Ring Manager cannot have RSTP or Trunking enabled.*
2. *RSTP & N-Ring are different modes and cannot share links or segments along those lines. See the examples in the RSTP configuration section.*
3. *Do not use Trunking on a switch that is directly in an active N-Ring.*
4. *Any one 7014 can only participate in one N-Ring.*
5. *N-Ring copper ports must be run at 100Mb full duplex, including the default 'autonegotiate' as long as all switches in the ring support 100Mb full duplex.*

The “N-Ring Mode” is one of three, as below:

Modify N-Ring Configuration	
N-Ring Mode	AutoMember
Port Set	Manager AutoMember Disable
Show Faults	Disable
Aging time	20
VLAN ID	3333
Tagging	Tagged
Update Cancel	

If N-Ring Mode is “Manager”, then a pull-down allows selection as available of ports P11 and P12, or GB1 and GB2 as N-Ring ports if GB1 and GB2 are populated. Otherwise only P11 and P12 will be offered as a selection.

Modify N-Ring Configuration

N-Ring Mode	Manager <input type="button" value="v"/>
Port Set	P11/P12 <input type="button" value="v"/>
Show Faults	P11/P12 On N-Ring Pages Only <input type="button" value="v"/>
Agingtime	20
VLAN ID	3333
Tagging	Tagged <input type="button" value="v"/>

N-Ring Configuration (continued)

If N-Ring Mode is “Manager”, then a pull-down allows selection of displaying N-Ring Summary Status on all web pages or on N-Ring pages only:

Modify N-Ring Configuration	
N-Ring Mode	Manager <input type="button" value="v"/>
Port Set	P11/P12 <input type="button" value="v"/>
Show Faults	On N-Ring Pages Only <input type="button" value="v"/>
Aging time	On N-Ring Pages Only On All Web Pages
VLAN ID	3333
Tagging	Tagged <input type="button" value="v"/>

N-Ring Configuration (continued)

If N-Ring Mode is “Manager”, then VLAN ID can be set to a unique vlan id (1 ~ 4094). Default is 3333.

If N-Ring Mode is “Manager”, then a pull-down allows selection as to whether the N-Ring ports are members of the VLANs Tagged or Untagged ports. Default is Tagged.

Modify N-Ring Configuration

N-Ring Mode	Manager
Port Set	P11/P12
Show Faults	On N-Ring Pages Only
Agingtime	20
VLAN ID	3333
Tagging	Tagged

Once these fields are filled in to meet the needs of the administrator’s network the changes may be saved by clicking the Update button at the bottom of the page.

NOTES:

- 1. Since VLANs are implemented for security reasons as well as traffic flow, N-Ring only makes minimal changes. It is up to the administrator to ensure that VLANs are configured correctly on the N-Ring manager and all N-Ring members.**
- 2. When the N-Ring manager and all N-Ring Members are in defaults, changing the N-Ring manager to use a Tagged VLAN requires no user interaction to allow non-ring traffic to pass through the ring. This works because changing to a Tagged VLAN does not remove the ring ports from the default VLAN.**
- 3. When the N-Ring manager and all N-Ring Members are in defaults, changing the N-Ring manager to use an Untagged VLAN other than VID 1, requires the administrator to add non-ring ports to the N-Ring VLAN to allow non-ring traffic to pass through the ring. This occurs because the N-Ring ports must be removed from VID 1 because an untagged port may only be a member of one VLAN.**

N-Ring – Status

The Status tab under the N-Ring category will display the N-Ring status.

Below is an example of N-Ring Status from a switch in defaults (N-Ring Auto Member) that is not an N-Ring Manager and has not become an “Active” N-Ring Member:

N-Ring Status View

Switch is in Auto Member Detection Mode

Below is an example of N-Ring Status from an “Active” N-Ring Member:

N-Ring Status View

Switch is an N-Ring Member

N-Ring Manager Address	
00:07:af:ff:e3:e0	

Active N-Ring Ports	
GB1	GB2

Switch is currently using N-Ring Aging Time = 20 Seconds

Below is an example of N-Ring Status from an N-Ring Manager with a healthy N-Ring:

N-Ring OK

N-Ring Status View

Switch is an N-Ring Manager, using N-Ring Aging Time = 20 Seconds

Refresh every secs.

12 Active Members Detected In Current N-Ring (12 reporting)

Switch No	MAC Address	IP Address	Subnet Mask	Name	Ports
RM	00:07:af:ff:e4:a0	192.168.1.227	255.255.255.0	N-TRON Switch	GB2 GB1
1	00:07:af:ff:ef:60	192.168.1.224	255.255.255.0	N-TRON Switch	GB2 GB1
2	00:07:af:ff:e6:a0	192.168.1.217	255.255.255.0	N-TRON Switch	GB2 GB1
3	00:07:af:ff:ef:80	192.168.1.221	255.255.255.0	N-TRON Switch	GB2 GB1
4	00:07:af:ff:e4:c0	192.168.1.241	255.255.255.0	N-TRON Switch	GB2 GB1
5	00:07:af:ff:d5:e0	192.168.1.229	255.255.255.0	N-TRON Switch	GB2 GB1
6	00:07:af:ff:d7:00	192.168.1.228	255.255.255.0	N-TRON Switch	GB2 GB1
7	00:07:af:ff:e6:c0	192.168.1.223	255.255.255.0	N-TRON Switch	GB2 GB1
8	00:07:af:ff:d5:20	192.168.1.231	255.255.255.0	N-TRON Switch	GB2 GB1
9	00:07:af:ff:e5:e0	192.168.1.238	255.255.255.0	N-TRON Switch	GB2 GB1
10	00:07:af:ff:e3:c0	192.168.1.239	255.255.255.0	N-TRON Switch	GB2 GB1
11	00:07:af:ff:d5:40	192.168.1.230	255.255.255.0	N-TRON Switch	GB2 GB1
12	00:07:af:ff:e3:e0	192.168.1.215	255.255.255.0	N-TRON Switch	GB2 GB1

Below is an example of N-Ring Status from an N-Ring Manager with a faulted N-Ring. The red fields on the N-Ring Map show problems. Ports that are red indicate that the port is not linked. MAC addresses that are red indicate that there is no communication to that switch. The red “Ring Broken” line shows where the N-Ring is broken.

N-Ring Fault

N-Ring Status View

Switch is an N-Ring Manager, using N-Ring Aging Time = 20 Seconds

Refresh every secs.

The total number of Active N-Ring Members is unknown. (11 reporting)

Switch order may be incorrect and all switches may not be shown.

Switch No	MAC Address	IP Address	Subnet Mask	Name	Ports
RM	00:07:af:ff:e4:a0	192.168.1.227	255.255.255.0	N-TRON Switch	GB2 GB1
1	00:07:af:ff:ef:60	192.168.1.224	255.255.255.0	N-TRON Switch	GB2 GB1
2	00:07:af:ff:e6:a0	192.168.1.217	255.255.255.0	N-TRON Switch	GB2 GB1
3	00:07:af:ff:ef:80	192.168.1.221	255.255.255.0	N-TRON Switch	GB2 GB1
4	00:07:af:ff:e4:c0	192.168.1.241	255.255.255.0	N-TRON Switch	GB2 GB1
5	00:07:af:ff:d5:e0	192.168.1.229	255.255.255.0	N-TRON Switch	GB2 GB1
6	00:07:af:ff:d7:00	192.168.1.228	255.255.255.0	N-TRON Switch	GB2 GB1
7	00:07:af:ff:e6:c0	192.168.1.223	255.255.255.0	N-TRON Switch	GB2 GB1
8	00:07:af:ff:d5:20	192.168.1.231	255.255.255.0	N-TRON Switch	GB2 GB1
9	00:07:af:ff:e5:e0	192.168.1.238	255.255.255.0	N-TRON Switch	GB2 GB1
10	00:07:af:ff:e3:c0	192.168.1.239	255.255.255.0	N-TRON Switch	GB2 GB1
11	00:07:af:ff:d5:40	192.168.1.230	255.255.255.0	N-TRON Switch	GB2 GB1
~~~~~ Ring Broken ~~~~~					
12	<a href="#">00:07:af:ff:e3:e0</a>	192.168.1.215	255.255.255.0	N-TRON Switch	<b>GB2</b> GB1

In rare cases an N-Ring can have a “Partial Fault”. An example of this is to have a break in just one fiber in a duplex channel fiber pair. The screenshot below shows N-Ring Manager Status when a ‘Higher’ N-Ring Port (GB2 or FX2) is not receiving self health frames all the way around the N-Ring, though the other (low GB1/FX1) N-Ring port is:

**N-Ring Partial Fault (GB2 is not receiving self health from GB1)**

**N-Ring Status View**

Switch is an N-Ring Manager, using N-Ring Aging Time = 20 seconds

Refresh every  secs.           

---

0 Active Members Detected In Current N-Ring (0 reporting)

Switch No	MAC Address	IP Address	Subnet Mask	Name	Ports
RM	<a href="#">00:07:af:00:b1:40</a>	192.168.1.135	255.255.255.0	N-TRON Switch	GB2 GB1

The screenshot below shows N-Ring Manager Status when a ‘Lower’ N-Ring Port (GB1 or FX1) is not receiving self health frames all the way around the N-Ring, though the other (high GB2/FX2) N-Ring port is:

**N-Ring Partial Fault (GB1 is not receiving self health from GB2)**

**N-Ring Status View**

Switch is an N-Ring Manager, using N-Ring Aging Time = 20 seconds

Refresh every  secs.           

---

0 Active Members Detected In Current N-Ring (0 reporting)

Switch No	MAC Address	IP Address	Subnet Mask	Name	Ports
RM	<a href="#">00:07:af:00:b1:40</a>	192.168.1.135	255.255.255.0	N-TRON Switch	GB2 GB1

## Event Log – Log Statistics

The Log Statistics tab under the EventLog category will show a list of how many times a type of event took place. On the bottom of the page it also lists the maximum log size which can be modified. There are 5 types of events that the 7014 will categorize messages in. If the log level is set to 1, the 7014 will log all 5 types of events. If the log level is set to 5 it will only record the Critical types (the 5th level).

Event Log Configuration View	
<b>Total No of Events :9</b>	
Event Type	Count
Informational	5
Warning	1
Minor	0
Severe	3
Critical	0
<b>Log Size</b>	100
<b>Log Level</b>	1
<input type="button" value="Modify"/>	<input type="button" value="Refresh"/>

Following the Modify button on the previous example, the administrator can modify these two variables to adjust for how large he or she wants the log file to be and the log level.

Event Log Configuration	
<b>Event Log Size</b> :	<input type="text" value="100"/>
<b>Event Log Level</b> :	<input type="text" value="1"/>
<input type="button" value="Update"/>	<input type="button" value="Cancel"/>

## Event Log – Show Events

The Show Events tab under the Event Log category will show a list of events that have occurred in the order in which they occurred. There is a time stamp for each event and they are categorized by the severity of the event.

Events View					
S.No	Code No	Source Name	Severity	Event Description	Time Stamp
1	98	Network/Ports	Informational	Port10 Link Up	00:00:00:00:26:05
2	99	Network/Ports	Severe	Port10 Link Down	00:00:00:00:26:01
3	27	Bridging	Warning	Entry does not exists in the AET	00:00:00:00:18:35
4	98	Network/Ports	Informational	Port10 Link Up	00:00:00:00:00:04
5	116	Image Loader	Severe	Error connecting to control socket	00:00:00:00:53:09
6	98	Network/Ports	Informational	Port10 Link Up	00:00:00:00:12:00
7	99	Network/Ports	Severe	Port12 Link Down	00:00:00:00:11:57
8	98	Network/Ports	Informational	Port12 Link Up	00:00:00:00:00:05
9	98	Network/Ports	Informational	Port12 Link Up	00:00:00:00:00:05

Total Number of Events Logged:9

## Firmware/Config - TFTP

The TFTP tab under the Firmware/Config category gives the administrator the ability to upload or download a config file for a 7014 Series switch. This gives administrators the ability to backup their configurations to a server offsite in case they need to reload their custom configurations at a later time. Administrators are also given the ability to flash the switch in the field allowing them to update the firmware in the field without losing their current configurations and without having to send the unit back in to N-Tron for updates in the future. It is important not to cycle power on the switch or interrupt the data connection between the TFTP server and the switch while you are flashing or uploading or downloading a config file. The switch will not stop working if this does occur, but the administrator will have to retransfer the file.

Firmware Download/Config Upload/Download - TFTP	
Server IP Address	<input type="text" value="192.168.1.2"/>
File Name	<input type="text" value="config"/>
Transfer Type	<input type="text" value="Image Download"/> ▾
<input type="button" value="Action"/>	

Firmware/Config through TFTP Status
<b>Downloading the image through TFTP .....Please wait..</b>
<b>The Image has been downloaded successfully.....</b>
<b>Click to restart for changes to take effect.</b>
<input type="button" value="Restart"/>



## Firmware/Config - FTP

The FTP tab under the Firmware/Config category gives the administrator the ability to upload or download a config file for a 7014 Series switch. This gives administrators the ability to backup their configurations to a server offsite in case they need to reload their custom configurations at a later time. Administrators are also given the ability to flash the switch in the field allowing them to update the firmware in the field without losing their current configurations and without having to send the unit back in to N-Tron for updates in the future. It is important not to cycle power on the switch or interrupt the data connection between the FTP server and the switch while you are flashing or uploading or downloading a config file. The switch will not stop working if this does occur, but the administrator will have to retransfer the file.

Firmware Download/Config Upload/Download - FTP	
User Name	<input type="text" value="anonymous"/>
Password	<input type="password"/>
Server IP	<input type="text" value="192.168.1.2"/>
File Name	<input type="text" value="config"/>
Mode	Binary <input type="button" value="v"/>
Transfer Type	Image Download <input type="button" value="v"/>
<input type="button" value="Action"/>	

Firmware/Config through FTP Status
Downloading the image through FTP.....Please wait..
The Image has been downloaded successfully.....

## Support – Web Site and E-mail

If at any point in time you get confused or would like additional support directly from N-Tron, you may visit N-Tron’s web site, or e-mail N-Tron directory with the links provided for more information.

The screenshot shows a Microsoft Internet Explorer browser window displaying the N-Tron website. The address bar shows the URL <http://192.168.1.201/goform/successfulValidation>. The website header features the N-Tron logo and the tagline "THE INDUSTRIAL NETWORK COMPANY". A navigation menu on the left lists various services, with "Support" expanded to show "Web Site" and "E-mail". The main content area is titled "Support & Service" and contains the following text:

All N-TRON products carry a [1 year limited warranty](#) that includes cross-shipment of a replacement product to minimize downtime. Products are available directly from N-TRON, our network of Systems Integrators, Value Added Resellers, and our Catalog and Internet Partners.

[Click here to download our RMA Warranty Service Request form](#) in PDF format.

For additional information, contact us at the address, email or phone number below:

<b>N-TRON Corp.</b> 820 S. University Blvd. Suite 4E Mobile, Al. 36609	
<b>phone:</b>	251-342-2164
<b>fax:</b>	251-342-6353
<b>E-Mail</b>	<a href="mailto:support@n-tron.com">support@n-tron.com</a>

At the bottom of the page, there is a "Shop Our New Online Store" button. The browser's status bar at the bottom indicates "Done" and "Internet".

## BPCL – Broadcast Packet Count Limit Configuration

The BPCL link will display all the ports that are installed in the 7014 Series unit and will list the BPCL Percentage for each port. BPCL defaults to 3%. A modify button is provided to change these fields. These are egress filters.

Port Name	BPCL [%]
P1	3
P2	3
P3	3
P4	3
P5	3
P6	3
P7	3
P8	3
P9	3
P10	3
P11	3
P12	3

## BPCL – Broadcast Packet Count Limit Configuration (Continued)

Following the Modify button on the previous example, the administrator can modify the BPCL Percentage for each port.

**Broadcast Packet Count Limit Configuration**

Port Name :	P4
BPCL Percentage :	P1 P2 P3 P4 P5 P6 P7 P8 P9 P10 P11 P12 GB1 GB2 All

Update

**Broadcast Packet Count Limit Configuration**

Port Name :	P4
BPCL Percentage :	50

Update Cancel

## User Mgmt – Adding Users

The User Management link will display a list of all the users who have access to the management features of the switch and their access permissions.

Authorized Users		
Serial No	User Name	Access Permission
1	admin	admin

Following the Add button on the previous example, the administrator can add another user and assign the user a username, a password, and the user's permissions (user/administrator).

Add New User	
User Name	<input type="text" value="user"/>
Password	<input type="password" value="••••••"/>
Access Permission	<input type="text" value="User"/> ▼

A page should display after the administrator clicks the Add button stating that the user was successfully added.

Status of Adding a New User
New User Added Successfully

**NOTE:** *There are a maximum number of 5 users per switch. User permissions have the right to view switch configurations and to view current port settings, but cannot make any changes to these settings. Admin permissions have the right to change and view any switch configuration and to change and view any current port settings.*

## User Mgmt – Removing Users

In order to remove a user, simply click on the Remove button at the bottom of the page.

Authorized Users		
Serial No	User Name	Access Permission
1	admin	admin
2	user	user

Following the Remove button on the last page, the administrator can remove a user by entering in the user's name and clicking the Remove button.

Remove an Existing User	
User Name	<input type="text" value="user"/>

A page should follow stating that the user was successfully removed from the list.

Status of Removing an Existing User
User Removed from Existing List Successfully.

## LogicalView

The 7014 Web Management offers a logical view of the switch. Here a user or administrator can see a graphical depiction of the 7014 switch. Ports that are linked will turn green, while ports that are not linked will show up as black. The example below shows ports 1,3,5,6,7,8,9,10, and 12 linked. The other ports are currently in the down state (not being used).

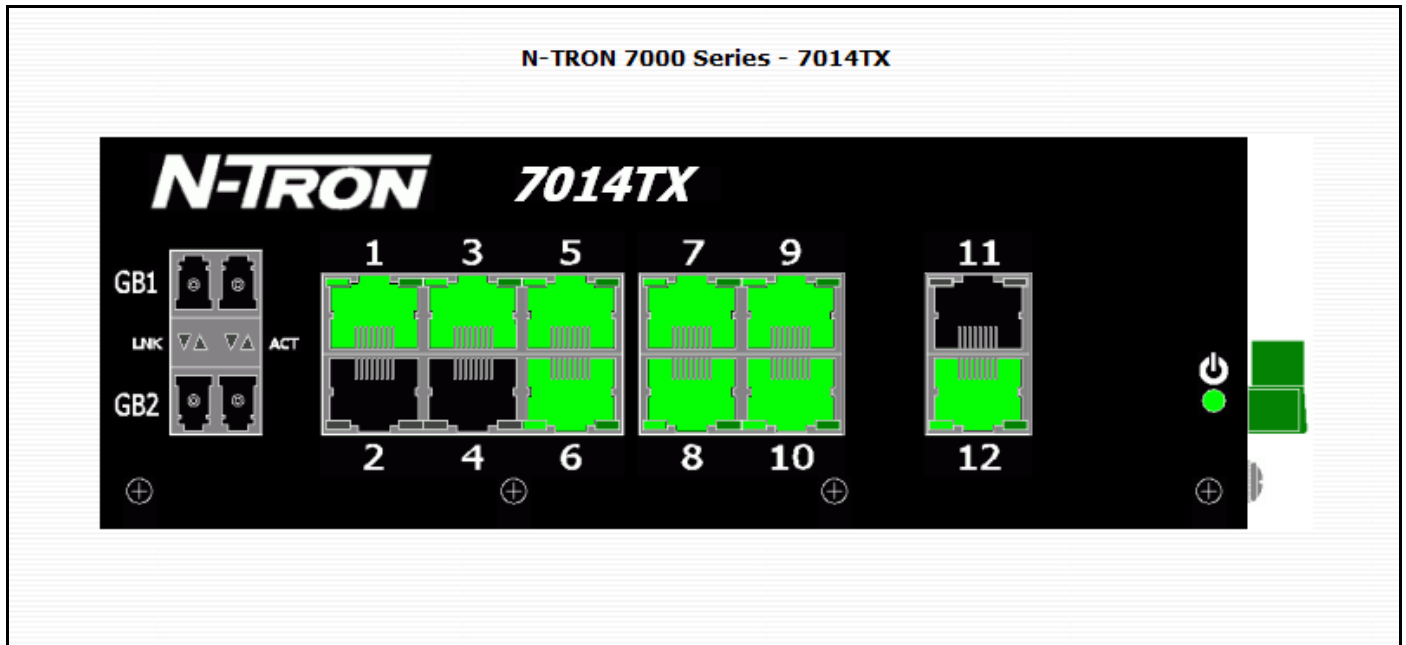

## Configuration – Save or Reset

The Configuration section of the web management gives an administrator the ability to save a running configuration into the NVRAM. This step is needed in order for the switch to remember any changes after a power cycle.

The Reset Configuration button will reload N-Tron’s factory default configuration settings. Doing so will re-configure the 7000 Series switch to factory defaults.

In many cases it is desirable to restore factory defaults but retain the IP, Slot Configuration, Subnet Mask, and Gateway Address settings. A choice is provided to this end.

**Configuration Save or Reset**

Click this button to save the current configuration.

Click this button to restore all factory defaults.

Click this button to restore factory defaults except for Slots configuration, and IP, Subnet and Gateway addresses.



# Help – Overview

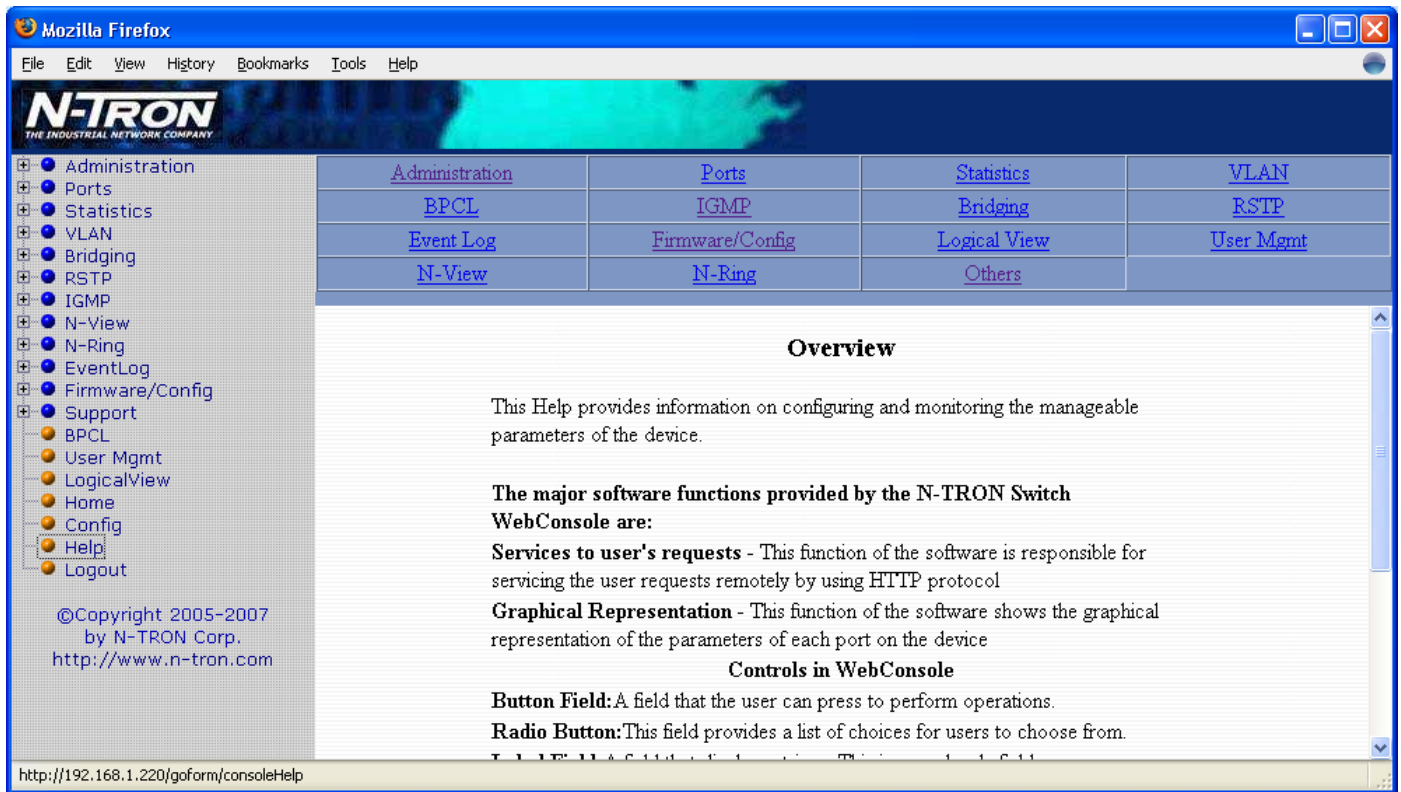

When the Help link is clicked on, you will see the Overview page that will have some basic definitions and more specific choices at the top of the screen. Although this page is not as detailed as the manual is, it gives you a basic feel for different features the 7014 offers.

# Help – Administration

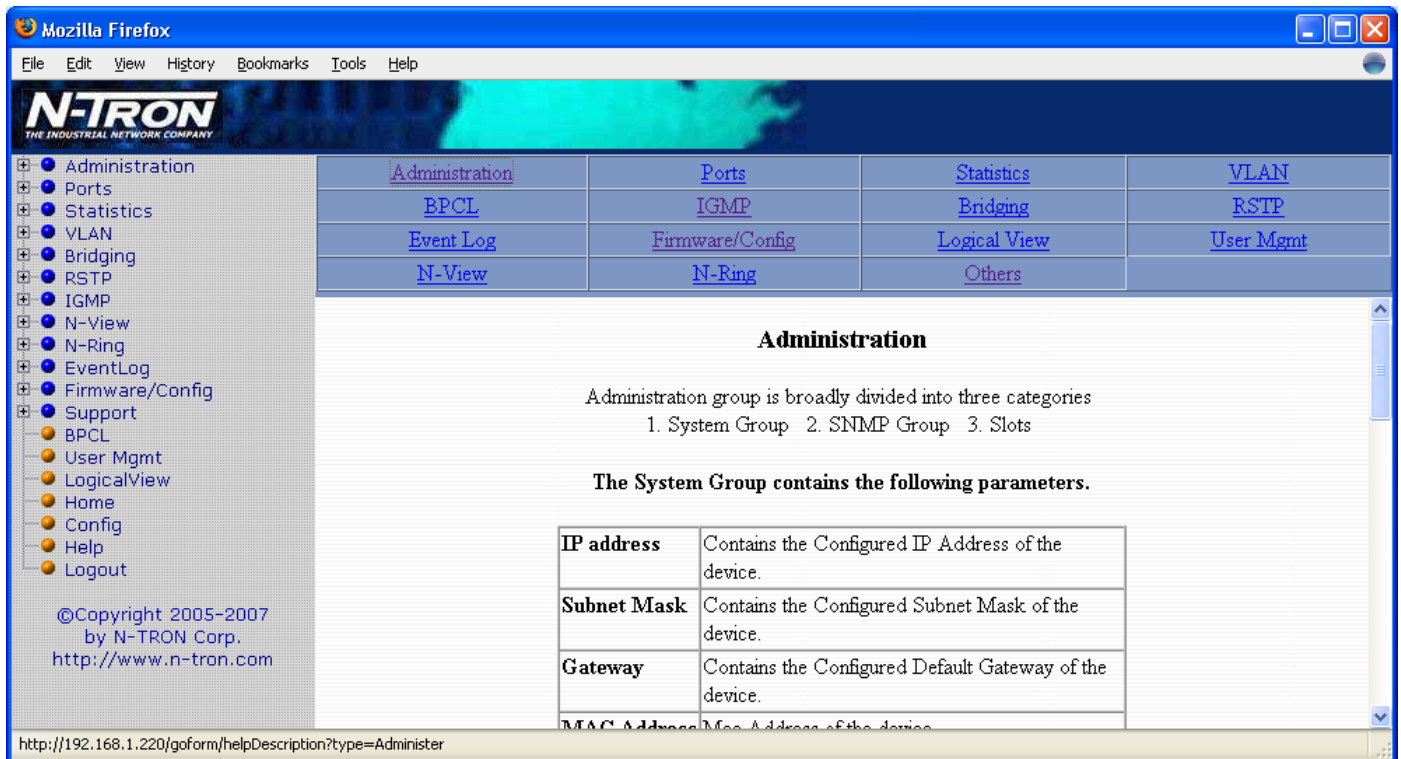

Selecting the Administration link on the help page, the administrator or user can see some information regarding the configuration options in the Administration category on the left side of the web management.

# Help – Ports

The screenshot shows a Mozilla Firefox browser window displaying the N-TRON web management interface. The browser title is "Mozilla Firefox". The address bar shows the URL "http://192.168.1.220/goform/helpDescription?type=Ports". The page content includes a navigation menu on the left, a top navigation bar with links like Administration, Ports, Statistics, and VLAN, and a main content area titled "Ports" with a table of port parameters.

**Ports**

Ports group is broadly divided into five categories

1. Configuration
2. Security
3. Intrusion Log
4. Mirroring
5. Trunking

**Port Configuration**

This Page shows all parameters(listed below) of each port in the switch

<b>Port No</b>	This is the port index.
<b>Port Name</b>	This field displays the name of the port.
<b>Admin Status</b>	This configurable field displays existing status of the port whether it is <b>Enabled/Disabled</b> .
<b>Port Link Status</b>	Current link state

Following the Ports link on the help page, the administrator or user can see some information regarding the configuration options in the Ports category on the left side of the web management.

## Help – Statistics

The screenshot shows the N-TRON web management interface. The browser window is Mozilla Firefox. The page has a blue header with the N-TRON logo and the text 'THE INDUSTRIAL NETWORK COMPANY'. Below the header is a navigation menu on the left with a tree view structure. The main content area features a table of links and a 'Statistics' section.

<a href="#">Administration</a>	<a href="#">Ports</a>	<a href="#">Statistics</a>	<a href="#">VLAN</a>
<a href="#">BPCL</a>	<a href="#">IGMP</a>	<a href="#">Bridging</a>	<a href="#">RSTP</a>
<a href="#">Event Log</a>	<a href="#">Firmware/Config</a>	<a href="#">Logical View</a>	<a href="#">User Mgmt</a>
<a href="#">N-View</a>	<a href="#">N-Ring</a>	<a href="#">Others</a>	

**Statistics**

Statistics group is broadly divided into two categories  
1. Ports Statistics 2. Ports Utilization

**Ports Statistics**

Displays the MIB counters for a given port, specified by the Port pull-down menu.  
Clicking the **Clear** button will reset all counters for the given port.

**Ports Utilization**

Shows a bandwidth percentage graph of all the ports. The graph is scaled based on the Scale pull-down menu.

©Copyright 2005-2007  
by N-TRON Corp.  
<http://www.n-tron.com>

Done

Following the Statistics link on the help page, the administrator or user can see some information regarding the configuration options in the Statistics category on the left side of the web management.

# Help – VLAN

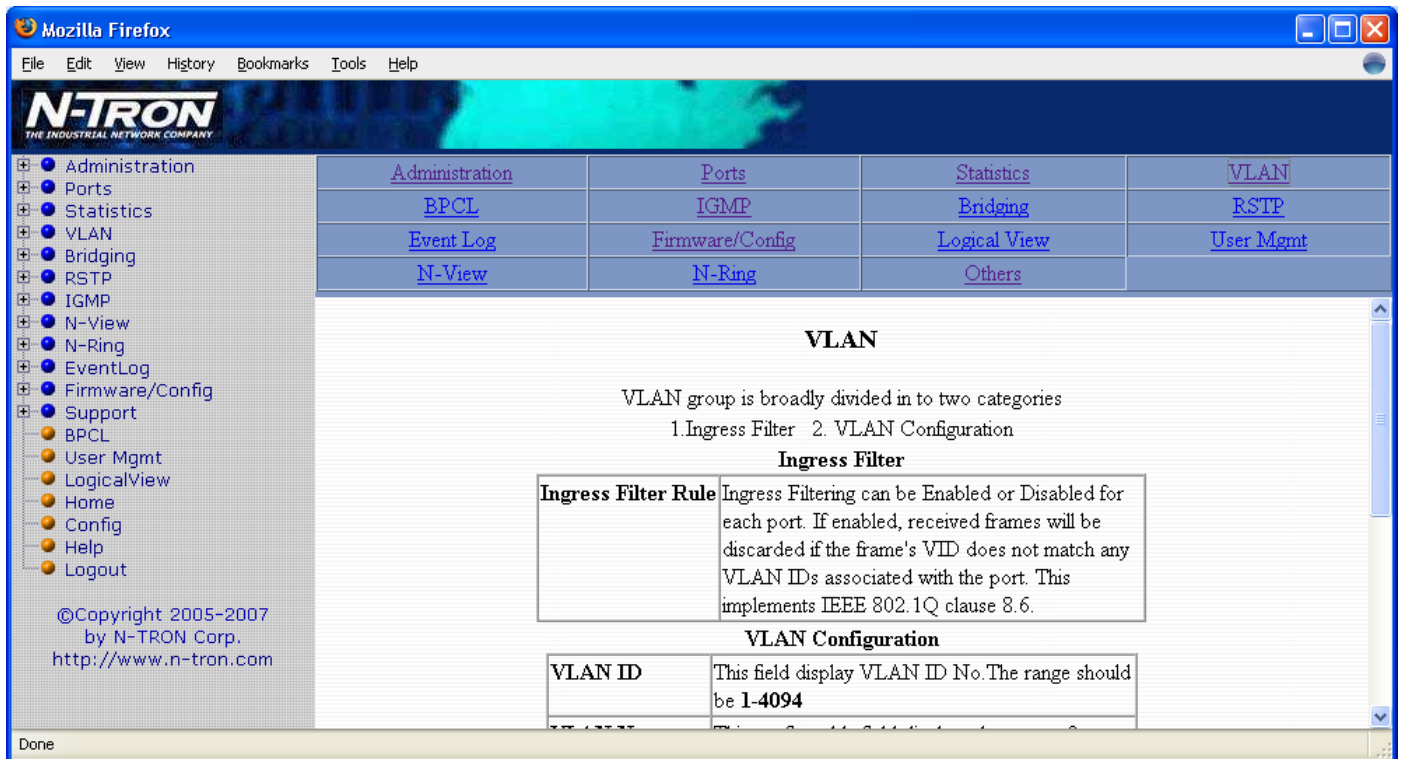

Using the VLAN link on the help page, the administrator or user can see some information regarding the configuration options in the VLAN category on the left side of the web management.

# Help – BPCL

**Broadcast Packet Count Limit**

**BPCL**

This Page shows the percentage of broadcast packets that will be accepted and forwarded.

<b>Port Name</b>	Descriptive name for the port
<b>BPCL [%]</b>	This configurable field displays the Broadcast traffic rate. The range should be <b>0-100</b> , the default is 3%.

The user can Modify the percentage on a particular port by clicking the **Modify** button

©Copyright 2006-2008  
by N-TRON Corp.  
<http://www.n-tron.com>

Using the BPCL the link on the help page, the administrator or user can see some information regarding the configuration options in the BPCL category on the left side of the web management.

## Help – IGMP

The screenshot shows the N-TRON web management interface. The left sidebar contains a navigation menu with the following items: Administration, Ports, Statistics, VLAN, Bridging, RSTP, IGMP, N-View, N-Ring, EventLog, Firmware/Config, Support, BPCL, User Mgmt, LogicalView, Home, Config, Help, and Logout. The top navigation bar includes links for Administration, Ports, Statistics, and VLAN. The main content area is titled "Internet Group Management Protocol (IGMP)" and contains the following text:

IGMP group consists of four categories

1. Configuration
2. Show Group
3. Show Router
4. RFilter Ports

**Configuration**

<b>IGMP Status</b>	Whether IGMP is enabled or disabled.
<b>Query Mode</b>	Can be Auto, On or Off
<b>Router Mode</b>	Can be Auto, None or Manual
<b>Manual Router Ports</b>	Port or ports that are specified as router ports manually.
<b>Router Add/Delete</b>	Either adds or deletes router ports to/from the port lists

©Copyright 2005-2007 by N-TRON Corp.  
http://www.n-tron.com

Following the IGMP link on the help page, the administrator or user can see some information regarding the configuration options in the IGMP category on the left side of the web management.

# Help – Bridging

The screenshot shows the N-TRON web management interface. The browser window is Mozilla Firefox. The page title is 'N-TRON THE INDUSTRIAL NETWORK COMPANY'. The navigation menu on the left includes: Administration, Ports, Statistics, VLAN, Bridging (selected), RSTP, IGMP, N-View, N-Ring, EventLog, Firmware/Config, Support, BPCL, User Mgmt, LogicalView, Home, Config, Help, and Logout. The main content area is titled 'Bridging' and contains the following text:

Bridging group is broadly divided into three categories  
1. Aging Time 2. Unicast Addresses 3. Multicast Addresses

**Aging Time**

<b>Aging Time</b>	This Configurable field displays the Aging Time for Dynamically Learned MAC Addresses. The inactive members will be removed from the Hardware Address Entry Table after this time period. The Aging Time range should be <b>5-1000000</b> . The default aging time is 20 Sec.
-------------------	-------------------------------------------------------------------------------------------------------------------------------------------------------------------------------------------------------------------------------------------------------------------------------

©Copyright 2005-2007 by N-TRON Corp.  
http://www.n-tron.com

http://192.168.1.220/goform/helpDescription?type=Bridging

Using the Bridging link on the help page, the administrator or user can see some information regarding the configuration options in the Bridging category on the left side of the web management.



# Help – RSTP

The screenshot shows a Mozilla Firefox browser window displaying the N-TRON web management interface. The browser's address bar shows the URL: <http://192.168.1.220/goform/helpDescription?type=RSTP>. The page title is "Rapid Spanning Tree Protocol (RSTP)".

The left sidebar contains a navigation menu with the following items:

- Administration
- Ports
- Statistics
- VLAN
- Bridging
- RSTP**
- IGMP
- N-View
- N-Ring
- EventLog
- Firmware/Config
- Support
- BPCL
- User Mgmt
- LogicalView
- Home
- Config
- Help
- Logout

The main content area features a table titled "RSTP root bridge information" with the following data:

RSTP root bridge information	
<b>Root Priority</b>	Priority of the Root Bridge
<b>Designated root</b>	The unique Bridge Identifier of the Bridge recorded as the Root in the Root Identifier parameter of Configuration BPDUs transmitted by the Designated Bridge for the LAN to which the Port is attached.
<b>Path Cost</b>	The cost of the path to the root offered by the Designated Port on the LAN to which this Port is

©Copyright 2005-2007 by N-TRON Corp.  
<http://www.n-tron.com>

Using the RSTP link on the help page, the administrator or user can see some information regarding the configuration options in the RSTP category on the left side of the web management.

# Help – Event Log

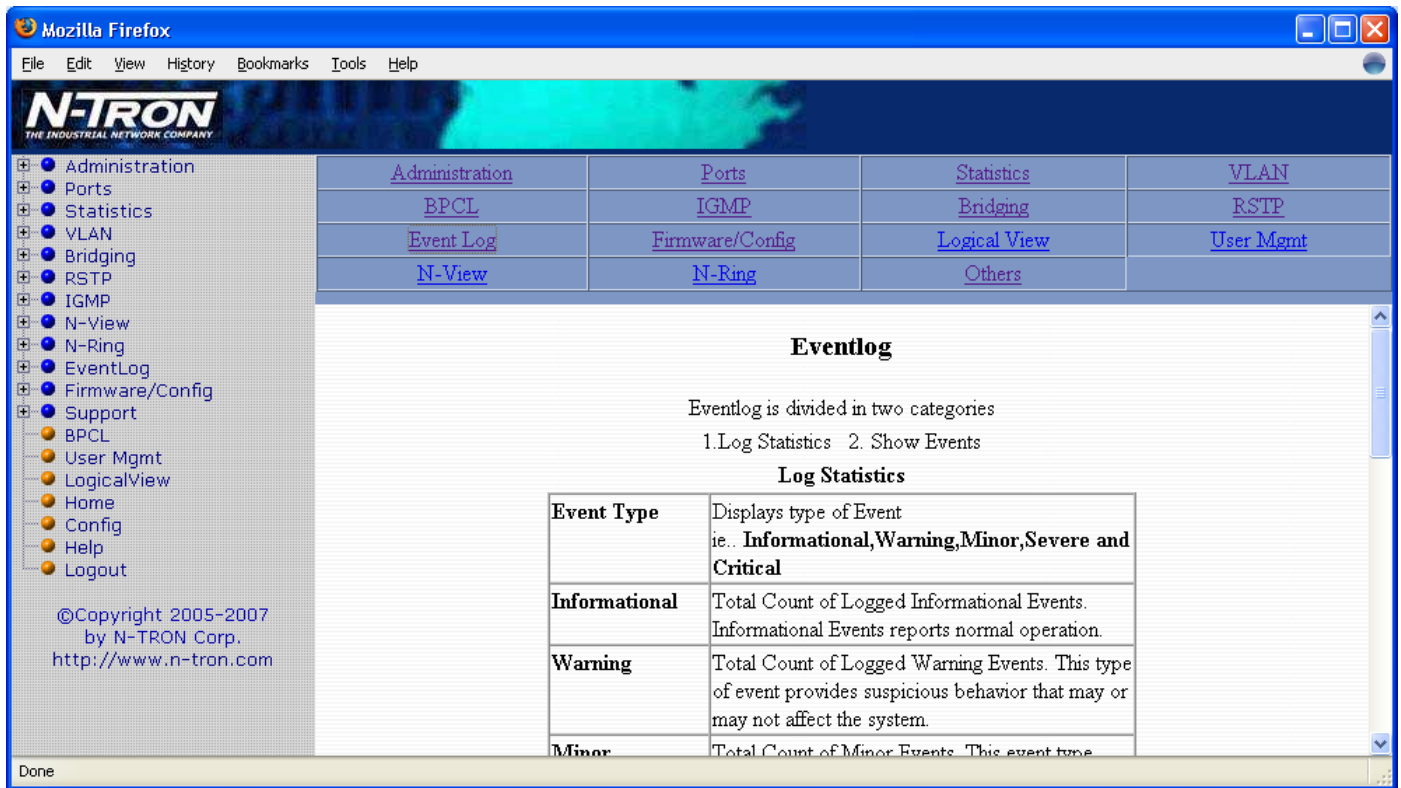

Using the Event Log link on the help page, the administrator or user can see some information regarding the configuration options in the Event Log category on the left side of the web management.

## Help – Firmware/Config

The screenshot shows the N-TRON web management interface. The left sidebar contains a navigation menu with the following items: Administration, Ports, Statistics, VLAN, Bridging, RSTP, IGMP, N-View, N-Ring, EventLog, Firmware/Config, Support, BPCL, User Mgmt, LogicalView, Home, Config, Help, and Logout. The main content area is titled "Firmware Download/ Config Upload/ Config Download - TFTP/FTP" and includes a sub-section for "TFTP".

The TFTP section contains the following text:

The firmware image can be downloaded onto the device (switch) using the TFTP protocol. The configuration data can be uploaded from or downloaded onto the device (switch) using the TFTP protocol.

<b>Server IP</b>	IP Address of the TFTP Server to which the connection is to be established.
<b>File Name</b>	Name of the file to be stored or retrieved.
<b>Transfer Type</b>	Type of transfer to be performed. It may be Image Download/config Upload/Config download.

At the bottom left of the browser window, the status bar shows "Done".

Using the Firmware/Config link on the help page, the administrator or user can see some information regarding the configuration options in the Firmware/Config category on the left side of the web management.

## Help – Logical View



Using the Logical View link on the help page, the administrator or user can see some information regarding the configuration options in the Logical View category on the left side of the web management.

## Help – User Mgmt

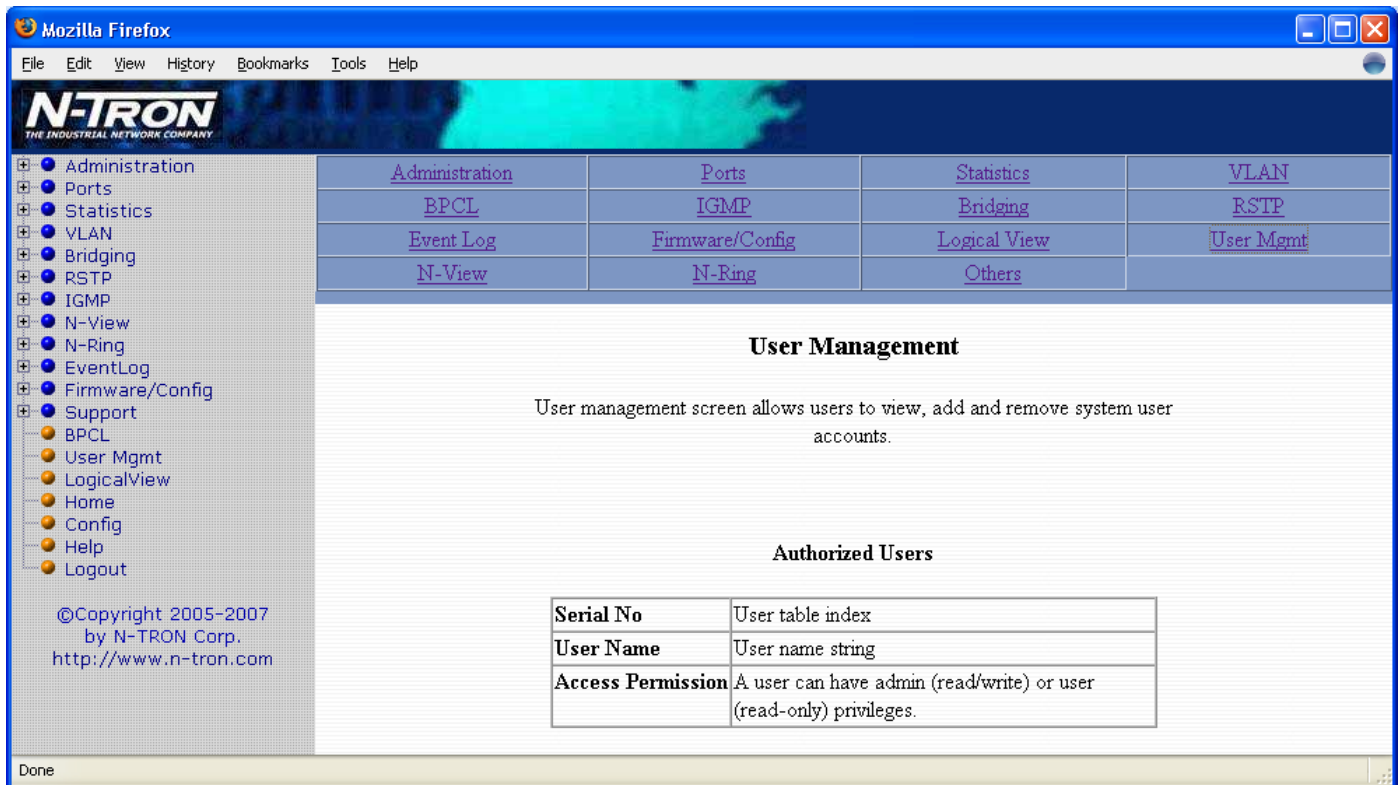

©Copyright 2005-2007  
by N-TRON Corp.  
<http://www.n-tron.com>

Done

<a href="#">Administration</a>	<a href="#">Ports</a>	<a href="#">Statistics</a>	<a href="#">VLAN</a>
<a href="#">BPCL</a>	<a href="#">IGMP</a>	<a href="#">Bridging</a>	<a href="#">RSTP</a>
<a href="#">Event Log</a>	<a href="#">Firmware/Config</a>	<a href="#">Logical View</a>	<a href="#">User Mgmt</a>
<a href="#">N-View</a>	<a href="#">N-Ring</a>	<a href="#">Others</a>	

### User Management

User management screen allows users to view, add and remove system user accounts.

#### Authorized Users

<b>Serial No</b>	User table index
<b>User Name</b>	User name string
<b>Access Permission</b>	A user can have admin (read/write) or user (read-only) privileges.

Using the User Mgmt link on the help page, the administrator or user can see some information regarding the configuration options in the User Mgmt category on the left side of the web management.

## Help – N-View

The screenshot shows a Mozilla Firefox browser window displaying the N-View help page. The browser's address bar is empty, and the page title is "N-View". The page content includes a navigation menu on the left, a main content area with a table of links, and a detailed view of the N-View configuration options.

**N-View**

N-View is divided in two categories

1. Configuration
2. Ports

**Configuration**

<b>N-View Status</b>	Global N-View enable or disable
<b>N-View Interval</b>	Global interval in seconds for autocasting MIB counters

©Copyright 2005-2007 by N-TRON Corp.  
http://www.n-tron.com

Using the N-View link on the help page, the administrator or user can see some information regarding the configuration options in the N-View category on the left side of the web management.

# Help – N-Ring

The screenshot shows the N-TRON web management interface. The browser window is Mozilla Firefox. The page has a blue header with the N-TRON logo and the text "THE INDUSTRIAL NETWORK COMPANY". Below the header is a navigation menu on the left with the following items: Administration, Ports, Statistics, VLAN, Bridging, RSTP, IGMP, N-View, N-Ring, EventLog, Firmware/Config, Support, BPCL, User Mgmt, LogicalView, Home, Config, Help, and Logout. The main content area has a table of links:

<a href="#">Administration</a>	<a href="#">Ports</a>	<a href="#">Statistics</a>	<a href="#">VLAN</a>
<a href="#">BPCL</a>	<a href="#">IGMP</a>	<a href="#">Bridging</a>	<a href="#">RSTP</a>
<a href="#">Event Log</a>	<a href="#">Firmware/Config</a>	<a href="#">Logical View</a>	<a href="#">User Mgmt</a>
<a href="#">N-View</a>	<a href="#">N-Ring</a>	<a href="#">Others</a>	

Below the table, the page is titled "N-Ring" and contains the text: "N-Ring is divided in two categories" followed by "1. Configuration 2. Status". Below this, there is a section titled "Configuration" with a table:

<b>N-Ring Mode</b>	Current N-Ring Mode of switch
<b>Port Set</b>	Port Set used if in N-Ring Manager Mode
<b>Show N-Ring Faults</b>	Show N-Ring Faults on N-Ring or All Web Pages if in N-Ring Manager Mode
<b>N-Ring Aging Time</b>	Aging Time Used When Switch Is Active In An

At the bottom left of the page, there is a copyright notice: "©Copyright 2005-2007 by N-TRON Corp. http://www.n-tron.com". The browser status bar at the bottom shows "Done".

Using the N-Ring link on the help page, the administrator or user can see some information regarding the configuration options in the N-Ring category on the left side of the web management.

## Help – Others

The screenshot shows the N-TRON web manager interface. On the left is a navigation menu with the following items: Administration, Ports, Statistics, VLAN, Bridging, RSTP, IGMP, N-View, N-Ring, EventLog, Firmware/Config, Support, BPCL, User Mgmt, LogicalView, Home, Config, Help, and Logout. Below the menu is the copyright information: ©Copyright 2005-2007 by N-TRON Corp. http://www.n-tron.com.

The main content area features a table of links:

<a href="#">Administration</a>	<a href="#">Ports</a>	<a href="#">Statistics</a>	<a href="#">VLAN</a>
<a href="#">BPCL</a>	<a href="#">IGMP</a>	<a href="#">Bridging</a>	<a href="#">RSTP</a>
<a href="#">Event Log</a>	<a href="#">Firmware/Config</a>	<a href="#">Logical View</a>	<a href="#">User Mgmt</a>
<a href="#">N-View</a>	<a href="#">N-Ring</a>	<a href="#">Others</a>	

Below the table, there is help information:

- Support website:** This link leads to the [http://www.n-tron.com/html/support_serv.html](http://www.n-tron.com/html/support_serv.html) web site, which is the official web site of N-TRON Corp., the developer of the switch software
- Support E-Mail:** To send any queries or suggestions to the support team at N-TRON Corp., - the developers of the switch software
- Configuration Save or Reset:** To save or reset the configuration data. This will save the current configuration of the device to the flash for future use.
- Logout:** To logout from the current session of configuration/management through WebConsole. The user may have to login again to start a new session.

Following the “Others” link on the help page, the administrator or user can see some information regarding other links or categories on the left hand side of the web manager, as above.



## CLI Commands

### Clear

Command Name	<b>clear</b>
Description	Clears the screen. The cleared screen shows only the command-line prompt and the cursor.
Syntax	<b>clear</b>
Parameters	<b>None</b>
Examples	N-TRON/Admin#[1]> clear <i>The entire screen will be cleared...</i> ... ... ... ... N-TRON/Admin#[2]>
NOTES	

### “?” (HELP)

Command Name	<b>“?”</b>
Description	Without <keywords>, this command will list all the available commands. This is the same as the default behavior of the <b>help</b> command.  If <keywords> is specified and if they match a specific command, the <b>usage</b> of the command will be displayed; otherwise, if <keywords> matches the prefix of a command(s), the name of the command(s) will be listed.  If ? is preceded by another ?, the usage and description of this command will be displayed.
Syntax	? <matched keywords> ? <command> ?
Parameters	<b>matched keywords</b> Prefixes of the command. <b>Command</b> Name of the any command supported by CLI
Examples	N-TRON/Admin#[1]> ? <i>The above command displays all the available commands.</i>  N-TRON/Admin#[2]> abcd ? Unknown command supplied as parameter.  N-TRON/Admin#[3]> clear ? Usage: clear  N-TRON/Admin#[4]> system ? System/  N-TRON/Admin#[5]> ? ?  <i>This displays the usage of “?” as shown below</i> [<keywords>] ?
NOTES	

## Top

Command Name	<b>top</b>
Description	Changes the context to the topmost (global) level. If already at the topmost context, the command is simply ignored
Syntax	<b>top</b>
Parameters	<b>None</b>
Examples	<pre>N-TRON/Admin#[1]system&gt; show N-TRON/Admin#[2]system/show&gt; top N-TRON/Admin#[3]&gt; top N-TRON/Admin#[4]&gt;</pre>
NOTES	

## Up

Command Name	<b>up</b>
Description	Changes the context to the next higher level. If already at the topmost context, the command is simply ignored
Syntax	<b>up</b>
Parameters	<b>None</b>
Examples	<pre>N-TRON/Admin#[1]&gt; system show N-TRON/Admin#[2]system/show&gt; up N-TRON/Admin#[3]system&gt; up N-TRON/Admin#[4]&gt; up N-TRON/Admin#[5]&gt;</pre>
NOTES	

## Logout

Command Name	<b>logout</b>
Description	Logs out the user from a CLI session. In case of a remote session, the session will be terminated after the user is logged out.
Syntax	<b>logout</b>
Parameters	<b>None</b>
Examples	<pre>N-TRON/Admin#[1] logout Hit &lt;ENTER&gt; to login:</pre>
NOTES	

## History

Command Name	<b>history</b>
Description	Lists all the commands in the history list for the current session, identifying each command with a reference number.
Syntax	<b>history</b>
Parameters	<ul style="list-style-type: none"><li><b>-reverse</b> reverse the order of display to be the most recent entry first.</li><li><b>-maxsize</b> set the maximum no. of entries that will be maintained in the list to the given value.</li><li><b>-clear</b> remove all entries in the command history list.</li></ul>
Examples	<pre>N-TRON/Admin#[1]&gt; history</pre> <p><i>The above command displays previously entered commands.</i></p>
NOTES	

“!”

Command Name	!
Description	<p>Repeats the command in the history list identified by &lt;command-reference&gt;.</p> <p><b>!!</b> – repeats the last command executed.</p> <p><b>!&lt;n&gt;</b> – repeats the command in the history list associated with reference number &lt;n&gt;.</p> <p><b>!&lt;str&gt;</b> – repeats the most recent command that begins with the string &lt;str&gt;.</p> <p>Any non-whitespace characters that follow are appended to the referenced command prior to its execution.</p>
Syntax	<p><b>!&lt;n&gt;</b></p> <p><b>!&lt;str&gt;</b></p>
Parameters	<p><b>N</b> It is the reference number of the command from history list that has to be repeated.</p> <p><b>Str</b> The most recent command from the history list that begins with keyword <b>str</b>.</p>
Examples	<pre>N-TRON/Admin#[1]&gt; !! Referenced command is not in the history list.  N-TRON/Admin#[2]&gt; !1 Referenced command is not in the history list.  N-TRON/Admin#[3]&gt; !s Referenced command is not in the history list.  N-TRON/Admin#[4]&gt; whoami admin    with privilege of Administrator  <i>here comes the usage of “!” command</i> N-TRON/Admin#[5]&gt; !w whoami admin    with privilege of Administrator  N-TRON/Admin#[6]&gt; !2 <i>The above command will execute the second command, which is available in history list.</i>  N-TRON/Admin#[7]&gt; !system <i>The above command will execute the latest command in the history list that starts with system.</i></pre>
NOTES	

## “\$”

Command Name	<b>\$</b>
Description	This command copies the command identified by reference number <command no> from the history list into the next command line allowing the user to edit the command for corrections or changes.
Syntax	<b>\$&lt;n&gt;</b>
Parameters	<b>n</b> The reference number of the command in the history list that has to be edited.
Examples	<pre>N-TRON/Admin#[1]&gt; whoaim</pre> <p><i>As shown above the command whoaim was entered instead of whoami. To edit the already entered command do as follows.</i></p> <pre>N-TRON/Admin#[2]&gt; \$1</pre> <pre>N-TRON/Admin#[2]&gt; whoaim</pre> <p><i>Now we can edit the command at the command prompt.</i></p>
NOTES	After entering ‘\$1’ at the prompt, it displays the previously entered command.

## Whoami

Command Name	<b>whoami</b>
Description	This command displays the current operating mode of the user.
Syntax	<b>whoami</b>
Parameters	<b>None</b>
Examples	<p><i>eg.1</i></p> <pre>N-TRON/Admin#[5]&gt;whoami</pre> <pre>admin    with privilege of Administrator</pre> <p><i>eg.2</i></p> <pre>N-TRON/User#[5]&gt; whoami</pre> <pre>user    with privilege of User</pre>
NOTES	

## Ping

Command Name	<b>ping</b>
Description	To issue the ping request to a specified host.
Syntax	<b>ping &lt;hostip-address&gt; [count]</b>
Parameters	<b>hostip-address</b> IP Address of the host to give the ping request. <b>count</b> Count the number of times to give the ping request (range 5-50).
Example	<pre>ping 10.1.6.15</pre> <pre>ping 10.1.6.15 10</pre>
Notes	

## System Configuration Commands

### Set Mode IP config

Command Name	<b>system set modeipconfig</b>
Description	To set the IP address mode of the system
Syntax	<b>system set modeipconfig</b> <manual/dhcp/bootp>
Parameters	<p><b>manual</b> Uses a static IP address scheme (default mode)</p> <p><b>dhcp</b> Pulls an IP address from a DHCP server on the LAN</p> <p><b>bootp</b> Pulls an IP address from a Bootp server on boot up</p>
Example	N-TRON/Admin#[1]> system set modeipconfig dhcp
NOTES	Bootp is an older version of DHCP, DHCP is recommended for a dynamic address scheme.

### Set IP/Subnet/Gateway Addresses of the system

Command Name	<b>system set ip</b>
Description	To set the IP address of the system
Syntax	<b>system set ip</b> <IP-address> <subnet>[ <gateway>]
Parameters	<p><b>IP Address</b> The IP address of the system in dotted decimal notation</p> <p><b>Subnet</b> The subnet of the above specified IP Address</p> <p><b>Gateway</b> The gateway address of the system.</p>
Example	<pre>N-TRON/Admin#[1]&gt; system set ip 10.1.1.158 255.0.0.0 N-TRON/Admin#[2]&gt; system set ip 10.1.6.150 255.255.255.0 10.1.6.150</pre>
NOTES	The IP address should be a valid IP address (excluding Class D & Class E type)

### Get IP Address of the system

Command Name	<b>system get ip</b>
Description	To display the IP/Subnet/Gateway addresses of the device
Syntax	<b>system get ip</b>
Parameters	<b>None</b>
Example	N-TRON/Admin#[1]> system get ip
NOTES	

### Set System Name

Command Name	<b>system set sysname</b>
Description	To set the system name
Syntax	<b>system set sysname</b> <Name-of-the-system>
Parameters	<p><b>Name-of-the-system</b> The system name to be used</p>
Example	<pre>N-TRON/Admin#[1]&gt; system set sysname N-Tron N-TRON/Admin#[2]&gt; system set sysname "N-Tron Switch"</pre>
Notes	Please ensure to use “ ” for supplying arguments with spaces

### Get System Name

Command Name	<b>system get sysname</b>
Description	To display the name of the system
Syntax	<b>system get sysname</b>
Parameters	<b>None</b>
Example	N-TRON/Admin#[1]> system get sysname  System Name : N-TRON Switch
Notes	

### Get Gateway Address of the System

Command Name	<b>system get gateway</b>
Description	To display the gateway address of the system
Syntax	<b>system get gateway</b>
Parameters	<b>None</b>
Example	N-TRON/Admin#[4]> system get gateway  System Gateway Address : 192.168.1.1
Notes	

### Get Mac Address of the System

Command Name	<b>system get sysmac</b>
Description	To display the mac address of the device
Syntax	<b>system get sysmac</b>
Parameters	<b>None</b>
Example	N-TRON/Admin#[1]> system get sysmac  System MAC Address : 00:07:af:00:00:00
Notes	

### Get Netmask of the System

Command Name	<b>system get netmask</b>
Description	To display the netmask/subnet of the device
Syntax	<b>system get netmask</b>
Parameters	<b>None</b>
Example	N-TRON/Admin#[8]> system get netmask  System Subnet : 255.255.255.0
Notes	

### Get System Contact

Command Name	<b>system get syscontact</b>
Description	To get the contact person name of the device.
Syntax	<b>system get syscontact</b>
Parameters	<b>None</b>
Example	N-TRON/Admin#[10]> system get syscontact  System Contact : N-TRON Admin
Notes	

### Set System Contact

Command Name	<b>system set syscontact</b>
Description	To set the contact details for the system
Syntax	<b>system set syscontact</b> <Contact-for-the-system>
Parameters	<b>Contact-for-the-system</b> The details of the person to be contacted for this system in case of any queries or problems
Example	N-TRON/Admin#[1]> system set syscontact <a href="mailto:admin@N-Tron.com">admin@N-Tron.com</a> N-TRON/Admin#[2]> system set syscontact "Support Team"
Notes	Please ensure to use "" for supplying arguments with spaces

### Get System Location

Command Name	<b>system get syslocation</b>
Description	To display the system location details.
Syntax	<b>system get syslocation</b>
Parameters	<b>None</b>
Example	N-Tron/Admin#[1]> system get syslocation
Notes	

### Set System Location

Command Name	<b>system set syslocation</b>
Description	To set the location details of the system
Syntax	<b>system set syslocation</b> <Location-of-the-system>
Parameters	<b>Location-of-the-system</b> The details of where the system is located
Example	N-TRON/Admin#[1]> system set syslocation "San Jose" N-TRON/Admin#[2]> system set syslocation Hyderabad
Notes	Please ensure to use "" for supplying arguments with spaces

### Get System Uptime

Command Name	<b>system get sysuptime</b>
Description	To get the uptime of the device.
Syntax	<b>system get sysuptime</b>
Parameters	<b>None</b>
Example	N-TRON/Admin#[1]> system get sysuptime  System Up Time : 9 days:17 hours:8 mins:40 secs
Notes	

### Get Number of Ports present in the System

Command Name	<b>system get portcount</b>
Description	To get the number of ports present in the device.
Syntax	<b>system get portcount</b>
Parameters	<b>None</b>
Example	N-TRON/Admin#[1]> system get portcount
Notes	

### Set System Gigabit

Command Name	<b>system set gigabit</b>
Description	To set the optional gigabit port details of the system
Syntax	<b>system set gigabit</b> <number> <None FX TX>
Parameters	<b>Gigabit-ports-of-the-system</b> The details of the optional gigabit ports of the system.
Example	N-TRON/Admin#[1]> system set gigabit 1 TX
Notes	



### Set IP Address of the SNMP Manager

Command Name	<b>system set snmpmgmtip</b>
Description	To set the IP address of the SNMP manager
Syntax	<b>Usage: system set snmpmgmtip &lt;station_num&gt; &lt;snmpgmt_ip&gt;</b>
Parameters	<b>Station Number</b> 1->5. <b>IP Address</b> The IP address of the SNMP manager in dotted decimal notation
Example	N-TRON/Admin#[1]> system set snmpmgmtip 10.1.5.100  N-TRON/Admin#[2]> system set snmpmgmtip 10.1.6.150
NOTES	The IP address should be a valid IP address (excluding Class D & Class E type). To restore a Trap to "Value Not Configured", enter '0.0.0.0'.

### Set SNMP Get Community name

Command Name	<b>system set snmpgetcommunity</b>
Description	To set the community name for performing snmpget operation
Syntax	<b>system set snmpgetcommunity &lt;Community-Name&gt;</b>
Parameters	<b>Community-Name</b> The name of the community to be used for performing snmpget operation
Example	N-TRON/Admin#[1]> system set snmpgetcommunity public  N-TRON/Admin#[1]> system set snmpgetcommunity "N-Tron Systems"
Notes	Please ensure to use "" for supplying arguments with spaces

### Set SNMP Set Community name

Command Name	<b>system set snmpsetcommunity</b>
Description	To set the community name for performing snmpset operation
Syntax	<b>system set snmpsetcommunity &lt;Community-Name&gt;</b>
Parameters	<b>Community-Name</b> The name of the community to be used for performing snmpset operation
Example	N-TRON/Admin#[1]> system set snmpsetcommunity private  N-TRON/Admin#[1]> system set snmpsetcommunity "N-Tron Systems"
Notes	Arguments cannot have spaces. You can use an underscore ('_') instead of a space.

### Set SNMP Trap Community name

Command Name	<b>system set snmptrapcommunity</b>
Description	To set the community name for raising snmp trap
Syntax	<b>system set snmptrapcommunity &lt;Community-Name&gt;</b>
Parameters	<b>Community-Name</b> The name of the community to be used for raising snmp trap
Example	N-TRON/Admin#[1]> system set snmptrapcommunity private  N-TRON/Admin#[1]> system set snmptrapcommunity "N-Tron Systems"
Notes	Arguments cannot have spaces. You can use an underscore ('_') instead of a space.

**Show all configuration parameters**

Command Name	<b>system show config</b>
Description	Displays the software version, the mac address, and status of gigabit ports.
Syntax	<b>system show config</b>
Parameters	<b>None</b>
Example	<pre>N-TRON/Admin#[32]system/show&gt; config  System Configuration      : Product Configuration    : 7014FX2 Software Version         : 1.1.8 MAC Address               : 00:07:af:ff:e5:60 IP Configuration Mode    : manual System IP Address        : 192.168.1.244 Subnet Mask               : 255.255.255.0 Gateway Address          : 192.168.1.1 System Name               : N-TRON Switch System Contact           : N-TRON Admin System Location           : Mobile, AL 36609 System Up Time           : 0 days:0 hours:28 mins:43 secs  Total Number of Ports    : 14 Port # 1 - 12            : 10/100 Mbps Copper and/or                         : 100 Mbps Fiber Port # 13                 : Gigabit Transceiver Port # 14                 : Gigabit Transceiver</pre>
Notes	

**Show all configuration parameters related to SNMP manager**

Command Name	<b>system show snmpinfo</b>
Description	To show all the configuration parameters related to snmp manager
Syntax	<b>system show snmpinfo</b>
Parameters	<b>None</b>
Example	<pre>N-TRON/Admin#[33]system/show&gt; snmpinfo  System SNMP Configuration : IP Address - Trap Station#1 : 192.168.1.2 IP Address - Trap Station#2 : Value Not Configured IP Address - Trap Station#3 : Value Not Configured IP Address - Trap Station#4 : Value Not Configured IP Address - Trap Station#5 : Value Not Configured SNMP Get Community Name    : public SNMP Set Community Name    : private SNMP Trap Community Name   : public</pre>
Notes	

**System Restart**

Command Name	<b>system restart</b>
Description	To restart (reboot) the device
Syntax	<b>system restart</b>
Parameters	<b>None</b>
Example	<pre>N-TRON/Admin#[1]&gt; system restart  Do you Want to Restart the System Now: [y/n]y Do you Want to Save the Configuration: [y/n]y ..... .....</pre>
Notes	

# User Management Commands

## Show System Users

Command Name	<b>system show users</b>
Description	Shows a list of users and their permissions on the system
Syntax	<b>system show users</b>
Parameters	<b>None</b>
Example	<pre>N-TRON/Admin#[1]&gt; system show users  Serial  Username          Access Permissions -----  - 1       admin                admin 2       ntron                 user</pre>
NOTES	

## Add a System User

Command Name	<b>system add user</b>
Description	To add a user to the system
Syntax	<b>system add user</b> <username> [access permission]
Parameters	<p><b>Username</b> A string of at least 3 characters and no more than 15 characters</p> <p><b>Access permission</b> “user” or “admin” permission rights</p> <p><b>Password</b> Administrator will be prompted for a password of 3 to 15 characters in length.</p>
Example	<pre>N-TRON/Admin#[1]&gt; system add user ntron user Enter User Password :****</pre>
NOTES	Users with User permissions can not make changes to the switch, but can view configuration settings and port settings. Users with admin permissions have the ability to change settings on the switch and can add more users. There is a limit of 5 users per switch with any combination of permissions.

## Modify a User’s Access Permissions

Command Name	<b>system modify useraccess</b>
Description	To change a user’s permissions
Syntax	<b>system modify useraccess</b> <username> <access permission>
Parameters	<p><b>Username</b> The user’s username that is to be modified.</p> <p><b>Access permission</b> “user” or “admin” permission rights</p>
Example	<pre>N-TRON/Admin#[1]&gt; system modify useraccess ntron admin</pre>
NOTES	User must have admin permissions to use this command

### Modify a User's Password

Command Name	<b>system modify userpassword</b>
Description	To change a user's password
Syntax	<b>system modify userpassword</b> <username>
Parameters	<b>Username</b> The user's username that is to be modified <b>Password</b> The new password for the user
Example	N-TRON/Admin#[1]system/modify> userpassword ntron Enter New Password :***** Confirm New Password :***** Password has been modified successfully
Notes	A user with user permissions can operate this command, but will be prompted for the old password before being prompted for the new password.

### Remove a System User

Command Name	<b>system remove user</b>
Description	To remove a user from the users list
Syntax	<b>system remove user</b> <username>
Parameters	<b>username</b> The user's username that is to be removed
Example	N-TRON/Admin#[1]> system remove user ntron Do you really want to delete the above user: [y/n]y User successfully deleted
Notes	Only users with admin permissions can operate this command.

## Image Loader Commands

### Download Image through COM port

Command Name	<b>image download</b>
Description	To download new firmware image through the serial port on the switch.
Syntax	<b>image download</b>
Parameters	<b>None</b>
Examples	N-TRON/Admin#[1]> image download
NOTES	Uses XModem protocol when transferring the file. N-Tron recommends that you use TFTP or FTP when updating the firmware. TFTP and FTP are both much faster.

# TFTP Commands

## Set the TFTP configuration parameter

Command Name	<b>tftp set</b>
Description	To set the TFTP configuration parameters TFTP Server IP Address and Remote File name.
Syntax	<b>tftp set serverparam &lt;ip-address&gt; &lt;remote-file-name&gt;</b>
Parameters	<p><b>ip-address</b> TFTP Server IP Address in dotted decimal notation for establishing the connection to transfer the file.</p> <p><b>remote-file-name</b> Name of the remote file (<i>including complete path</i>) to be retrieved from the TFTP Server.</p>
Examples	<p><i>eg.1</i> N-TRON/Admin#[1]&gt; tftp set serverparam 10.1.1.151 flash</p> <p><i>eg.2</i> N-TRON/Admin#[1]&gt; tftp set serverparam 10.1.1.151 /usr/local/tftp/flash</p>
NOTES	Please ensure that TFTP ServerIP is a valid IP Address by pinging it.

## Show TFTP configuration parameters

Command Name	<b>tftp show</b>
Description	To display the present values of all the TFTP related configuration parameters.
Syntax	<b>tftp show</b>
Parameters	<b>None</b>
Examples	N-TRON/Admin#[1]> tftp show
NOTES	Displays the Server IP Address and Filename.

## Download file from TFTP server

Command Name	<b>tftp action get</b>
Description	To download a specified file from the TFTP server.
Syntax	<b>tftp action get</b>
Parameters	<b>None</b>
Examples	N-TRON/Admin#[1]> tftp action get
NOTES	<p>Check whether the server is up or not</p> <p>Check that the connection is established.</p> <p>Check if the file exists or not.</p> <p>Check the number of bytes downloaded</p>

# FTP Commands

## Set Username

Command Name	<b>ftp set username</b>
Description	To set the user name which will be used to log into the FTP server
Syntax	<b>ftp set username</b> <Username>
Parameters	<b>Username</b> The user name for logging on to the FTP server
Example	<i>eg.1</i> N-TRON/Admin#[1]> ftp set username ntron <i>eg.2</i> N-TRON/Admin#[1]> ftp set username admin
Notes	The user name should be a valid one; else logging into FTP server will fail.

## Set Password

Command Name	<b>ftp set password</b>
Description	To set the password for the above user name
Syntax	<b>ftp set password</b>
Parameters	<b>Password</b> Password for the above user required to log into the FTP server
Example	N-TRON/Admin#[1]> ftp set password Enter the password : *****
Notes	The password should be a valid one for the user; else logging into the FTP server will fail.

## Set IP Address of FTP server

Command Name	<b>ftp set serverip</b>
Description	To set the IP address of the FTP server to be used for establishing the FTP connection for transfer of files/data
Syntax	<b>ftp set serverip</b> <Server-IP-address>
Parameters	<b>Server-IP-address</b> The IP address of the FTP server in decimal dotted notation for establishing a FTP connection
Example	<i>eg.1</i> N-TRON/Admin#[1]> ftp set serverip 10.1.1.100 <i>eg.2</i> N-TRON/Admin#[1]> ftp set serverip 15.1.1.150
Notes	The IP address of the FTP server should be a valid IP address (excluding Class D & Class E types). The IP address should also be a valid FTP server IP in order to ensure successful connection establishment.

## Set Name of the Remote File

Command Name	<b>ftp set remotefile</b>
Description	To set the name of the remote file which has to be retrieved from the FTP server
Syntax	<b>ftp set remotefile</b> <Remote-file-name>
Parameters	<b>Remote-file-name</b> Name of the file to retrieved from the FTP server including the complete path
Example	<i>eg.1</i> N-TRON/Admin#[1]> ftp set remotefile Flash <i>eg.2</i> N-TRON/Admin#[1]> ftp set remotefile /usr/local/ftp/flash
Notes	The file name (including the complete path) should be a valid name else retrieval of the file would fail.

### Display FTP related configuration parameters

Command Name	<b>ftp show</b>
Description	To display the present value of all the FTP related configuration parameters
Syntax	<b>ftp show</b>
Parameters	<b>None</b>
Example	N-TRON/Admin#[1]> ftp show
Notes	

### Perform the configuration file transfer action

Command Name	<b>ftp &lt;get put&gt; config</b>
Description	To perform the desired File Transfer action (either get or put). Get retrieves a remote file from the FTP server and put stores a local file at the FTP server
Syntax	<b>ftp get config</b> <b>ftp put config</b>
Parameters	<b>Action-command</b> The desired File transfer action (either get or put)
Example	<i>eg.1</i> N-TRON/Admin#[1]> ftp get config <i>eg.2</i> N-TRON/Admin#[1]> ftp put config
Notes	The action name should be either get or put

### Perform the image file transfer action

Command Name	<b>ftp get image</b>
Description	To perform the desired File Transfer action. Get retrieves a remote file from the FTP server
Syntax	<b>ftp get image</b>
Parameters	<b>None</b>
Example	N-TRON/Admin#[1]> ftp get image
Notes	Can only get an image from a server

## Port Manager Commands

### Get the link state of a given port

Command Name	<b>port get linkstate</b>
Description	This command is used to get the present link state of a given port. Whenever there is an active connection, link state (operational state) is up; else link state is down.
Syntax	<b>port get linkstate</b> <port-no>
Parameters	<b>port-no</b> Port number. (1 ~ 14).
Examples	N-TRON/Admin#[1]> port get linkstate 3 Link state of [3] port is: [down]  N-TRON/Admin#[2]> port get linkstate 1 Link state of [1] port is: [up]
NOTES	Check whether <i>port-no</i> is in the valid range. (1 ~ 14)

### Get admin status of the port

Command Name	<b>port get adminstatus</b>
Description	This command is used to the get present adminstatus of a given port. Adminstatus is used to enable or disable the port operations even though there are active connections.
Syntax	<b>port get adminstatus</b> <port-no>
Parameters	<b>port-no</b> Port number. (1 ~ 14).
Examples	N-TRON/Admin#[1]> port get adminstatus 4 Admin state of [4] port is: [enable]  N-TRON/Admin#[2]> port get adminstatus 9 Admin state of [9] port is: [disable]
NOTES	Check whether <i>port-no</i> is in the valid range. (1 ~ 14)

### Set admin status of a port

Command Name	<b>port set adminstatus</b>
Description	This command is used to set the adminstatus of a given port to enable or disable. If the adminstatus is disabled, the port cannot process the received packets.
Syntax	<b>port set adminstatus</b> <port-no><enable / disable>
Parameters	<b>1. port-no</b> Port number. (1 ~ 14). <b>2. adminstatus</b> adminstatus is either enable or disable.
Examples	N-TRON/Admin#[1]> port set adminstatus 4 enable  N-TRON/Admin#[2]> port set adminstatus 8 disable
NOTES	Check whether <i>port-no</i> is in the valid range. (1 ~ 14)



### Show port statistics

Command Name	<b>port show stats</b>
Description	This command is used to get the port statistics of a given port for all available counters.
Syntax	<b>port show stats</b> <port-no>
Parameters	<b>port-no</b> Port number. (1 ~ 14).
Examples	<pre>N-TRON/Admin#[1]&gt; port show stats 5 -----                 COUNTER TYPE  :[] ----- COUNTER NAME          COUNTER VALUE ----- byteFrames             28072 64 byte Frames         272 64-127 byte Frames     24 128-255 byte Frames    43 256-511 byte Frames    43 512-1023 byte Frames   0 1024-1518 byte Frames  0 1519-1522 byte Frames  0 .....</pre>
NOTES	Check whether <i>port-no</i> is in the valid range. (1 ~ 14)

### Get total number of good frames received

Command Name	<b>port get totalgoodframes</b>
Description	Gets the total number of good frames received on the switch.
Syntax	<b>port get totalgoodframes</b>
Parameters	None
Examples	<pre>eg.1 N-TRON/Admin#[1]&gt; port get totalgoodframes Total no of good frames: [12456] eg.2 N-TRON/Admin#[1]&gt; port get totalgoodframes Total no of good frames: [56732]</pre>
NOTES	

### Get port speed

Command Name	<b>port get speed</b>
Description	Gets the port speed in megabits.
Syntax	<b>port get speed</b> <port-no>
Parameters	<b>port-no</b> Port number. (1 ~ 14).
Examples	<pre>N-TRON/Admin#[1]&gt; port get speed 4 port speed of port no [4] is : [10] N-TRON/Admin#[2]&gt; port get speed 5 port speed of port no [5] is : [100]</pre>
NOTES	Check whether <i>port-no</i> is in the valid range. (1 ~ 14)

### Set Port Speed

Command Name	<b>port set speed</b>
Description	Sets the port speed of a given port.
Syntax	<b>port set speed</b> <port-no><speed>
Parameters	<b>port-no</b> Port number. (1 ~ 12) <b>speed</b> Speed of the port. Speed must either 10, 100, 1000 megabits per sec.
Examples	N-TRON/Admin#[1]> port set speed 5 10  N-TRON/Admin#[2]> port set speed 9 100
NOTES	If the auto negotiation mode is enabled, port speed cannot be set. First disable the auto negotiation mode, and then set the port speed.

### Get the port duplex mode

Command Name	<b>port get duplexmode</b>
Description	Gets the port Duplex mode (FULL_DUPLEX / HALF_DUPLEX ) for a given port number .
Syntax	<b>port get duplexmode</b> <port-no>
Parameters	<b>port-no</b> Port number. (1 ~ 14)
Examples	N-TRON/Admin#[1]> port get duplexmode 4 Duplex mode of [4] port is: [half] N-TRON/Admin#[2]> port get duplexmode 23 Duplex mode of [23] port is: [full]
NOTES	Check whether <i>port-no</i> is in the valid range. (1 ~ 14)

### Set the port duplex mode

Command Name	<b>port set duplexmode</b>
Description	Sets the port duplex mode (HALF_DUPLEX / FULL_DUPLEX) for a given port number.
Syntax	<b>port set duplexmode</b> <port-no> <full / half>
Parameters	<b>port-no</b> Port number. (1~12) <b>full   half</b> Duplex mode of the port. Duplex mode must be either FULL_DUPLEX or HALF_DUPLEX.
Examples	N-TRON/Admin#[1]> port set duplexmode 4 full N-TRON/Admin#[2]> port set duplexmode 4 half
NOTES	Check whether <i>port-no</i> is in the valid range. (1 ~ 12)

### Set the Lockstate of a given port

Command Name	<b>port set lockstate</b>
Description	Sets the lock state of a given port to either enable or disable. If the port lock is enabled, the switch can process the data packets only from locked MAC addresses. Other data packets will not be processed.
Syntax	<b>port set lockstate</b> <port-no> <enable / disable>
Parameters	<b>port-no</b> port number (1 ~ 14) <b>enable   disable</b> Lock enable or disable
Examples	N-TRON/Admin#[1]> port set lockstate 5 disable N-TRON/Admin#[2]> port set lockstate 8 enable
NOTES	Once the port is locked, all the MACs that are learned on that port are treated as static MACs. This means the switch can process the packets from those MACs only. It will discard all packets from other MACs. Because the MAC is set for that port, it will only be addressable via that port.

### Get Lock State

Command Name	<b>port get lockstate</b>
Description	Gets the lock state for a given port.
Syntax	<b>port get lockstate</b> <port-no>
Parameters	<b>port-no</b> port number (1 ~ 14).
Examples	N-TRON/Admin#[1]> port get lockstate 6 LockState : [enable] N-TRON/Admin#[2]> port get lockstate 14 LockState : [disable]
NOTES	Check whether <i>port-no</i> is in the valid range. (1 ~ 14)

### Get Auto-negotiation State

Command Name	<b>port get autonego</b>
Description	Gets the auto negotiation mode for a given port.
Syntax	<b>port get autonego</b> <port-no>
Parameters	<b>port-no</b> Port number (1 ~ 14).
Examples	N-TRON/Admin#[1]> port get autonego 6 Auto negotiation mode is : [enabled] N-TRON/Admin#[2]> port get autonego 12 Auto negotiation mode is : [disabled]
NOTES	Check whether <i>port-no</i> is in the valid range. (1 ~ 14)

### Set Auto-negotiation State

Command Name	<b>port set autonego</b>
Description	Sets the auto negotiation mode of a given port to either enable or disable. If the port auto negotiation mode is enabled, the switch can automatically adjust its speed and duplex mode to the incoming speed and duplex mode.
Syntax	<b>port set autonego</b> <port-no><enable / disable>
Parameters	<b>port-no</b> port number (1 ~ 12) <b>enable   disable</b> Auto negotiation enable or disable
Examples	N-TRON/Admin#[1]> port set autonego 6 enable Auto negotiation mode of port[6] is : [enabled] N-TRON/Admin#[2]> port set autonego 7 disable Auto negotiation mode of port[7] is : [disabled]
NOTES	Check whether <i>port-no</i> is in the valid range. (1 ~ 12)

### Set Priority State

Command Name	<b>port set prioritystate</b>
Description	Enables or Disables the Priority State on a per port basis.
Syntax	<b>port set prioritystate</b> <enable / disable><port-no>
Parameters	<b>port-no</b> port number (1 ~ 14) <b>enable   disable</b> Priority State enable or disable
Examples	N-TRON/Admin#[1]> port set prioritystate enable 6
NOTES	Check whether <i>port-no</i> is in the valid range. (1 ~ 14)

### Set Flow Control

Command Name	<b>port set flowcontrol</b>
Description	Enable or Disable flow control (typically refers to 100Base). When enabled a pause frame will be sent to help control the flow.
Syntax	<b>port set flowcontrol</b> <port-no><enable   disable>
Parameters	<b>port-no</b> port number (1 ~ 12) <b>enable   disable</b> Flow Control enable or disable
Examples	N-TRON/Admin#[1]> port set flowcontrol 6 enable
NOTES	Check whether <i>port-no</i> is in the valid range. (1 ~ 12)

### Set Name

Command Name	<b>port set name</b>
Description	Changes the name of the port. This change will only be visible in the CLI.
Syntax	<b>port set name</b> <port-no><name>
Parameters	<b>port-no</b> port number (1 ~ 14) <b>name</b> A string that describes the port
Examples	N-TRON/Admin#[1]> port set name 6 waterplant
NOTES	This will be reset if you change a slot configuration.

### Set PVID

Command Name	<b>port set pvid</b>
Description	Set a port's VLAN-ID.
Syntax	<b>port set pvid</b> <port-no><pvid-number>
Parameters	<b>port-no</b> port number (1 ~ 14) <b>pvid-number</b> The VLAN-ID number of the VLAN that this port will be a member of
Examples	N-TRON/Admin#[1]> port set pvid 6 2
NOTES	A port can be a member to several VLANs, but can only have one PVID

### Set Backpressure

Command Name	<b>port set backpressure</b>
Description	Enables or disables backpressure on a given port. This is normally used on 10Base setups and is a controlled by the hardware.
Syntax	<b>port set backpressure</b> <port-no><enable   disable>
Parameters	<b>port-no</b> port number (1 ~ 12) <b>enable   disable</b> Backpressure enable or disable
Examples	N-TRON/Admin#[1]> port set backpressure 6 enable
NOTES	Check whether <i>port-no</i> is in the valid range. (1 ~ 12)

### Set Intruderstate

Command Name	<b>port set intruderstate</b>
Description	Enables or Disables the intruder log.
Syntax	<b>port set intruderstate</b> <enable   disable>
Parameters	<b>enable   disable</b> Enable or disable the intruder log
Examples	N-TRON/Admin#[1]> port set intruderstate enable
NOTES	This must be enabled for the intruder log to log anything.

### Set Priority Level

Command Name	<b>port set prioritylevel</b>
Description	Sets the priority level of a given port.
Syntax	<b>port set prioritylevel</b> <port-no> <level>
Parameters	<b>port-no</b> port number (1 ~ 14) <b>level</b> priority level (0 ~ 7)
Examples	N-TRON/Admin#[1]> port set prioritylevel 6 7
NOTES	Priority State should be enabled to use this feature.

### Show Configuration

Command Name	<b>port show config</b>
Description	Displays basic configuration settings on given ports.
Syntax	<b>port show config</b> <port-no / all>
Parameters	<b>port-no   all</b> port number (1 ~ 14), you may enter all to see all the ports at once.
Examples	N-TRON/Admin#[1]> port show config all
NOTES	Check whether <i>port-no</i> is in the valid range. (1 ~ 14)

### Show Intruders

Command Name	<b>port show intruder</b>
Description	Displays a list of MAC addresses that were not allowed on the network.
Syntax	<b>port show intruder</b>
Parameters	None
Examples	N-TRON/Admin#[1]> port show intruder
NOTES	Intruder log must be enabled before this will log anything.

### Show Link Utilization

Command Name	<b>port show linkutilization</b>
Description	Shows the utilization statistics for all the ports including %bandwidth, %in, %out, RX bytes, and TX bytes for each port.
Syntax	<b>port show linkutilization</b>
Parameters	None
Examples	N-TRON/Admin#[1]> port show linkutilization
NOTES	%Bandwidth is the %in or %out value that is higher, not the average value.

### Get Flow Control

Command Name	<b>port get flowcontrol</b>
Description	Displays the current flow control settings on a given port.
Syntax	<b>port get flowcontrol</b> <port-no>
Parameters	<b>port-no</b> port number (1 ~ 14)
Examples	N-TRON/Admin#[1]> port get flowcontrol 6
NOTES	Check whether <i>port-no</i> is in the valid range. (1 ~ 14)

### Get Name

Command Name	<b>port get name</b>
Description	Displays the name of a given port.
Syntax	<b>port get name</b> <port-no>
Parameters	<b>port-no</b> port number (1 ~ 14)
Examples	N-TRON/Admin#[1]> port get name 6
NOTES	Check whether <i>port-no</i> is in the valid range. (1 ~ 14)

### Get State Of Priority

Command Name	<b>port get stateofpriority</b>
Description	Displays the priority state of a given port number.
Syntax	<b>port get stateofpriority</b> <port-no>
Parameters	<b>port-no</b> port number (1 ~ 14)
Examples	N-TRON/Admin#[1]> port get stateofpriority 6 Priority State of Port[6] is : [disabled]
NOTES	Check whether <i>port-no</i> is in the valid range. (1 ~ 14)

### Get Intruder State

Command Name	<b>port get intruderstate</b>
Description	Displays whether the intruder log is enabled or disabled.
Syntax	<b>port get intruderstate</b>
Parameters	None
Examples	N-TRON/Admin#[1]> port get intruderstate Intruder Log : Disabled
NOTES	

### Get Priority Level

Command Name	<b>port get prioritylevel</b>
Description	Displays the priority level on a given port.
Syntax	<b>port get prioritylevel</b> <port-no>
Parameters	<b>port-no</b> port number (1 ~ 14)
Examples	N-TRON/Admin#[1]> port get prioritylevel 6 Priority Level of Port[6] is : [1]
NOTES	Check whether <i>port-no</i> is in the valid range. (1 ~ 14)

### Get STP Status

Command Name	<b>port get STP Status</b>
Description	Displays the Spanning Tree Protocol Status on a given port.
Syntax	<b>port get stpstatus</b> <port-no>
Parameters	<b>port-no</b> port number (1 ~ 14)
Examples	N-TRON/Admin#[1]> port get stpstatus 6 Stp state of [6] port is : [Forward]
NOTES	STP states include: Listening, Learning, Blocking, & Forwarding

### Get Back Pressure

Command Name	<b>port get backpressure</b>
Description	Displays the backpressure information on a given port number (enabled or disabled).
Syntax	<b>port get backpressure</b> <port-no>
Parameters	<b>port-no</b> port number (1 ~ 14)
Examples	N-TRON/Admin#[1]> port get backpressure 6 Back Pressure is DISABLED
NOTES	Check whether <i>port-no</i> is in the valid range. (1 ~ 14)

### Get PVID

Command Name	<b>port get pvid</b>
Description	Displays a given port's VLAN-ID.
Syntax	<b>port get pvid</b> <port-no>
Parameters	<b>port-no</b> port number (1 ~ 14)
Examples	N-TRON/Admin#[1]> port get pvid 6 PVID of port 6 is 4.
NOTES	Check whether <i>port-no</i> is in the valid range. (1 ~ 14)

### Clear Counters

Command Name	<b>port clear counters</b>
Description	Clears all the numbers in the counters for a given port. These are counters for RX bytes and TX bytes and so on.
Syntax	<b>port clear counters</b> <port-no>
Parameters	<b>port-no</b> port number (1 ~ 14)
Examples	N-TRON/Admin#[1]> port clear counters 6 Counters of Port[6] are : [cleared]
NOTES	This will clear all data in the port specific counters. This data cannot be recovered after this step.

### Clear Intruder Log

Command Name	<b>port clear intruderlog</b>
Description	This command will clear all intruders out of the intruder log.
Syntax	<b>port clear intruderlog</b>
Parameters	None
Examples	N-TRON/Admin#[1]> port clear intruderlog
NOTES	This will clear all data from the intruder log. This data can not be recovered after this step.

## Trunk related commands

### Enable or disable Trunking

Command Name	<b>trunk set &lt;enable   disable&gt;</b>
Description	To enable or disable the trunk that is already created.
Syntax	<b>trunk set enable</b> <b>trunk set disable</b>
Parameters	<b>Enable   disable</b>
Examples	N-TRON/Admin#[1]> trunk set enable Trunking is activated. N-TRON/Admin#[1]> trunk set disable Trunking is deactivated.
NOTES	RSTP must be disabled in order to use Trunking. All trunk ports must be at the same speed and duplex mode. It is best to hard code speed and duplex mode for each trunking link, at both ends. <b>Do not use Trunking on a switch that is directly in an active N-Ring.</b>

### Modify Trunk

Command Name	<b>trunk modify</b>
Description	To add new required ports to the trunk in order to withstand high traffic.
Syntax	<b>trunk modify &lt;port-list&gt; [-name &lt;trunk-name&gt;]</b>
Parameters	<b>port-list</b> Port numbers to be in the trunk. <b>trunk-name</b> Name given to a trunk
Examples	N-TRON/Admin#[6]trunk> modify 1,2 -name trunk1
NOTES	A maximum of 4 ports can be in a trunk. All trunk ports must be at the same speed and duplex mode. If a port is not linked, there could be difficulty matching similar speed and duplex mode. It is best to hard code speed and duplex mode for each trunking link, at both ends.

### Create Trunk

Command Name	<b>trunk create</b>
Description	To create a trunk. A trunk is used to get more bandwidth to withstand high traffic.
Syntax	<b>trunk create &lt;port-list&gt; [-name &lt;trunk-name&gt;]</b>
Parameters	<b>port-list</b> Port numbers to be added to the trunk. <b>trunk-name</b> Name given to a trunk
Examples	N-TRON/Admin#[1]> trunk create 4-7 -name trunk1
NOTES	RSTP must be disabled in order to use Trunking. Only 1 trunk can be created per switch. A maximum of 4 ports can be in a trunk. All trunk ports must be at the same speed and duplex mode. If a port is not linked, there could be difficulty matching similar speed and duplex mode. It is best to hard code speed and duplex mode for each trunking link, at both ends.

### Delete Trunk

Command Name	<b>trunk delete</b>
Description	To delete the trunk .
Syntax	<b>trunk delete</b>
Parameters	
Examples	N-TRON/Admin#[1]> trunk delete Trunk has been deleted.
NOTES	



## Show Trunk Information

Command Name	<b>trunk show</b>
Description	To show all the trunks information.
Syntax	<b>trunk show</b>
Parameters	<b>None</b>
Examples	<pre>N-TRON/Admin#[1]&gt; trunk show -----   TRUNK NAME   TRUNK PORTS   TRUNK STATE   -----        trunk1             3-5       DISABLE   -----</pre>
NOTES	

## Mirroring related commands

### Set Mirror config

Command Name	<b>mirror set config</b>
Description	To the mirroring feature of the switch, for specified ports.
Syntax	<b>mirror set config</b> <dest-port> <src-ports>
Parameters	<p><b>dest-port</b> Destination port is the snooper port onto which the selected source ports traffic is to be mirrored. The gigabit ports cannot be destination ports.</p> <p><b>src-ports</b> List of ports to be monitored.</p>
Examples	N-TRON/Admin#[1]> mirror set config 1 2-5
NOTES	A mirroring port is a dedicated port that is configured to receive the copies of Ethernet frames that are being transmitted out and also being received in from any other port that is being monitored.

### Enable or Disable Port Mirroring

Command Name	<b>mirror set</b> <enable   disable>
Description	Enables or disables network monitoring or port mirroring. It treats source port as the Ethernet port and the destination port as a monitoring port.
Syntax	<b>mirror set enable</b>
Parameters	<b>None</b>
Examples	<pre>N-TRON/Admin#[1]&gt; mirror set enable mirror enabled N-TRON/Admin#[1]&gt; mirror set disable mirror disabled</pre>
NOTES	

### Show Mirror config

Command Name	<b>mirror show</b>
Description	To show all the mirror information.
Syntax	<b>mirror show</b>
Parameters	<b>None</b>
Examples	<pre>N-TRON/Admin#[1]&gt; mirror show -----   DEST PORT   SOURCE PORTS   MIRROR STATE   -----   5           2-4           ENABLED        -----</pre>
NOTES	

## VLAN Related Commands

### Add VLAN Entry

Command Name	<b>vlan add</b>
Description	To create a Port based Virtual LAN
Syntax	<b>vlan add</b> <vlan id> <mgmt port> <at least one of: [-untagged <port mask>] or [-tagged <port mask>]> [-name <vlan name>] [-admit <tagged-only/all>] [-mirror <port-no>]
Parameters	<p><b>vlan-id</b> Unique vlan id (2 ~ 4094).</p> <p><b>mgmt port</b> Either 1 or 0. '1' sets this vlan as a management vlan.</p> <p><b>vlan name</b> Unique vlan name, which can be used to identify the group. The name may include characters and numbers, but should start with an alphabetic. Maximum number of characters must not exceed 25.</p> <p><b>-untagged port mask</b> List of ports that are to be included under this VLAN. Commas can be used to separate individual ports (2,5,9) and the range can be specified using a hyphen (10-15). The port numbers cannot exceed the maximum number of ports on the board.</p> <p><b>-tagged port mask</b> Tagged port mask values can be specified in the same way as that of an untagged port mask.</p> <p><b>-admit</b> Allow tagged-only or all (untagged and tagged) packets.</p> <p><b>port-no</b> Optional parameter. Port number that data should be mirrored to.</p>
Examples	<pre>N-TRON/Admin#[1]&gt; vlan add 2 1 -untagged 1-12 -name vlan2 - admit all N-TRON/Admin#[2]&gt; vlan add 3 1 -tagged 13-24 -name "vlan 3" - admit tagged-only</pre>
NOTES	Ensure that the ports included in the tagged port list do not exist in the untagged ports-list field. Changing anything on a VLAN will turn on RSTP on all VLANs as a precautionary measure.

### Show List of Configured VLANs

Command Name	<b>vlan show config</b>
Description	Displays the list of configured VLANs
Syntax	<b>vlan show config</b>
Parameters	<b>None</b>
Examples	N-TRON/Admin#[1]> vlan show config
NOTES	It displays the information of the default vlan if no vlan is configured.

### Display Information of a particular VLAN

Command Name	<b>vlan get info</b>
Description	Displays the details of a particular VLAN.
Syntax	<b>vlan get info</b> <vlan-id>
Parameters	<b>vlan-id</b> Vlan id of the existing vlan whose individual configuration is required.
Examples	N-TRON/Admin#[1]> vlan get info 2 vlan ID : 2 vlan Name : "vlan 2" port list : 1-4,11 tagged port mask: 10-15 management port : NO
NOTES	

### Modify an existing VLAN

Command Name	<b>vlan modify</b>
Description	Modifies an existing VLAN.
Syntax	<b>vlan modify</b> <vlan id> <mgmt port> <at least one of: [-untagged <port mask>] or [-tagged <port mask>]> [-name <vlan name>] [-admit <tagged-only all>] [-mirror <port-no>]
Parameters	<b>vlan-id</b> unique vlan id ( 2 ~ 4094). <b>mgmt port</b> Management Port, yes or no (1 or 0). <b>-untagged port mask</b> List of ports that are to be included under this VLAN. Commas can be used to separate individual ports (2,5,9) and the range can be specified using a hyphen (10-15). The port numbers cannot exceed the maximum number of port on the board. <b>-tagged port mask</b> Tagged port list values can be specified in the same way as that of -untagged port mask. <b>vlan name</b> unique clan name, which can be used to identify. <b>admit</b> tagged-only or all. Type of packets can enter the port. <b>port-no</b> Optional parameter. Port number that data should be mirrored to.
Examples	N-TRON/Admin#[1]> vlan modify 2 1 -tagged 11-12 -name "newvlan2"  N-TRON/Admin#[2]> vlan modify 3 1 -untagged 1-10 -name "vlan 3" -admit all
NOTES	Changing anything on a VLAN will turn on RSTP on all VLANs as a precautionary measure.

### Delete VLAN

Command Name	<b>vlan delete</b>
Description	Removes an existing VLAN from the list of configured VLANs.
Syntax	<b>vlan delete</b> <vlan-id>
Parameters	<b>vlan-id</b> Vlan id of the existing vlan which has to be deleted
Examples	N-TRON/Admin#[1]> vlan delete 2
NOTES	Please ensure that a port based vlan with the given vlan id exists. Changing anything on a VLAN will turn on RSTP on all VLANs as a precautionary measure.

### Set VLAN as management VLAN

Command Name	<b>vlan set mgmtvlan</b>
Description	Enable or disable a Vlan as a management vlan. User can connect and monitor the device activity of this VLAN.
Syntax	<b>vlan set mgmtvlan</b> <vlan-id> <enable/disable>
Parameters	<b>vlan-id</b> Vlan id of the vlan <b>enable/disable</b> Enable or Disable management of the specified vlan.
Examples	N-TRON/Admin#[47]vlan/set> vlan set mgmtvlan 1 enable
NOTES	Please ensure that the vlan with that vlan id already exists. Changing anything on a VLAN will turn on RSTP on all VLANs as a precautionary measure.

### Set VLAN to defaults

Command Name	<b>vlan set default</b>
Description	Removes all the configured vlans and add all the ports under the Default vlan.
Syntax	<b>vlan set default</b>
Parameters	<b>None</b>
Examples	N-TRON/Admin#[1]> vlan set default
NOTES	Changing anything on a VLAN will turn on RSTP on all VLANs as a precautionary measure.

### Set VLAN Ingress Filter

Command Name	<b>vlan set ingressfilter</b>
Description	Enables or Disables an inbound filter on specified ports that will throw out any packet with the wrong VID in the VLAN tag on the packet.
Syntax	<b>vlan set ingressfilter</b> <enable/disable> <port-list/all>
Parameters	<b>enable/disable</b> Enable or Disable the filter on the a specified port. <b>port-list all</b> Enter a specific port number list or specify all ports
Examples	N-TRON/Admin#[1]> vlan set ingressfilter enable 1-6 N-TRON/Admin#[2]> vlan set ingressfilter enable all
NOTES	The ingressfilter will automatically be turned on for tagged ports.

### Get VLAN Ingress Filter

Command Name	<b>vlan get ingressfilter</b>
Description	Gets inbound filter info on specified ports.
Syntax	<b>vlan get ingressfilter</b> <all port-list>
Parameters	<b>all port-list</b> Enter a specific port number list or specify all ports
Examples	N-TRON/Admin#[1]> vlan get ingressfilter 1-6
NOTES	

### Get VLAN info

Command Name	<b>vlan get info</b>
Description	Displays the current state of the configured vlans.
Syntax	<b>vlan get info &lt;vlanid&gt;</b>
Parameters	<b>vlanid</b> Enter a specific Vlan ID
Examples	N-TRON/Admin#[1]> vlan get info 1
NOTES	

## Eventlog Related Commands

### Get Eventlog count

Command Name	<b>eventlog get count</b>
Description	To display the logged events count
Syntax	<b>eventlog get count</b>
Parameters	<b>None</b>
Examples	N-TRON/Admin#[1]> eventlog get count No. of events logged : 14
NOTES	

### Get Eventlog level

Command Name	<b>eventlog get loglevel</b>
Description	To display the present log level
Syntax	<b>eventlog get loglevel</b>
Parameters	<b>None</b>
Examples	N-TRON/Admin#[1]> eventlog get loglevel Present log Level: 1
NOTES	There are 5 levels or categories that events are classified as. Level 1 will log all 5 types into the event log. Level 5 will log on the highest level “Critical” in the event log. The log levels in order from least severe to most critical are: Informational, Warning, Minor, Severe, & Critical.

### Get Eventlog size

Command Name	<b>eventlog get logsize</b>
Description	To display the present log size
Syntax	<b>eventlog get logsize</b>
Parameters	<b>None</b>
Examples	N-TRON/Admin#[1]> eventlog get logsize Present Log Size: 100
NOTES	

### Set Eventlog level

Command Name	<b>eventlog set loglevel</b>
Description	To set the log-level to a specified value for filter out the raised events.
Syntax	<b>eventlog set loglevel &lt;level&gt;</b>
Parameters	<b>level</b> The log level. The value is ranging from 1-5
Examples	N-TRON/Admin#[1]> eventlog set loglevel 3 N-TRON/Admin#[2]> eventlog set loglevel 1 N-TRON/Admin#[3]> eventlog set loglevel 2
NOTES	There are 5 levels or categories that events are classified as. Level 1 will log all 5 types into the event log. Level 5 will log on the highest level “Critical” in the event log. The log levels in order from least severe to most critical are: Informational, Warning, Minor, Severe, & Critical.

### Set Eventlog size

Command Name	<b>eventlog set logsize</b>
Description	To set the maximum number of events to be stored in the list.
Syntax	<b>eventlog set logsize &lt;size&gt;</b>
Parameters	<b>size</b> The log size. Maximum number of events that can be stored.
Examples	N-TRON/Admin#[1]> eventlog set logsize 100 N-TRON/Admin#[2]> eventlog set logsize 20
NOTES	

### Show Eventlog events

Command Name	<b>eventlog show events</b>
Description	To display the logged events
Syntax	<b>eventlog show events</b>
Parameters	<b>None</b>
Examples	N-TRON/Admin#[1]> eventlog show events
NOTES	



## Bridging Related Commands

### Add Multicast MAC Address

Command Name	<b>bridge add multicastmac</b>
Description	Adds a multicast mac address which is associated with a vlan.
Syntax	<b>bridge add multicastmac</b> <mac-address> <port-list>
Parameters	<b>mac-address</b> Multicast group address to be added to the bridge <b>port-list</b> Port numbers to which the multicast group is associated
Examples	N-TRON/Admin#[1]>bridge add multicastmac 01:00:5e:03:01:18 4
NOTES	If there are multiple ports on different VLANs, the 7014 will apply the static broadcast address to the lowest VLAN-ID that is associated with one of the ports assigned to the static multicast address. So if the lowest VLAN-ID contains all the ports assigned to the static multicast address (an umbrella VLAN), it will function for all those ports with no problems. This can be achieved with overlapping VLANs.

### Delete Multicast MAC Address

Command Name	<b>bridge delete multicastmac</b>
Description	Removes an existing multicast mac address.
Syntax	<b>bridge delete multicastmac</b> <mac-address>
Parameters	<b>mac-address</b> Multicast group address to be removed to the bridge
Examples	N-TRON/Admin#[1]> bridge delete multicastmac 01:00:5e:03:01:18
NOTES	

### Add a Unicast MAC Address

Command Name	<b>bridge add unicastmac</b>
Description	Adds a unicast mac address.
Syntax	<b>bridge add unicastmac</b> <mac address> <port number> [-mirror <disable enable>]
Parameters	<b>mac-address</b> Unique unicast mac address. <b>port number</b> port number on which this mac is learned. The port number must range between 1 and maximum port numbers in switch.
Examples	N-TRON/Admin#[1]> bridge add unicastmac 00-a0-ae-60-3a-70 3 N-TRON/Admin#[2]> bridge add unicastmac 00-10-a1-33-49-b5 6
NOTES	

### Delete Unicast MAC Address

Command Name	<b>bridge delete unicastmac</b>
Description	Delete an existing unicast mac address.
Syntax	<b>bridge delete unicastmac</b> <mac-address>
Parameters	<b>mac-address</b> Unique unicast mac address.
Examples	N-TRON/Admin#[1]> bridge delete unicastmac 00-a0-ae-60-3a-70
NOTES	

### Display List of Configured Static MAC Addresses

Command Name	<b>bridge show staticmac</b>
Description	To view the list of configure static mac addresses
Syntax	<b>bridge show staticmac &lt;all multicast unicast&gt;</b>
Parameters	<b>&lt;all multicast unicast&gt;</b> which set of static mac addresses to show
Examples	N-TRON/Admin#[1]> bridge show staticmac all  N-TRON/Admin#[2]> bridge show staticmac multicast  N-TRON/Admin#[3]> bridge show staticmac unicast
NOTES	<b>These are egress filters.</b>

### Set Aging Time

Command Name	<b>bridge set agingtime</b>
Description	Sets the aging time for dynamically learned MAC addresses of the chipset.
Syntax	<b>bridge set agingtime &lt;aging-time&gt;</b>
Parameters	<b>aging-time</b> aging time to be set for stp. Minimum aging time can be 5 seconds. Default aging time is 300 seconds. Maximum aging time is 1000000 seconds.
Examples	N-TRON/Admin#[1]> bridge set agingtime 20
NOTES	

### Display Current Aging Time

Command Name	<b>bridge show agingtime</b>
Description	Displays the current aging time.
Syntax	<b>bridge show agingtime</b>
Parameters	None
Examples	N-TRON/Admin#[1]> bridge show agingtime
NOTES	

### Display Mac Address by port

Command Name	<b>bridge show machyport</b>
Description	Displays all the MAC addresses associated with a port.
Syntax	<b>bridge show machyport &lt;portno/all&gt;</b>
Parameters	<b>port-number</b> The port number must range between 1 and the maximum number of ports on the switch. <b>all</b> Display MAC addresses for all ports
Examples	N-TRON/Admin#[1]> bridge show machyport 6
NOTES	

### Display port by Mac Address

Command Name	<b>bridge show portbymac</b>
Description	Display the port number to which the mac is associated.
Syntax	<b>bridge show portbymac &lt;mac-address&gt;</b>
Parameters	<b>mac-address</b> Unique unicast mac address.
Examples	N-TRON/Admin#[1]> bridge show portbymac 00-a0-ae-60-3a-70
NOTES	

### Display Mac count

Command Name	<b>bridge show maccount</b>
Description	Displays the total count of the static mac addresses.
Syntax	<b>bridge show maccount</b>
Parameters	<b>None</b>
Examples	N-TRON/Admin#[1]> bridge show maccount
NOTES	

## IGMP Related Commands

### Enable IGMP

Command Name	<b>igmp set enable</b>
Description	The igmp status is made to enable .
Syntax	<b>igmp set enable</b>
Parameters	<b>None</b>
Examples	<pre>N-TRON/Admin#[1]&gt; igmp set enable igmp status is Enabled N-TRON/Admin#[2]&gt; igmp show config   Igmp                : Enabled   Query Mode          : auto   Router Mode         : auto   Router Ports (Manual) :</pre>
NOTES	The status can be viewed through the igmp show config command

### Disable IGMP

Command Name	<b>igmp set disable</b>
Description	The igmp status is made to disable
Syntax	<b>igmp set disable</b>
Parameters	<b>None</b>
Examples	<pre>N-TRON/Admin#[1]&gt; igmp set disable igmp status is Disabled N-TRON/Admin#[2]&gt; igmp show config   Igmp                : Disabled   Querier              : Enabled   Query Mode          : auto   Router Mode         : auto   Router Ports (Manual) :</pre>
NOTES	The status can be viewed through the igmp show config command

### Show IGMP config

Command Name	<b>igmp show config</b>
Description	The igmp configuration is displayed
Syntax	<b>igmp show config</b>
Parameters	<b>None</b>
Examples	<pre>N-TRON/Admin#[1]&gt; igmp show config   Igmp                : Disabled   Querier              : Enabled   Query Mode          : auto   Router Mode         : auto   Router Ports (Manual) :</pre>
NOTES	This command is used to see the config previously set by the user

### Show IGMP group

Command Name	<b>igmp show group</b>
Description	The igmp show group command is used to display the groups present in the group list
Syntax	<b>igmp show group</b>
Parameters	<b>None</b>
Examples	<pre>N-TRON/Admin#[1]&gt; igmp show group GroupIp          PortNo          VlanID ----- 224.0.0.2        6                1 224.0.1.24       6                1</pre>
NOTES	The group display is used to check that the group ip, port no & vlan id were received correctly.

### Show IGMP router

Command Name	<b>igmp show router</b>
Description	The igmp show router command is used to display the auto-detected routers at present.
Syntax	<b>igmp show router</b>
Parameters	<b>None</b>
Examples	N-TRON/Admin#[1]> igmp show router RouterIp            PortNo ----- 192.168.1.150        5
NOTES	The router display is used to check that the router ip & port number was received correctly.

### Set IGMP query mode

Command Name	<b>igmp set qmode</b>
Description	Set the query mode of the switch to either on, off, or automatic.
Syntax	<b>igmp set qmode</b> <off   on   auto>
Parameters	<b>off   on   auto</b> There are three different query modes; off, on, and auto.
Examples	N-TRON/Admin#[1]> igmp set qmode auto
NOTES	Default: Auto

### Set IGMP router port

Command Name	<b>igmp set rtrport</b>
Description	Enable or disable a router port based on a port-range.
Syntax	<b>igmp set rtrport</b> <port-range> <enable   disable>
Parameters	<b>port-range</b> enter a range of port numbers. <b>enable   disable</b> enable or disable the router port.
Examples	N-TRON/Admin#[1]> igmp set rtrport 1-4 enable
NOTES	

### Set IGMP router mode

Command Name	<b>igmp set rtrmode</b>
Description	The igmp show router command is used to display the router group present in the group list
Syntax	<b>igmp set rtrmode</b> <none   manual   auto>
Parameters	<b>none   manual   auto</b> There are three different router modes available; none, manual, and auto.
Examples	N-TRON/Admin#[1]> igmp set rtrmode auto
NOTES	Default: Auto

### Show IGMP rfilter mode

Command Name	<b>igmp show rfilter</b>
Description	The igmp show rfilter command is used to display the rfilter status by port(s).
Syntax	<b>Usage: igmp show rfilter</b> <all port-list>
Parameters	<b>port-list all</b> Enter a specific port number list or specify all ports
Examples	N-TRON/Admin#[22]> Igmp show rfilter all  N-TRON/Admin#[22]igmp/show> igmp show rfilter 5

	<pre> Port No.   IGMP RFilter ----- 5         DISABLE  N-TRON/Admin#[6]igmp/show&gt; igmp show rfilter 5-7  Port No.   IGMP RFilter ----- 5         DISABLE 6         DISABLE 7         DISABLE N-TRON/Admin#[7]igmp/show&gt; </pre>
NOTES	Default: enable

### Set IGMP rfilter mode

Command Name	<b>igmp set rfilter</b>
Description	The igmp set rfilter command is used to enable or disable rfilter based on a port-range.
Syntax	<b>Usage: igmp set rfilter &lt;enable disable&gt; &lt;port-list all&gt;</b>
Parameters	<p><b>enable disable</b> Enable or Disable the filter on the a specified port.</p> <p><b>port-list all</b> Enter a specific port number list or specify all ports</p>
Examples	<p><u><a href="#">N-TRON/Admin#[35]igmp/set&gt; igmp set rfilter enable 5</a></u></p> <p><u><a href="#">IGMP RFilter enabled for port 5.</a></u></p> <p><u><a href="#">N-TRON/Admin#[36]igmp/set&gt;</a></u></p>
NOTES	Default: enable

## N-Ring Related Commands

### N-Ring get agingtime

Command Name	<b>n-ring get agingtime</b>
Description	To display the N-Ring Agingtime of the device
Syntax	<b>n-ring get agingtime</b>
Parameters	<b>None</b>
Example	N-TRON/Admin#[1]> n-ring get agingtime  N-Ring Aging Time : 20
NOTES	Default: 20 seconds and is separate from the Bridging Aging Time. N-Ring Aging time is used for the whole switch if the switch is an N-Ring Manager or becomes an active N-Ring Member.

### N-Ring set agingtime

Command Name	<b>n-ring set agingtime</b>
Description	Sets the aging time for dynamically learned MAC addresses of the chipset when in N-Ring Manager or Active N-Ring Member modes.
Syntax	<b>n-ring set agingtime &lt;aging-time&gt;</b>
Parameters	<b>aging-time</b> aging time to be set for N-Ring. Minimum N-Ring agingtime can be 5 seconds. Default N-Ring aging time is 20 seconds. Maximum aging time is 1000000 seconds.
Examples	N-TRON/Admin#[1]> n-ring set agingtime 200
NOTES	Is separate from the Bridging Aging Time. N-Ring Aging time is used for the whole switch if the switch is an N-Ring Manager or becomes an active N-Ring Member.

### N-Ring get webfault

Command Name	<b>n-ring get webfault</b>
Description	To display the browser N-Ring fault reporting mode.
Syntax	<b>n-ring get webfault</b>
Parameters	<b>None</b>
Example	N-TRON/Admin#[1]> n-ring get webfault  N-Ring faults will be shown on N-Ring Web Pages only
NOTES	

### N-Ring set webfault

Command Name	<b>n-ring set webfault</b>
Description	Sets the browser N-Ring fault reporting mode.
Syntax	<b>n-ring set webfault &lt;ring/all&gt;</b>
Parameters	<i>Ring or all</i>
Examples	N-TRON/Admin#[1]> n-ring set webfault all  N-Ring faults will be shown on All Web Pages
NOTES	

### N-Ring get interval

Command Name	<b>n-ring get interval</b>
Description	To display the Self-Health Packet interval and missed threshold.
Syntax	<b>n-ring get interval</b>
Parameters	<b>None</b>
Example	N-TRON/Admin#[1]> n-ring get interval  Self Health Packet interval is 1 Maximum Missed Packets is 2
NOTES	Default: interval=1, missed=2

### N-Ring set interval

Command Name	<b>n-ring set interval</b>
Description	Sets the Self-Health Packet interval and missed threshold.
Syntax	<b>n-ring set interval &lt;interval&gt; [missed]</b>
Parameters	<b>interval and missed</b>
Examples	N-TRON/Admin#[36]n-ring/set> n-ring set interval 1 3  Self Health Packet interval set to 1 Maximum Missed Packets set to 3
NOTES	The interval is in 10 millisecond increments. The missed threshold sets how many missed Self-Health Packets constitute a fault.

### N-Ring get mode

Command Name	<b>n-ring get mode</b>
Description	To display the current N-Ring Mode.
Syntax	<b>n-ring get mode</b>
Parameters	<b>None</b>
Example	N-TRON/Admin#[1]> n-ring get mode  N-Ring Mode : AutoMember Port Set : 100 VLAN ID : 1 Tagging : Untagged
NOTES	<b>Do not use Trunking on a switch that is directly in an active N-Ring.</b>

### N-Ring set mode

Command Name	<b>n-ring set mode</b>
Description	Sets the current N-Ring Mode. Sets ring ports, vlanid and tagging, if manager mode.
Syntax	<b>n-ring set mode &lt;manager/automember/disable&gt; [-rp &lt;100 GB&gt;] [-vlanid &lt;id&gt;] [-tagging &lt;tagged/untagged&gt;]</b>
Parameters	<b>manager automember disable</b> N-Ring mode <b>A E</b> N-Ring ports, 100 for ports FX1 and FX2, while GB for ports GB1 and GB2 <b>id</b> Unique vlan id (1 - 4094). Default is 3333. <b>tagged untagged</b> Determines whether the N-Ring ports are members of the VLANs Tagged or Untagged ports. Default is Tagged.
Examples	N-Ring Mode set to automember ..... ..... . Device is Going for Reboot....  N-TRON/Admin#[3]> n-ring set mode manager -rp GB



	<pre> N-Ring Mode set to manager Port Set to be used is GB N-Ring VLAN ID is set to: 3333 N-Ring Tagging is set to: Tagged ..... ..... Device is Going for Reboot.... </pre>
NOTES	<p><b>NOTE: N-Ring Manager cannot have RSTP enabled.</b>  <b>Do not use Trunking on a switch that is directly in an active N-Ring.</b></p>

**N-Ring show status**

Command Name	<b>n-ring show status</b>
Description	Shows the current N-Ring status of the switch. If Manager, shows ring members. Shows if Automember or active member. If active (manager or member) shows N-Ring ports.
Syntax	<b>n-ring show status</b>
Parameters	<b>None</b>
Examples	<pre> On an N-Ring Manager: N-TRON/Admin#[1]&gt; n-ring show status  Switch is in N-Ring Manager Mode N-Ring OK    Port 1   Port 2   =====     1       2  No:    MAC Address        IP Address        Subnet Mask       Port 1   Port 2 ===== 1      00:07:af:ff:f6:40   192.168.1.233     255.255.255.0     1        2  -----  On an N-Ring Active Member: N-TRON/Admin#[1]&gt; n-ring show status  Switch is a N-Ring Member N-Ring Manager is 00:07:af:ff:f6:c0    Port 1   Port 2   =====     1       2  -----  On an N-Ring AutoMember (not active):  N-TRON/Admin#[2]n-ring/show&gt; n-ring show status  Switch is in Auto Member Detection Mode </pre>
NOTES	

### N-Ring show switch

Command Name	<b>n-ring show switch</b>
Description	From the N-Ring Manager, shows info about a switch on the N-Ring.
Syntax	<b>n-ring show switch</b> <MAC ADDRESS>
Parameters	<MAC ADDRESS>
Examples	N-TRON/Admin#[12]n-ring/show> switch 00:07:af:ff:f6:40  Information for 00:07:af:ff:f6:40  Name : N-TRON Switch Location : Mobile, AL 36609 Product Name : N-TRON 7000 Series Product Version : 4.1.1 IP Address : 192.168.1.233 Subnet Mask : 255.255.255.0 N-Ring Port 1 : 1 N-Ring Port 2 : 2  N-TRON/Admin#[13]n-ring/show>
NOTES	

### N-Ring set keepalive

Command Name	<b>n-ring set keepalive</b>
Description	Set timeout after which an N-Ring member will drop back to RSTP mode on the N-Ring ports after loosing communication with the N-Ring manager.
Syntax	<b>n-ring set keepalive</b> <timeout>
Parameters	<b>timeout</b> Timeout in seconds
Examples	N-TRON/Admin#[10]n-ring/set> n-ring set keepalive 40  Keep-Alive Timeout set to 40
NOTES	Default is 31 seconds

### N-Ring get keepalive

Command Name	<b>n-ring get keepalive</b>
Description	Get timeout after which an N-Ring member will drop back to RSTP mode on the N-Ring ports after loosing communication with the N-Ring manager.
Syntax	<b>n-ring set keepalive</b>
Parameters	<b>None</b>
Examples	N-TRON/Admin#[10]n-ring/get> n-ring get keepalive  Keep-Alive Timeout is 31
NOTES	

## Configuration Related Commands

### Save Configuration

Command Name	<b>config save</b>
Description	The configuration will be saved to the flash.
Syntax	<b>config save</b>
Parameters	<b>None</b>
Examples	N-TRON/Admin#[1]> config save
NOTES	

### Load Default Configuration

Command Name	<b>config erase</b>
Description	This command is useful to erase the configuration data
Syntax	<b>config erase</b>
Parameters	<b>None</b>
Examples	N-TRON/Admin#[1]> config erase  Load Factory Default Setting. [y/n]y Factory Default Configuration Successfully loaded  Restart the switch to effect this change
NOTES	This command will reset all configurable fields back to the default settings that the switch shipped with. This will change the IP address back to 192.168.1.201 and will change the slot configurations of the 7014 to all 9006TX modules and no gigabit fiber ports.

### Configuration Upload

Command Name	<b>config send</b>
Description	The configuration on the flash is grouped into a file and sent to the tftp server.
Syntax	<b>config send &lt;Server-IpAddress&gt; &lt;File-Name&gt;</b>
Parameters	<b>Server-IpAddress</b> IP Address of the TFTP Server, to where the switch configuration data will be uploaded. <b>File-Name</b> Name of the file to be saved as.
Examples	N-TRON/Admin#[1]> config send 10.1.6.151 config
NOTES	The ip address should be the valid tftp server ip address, and the target tftp server should be running.

### Configuration Download

Command Name	<b>config receive</b>
Description	The file name mentioned will be downloaded from the server and the same configuration is overwritten to the flash.
Syntax	<b>config receive &lt;Server-IpAddress&gt; &lt;File-Name&gt;</b>
Parameters	<b>Server-IpAddress</b> IP Address of the TFTP server, from where the configuration data to be retrieved. <b>File-Name</b> Name of the file to be retrieved.
Examples	N-TRON/Admin#[1]> config receive 10.1.6.151 config
NOTES	The ip address should be the valid tftp server ip address, and the target tftp server should be running.

## Rapid Spanning Tree Protocol Related Commands

### Set RSTP Admin Edge

Command Name	<b>rstp set adminedge</b>
Description	Sets the Adminedge value of a port in a Vlan.
Syntax	<b>rstp set adminedge</b> <vlan id> <port no> <status>
Parameters	<p><b>vlan id</b> Vlan Id containing the port for which the adminedge is to be set.</p> <p><b>port no</b> Port number in the Vlan to be set.</p> <p><b>status</b> Status of the adminedge of the port to be set. Values of “enable” and “disable” are valid</p>
Examples	N-TRON/Admin#[1]> rstp set adminedge 1 1 disable N-TRON/Admin#[2]> rstp set adminedge 2 2 enable
NOTES	

### Get RSTP Admin Edge

Command Name	<b>rstp get adminedge</b>
Description	Gets the Adminedge value of the given port in the given Vlan-Id.
Syntax	<b>rstp get adminedge</b> <vlan id> <port>
Parameters	<p><b>vlan id</b> Vlan Id containing the port for which the adminedge is to be viewed .</p> <p><b>port</b> Port for which the adminedge value is to be viewed .</p>
Examples	N-TRON/Admin#[1]> rstp get adminedge 1 1 N-TRON/Admin#[2]> rstp get adminedge 2 2
NOTES	

### Set RSTP Auto Edge

Command Name	<b>rstp set autoedge</b>
Description	Sets the Autoedge value of a port in a Vlan.
Syntax	<b>rstp set autoedge</b> <vlan id> <port-no> <status>
Parameters	<p><b>vlan id</b> Vlan Id containing the port for which the autoedge is to be set.</p> <p><b>port-no</b> Port number in the Vlan to be set.</p> <p><b>status</b> Status of the autoedge of the port to be set. Values of “enable” and “disable” are valid</p>
Examples	N-TRON/Admin#[1]> rstp set autoedge 1 1 disable N-TRON/Admin#[2]> rstp set autoedge 2 2 enable
NOTES	

### Get RSTP Auto Edge

Command Name	<b>rstp get autoedge</b>
Description	Gets the Autoedge value of the given port in the given Vlan-Id.
Syntax	<b>rstp get autoedge</b> <vlan id > <port>
Parameters	<p><b>vlan id</b> Vlan Id containing the port for which the autoedge is to be viewed .</p> <p><b>port</b> Port for which the autoedge value is to be viewed .</p>
Examples	N-TRON/Admin#[1]> rstp get autoedge 1 1 N-TRON/Admin#[2]> rstp get autoedge 2 2
NOTES	

### Set RSTP Bridge Admin Status

Command Name	<b>rstp set bridgeadminstatus</b>
Description	Sets the Bridge Admin Status of the given Vlan-ID.
Syntax	<b>rstp set bridgeadminstatus</b> <vlan id > <bridge adminstatus >
Parameters	<b>vlan id</b> Vlan Id for which the priority to be set. <b>bridge adminstatus</b> Status of the Bridge to be set. Values of “fast”, “forcestp” and “disable” are valid
Examples	N-TRON/Admin#[1]> rstp set bridgeadminstatus 1 disable N-TRON/Admin#[2]> rstp set bridgeadminstatus 2 fast
NOTES	

### Get RSTP Bridge Admin Status

Command Name	<b>rstp get bridgeadminstatus</b>
Description	Gets the Bridge Admin Status of the given Vlan-Id.
Syntax	<b>rstp get bridgeadminstatus</b> <vlan-id >
Parameters	<b>vlan-id</b> Vlan Id for which the admin status is to be viewed .
Examples	N-TRON/Admin#[1]> rstp get bridgeadminstatus 1 N-TRON/Admin#[2]> rstp get bridgeadminstatus 2
NOTES	

### Set RSTP Bridge Forward Delay

Command Name	<b>rstp set bridgeforwarddelay</b>
Description	To set the forward delay time for a given Vlan-Id. Forward Delay in STP is the time a switch waits after connecting to a root bridge, before he changes the port state to forwarding from the listening and learning states. RSTP only uses this as a backup feature for legacy STP device support.
Syntax	<b>rstp set bridgeforwarddelay</b> <vlan-id > <forwarddelay >
Parameters	<b>vlan-id</b> Vlan Id for which the forward delay time to be set. <b>forwarddelay</b> Forward delay Time to be set. The valid range of the Forward delay time is (4.0 – 30.0) secs.
Examples	N-TRON/Admin#[1]> rstp set bridgeforwarddelay 1 6 N-TRON/Admin#[2]> rstp set bridgeforwarddelay 2 10
NOTES	Please ensure that the forwarddelay time and vlan id values are valid. STP switches can take up to 2x this figure before both the root switch and the STP switch changes the port modes into forwarding states.

### Get RSTP Bridge Forward Delay

Command Name	<b>rstp get bridgeforwarddelay</b>
Description	To get the Forward Delay Time of a given Vlan Id.
Syntax	<b>rstp get bridgeforwarddelay</b> <vlan-id>
Parameters	<b>vlan-id</b> Vlan Id for which the forward delay time is to be viewed.
Examples	N-TRON/Admin#[1]> rstp get bridge forwarddelay 1 N-TRON/Admin#[2]> rstp get bridge forwarddelay 2
NOTES	Please supply a valid Vlan Index ( being greater than zero)

### Set RSTP Bridge Hello Time

Command Name	<b>rstp set bridgehellotime</b>
Description	To set the HelloTime for a given Vlan-Id. With STP, Hello Time is the time intervals that the root bridge sends out new BPDUs to the rest of the network. Other STP capable switches will forward these BPDUs along. With RSTP every RSTP capable switch will generate new BPDUs and send them out on every Hello Time Interval.
Syntax	<b>rstp set bridgehellotime</b> <vlan-id> <hellotime>
Parameters	<b>vlan-id</b> Vlan Id for which the priority is to be set. <b>hellotime</b> Hello Time to be set. The valid range of the Hello Time is (1.0-10.0)secs.
Examples	N-TRON/Admin#[1]> rstp set bridgehellotime 1 2 N-TRON/Admin#[2]> rstp set bridgehellotime 2 5
NOTES	Please ensure that the hellotime and vlan id values are valid

### Get RSTP Bridge Hello Time

Command Name	<b>rstp get bridgehellotime</b>
Description	To get the Hello Time of a given Vlan Id.
Syntax	<b>rstp get bridgehellotime</b> <vlan-id>
Parameters	<b>vlan-id</b> Vlan Id for which the hellotime is to be viewed.
Examples	N-TRON/Admin#[1]> rstp get bridge hellotime 1 N-TRON/Admin#[2]> rstp get bridge hellotime 2
NOTES	Please supply valid Vlan Index ( being greater than zero)

### Set RSTP Bridge Max Age

Command Name	<b>rstp set bridgemaxage</b>
Description	To set the Max Age for a given Vlan-Id. RSTP Max Age is the time the switch waits after receiving a BPDU from the root bridge before declaring that there is no longer a valid path to the root bridge (therefore he attempts to become the new root bridge on the network). RSTP will only use this as a backup feature, and to allow compatibility with older STP devices.
Syntax	<b>rstp set bridgemaxage</b> <vlan-id> <maxage>
Parameters	<b>vlan-id</b> Vlan Id for which the priority is to be set. <b>maxage</b> The Max Age to be set. The valid range for maxage is 6.0-40.0 secs. (IEEE 802.1D)
Examples	N-TRON/Admin#[1]> rstp set bridgemaxage 1 7 N-TRON/Admin#[2]> rstp set bridgemaxage 2 40
NOTES	Please ensure that the max age and vlan-id are valid.

### Get RSTP Bridge Max Age

Command Name	<b>rstp get bridgemaxage</b>
Description	Gets the Bridge max age of the given Vlan-Id.
Syntax	<b>rstp get bridgemaxage</b> <vlan-id >
Parameters	<b>vlan-id</b> Vlan ID for which the maxage is to be viewed.
Examples	N-TRON/Admin#[1]> rstp get bridgemaxage 1 N-TRON/Admin#[2]> rstp get bridgemaxage 2
NOTES	Please supply valid vlan Index ( being greater than zero)

### Set RSTP Bridge Priority

Command Name	<b>rstp set bridgepriority</b>
Description	Sets the Bridge Priority. The root bridge on the network will be the one with the lowest bridge priority, or the lowest MAC address if the priorities are the same (as per IEEE 802.1D specification).
Syntax	<b>rstp set bridgepriority</b> <vlan-id> <bridge priority>
Parameters	<b>vlan-id</b> Vlan Id for which the priority to be set. <b>bridge priority</b> Priority of the Bridge to be set. The value should range between 0 and 65535. (as per IEEE 802.1D specification)
Examples	N-TRON/Admin#[1]> rstp set bridgepriority 1 1000 N-TRON/Admin#[2]> rstp set bridgepriority 2 2000
NOTES	Ensure to use a valid range of Bridge priority and Vlan Index (being greater than zero)

### Get RSTP Bridge Priority

Command Name	<b>rstp get bridgepriority</b>
Description	Gets the Bridge Priority of the given Vlan-Id.
Syntax	<b>rstp get bridgepriority</b> <vlan-id>
Parameters	<b>vlan-id</b> Vlan Id for which the priority is to be viewed .
Examples	N-TRON/Admin#[1]> rstp get bridgepriority 1 N-TRON/Admin#[2]> rstp get bridgepriority 2
NOTES	

### Set RSTP Port Path Cost

Command Name	<b>rstp set portpathcost</b>
Description	To set the port path cost for a given port in the given vlan id. STP and RSTP use the path cost to determine which path to use when there are 2 or more available paths that both have the same port priority.
Syntax	<b>rstp set portpathcost</b> <vlan-id> <port no> <pathcost>
Parameters	<b>vlan-id</b> Vlan Id for which the pathcost is to be set. <b>port no</b> The portnumber for which the path cost is to be set. <b>pathcost</b> The path cost value to be set (1-200000000).
Examples	N-TRON/Admin#[1]> rstp set portpathcost 1 4 100 N-TRON/Admin#[2]> rstp set portpathcost 2 6 200
NOTES	Please supply a valid Vlan Index (being greater than zero), a valid Port Number, and a valid path cost.

### Get RSTP Port Path Cost

Command Name	<b>rstp get portpathcost</b>
Description	To get the port path cost for a given port in the given vlan id
Syntax	<b>rstp get portpathcost</b> <vlan-id> <port no>
Parameters	<b>vlan-id</b> Vlan Id to which the port belongs. <b>port no</b> The portnumber for which the path cost is to be viewed.
Examples	N-TRON/Admin#[1]> rstp get port pathcost 1 4 N-TRON/Admin#[2]> rstp get port pathcost 2 6
NOTES	Please supply a valid Vlan Index (being greater than zero)and Port Number

### Set RSTP Port Priority

Command Name	<b>rstp set portpriority</b>
Description	To set the priority of the port for a given port in the given vlan-id. STP and RSTP use the port priority to determine which port to place into forwarding mode when there are 2 or more ports to choose from.
Syntax	<b>rstp set portpriority</b> <vlan-id> <port no> <port priority>
Parameters	<b>vlan-id</b> Vlan Id to which the port belongs. <b>port no</b> The portnumber for which the port priority is to be set. <b>port priority</b> The Port priority value to be set. The valid port priority is 0-255.
Examples	N-TRON/Admin#[1]> rstp set portpriority 1 4 100 N-TRON/Admin#[2]> rstp set portpriority 2 6 50
NOTES	Please supply a valid Vlan Index (being greater than zero)and Port Number. If the port priority is the same on both ports then the switch will resort to the path cost to determine the best path.

### Get RSTP Port Priority

Command Name	<b>rstp get portpriority</b>
Description	To get the priority of the port for a given port in the given vlan-id
Syntax	<b>rstp get portpriority</b> <vlan-id> <port no>
Parameters	<b>vlan-id</b> Vlan Id to which the port belongs. <b>port no</b> The portnumber for which the port priority is to be set.
Examples	N-TRON/Admin#[1]> rstp get portpriority 1 4 N-TRON/Admin#[2]> rstp get portpriority 2 6
NOTES	Please supply a valid Vlan Index (being greater than zero)and Port Number



## Broadcast Packet Count Limit Commands

### Get the Broadcast Packet Count Limit for one port

Command Name	<b>broadcast get percentage</b>
Description	Displays the broadcast packet percentage for a particular port.
Syntax	<b>broadcast get percentage</b> <port-number>
Parameters	<b>port-number</b> The port number must range between 1 and the maximum port number in the switch.
Examples	N-TRON/Admin#[1]> broadcast get percentage 6  The BPCL for port number 6 is : 100
NOTES	

### Get the Broadcast Packet Count Limit for all ports

Command Name	<b>broadcast show percentage</b>
Description	Displays the broadcast packet percentage for all ports.
Syntax	<b>broadcast show percentage</b>
Parameters	<b>None</b>
Examples	N-TRON/Admin#[1]> broadcast show percentage  Broadcast Percentage Value for Ports Port # 1 : 100            Port # 14 : 100 Port # 2 : 100 Port # 3 : 100 Port # 4 : 100 Port # 5 : 100 Port # 6 : 100 Port # 7 : 100 Port # 8 : 100 Port # 9 : 100 Port # 10 : 100 Port # 11 : 100 Port # 12 : 100 Port # 13 : 100
NOTES	<b>These are egress filters.</b>

### Set the Broadcast Packet Count Limit

Command Name	<b>broadcast set percentage</b>
Description	Sets the broadcast packet percentage for a particular port
Syntax	<b>broadcast set percentage</b> <port-number> <%>
Parameters	<b>port-number</b> The port number must range between 1 and the maximum port number in the switch.  <b>%</b> The count limit should be in the range 0 to 100 and represents the percentage.
Examples	N-TRON/Admin#[1]> broadcast set percentage 4 100
NOTES	Default is 3.

# VLAN Configuration Examples

## Example 1 – Basic understanding of port based VLANs

VLAN Configuration View

VLAN Status : Enable						
VLAN ID	VLAN Name	Untagged Port(s)	Tagged Port(s)	Mgmt Port	Admit	Mirror Port
1	Default VLAN	P3-P12	--	YES	All	0
2	VLAN -2	P1-P2	--	YES	All	0

Ports Configuration View

Port No	Port Name	PVID
1	P1	2
2	P2	2
3	P3	1
...	...	...
11	P11	1
12	P12	1

Receiving Port #	Tagged VID in packet	Destination Address	Transmitting Port #s	Notes
Port P1	Untagged	MAC on port P2	Port P2	Unicast Traffic
Port P1	Untagged	Unknown MAC	Port P2	Floods VLAN 2
Port P1	VID 4	MAC on port P2	Port P2	Strips VID off packet
Port P3	Untagged	MAC on port P5	Port P5	Unicast Traffic
Port P3	Untagged	Unknown MAC	Port P4-P12	Floods VLAN 1
Port P3	VID 4	MAC on port P6	Port P6	Strips VID off packet

## Example 2 – Basic understanding of tagged VLANs (Admit – Tagged Only)

VLAN Configuration View

VLAN Status : Enable						
VLAN ID	VLAN Name	Untagged Port(s)	Tagged Port(s)	Mgmt Port	Admit	Mirror Port
1	Default VLAN	--	P3-P12	YES	Tagged Only	0
2	VLAN -2	--	P1-P2	YES	Tagged Only	0

Ports Configuration View

Port No	Port Name	PVID
1	P1	**
2	P2	**
3	P3	**
...	...	...
11	P11	**
12	P12	**

Receiving Port #	Tagged VID in packet	Destination Address	Transmitting Port #s	Notes
Port P1	Untagged	MAC on port P2	--	Packet Discarded
Port P1	VID 2	MAC on port P2	Port P2	Unicast Traffic
Port P1	VID 4	MAC on port P2	--	Packet Discarded
Port P1	VID 2	MAC on port P5	Port P2	Floods VLAN 2
Port P3	Untagged	MAC on port P1	--	Packet Discarded
Port P3	VID 1	MAC on port P6	Port P6	Unicast Traffic
Port P3	VID 1	Unknown MAC	Port P4-P12	Floods VLAN 1
Port P3	VID 4	MAC on port P8	--	Packet Discarded

**Example 3 – Basic understanding of tagged VLANs (Admit – All)**

**VLAN Configuration View**

VLAN Status : Enable						
VLAN ID	VLAN Name	Untagged Port(s)	Tagged Port(s)	Mgmt Port	Admit	Mirror Port
<a href="#">1</a>	Default VLAN	--	P3-P12	YES	All	0
<a href="#">2</a>	VLAN -2	--	P1-P2	YES	All	0

**Ports Configuration View**

Port No	Port Name	PVID
<a href="#">1</a>	P1	**
<a href="#">2</a>	P2	**
<a href="#">3</a>	P3	**
...	...	...
<a href="#">11</a>	P11	**
<a href="#">12</a>	P12	**

Receiving Port #	Tagged VID in packet	Destination Address	Transmitting Port #s	Notes
Port P1	Untagged	MAC on port P2	Port P2	Adds VID 2 to packet
Port P1	VID 2	MAC on port P2	Port P2	Unicast Traffic
Port P1	VID 4	MAC on port P2	--	Packet Discarded
Port P1	VID 2	Unknown MAC	Port P2	Floods VLAN 2
Port P3	Untagged	Unknown MAC	Port P4-P12	Adds VID 1 to packet & Floods VLAN 1
Port P3	VID 1	MAC on port P6	Port P6	Unicast Traffic
Port P3	VID 1	Unknown MAC	Port P4-P12	Floods VLAN 1
Port P3	VID 4	MAC on port B2	--	Packet Discarded

**Example 4 – Basic understanding of Hybrid VLANs**

**VLAN Configuration View**

VLAN Status : Enable						
VLAN ID	VLAN Name	Untagged Port(s)	Tagged Port(s)	Mgmt Port	Admit	Mirror Port
<a href="#">1</a>	Default VLAN	P3-P12	--	YES	All	0
<a href="#">2</a>	VLAN -2	P1-P2	P3-P4	YES	All	0

**Ports Configuration View**

Port No	Port Name	PVID
<a href="#">1</a>	P1	2
<a href="#">2</a>	P2	2
<a href="#">3</a>	P3	1
...	...	...
<a href="#">11</a>	P11	1
<a href="#">12</a>	P12	1

Receiving Port #	Tagged VID in packet	Destination Address	Transmitting Port #s	Notes
Port P1	Untagged	MAC on port P2	Port P2	Unicast Traffic
Port P1	Untagged	MAC on port P3	Port P3	Adds VID 2 in the packet
Port P1	VID 4	MAC on port P2	--	Packet Discarded
Port P1	VID 4	MAC on port P3	--	Packet Discarded
Port P1	VID 2	MAC on port P2	Port P2	Strips VID off packet
Port P3	Untagged	MAC on port P6	Port P6	Unicast Traffic
Port P3	Untagged	Unknown MAC	Port P4-P12	Floods VLAN 1
Port P3	VID 4	MAC on port P5	--	Packet Discarded
Port P3	VID 4	MAC on port P4	--	Packet Discarded
Port P3	VID 2	MAC on port P4	Port P4	Strips VID off packet
Port P3	VID 2	MAC on port P1	Port P1	Strips VID off packet

**Example 5 – Basic understanding of Overlapping VLANs**

**VLAN Configuration View**

VLAN Status : Enable						
VLAN ID	VLAN Name	Untagged Port(s)	Tagged Port(s)	Mgmt Port	Admit	Mirror Port
<a href="#">1</a>	Default VLAN	--	--	YES	All	0
<a href="#">2</a>	VLAN -2	P1-P12	--	YES	All	0
<a href="#">3</a>	VLAN -3	P2-P12	--	YES	All	0
<a href="#">4</a>	VLAN -4	P1-P2	--	YES	All	0

**Ports Configuration View**

Port No	Port Name	PVID
<a href="#">1</a>	P1	4
<a href="#">2</a>	P2	2
<a href="#">3</a>	P3	3
<a href="#">4</a>	P4	2
<a href="#">5</a>	P5	3
...	...	...
<a href="#">11</a>	P11	3
<a href="#">12</a>	P12	3

Receiving Port #	Tagged VID in packet	Destination Address	Transmitting Port #s	Notes
Port P1	Untagged	MAC on port P2	Port P2	Unicast Traffic
Port P1	Untagged	MAC on port P3	--	Packet Discarded
Port P1	VID 4	MAC on port P2	Port P2	Strips VID off packet
Port P1	VID 4	Unknown MAC	Port P2	Strips VID off packet & Floods VLAN 4
Port P2	Untagged	MAC on port P1	Port P1	Unicast Traffic
Port P2	Untagged	MAC on port P5	Port P5	Unicast Traffic
Port P2	VID 2 or 3	MAC on port P5	Port P5	Strips VID off packet
Port P2	Untagged	Unknown MAC	Port P4	Floods VLAN 2
Port P3	Untagged	MAC on port P1	--	Packet Discarded
Port P3	Untagged	MAC on port P2	Port P2	Unicast Traffic
Port P3	Untagged	MAC on port P5	Port P5	Unicast Traffic
Port P3	VID 2 or 3	MAC on port P2	Port P2	Strips VID off packet

**Example 6 – Basic understanding of VLANs with Multicast Filtering**

**VLAN Configuration View**

VLAN Status : Enable						
VLAN ID	VLAN Name	Untagged Port(s)	Tagged Port(s)	Mgmt Port	Admit	Mirror Port
1	Default VLAN	--	--	YES	All	0
2	VLAN -2	P1-P12	--	YES	All	0
3	VLAN -3	P2-P12	--	YES	All	0
4	VLAN -4	P1-P2	--	YES	All	0

**Display Static Multicast Group Address(es)**

Multicast Address	Port List
01:00:00:00:00:01	P1-P12
01:00:00:00:00:02	P1,P6,P8

**Ports Configuration View**

Port No	Port Name	PVID
1	P1	4
2	P2	2
3	P3	3
...	...	...
11	P11	3
12	P12	3

Receiving Port #	Tagged VID in packet	Destination Address	Transmitting Port #s	Notes
Port P1	Untagged	01:00:00:00:00:01	Port P2	Goes to Ports P1-P12, but port P1 can only send to Port P2 (VLAN 4)
Port P3	Untagged	01:00:00:00:00:02	Port P7	Packet Discarded
Port P2	Untagged	01:00:00:00:00:01	Port P1,P3-P12	Goes to Ports P1-P12, but won't go back out the port it came in on
Port P2	Untagged	01:00:00:00:00:02	Port P1,P6,P8	Goes to ports P1,P6,P8
Port P3	Untagged	01:00:00:00:00:01	Port P2	Goes to Port P3.
Port P6	Untagged	01:00:00:00:00:02	Port P8	Goes to Port P6.
Port P3	Untagged	01:00:00:00:00:02	Port P9	Packet Discarded

Note: If there are multiple ports on different VLANs, the 7014 will apply the static multicast address to the lowest VLAN-ID that is associated with one of the ports assigned to the static multicast address. If the lowest VLAN-ID contains all the ports assigned to the static multicast address (an umbrella VLAN), it will function for all those ports with no problems. This can be achieved with overlapping VLANs.

For further information and examples on overlapping vlans, see:

<http://www.n-tron.com/pdf/overlappingportvlan.pdf>

# KEY SPECIFICATION

## Switch Properties

Number of MAC Addresses: 4,096  
 Aging Time: Programmable  
 Latency Type: 2.9  $\mu$ s  
 Switching Method: Store & Forward

## Physical

Height: 2.50" / 6.35 cm  
 Width: 7.40" / 18.76 cm  
 Depth: 4.15" / 10.54 cm  
 Weight (max): 2.10 LBS / 0.95 kg  
 Din-Rail mount: 35mm

## Electrical

Redundant Input Voltage: 10-30 VDC  
 Input Current (max): 3.0 A  
 Inrush @ 24VDC: 12.6A/0.05ms  
 Input Ripple: Less than 100 mV  
 N-TRON Power Supply: NTPS-24-3 (3 Amp@24VDC) (NOTE: Not appropriate for use with M12, POE, and HV models.)



## Environmental

Operating Temperature: -20°C to 70°C  
 Storage Temperature: -40°C to 85°C  
 Operating Humidity: 10% to 95% (Non Condensing)  
 Operating Altitude: 0 to 10,000 ft.

## Shock and Vibration (bulkhead mounting)

Shock: 200g @ 10ms  
 Vibration/Seismic: 50g, 5-200Hz, Triaxial

## Reliability

MTBF: >1Million Hours

## Connectors

10/100BaseTX: Ten (10) RJ-45 Copper Ports  
 100BaseFX: Two (2) SC or ST Duplex Ports  
 1000BaseSX/LX: Up to two (2) SFP LC Duplex Ports as an option  
 1000BaseT: Up to two (2) SFP RJ45 Duplex Ports as an option

## Recommended Wiring Clearance:

Front: 4" (10.16 cm) FX models  
 2" (5.08 cm) TX models  
 Side: 1" (2.54 cm)

## Network Media

10BaseT: >Cat3 Cable  
 100BaseTX: >Cat5 Cable  
 1000BaseT: >Cat5e Cable  
 minimum length : 1 meter  
 maximum length : 100 meters  
 100BaseFX, 1000BaseSX:  
 Multimode: 50-62.5/125 $\mu$ m  
 100BaseFXE, 1000BaseLX:  
 Singlemode: 7-10/125 $\mu$ m

### Gigabit Fiber Transceiver (SFP) Characteristics

<b>Fiber Length</b>	550m* with 50/125 $\mu$ m 275m @ 62.5/125 $\mu$ m	10km**	40km**	80km**
<b>TX Power Min</b>	-9.5dBm	-9.5dBm	-2dBm	0dBm
<b>RX Sensitivity Max</b>	-17dBm	-20dBm	-22dBm	-24dBm
<b>Wavelength</b>	850nm	1310nm	1310nm	1550nm
<b>Assumed Fiber Loss</b>	3.5 to 3.75 dB/km	0.45 dB/km	0.35 dB/km	0.25 dB/km
<b>Laser Type</b>	VCSEL	FP	DFB	DFB

*SX Fiber Optic Cable

** LX Fiber Optic Cable

### 100 Mb Fiber Transceiver Characteristics

<b>Fiber Length</b>	2km*	15km**	40km**	80km**
<b>TX Power Min</b>	-19dBm	-15dBm	-5dBm	-5dBm
<b>RX Sensitivity Max</b>	-31dBm	-31dBm	-34dBm	-34dBm
<b>Wavelength Min/Max</b>	1310nm	1310nm	1310nm	1550nm

* Multimode Fiber Optic Cable

** Singlemode Fiber Optic Cable

### Regulatory Approvals:

**Safety:** Suitable for use in Class I, Division 2, Groups A, B, C and D Hazardous Locations, or Nonhazardous Locations only.

**EMI:** EN 61000-6-4, EN 55011 – Class A  
FCC Title 47, Part 15, Subpart B - Class A  
ICES-003 – Class A

**EMS:** EN 61000-6-2  
IEC 61000-4-2 (ESD)  
IEC 61000-4-3 (RS)  
IEC 61000-4-4 (EFT)  
IEC 61000-4-5 (Surge)  
IEC 61000-4-6 (Conducted Disturbances)

### GOST-R Certified.

**Warranty:** Effective January 1, 2008, all N-TRON products carry a 3 year limited warranty from the date of purchase.

## **N-TRON Limited Warranty**

N-TRON, Corp. warrants to the end user that this hardware product will be free from defects in workmanship and materials, under normal use and service, for the applicable warranty period from the date of purchase from N-TRON or its authorized reseller. If a product does not operate as warranted during the applicable warranty period, N-TRON shall, at its option and expense, repair the defective product or part, deliver to customer an equivalent product or part to replace the defective item, or refund to customer the purchase price paid for the defective product. All products that are replaced will become the property of N-TRON. Replacement products may be new or reconditioned. Any replaced or repaired product or part has a ninety (90) day warranty or the remainder of the initial warranty period, whichever is longer. N-TRON shall not be responsible for any custom software or firmware, configuration information, or memory data of customer contained in, stored on, or integrated with any products returned to N-TRON pursuant to any warranty.

**OBTAINING WARRANTY SERVICE:** Customer must contact N-TRON within the applicable warranty period to obtain warranty service authorization. Dated proof of purchase from N-TRON or its authorized reseller may be required. Products returned to N-TRON must be pre-authorized by N-TRON with a Return Material Authorization (RMA) number marked on the outside of the package, and sent prepaid and packaged appropriately for safe shipment. Responsibility for loss or damage does not transfer to N-TRON until the returned item is received by N-TRON. The repaired or replaced item will be shipped to the customer, at N-TRON's expense, not later than thirty (30) days after N-TRON receives the product. N-TRON shall not be responsible for any software, firmware, information, or memory data of customer contained in, stored on, or integrated with any products returned to N-TRON for repair, whether under warranty or not.

**ADVANCE REPLACEMENT OPTION:** Upon registration, this product qualifies for advance replacement. A replacement product will be shipped within three (3) days after verification by N-TRON that the product is considered defective. The shipment of advance replacement products is subject to local legal requirements and may not be available in all locations. When an advance replacement is provided and customer fails to return the original product to N-TRON within fifteen (15) days after shipment of the replacement, N-TRON will charge customer for the replacement product, at list price.

**WARRANTIES EXCLUSIVE:** IF AN N-TRON PRODUCT DOES NOT OPERATE AS WARRANTED ABOVE, CUSTOMER'S SOLE REMEDY FOR BREACH OF THAT WARRANTY SHALL BE REPAIR, REPLACEMENT, OR REFUND OF THE PURCHASE PRICE PAID, AT N-TRON'S OPTION. TO THE FULL EXTENT ALLOWED BY LAW, THE FOREGOING WARRANTIES AND REMEDIES ARE EXCLUSIVE AND ARE IN LIEU OF ALL OTHER WARRANTIES, TERMS, OR CONDITIONS, EXPRESS OR IMPLIED, EITHER IN FACT OR BY OPERATION OF LAW, STATUTORY OR OTHERWISE, INCLUDING WARRANTIES, TERMS, OR CONDITIONS OF MERCHANTABILITY, FITNESS FOR A PARTICULAR PURPOSE, SATISFACTORY QUALITY, CORRESPONDENCE WITH DESCRIPTION, AND NON-INFRINGEMENT, ALL OF WHICH ARE EXPRESSLY DISCLAIMED. N-TRON NEITHER ASSUMES NOR AUTHORIZES ANY OTHER PERSON TO ASSUME FOR IT ANY OTHER LIABILITY IN CONNECTION WITH THE SALE, INSTALLATION, MAINTENANCE OR USE OF ITS PRODUCTS. N-TRON SHALL NOT BE LIABLE UNDER THIS WARRANTY IF ITS TESTING AND EXAMINATION DISCLOSE THAT THE ALLEGED DEFECT OR MALFUNCTION IN THE PRODUCT DOES NOT EXIST OR WAS CAUSED BY CUSTOMER'S OR ANY THIRD PERSON'S MISUSE, NEGLIGENCE, IMPROPER INSTALLATION OR TESTING, UNAUTHORIZED ATTEMPTS TO OPEN, REPAIR OR MODIFY THE PRODUCT, OR ANY OTHER CAUSE BEYOND THE RANGE OF THE INTENDED USE, OR BY ACCIDENT, FIRE, LIGHTNING, POWER CUTS OR OUTAGES, OTHER HAZARDS, OR ACTS OF GOD.

**LIMITATION OF LIABILITY:** TO THE FULL EXTENT ALLOWED BY LAW, N-TRON ALSO EXCLUDES FOR ITSELF AND ITS SUPPLIERS ANY LIABILITY, WHETHER BASED IN CONTRACT OR TORT (INCLUDING NEGLIGENCE), FOR INCIDENTAL, CONSEQUENTIAL, INDIRECT, SPECIAL, OR PUNITIVE DAMAGES OF ANY KIND, OR FOR LOSS OF REVENUE OR PROFITS, LOSS OF BUSINESS, LOSS OF INFORMATION OR DATA, OR OTHER FINANCIAL LOSS ARISING OUT OF OR IN CONNECTION WITH THE SALE, INSTALLATION, MAINTENANCE, USE, PERFORMANCE, FAILURE, OR INTERRUPTION OF ITS PRODUCTS, EVEN IF N-TRON OR ITS AUTHORIZED RESELLER HAS BEEN ADVISED OF THE POSSIBILITY OF SUCH DAMAGES, AND LIMITS ITS LIABILITY TO REPAIR, REPLACEMENT, OR REFUND OF THE PURCHASE PRICE PAID, AT N-TRON'S OPTION. THIS DISCLAIMER OF LIABILITY FOR DAMAGES WILL NOT BE AFFECTED IF ANY REMEDY PROVIDED HEREIN SHALL FAIL OF ITS ESSENTIAL PURPOSE.

**DISCLAIMER:** Some countries, states, or provinces do not allow the exclusion or limitation of implied warranties or the limitation of incidental or consequential damages for certain products supplied to consumers, or the limitation of liability for personal injury, so the above limitations and exclusions may be limited in their application to you. When the implied warranties are not allowed to be excluded in their entirety, they will be limited to the duration of the applicable written warranty. This warranty gives you specific legal rights which may vary depending on local law.

**GOVERNING LAW:** This Limited Warranty shall be governed by the laws of the State of Delaware, U.S.A.