



Ocean Data Systems



**Ocean Data Systems Ltd.**  
The Art of Industrial Intelligence

---

# **Dream Report<sup>®</sup>**

## **Version 4.7**

### **User's Guide**

**User Friendly and Programming Free<sup>™</sup>**  
**Reporting for Automation**

**<http://www.dreamreport.net>**

Copyright ©, All rights reserved, Ocean Data Systems Ltd.



# Table of Contents

<b>1. Help Documentation</b>	<b>7</b>
<b>2. General Information</b>	<b>7</b>
Dream Report - Enterprise Information Integration and Reporting Software	7
System Requirements	8
Dream Report Installation Tips	10
Uninstall or Modify Installation	13
Project Upgrade Procedure	15
<b>3. Licensing and Software Protection</b>	<b>19</b>
<b>4. Project Wizard</b>	<b>21</b>
Project Wizard - General	21
Project Wizard - Project Name	24
Project Wizard - Connectivity	25
Project Wizard - Data Archiving	27
Project Wizard - Batch Definition	32
Project Wizard - Report Configuration	36
<b>5. Project Settings</b>	<b>50</b>
Project Settings - General	50
Project Settings - Database Configuration	53
Project Settings - Web Configuration	56
Project Settings - Folder Selection	59
Project Settings - Log File Settings	60
Hotbackup (Redundancy) Configuration	62
Project Settings - Localization	64
<b>6. User Management</b>	<b>66</b>
Project Settings - User Management	66
User/Group Authorization	70
<b>7. Audit Trail</b>	<b>73</b>
<b>8. Report Settings</b>	<b>74</b>
Report Settings - General	74
Report Settings - Report Name Format	79
Report Settings - Generation Time Definition	81
Report Settings - Generate Report on Event	83
Report Settings - Report Output Format	85
Report Settings - Excel Reports	87
Report Settings - Email Configuration	90
Report Settings - Printer Selection	92
Report Preprocessor	93
Report Settings - Macros	96
Report Settings - User Authorization	97
Report Settings - Advanced PDF Security	98

---

<b>9. Logger Configuration Studio</b>	<b>99</b>
Logger Studio Overview	99
<b>10. Communication Driver Configuration</b>	<b>101</b>
<b>11. Item Group</b>	<b>104</b>
Item Group Definition	104
Item Group Definition - Logging Schedule	106
Item Group Definition - Log on Event	109
Alarm Group	111
Alarm Group Definition - Logging Schedule	113
Alarm Group Definition - Log on Event	114
<b>12. Designer Studio</b>	<b>115</b>
Designer Studio - Create new report	115
Rulers and Grid	117
Designer Studio - Static Objects	119
Designer Studio - Insert Picture	120
Designer Studio - Background	123
Designer Studio - Text Object	124
Designer Studio - Search and Replace	125
List of Dynamic Tokens	130
Using Dynamic Tokens in a Data Source Definition	132
<b>13. Simple Statistic Objects</b>	<b>134</b>
Designer Studio - Single Data Object	134
General Functions:	136
Advanced Functions:	137
Performance Analysis Functions:	140
Energy Management Functions:	141
Batch Functions:	141
Set Point Analysis Functions:	141
Alarm Analysis Functions:	144
Direct SQL Query:	144
Pulse Analysis Functions:	145
Manual Input:	146
Designer Studio - Compound Data Object	148
Designer Studio - Expression Data Object	149
Advanced Visualization	156
Designer Studio - Batch Definition	157
Appearance - Result Representation	160
Alarm Filter Manager	169
Dynamic Text Object	170
Page Number Object	172
Advanced SQL Condition	173
Date & Time Object	174
Time Period Definition	176
Apply Correction Factor	179
<b>14. Tables</b>	<b>180</b>
Item Table (Raw Values)	180
Free Table	183
Automatic Statistical Table	185
Designer Studio - Step Table	188



## Ocean Data Systems

SQL Query Table	196
SQL Query Manager	197
Designer Studio - Alarm Table	202
Table Footer	206
<b>15. Charts and Graphs</b>	<b>208</b>
Pie Graph	208
Bar Graph	212
Line Chart	220
Indicator	230
<b>16. Dynamic Interactive Objects</b>	<b>235</b>
Timestamp Picker	235
Hyperlink	237
Combo Box	240
Action Button	247
Tree Object	253
<b>17. Report and Page Templates</b>	<b>255</b>
Page Templates	255
Report Templates	257
<b>18. Tools</b>	<b>262</b>
Tag Dictionary	262
Setpoint Stability Analysis	265
Custom Archives Import Tool	269
Virtual Report Instances	271
DBatch	274
Database Archiving	281
Aggregated Data Filter	284
Multi-Tag Aggregation	287
Pivot Groups	292
Pivot Tables (SQL Table Row Grouping)	295
Project Deployment Tool	298
Dynamic Objects Selection	299
Electronic-Signature	300
Data Modeler	306
FTP Transfer Engine	310
<b>19. SPC Module</b>	<b>313</b>
SPC Configuration	314
SPC Control Charts - X-bar, R and S	315
Histogram Chart	319
Histogram Table	321
Process Value Table	324
SPC Statistical Functions	326
<b>20. SQL Development Tools</b>	<b>327</b>
DSN Manager	327
Edit SQL Query	329
SQL Query Manager	330
Visual SQL Query Designer	332



---

<b>21. Runtime Manager</b>	<b>333</b>
Runtime Management Console	333
Runtime Configuration	342
Dynamic Report Generator	344
<b>22. Communication Drivers</b>	<b>352</b>
List of Communication Drivers	352
Data Source Definition	357
Supported GE Intelligent Platforms Software	361
Cimplicity historical values driver	362
GE Proficy Historian Historical Messages driver	364
GE Proficy Historian Historical Values driver	367
iFix Native real-time values driver	371
iFix Native real-time alarms driver	372
iFix Native historical values driver	373
iFix Native historical alarms driver	375
ODBC Driver	376
Excel Data Import Driver	380
OPC Drivers	387
Modbus Communication Driver	392
Analytical Driver	396
Web Manual Driver	397
Rockwell RSView Historical Values Driver	399
InTouch Native Driver	401
Wonderware OPC Driver	404
Wonderware Historian driver	408
InTouch Historian Driver (LGH files)	411
Wonderware WWALM Historical Alarms Driver	413
WW Historian Alarms Driver	417
OPC Offline Driver	420
Eurotherm Review Communication Driver	422
PcVue Communication Drivers	425
Control Maestro (legacy Wizcon) communication driver	432
LUA Script Historical Data Access driver	433
Kit of Simulation drivers	436
Communication driver development toolkit	440
<b>23. Remote Connector</b>	<b>441</b>
Remote Connector Server	441
Remote Driver Connector	443
<b>24. Web Portal</b>	<b>445</b>
Dream Report Web Portal	445
Web Manual Driver	454
Manual Data Entry	456
IIS Configuration on Windows Vista	458
Manual Configuration of IIS	459
<b>25. Dynamic Interactive Objects</b>	<b>470</b>
Timestamp Picker	470
Hyperlink	472
Combo Box	475
Action Button	482
Tree Object	488





# Help Documentation

## General Information

### Dream Report - Enterprise Information Integration and Reporting Software

Dream Report is professional software for industrial automation, for real-time data and alarm acquisition, logging to the database as well as data analysis and advanced reporting, based on Dream Report database or any other external history data server.

#### **Dream Report is out-of-the-box Reporting software for the Automation Market which:**

- Directly collects Alarms and Raw Data from multiple heterogeneous Data Sources such as I/O, PLC, RTU, SCADA, DCS, MES, etc.
- Leverages all archives from other solutions and applications such as SCADA, Historians...
- Aggregates and logs to any standard Database all alarms and Data collected facilitating Information Integration within Manufacturing and Enterprise applications
- Integrates in one user-friendly environment all tools to easily create and generate automated Reports
- Enables Print, Archive, Email and Reports Publishing over the Web automatically
- Is intuitive requiring only one-day training and assimilation
- Compatible with any application in all Vertical Markets
- Runs in a fully secured multilingual environment
- Provides an extra tool (Dream Report Project Creating Wizard), that helps to create a turnkey simple project, which can be later edited and developed in the Dream Report Studio

To learn how to configure data logging, please, refer to [Logger Studio](#) section.

To learn more about database configuration and maintenance, please, refer to [Database Configuration](#) section

To learn more about report graphical design, please, refer to [Designer Studio](#) section.

To learn more about report configuration and/or report automatic generation and distribution, please, refer to [Report Settings](#) section.



## System Requirements

### Hardware Requirements

<b>CPU:</b>	Dual Core 2.4 GHz+
<b>RAM:</b>	8 Gb+
<b>HDD:</b>	500Mb (for installation) minimum, 7200 rpm or higher (or SSD)
<b>Video adapter:</b>	Minimum memory 128 Mb
<b>Network adapter:</b>	No special requirements
<b>Monitor resolution:</b>	1280x768

### Operating Systems Supported

- Windows 2003 Server (incl. R2)(Web Portal requires Service Pack 2)
- Windows Vista (Web Portal requires Service Pack 1 and higher)
- Windows 2008 Server (incl.R2), any SP and (32-bit) and (64-bit)
- Windows Server 2012 (incl.R2), any SP, (32-bit and 64-bit editions)
- Windows 7 (32-bit) and (64-bit) with and without SP1
- Windows 8 Professional and Enterprise (32-bit and 64-bit editions), incl. SP1 and SP1 R2
- Windows 8.1 Professional and Enterprise
- Windows 10

### Databases Supported

- MS SQL Server 2005 Express, 2008 Express, 2012 Express (using ODBC SQL Native Client 11) , 2014 Express (using ODBC SQL Native Client 11)
- MS Access 2000, 2003, 2007, 2010, 2013
- MS SQL Server 2005, 2008 (incl. R2)
- MS SQL Server 2012 over ODBC SQL Native Client 11
- MS SQL Server 2014 over ODBC SQL Native Client 11
- MySQL 4.x and 5.x versions over ODBC driver 3.51, 5.1
- Oracle 11 over Oracle XE ODBC driver

### Web Browsers Support for Web Portal

- Internet Explorer 9 and higher (IE 11 recommended)
- Edge
- Chrome
- Mozilla
- Opera

### Mobile Operating Systems

The Dream Report Web portal is supported in a web browser on Android, iOS (both iPad and iPhone) and Windows Phone 8.1.



## Additional Software Requirements

- To visualize PDF files you need to install Adobe Acrobat or other PDF viewer (the latest versions are recommended)
- To use Web Portal, you have to install a web server (Internet Information Server or other) before Dream Report® installation.
- .NET Framework 3.5 **and** .NET Framework 4.5 or higher has to be installed before Dream Report® installation.
- If you want to use [DRWeb Portal](#), please install a web server (Internet Information Services) before installing Dream Report. For additional information on configuring IIS for use with Dream Report, please refer to the [Web Portal](#) section

For a complete list of supported operating systems and databases for all versions of Dream Report, please refer to the following **Compatibility Matrix**:

<http://dreamreport.net/wp-content/uploads/Dream-Report-Windows-and-Database-Support-Matrix-Dec2015.pdf>

## Online Help:

The online help contains detailed description about most of Dream Report functionality and is available in 3 different ways.

It can be loaded:

- Pressing F1 in Dream Report studio
- From menu Help in Dream Report Designer Studio
- From start menu in Windows (*Start-->Programs-->ODS-->Documentation-->Dream Report Online Help*)

## Contact us to buy:

[sales@dreamreport.net](mailto:sales@dreamreport.net)

### Contact our technical support:

[support@dreamreport.net](mailto:support@dreamreport.net)

For any other information, please, visit our web site:

[www.dreamreport.net](http://www.dreamreport.net)

Join our LinkedIn groups:

<https://www.linkedin.com/groups/7450756>



## Dream Report Installation Tips

### Installation of Dream Report

- **Prerequisites**

Before installation user has to ensure that the following list of components is installed on the target computer:

1. Microsoft .NET framework 3.5 or 3.5 SP1.
2. If user plans to run the Dream Report embedded web portal, then IIS (Internet Information Services) feature has to be installed on the computer.
3. It is recommended to close all running programs due to the fact that, at the end of installation, user will be asked to restart the computer.

- **Installation process**

In order to start Dream Report installation, please use the CD (supplied by Ocean Data Systems) with the product installer or download the product from the Dream Report corporate web portal.

1. Run Dream Report setup executable.
2. Accept the license agreement.
3. Select all required components from the Features Tree (including required communication drivers).
4. Wait while the product installation process is completed.
5. Restart the computer.

Here are some installation tips, which we ask you to read before installing:

- **Selection of Communication Drivers.**

When installing Dream Report, it will automatically install only 4 basic drivers: OPC, ODBC, Analytical and Simulation drivers. If you need to use any other drivers in your project, then, during product installation, when you come to the "Select installed components" window in the installation wizard, you will see a tree of installed components and communication drivers. There you have to expand a **Communication Drivers** branch of that tree and select (check) all drivers, which you may need when using Dream Report.

- **Web portal**

During Dream Report installation, the installation wizard will check if Internet Information Services (IIS) are installed in your operating system. Together with IIS you have to ensure that all ASP.NET related components are installed (please refer to [Manual Configuration of the IIS](#) guide). If IIS is not installed on your system, then the Web portal and all related components will not be installed. In this case you will get a prompt message that IIS installation is not found, and the Web portal will not be installed, and if you wish to continue product installation.

If you do not intend to use Dream Report web portal, please, click "Yes" and the product installation will continue without installing Web portal. If you do intend to use Dream Report web portal, please, click "No", exit Dream Report installation, install IIS and after that install Dream Report.

If you have installed Dream Report without the web portal and afterwards you have installed IIS and you wish to start to use the Dream Report web portal, you have to uninstall Dream Report and then install it again. During new installation, Dream Report installation procedure will recognize that IIS is installed and then all relevant web components will be installed.



## Ocean Data Systems

- **Additional installed components (OPC Core Components and Visual C++ Runtime)**

During installation of Dream Report, one of Dream Report installation wizard sections is "[Select installation components](#)". In this section you will see a tree of components, available for installation, including Dream Report designer studio, Communication drivers and others. This section also has two custom components in that list: OPC Core Component and Visual C++ 2005 Runtime Redistributable. Please, check why and when you may need them:

- [OPC Core Component](#). This is an official patch, redistributable from the OPC Foundation. It re-installs all necessary Windows components, needed for proper operation of OPC. In many cases, strange OPC operating problems can be solved just by installing this component. If you do not use OPC (DA/AE/HDA) in your Dream Report projects, then installation of these components is not required.

- [Visual C++ Runtime Redistributable](#). This is a component, provided by Microsoft, which is required for proper operation of Web Services communication. In the actual version of Dream Report, Web Services are used in the communication drivers for PcVue SCADA and for Schneider FactoryCast PLC. If you use Dream Report with native communication to PcVue SCADA package, please, install this component. Otherwise, its installation is not required

- **Language Installation**

While installing Dream Report, installation procedure doesn't provide selection of the installed language. Though Dream Report has true-multilingual environment, you can set your preferred language after installation in the Project Settings section in the Dream Report studio. However, also during installation, Dream Report will automatically check for the language of actual operating system and will automatically set product language to it, if that language exists in the product, or otherwise set product language to English (as default).

Also, it is possible to manually change the current language - open [DreamReport.ini](#) file in the [System](#) folder. This is an ASCII text file, which can be opened using Notepad or other text editors. This file contains section [Current Language]. You will see there the actual defined language. You can change it to any other language, existing in the Dream Report lexicon, save and close the file. The next time you open Dream Report Designer Studio or Runtime Manager, the new language setting will be used.

- **Installed tools and utilities**

Dream Report installation doesn't install, but provides you with installation files for some free third-party software tools, which you may need while using Dream Report:

- [Adobe Acrobat Reader](#) is needed to open and view files in PDF format. If Adobe Reader is still not installed on your computer and you will generate report files in PDF format, please, find the installation of English version of [Adobe Acrobat Reader 11.0](#) (AdbRdr11000\_mui\_Std.exe) in the [Utilities](#) folder in Dream Report installation and install it.

- [Adobe flash player](#) is needed for better view of Dream Report online help as well as it may be used to visualize some web sites, which also use Flash technology.

- [MDAC](#) (Microsoft Data Access Component) - this is a component, redistributed by Microsoft, which is required for proper database management. if you use the default database option in Dream Report, then, Dream Report can create an MS Access database (MDB file) and interact with it without MS Access installed - using this free database engine (MDAC). Usually, MDAC is installed automatically with the operating system, but if for some reason your MDAC installation is corrupted or invalid, you can install it yourself from the [Utilities](#) folder.

- **Additional tools:**

- SQL Native client 11 - is required to connect to SQL Server databases

- Hasp Driver (installed during the process of Dream Report installation, can be re-installed upon user needs)



## Ocean Data Systems

- **User rights.**

Dream Report installation requires that current Windows user must have administrator rights on that local machine, where the product is installed. If the current user has only guest or other limited user rights, the installation will not run properly.

Also to run and use the product (using both designer studio and runtime manager), a user needs to have local administrative rights.

- **Firewall Blocking**

If your PC has Firewall installed and turned on, please, allow unblocking the following components:

**LoggerRT.exe**, **USC.exe** and **Generator.exe**. These are the components of Dream Report and won't do any harm to your computer.





## Uninstall or Modify Installation

- **Remove / Modify**

It is possible to modify or to remove Dream Report from your computer in two ways:

1. Open Start menu (*Start - Programs - ODS - Dream Report - Uninstall*).
2. Use [Add/Remove Programs](#) component in the Control Panel of your Windows.

### Modifying existing installation

In case you use the same installation to Remove/Modify Dream Report installation, when starting the installation, you will see the dialog window, which will offer you 2 available options - either *Modify* or *Remove* existing product installation.

If you want to [remove Dream Report](#) from your computer, choose the *Remove* option, click *Next* and the uninstall process will start. Be aware that not all folders will be removed during the uninstall process. Directories, that include all projects developed on that computer, will remain (by default *Project* folder). License and Template directories and all their content will NOT be erased (in order to save your existing license, if any, and also to save your custom clipart images, if you have any).

By selecting the *“Modify”* option, the *“Installation Components”* window will appear. This window will include all installed features as checked and all not installed yet as unchecked:

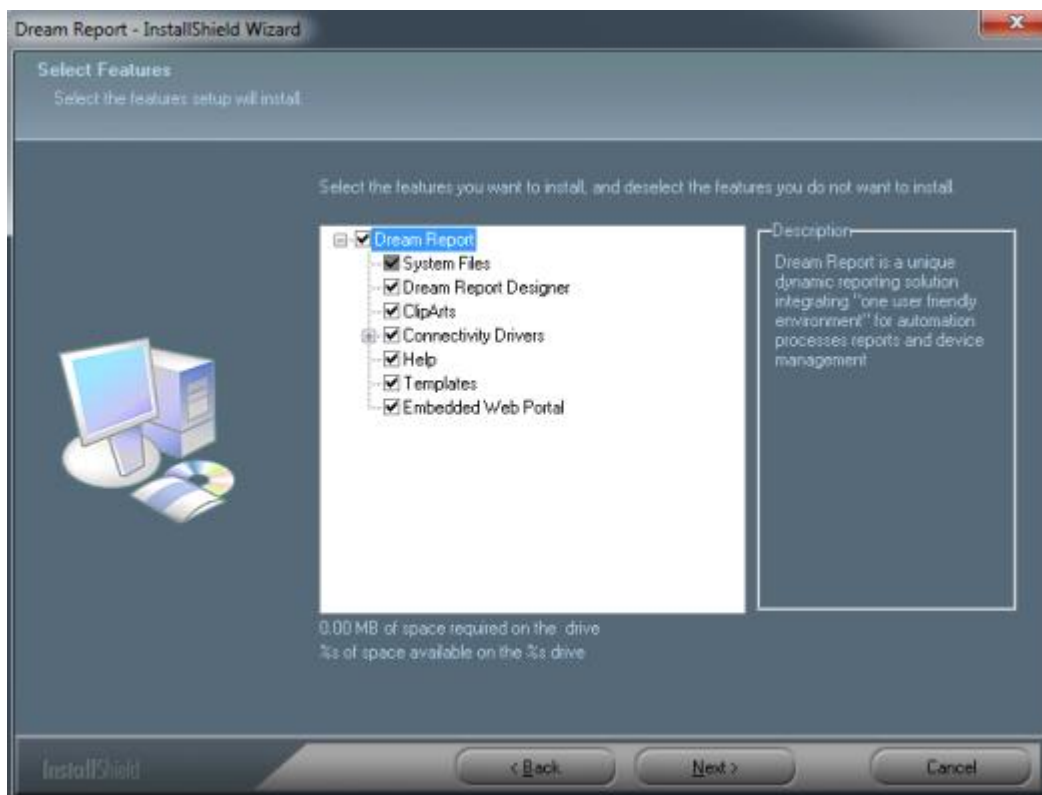



### Upgrading existing installation to a new version

The installer of Dream Report has an auto-upgrade feature. It will automatically recognize the version, currently installed on your computer, and start the upgrade process if its version has any newer files. During this process all new files will be copied to appropriate place. No uninstall of the previous version is needed.

When you run the installation, the corresponding window will appear, saying that the older product version is already installed on this computer.

Press the [Next](#) button in order to proceed with upgrade. You can continue using Dream Report right after upgrade.



## Project Upgrade Procedure

If you need to upgrade your project to a newer Dream Report version 4.6, please perform the following upgrade steps:

### 1. Backup of the Existing Project.

First, you should backup your actual Dream Report project, which was created and is running in an earlier version of Dream Report. Backup has to be done for the complete project folder including all subfolders.

### 2. Installation of Dream Report Version 4.6.

Now, you have to install Dream Report version 4.6 by launching the Dream Report setup executable. Please note that there is no need to uninstall the previously installed Dream Report version. If the previous version of Dream Report has been installed, then, by running the Dream Report version 4.6 setup, the installer will automatically recognize that the older version is already installed, and will propose an upgrade of the existing Dream Report installation by a new one. After completion of the installation process it is strongly recommended to restart your PC.

### 3. Loading the project.

Load the existing project with a newer product version 4.6 from **DREAM REPORT STUDIO**. You will get the warning message: “**Are you sure you want to perform an upgrade of the project?**” – Click “**Yes**”.

**NOTE:** Please note that since that moment you cannot downgrade the project to the previous Dream Report version. Therefore ensure to back up your project just before performing the upgrade operation.

### 4. Web Portal upgrade.

If you perform the upgrade of your project to Dream Report version 4.6, it is required to do a web portal manual update if it's used in the project. To do the Dream Report web portal update, take the following steps:

- a. Go to the project Web directory and delete the “**Settings.Config**” file.
- b. Open **Project Settings- Web Configuration**. Select all required web portal elements, which you are willing to include into the Dream Report web portal.
- c. Press “**Configure IIS**” button.

**NOTE:** If you are running Windows Vista, Window 7 or Windows 2008 server, before configuration of IIS, please ensure that the following components are installed in Windows Features – Internet Information Services:

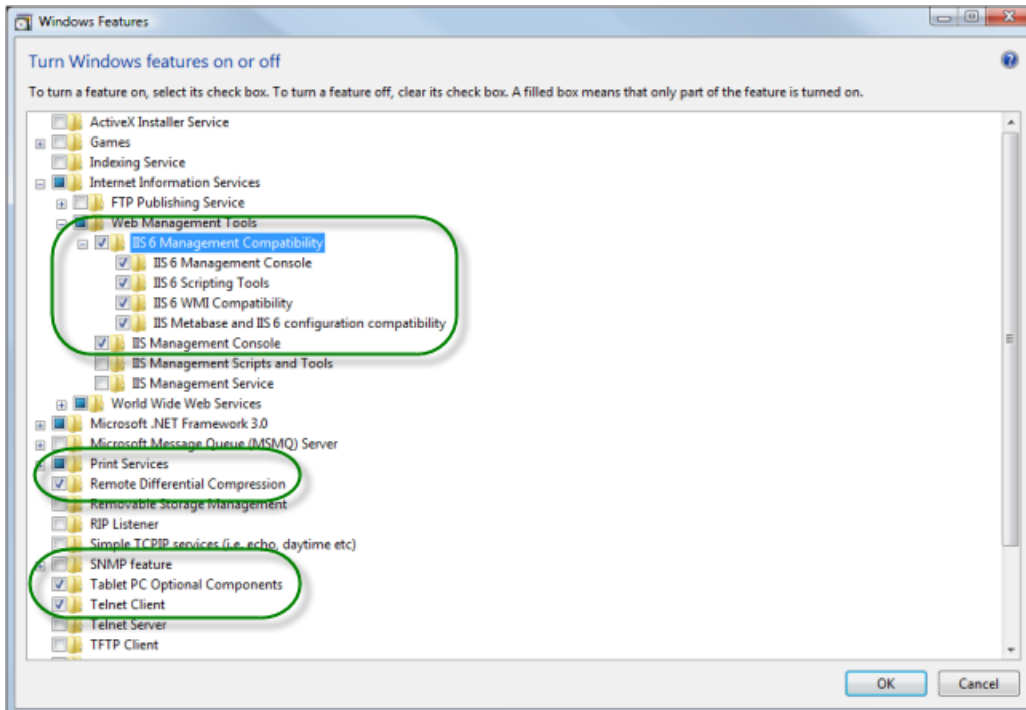

**NOTE:** In order to successfully upgrade Web Portal to Dream Report version 4.6, when you click "*Configure IIS*" button, you will have to agree to save the backup of your Web Portal configuration (in the **IIS configurator** window, which will pop up, user will have to click "*Yes*" (please see the picture below):

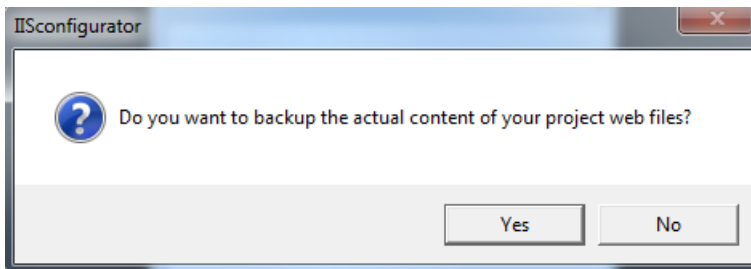

## 5. Project Database Upgrade.

If you upgrade your project to the Dream Report version 4.6, you will also have to convert the database, as Dream Report version 4.6 has the new internal database structure and the existing database from the previous versions is unavailable for reporting.

If your Dream Report project is configured so that the data is logged into the internal Dream Report database, then, in order to convert the existing database to a new database structure, please go to Windows menu:

**Start - All Programs - ODS - Dream Report - DBConverter.**

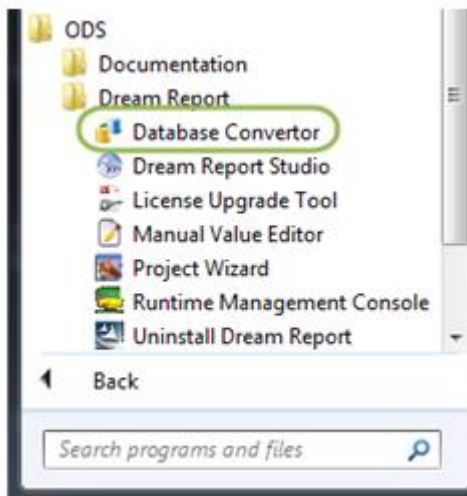

Start Database Converter and select the path where your Dream Report Project is located:

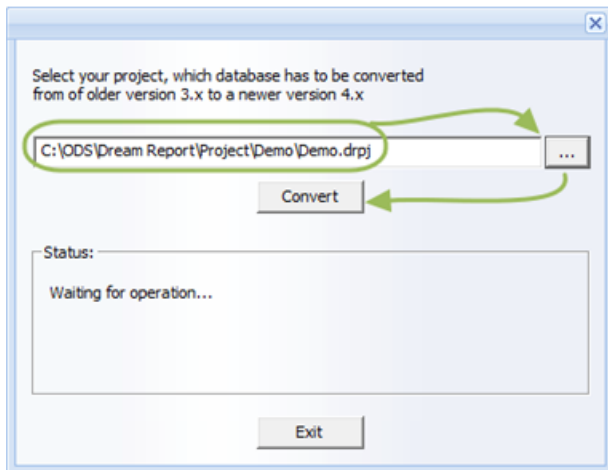

Then press “*Convert*” button in order to begin the conversion process. Please note that the time required to convert the complete database for the upgraded project depends on the amount of the data stored in the previous database.

### DSN settings (SQL Server connection)

If, before upgrading to version 4.6, the Dream Report project DSN was defined in order to connect to SQL databases (SQL Server 2008, SQL Server 2005, SQL Server 2000, 7.0), then the driver in the DSN definition should be changed for the SQL Native Client 10.0 driver.

### Runtime mode settings

Please note that when you upgrade your project to Dream Report version 4.6, you can also configure the runtime engine to run as Windows service or as an application (new option). By default Dream Report runtime engine will start as an application. In order to set runtime engine to run as service, user can go to [Dream Report studio - section “Runtime”](#) and click on the “*Runtime Configuration*” button. The runtime configuration window will be opened:

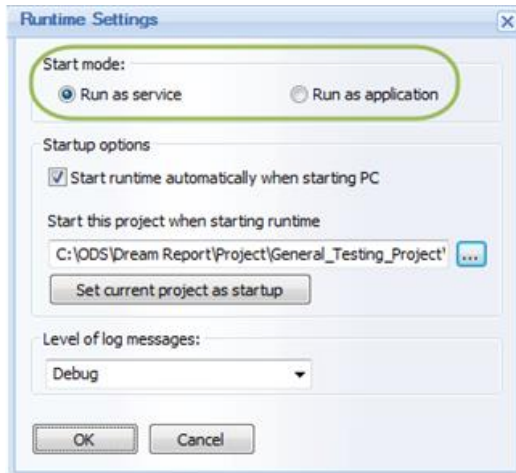

### Default project settings

If your project has to be launched on OS start and as default project when runtime is started, then, specify this also in the “*Startup options*” section of the “**Runtime Settings**” configuration window (see the picture above).

For details on how to configure the runtime engine, please, see [Runtime Configuration](#) section of this manual.



# Licensing and Software Protection

Dream Report has either software or hardware license protection.

## 1. Demo license

When Dream Report is installed without any license, it will automatically run in demonstration mode. Dream Report demo mode sets a limit of 100 tags and enables web portal with 1 web client. Designer Studio will run the unlimited period of time and Runtime manager will operate up to 30 minutes.

The purpose of the Demo mode is to provide user with a possibility to evaluate and try using the product. The use of the product in real projects is forbidden.

## 2. Temporary license

Temporary license is a full-functional license with a limited period of service (available for periods of 15-90 days). This license is available only as a software license key (file "license.dat").

Runtime will run continuously with that type of license, until the license period is expired.

Ocean Data Systems can issue temporary license for specific cases on per-case base. Number of items, web options is specified there according to the customer's demand. Temporary license can be issued on a period up to 90 days. If you have a need for a temporary license, please, contact your local Dream Report distributor or contact us directly at [sales@dreamreport.net](mailto:sales@dreamreport.net)

**3. Permanent license** is available either as a hardware USB protection key or as a software protection file "license.dat" - upon customer's choice.

In case of using a software license, after purchasing a permanent Dream Report license, product activation has to be done in the Dream Report studio, according to the procedure, described below:

- Select menu **Help --> Register in Dream Report studio**;
- Fill correct end-user information in the opened dialog window and press "OK" button. It will create the activation file "activation.dat" in Dream Report license folder (e.g. *C:\ODS\Dream Report\License*);
- Send activation file by email to [activate@dreamreport.net](mailto:activate@dreamreport.net)
- You will receive a permanent Dream Report license shortly, with an unlimited period of use.

If Dream Report permanent license is provided as a hardware HASP USB dongle, then it will not be linked to a specific computer. It will be linked only to that specific USB hardware key, and it will allow running product on any computer, where Dream Report USB license key is plugged in.

*NOTE: HASP protection, if running under Windows Server OS types, will work only in console terminal mode if set to run as an application. Otherwise, please set Runtime to run as a service.*

For all additional commercial information regarding different license models, license types, prices and other commercial information, please, ask your distributor or contact us at [sales@dreamreport.net](mailto:sales@dreamreport.net).

**3.1. Redundant license** is a special license, which can be used only with Dream Report project, which is defined as a backup (redundant) and works in redundant mode for the main project. Such a license has a special discount. Please, ask Dream Report reseller for more details.

## 4. License linked to the custom external license.

Dream Report license has an option to be linked to the custom external license. Actual version of Dream Report license can be linked to a specific license of iFix license number or to Wizcon license number or to PcVue license. In order to issue a license, linked to another external license, please, ask your Dream Report distributor for that option and provide the ID number of your SCADA license key to be linked to.



## 5. Special licenses

**5.1. System Integrator Pack.** This is a full-functional license for Dream Report demonstration and development. This license is intended for Dream Report distributors and systems integrators for internal use. Standard system integrator pack includes:

- 10,000 tags;
- 5 web clients;
- Validity - 1 year.

System integrator pack license can be supplied on a USB key or as a software license file.

**NOTE:** *System integrator pack license cannot be used in real projects, but can be used only for project development and demonstration purposes.*

**5.2. MES license option.** This special license option enables unlimited calls of SQL queries, SQL stored procedures and other database requests as well as adds 5 web client to the license configuration. This license is designed for use in MES reporting applications, but can be convenient and cost-effective option for other applications, where intensive database interaction is required.

**5.3. Life Sciences license option.** This license option enables functionality, which is required for reporting applications in life sciences industry. This option enables such options, like:

- Setpoint analysis mechanism;
- Pulse analysis;
- F0 calculation (for sterilization validation);
- Electronic signature;
- DBatch (real-time electronic batch recording).

**NOTE:** *Permanent software license will operate only on a PC, where activation file has been generated. Software license is linked to the specific PC hardware profile.*

## 6. Invalid License

If during Dream Report installation the Invalid license message box appears, please, consider the following reasons for this:

1. The software license file ("license.dat") has been installed on the wrong PC, i.e., in case when the activation file ("activation.dat") has been generated for one PC, and the license file is used on another PC;
2. The software license file ("license.dat") or the hardware USB license key is used with a newer version of the product;
3. The USB license has an error while reading the USB plug. In this case the driver has to be reinstalled and a user should contact the Dream Report technical support team ([support@dreamreport.net](mailto:support@dreamreport.net)).

### 6.1. USB License Upgrade: Invalid License

**NOTE:** *Please, note that when the hardware (USB key) license is upgraded, the problem with its upgrade may occur due to the incorrect functioning of HASP driver currently installed on the computer where user tries to run the upgrade of Dream Report USB plug.*

If this is the case, please do the following:

1. Unplug the key;
2. Uninstall the existing HASP driver as follows:
  - a. Run command line;
  - b. Set path to `<path to >\ODS\Dream Report\Utilities;`
  - c. Run the following command `"<path to executable>\haspdinst.exe" -kp -r;`
3. Install the new version of HASP driver (it is located in \Utilities folder of Dream Report) as follows:
  - a. Run command line;
  - b. Set path to `<path to >\ODS\Dream Report\Utilities;`
  - c. Run the following command `"<path to executable>\haspdinst.exe" -kp -i;`
4. Plug the key again;
5. Repeat the LUT procedure and upgrade the USB key.





# Project Wizard

## Project Wizard - General

**Project Wizard** enables users to create a turn-key simple project in an easy way, and then continue its development (if needed) in the Dream Report Designer studio in a normal working mode.

This functionality is implemented as a standalone **exe.** file utility.

It can be launched:

- From the Windows start menu.
- When opening DR Designer Studio.
- By double-clicking on the **ProjectWizard exe.** file in the Dream Report Project/System folder.

A user can launch Project Wizard from the Dream Report Studio. When the DR studio is started, please, select the right button menu "**Run Project Wizard**" (as displayed on a picture below).

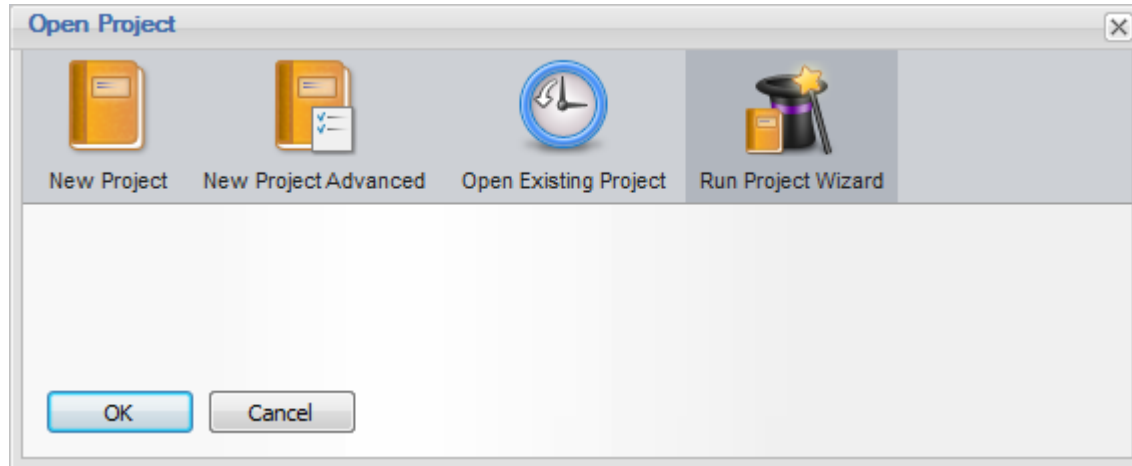

Then, Dream Report studio will be closed and **Project Wizard** will be started.

**NOTE:** Several instances of Project Wizard can be started at once.

At each step of Project Wizard, if a user clicks on the "**Close**" button, it will be closed without any operations performed. **No project will be created.**

If a user clicks on the "**Back**" button at any step, Project Wizard will go one step back, and user will be able to either re-configure its functionality/settings or to check the configuration.

If a user clicks on the "**Next**" button, Project Wizard will bring him/her to the next step of project creation.

**NOTE:** If Project Wizard is launched when opening the Dream Report Designer Studio, then, when it will close, after project creation is complete, the Dream Report Designer Studio will start automatically with the project just created.

If Project Wizard is launched either from the Windows start menu or by double-clicking on the **ProjectWizard exe.** file in the Dream Report project/system folder, then, when Project Wizard will close after project creation, nothing will happen. This project and all its configuration files will be saved in the Dream Report Project folder in a special folder that will have the name, defined in the **Project Name** section of Project Wizard. Then, if you want to continue project development in the Dream Report Designer Studio in a normal working mode, you will only have to double-click on the **<project name>.drpj** file to start the project.



When **Project Wizard** is started, the first welcome window will be opened:

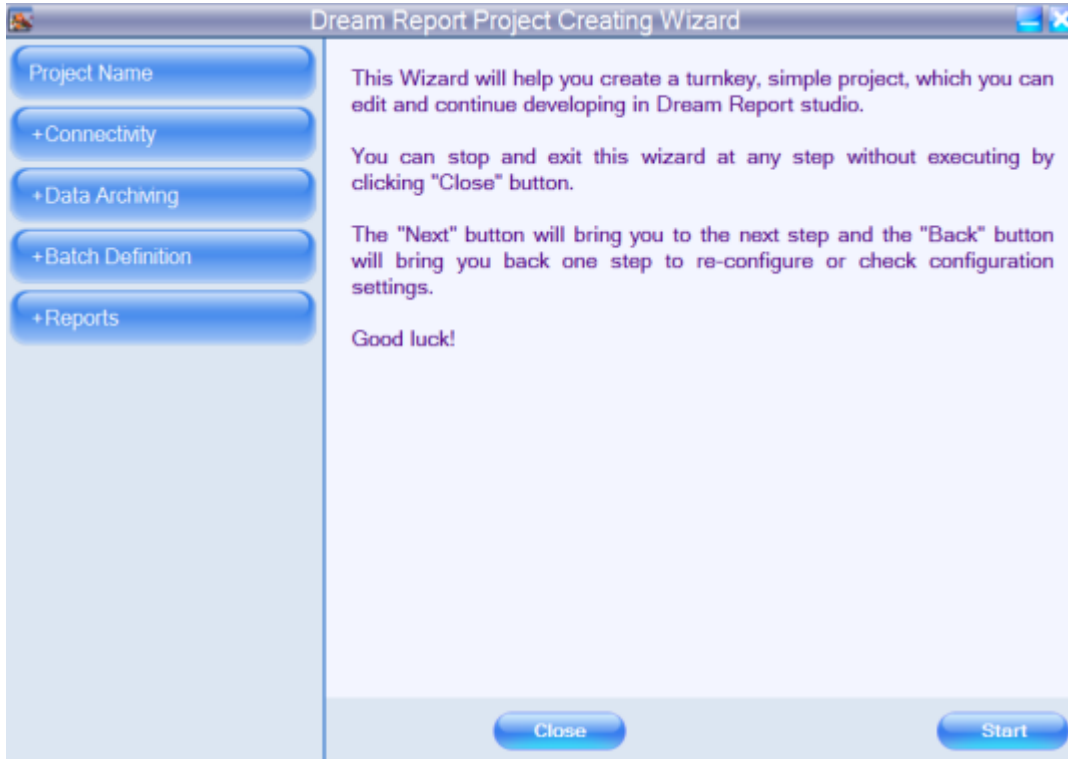

In this section you will find basic instructions on how to use Project Wizard. You can either choose to start creating a new project, or exit.

Click **Start**, and go to the **Project Name** section.

Click **Close** to exit Project Wizard without any operations performed.

## Project Wizard Navigation

As you go through different steps of project creation, each time one of the steps is finished, the corresponding button in the left-hand part of the Project Wizard window will get a green tick:



If you are in the process of performing the operation at some step of the project creation, then, the corresponding button in the left-hand part of the Project Wizard window will be marked this way:

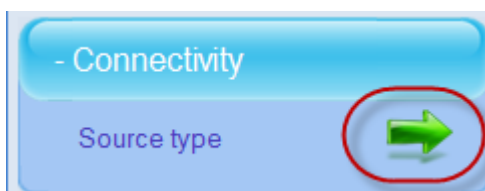



So, the buttons, that correspond to each step of project creation and are located in the Project Wizard menu (left-hand part of the Project Wizard window), will be either enabled (in two ways shown above) or disabled, depending on whether the operation at the corresponding step has already been performed or not. This way a user will always be able to check how the process of project creation in the Project Wizard is going on - what has been done, what is missing, and what should be done (please, see an example on the picture below).

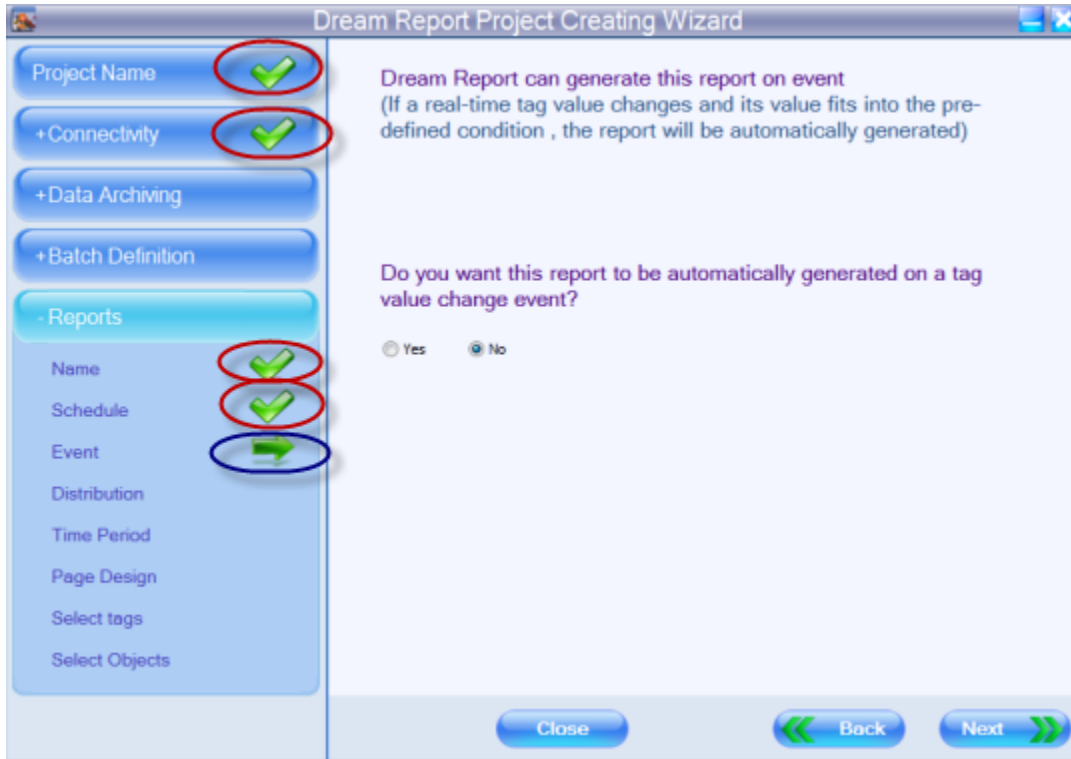

Also, if you will need to come back to re-configure or check project configuration at any step of project creation, you will be able to do it just by clicking on the corresponding button in the left-hand part of the Project Wizard window (menu). Project Wizard will open the step that you need.



## Project Wizard - Project Name

By clicking the "**Start**" button in the **Project Wizard Welcome** window, a user will start creating a new project.

First, the **Project Name** window will be opened:

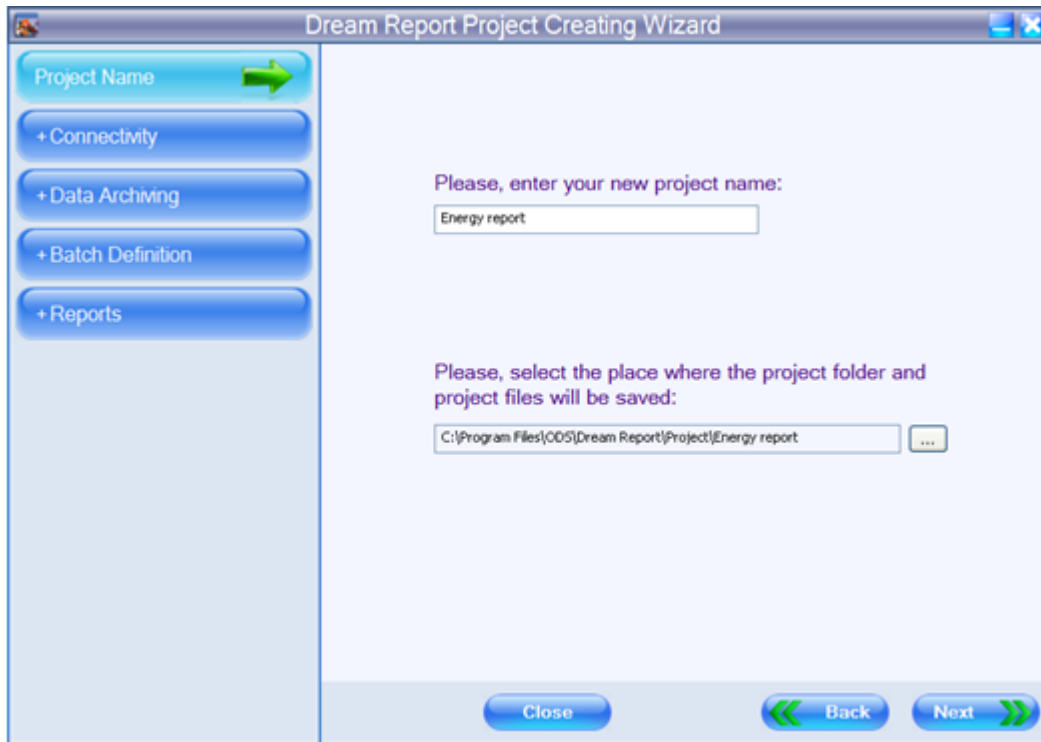

In this section user will define the project name and select the PC folder, where the project configuration files will be saved. The folder will have the project name you have entered.

Click **Next** to go to the next step of project creation.

Click **Back** to go one step back to re-configure or check project configuration.

Click **Close** to exit Project Wizard without any operation performed.

**NOTE:** Please, always define the name of the project which is being created by the Project Wizard.

If you don't define the name of your project, then, when you will come to the final step of project creation, and will click button **Create** to close Project Wizard and to load the project into the Dream Report Studio, the message box "**Project Name is Empty**" will pop up, and you will not be able to perform the operation you want.



## Project Wizard - Connectivity

This step of project creation enables users to connect to any data source and acquire live data/alarms, or access its history.

To configure an appropriate communication driver, click on the *Source type* of the Project Wizard menu. The **Source type selection** window will be opened:

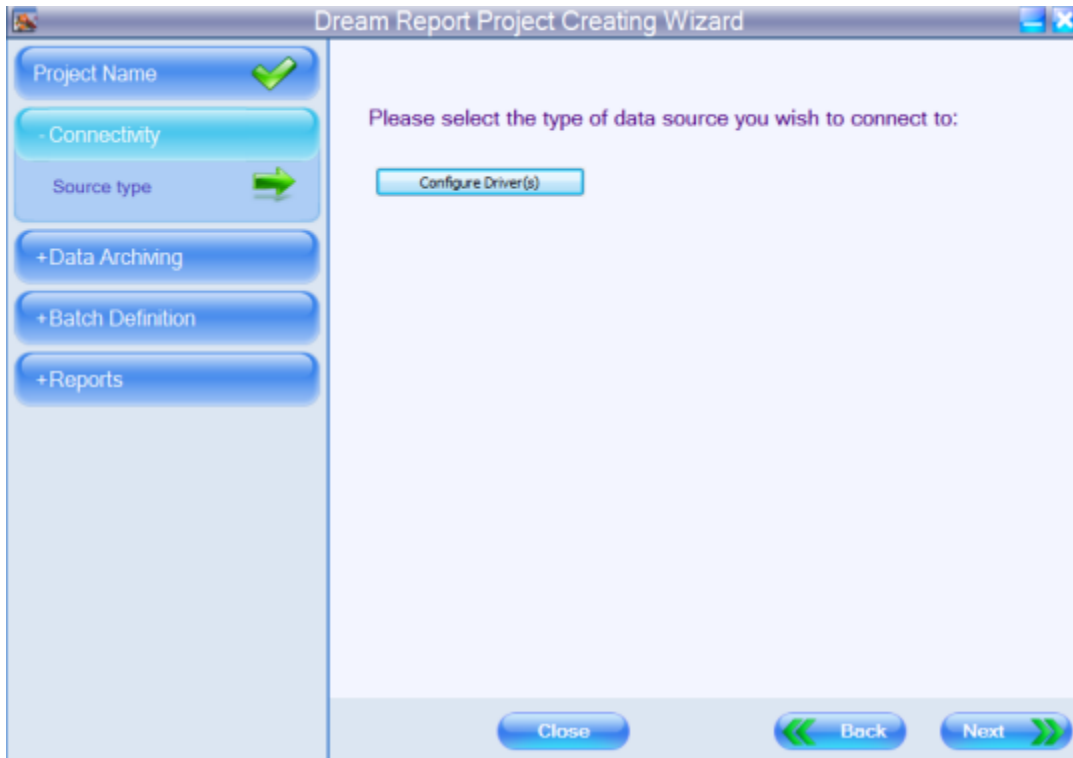

At this step a user will have to select and configure an appropriate communication driver to connect to and to get data for the project report.

Click the **Configure Driver(s)** button and the **Communication Configuration Wizard** dialog box will be opened.

For details on how to configure different types of drivers for the project, please, see related parts of the **Communication Driver Definition** section of this manual.

Click **Next** to go to the next step of project creation.

Click **Back** to go one step back to re-configure or check project configuration.

Click **Close** to exit Project Wizard without any operation performed.

The next step will enable users to select whether to log real-time item/tag values into the Dream Report History or not (please, see pic. below):

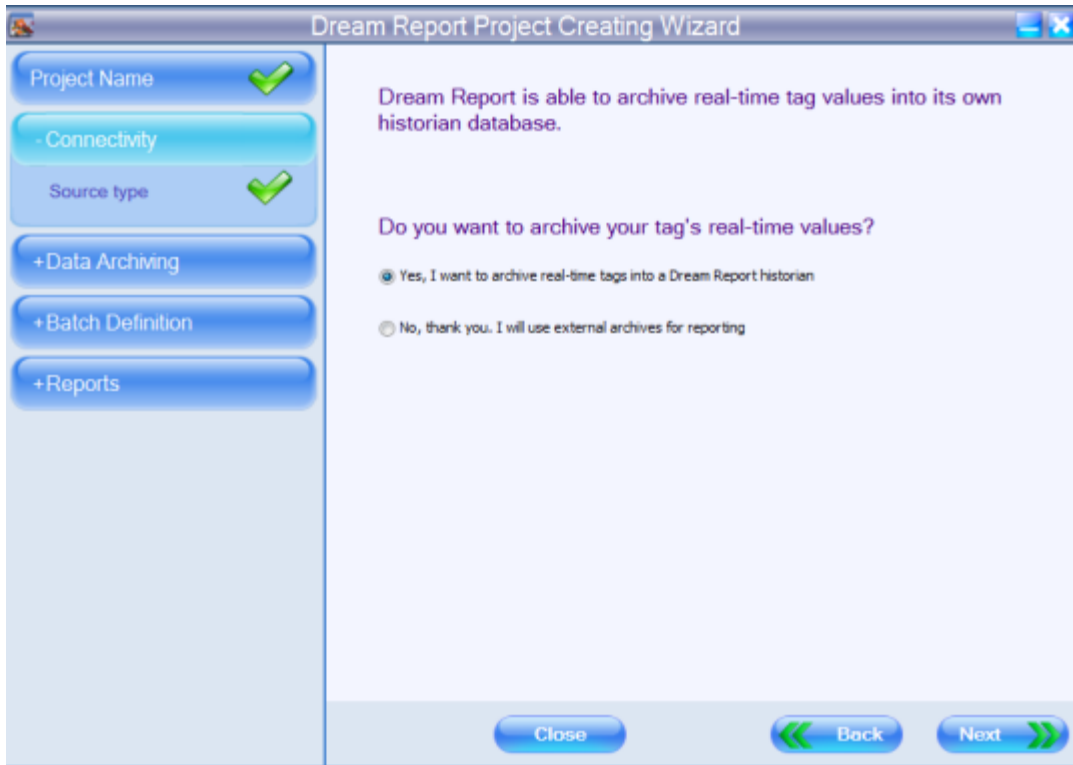

If “*No, thank you. I will use external archives for reporting*” option is selected, the button “*Next*” will skip the “**Data archiving**” section, and a user will go directly to the Project Wizard **Batch definition** section.

If “*Yes, I want to archive real-time tags into a Dream Report historian*” option is selected, then, a user will go to the Project Wizard **Data archiving** section.

**NOTE:** If a user has defined at least one real-time driver, he can start configuring data logging into the Dream Report historian in the Project Wizard **Data archiving** section.

But, if a user has defined only external history access drivers, he will not be able to configure data logging into the Dream Report historian, and will have to go directly to the Project Wizard **Batch definition** section.

Click **Next** to go to the next step of project creation.

Click **Back** to go one step back to re-configure or check project configuration.

Click **Close** to exit Project Wizard without any operation performed.



## Project Wizard - Data Archiving

**Data archiving** enables data logging into the Dream Report history database.

If a user selects "**Yes, I want to archive real-time tags into a Dream Report historian**" option in the dialog window below, and clicks **Next**, he will go directly to the **Data archiving** section, where he can define conditions for data logging into the Dream Report history database:

Dream Report Project Creating Wizard

Project Name ✓

- Connectivity

Source type ✓

+ Data Archiving

+ Batch Definition

+ Reports

Dream Report is able to archive real-time tag values into its own historian database.

Do you want to archive your tag's real-time values?

Yes, I want to archive real-time tags into a Dream Report historian

No, thank you. I will use external archives for reporting

Close Back Next



## Tag Selection

First, the **Tag selection** window will be opened:

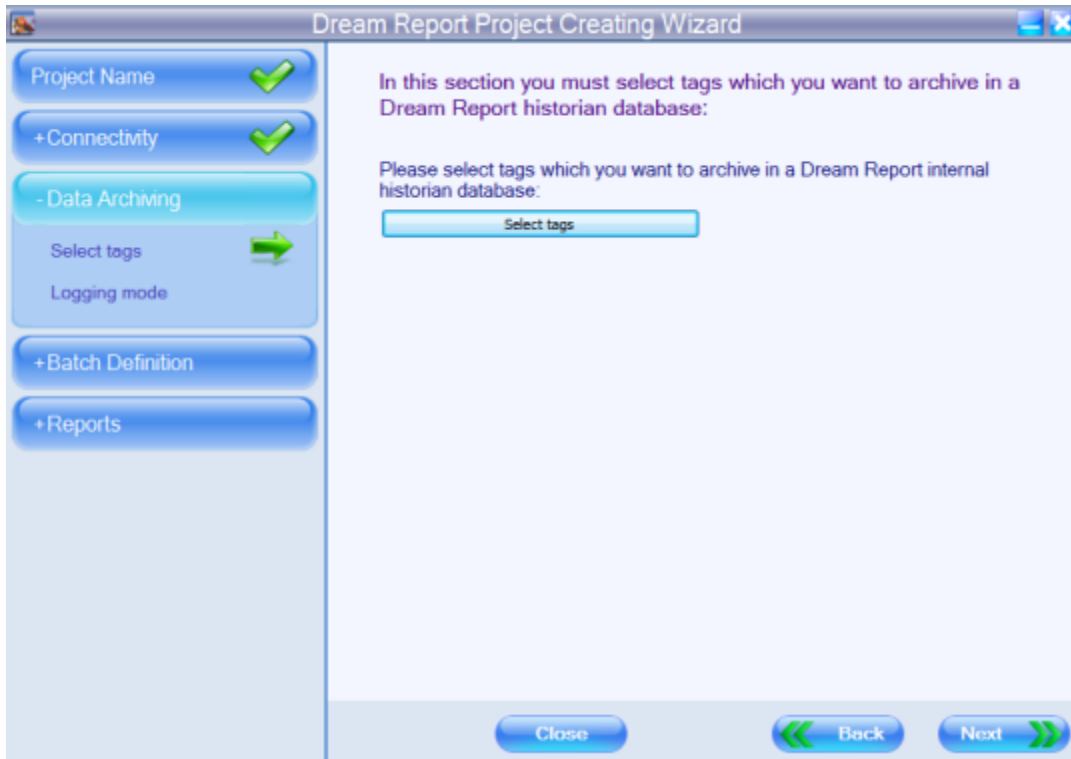

The **Select tags** button will open a new dialog box (**Select Data Items**), containing the complete list of all data items from the selected drivers. User will be able to add or remove items from the entire item/tag group.

The left-list box of that window will contain a complete list of available items and the right-list box will contain a list of items selected for the entire group.

**Items Filter** enables users to easily find an item in a list. As soon as a prefix is entered, the list will be automatically filtered by the prefix.

Use an asterisk (\*) as a wildcard character.

**NOTE:** You can't proceed to the next step (**Logging mode**) until you haven't selected any tags to be logged.

Click **Next** to go to the next step of project creation.

Click **Back** to go one step back to re-configure or check project configuration.

Click **Close** to exit Project Wizard without any operation performed.





## Logging Mode

The **Logging mode** step of project creation enables users to define how often values of all the selected data items/tags will be logged in the database during the active logging period (please, see pic. below):

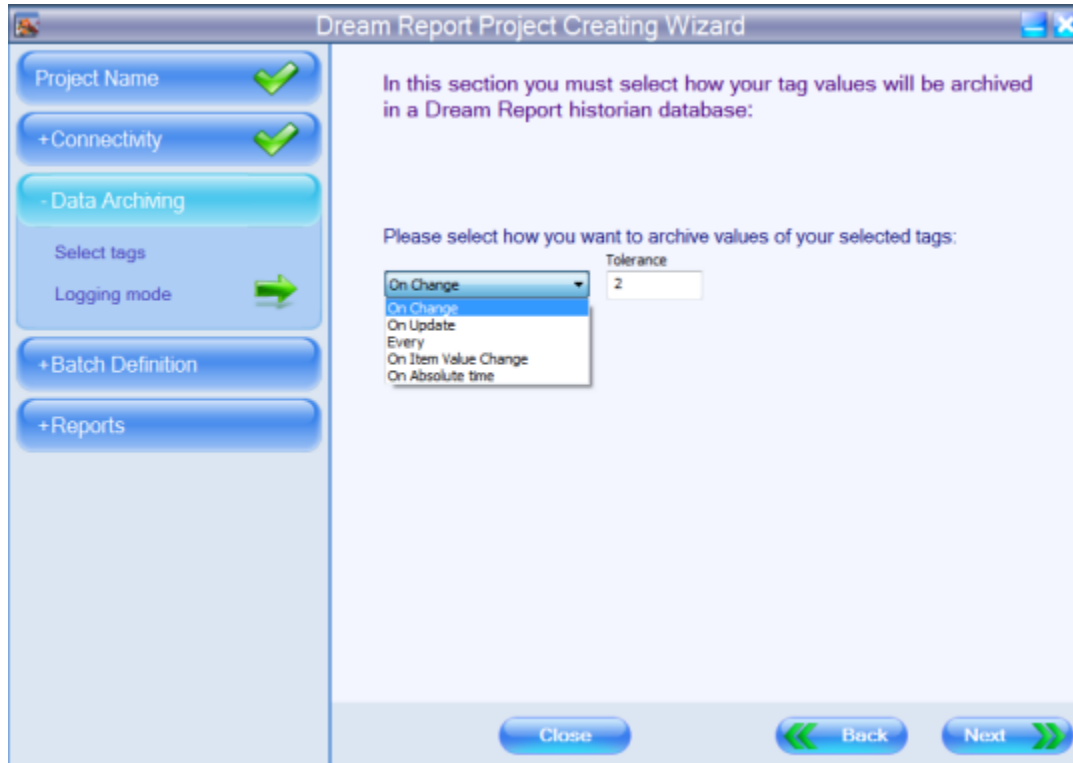

The **logging mode** combo box will have the following options: **On Change**, **On Update**, **Every**, **On Item Value Change** and **On Absolute time**.

The **On Change** option will enable logging only on a value update if the value is different from the previous one.

When this logging mode is switched on, a user can define **tolerance** in the corresponding "**Tolerance**" edit box. The value entered in this edit box will define how many units of value should be changed in order to log a new value to the database and which value change should be ignored.

The **On Update** option will enable logging when any value update is received from the data source, whether or not the new value is different from the previous one.

The **Every** option will record the item value at the defined rate whether or not the value has changed. The rate is defined in seconds.

The **On Item Value Change** option will record item values each time the value of a control item changes. It works as follows:

1. You can define an item from the same data source, that this group will log data from (as displayed on the picture below):

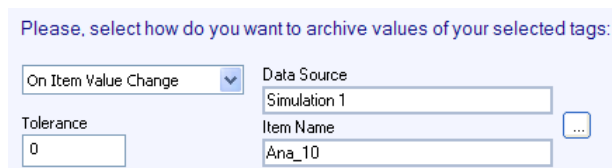



## Ocean Data Systems

2. Every time this value changes, Dream Report will log values of all selected tags.

Please, note that only items from real-time data sources can be used. If you select a data item from the external history server, this option won't work.

The **On Absolute Time** option will record item values at an exact time specified in the list (see example below):

Please, select how do you want to archive values of your selected tags:

On Absolute time	Set Time	12:00:00
	12:00:00	

Add  
Modify  
Delete

You can add as many time definitions as you need, and, when the PC clock reaches the time in the list, values for all of the selected tags will be logged to the database.

Click **Next** to go to the next step of project creation.

Click **Back** to go one step back to re-configure or check project configuration.

Click **Close** to exit Project Wizard without any operation performed.

### Tag Group Name

When the tag group configuration is finished, a user will have to confirm the creation of a new tag logging group in the following window:

**Group name** should be a unique logical name, which will give a tip to a user about the data content.



## Ocean Data Systems

Click **Next** to go to the next step of project creation.

Click **Back** to go one step back to re-configure or check project configuration.

Click **Close** to exit Project Wizard without any operation performed.



## Project Wizard - Batch Definition

**Batch Definition** enables users to define a rule to dynamically calculate time periods for report generation.

If a report is for a batch process (process loop), where the exact time period and duration is not known in advance, use this batch mechanism of the Dream Report Project Wizard.

Each batch process is marked by a unique ID, and this ID will be used later to recognize and distinguish batches (process loops). So, in order to track batches, define the source for batch IDs.

The **Batch definition** window (please, see pic. below) has 2 options.



If **No, I will have only time-based reports** option is selected, click **Next**, and go to the Project Wizard **Reports** section.

If **Yes, I need batch information in this project** option is selected, click **Next**, and go to the next step, where you can start creating batch definitions for the project reports.



The following window will be opened:

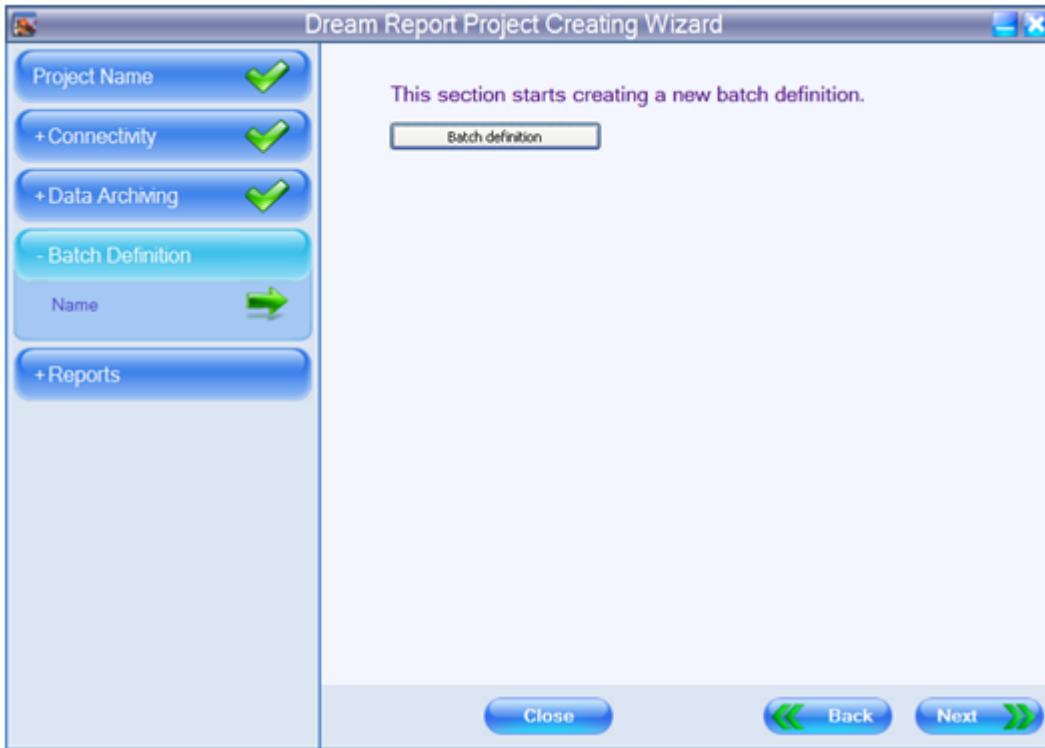

The **Batch definition** button will open the **Batch definition** dialog window:

To add a new batch definition, click on the **New** button and a new batch definition will be added to the list.

In the **Name** edit box you can edit the name of the batch field (it will update the name in the batch list automatically).

The **Description** edit box can contain a brief explanation of the batch field.

Each batch process is marked by a unique ID, and this ID will be used later to recognize and distinguish batches (process loops). So, in order to track batches, define the source for batch IDs.

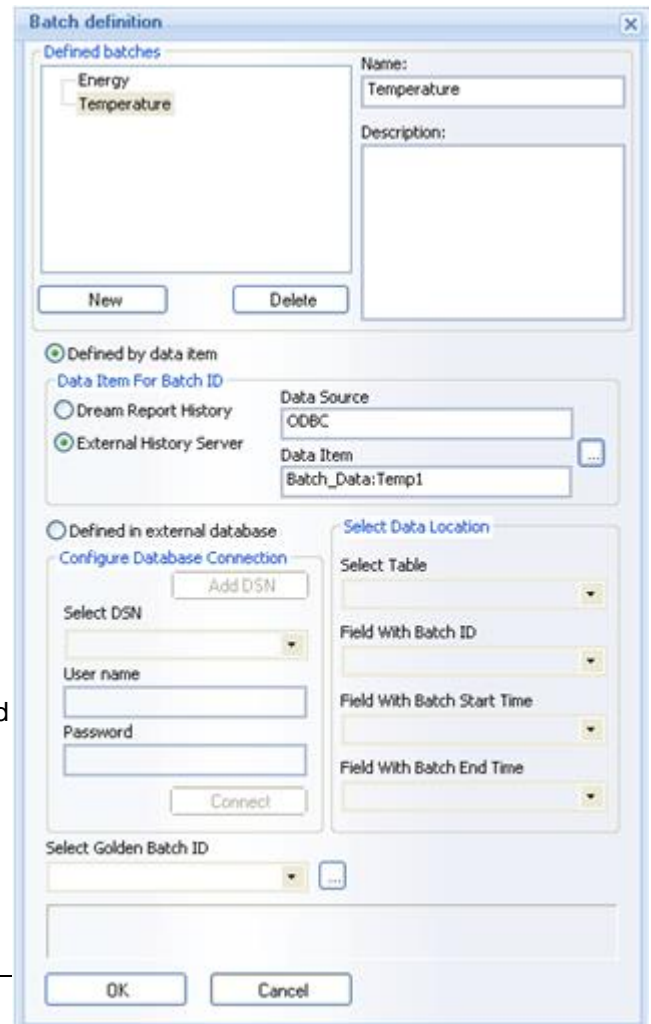



## Ocean Data Systems

Dream Report batch definitions allow tracking batch IDs by a tag from any real-time data source by logging batch information into internal Dream Report history or retrieving them from an external database in different formats.

Batch in Dream Report can be defined in 2 ways according to the way batch information is stored.

1. If the table, where batch information is stored, includes columns corresponding to **Batch ID**, **Batch Start Time** and **Batch End Time**, then select the "**Defined in external database**" option.

Use Select DSN to select the database, where batch information is stored. If the DSN doesn't exist, create it and then continue the batch definition. If the DSN is protected with a login and password, then enter the login and password in the User name and Password text boxes. Click on the "**Connect**" button and Batch Manager will connect to your database via the selected DSN.

After connecting to a database, in the section "**Select Data Location**" specify the location of all data components needed to process the batch information:

- In the **Select Table** combo box select a table, which contains batch information (batch ID, start time and end time)
- In the **Field with Batch ID** combo box select a table column, which contains batch IDs
- In the **Field with Batch Start Time** and **Field with Batch End Time** combo boxes select the table columns, which contain the batch start time and end time.

2. If the table, where batch information is stored, doesn't include **Batch Start Time** and **Batch End Time** columns, select the "**Defined by data item**" option. This option will require only Batch ID column where Batch ID will be recorded periodically.

In the "**Data Item for Batch ID**" section select data source and data item containing batch ID. Then click **OK** and batch definition will be completed.

**NOTE:** Batch process must be continuous and there will be no time interval between consequent batches. **Batch Start Time** will correspond to the Timestamp of the first value of the defined batch (as explained in the formula below):

**Batch\_Start\_Time(Batch\_N)=Timestamp\_of\_First\_Value(Batch\_N)** (where Batch\_N is ID of the defined batch).

"**Batch End Time**" will correspond to the timestamp of the first value of the next batch with the difference of 1 second (as explained in the formula below):

**Batch\_End\_Time(Batch\_N)=(Timestamp\_of\_First\_Value(Batch\_N+1))-1s** (where Batch\_N is ID of the defined batch and Batch\_N+1 is ID of the next batch).

**Batch Start Time** and **Batch End Time** will have time resolution of 1 second (msec will be ignored).

Once batch definition is completed, click **OK**, and continue designing your project. During report generation Dream Report will automatically go to the database, analyze the values of a tag defined for the batch, recognize the start and end times of the batch and will then apply those times to the object.

If you add a phase for a batch, it will operate the same way as batch. As mentioned before, a phase is used in Dream Report to make the project configuration easier to understand.

### Golden Batch

In the **Select Golden Batch ID** combo box (on the bottom part of the **Batch Definition** dialog window) user can enter the ID of the golden batch for the data comparison. To browse for specific batch ID from the database, user can click on the "..."(browse) button,



The screenshot shows a dialog box titled "Batch IDs in time range" with a close button (X) in the top right corner. The dialog contains the following elements:

- A dropdown menu at the top with "Batch IDs in time range" selected. Below it, a list shows "All batch IDs" (highlighted in blue) and "Batch IDs in time range".
- A dropdown menu labeled "Absolute or relative period definition".
- Two columns for time selection:
  - Start of report period:** A dropdown menu set to "Relative Date/Time", a numeric spinner set to "1" with "Days" to its right, and a time spinner set to "00:00:00" with "hh:mm:ss back" to its right.
  - End of report period:** A dropdown menu set to "Relative Date/Time", a numeric spinner set to "0" with "Days" to its right, and a time spinner set to "00:00:00" with "hh:mm:ss back" to its right.
- Two buttons at the bottom: "OK" and "Cancel".

select the time period to search all available batch IDs from, (*Batch IDs in time range*) or select *All batch IDs*. Then the combo box **Select Golden Batch ID** will be automatically populated with all available batch IDs during the specified period and user will be able to select any of them to be the *Golden Batch ID*.

As soon as the *Golden Batch ID* is selected, this batch ID will be taken for calculations in any statistical object throughout the reporting project, where time definition is configured for the *Golden batch*.

Click **Next** to go to the next step of project creation.

Click **Back** to go one step back to re-configure or check project configuration.

Click **Close** to exit Project Wizard without any operation performed.



## Project Wizard - Report Configuration

The **Report Configuration** section of the Project Wizard enables users to configure the output properties for a project report.

### Name

First, select a name for your new report in the **Reports Name** window:

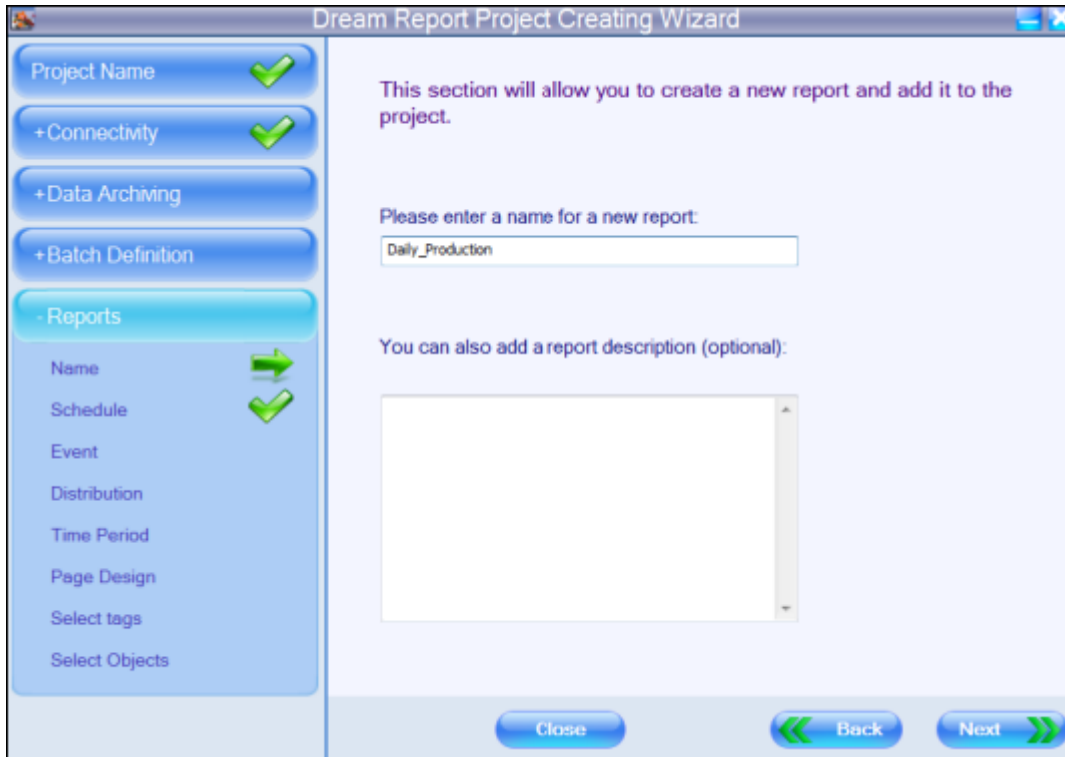

The **Report Name** can be any unique logical name. Only alphanumeric characters and spaces can be used, otherwise unexpected problems can be expected. The maximum length of a report name is 64 characters.

The **Description of Report** text box is optional, and can include a short description for the report. The description can be up to 256 characters.

Click **Next** to go to the next step of project creation.

Click **Back** to go one step back to re-configure or check project configuration.

Click **Close** to exit Project Wizard without any operation performed.





## Schedule

The **Reports Schedule** window allows users to define an automatic report generation schedule:

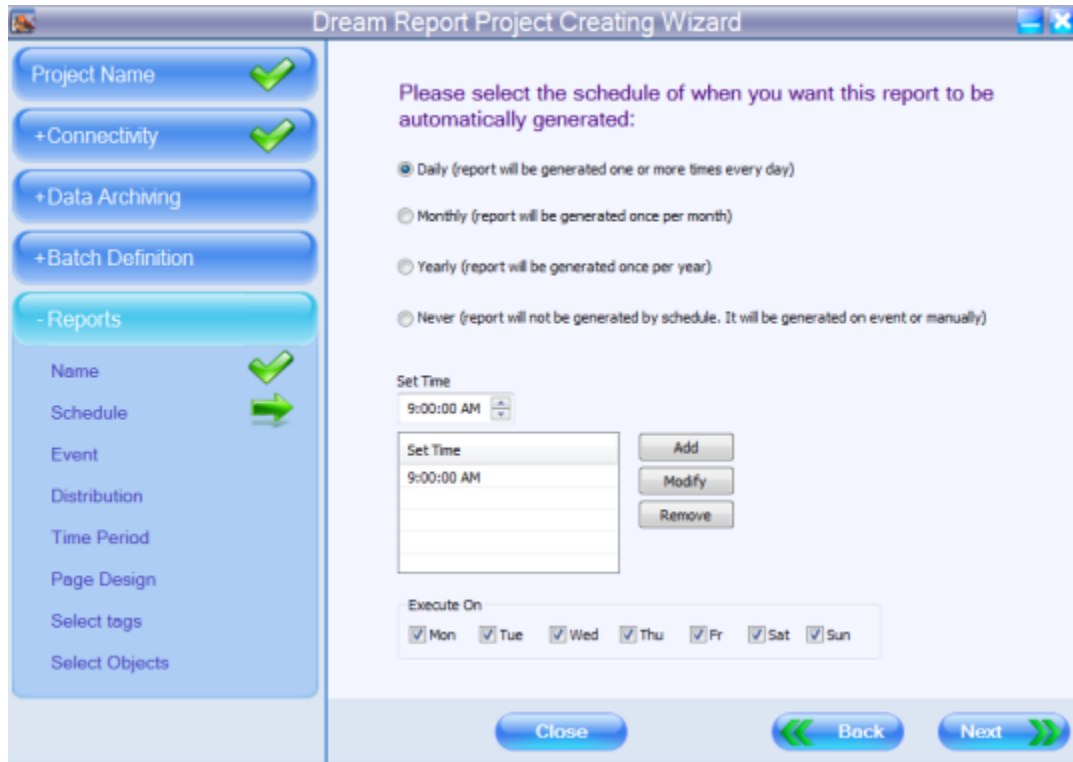

The **Daily Report** option enables a user to define a very flexible schedule of report generation one or more times during one specific day or several days of the week (please, see the pic. above).

For this, create a list of schedule records, defining when each report will be generated. The schedule record includes the time (**hh:mm:ss**) and the days of the week. Each scheduler record may contain its own set of days of the week. The report will be generated every day at each defined time, which is enabled in the schedule.

To add a record, enter the desired time in the **Set Time** edit box in the format **hh:mm:ss**, select the desired days of the week, and click the **Add** button. The new scheduler record will be added to the scheduler list.

To delete a scheduler record, select a record to be deleted, and click the **Remove** button. The selected record will be deleted.

To modify an existing scheduler record, select the record to be modified - the day of the week. The **Set Time** edit box will display the current definition of that scheduler record. Enter the new time in the **Set Time** edit box and selected desired days of the week in the **Execute On** (group of days of the week) check boxes. After scheduler record settings editing is finished, click the **Modify** button. The selected record will be modified with the new settings.

The **Monthly** or **Yearly** report options enable users to define a specific time and day of the month or day of the year, when the selected report will be automatically generated. Please, select which type of schedule you would like to use: **Monthly** or **Yearly**.

If **Monthly** option is selected, then the **Select Day** combo box will be filled with the possible days of the month (1-31). Select which date of every month the selected report will be automatically generated. To the right of date selection, specify the time at which the report will be generated:



## Ocean Data Systems

Select Day	Select Time
<input type="text" value="7"/>	<input type="text" value="09:00:00"/>

If **Yearly** option is selected, then the **Select Day** combo box will display a calendar to select a day of the year for the given report to be generated. Though the calendar will contain the current year, report generation will not be limited to the selected year. Every year the report will be generated at your selected date. To the right of date selection, specify a time at which the report will be generated.

Select Day	Select Time
<input type="text" value="6/21/2011"/>	<input type="text" value="10:00:00"/>

If you don't want to generate the report automatically by schedule, select **Never** option.

Click **Next** to go to the next step of project creation.

Click **Back** to go one step back to re-configure or check project configuration.

Click **Close** to exit Project Wizard without any operation performed.

### Event

The next step of project creation enables or disables event-based report generation.

First, the **Reports Event** window will be opened:

If **No** radio button is enabled, click **Next**, and you will go directly to the next step of report configuration - **Reports Distribution** (please, see the description in the **Distribution** section below) .



## Ocean Data Systems

If **Yes** radio button is enabled, please, select data source, data item, event condition, and enter a condition value in the combo box that will appear.

The "... (browse) button will open the **Select Data Item** combo box. It will be filled with a list of all available sources. After selecting a data source, the combo box **Select Data Item** will be filled with a list of all available items from the selected data source.

**Items Filter** enables users to easily find an item in a list. As soon as a prefix is entered, the list will be automatically filtered by the prefix.

Use an asterisk (\*) as a wildcard character.

The **Condition value** can be any number in the range from -65535.00 to 65535.00.

The symbol "." must be used as the decimal separator.

Click **Next** to go to the next step of project creation.

Click **Back** to go one step back to re-configure or check project configuration.

Click **Close** to exit Project Wizard without any operation performed.

## Distribution

The **Reports Distribution** section defines working with report files (please, see pic. below):



In this window users will find information about the possible report formats, the rules of how file names for an output file will be generated, and define how to configure report output settings, i.e. what format the report will be generated in.



If a user checks ***I want to print my report*** check box, the **Configure** button will become enabled. Click on it, and the **Printer Configuration** window will be opened:

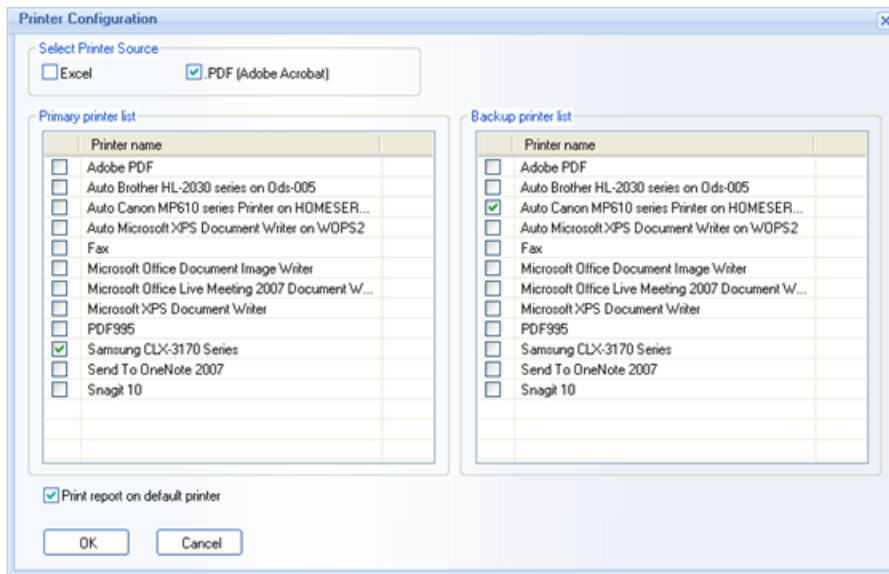

Select one or several printers, where each report will be printed each time it is generated. Or select multiple printers by using **Ctrl + select** combination.

For details, please, go to the [Printer Selection](#) section.

Click **Next** to go to the next step of project creation.

Click **Back** to go one step back to re-configure or check project configuration.

Click **Close** to exit Project Wizard without any operation performed.

### Time Period

This step enables to define default time period for reporting statistical objects.

The **Reports Time Period** window has a combo box with 3 time period selection options: “**Fixed calendar time**”, “**Relative or absolute date/time**” and “**Batch based period**”:



- If you select **Fixed calendar time** from the **Select time period option** combo box, you will have another combo box from which to select a fixed period as seen below:

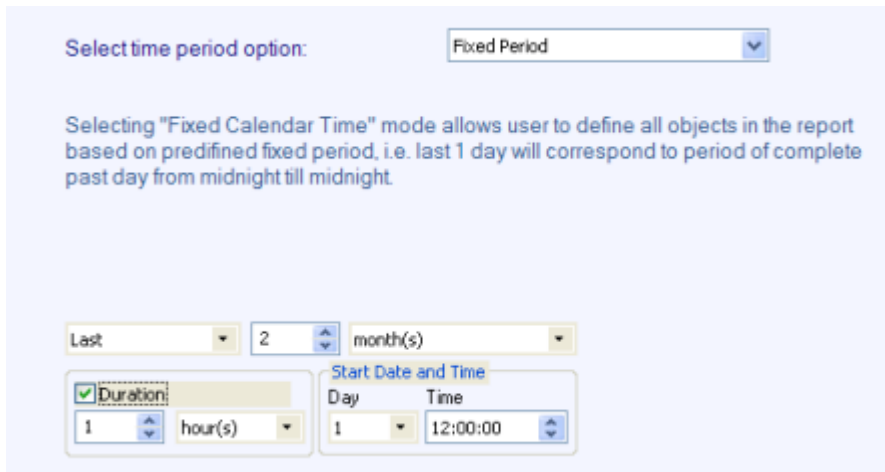

*Last* means "previous complete", i.e. if the current time is 14:32, then the Last hour will be 13:00 - 14:00

*Current*, means the incomplete, "in progress" period. If the current time is 14:32, then the Current hour will be 14:00 - 14:32.

Combining a mode (*Last/Current*), time unit and number of units you can compile any time period (i.e. Last 3 years, Current 6 months etc.).



## Ocean Data Systems

If the check box **Duration** is checked, then, specify how long the duration of the fixed period will be, and it will modify appropriately the end time.

**Example:** If today is *April 29* and you specify the fixed period "*Last 2 months*" and Duration *1 month*, then: *Start period* will be defined by "*Last 2 months*", i.e. *Feb.* and *March*, i.e. start of the period will be *February 1*; *End of the period* will be defined by Duration, i.e. *1 month*, i.e. the end date will be: *February 1 + 1 month = March 1*.

The section **Start Date and Time** may define when the start and end date and time for the specified fixed period are.

For example, the *Last 1 day* period means the period from midnight last day until midnight today. Using start date, you can count 1 day not from midnight to midnight, but from and to the time, specified in the Start Date/Time field. E.g. if the start time is 07:00:00, then Last 1 day period will be accounted not from midnight last day until midnight today, but from 07:00:00 last day until 07:00:00 today.

If a user specifies last or current day/week, then only *Start time* is available. If a user specifies period *Last* or *Current month*, or *quarter* or *year*, then both *Start Date* and *Time* will be available.

- If you select **Absolute or relative period definition** in the **Select time period option** combo box, then you must specify the start and end time for the period:

Select time period option: **Absolute or relative period definition**

Selecting "Relative or Absolute date/time" mode allows user to define all objects in the report based on relative or absolute time(start and end time separately)

Start of report period: Absolute Date/Time, 7/15/2011 Days, 11:00:00 hh:mm:ss back

End of report period: Absolute Date/Time, 8/16/2011 Days, 11:00:00 hh:mm:ss back

The Start and End of time of the period can be defined using four options:

- [Absolute date/time](#)
- [Relative date/time](#)
- [Absolute date/Relative time](#)
- [Relative date/Absolute time](#)

If the **absolute** option is selected, then, specify the calendar date and time.

If the **relative** option is selected, then, specify the time offset, i.e. a number of days or hours, minutes and seconds back from the time of the report definition. If the time period is defined in the relative mode, then the time will be defined as follows: during report generation, the current time will be captured as the end time and the time offset will be deducted from it as the start time. E.g. If the time is defined in relative mode as 00:10:00 (hh:mm:ss), then it will mean 10 minutes before report generation.

The **Start** and **End of period** may have separate modes (any of four possible).

- If you select the **Batch Based** option, then the following period definition control will appear:



Select time period option:

Selecting "Batch based period" allows user to define all objects in the report corresponding to batch-based time period

Batch

Mode                      count  
                     

Duration  
batches

Here you can select a batch definition, which will be used to calculate the period for your object. The **Batch** combo box will contain a list of previously defined batch definitions. If you need to edit that list, click on the browse button ("...") and the **Batch definition** window will be opened, where you can edit the existing batch definitions. Batch definition is described in detail in the Batch Definition section.

Then, after selecting a batch definition, select the mode (*Last/Current*) and the batch count.

**Last batch** means the most recently completed batch ID, i.e. at the time of the report generation it has valid start time and end time.

**Current batch** means batch ID, which is being processed at present, i.e. at the time of the report generation it has a valid start time and no end time yet.

**Absolute batch ID** will enable user to enter any specific absolute batch ID, and their start and end time will be considered as the time period for that statistical object.

**Golden batch** will use start and end time of the golden batch ID, defined in the selected batch definition (in the batch configuration dialog window).

The **Absolute batch ID** and the **Golden batch** options are similar. The difference between them is that the **Golden batch** is defined once per reporting project. Then, since a user has defined the **Golden batch ID** once (in the batch definition window), then it will be used for all the reporting objects, throughout the entire project. If a user changes it, it will be automatically applied to all reporting objects as well. The **Absolute batch ID** is applied to one specific reporting object and will not affect any other objects. If a user wants to modify the **Absolute batch ID**, he will have to go through every reporting object, where the absolute batch ID is used and to change each of them.

**Example:** Last 2 batches will mean 2 last batches, which have been completed at the time of generation, but not including the one which is in-process now. The current 2 batches will mean the last 2 batches, including the one which is in process now.

Click **Next** to go to the next step of project creation.

Click **Back** to go one step back to re-configure or check project configuration.

Click **Close** to exit Project Wizard without any operation performed.





## Page layout design

This step allows users to create a page template with a common visual layout for every report page.

A page template will save all static objects, including images, pictures, backgrounds, static drawings, static text, and some dynamic objects, such as page number, dynamic text and date/time.

The **Reports Page Design** window has a number of options to create a page template for the report:

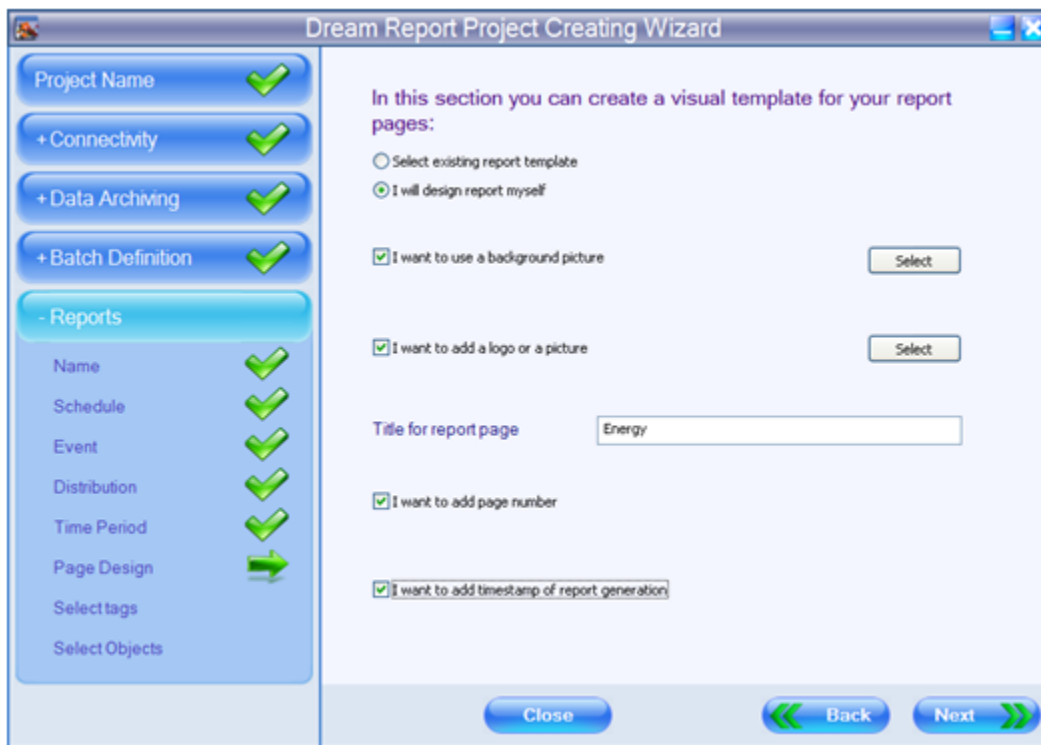

User can select one of the 2 ways to use a page template in the report: **Select existing report template** and **I will design report myself**.

If **I will design report myself** radio button is enabled, please, create a report template yourself by selecting the proper settings in the **Reports Page Design** dialog window (see pic. above).

**I want to use a background picture** option enables to set a background image for the report pages. Button "**Select**" will open a standard Windows Open File dialog box, where a user can select an image file ( **\*.jpg** file format) to use as a background picture in the report page template.

**I want to add a logo or a picture** option enables to add a picture to a report. Button "**Select**" will open a standard Windows Open File dialog box, where a user can select an image file ( **\*.jpg** file format) to add to the report page template.

When an image is inserted into a report, it can be handled as a native Dream Report object. It will be saved in the report layout file and will not require the original image picture file.

After adding an image, it will be available to most of the object operations: copy/paste, re-size, move etc.

If **I want to add page number** option is selected, then, the page number will be automatically added to every page of the report.

**I want to add timestamp of report generation** option enables to add to the report page template the timestamp of logged item values to be displayed, using local time of the computer where Dream Report is running.





## Ocean Data Systems

You can also type the **title for report page** in the corresponding edit box.

**NOTE:** Page template files are created with \*.ptdr extension. By default page template files are saved in the Templates folder within the Dream Report installation directory.

Click **Next** to go to the next step of project creation.

Click **Back** to go one step back to re-configure or check project configuration.

Click **Close** to exit Project Wizard without any operation performed.

If **Select existing report template** radio button is enabled, then, the following **Reports Page Design** window will be opened:

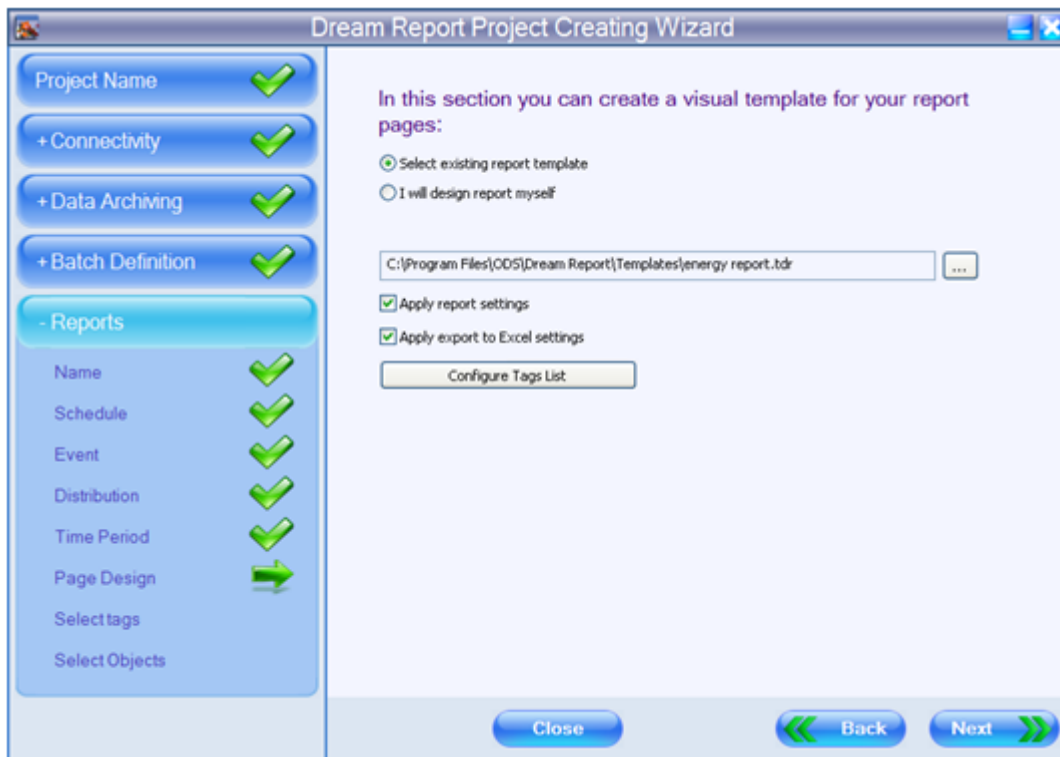

First, select (with the "..." browse button to the right from the combo box) the desired report template from the **Templates** folder of the Dream Report installation directory (\*.tdr files).

If the selected report template has any of the following settings: **Report Settings**, **Export Excel Settings** or **Tag Dictionary**, then, the corresponding options in the **Reports Page Design** window will become enabled.

**Example:** if you select "report energy 4" template (see pic. above), and this existing report template has all the settings mentioned above (**Report Settings**, **Export to Excel Settings** and **Tag Dictionary**), then, **Apply report settings** and **Apply export to Excel settings** check boxes will become checked, and the **Configure Tags List** button will become enabled. But, if you select an existing report template, that has only the **Report Settings** option set, then, only the **Apply report settings** check box will become checked. The **Apply export to Excel settings** check box will remain unchecked, and the **Configure Tags List** button will remain disabled.

In this window you can configure the applying settings of the selected report template (if needed) to be applied for your report page template, created in the Project Wizard.



**Apply report settings** check box defines report settings, such as report naming rule, generation schedule, report target configuration etc. If this check box is checked, then, the report settings from the report template will overwrite actual reports settings. If this check box will be/become unchecked, then the report will remain with the original report settings.

**Apply export to Excel settings** check box defines if Excel report configuration will be applied from report template to your report. If this check box is enabled, then Excel report configuration will be applied to your report and overwrite existing Excel configuration (if it exists). If this check box will be/become unchecked, then, the Excel report configuration will not be applied to your report from the report template.

**Tag configuration.** If the current loaded template has any entry(ies) in the tag dictionary, then, the **Configure Tags List** button will become enabled. If the current template has no tag dictionary defined, or it's originated from older versions, then, the **Configure Tags List** button will be disabled.

If you click on the "**Configure Tags List**" button the "**Project Tag Dictionary**" window will be opened (please, see [Tag Dictionary](#) section).

If this dialog is opened from the existing report template, which has tag dictionary defined, then it will be filled with tag descriptions from the template. "**Source**" and "**Item name**" columns will contain a small button "..." (browse). When user clicks on it, the following **Data Item Picker** dialog window will appear:

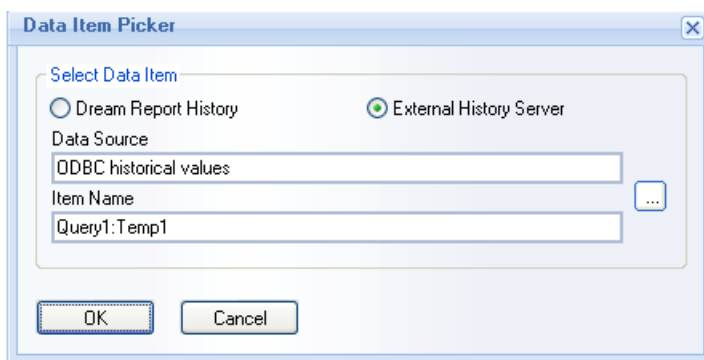

If a user clicks **OK** in this item selection dialog window, source name and item name will be set into the list control. The source type (**Dream Report History** or **External History Server**) will be saved for each entry separately as well.

If source name or/and item name is defined in the list control, and a user calls the item selection dialog window, then **Select Data Item** window will be opened with existing selection filled in.

If a user double-clicks either into the "**Source name**" column or into the "**Item name**" column, the cell will be opened for manual text editing.

For details on how to configure tag dictionary, please, go to the [Tag Dictionary](#) section.

**NOTES:**

- Once the selected template is added to the report, each template element will be available for editing as an independent object.

Further report modifications will not affect its report template design and also further template modifications will not affect design of that report.

- Page template files are created with **\*.ptdr** extension. By default page template files are saved in the Templates folder within the Dream Report installation directory.

Click **Next** to go to the **Final** step of project creation.

Click **Back** to go one step back to re-configure or check project configuration.



Click **Close** to exit Project Wizard without any operation performed.

## Tag Selection

This step of the project creation enables a user to select tags that will be applied to all reporting objects, defined in the next section (**Object Selection**) of the Project Wizard.

In the **Reports Tag Selection** window (please, see pic. below), select tags/items to be applied to the report objects:

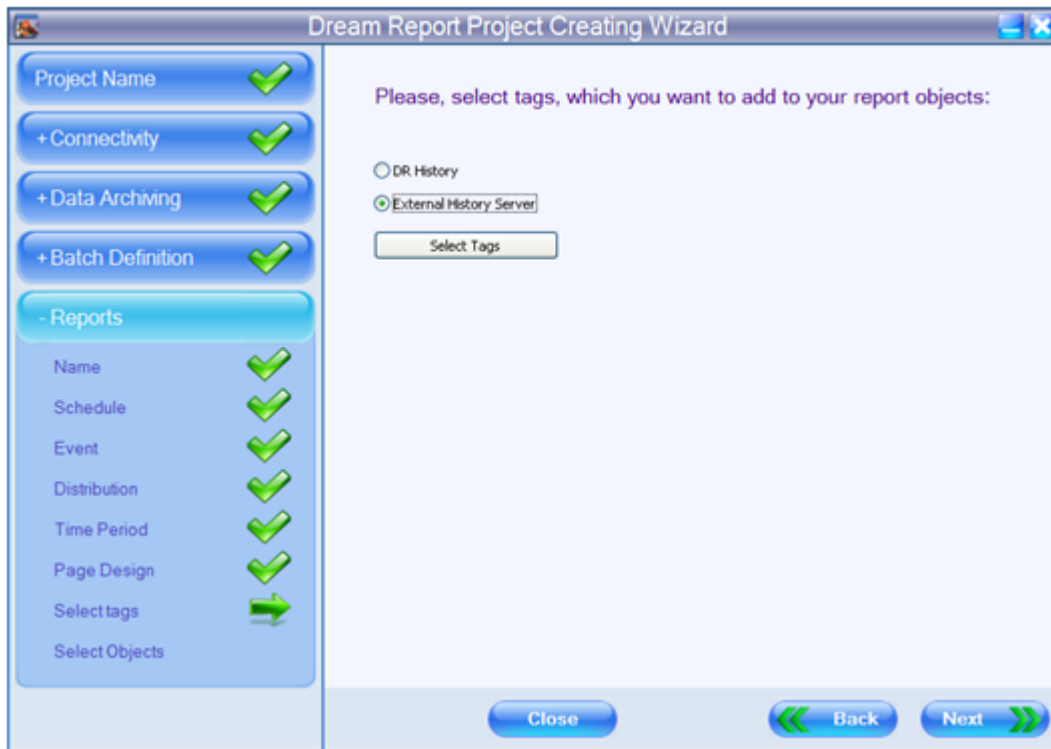

The radio buttons "**Dream Report History**" and "**External History Server**" define whether historical data will be taken from the Dream Report history or directly from the history of an external server using the history driver for that server.

The **Select tags** button will open a new dialog box (**Select Data Items**), containing the complete list of all data items from the selected drivers. User will be able to add or remove items from the entire item/tag group.

If the radio button "**Dream Report History**" is enabled, then, the "**Select Data Items**" dialog box will contain a list of data access drivers defined in the project. If the radio button "**External History Server**" is enabled, the "**Select Data Items**" dialog box will contain a list of history access drivers defined in the project.

The left-list box of that window will contain a complete list of available items and the right-list box will contain a list of items selected for the entire group.

**Items Filter** enables users to easily find an item in a list. As soon as a prefix is entered, the list will be automatically filtered by the prefix.

Use an asterisk (\*) as a wildcard character.

**NOTE:** If you select "**Dream Report History**", then you will be prompted to select a data item only from the list of data items defined in one or more logging groups within the Dream Report logger.



## Ocean Data Systems

If you select "**External History Server**", then you will be prompted to select a data item from the list of all available items within the selected history source.

Click **Next** to go to the next step of project creation.

Click **Back** to go one step back to re-configure or check project configuration.

Click **Close** to exit Project Wizard without any operation performed.

### Object Selection

This step of the project creation enables a user to select the types of dynamic objects that will display the data in the report.

In the **Reports Objects Selection** window (please, see pic. below), select the type of the report objects you will need for your report data display:

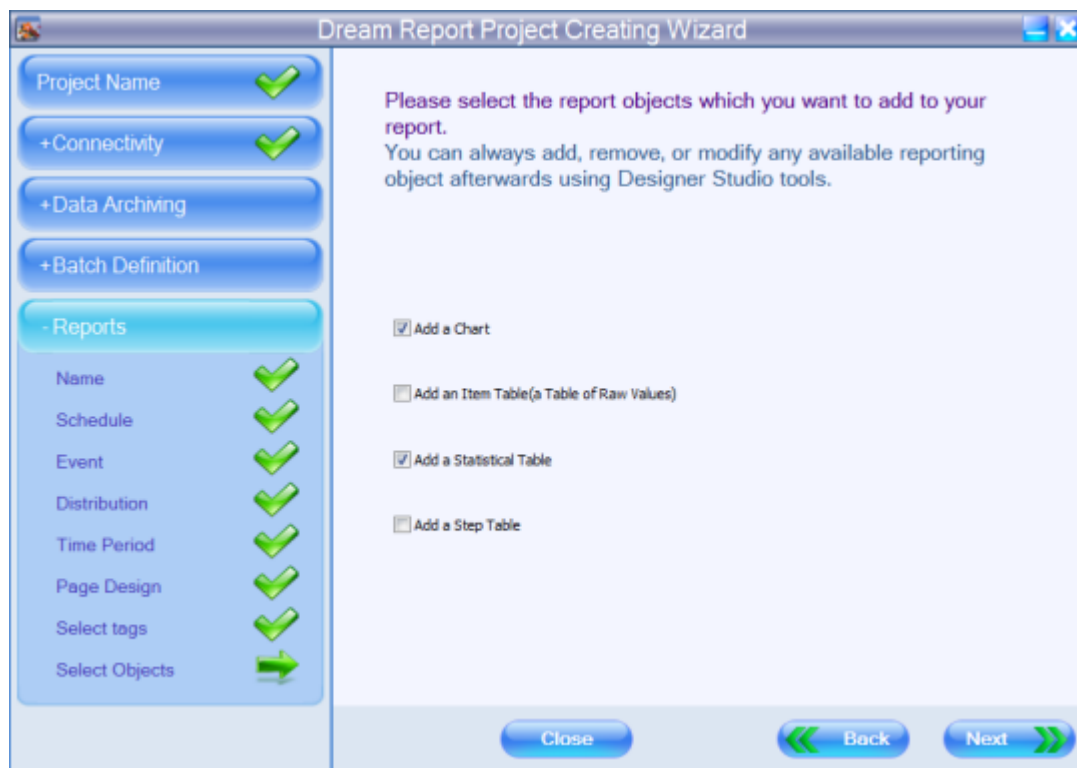

**Add a Chart** option enables to create a chart to display data value, a counter of logged values or a counter of logged alarms.

**Add an Item Table (a Table of Raw Values)** option enables to create a table, that will display an array of values from one or more data items within a specified value range, which were logged during the specified time period.

**Add a Statistical Table** option enables to create a table that will display the performance of some statistical functions for the selected tags during the defined time period.

**Add a Step Table** option enables to create a table automatically with a predefined time for each row in the table.

**NOTE:** The type of the selected dynamic object can be removed/added/modified in the Dream Report Designer studio after Project Wizard project creation is completed.

Click **Next** to go to the final step of project creation.



## Ocean Data Systems

Click **Back** to go one step back to re-configure or check project configuration.

Click **Close** to exit Project Wizard without any operation performed.

At the final step of the Wizard project creation, the button **Create** will complete Project Wizard, create the entire project according to its definition, and open the Dream Report Designer studio with that project:

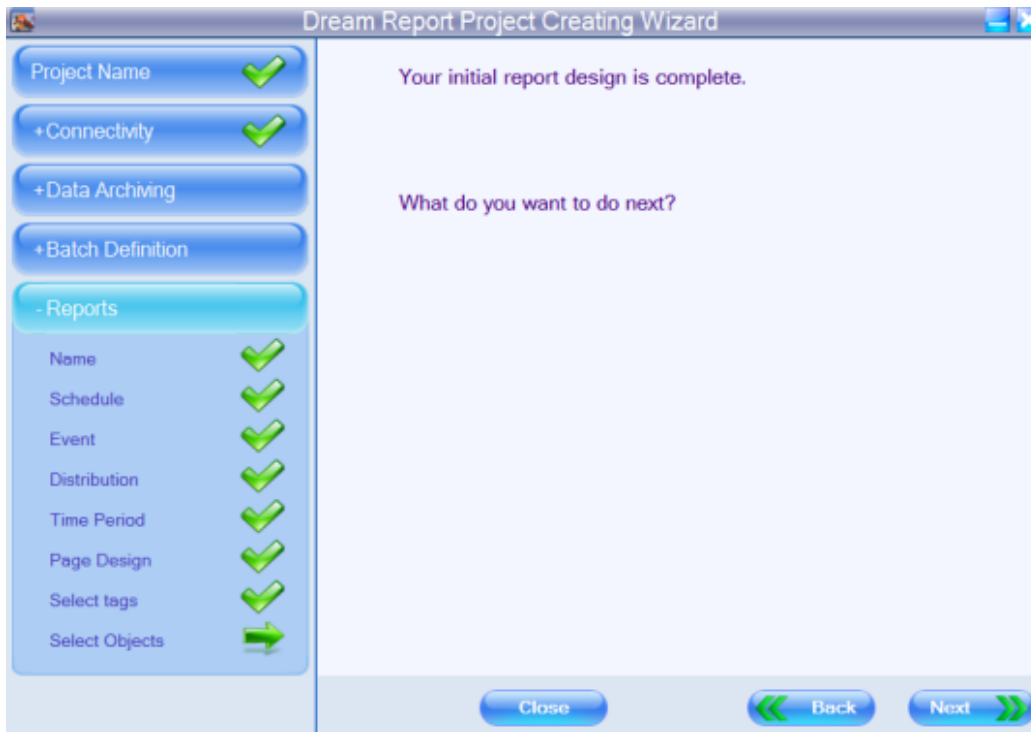

If you click **Back**, you will go one step back to re-configure or check project configuration.

If you click **Close**, you will exit Project Wizard without any operation performed.

If you click **Create**, Project Wizard will close, and the created project will be loaded into the Dream Report Studio. This new project will be created in a specified folder with all project and report files according to the information already entered in the completed steps.

You can then continue project development (if needed) in the **Designer Studio** in a normal working mode.

If Project Wizard was launched when opening the Dream Report Designer Studio, then, when you click **Create** and Project Wizard closes, Dream Report Designer Studio will start automatically with the project just created.

If Project Wizard was launched either from the Windows start menu or by double-clicking on the **ProjectWizard.exe** file in the Dream Report project/system folder, then, when you click **Create**, nothing will happen. The created project and all its configuration files will be saved in the Dream Report Project folder in a special folder that will have the name, defined in the **Project Name** section of Project Wizard. Then, if you want to continue project development in the Dream Report Designer Studio in a normal working mode, you will only have to double-click on the **<project name>.drpj** file to start the project.

**NOTE:** If you click **Create**, and the message box "**Project Name is Empty**" will pop up, please, go back to the **Project Name** section and define the name of the project. Then, you'll have to go again through all the steps of project creation in the Project Wizard (the only section, which will remain configured, will be "**Connectivity**"), and the new project will now be saved in a specified folder with all project and report files according to the information already entered in the completed steps.

For details, please, see **Project Name** section.



# Project Settings

## Project Settings - General

**Project Settings** is a dialog box, which defines global settings of the opened project.

All entered data will be applied to the overall project

To open **Project Settings**, click on the command button *General* on the **Project** ribbon icon on the horizontal toolbar either in the Dream Report Logger Studio or Dream Report Designer Studio menu (see pic. below):

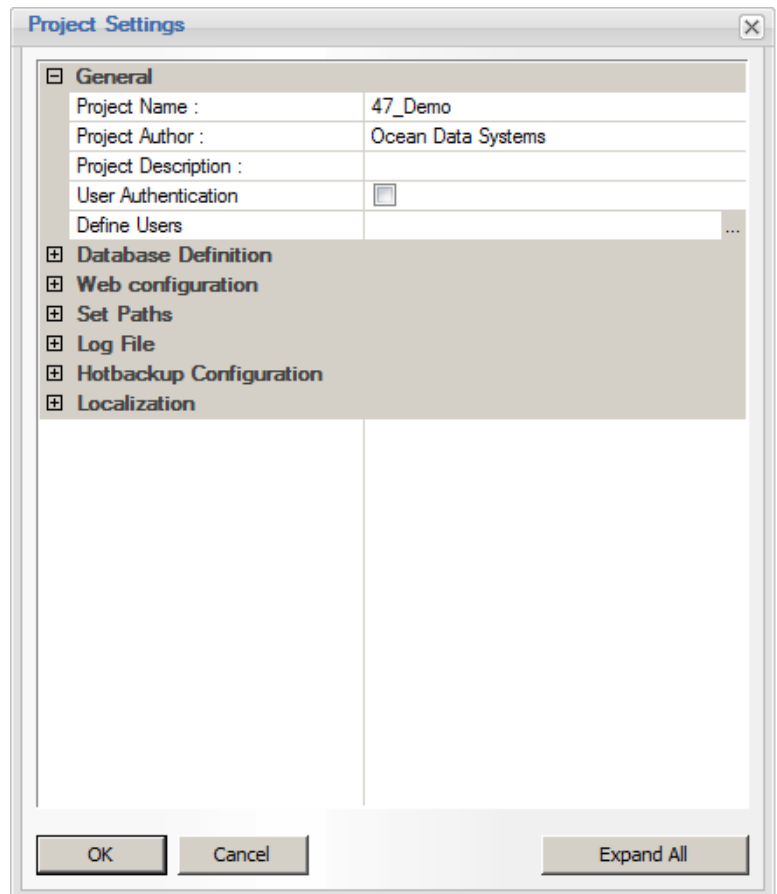
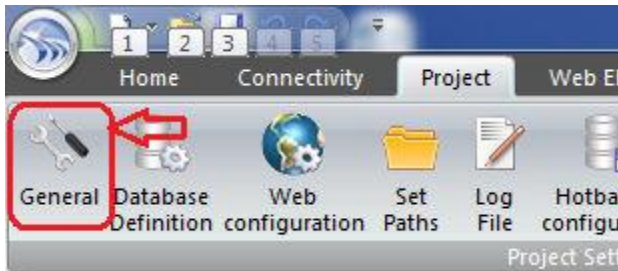

A user can define:

- Project-related general information (name, author, description)
- Database connection settings
- Log file definition
- Web portal configuration settings
- Project paths to different folders for file management of different modules
- Connection of two Dream Report stations as a hot backup couple to work accordingly
- Interface language settings - all dialog boxes and menus.

In the **GENERAL** tab, a user defines general project-related information, like project name, author and description.

Project configuration files will be saved in a folder, which will have the project name you have entered.

- Check box **"Enable user authorization"** defines whether project access is going to be password protected. If the user checks that check box, he has to define users.
- Clicking on **"Define Users"** button will open user definition dialog box. For more detailed information, related to this dialog box, please refer to the User Management section.

If user management is switched on in the entire project, and the currently logged on user has no access to user definition window, then all controls in **"User Authentication"** group (check box and a button) will be disabled.



## Ocean Data Systems

To enable it again, please, login with an appropriate user, using studio menu ([User Management - Log in with different user](#)).

**Internal Project Parameters (IPP)** section enables to configure a set of pre-defined internal variables for the project which can take data from report objects (during report generation) or from command lines. When user will click on the button "[Configure Project Parameters](#)", the "**Internal Project Parameters Dialog**" window will be opened where user will be able to configure passing parameters for report generation.

For details on internal project parameters configuration, please refer to the [Project Parameters](#) section of this manual.

**NOTE:** New project can be also started by clicking on the DR Main Button in the upper left part of the Dream Report Designer Studio (please see the picture below):

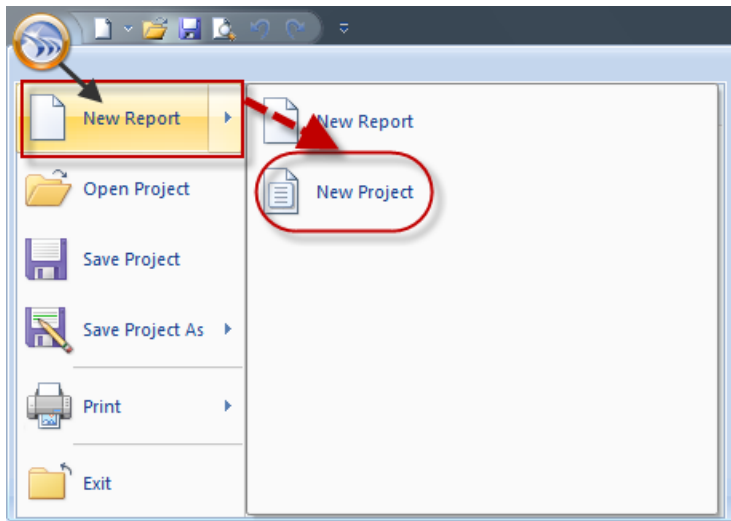



## Ocean Data Systems

By clicking on the DR Main Button in the Dream Report Designer Studio users can also perform the following operations with projects, such as:

- create a new project;
- open any existing project;
- save the current project;
- exit the Studio (with the current project opened) (please see the picture below):

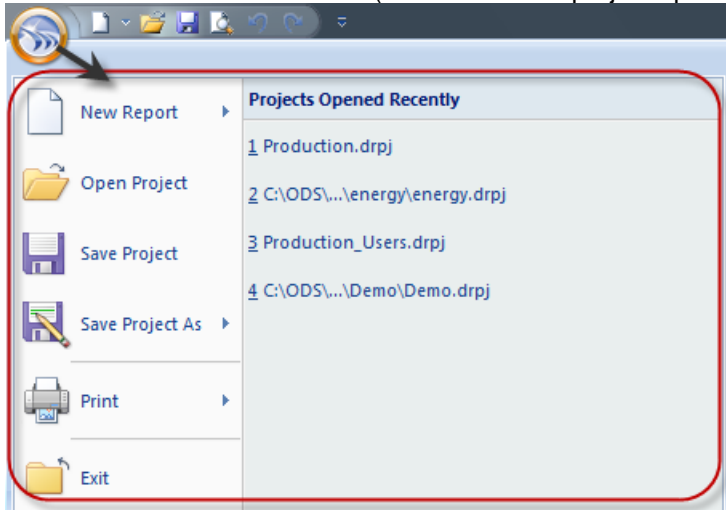

By clicking on the DR Main Button in the Dream Report Logger Studio users can perform only some of the operations (enabled in the DR Logger Studio) with projects, such as:

- open any existing project;
- save the current project;
- exit the Studio (with the current project opened):

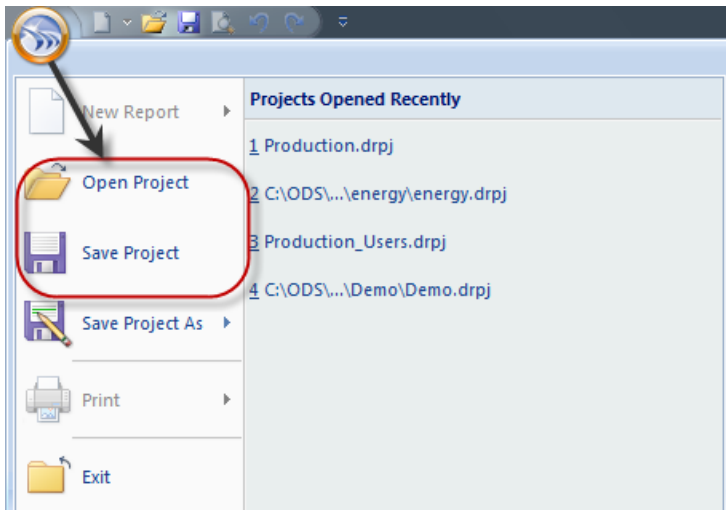





## Project Settings - Database Configuration

**Database Configuration** tab enables users to configure databases for data and alarm logging within the entire project.

Data can be logged either to the Dream Report default database or to any open database using the ODBC interface.

To open **Database Configuration** dialog window, click on the command button *Data Base Definition* on the **Project** ribbon icon on the horizontal toolbar either in the Dream Report Logger Studio or Dream Report Designer Studio menu (see pic. below):

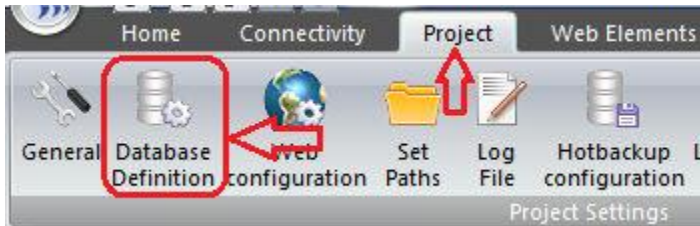

**Default Database (MS Access/MS SQL Server)**. If this option is selected, the project database will be created automatically in the project database folder, defined in the **Project Settings** dialog box.

No user configuration is needed. The database will be created and maintained automatically

**NOTE:** It is highly recommended not to use the MS Access for the real projects installing at least SQL Server 2008 Express edition as minimum required. Please note that SQL Server Express Edition is commercially free, however as a free tool it is also limited in terms of performance.

When selecting the option to use "MS SQL Server" - there is a combo box, where user can select any available local or remote SQL server - either default server or any of its instances.

**Custom database using DSN.** This option enables users to connect to any predefined custom database, using the ODBC interface.

If this radio button is enabled, user will have either to select an existing DSN, or add a new DSN definition. New DSN definition will be created using the standard Windows wizard window, which will be opened as soon as user clicks on **Add** button.

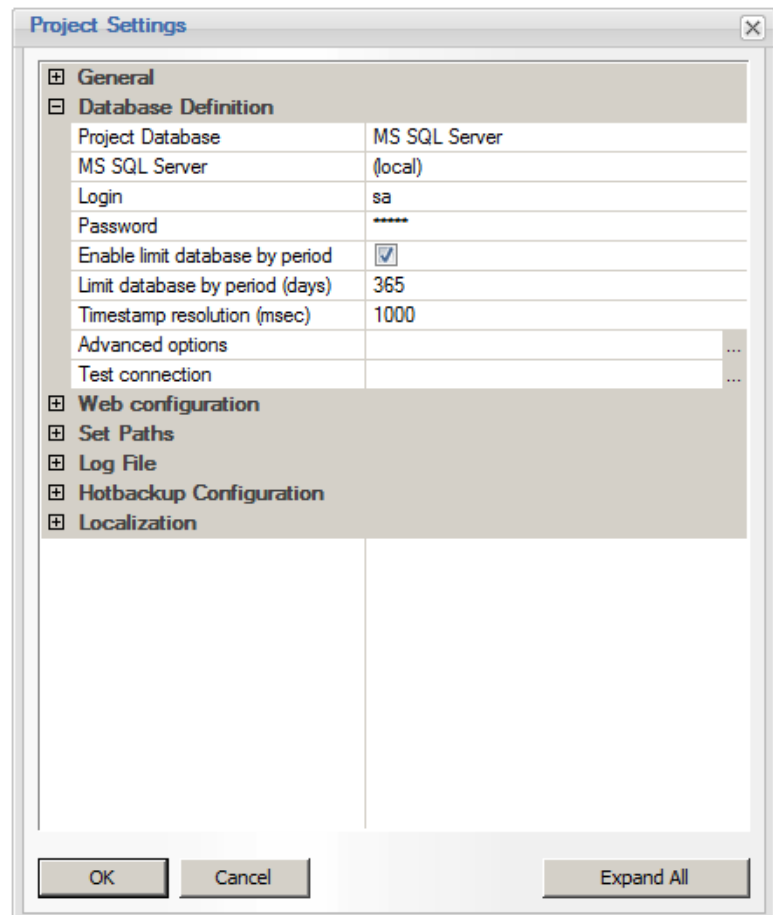

After the DSN selection, user will have to specify DSN login and password, and click on **Test connection** button to check if the connection to the selected DSN succeeded or failed. If DSN connection failed, a message box with error will be opened. User will have to check the reasons for the DSN connection failure.

This option also enables users to connect to remote databases over the network. The network connection will be managed by ODBC.



**NOTES:**

- All DSNs defined in the project are saved and can be managed from one place (for details, please see the [DSN Manager](#) section of this manual).
- If, before upgrading to version 4.6, the Dream Report project DSN was defined in order to connect to SQL databases (SQL Server 2008, SQL Server 2005,), then, in version 4+, the driver in the DSN definition should be changed for the SQL Native Client 10.0 driver (for details, please see the [Project Upgrade Procedure](#) section of this manual).

**Limit Database by period.** If enabled, this option allows a user to limit the database by the data age, i.e., the maximum number of days for which historical data will be kept. This will be checked by Dream Report each midnight or during project start. All data exceeding the limits will be deleted without being backed up into another database.

This option is recommended to be used especially with databases with limited allowed database sizes, for example with SQL Server 2005 Express Edition, limited to 4 Gb, or SQL Server 2008 Express Edition which is limited to 10 Gb and newer SQL Server Express Editions (2012, 2014).

In the [Data Logging Settings](#) section you can configure your timestamp settings for a timestamp for logged item values and alarms.

**Data Logging (Timestamp Resolution)**

The Dream Report logging system enables you to select timestamp resolution for logged item values. The default timestamp resolution is 1000 msec, which means that, by default, Dream Report is logging data with 1 sec resolution and milliseconds are rounded to a second using standard rounding rules. This significantly saves the database space and keeps it more usable.

However, if, in any specific cases, second resolution is not enough and milliseconds are required, you can set your resolution in a [Timestamp resolution](#) edit box. If msec resolution is set, then, all incoming milliseconds will be rounded using standard rounding rules according to the selected resolution.

**Here are few examples:**

**Example 1:** If resolution is set to 1000 msec and 2 values are coming: value: 5, ts: 12:01:10.125 and value: 6, ts: 12:01:10.550.

Result: both values will be recorded with timestamps: value: 5, ts: 12:01:10 and value: 6, ts: 12:01:11.

**Example 2:** If resolution is set to 1000 msec and 2 values are coming: value: 5, ts: 12:01:10.525 and value: 6, ts: 12:01:10.750.

Result: only last value will be recorded with the timestamp: value: 6, ts: 12:01:11, because both values are rounded to the same second and always only the last one will be logged.

**Example 3:** If resolution is set to 200msec and the following value is coming: value: 5, ts: 12:01:10.750.

Result: the value 5 will be recorded with the timestamp: 12:01:10.800.



## Data Logging (Time)

The timestamp of logged item values and/or alarms will be logged using both the local time of the computer, where Dream Report is running, and the UTC/GMT time format.

## Data Logging and Database Organization

In Dream Report 4 generation a completely redesigned database structure has been introduced. It allows Dream Report to raise data logging up to 10 times.

## Database Archiving

If user clicks on "[Advanced Options](#)" button, the "[Database Archiving Configuration Dialog](#)" window will be opened. In this configuration window user will be able to configure periodic archiving of internal Dream Report database.

For details on the configuration of database archiving, please refer to the [Database Archiving Configuration](#) section of this manual.

### Useful tips:

- **Which database is better to use?**
  - MS Access can be used only for small-size projects. MS Access is limited in size to 2Gb, but when your MS Access database (\*.mdb file) reaches the size of several hundreds Mbytes, you can start to experience problems, so we recommend to use MS Access where the database size doesn't exceed 100Mb.
  - MS SQL Server is a good and reliable database, and is recommended for use. MS SQL Server Express 2008 Edition is free and is limited in size to 10Gb. So, if your database does not exceed 10Gb, this database type can be also used.
  - MySQL is free and has no limitation. This database type is also recommended for use as good and reliable.
- **What is the approximate database size allocation?**

When numeric data is logged by Dream Report, then the approximate database size allocation is about 16 bytes per record. When string or textual values are logged, this depends on the size of a logged text.
- **What is the supported data logging performance?**

Actual Dream Report version supports data logging frequency up to 1000 records per second if data provider is capable to provide data at such a high rate.



## Project Settings - Web Configuration

This dialog box allows a user to define the remote station list for the web portal.

Dream Report web portal provides users with a list of predefined remote Dream Report stations and can re-direct a user to any listed remote station.

To open **Web Configuration** dialog window, click on the command button *Web configuration* on the **Project** ribbon icon on the horizontal toolbar either in the Dream Report Logger Studio or Dream Report Designer Studio menu (see pic. below):

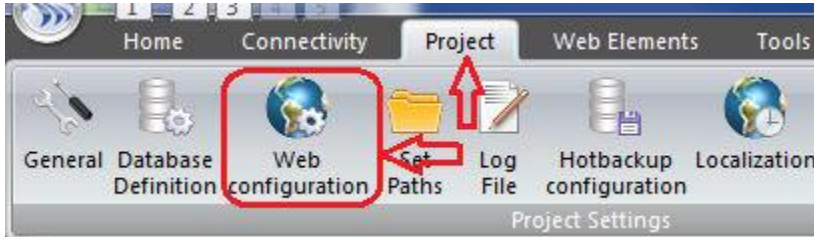

The predefined remote station list is created in this dialog box. User has to specify a list of each logical station name and its URL.

Station "localhost" with URL "localhost/drweb" is always added automatically for a local Dream Report project.

**Alias name for local web server** is a name, which Dream Report will use for a new virtual folder. It will be automatically created on every project start.

To have access to a project in the Dream Report Web Portal, each time a new project is started, user will have to configure IIS (Internet Information Services) for that project manually, by clicking on the **Configure IIS** button.

If the IIS configuration process has succeeded, user will get the message "**IIS configuration has been successfully completed**". Otherwise, he will have to check the reason for the IIS configuration failure.

**NOTE:** If Internet Information Services (IIS) are not installed in your operating system, you will get the message box "**Can't configure IIS. Web portal is not enabled**". You will have, first, to install IIS, and then, configure IIS (for details, please, see **Installation Tips**).

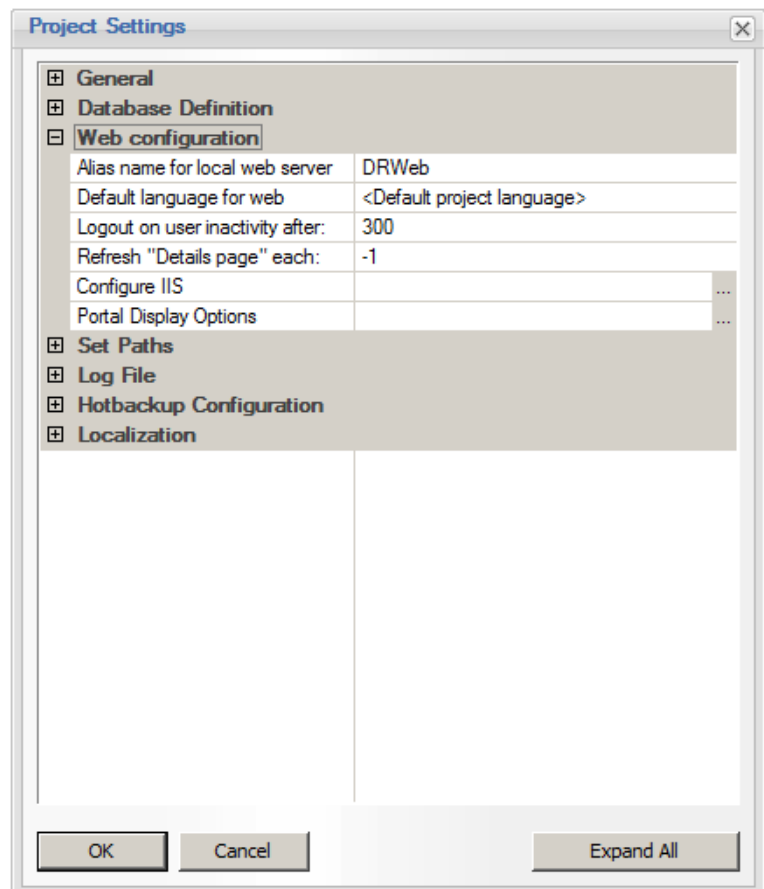

Internet Information Services (IIS) can be also configured from the Runtime Management Console (for details, please, see **Runtime Management Console** section).



**NOTES:**

- For IIS versions 7, 7.5 and 8, if user clicks on "*Configure IIS*" button, the Application Pool "**OdsDrAppPool**" will be automatically created. Thus, for 64-Bit OS this will allow automatic configuration of Dream Report Web portal;
- If you upgrade Web Portal to Dream Report version 4.6, when you click "*Configure IIS*" button, you will have to agree to save the backup of your Web Portal configuration. Please, click "*Yes*" in the **IIS configurator** window, which will pop up asking: "*Do you want to backup the actual content of your project web files?*"

**Default language for web clients** combo box defines which language will be used for a web client by default (if a language on a web client web browser does not exist in the product language list).

**Station Name** is a logical name of the Dream Report station, which will be displayed in the list of Dream Report stations.

**URL** is a real address with the alias name of the Dream Report virtual folder.

**Timeouts** group box contains tunable timeout parameters, described below:

**Logout on user inactivity** parameter specifies a timeout period, during which, if a user performs no action (click, mouse move, press key on a keyboard), web portal will automatically logout a currently logged user. So, then user will need to login again to continue working with a web portal.

**Refresh "Details page" each** parameter specifies a timeout period, where every such a period, web portal will automatically check for updates in the reporting project and refresh "Details" page. Parameter value (-1) will disable auto-refresh of the "Details" page. This value is set by default. Minimum value is 1 second, i.e. web portal will check for project updates every 1 second and update the "Details" page.

**Display Options** - if user will click on the button "Portal Display options", the display options dialog window will be displayed:

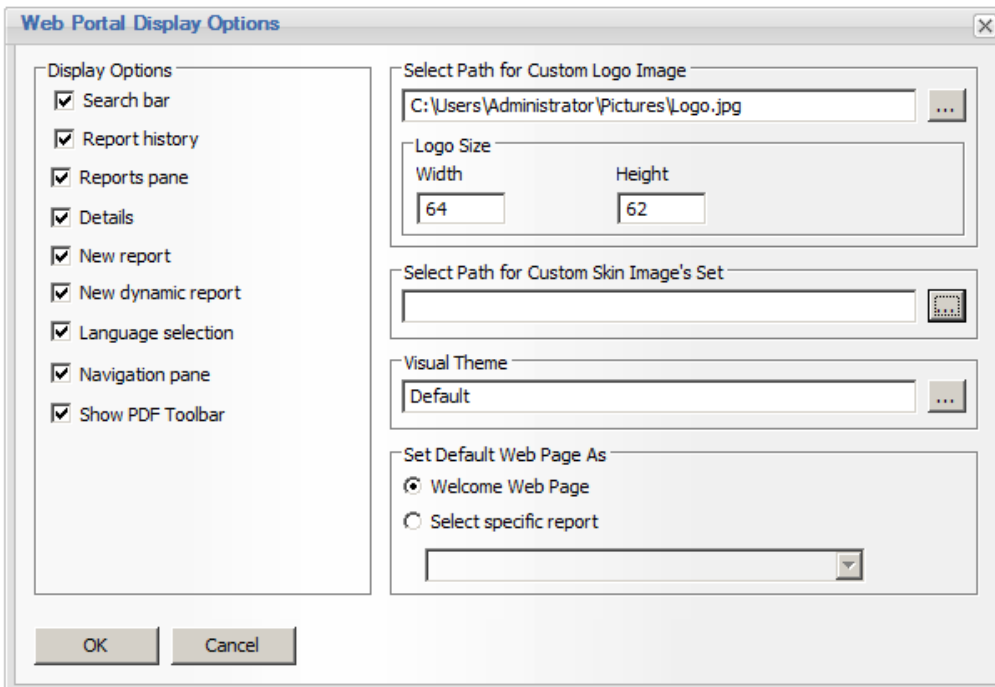

In this dialog window, the user can select which elements of web portal he would like to display or to hide.



## Ocean Data Systems

**Select path for custom logo image** allows users to select an image, which will be displayed in the top left corner of a web portal.

**Select path for custom skin images set** allows users to select images, which will be used as a skin for web portal window.

These are project-based settings, which means that in different projects on the same PC user can set different images.

The section **Set default web page as** allows users to select which web page will be opened by default when web portal is opened as a default first page. Usually, by default, web portal is always opened at the "Welcome page" with the list of all reports in the project. However, user can select another page, which can be any available report page. Then, every time when web portal is opened, it will be opened at selected page.

Here we need to mention that there is also another possibility to set a default page for specific user - in User management section it's possible to set the first page for specific users.

The different between the default page setting in this section and the first page per user is that in this Project setting section the default page is set globally per project, independently of a user. And the first page per user is set for specific user without any impact on a global project.

If the project has both options enabled, if no user is logged, then project default page will be loaded. If a user logged in and he has another first page defined, then user page will be loaded. User defined page will have higher priority than a project global first page.

**For example:** if the project setting has report A as a default and user Sam has defined default page report B.

So, if user Jim will log in - the report A will be loaded as the first page (project default page). If user Sam will log in, then report B will be opened as the first page.



## Project Settings - Folder Selection

In the **Project Paths** dialog window a user can configure destination folders, where different project files will be written to.

To open **Project Paths** dialog window, click on the command button *Set Paths* on the **Project** ribbon icon on the horizontal toolbar either in the Dream Report Logger Studio or Dream Report Designer Studio menu (see pic. below):



The following dialog window will be opened:

By default all folders will be pointed to the following directory:

*<installation directory>/Projects/<Project name>*

However, a user can change working directories as follows:

**Project Configuration Files** defines where all project files will be stored:

- \*.drpj - Dream Report studio launch file
- \*.drt - Runtime manager launch and configuration file
- <report name>.cfg - files with settings of reports, defined in a project
- <report name>.lyt - files with object layout of reports, defined in a project
- other project related files

**Log File** defines the folder, where project log files will be created and stored.

**Default Database** defines the folder, where default database files (if defined) of the entire project will be stored.

**Report Destination Folder** defines the folder, where report files in PDF format will be stored.

**Web files** defines the folder, where all web portal related files will be copied

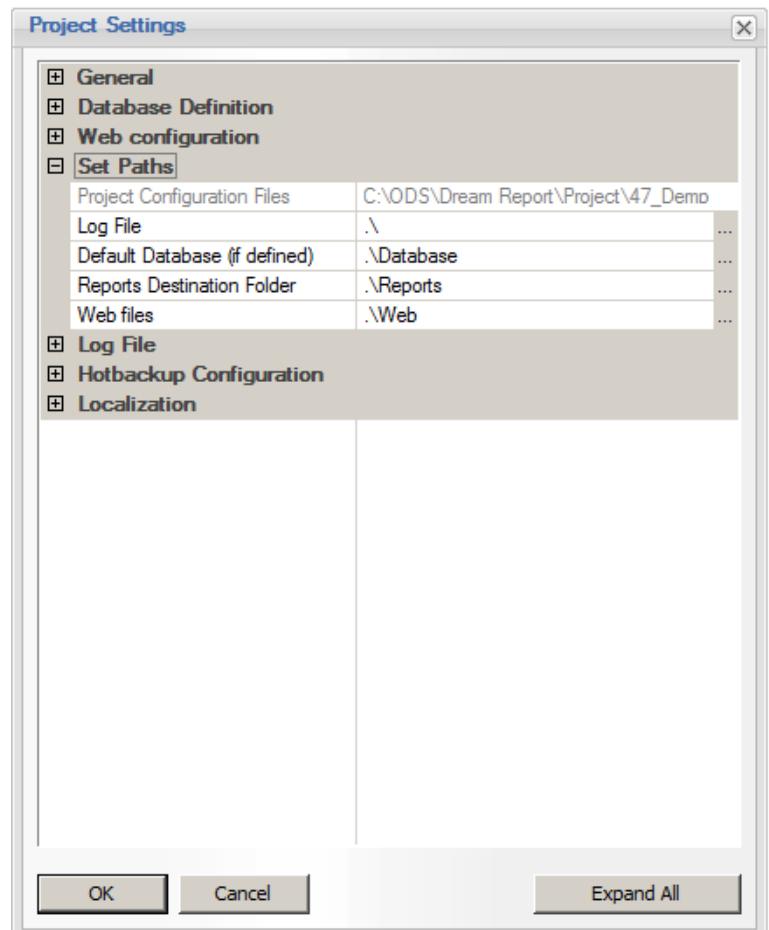

To change the folder, a user has to type a new path in the appropriate edit box, or click on the **Browse** button and select the specific folder.





## Project Settings - Log File Settings

**Dream Report** has a built-in service to log online errors and information, which may be useful in debugging or auditing a project.

The *log file configuration* is defined in the **Log File** tab of the *Project Settings* dialog box.

To open **Log File** dialog window, click on the command button *Log File* on the **Project** ribbon icon on the horizontal toolbar either in the Dream Report Logger Studio or Dream Report Designer Studio menu (see pic. below):



The following dialog window will be opened:

The log file is created and written in a **.csv** format, which can be opened by MS Excel as well as by the text editor.

Using MS Excel can enable a user to use built-in MS Excel filtering tools for easier analysis.

The **Use Online Log File** check box will enable logging of all online data.

The **Limit size of Info File** option will limit the size of the info file.

If this option will be enabled and file size limit is reached, additional data will be deleted.

If that check box will be unchecked, the log file size will be unlimited.

2 options are available:

**Cut from end** - older records will be deleted and newer added.

**Cut from beginning** - newer records will be deleted.

After the log file size exceeds the limit defined in the edit box "**Limit File Size by**", all content above the limit will be removed according to the selected option, described above.

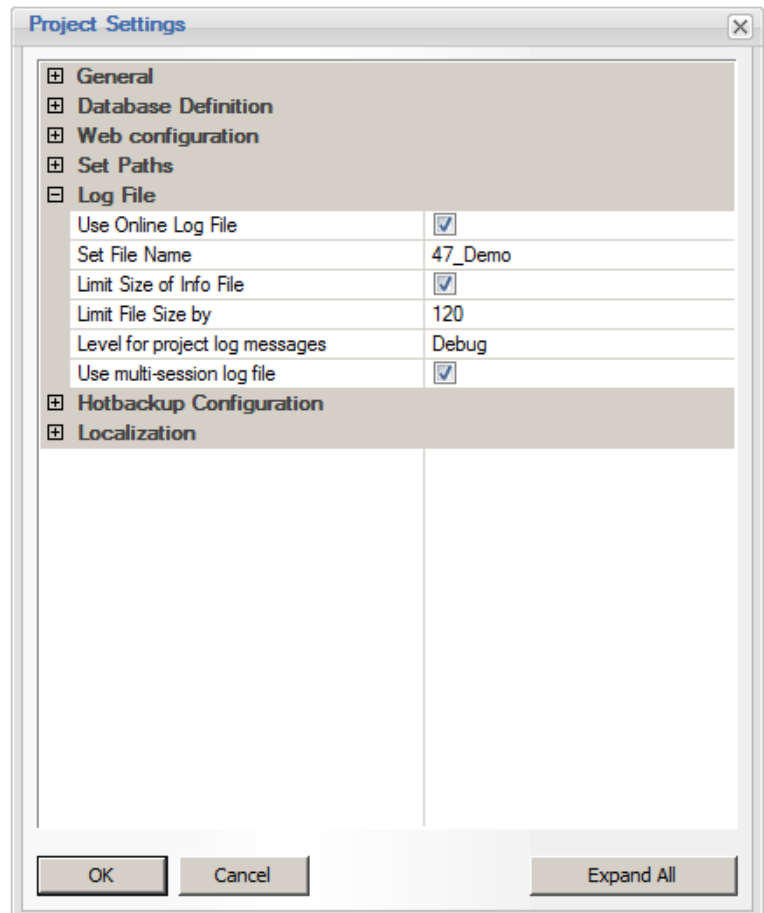





**Level for project log messages** combo box enables configuring the level to control which message of the severity of the event, that has occurred, will be actually printed out to the log.

2 options are available:

**Normal** - The default log level, where only the events with a severity of NOTICE or greater will be logged.

**Debug** - The log level, where all events will be logged in detail, and its debugging messages will be very important for diagnosing configuration problems.

### **Multi-session log file mode**

The Dream Report log file can manage info logging in 2 different ways: Each time a project is started, a new log file will be created (**single-session mode**) and log from old session will be removed. Or, each time a project is started, Dream Report will continue info logging in the same existing log file, just putting a note that a new session was started (**multi-session mode**).

This is managed by the "**Use multi-session log file**" check box. If this check box is enabled, the multi-session mode will be maintained. If this check box is disabled, then the single-session mode will be maintained.



## Hotbackup (Redundancy) Configuration

It's possible to run a local reporting runtime node as a redundant station, coupled with the main station.

There is no special configuration required for the main station - it should run as it is.

For the backup (redundant) node, first of all, it should run the exact copy of the project, which is running on the main station.

Then, to couple a backup node to the main node, a user will have to open **Hotbackup Configuration** dialog window by clicking on the command button *Hotbackup Configuration* on the **Project** ribbon icon on the horizontal toolbar either in the Dream Report Logger Studio or Dream Report Designer Studio menu (see pic. below):

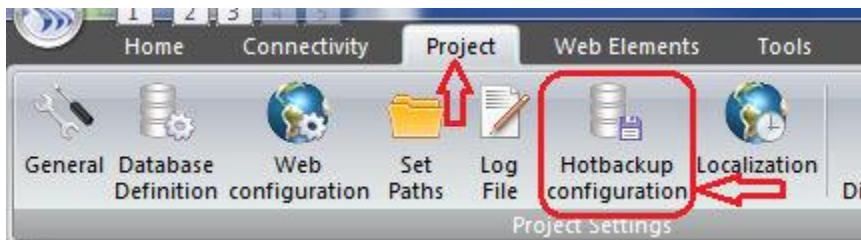

The **Hotbackup Configuration** window will be opened:

In order to define the local node as a backup for the main node, check the check box "**This node is working in a hotbackup node**".

Then, specify the **IP address** or **PC name** (without "\\ " - just a network PC name) of the PC, which is running as the main station (*Set the IP address or name of the PC where the main node is running*). This field must contain a valid information and it can't be empty.

If you wish to test the actual connectivity to the main station, you can press on the button **Test Connection**, and the Designer Studio will try to connect to the main node. If test connection succeeds, the message box "*Test connection succeeded*" will pop up. If test connection to the main station fails, the message box "*Test connection failed*" will pop up.

Hotbackup connection check uses **port 57034** on both the main and the backup stations sides. This port should normally be allowed by Windows or any other installed Firewall software when a user unblocks runtime during its first launch. But if connection test fails, it makes sense to check the Firewall for a proper port configuration.

As soon as you have defined this node as a backup, you have also to specify the **Checkup rate**. It must be a positive, non-zero number between 1 to 86400, which means each time interval in seconds, when this local runtime manager will check the connection to the main station.

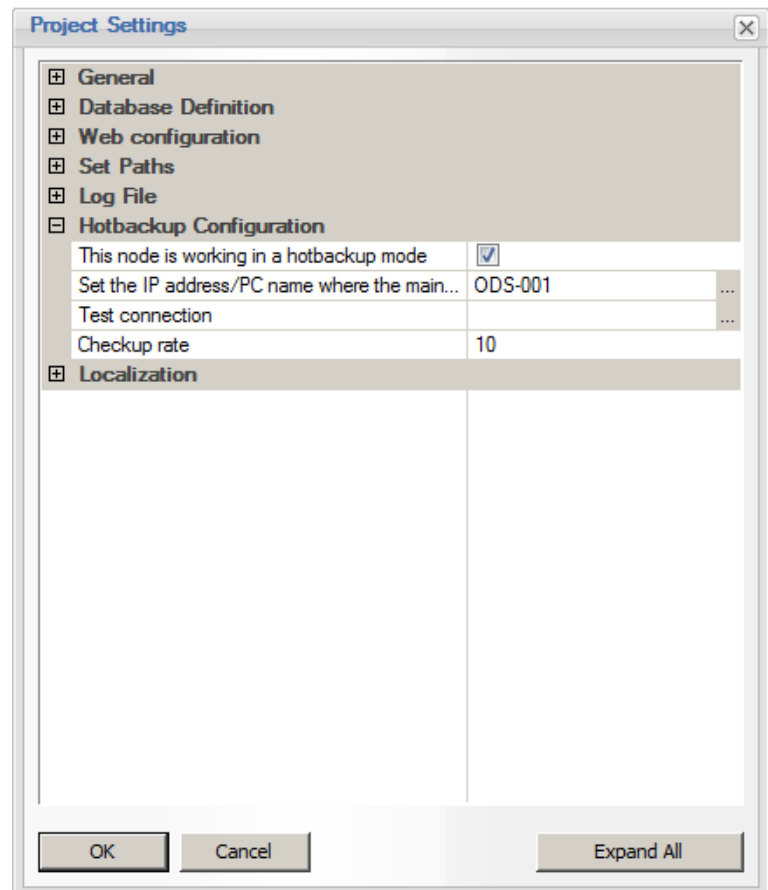



### Functionality

If the check box "**This node is working in a hotbackup mode**" is checked, then, when starting the runtime manager, it will try to connect to the runtime manager on the PC, which is specified as the main node. If connection check has succeeded, then the backup node will work in a standby mode. It will not record data into a database and will not generate reports, but will only periodically check connection with the main station every "checkup rate".

### Licensing

If user is using Dream Report in a backup mode, then he use a license with a special "backup" license option. A license with backup option allows users to use that license only on a backup node and such a license will have considerable discount from a regular such license price. More details you can check with your Dream Report reseller.



## Project Settings - Localization

The **Localization** tab enables users to set the language of the interface (i.e. all dialog boxes and menus), configure date/time/week, and display settings for the report objects.

To open **Localization** dialog window, click on the command button **Localization** on the **Project** ribbon icon on the horizontal toolbar either in the Dream Report Logger Studio or Dream Report Designer Studio menu (see pic. below):

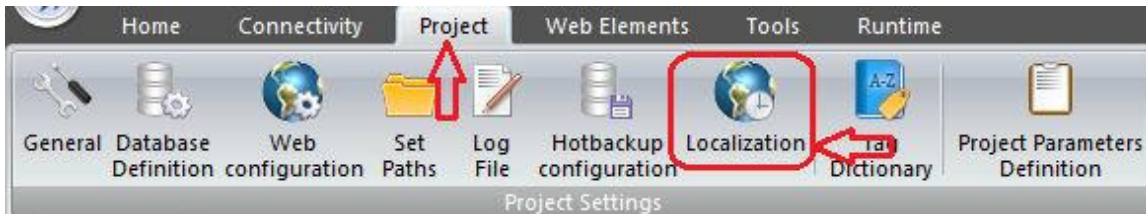

### Language Selection

This dialog box enables a user to select the current language of the Dream Report studio interface - dialog boxes, menu and popup messages.

When a new language is selected and a user clicks on **Apply** or **OK**, a new language will be applied immediately. No project restart is needed.

All strings are loaded dynamically from the language database (**Lexicon.mdb**) file, which is located in the **Database** folder of **Dream Report** installation.

Each language is implemented in a separate table. The name of the table is the name of the language. The list of tables in the language database corresponds to the list of available languages - it's recognized by Dream Report automatically.

#### **Useful tip:**

In order to add a new language, one needs only to add a new table to the database, which has to be the exact copy of the *English* table (English is a template language), open it and replace all English strings by the translated ones. The new table and new language will be recognized automatically.

### Date Format

Dream Report provides users a capability to configure a format of the timestamp, which will be displayed in various report objects. The default value of the date format will be taken from the Windows regional settings of the local machine.

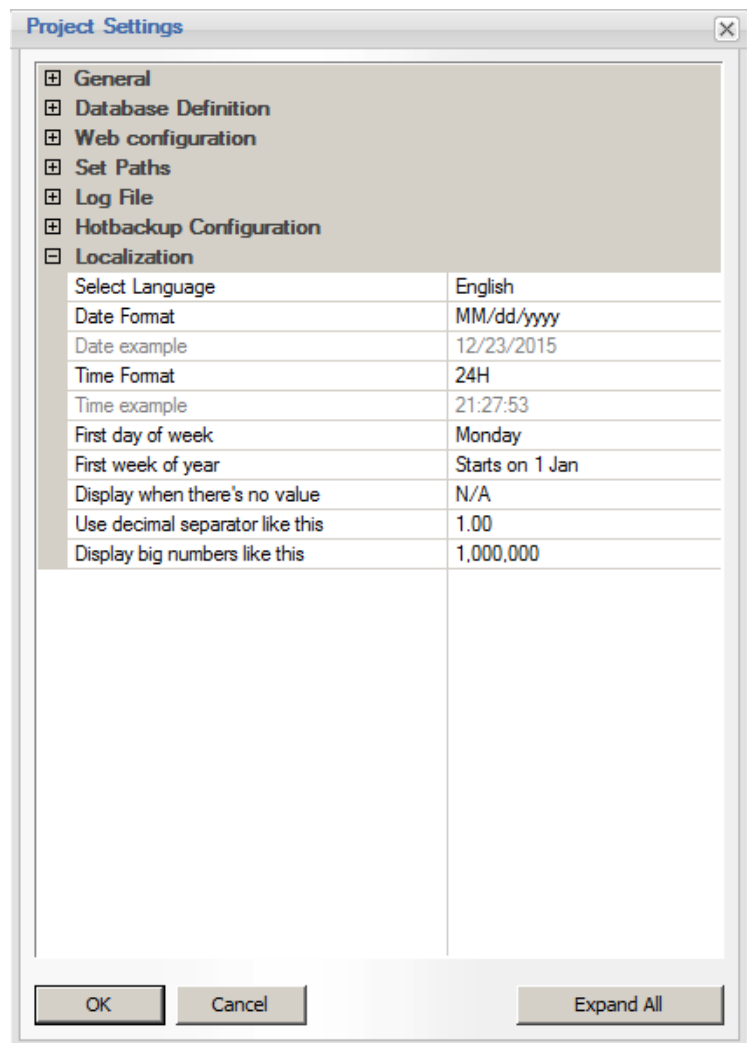

If a user wishes to change the date display format, he can select the desired date format from the **Date format** combo box. If that combo box doesn't contain the desired time format, user can enter any desired date format inside that combo box, using any free format and separators, and applying the following conventions:



## Ocean Data Systems

- dd - day of the month,
- MM - month number
- Mon - abbreviated month name (3 letters)
- yy - short year in 2 digits
- yyyy - full year in 4 digits
- Month - full month name in the local language.

After the required date format is set, an example will be displayed in the [Result example](#) edit box. This edit box is not editable and its purpose is only to display the result date representation.

### Time Format

Users can also select which time format will be displayed in timestamps - 24 hour time representation or 12 hour (AM/PM) time representation. The default value is taken from the operating system when a new project is opened. Then a user can change this setting by selecting the desired option radio-button.

**NOTE:** Date and time format from this dialog window will be used to display timestamps in item and alarm tables, display results of the following statistical functions in [Single Data Objects](#) (Timestamp of Minimum/Maximum/First/Last values), display timestamps in charts and bar graphs. The timestamp for the report name format is configured in [Report Settings --> Report name format](#). The timestamp for the step tables is configured in the [Step table](#) dialog window.

### Week Settings

[Week Settings](#) section has two combo boxes: "**First day of week**" and "**First week of year**".

In the "**First day of week**" combo box, select the day of the week, which will be considered as a week start day for weekly reports. By default selection is "**Monday**".

The "**First week of the year**" combo box defines the mechanism of how weeks enumeration will work. Select one of the three options: "**Starts on 1 Jan**", "**First 4 day week**" and "**First full week**". This setting will define the algorithm how to define a week number for display in the report and filenames.

Click on [Apply](#) or [OK](#). The new week settings will be applied automatically.

### Common Visualization Settings

This group box allows users to do advanced formatting of displayed results in all report objects.

**Display ("N/A") when there is no value.** This parameter defines what will be displayed in the report when there is no value to be displayed in this report. By default it is "**N/A**" (i.e. "**Not Available**"). User can put there any string (including blank space), which will be displayed in the report when there's no result available.

**Use decimal separator like this.** This parameter defines which symbol will be used as a decimal separator, that separates the whole part of a number from its decimal part. There are two choices available: "." (**a dot**) and "," (**a comma**).

**Display big numbers like this.** This parameter defines whether the result will be formatted with separated groups of digits for better readability, where a digit grouping symbol will be placed between each of digits (either 2 or 3 digits).

**Example:** If result number is [31415926535](#) and digit grouping symbol is <space>, then the displayed number will be: [31 415 926 535](#)



# User Management

## Project Settings - User Management

This functionality allows users to define user/user group authorization and authentication for access to different project modules.

The **User Management** dialog box provides an interface to define users and their access rights.

The number of users is unlimited.

If you want to enable other users to have access to the Dream Report project, first, check the "**Enable User Authorization**" check box in the **General** section of the **Project Settings** dialog box, and click on "**Define Users**" button. The following dialog box will be opened:

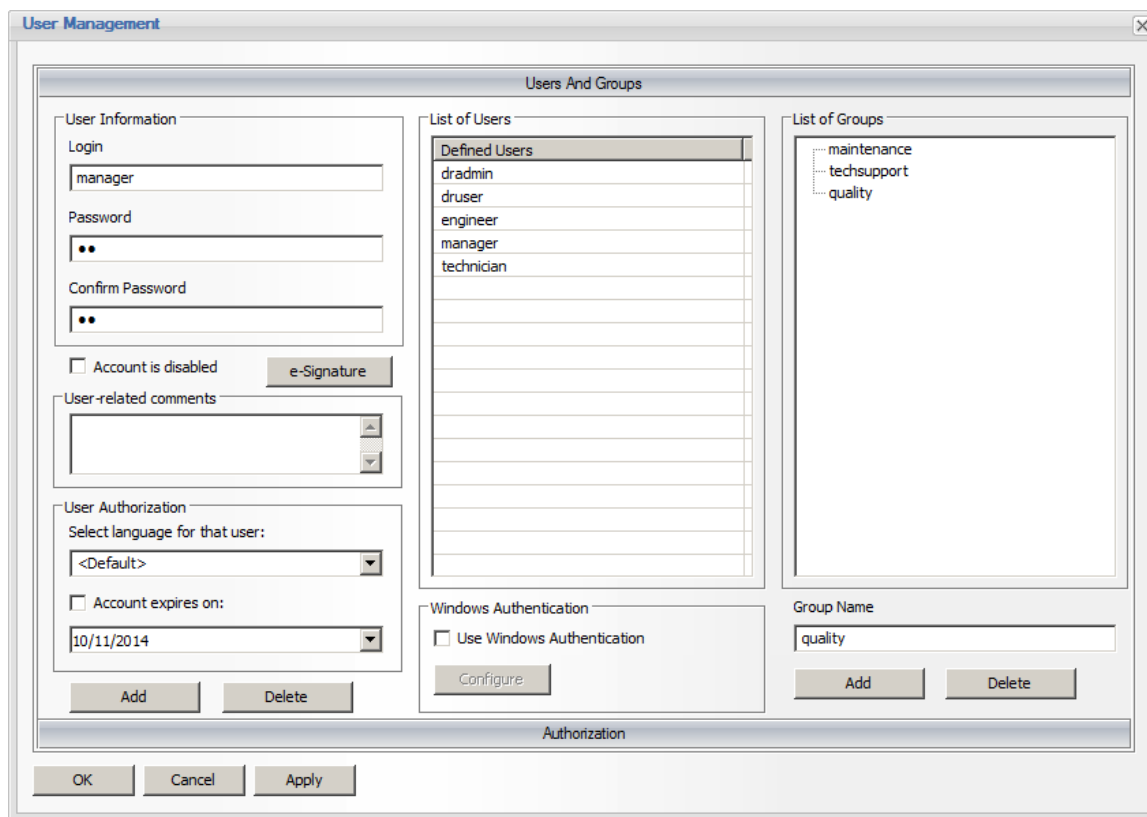

This dialog box will be also opened if a user clicks on the "**Edit project users**" command button in the **User Management** section of the **Project** ribbon icon on the horizontal toolbar or on the vertical toolbar either in the Dream Report Designer Studio or Logger Studio menu (see pic. below):

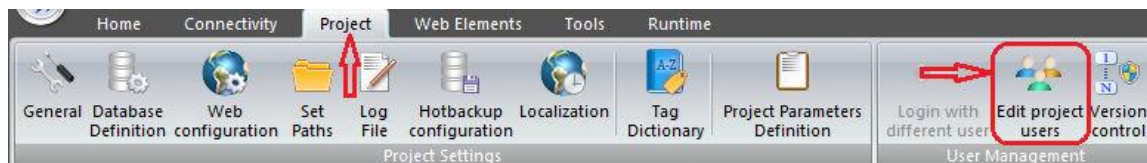

**NOTE:** **Edit project users** option will be enabled only if you have **Full Administrator Rights**, i.e. the right to modify existing users and their properties as well as to create new users. This access is usually given to project administrators (please, see **Full Administrator Rights** option in the **User/Group Authorization** section).



The **Edit project users** option enables to change user access to different project modules at any stage of the project report generation.

## Users and Groups

In the **Users and Groups** section, you can create users and user groups.

Left part of the dialog box contains the users definition and the right part contains the users' groups definition.

### List of Users

When you add a user, you fill in the user name, its password and password confirmation, set up the user's preferred language and expiration date as an option.

**User Authorization** section contains additional user definitions, like user-related language and expiration of the entire account.

The **e-Signature** button allows you to configure electronic signature details for that user, if required. For details on configuring electronic signatures, please refer to the section Electronic Signatures.

**Select language** option enables you to assign specific language of the Dream Report studio interface (studio menus, strings in dialog windows etc.) to specific users. It allows more convenient and use-friendly project development in multi-lingual teams, which develop and maintain a project.

Check box "**Account expires on:**" enables the option to limit the validity period of the entire account. If this check box is unchecked, the account has an unlimited term of validity.

If this check box is enabled, then the period of the user account validity will be limited until the period, defined in the calendar combo box below.

If the user authentication-enabled project is launched either in the studio or in the runtime, a login window will be prompted:



The login window will also appear if a user clicks on the "**Login with different user**" command button in the **User Management** section of the **Project** ribbon icon on the horizontal toolbar either in the Dream Report Designer Studio or Logger Studio menu (see pic. below).

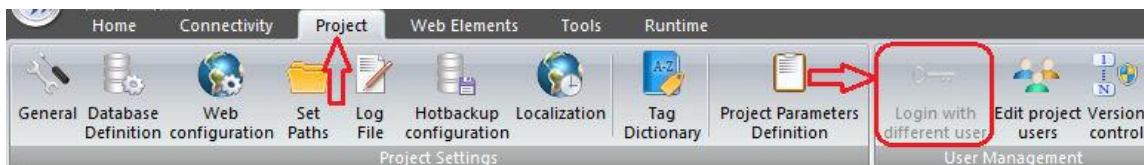

If a user has more than 3 unsuccessful attempts to login to the Dream Report studio, it will be closed automatically.





**NOTE:** Please, remember that *Login with different user* option will become enabled only if the "Enable User Authorization" check box in the **General Project** section is checked.

If a user logs in to the Dream Report studio and has no right to access the designer studio and the logger studio, he has no rights to edit a project and the studio will be closed automatically.

If the runtime manager of such a project is launched, then, each time, when its window is loaded from the system tray and opened, the login dialog window will be shown. If the user login fails, the project will continue to run, but the **Runtime Management Console** window will be immediately closed and placed in the system tray so that the current user will have no access to any control operation.

If a user hasn't entered the login information for the runtime during 1 minute, the login window will be closed automatically, and the runtime window will be minimized to the system tray.

As soon as user properties are done, click on **Add** button and the new user will be added to the list of local users.

When you click on a user in the list, and click on **Delete** button, then the selected user will be deleted. If you select several users in the list, then user name, password and password confirmation edit boxes will be disabled. If you click on **Delete** button, all selected users will be deleted.

If you press on **Delete** button on the keyboard, then one or several selected users in the list will be deleted as well.

### List of Groups

When you add a user group, you just type a new group name in the edit box below the list control, click on **Add** button, and new user group will be added to the list.

When you select one or several users in the list, you can drag and drop selected users to the required group.

When you select any group in the list, it will immediately set selected all the users, defined in that group, in the users list. You can click on any user entry to select/unselect user for the selected group.

### Windows Authentication

This section allows to get users/groups list(s) from Windows and to include those users and user groups into the Dream Report authentication configuration. Below the users list, there is a check box "Use windows authentication". If this check box is not checked, then the button "Configure" will be disabled. As soon as a user enables that check box, the **Configure** button will become enabled, and the standard Windows "Select User or Group" dialog box will be opened:

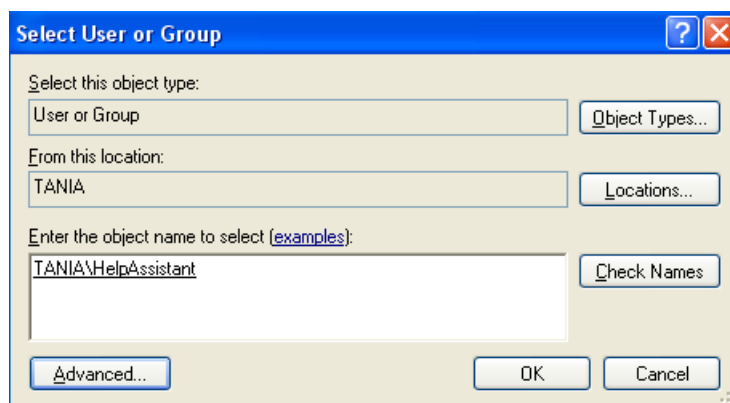

User will have to select Windows users/ groups, their location, and the name.

If the selected name can't be found, or is not typed correctly, then the error message box will pop up, saying that an object with the selected name cannot be found.





## Ocean Data Systems

In this case user can click on the "**Advanced**" button to start advanced Windows user/group selection. The following dialog box will be opened:

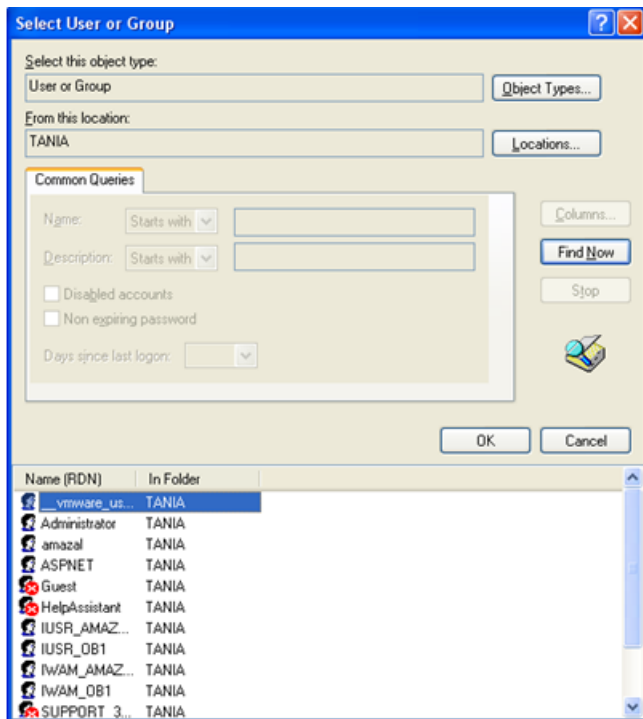

If a user clicks on the "**Find Now**" button, the drop-down list will appear. User will be able to select the relative - distinguished name (RDN) to be added to the list of Users /Groups, and click on **OK**. This name will immediately appear in the object name edit box of the **Select User or Group** dialog box.

Click on **OK**, and the selected Windows user or group will be added to the corresponding list in the **User Management Users and Groups** dialog window.

All selected information will be saved in the **Dream Report User Management database**.



## User/Group Authorization

This functionality enables to assign project report access rights to the user/ user groups selected.

If you click on the **Authorization** tab, the Authorization dialog window section will be opened:

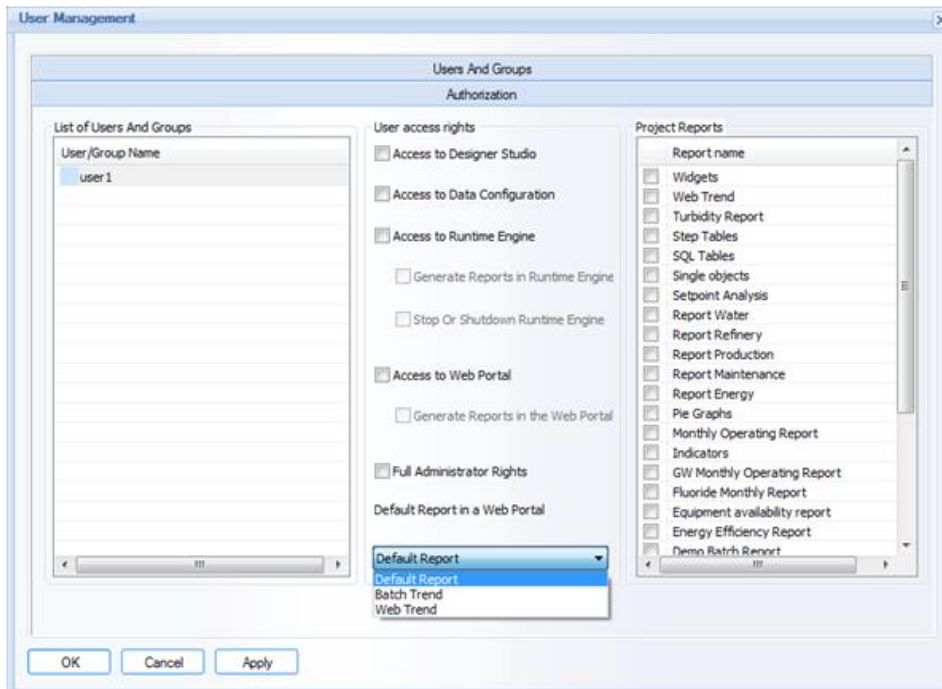

The **List of Users and Groups** will be filled with all local users and groups, defined in Dream Report, as well as with all users and groups from the Windows active directory selection in the **Users and Groups** section.

You can select any user/group and assign its access rights by checking the corresponding check boxes with allowed access rights in the **User access rights** section of this dialog window.

### User Access Rights

**Access to designer studio** defines if the user has a right to access and edit graphical representation of project reports. If this option is switched off, the Designer Studio floating splitter and the same menu option in View menu will be disabled.

**Access to data configuration** defines if the user has rights to access communication and data logging definition sections. If this option is switched off, the Logger studio floating splitter and menu option in View menu, as well as driver definition dialog box access, will be disabled, and user will not be able to edit data communication settings.

**Access to runtime engine** defines if the user has rights to control runtime manager operations. If this option is disabled, the Runtime Management Console dialog box will be unavailable for that user.

**NOTE:** If RMC is password-protected and is minimized (and hidden in the system tray), then, every time user wants to maximize it by double-clicking on the RMC icon in the system tray, RMC will ask for user authorization.

**Access to web portal** defines if the user has a right to access the web portal and browse and generate reports over the web.



## Full Administrator Rights

**Full Administrator Rights** defines if a user has all access rights as well as a right to access to the user definition window to modify existing users and their properties, and create new users. Usually this access is given to project administrators.

If this option is enabled, then, all other check boxes with allowed access rights will automatically become checked, but not allowed for manual editing.

If this option is enabled for a user, then, every time this user logs in the Dream Report Studio, the **Edit project users** command button in the **User Management** section of the **Project** ribbon icon on the horizontal or vertical toolbar will be enabled. And the user will have an access to editing project users in the Dream Report Studio.

Otherwise, this command button will be always disabled.

**NOTE:** Please, always select at least one user, that will have **Full Administrator Rights**. If no user or group has been given the right to have access to the User Definition window in the project, then, on exiting the **User Management** section, the following message box will appear: "**No user with the right to administrate project was defined. Please, define at least one user with an access to User Definition window**". Then, you will have to go back to the **Authorization** section and select at least one user, who will have access to the User Definition window.

You can assign different user rights by selecting one or several users and/or groups from the **List of Users and Groups**, and by checking appropriate check boxes with the corresponding access rights.

Check boxes in the **List of Users and Groups** are not related to user rights, but are related only to access to the reports.

If no report is selected in the **Report name** list of the **Project Reports** section (on the right), then, all check boxes in the **User access rights** list will be disabled.

If you select several users and/or groups at the same time, and check **User access rights** check boxes, then, those check boxes will be assigned to several users.

Also, at the same time, if you select one or several users and/or groups, and they already have access rights defined, then only those access right check boxes will be checked, that are enabled in **all** selected users and/or groups. If some users/groups have access rights, which are not defined in other selected users/groups, then those **User access rights** check boxes will not be checked for this common users selection.

In the real time, when a user makes login, the Dream Report User Management will check if it's Windows user. If yes, then it will verify with Windows Active Directory, which groups this user belongs to, and then will apply the access right.

If a user belongs to different groups, which are defined in the Dream Report User Management, then user rights will be set using maximum (summary) access mode.

**Example:** if a user belongs to the Guest group with access to the Designer studio and also he belongs to the Engineers group, which has an access to the Runtime manager, then, the user, who belongs to those 2 groups, will get access both to the Designer studio and the Runtime manager.

**Default report in a web portal** control provides users a possibility to assign a default report to be opened in a web portal when user logs in to a web portal. If no default report is selected for the user, then when that user will log in to the web portal, a standard Welcome web page will be opened. If the user has default report selected, then when he will log in to the web portal, selected default report page will be opened directly and Welcome web page will be skipped.

By default no default report will be assigned to all users.



## Ocean Data Systems

The **Project Reports** list will be filled with all reports, existing in the actual Dream Report project. When a user selects one or multiple users or groups, he can check the reports, which the selected users and groups will have access to, in the **Report Name** list control (on the right).

**NOTE:** If there are any virtual instances of the reports in the project, then, if a user gets some/ all access rights to any report in this project, he will automatically get the same defined access rights to all the instances of that report.



## Audit Trail

**Audit Trail** module provides ability to log all events from Designer Studio and Runtime into an audit-trail database. The Audit Trail feature is only enabled at Runtime with the Dream Report "Life Sciences" license option.

This functionality will be disabled by default when the new project is opened. Since Audit Trail functionality is related to report Version Control, it will become enabled if a user clicks on the "*Version control*" command button in the **User Management** section of the **Project** ribbon icon on the horizontal toolbar in **Studio** (see pic. below):

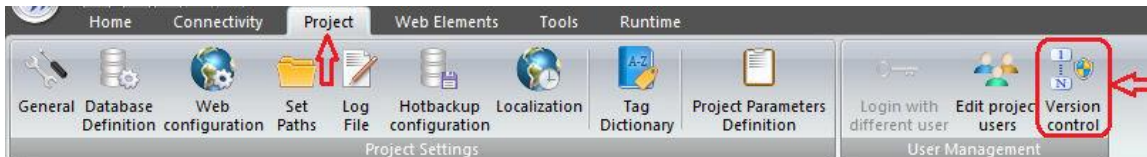

Then the following dialog box will be opened:

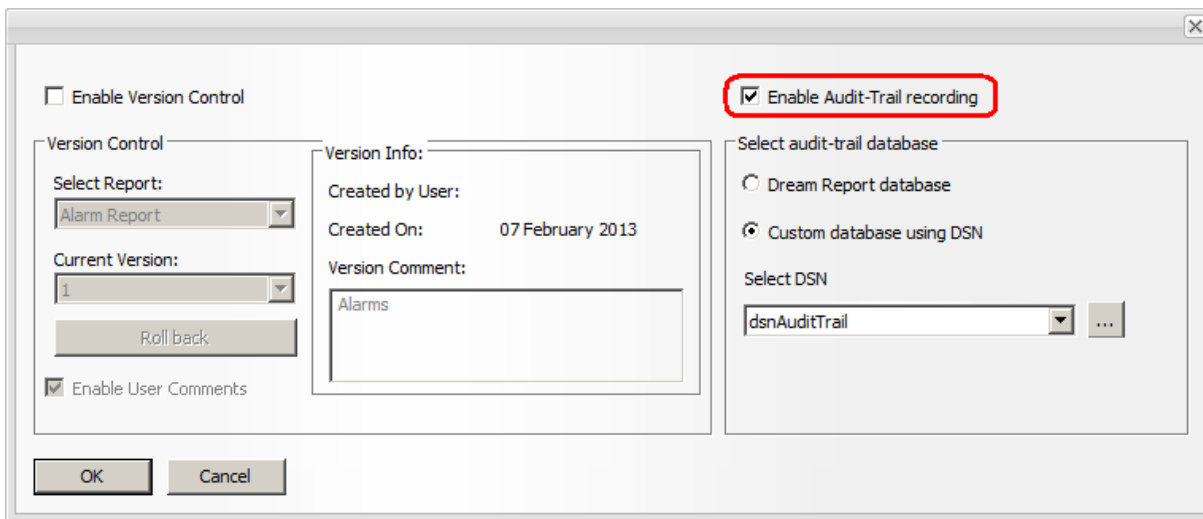

The edit box "**Enable Audit-Trail recording**" will enable or disable the **Audit Trail** functionality.

When enabled, **Select audit-trail database** to choose whether the audit trail will be logged (by default) to the project's **Dream Report database** (defined in the **Project Settings - Database Configuration**), or in a separate database, defined as a **Custom database using DSN**. If a Custom Database is selected, either **Select DSN** from the list of defined data source names, or create a database data source name using the **DSN Manager**.

### Note:

If security is enabled on the selected Audit Trail database, please ensure that the database account used to connect to the database server has both table "Create" and "Insert" permissions enabled.

Click **OK** to close the Enable Audit-Trail recording option.

When the project is next started in Runtime, Dream Report will first check for the existence of the Audit Trail table in the selected database, and if not present, will attempt to create it. Then, any runtime activities will get logged to this table (named **[tOdsAuditTrailEvent]**).



# Report Settings

## Report Settings - General

**Report Settings** is a dialog box where output properties of a report are configured.

To configure report settings, right-click on the report tree in the Report Designer Studio and select **Report Settings** from the context menu:

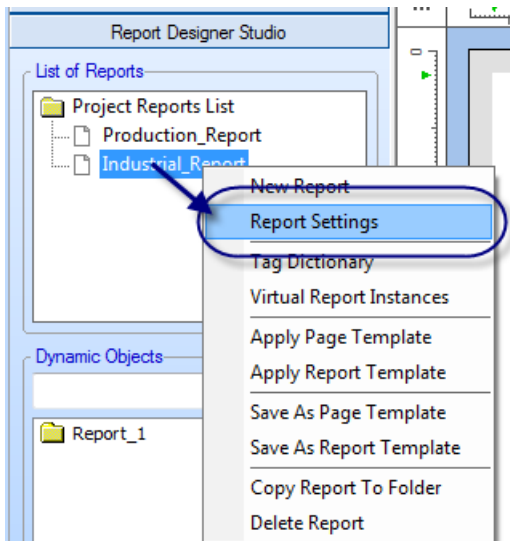



The **Report Settings** dialog window will be

opened:

The left tree contains a list of reports defined in the project. Panels on the right display settings for the selected report in the tree. If the report selection is changed, the panel will be updated with data from the selected report.

The configuration of all reports in the project can be changed in one window without closing and reopening it again. Clicking on another report in the tree in the left part of the dialog window will automatically update a dialog window with settings of the selected report.

The **Report Name** can be any unique logical name. Only alphanumeric characters and spaces can be used, otherwise unexpected problems can be expected. The maximum length of a report name is 64 characters.

The **Description of Report** text box can include a short description for the report. The description can be up to 256 characters.

The **Report storage** section allows you to organize report files - store and maintain them in a more organized way.

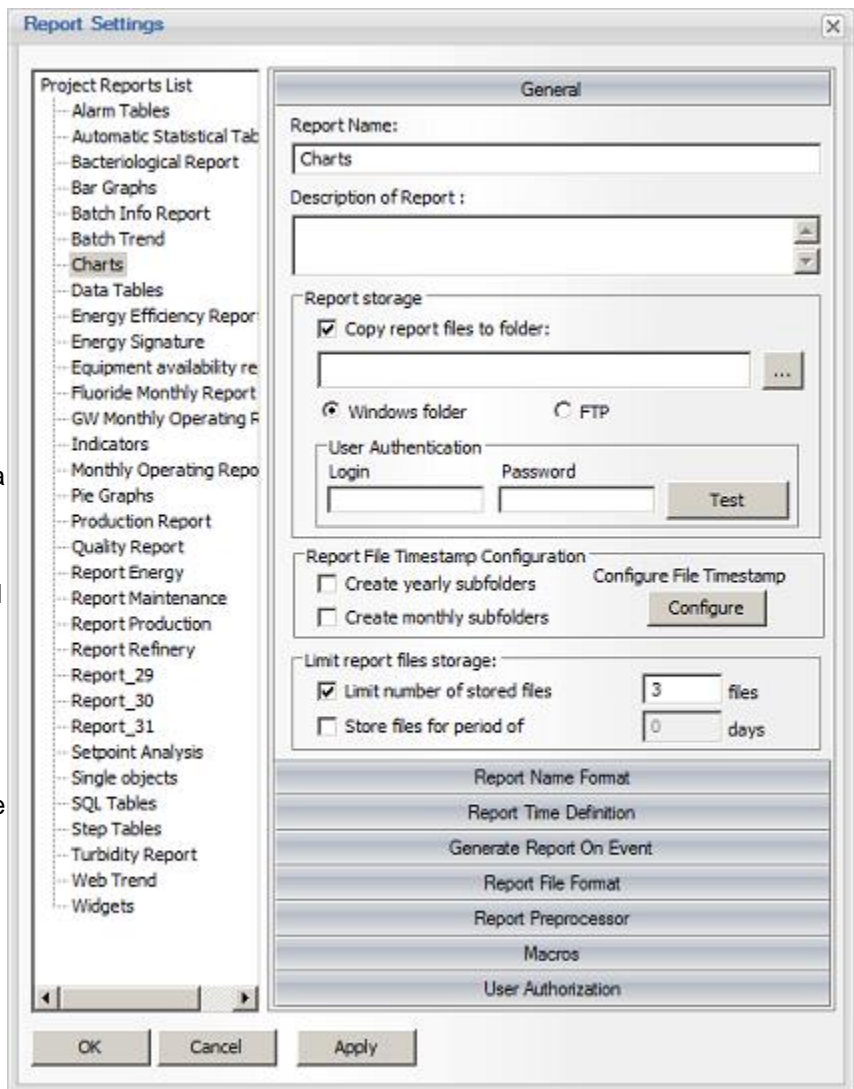

The **Copy report files to report folder** option enables a user to copy generated files from this report to a special location. The path can be absolute or relative to the report path, defined in the **Project Settings** path definition. This option is defined separately for each report.

**NOTE:** If the web option is enabled, then all (PDF and Excel) report files will be copied to an alternative directory, defined in this section of the report settings. PDF files will also be copied to the main report files folder, defined in the **Project Settings**, and will be used for the web portal.

### FTP Upload for Generated Reports

The **Report storage** section also allows to configure uploading generated reports in **PDF**, **Excel** and **CSV** format to a pre-defined FTP server.

“**Windows folder**” option will be always selected by default.

If “**FTP Server**” option will be enabled, Dream Report will upload all reports files, generated by that report template, to the specified FTP server.

By clicking the “**Test**” button user will be able to test connection to the selected Windows folder or FTP server.





"[Limit report files storage](#)" section (described below) will perform its function of limiting archived report files by period or by files number both for the Windows folder and for FTP server.

### Report File Timestamp Configuration

The option **Create yearly subfolders** will automatically create a subfolder for the current calendar year in the format YYYY (e.g."2006"). The folder will be created in the report directory. This option is defined separately for each report.

The option **Create monthly subfolders** will automatically create a subfolder for the current calendar month (e.g."October"). The folder will be created in the report directory. This option is defined separately for each report.

**NOTE:** **Monthly/yearly** subfolders will be created in the report directory only as soon as the first report will be generated and stored in the **Reports** folder. It means that, if you have enabled any of these two options, but have not generated any report so far, there will be no subfolder created in the report directory.

The **Configure File Timestamp** button opens a configuration screen where the user has the ability to set the report file timestamp to be the "[Report Generation Time](#)" (default); "[Report Start Time](#)"; or "[Report End Time](#)":

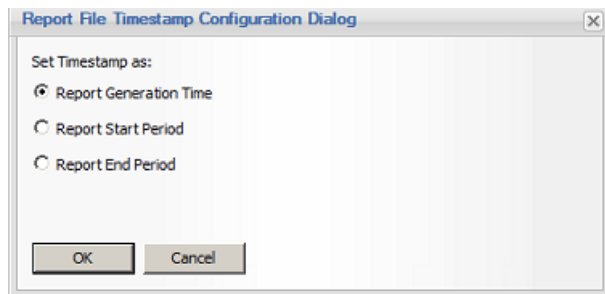

The [Limit report files storage](#) section allows you to control the number of report files saved by Dream Report. This option will be applied to both PDF and Excel report files.

**Limit number of stored files** defines how many files of this report should be stored in the report files directory. If this option will be enabled, then each time a new report is generated, Dream Report will check the number of existing report files. If this limit will be exceeded, the oldest files will be deleted.

**Store files for period of** defines for which period files of this report should be kept in the report files directory. If this option will be enabled, then each time a new report is generated, Dream Report will check the creation date of existing report files and will delete each report created before the defined period.

### Reports Tree Organization

By default all reports will be created and displayed as a report tree.

If a user will right-click below the report list, he will get a new entry in the context menu: [Add New Level](#) (please see the pic. below):

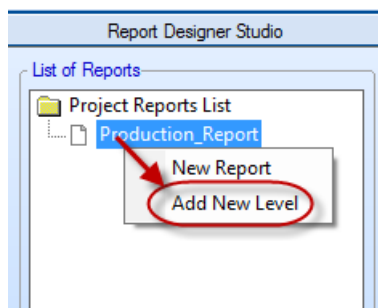

If a user will click on this entry, the [Report Level](#) window will pop up:



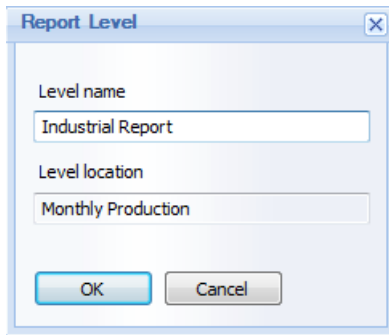

User will have to enter the report level name (**Level name**), location of this report level (**Level location**) and click **OK**. The new report level will be added to the report tree (please see the pic. below):

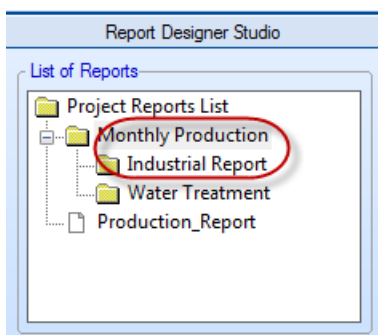

As soon as at least one report level has been defined, a user will be able to rename and delete report levels according to the needs by just right-clicking on the corresponding report level (please see the pic. below):

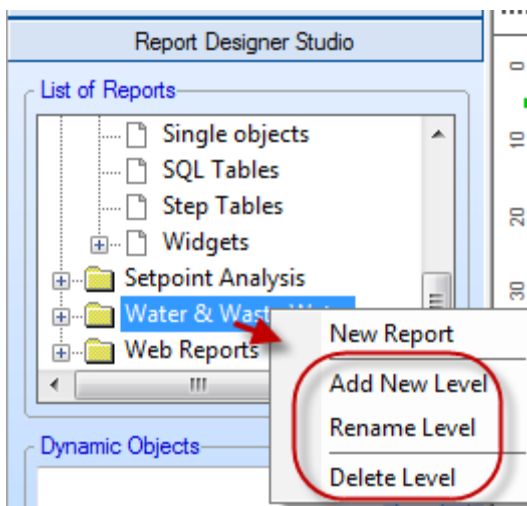

**NOTES:**

- Such report folders organization is just a logical visual representation, which allows users to visually better organize their reports and be able to find/access their reports faster and easier.
- If no report has been defined under the report level, then this report level won't be stored in a project.
- Users can also move reports (if needed) within the report tree from one level to another by just dragging them with a mouse.

**NOTE:** New report can be also configured by clicking on the DR Main Button in the upper left part of the Dream Report Designer Studio (please see the picture below):

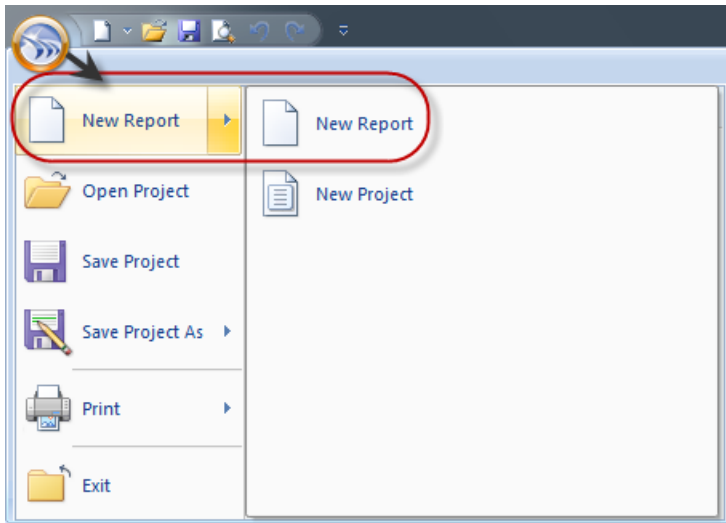



## Report Settings - Report Name Format

The **Report Name Format** dialog box defines how file names for an output file are generated.

The report file naming rule will be applied both to PDF and Excel report files.

The **Report filename mask** can be any combination of 4 types of components.

All components defined in a filename mask should be separated by "+".

The maximum number of characters for filename mask is 256 characters.

The available file name component types are:

- **Static text.** You can enter any text strings in any part of a mask. Each string should be included in "" (e.g. "text"+"my report name")
- **Report/Instance Name.** In this section a user has two options: "Report name" and "Instance name". If the "Report name" menu is selected, then, the following string will be added to the filename mask: [s#ReportName] and, during report generation, it will be replaced by report name. In the "Instance name" menu the following string will be added to the filename mask: [s#InstanceName] and, during report generation, it will be replaced by the report instance name for which this report file was generated.

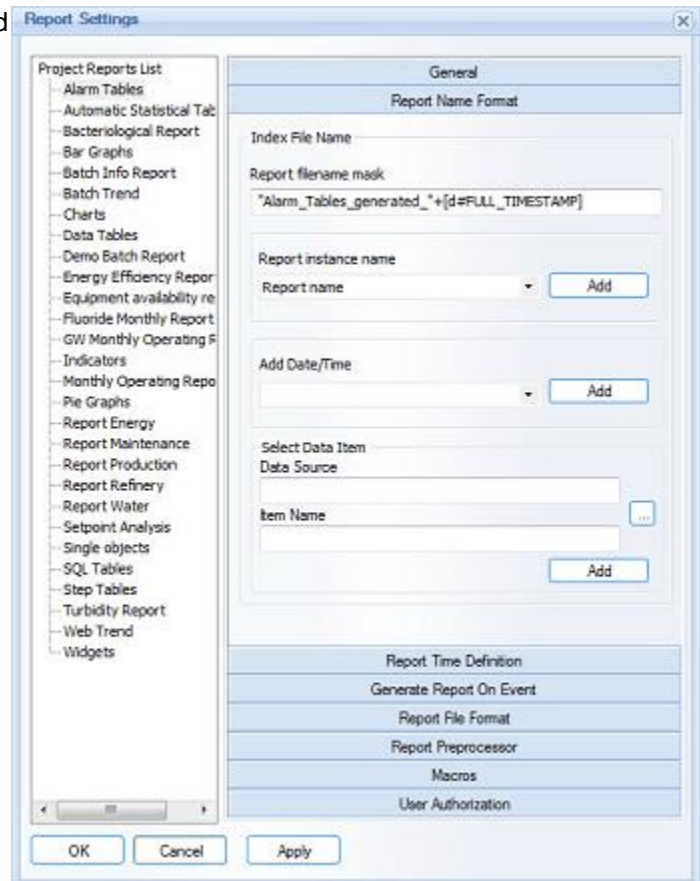

If the file was generated for the generic report template, the string "Default" will be used.

Click **Add** and the component will be added in an appropriate format and the "+" separator will be added automatically.

- **Date/time of file generation in various formats.** Select any format of date/time from the "Add Date/Time" combo box and click on the button "Add". The current value of any tag during report generation can be added as Select Data Item Add the "+" separator will be added automatically. During report generation this component will be replaced by the current value of the selected item.
- The **current value of any tag during report generation** can be added as well. Select the data source and tag in the section "Select Data Item" and click on the "Add" button. The appropriate component will be added to the mask. The "+" separator will be added automatically. During report generation this component will be replaced by the current value of the selected item

You can mix any number of any components in your report filename mask as long as the mask length does not exceed 256 characters. When the length of a filename mask reaches 256 characters, the edit box will automatically stop accepting additional characters.



## Ocean Data Systems

**NOTE:** If a user wants to add the date to the report name, using not the timestamp of the report generation, but applying some offset (i.e. some days back), then the additional tokens: **-XDAYS** or **+XDAYS** can be used (please, see the sample below), where:

- “-“ or “+” is an operator (whether the number of days offset should be added or deducted from the report generation date)
- **X** is the number of days to add or deduct from the report generation date
- **DAYS** is the conventional token word, which will be recognized by the report name mask parser.

Report Name Format

Index File Name

Report filename mask

[s#ReportName]+\_[d#FULL\_TIMESTAMP-2DAYS]

On the picture above the example shows how the additional tokens: **-XDAYS** or **+XDAYS** can be used.

**NOTE:** Please, always check that these tokens should be added to the timestamp format inside the brackets as shown in this example.



## Report Settings - Generation Time Definition

The **Report Time Definition** dialog box allows a user to define an automatic report generation schedule.

The **Report Instances** combo box contains the list of all available virtual instances for this report. It will enable a user to apply and save different generation schedules to different report instances.

You can only enable this box if report instances for this project have already been created. Otherwise this box will be disabled.

For more details on how to create virtual report instances, please, see **Virtual Report Instances** section.

If a user selects the **Report Instances** option, which is set as an original report template, then, the specified time schedule will be applied only to original report template and will not be applied to any of the report instances.

If a user selects any of the report instances created, then "Use Schedule" and "Apply to All" boxes will appear.

If **Apply to All** option is selected, then, the specified schedule will be applied to all instances of this report in the project.

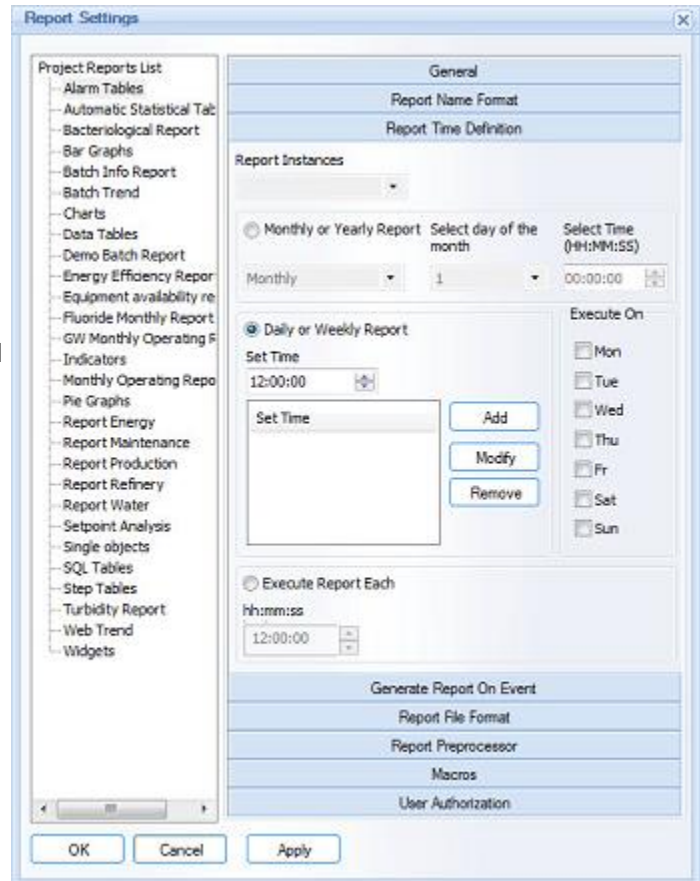

To configure the schedule, enable the "Use Schedule" box.

If there is time schedule, defined for "Apply to All", and there is another time schedule, defined for any other template, then that template will be generated twice: at its own schedule and for "Apply to All" schedule.

All time schedules for every template will be saved inside the report settings structure of that selected report.

If the report generation schedule is defined and a new instance is added, then it will have no generation schedule by default.

There are 2 options available to configure automatic report generation: **generation on schedule** or **cyclic generation**.

### Generation on Schedule

The **Monthly or Yearly Report** option enables users to define a specific time and day of the month or day of the year, when the selected report will be automatically generated.

The left combo box contains two entries: **Monthly** and **Yearly**. Please, select which type of schedule you would like to use.

If **Monthly** option will be selected, then the combo box on the right will be filled with the possible days of the month (1-31). Select which date of every month that selected report will be automatically generated. To the right of date selection, specify the time at which the report will be generated.

**NOTE:** In Monthly option user has two additional parameters: "Every Day" and "Last Day" of the Month.



If **Yearly** option will be selected, then the combo box on the right will display a calendar to select a day of the year for the given report to be generated. Though the calendar will contain the current year, report generation will not be limited to the selected year. Every year the report will be generated at your selected date. To the right of date selection, specify a time at which the report will be generated.

The **Daily or Weekly Report** option enables a user to define a very flexible schedule of report generation one or more times during one specific day or several days of the week.

For this, create a list of schedule records, defining when each report will be generated. The schedule record includes the time (**hh:mm:ss**) and the days of the week. Each scheduler record may contain its own set of days of the week. The report will be generated every day at each defined time, which is enabled in the schedule.

To add a record, enter the desired time in the **Set Time** edit box in the format **hh:mm:ss**, select the desired days of the week and click the **Add** button. The new scheduler record will be added to the scheduler list.

To delete a scheduler record, select a record to be deleted and click the **Remove** button. The selected record will be deleted.

To modify an existing scheduler record, select the record to be modified - the day of the week. The **Set Time** edit box will display the current definition of that scheduler record. Enter the new time in the **Set Time** edit box and selected desired days of the week in the **Execute On** (group of days of the week) check boxes. After editing scheduler record settings is finished, click the **Modify** button. The selected record will be modified with the new settings.

**TIP:** If user wants to disable report generation on schedule, he can remove the **Daily/Weekly** settings by clicking on the **Remove** button (please see the picture below):

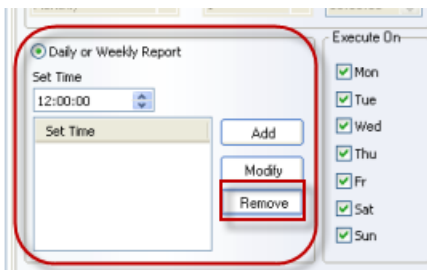

### Cyclic Report Generation

If the **Execute Report Each** option will be selected, then, reports will be generated automatically in a periodical cycle using the period defined in the combo box. The period is entered in the format **hh:mm:ss** .

When defining cyclic generation, it's also influenced by the days of the week. You can define on which days reports will be created.

You can enter any period from 00:00:01 up to 23:59:59.

**! We recommend not scheduling reports more frequently than every 10 minutes.**

**NOTE:** A report cannot be set to have both generation options. A report can be configured to be generated only according to a schedule or in the periodical cycle.



## Report Settings - Generate Report on Event

The **Generate Report on Event** dialog box configures an event-based report generation.

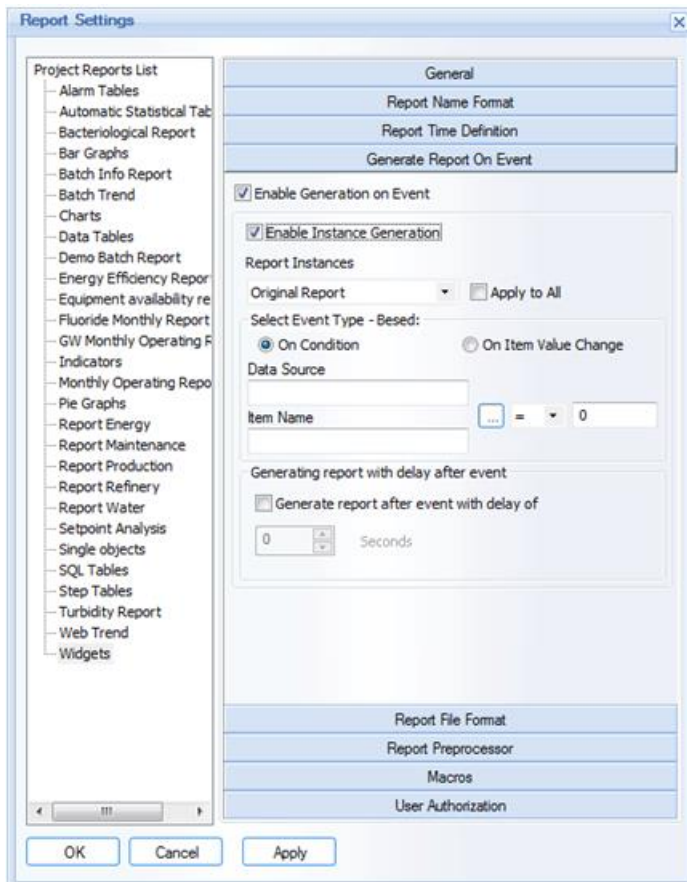

The "**Enable Generation On Event**" check box enables/disables event-based report generation.

If a user enables "**Instance Generation**" check box, he can configure report generation, and, define different generation rules on event for different report instances.

This box can be enabled only if report instances for this project have already been created. Otherwise this box will be disabled.

For more details on how to create virtual report instances, please, see [Virtual Report Instances](#) section.

When the "**Instance Generation**" check box is enabled, select data source, data item, event condition and enter a condition value.

The **Select data source** combo box will be filled with a list of all available sources. After selecting a data source, the combo box **Select Data Item** will be filled with a list of all available items from the selected data source.

The **Condition value** can be any float number in the range from **-65535.00** to **65535.00**.

The symbol "." must be used as the decimal separator.

If the "**Enable Generation on Event**" option is checked and no condition value is specified, or the data source or data item is not specified, the user will get an error message and the report definition will not be complete.

If **On Item Value Change** option was selected, then the window will change configuration controls as follows:



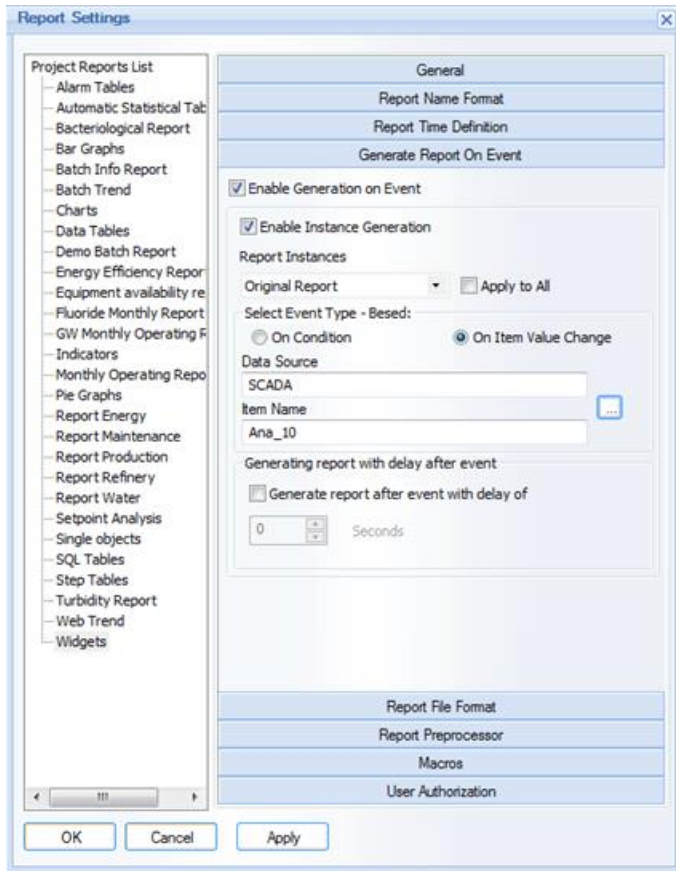

If this option is selected, then every time, when selected data item will change its value, report will be generated. String type data items are supported by that option as well.

User has also a possibility to set a delay to generate report after event has occurred.

If a user checks the "Generate report with delay after event" check box, then, he must set a valid number (from 0 to 86400) of seconds, which runtime will sleep after report generation event has taken place. After the specified period of seconds, the report will be generated.





## Report Settings - Report Output Format

This dialog enables users to configure report output settings, i.e. what format the report will be generated in, and how and to whom it will be distributed.

**Web** option will be enabled only if the current license has web portal option enabled. Otherwise, the Web target option will be by default disabled. If a user currently doesn't have a web portal option but he does enable the **Web** format, a warning message box will be displayed saying that using web portal in a runtime will require web license option enabled.

For details please see [Web Portal](#) section of this manual.

If user has selected web reports format, this allows user to display real-time values (using single data object) and those objects can dynamically change values in real-time. Real-time values update rate can be configured if user will click on "Settings" button, next to "Web" check box:

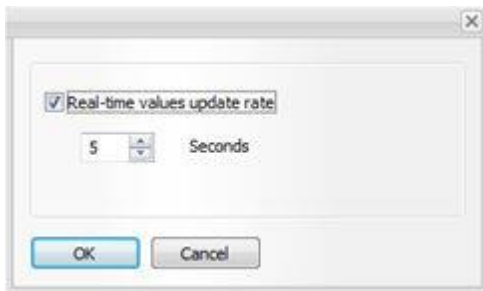

In this window user can enable or disable real-time values update and set the value update rate. By default values real-time update is disabled and if user enables it, then real-time value update default rate is 1 second.

The minimum update rate is 1 second.

If the **.PDF** (Adobe Acrobat) option is checked, then the report will be generated in a file of PDF format, which can be opened and viewed by Adobe Acrobat Reader. We recommend using Adobe Acrobat Reader version 8.0 or higher for the best performance. The report file name will be set based on the Report Name Format section.

If a user clicks on the [Settings](#) button, just below the PDF check box, the **Advanced PDF Security** settings dialog window will be opened. Click **Advanced PDF security** to find more details about this functionality.

When the PDF option is checked, the **Email** check box will be enabled and can be checked as well. This option enables the user to send each generated report file (PDF) to a list of predefined users.

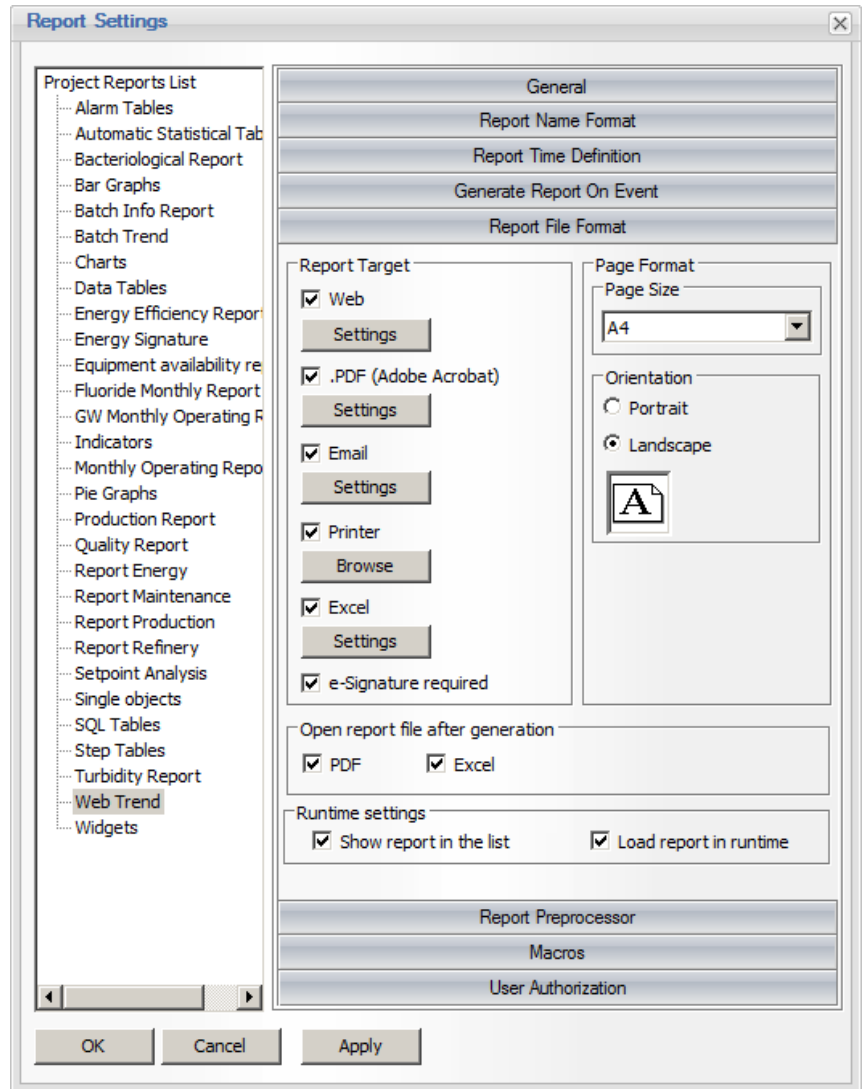



When the **Email** option is checked, click on the **Settings** button to configure the list of email recipients. Configuration of email manager is described in the Email Configuration section.

If a generated report is to be printed, select the **Printer** option.  
To select one or more printers, click the **Browse** button.  
Printer configuration is described in the Printer Selection section.

If you need to export data to **Excel**, enable the "**Excel**" option and click on the "**Settings**" button. It will open the MS\_Excel report layout wizard. In this wizard select the report layout, i.e. what data will be exported to Excel.

If an e-Signature is required for the report to be generated, select the **e-Signature** required option. For additional requirements on configuring electronic signatures, please refer to the section Electronic Signatures.

**Page Format** will set up page size and orientation of the report.

The combo box **Page Size** contains most of the popular standards of page sizes (e.g. A4, US Letter, Legal, A5, B5 and others.)

If the **Portrait** option will be selected, the page will be positioned horizontally.

If the **Landscape** option will be selected, the page will be positioned vertically.

The **Open report file after generation** option allows users to always open reports automatically after generation. This means that each time a report is generated, it will be opened on the local computer. The options **PDF** and/or **Excel** allow users to specify report formats that will be opened automatically.

If a report is generated via the web portal or using the Dynamic Report Generator, it will not be opened automatically.

To open a report in Excel format, MS Excel must be installed, as Excel format reports are opened in MS Excel environment. To open a report in PDF format, Adobe Acrobat (PDF) Reader has to be installed.

The **Runtime settings** section contains 2 options for use and display of that given report in a runtime:

- The option **Show report in the list** will define if that given report will be listed in the list of reports in a runtime management console (RMC) and in a web portal.  
If this option is enabled - the report will be loaded in the runtime engine and will be displayed in the report list, together with all other reports.  
If this option is unchecked, that the report will be loaded in the runtime engine, but will be not displayed in the list of reports neither in runtime console (RMC), nor in dynamic report generator (DRG), nor in a web portal. However, that report will be running in the project and will perform, what is has to do - it will be just hidden and excluded from runtime reports display list.  
This option can be useful for so-called "fake reports", where report is done for some internal calculations, but is not intended to be generated as the final result report and therefore end users don't have to see it in the list.  
By default, the option "*Show report in the list*" is enabled for all new reports.
- The option **Load report in runtime** will define if that given report will be loaded in the runtime engine and will be running in the project in the runtime with all the other reports.  
If this option is enabled - the report will be loaded in the runtime engine. It will be running with all the other reports and will execute all what has to be executed.  
If this option is unchecked, that the report will be not loaded in the runtime engine. It will be just skipped on loading the project. So, that in designer studio it will be always presented, but in runtime it will be ignored.  
This option can be useful for reports, which are still in development or which are not required at the moment. So, a user doesn't need to delete them from the project - that report can be still the part of the project, but will be not loaded in runtime and users can switch it on back to the project when needed.



## Report Settings - Excel Reports

**Dream Report** allows users to generate report files in **PDF** and **MS Excel** formats. If a user enables the "**Excel**" option, then the Excel format for that report will be enabled. The layout, which will be exported to Excel, has to be defined separately from the layout for PDF.

**NOTE:** Dream Report Excel export module will also allow exporting report data to CSV format (for details, please see the "**CSV Report Format**" section below).

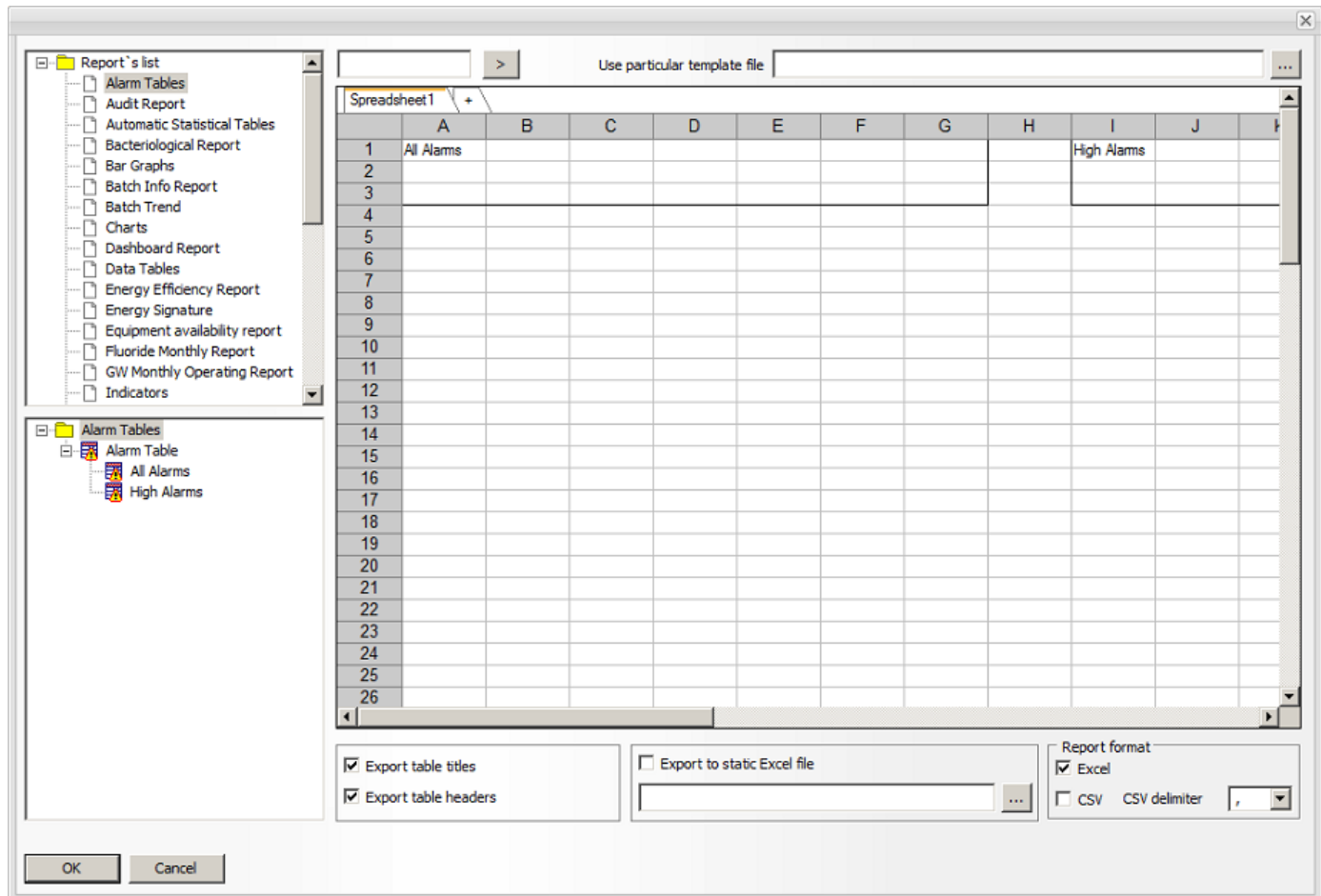

In order to define Excel format, click on the "**Excel Settings**" button in the "**Report File Format**" section of Report Settings. The **Excel Wizard** will be opened (please see the picture below):

All static text, background color, imported bitmap images, graphic images, cannot be exported to the Excel file.

Dream Report enables export of only non-graphic data objects:

- **Single data objects**
- **Compound objects**
- **Expression objects**
- **Item tables**
- **Alarm tables**
- **Step tables**
- **SQL tables.**



To add an object to an Excel spreadsheet, first, select the desired report from the report list on the top-left part of the wizard. Then select the desired object from the left-bottom part with a mouse left-click and place the selected object in the desired cell in the Excel Wizard with a mouse right-click.

**NOTE:** A table object in a report must have a [Table Name](#) specified if it will be used in an Excel-format report output. If not, the table will not be available to select in the Excel configuration. However, the table name does not necessarily need to be displayed in the object:

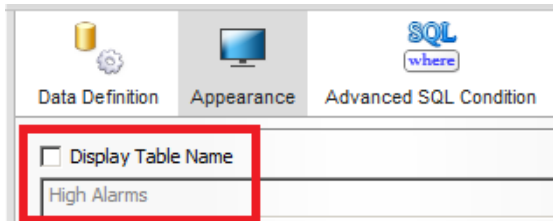

To delete an object from an Excel wizard cell, select an object in the wizard cell and press the [Delete](#) button.

To move an object within the Excel Wizard to another cell, select an object in a cell with a mouse left-click and then right-click on a new place, where the selected object is to be placed. The object will be automatically placed there. The **"Export Table Titles"** and **"Export Table Headers"** options define the export mode of the table objects.

## CSV Report Format

The [Report Format](#) section allows to export report data to \*.xls or \*.xlsx and/or CSV format. It has 2 check boxes: **"Excel"** and **"CSV"**.

By default **"Excel"** check box is checked and **"CSV"** check box is unchecked.

If **"Excel"** option is checked, then the report will be generated in Excel format.

If **"CSV"** option is checked, the report will be generated using the same name as in Excel format, but will have **".csv"** extension.

Both report file formats - **"Excel"** and **"CSV"** - will be available for report generation.

All values will be recorded in a regular text file instead of Excel format with a separator taken from the operating system. The default separator (**"CSV delimiter"**) will be **","**.

## Search a cell

The number of cells displayed in the Excel Wizard dialog windows is limited to 100,000 cells in either direction. To select any cell you may type the cell address (e.g. A100) in the edit box in the top left part of the dialog window (next to the report list) and click on the button with the arrow (>). Then the required cell will be selected.

The [Export Table Titles](#) option controls if the title of the exported table will be exported into Excel or not. If this option will be enabled, the title will be exported as a plain text - the font size, style, title background color will not be exported.

The [Export Table Headers](#) option defines if a table header will be exported into Excel or not. If this option is enabled, the table header will be exported as a plain text. Header font size, style, header background color will not be exported.

The option [Export to static Excel file](#) enables users to export one or more reports to an existing Excel file rather than creating a new file each time the report is executed. This gives users the option to export several reports into the same Excel spreadsheet and create consolidated reports in the same Excel file.



## Ocean Data Systems

**Template selection.** Dream Report enables selection of a specific pre-formatted Excel file template for specific reports. If you wish to use an Excel file template for the specific report, select your report in the list and then select your Excel file template in the edit box "[Use particular template file](#)" in the top right part of the Excel Configuration Wizard dialog window.

### Useful tips:

- When exporting data into an Excel file and creating new Excel report files, Dream Report will copy a template Excel file from a folder "Untitled" in the Project folder of Dream Report installation - **template.xls** file. If you wish to generate custom Excel reports in pre-formatted Excel files, you can format the template.xls file and Dream Report will always use it each time to generate Excel reports.
- When adding objects to an Excel spreadsheet, objects are listed in the object tree by their logical names. To see tables in that object tree, one must specify table names by definition, even if the table name is hidden in an object itself.
- Users, that plan to work based on the Excel template which includes some logical operations or macros, have to ensure that MS Excel is installed on the PC where the project is running.



## Report Settings - Email Configuration

The "Email" dialog box allows configuring all settings, related to the email server, and to setup a list of email recipients, who will receive emails with generated report files.

The Email server login information and the mail recipient list will be saved globally for your project, but the list of the selected mail recipients will be saved for each report separately.

The Dream Report email engine can send emails via any SMTP (Simple Mail Transfer Protocol) server.

To send automatic emails, you need to have only a network connection and properly set SMTP attributes. No additional email software (e.g. MS Outlook) is needed.

In the **Mail server login information** section you need to specify your SMTP server login information:

**SMTP Server:** specify the address of your SMTP server. If you use Internet email service, that information is usually specified at the email provider web site.

**User name:** specify user name to your email account

**Password:** specify password to your email account

**SSL** check box will enable/disable sending emails using SSL (Security Socket Layer) protocol, which is required by some Internet email services (e.g. gmail).

Also, if you need to send emails from a specific TCP/IP port, you can specify your port as addition to the SMTP server address string after symbol (e.g. **smtp.gmail.com:5** - will mean that emails will be sent over TCP/IP port 5).

**Email sender:** Specify the name of your email account. It should be specified exactly as defined in your account. Some email servers may reject sending emails, if this is specified differently.

In the **Email subject** specify which subject will be applied for every email. This option is set for every report separately.

The list below contains a list of mail recipients, who can be selected to send generated report files to.

The check box, on the left from every contact, indicates if that contact is selected to be recipient of this particular report or not.

Double-clicking on any contact in the list will open a dialog box where that contact information can be edited.

The contact list can be imported from an ASCII file to simplify configuring distribution lists. To do that, manually create an ASCII file with the list of contacts, containing the contact alias and email address and click the **Import** button. After that user can browse for an ASCII file, select it and the email recipient list will be imported.

Alias	Email Address
<input checked="" type="checkbox"/> Senior Project Engineer	senior@company.com
<input checked="" type="checkbox"/> Technical Support Engineer	support@company.com
<input checked="" type="checkbox"/> Production Manager	pmanager@company.com



## Ocean Data Systems

To add an email contact manually, click on the [Add](#) button and the [Add Email Contact](#) dialog box will be opened:

A screenshot of the 'Add Email Contact' dialog box. It has a light blue header and a white body. The 'Alias' field contains 'Production Manager'. The 'Email Address' field contains 'pmanager@company.com'. At the bottom, there are two buttons: 'OK' and 'Cancel'.

In the [Alias](#) field, fill in the recipient alias (name or title).

In the [Email Address](#) field, enter the recipient email address.

**NOTE:** Emails will be generated and delivered only during automatic report generation (according to the generation schedule - on time or on event - as defined in the "[Report Time Definition](#)" / "[Generate report on event](#)" sections of the Report Settings).

If you need to send/deliver emails with generated reports where the data has been entered manually/on demand, please enable the Email check box in the User Reports Targets section of the [Dynamic Report Generator](#) in runtime.



## Report Settings - Printer Selection

Each separate report can be printed on a separate list of printers, which enables the most efficient report distribution.

If a user clicks on the [Browse](#) button below the **Printer** check box in the [Report File Format](#) dialog box, the **Printer Configuration** window will be opened:

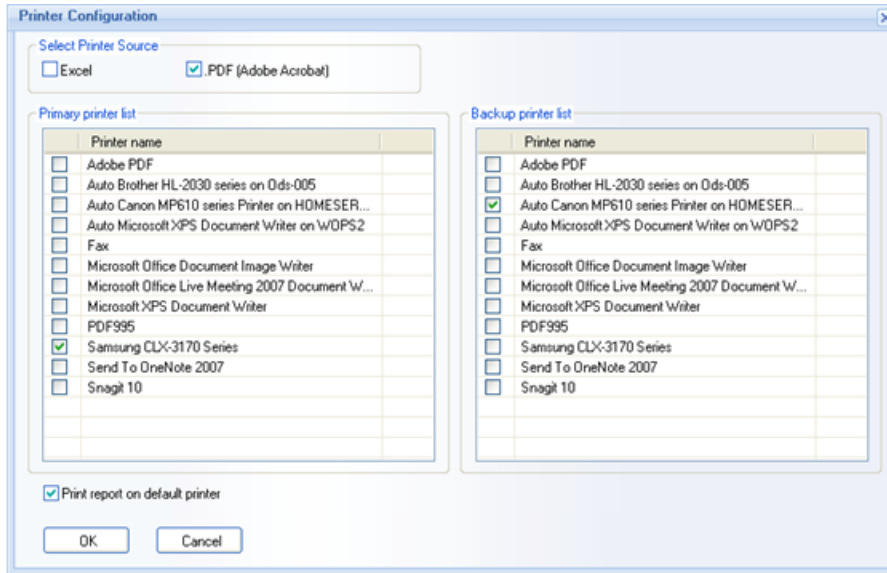

User can select one or several printers, where each report will be printed each time it is generated.

The [Paper size and orientation](#) (portrait or landscape) will be taken from the Report File Format section of the [Report Settings](#) window.

The options "Excel" and "PDF" enable you to specify which formats of result report you wish to print: the report in PDF format or/and the report in Excel format.

There is no limitation regarding printer type or manufacturer.

The [Primary printer list](#) defines the main list of printers, on which report will be printed. One or multiple printers can be selected. Active printer for the report printing will be the one, which check box is checked.

Each main printer may have one backup printer. To define the backup printer, you have to select a printer in the [Primary printer list](#) (not to select the check box, but to select the printer, to make it highlight), and then select one printer in the [Backup printer list](#) (selecting its check box).

Both printer lists are populated with all printer definitions, available in Windows (both local and remote ones).

The option [Print report on default printer](#) enables printing report on the printer, which is currently defined as default on that computer. If this option is enabled, then, copying that project to another computer will make it work (able to print reports) without re-configuring printer definitions.





## Report Preprocessor

The **Report Preprocessor** dialog box enables users to perform an action (SQL query or stored procedure) before report generation using input parameters, and use the result as an input for report, e.g. as a list of tags.

**Report Preprocessor** is a database command (SQL query or stored procedure), which will be performed before report generation. The result of that command can be used for further report generation.

First, in the **ODBC Data Source** section define the external server for getting data from (please, see the picture below):

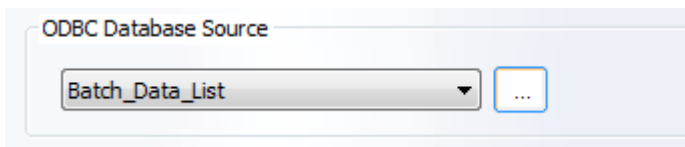

**NOTE:** All DSNs defined in the project are saved and can be managed from one place (for details, please see the **DSN Manager** section of this manual).

Then **enter the SQL Query data** (for more details, please, see **Single Data Object** or **SQL Table** section).

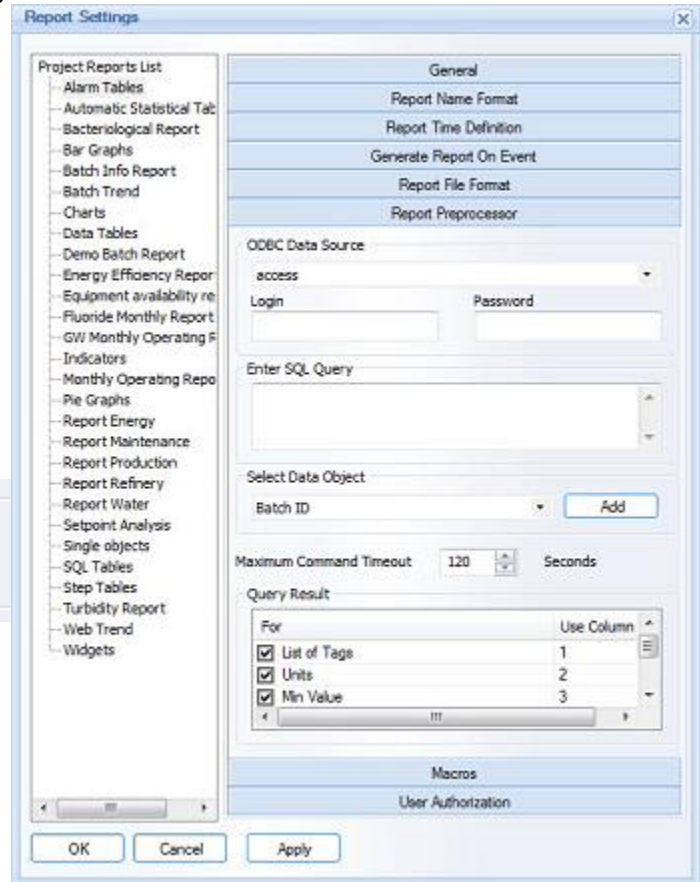

In the **“Select Data Object”** combo box you can only select data objects from the preset list of the following 4 objects available: **“Batch ID”**, **“Report start time”**, **“Report end time”** and **“Input parameter from file”**. If a user adds any of those objects to the SQL query (or stored procedure) statement, by clicking **Add** button, then, when launching before report generation, it will replace those dynamic objects by the corresponding real value.

All values for **“Batch ID”**, **“Report start time”** or **“Report end time”** will be accepted only via Dynamic Report Generator. If a report is generated by schedule or event and not by DRG, then, those input parameters will be empty.

If you select the **“Input parameter from file”** option, please, see the corresponding section below.

**NOTE:** The following dynamic tokens can be used in Report Preprocessor:

**[gen#BatchId]** - This dynamic token will be replaced by ID of the batch (Batch ID) for which the report is generated.

**[gen#ReportStartTime]** - This dynamic token will be replaced by **Report Start Time** as configured in the **dynamic generation** settings.

**[gen#ReportEndTime]** - This dynamic token will be replaced by **Report End Time** as configured in the **dynamic generation** settings.

**[file#<file\_name>#<param\_name>]** - This dynamic token will be replaced by the parameter value that will be found in the specified **<file\_name>**. The file has to have a special format in order to be used in Report Preprocessor. The special file format is:



```
<ods_rpp_document ver = "1.00">  
  
  <ods_rpp_param_list>  
  
    <ods_rpp_param name = "param1" value = "value1"/>  
    <ods_rpp_param name = "param2" value = "value2"/>  
    <ods_rpp_param name = "param3" value = "value3"/>  
  
  </ods_rpp_param_list>  
  
</ods_rpp_document>
```

**NOTE:** For details on the dynamic tokens, used in Dream Report, please see the [List of Dynamic Tokens](#).

The **Query Result** section defines how the result of the SQL command will influence report generation.

There are 4 possible options here:

**Option 1. List of tags.** If this option is checked, then, the content of the specified column of the SQL query result will be considered as a tag list for report objects. If this option is unchecked, then all other three options below will be unchecked automatically. Three options below make sense only in connection with the tag list.

**Option 2. Units.** If this option is checked, then, the content of the specified column of the SQL query result will be considered as a unit for the corresponding tag from received tag list.

**Option 3. Minimum value.** If this option is checked, then, the content of the specified column of the SQL query result will be considered as a minimum value for the corresponding tag from the received tag list. This minimum value will be used for a chart Y scale setting for that tag.

**Option 4. Maximum value.** If this option is checked, then, the content of the specified column of the SQL query result will be considered as a maximum value for the corresponding tag from the received tag list. This maximum value will be used for a chart Y scale setting for that tag.

If all check boxes in **“Query result”** are unchecked, then, the SQL command will be executed and its result will be ignored. This case can be used to prepare data before report generation.

**NOTE.** SQL Command will be executed in synchronous mode with report generation. Report will start generation only after execution of the SQL command. In the **Maximum Command Timeout** edit box define the maximum waiting timeout. If this timeout is expired, the report will start generation without waiting for the preprocessor results and they will be ignored, i.e., the report will be generated, using its original configuration.

If report has any macros, define it before report generation. Anyway, the **“Report preprocessor”** command will be generated before macros.

### Input Parameter from File

If a user selects the **“Input parameter from file”** option and clicks on **“Add”** button, then, **Input parameter from XML file** dialog window will be opened (see pic. below):

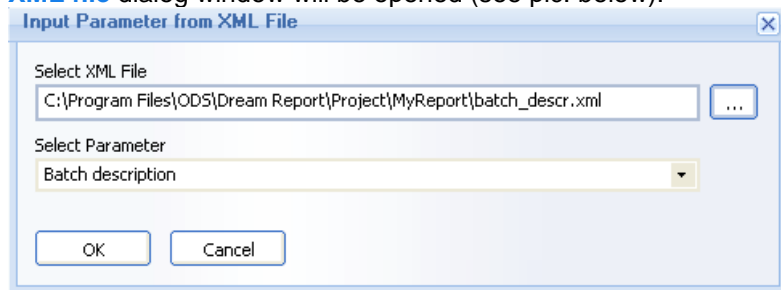



## Ocean Data Systems

Enter parameter name and select an **XML file** or enter an **XML file name**.

Report Preprocessor will try to open the specified XML file, read it and look for the specified parameter.

If the file has been found, Report Preprocessor will read its value and use as an input parameter for report generation.

When custom input parameter is added to the SQL command edit box, it will be added in the format:

[file#<filename>#<parameter name>]

e.g. [file#C:\Batch\Report\_gen.xml#Dataset name]

## REPORT PREPROCESSOR APPLICATION

Items can be replaced in the following objects: *Charts*, *Automatic Statistical Tables*, *Item Tables*.

### Charts

- When replacing items, each line will be added in the order of its retrieval from the database.
- Data source will **NOT** be replaced. New dynamic items will have the same data source as originally defined in a chart. If a chart has several data sources for different lines, then, the first one (defined for the first line) will be considered as the correct data source.
- When replacing the existing lines, each new line will take the corresponding color of a replacing line. E.g. If chart definition has three lines defined with item A (red), item B (blue) and item C (green), and, if two lines come from a database by preprocessor, then, those two lines will take colors red and blue (in the order of their retrieval from a database). If new lines are more than ones in the existing chart definition, then all lines, exceeding the original number, will take default colors.
- Each such an item name will be automatically added to the legend, so a user will automatically see which item corresponds to which color.
- If original chart definition has separate line settings (e.g. time, scale settings) for different lines, then, the line setting of the first line in a chart will be taken as a default one for all dynamic lines.
- If there is any line, defined on “**Absolute**” or “**Golden batch**”, it will **NOT** be replaced and will stay in addition to all dynamic lines.
- Time definitions and all other settings will have no change – **ONLY** data items will be dynamically replaced.

### Automatic Statistical Table

Automatic Statistical Table will take all statistical functions, defined in the table and apply it for all items, supplied by preprocessor. All settings (SQC, AVC) from the first item in the table will be used. Also, the data source from the first item will be used as the right one.

### Item Tables

In Item tables all originally defined items will be replaced by the new ones. The data source will remain the same. If an Item table contains several data sources, then, the one from the first data item will be considered as the correct one.



## Report Settings - Macros

This option enables users to define and attach a list of **macros** to each report separately and run it when the report is generated or on event.

A macro can be one of two types: **an SQL macro** or **a shell command (command line)**.

To add a macro to a list:

- Specify a unique logical **Macro name** to associate with the macro.
- Select macro type: **SQL Macro** or **Shell command**
- Enter Macro itself.

If the macro type is a **Shell command** enter the command line.

If the macro type is **SQL macro**, enter the name of SQL stored procedure defined in a database associated with the Dream Report project. The format for the SQL stored procedure is:

**DSN=DSN\_Name:Macro\_Name**

If the DSN is password protected, then the syntax of a macro will be:

**DSN=DSN\_Name;UID=login;PWD=password:Macro\_Name**

If the macro type is **Microsoft Access Macro**, please, enable radio button **SQL Macro**, enter the name and the format:

**MACC:"D:\Folder\_Path\DB\_Name.mdb":Macro\_Name**

**Example:** *MACC:"C:\Program files\ODS\Dream Report\Project\Energy report\Database\Energy report.mdb":Restore*

As soon as you have specified a macro, choose the execution mode. The execution mode is applied to each macro separately and not globally to the entire macro list.

If the execute **before report generation** option will be selected, the macro will be executed before each report is processed. However, the report generation will not wait until the macro execution is completed. The macro will be executed asynchronously.

If the execute **after report generation** option will be selected, the macro will be executed each time after the report is processed.

If the execute **On Event** option is selected, specify a macro event condition: source item and the condition itself. The condition value must be a numeric value.

Each time the item value meets the defined condition, the macro will be executed. This option is independent of report generation.

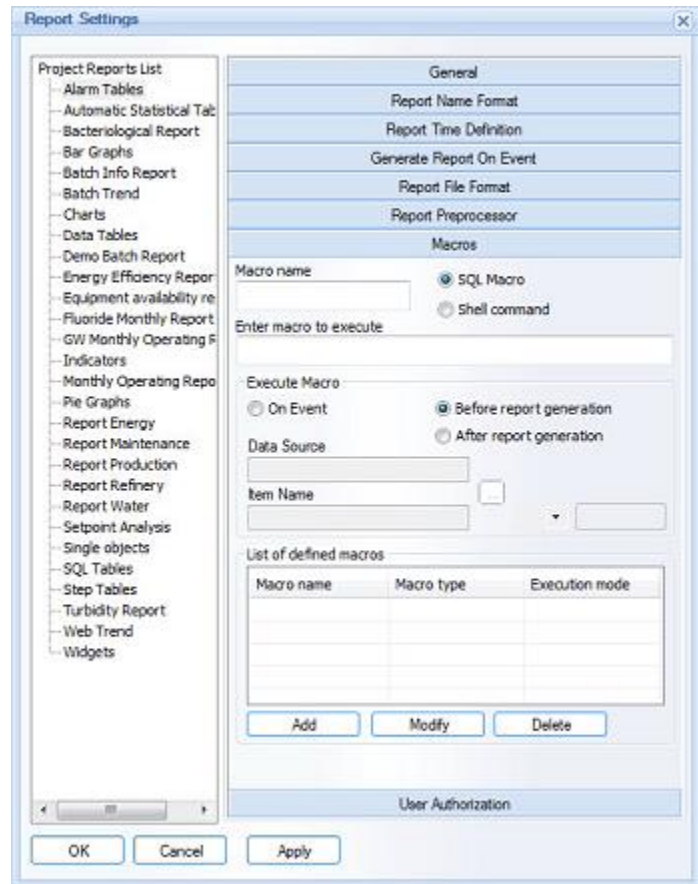



## Report Settings - User Authorization

This window enables you to define access rights to each specific report for specific users/groups.

This option is also applied for the Runtime Manager and in the Web Portal.

If user management is defined in the project, then you have to specify which users are authorized to have access to each report.

Authorized access to a report means that this user will see that report in the list of reports in the Runtime Management Console window, will be able to select and generate that report, open the PDF file for this report and enable/disable automatic report generation.

If a user is not authorized to have access to a report (i.e. in the "User Authorization" section of this report settings, a check box of that user is unchecked), then after making login to the Runtime manager or to the Web Portal, that unauthorized report will not be displayed in the list of reports. It will be hidden from unauthorized users.

The **List of defined users**, displayed in this section, is a global project list, defined in the **Authorization** dialog window, and is described in details in the User Management section.

If you delete any user from the project **List of Users and Groups** in the **Authorization** dialog window of the **User Management** dialog box, then, it will be automatically removed from the **List of defined users** in the **User Authorization** section described here.

If you add a new user to the global project **List of Users and Groups**, it will be automatically added to the **List of defined users** in the **User Authorization** section, described here, and will be unselected. All users are unselected (unauthorized) by default for all reports, unless you select (authorize) them.

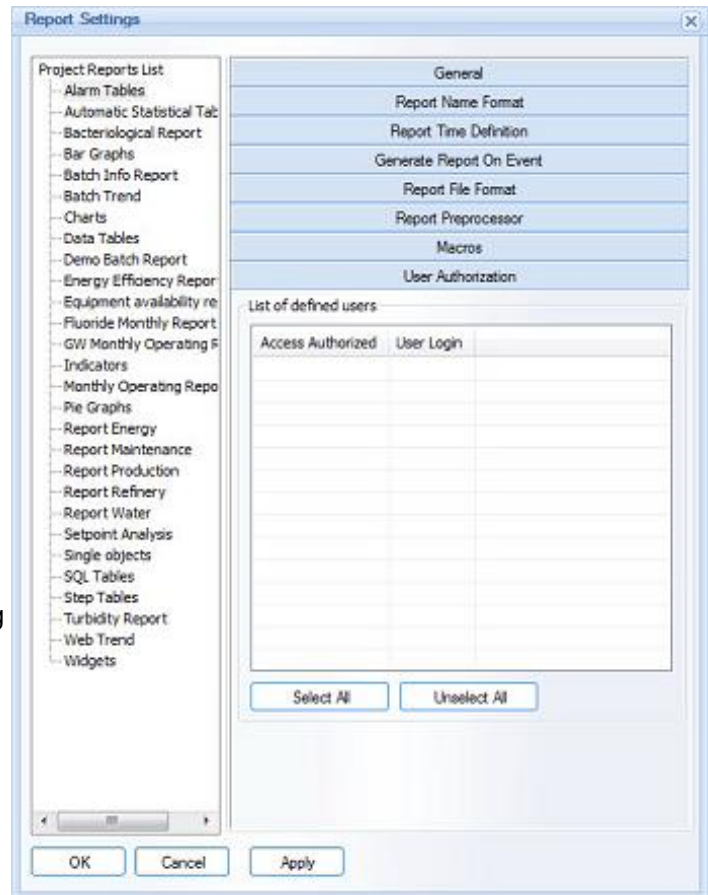



## Report Settings - Advanced PDF Security

Users have a possibility to increase security of PDF reports, created by Dream Report by activating and configuring **Advanced PDF Security**. Click on the button *Settings* just below the **PDF** check box in *Report Settings -->Report File Format -->Report Target* window. The following dialog window will be opened:

The dialog window titled "Advanced PDF Security" contains the following elements:

- Activate PDF Security
- Insert Password: [password field]
- Insert Owner Password: [password field]
- Confirm Password: [password field]
- Confirm Owner Password: [password field]
- Encryption Level:
  - 40 Bit Encryption
  - 128 Bit Encryption
- Permission:
  - No Printing
  - No Changing Document
  - No Copying or Extraction
  - No Adding or Changing Form Fields
- Buttons: OK, Cancel

When a user checks the **Activate PDF Security** check box, all dialog window controls will become enabled.

PDF security configuration dialog provides two passwords: *User Password* to open/read the PDF document and *Owner Password*. This will allow users to change the preset permissions to allow printing, editing and copying pdf document content.

Users must also select the encryption mode in the **Encryption Level** section. There are 2 encryption modes available: **40 bit** and **128 bit**. When this mode option is selected, all generated PDF reports will be generated using the selected encryption mode.

**Permissions** determine which kind of access the user will get while opening the PDF document. There are 4 options available: **No Printing**, **No Changing Document**, **No Copying or Extraction** and **No Adding or Changing Form Fields**. Using these permissions you can prohibit users from printing and using cut and paste operations.

To disable encryption, permission and password protection, uncheck the "**Activate PDF Security**" check box.





# Logger Configuration Studio

## Logger Studio Overview

**Logger studio** is a user interface to configure all data communication and logging.

Logger studio is split vertically into two parts: the upper part is data communication and logging definition and the bottom part is alarm communication and logging definition.

To establish communication, select the appropriate communication drivers. Detailed explanation of data source definition is described in the Communication Driver Definition chapter.

The top left list box contains a list of all data items groups for data logging. A detailed explanation of data item group definition is in the Item Group chapter.

The upper list control shows the items from your selected source or selected group. You can define which list of items you would like to see using combo boxes above this list control. The left combo box allows you to select **Item List by Data Source**. Then, the right combo box will be filled with a list of available data sources, defined in a project and the configured source, the item list will be filled with the list of items from that data source. If you will select **Item List by Group**, the right combo box will be filled with a list of item groups defined in a project and selecting a group will list the items from that group.

The lower left part contains a list of all alarm logging groups defined in a project. Detailed explanation of data alarm group definition is described in the Alarm Group Definition chapter.

If you right-click on the **item list header**, a popup menu will appear where you can select which columns to show:

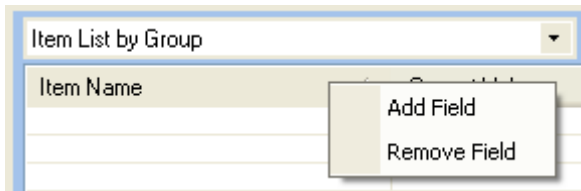

If you will select **Remove Field**, the selected column will be removed from the list. If you will select **Add Field**, then the column definition dialog will be opened, where you can select which columns you would like to add:

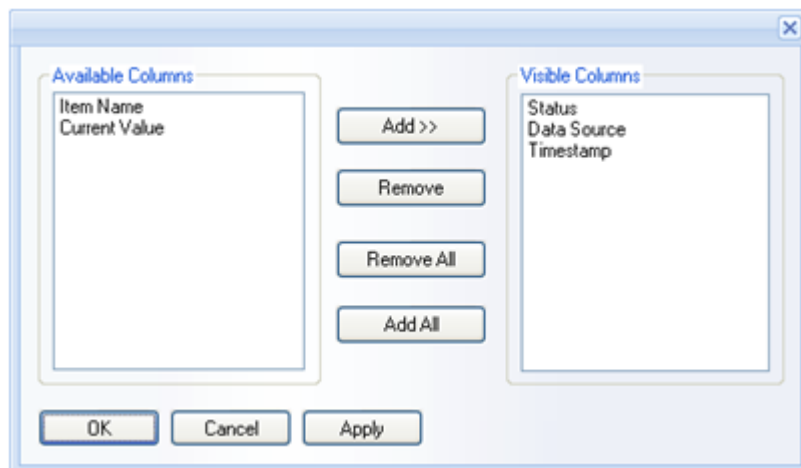



## Ocean Data Systems

The available columns for the item list header can be: **Item Name**, **Current Value**, **Status**, **Data Source**, **Timestamp**.

There are 2 options in the Logger Studio which allow to manage the process of data logging: **Start Monitoring** and **Force Read** (as shown below):

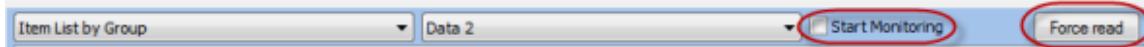

If **Start Monitoring** check box is checked, then the whole process of data logging (data logging value changes, status, timestamp) can be monitored, or controlled.

If **Force Read** button is clicked, then the current status details of the data item logging (current value, status and timestamp) will be displayed, i.e. you will see the logging status details, but you won't be able to observe and control the process of data logging (as with "**Start Monitoring**" option).

By default, when Logger Studio is opened, both options will be disabled.

**NOTE:** By clicking on the DR Main Button in the Dream Report Logger Studio users can perform only some of the operations (enabled in the DR Logger Studio) with projects and reports, such as:

- open any existing project;
- save the current project;
- exit the Studio (with the current project opened):

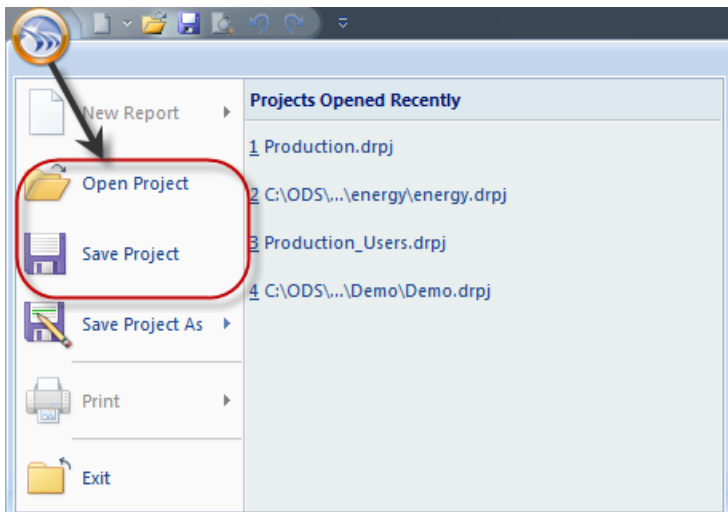





# Communication Driver Configuration

To connect to any data source and acquire live data, alarms or access its history, a user has to select an appropriate communication driver.

Each communication driver is configured via "**Communication Configuration Wizard**" dialog box, which can be opened either from the Logger Studio or from the Report Designer Studio menu. Click on the command button "**Driver Configuration**" either on the **Connectivity** ribbon icon or on the "**Driver Configuration**" button also located on the left vertical toolbar (see picture below):

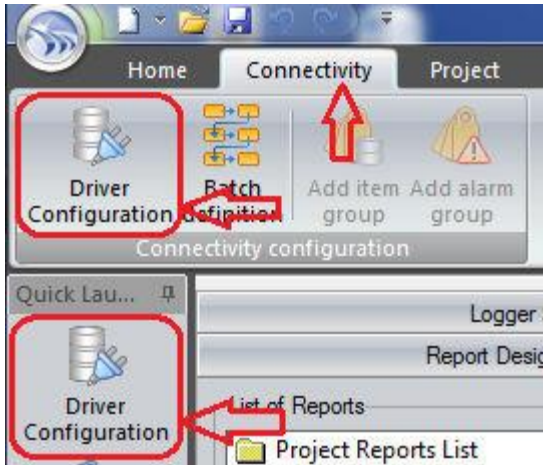

The following driver configuration dialog box will be opened:

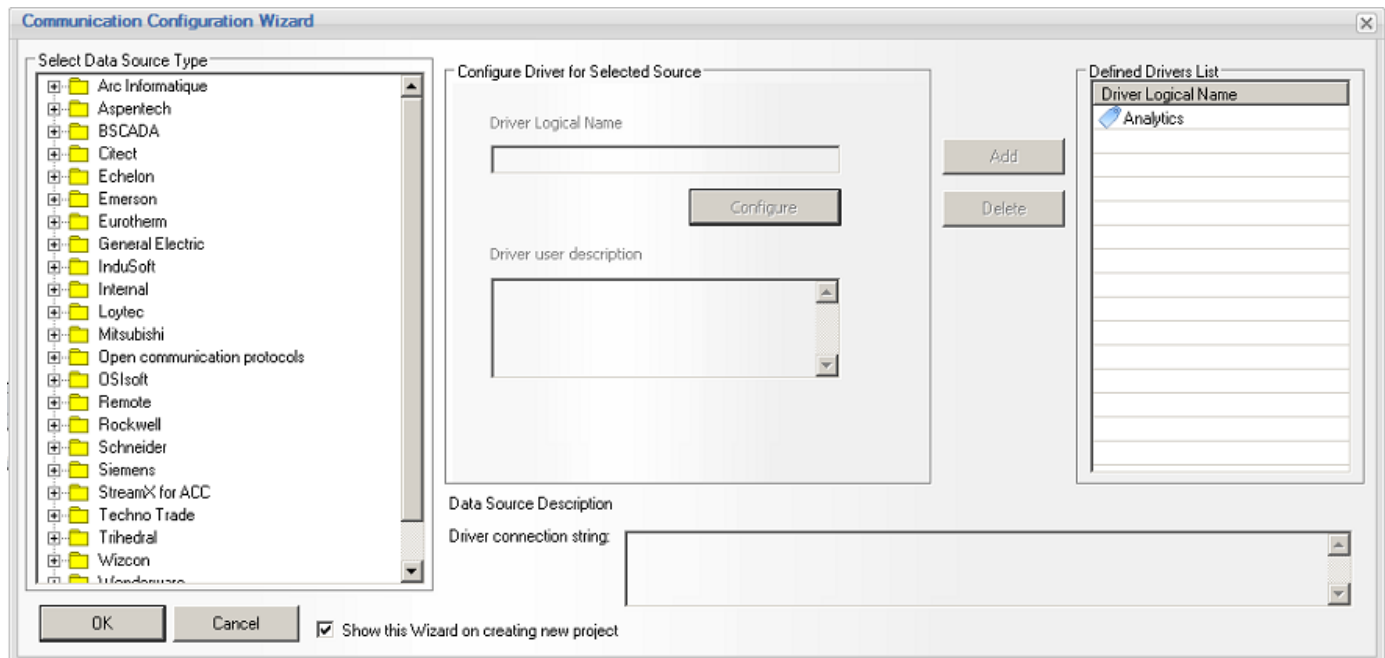

When the driver configuration window is opened in the **Driver Logical Name** section the Dream Report analytical driver (**Analytics**) will be automatically configured, and you will not need to do its configuration again. This driver (**Analytical real-time values**) is an internal module, responsible for record of statistical data, calculated by Dream Report to the database.



**NOTE:** In Dream Report version 3.43 each driver, when configured, had only one driver instance with one, two or three subdivisions (according to the types of data to access) for configuration, i.e., the driver could have maximum three options available for configuration: **Data Driver (real-time values)**, **Alarm Driver** and **History Driver**.

**Example:** The ODBC History Access driver had one instance both for historical data and historical alarms configuration.

The Eurotherm (Review) driver had one instance for both real-time and historical data access configuration.

Now, in this new version of Dream Report, each driver has separate instances for each type of data to access ( real-time, alarms, historical values), which should be configured separately.

Please note that after doing an upgrade from 3.43 or earlier versions all subdivisions of driver instances will have up to 4 driver instances: *Items DA, Alarms DA, Items HDA, Alarms HDA*.

**Example:** The ODBC driver has now two instances and should be configured separately as "**ODBC historical values**" (for historical data) or/and "**ODBC historical alarms**" (for historical alarms).

The Eurotherm (Review) driver has now three instances and should be configured separately as "**Historical values in Review or UHH database**", "**Historical alarms/messages in Review or UHH database**" or "**Real-time batch monitor**".

Though various data servers support data or/and alarms or all three types of data exchange services, in Dream Report user defines **DATA SOURCE**, which can be a set of drivers, that enables to connect to a server and to get data.

**Data source selection** will be displayed as a tree. The first browse level will be the list of the data source vendors. All first level browse will be displayed as folders.

When the type of driver will be selected from the **Data source** tree, it will automatically appear in the "**Driver logical name**" box for configuration. To configure communication settings, button "**Configure**" will open the driver configuration dialog box. Each driver has its own configuration user interface, which depends on the specific protocol needs.

If driver doesn't have any configuration interface, that button will be disabled.

When source is configured, it can be added to the general list of data sources, defined in the project, by clicking on **Add** button. The source configured will appear in the "**Defined drivers list**". Button "**Delete**" will delete the selected source from the list.

If the check box **Show this wizard on creating new project** is enabled, then each time when user starts a new project, this driver configuration window will be automatically opened with designer studio, so that user will know that first thing to do is to define communication drivers. If user will uncheck this check box, then each time when new project is created, users will not see this window opened anymore.

**Driver connection string** section will show internal communication string for already defined drivers. Each time when user adds a new driver to a project, all driver configuration is saved in the project as a configuration string, which is used then by that driver. So, in this "connection string" section users will see selected driver's connection string in pure internal format.

**NOTE:** If you need to configure the same driver more than once, then, after having configured it the first time, you'll just need to click in the "**Select Data Source Type**" field on any other driver and then go back to the driver that you need to configure.

When all the communication settings for the project are done, click on **OK**, and the driver configuration will be finished.



## Ocean Data Systems

For help information on a specific driver use, please, refer to the specific driver information in the Communication Drivers section.

**NOTE:** When changing the definition of an existing driver, please, be aware that the name of the existing driver can **NOT** be changed.



# Item Group

## Item Group Definition

The Dream Report Logger Studio enables users to split different data items by groups and define separate logging conditions for each group of data items.

Click on the command button *Add Item Group* on the **Connectivity** ribbon icon on the horizontal toolbar in the Dream Report Logger Studio menu (see pic. below):



**Add Item Group** dialog window will be opened (see pic. below).

If no item group has already been created, you can open the Dream Report Logger Studio and right-click on **Add item group** in the left top part of the Logger Studio.

If any item group has already been created, and you want to create a new item group, you can open the Dream Report Logger Studio, right-click in the left top part of it:

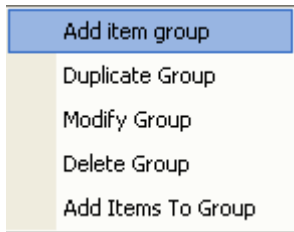

The **Duplicate Group** option will clone the selected item group with all settings, driver and list of items, taken from the original group.

If a user wants to edit the definition of an existing group, select the **Modify Group** menu option.

The **Delete Group** menu option will delete the definition of the selected group.

The **Add Items to Group** menu option will open the **Select Data Items (Add Items)** dialog box, which is described below. It will edit the data item list of the entire group.

Select **Add item group** from the context menu, and the **Item Group Definition** dialog box will be opened (see pic. below).



**Add Item Group** dialog box has 3 tab pages:

- **General**
- **Record Rate** (Logging Schedule)
- **Record Conditions** (Log on Condition)

### General

This page defines the following general properties of a group:

- Logical name.
- Short description (if needed).
- Selection of data source, from which a user will include items into a group.
- Data items list.

**Group Name** is a unique logical name, which will distinguish the entire group from others and give a tip to a user about the data content. Each group name must be unique.

**Group Description** allows the report developer to put comments about the purpose of a group or other useful information.

The **Group Source** combo box is filled with a list of the drivers already defined in the project. The developer has to select a driver, from which data points will be included into a group.

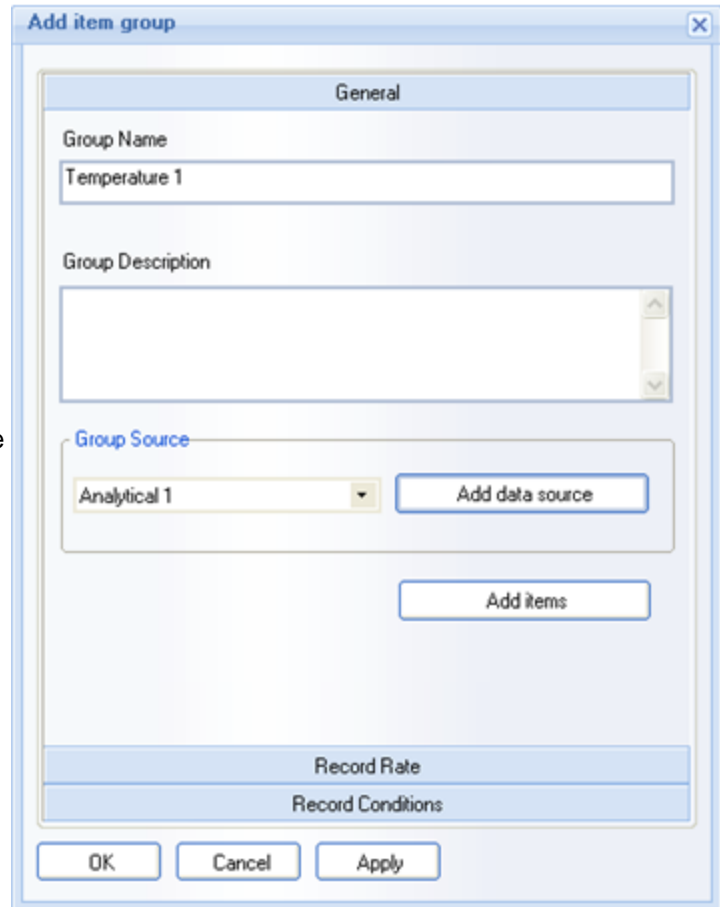

The **Add Data Source** button will add a new driver to the project. When the user clicks this button, a standard driver configuration dialog box (**Communication Configuration Wizard**) will be opened. When the user clicks **OK** and closes that dialog, the driver list in the **Group Source** combo box will be renewed.

The **Add Items** button will open a new dialog box (**Select Data Items**), containing the complete list of all data items from the selected drivers. User will be able to add or remove items from the entire group.

The left list box of that window will contain a complete list of available items and the right list box will contain a list of items selected for the entire group.

**Items Filter** enables users to easily find an item in a list. As soon as a prefix is entered, the list will be automatically filtered by the prefix.

Use an asterisk (\*) as a wildcard character.



## Item Group Definition - Logging Schedule

When the group definition dialog box is opened, a user can click on the **Record Rate** floating splitter and the appropriate tab page will be opened.

Here a user will have to select logging mode and schedule for the entire group.

Upper section - **Record Mode** - defines how often values of all data items in the group will be logged in the database during the logging period.

There are 5 options for the data logging mode: **On Change**, **On Update**, **Every**, **On Item Value Change** and **On Absolute Time**.

The **On Change** option will enable logging only on a value update if the value is different from the previous one (please, see the picture below):

Record Mode  
Record Mode: On Change (dropdown) | Tolerance: 0 (input box)

Tolerance on Abs. Value  
 Tolerance on Percentage (%)

When this logging mode is switched on, the user is able to define **tolerance** in the corresponding "**Tolerance**" edit box. The value entered in this edit box will define how many units of value should be changed in order to log a new value to the database and which value change should be ignored.

**Add item group** (Title Bar)

**General** (Tab)

**Record Rate** (Section Header)

**Record Mode** (Section Header)

Record Mode: On Change (dropdown) | Tolerance: 5 (input box)

**Record Period** (Section Header)

From: 01:00:00 (time picker) | To: 21:00:00 (time picker)

Day Settings:  Mon  Tue  Wed  Thu  Fr  Sat  Sun

Buttons: Add, Modify, Remove

From	To
01:00:00	21:00:00

**Record Conditions** (Section Header)

Buttons: OK, Cancel, Apply

It's possible to set tolerance in absolute units or in percentage by selecting the appropriate radio button inside the record mode section (either "**Tolerance on abs. value**" or "**Tolerance on percentage (%)**") (see pic. above).

The **On Update** option will enable logging when any value update is received from the data source, whether or not the new value is different from the previous one (please see the picture below):

Record Mode  
Record Mode: On Update (dropdown)

The **Every** option will record the item value at the defined rate whether or not the value has changed. The rate can be defined in **hours:minutes:seconds** (please see the picture below):



Record Mode  
Record Mode

Every 07:10:14

Normalized Time Sampling

The option **Normalized time sampling** allows logging values with normalized timestamps, i.e. rounded to round absolute time.

**For example:** if use will select "Every 20 seconds", then values will be logged every minute at 00 seconds, 20 and 40 seconds of each minute.

If user will select logging rate "Every 30 minutes", then values will be logged every round hour (00 minutes) and every 30 minutes of each hour.

This option works only if selected time is even to round hour. If a round hour (3600 seconds) can't be divided by selected record rate with no rest, then this option "Normalized time sampling" will be ignored and logging will be done as usual (as if this option is switched off), just milliseconds will be rounded to a round second.

The **On Item Value Change** option will record item values each time the value of a control item changes. It works as follows:

1. You can define an item from the same data source, that this group will log data from (as displayed on the picture below):

Record Mode  
Record Mode

On Item Value Change Data Source

MVE

Tolerance Item Name

3 energy 2

2. Every time this value changes, Dream Report will log values of all data items defined in that group.

**NOTE:** Please, note that only items from real-time data sources can be used. If you select a data item from external history server, this option won't work.

The **On Absolute Time** option will record item values at an exact time specified in the list (see example below):

Record Mode  
Record Mode

On Absolute time

11:00:00 11:00:00

Add

Modify

Delete

You can add as many time definitions as you need and when the PC clock reaches the time in the list, values for all of items in the group will be logged to the database.

Lower section - **Record Period** - defines a schedule for the logging period.

To **add active period**, specify time **FROM** (absolute time format), time **TO** (absolute time format), check which days of a week this period will be active, and click **Add** button to add a record to a list. Each record may have its own weekly schedule.



## Ocean Data Systems

If you select any record in the list, and click on **Modify** button, then, the selected record will get current values from the edit boxes and check boxes.

**Remove** button will remove selected record from the list.





## Item Group Definition - Log on Event

The comprehensive logging mechanism of Dream Report allows data logging control, based on a pre-defined event.

If the **Enable Record on Condition** check box is checked, then, the values of items from the entire group will be logged only if a pre-defined condition is true. If group logging scheduler is defined, that data will be logged only when the logging period is active and the event is *TRUE*.

If a group has no specific schedule period defined, then, data will be logged when the condition is *TRUE*.

When the check box **Enable Record on Condition** is enabled, users can define the record condition.

A data source can be selected from the source list in the upper combo box. The lower combo box will have a complete list of data items from the selected source. The user will have to select a source and a data item for the condition expression.

After the item name is selected, select a condition sign from the appropriate combo box and a condition value in the edit box. The value can be a floating point number, using a "." as the decimal separator.

Data from that group will be logged only when the defined condition is true. When the condition is false, no data from any item within this group will be logged.

**Log values in the range** defines a value filter for data logging. The check box "Log out of range" defines how values, which are out of a defined range, will be recorded.

If this check box will not be enabled, then all values, which are out of range, will be ignored and not recorded into the database.

The screenshot shows the 'Add item group' dialog box with the 'Record Conditions' tab selected. The 'Enable Record on Condition' checkbox is checked. The 'Data Source' is 'Ana' and the 'Item Name' is 'Energy report:temp4'. The condition is '> 0'. The 'Log values in the range' section shows 'From 10' to '30' with 'Log out of range' checked. The 'Engineering unit conversion' section shows 'Simple conversion' selected with a value of '/1000'. There are also 'Raw value' and 'Engineering' columns for 'Value 1' and 'Value 2', both showing '0'. An 'Inhibit group logging' checkbox is unchecked. Buttons for 'OK', 'Cancel', and 'Apply' are at the bottom.

If this check box will be enabled, then all values out of range will be rounded to the closest range limit and then written to the database (e.g. if range is 10 to 30, a value of 35 will be recorded to the database as 30 and a value of 5 will be recorded to the database as 10).

**Engineering unit conversion** has 2 options: **Simple conversion** and **Linear calculation**.

**Simple conversion** option enables users to make simple mathematical operations with raw values and write the result into the database. Allowed calculation operators are: +, -, \*, /.

**Example:** A simple conversion of "/1000" will divide each received value by 1000 and log the result from the group. If the received value is 65000, then the logged value will be 65. This will be applied to each value received for each tag defined in the group.



## Ocean Data Systems

Selecting **Linear calculation** will allow users to perform linear calculation from the raw value. The user enters upper and lower raw values 1 and 2, and upper and lower engineering unit values 1 and 2. Dream Report will scale the raw values to engineering units.

The **Inhibit group logging** check box can disable group logging. It can allow users to define a list of group definitions for future use and optionally disable data recording while doing the maintenance of the site where Dream Report project is running in order to avoid wrong data to be recorded into the Dream Report database.



## Alarm Group

### Alarm Group Definition

The Dream Report logger enables a user to split different alarms by groups according to their source and priority range and define separate logging conditions for each alarm group.

Click on the command button *Add alarm group* on the **Connectivity** ribbon icon on the horizontal toolbar in the Dream Report Logger Studio menu (see pic. below):



The **Alarm Group Definition** dialog box will be opened (see pic. below).

If no alarm group has already been created, you can open the Dream Report Logger Studio and right-click on Add alarm group in the **Alarms** section (left bottom part of the Logger studio).

If any alarm group has already been created, and you want to create a new alarm group, you can also open the Logger studio, and right-click in the **Alarms** section (left bottom part of the Logger studio)

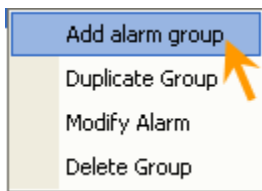

To edit an existing group, select *Modify Alarm*.

To duplicate an existing group, select *Duplicate Group*.

The *Delete Group* menu option will delete the selected group.

Select *Add alarm group* from the context menu, and the **Alarm Group Definition** dialog box will be opened (see pic. below).

The **Alarm Group Definition** dialog box has 3 tabs:

- **General** (Group Definition)
- **Record Rate** (Logging Schedule)
- **Record Conditions** (Log on Condition)



### Alarm Group Definition - General

This page defines general properties of a group as follows:

- Unique logical name
- Short description (if needed)
- Selection of data source, from which user will include alarms into a group
- Alarm priority range definition

**Group Name** - is a logical name, which will distinguish the group from another group and give a tip to a user about its content.

**Group Description** - allows the report developer to put comments about the purpose of a group and other related information.

**Priority Filter** - specifies the priority range of alarms, which will be included in the group definition.

If you click on **Define Alarm Filter** button, the **Alarm Filter Manager** dialog window will be opened. Please, select from the list of defined alarm filters the **priority filter** from which data points will be included into a group. Its name will appear in the **Priority Filter** box of the **General** tab. In this window you can also define a new alarm filter or edit the properties of an existing alarm filter.

For details, please, see [Alarm Filter Manager](#) section.

The screenshot shows a dialog box titled "Add alarm group" with a close button in the top right corner. The dialog has a "General" tab selected. Inside the dialog, there are several input fields and a button:

- Group Name:** A text box containing "Alarms 2".
- Group Description:** A large text area, currently empty.
- Priority Filter:** A text box containing "Alarm 1". Below it is a button labeled "Define Alarm Filter".
- Record Rate:** A label positioned above a text box.
- Record Conditions:** A label positioned above a text box.
- Buttons:** "OK" and "Cancel" buttons are located at the bottom right of the dialog.



## Alarm Group Definition - Logging Schedule

When the **Alarm Group Definition** dialog box is opened, a user can click on the **Record Rate** floating splitter and the Logging Schedule page will be opened.

Here a user can define schedule of alarm logging for the group.

Section **Record Period** defines a schedule for the active logging period.

If **Record Time Schedule** will be unchecked, then the logging period will always be active, i.e. Dream Report will always log alarms into a database.

If **Record Time Schedule** check box will be checked, then a user can define one or more periods where the logging period will be active and alarms will be logged. Then all other periods of time, except those defined in a schedule, will be passive and the alarms will not be logged.

To **add active period**, a user has to specify the time **FROM** (absolute time format), the time **TO** (absolute time format), and check the days of the week this time period will be active (**Day Settings**). Click the **ADD** button to add a record to the list. Each record may have its own weekly schedule.

If a user will select any record in the list and will click the **Modify** button, the selected record will get the current values from the edit boxes and check boxes.

The **Remove** button will remove the selected record from the list.

The screenshot shows the 'Add alarm group' dialog box with the 'Record Rate' section expanded to the 'Record Period' sub-section. The 'Record Time Schedule' checkbox is checked. The 'From' time is set to 00:00:00 and the 'To' time is set to 23:59:59. All days of the week (Mon, Tue, Wed, Thu, Fr, Sat, Sun) are checked under 'Day Settings'. There are 'Add', 'Modify', and 'Remove' buttons. Below these is a table with one row containing the current 'From' and 'To' values. At the bottom of the dialog, there are 'OK' and 'Cancel' buttons.

From	To
00:00:00	23:59:59



## Alarm Group Definition - Log on Event

The comprehensive logging mechanism of Dream Report allows alarm logging, being based on a pre-defined event.

If the **Enable Record on Condition** check box will be checked, then the alarms from the entire group will be logged only if a pre-defined condition is true. If the group logging schedule will be defined, that data will be logged only when the logging period is active and the event is true.

If the group will have no schedule defined, then data will always be logged when the condition is true.

When the check box **Enable Record on Condition** is enabled, define the event.

By clicking the "..." browse button, in the **Select Data Item** dialog box, that will appear, user can select **Data Source** and **Item Name**. A data source can be selected in the upper combo box from the source list. The lower combo box will have a complete list of data items from the selected source. The user will have to select the source and data item for the event expression.

After an item name is selected, select the condition sign from the combo box and enter a condition value in the edit box. Any numeric can be entered using a "." as the decimal separator.

Alarms from that group will be logged only when the defined condition is true. When the condition is false, any alarms within this group will not be logged.

The **Inhibit group logging** check box can disable group logging. It can allow the user to define a list of group definitions for future use and inhibit them without deleting the configuration.

The screenshot shows the 'Add alarm group' dialog box with the 'Record Conditions' tab selected. The 'Enable Record on Condition' checkbox is checked. The 'Data Source' is set to 'Ana' and the 'Item Name' is 'Energy report:temp7'. A dropdown menu is open next to the 'Item Name' field, showing a greater-than sign (>). To the right of the dropdown is a text box containing the value '35'. At the bottom left, the 'Inhibit group logging' checkbox is also checked. The 'OK' and 'Cancel' buttons are at the bottom right.



# Designer Studio

## Designer Studio - Create new report

To create a new report, right-click on the report tree in the *Report Designer Studio* and select *New Report* from the context menu.

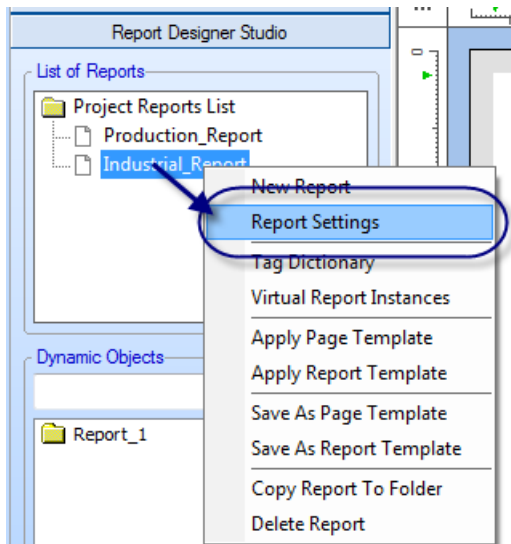

When the new report is created, you can add objects and design your report template.

You can use an existing page template to design your static page layout (header, footer, background etc.).

You can use an existing report template to add statistical objects to your report.

To add/ insert a new page, click on "*Insert new page*" icon on the toolbar in the Report Designer Studio (see on a pic. below).

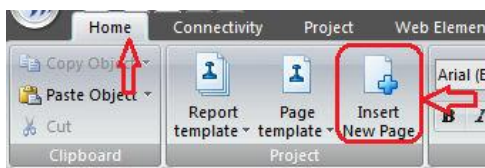



To delete a page from the report, right-click on that page and select "**Delete current page**" from the popup menu:

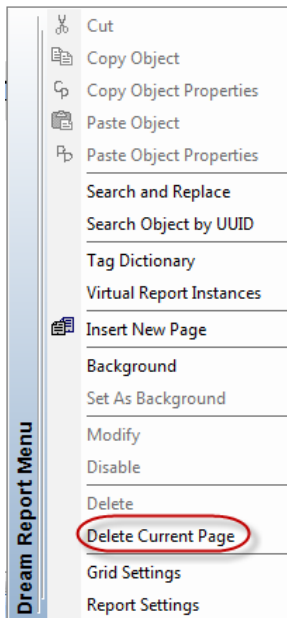

**NOTE:** The first page of report cannot be deleted and therefore "**Delete Current Page**" will be disabled on the first page of report.

**NOTE:** New report can be also configured by clicking on the DR Main Button in the upper left part of the Dream Report Designer Studio (please see the picture below):

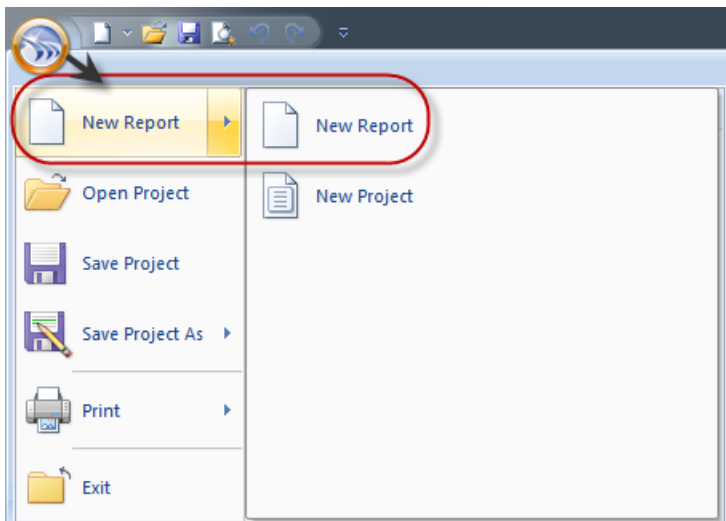





## Rulers and Grid

The **Rulers and Grid** dialog box defines settings for rulers and the grid in the report designer workspace.

User can open the dialog window with **Grid and Ruler settings** either using the menu in the Designer studio or the toolbar button:



To learn more about how to create header and footer, please, refer to the Page template section.

### Rulers

**Rulers** are the vertical bar on the left side of the page and the horizontal bar on the top side of the page, which show the exact position of the object on the output report page.

**Subdivisions** (horizontal and vertical) define the space between ticks in the ruler. The upper combo box has 3 preset positions.

If the unit selection is **mm**, then the ruler definition will have the following spacing:

- **Fine** (1mm tick),
- **Normal** (5mm tick) and
- **Coarse** (1cm tick).

If the unit selection is **inches**, then the ruler definition will have the following spacing:

- **Fine** (1/32" tick),
- **Normal** (1/8" tick) and
- **Coarse** (1" tick).

**Ruler Zero** defines the offset between 0 ruler mark and the top left corner of the page.

### Grid

The grid is a set of dots, drawn in vertical and horizontal lines over the workspace, which makes it easy to align objects on the page and align objects with each other.

**Grid spacing** defines the distance between dots in ticks.

**Minimum spacing.** This value sets a minimum grid spacing, which is a low limit of grid spacing while zooming a workspace in low zoom. If low zoom factors are used, the grid spacing will change according to a new zoom factor, but cannot be lower than a value, specified in the **Minimum Spacing** edit boxes.

If the unit selection is **mm**, then 1unit of the grid minimum spacing definition will correspond to 1mm.

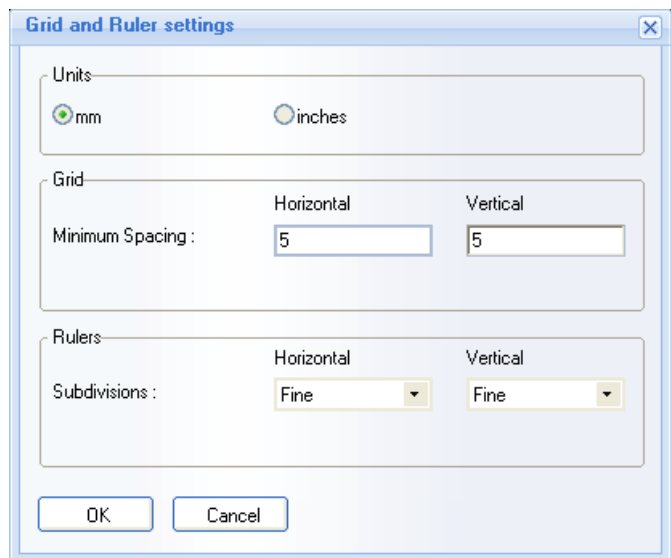



### Ocean Data Systems

If the unit selection is **inch**, then 1 unit of the grid minimum spacing definition will correspond to 1 tick (of rulers) in fine definition, i.e. 1/32".

**Example:** Grid minimum spacing of 5 units in inches will correspond to 5/32".



## Designer Studio - Static Objects

The Dream Report graphic editor supports drawing most basic shapes in order to add custom graphics to a report.

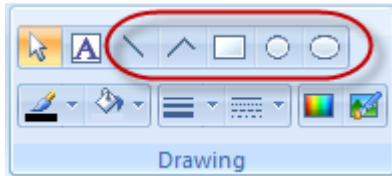

All drawing of static objects can be done using the **Drawing** toolbar or using the **Designer** menu in the Report Designer Studio.

**Line.** Click the *Line* button (left one) on the toolbar. Then click the left mouse button on the report page where the line should start. Move the mouse to the point where the line should end and release the mouse button. To edit line properties, click on the line and select a property from the toolbar. The following line properties can be edited: color, width, style. All these properties are accessible from the same toolbar (toolbar on the picture above, see the marked area).

**Multi-line.** Click the *Multi-line* button on the toolbar, click and release the left mouse button on the report page where the line should start. Then move mouse to the point where the line segment should end, click and release the mouse button. Then move the mouse again - another line will be drawn from the end point of the previous one. To complete the multi-line, right-click the mouse button. To edit the line properties, click on the line and select a property from the toolbar. The following line properties can be edited: color, width, style. All these properties are accessible from the same toolbar (toolbar on the picture above, see the marked area).

**Circle.** Click on the *Circle* button on the toolbar. Then click the left mouse button on the report page where the center of the circle will be. Move the mouse to expand the radius of the circle and release the mouse button when the circle is the correct size. To edit its line properties, click on the circle. The following line properties can be edited: color, width, border line style and background colour. All these properties are accessible from the same toolbar (toolbar on the picture above, see the marked area).

**Ellipse.** Click on the *Ellipse* button on the toolbar. Then click the left mouse button on the report page where one corner of the ellipse will be. Move the mouse to expand the ellipse and release the mouse button when the ellipse is the correct size. To edit its line properties, click on the ellipse. The following line properties can be edited: color, width, border line style and background color. All these properties are accessible from the same toolbar (toolbar on the picture above, see the marked area).

**Line width.** Select a shape, click on the arrow next to the *Line Style* button on the toolbar and select the desired line style. The selected style will be applied to the line.

**Line style.** Select a shape, click on the arrow next to the *Line Width* button on the toolbar and select the desired line width. The selected width will be applied to the line.



## Designer Studio - Insert Picture

Pictures can be added to a report in three different ways:

- Reference a **static image file**
- Reference an image **dynamically from a file**, with the option of referencing different image files based on one or more conditions
- Reference an **image stored in a SQL database**, through the use of a SQL query

To add the Picture object on a report, click on the **Insert Picture** button on the “**Drawing**” section of the **Home** toolbar in **Report Designer Studio**, and then click on the report workspace, where the upper left corner of the image should be placed:



The **Display a Picture** dialog box will then open.

### Displaying a Static Image

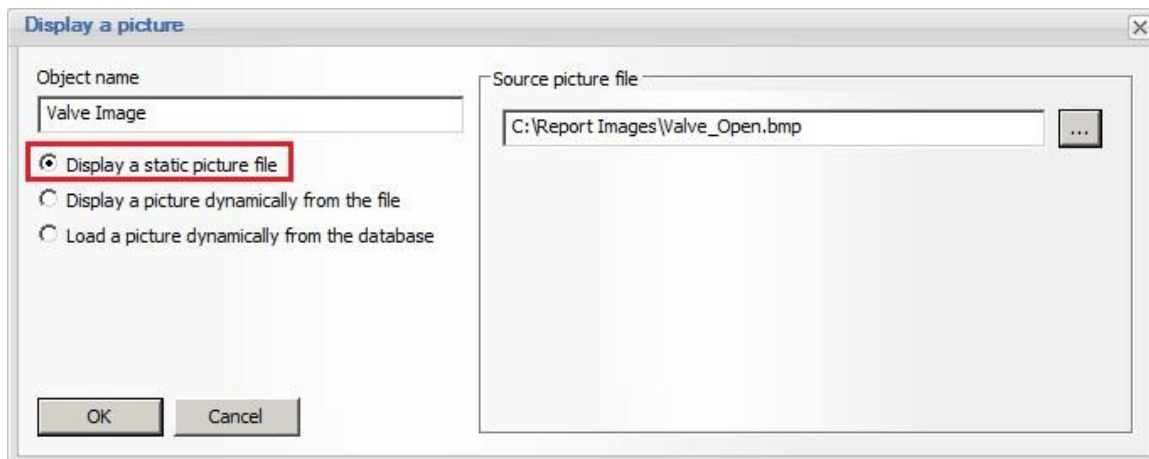

1. When the **Display a Picture** dialog box opens, enter a unique (to that report) **Object Name**
2. Select **Display a static picture file**
3. Browse and select a **Source Picture File** (\*.jpg, \*.bmp, \*.png and \*.gif formats are supported)
4. Click “**OK**” and the image will appear on the report. The image can be resized to fit the report, if needed. This exact image will be displayed whenever the report is generated.



## Displaying a Dynamic Image from a File

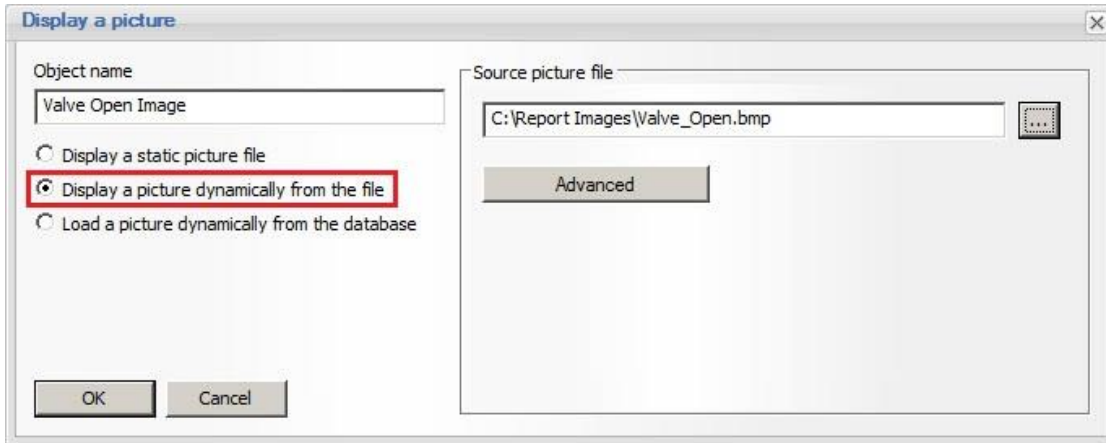

1. When the **Display a Picture** dialog box opens, enter a unique (to that report) **Object Name**
2. Select **Display a static picture dynamically from the file**
3. Browse and select a **Source Picture File** (\*.jpg, \*.bmp, \*.png or \*.gif). The current version of this file will be shown on the report whenever the report is generated. If the image file is changed (either over-written with a new file, or modified in any way) then the latest version of the file will be used at report generation time.
4. If you need different images to be displayed based on a condition, click the “**Advanced**” button. The **Advanced Picture Display** dialog box will open:

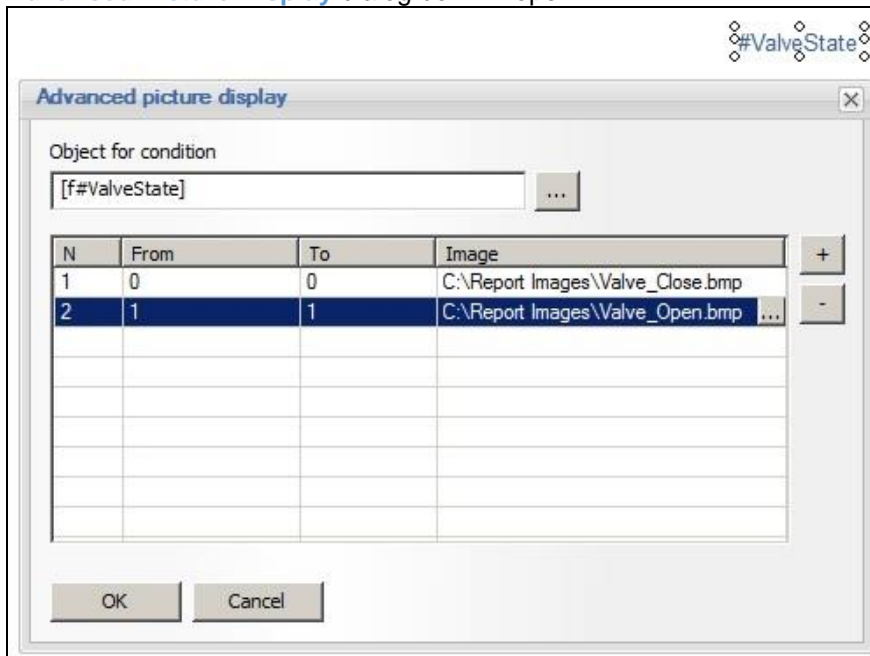

5. Select the **Object for Condition** by browsing for any single object on a report that you wish to base the conditional display on. The object could be based on a standard Dream Report statistical function, a current value, or an expression object.
6. Click the “+” (or “-”) buttons to add (or remove) the number of values or value ranges you wish to evaluate. For instance, these could be “0 to 0” and “1 to 1” to evaluate the two states of a discrete tag, or “0-5”, “5-10”, “10-15”, etc. to base the image to be displayed on analog value ranges
7. For each range, browse and select the **image file** to be associated with that condition.
8. Click “**OK**” to close the **Advanced Picture Display** window, and then “**OK**” to close the **Display a Picture** window
9. When the report is generated, the referenced object will be evaluated, and the appropriate image displayed on the report.



## Displaying a Dynamic Image from a Database

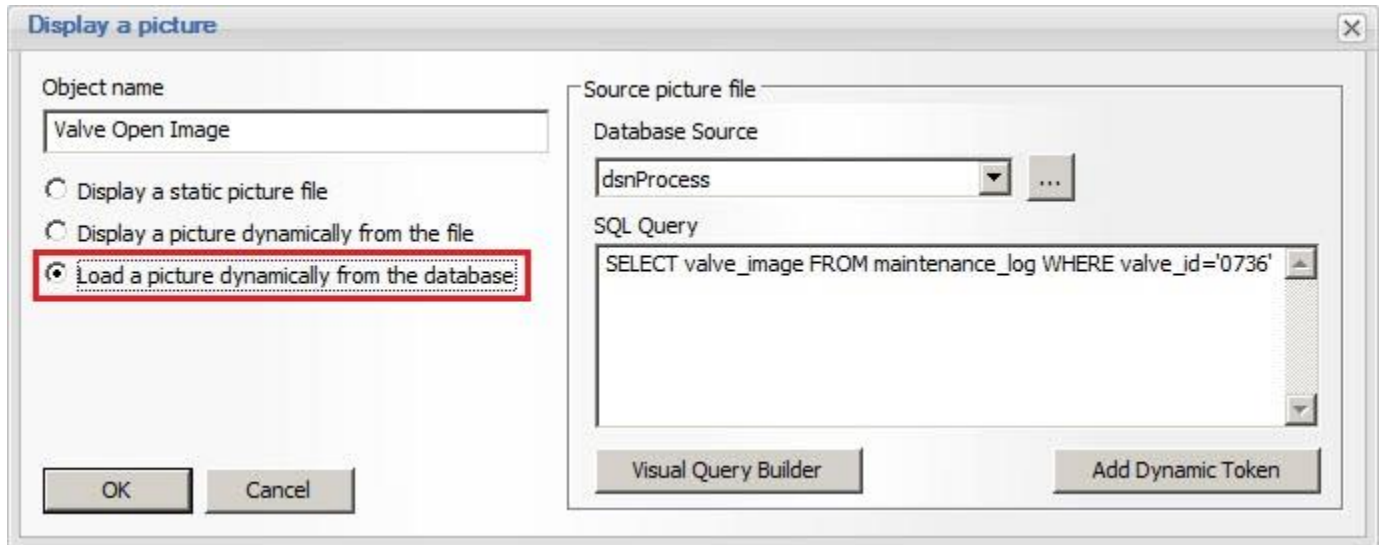

1. When the **Display a Picture** dialog box opens, enter a unique (to that report) **Object Name**
2. Select **Load a picture dynamically from the database**
3. In the **Source Picture File** section, select an existing ODBC **Database Source** (or click the [...] button to launch the *DSN Manager* to define a new ODBC data source.)
4. Enter a valid **SQL Query** that will select a valid image file (typically stored in a SQL “BLOB” format). Click the “**Visual SQL Query Builder**” button to help with building the SQL query. Note that the SQL query can be a dynamic query, by using the “**Add Dynamic Token**” button to browse for dynamic tokens or “variables” from the report to use in the query.
5. Click “**OK**” to close the Display a Picture window
6. The following “icon” will be placed on the report where the actual image will be displayed at generation time:



**NOTE:** An image, inserted into a report is stored internally in a report layout file as uncompressed, therefore consuming more memory while loaded at runtime. Therefore, use images with size not bigger than 100Kb. The quality of the generated report won't be affected. Likewise, for dynamically-loaded images, the size of the image files could impact report generation time.



## Designer Studio - Background

*Dream Report* supports setting a background image or color.

To define background, click on the **Set background** button on the **Edit** toolbar in the Report Designer Studio:

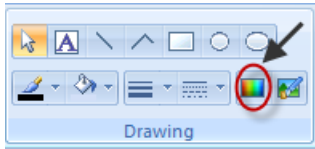

When the button is clicked, the **Background** dialog box will be opened:

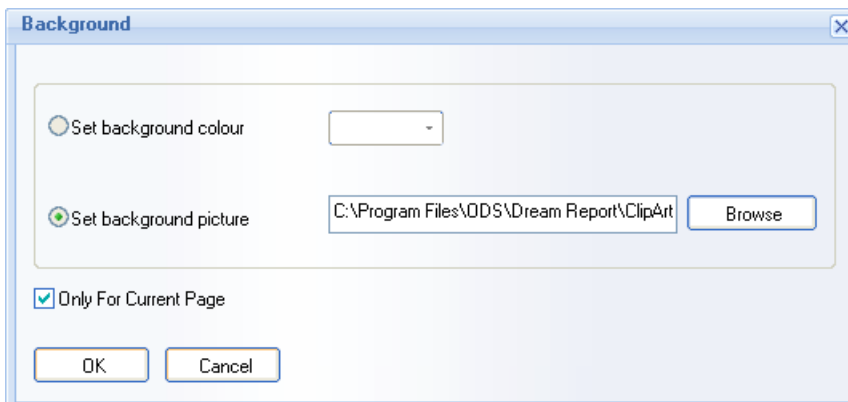

The **Set Background Color** option will set the background color selected in the color selection combo box. The **Set Background Picture** option will set a background from an image file selected using **Browse** button, or by typing a file path and name directly in the edit box.

The check box **Only for Current Page** defines whether the background will be applied to all pages of the report or only applied for the current page.



## Designer Studio - Text Object

This object allows users to add static text to a report.

- **Add New Text Object**

When a user selects a text object in the toolbar or from the menu in the Report Designer Studio:



then left-click on the workspace, and drag the mouse to mark the boundaries of the text area and then release the mouse button. When inserted, the text box will contain the word "TEXT", which can be replaced by typing the desired text.

As soon as the text has been entered, press *ENTER* or click on the workspace outside the text rectangle and the text will be accepted.

- **Edit Existing Text Object**

To edit the properties of the text, click on the text again and the boundary rectangle will be shown. You can change the text properties, e.g. font color, style, size, alignment, background color, or border color (if any).

To edit the text, double-click on the text and the text box will be opened and available for editing.

The font size can be increased or decreased by 1 point size using the appropriate toolbars:



The text string can be aligned within the text box by the right or left edge or centered, using the appropriate buttons on the alignment toolbar:

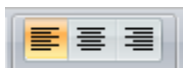

- **Text Object Manipulation**

Dream Report supports changing the direction of the text. The default direction of the text is left-to-right. However, you can make it right-to-left by selecting the text box and using the text direction toolbar buttons (selected button on the image above).





## Designer Studio - Search and Replace

Designer studio contains the **Search and Replace** section, which helps report designer to easily find the statistical objects needed, and to open their configuration dialog window as well as automatically replace data items and time period definitions throughout the currently opened report.

To open the **Search and Replace** dialog window, user has to right-click on any place of the object location area (bottom left part of the Designer studio), as displayed on the picture below:

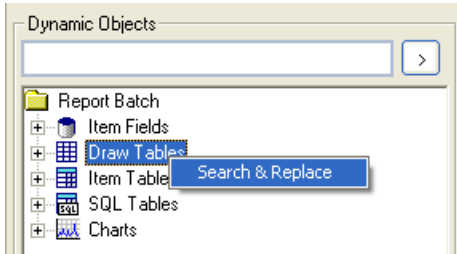

The **Search and Replace** dialog window will be opened:

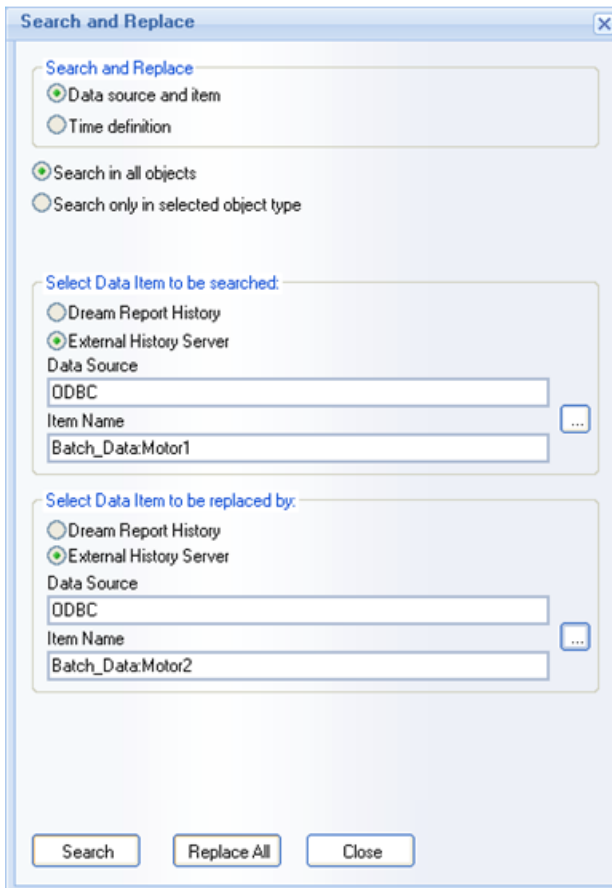



## Ocean Data Systems

Using this function, users can automatically either search or replace a specific data item by another data item, or search/replace one specific or all time definitions by a specified one throughout all the objects within that report.

To search or replace *a specific data item by another one*, select **Data source and item** option in the **Search & Replace** group box, on the top of the window:

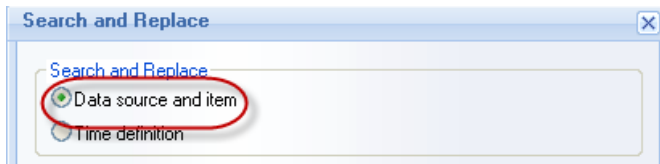

User can select which type of statistical reporting objects will be affected by that data item search/replacements.

If option **Search in all objects** will be selected, then the data item search/replacement will be done in all statistical objects of that report.

If option **Search only in selected object type** will be selected, then the combo box with the list of all available object types will appear just below that radio button. User will be able to select the desired object type and then data item search/replacement will affect only the object type selected:

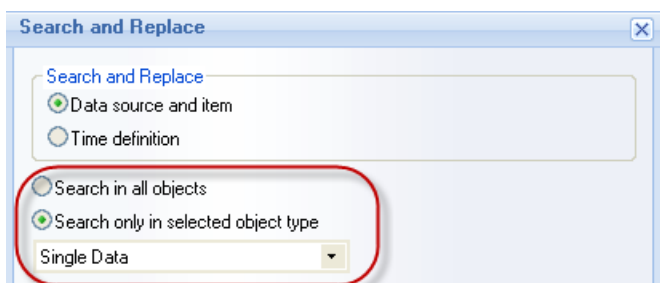

Then, in the section **Select Data Item to be searched**, select data item to be searched.

If a user needs to search for a statistical object, which is defined on that data item, he will have to click on **Search** button. The first found object, which has specified that data item defined, will be selected in the Report Designer studio, and the window focus will be put on that object. (If there are several objects, which have that data item specified, and a user needs all or some of them, he will have only to click on **Search** button again, and, each time this button is clicked, the window focus will be put on another statistical object, which has the specified data item).

If a user needs to replace any specified data item in the statistical objects in that report, he will have to select data item to replace within the **Select Data Item to be replaced by** section below. Then, click on **Replace All** button, and all the statistical objects, which use the specified item searched, will replace this specified searched item inside their definition by the item, selected to be replaced by.



## Ocean Data Systems

Then, the box, which will show the number of found statistical objects, where this data item replacement has been done, will pop up:

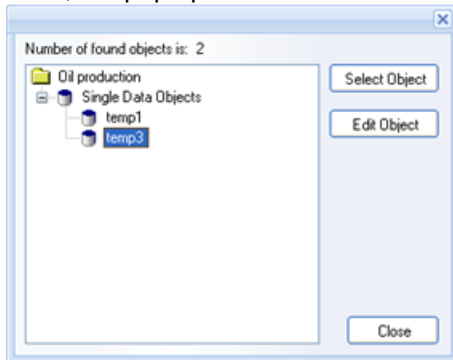

If a user needs to do any changes in any of the objects from this list, he will have to click on *Edit Object*, and the window focus will be put on that object.

Otherwise, click *Close*, and exit without any changes.

If a user wants to replace any specified data item only in one statistical object, he will first have to select the specified data item. Then, by clicking *Search* button, find the statistical object needed, and do the replacements.

To replace *time definition*, select *Time definition* option on the top of the dialog window:

Then, select which type of statistical reporting objects will be affected by that time replacements.

If option *Search in all objects* will be selected, then the time period replacement will be done in all statistical objects of that report.

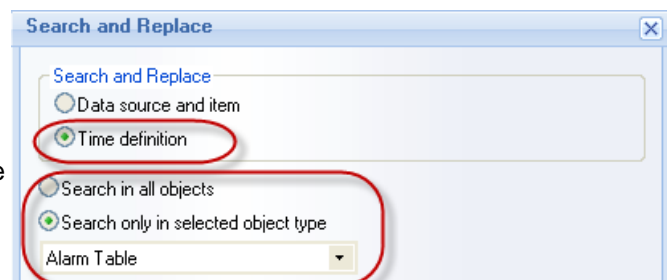

If option *Search only in selected object type* will be selected, then the combo box with the list of all available object types will appear just below that radio button. User can select the desired object type and then time period replacement will affect only the object type selected.



After that, specify the time period to search for (**Search time period**) and the time period to replace by (**Replace by time period**) (see pic. below):

If you will select the radio button **All time periods**, then the time period to search will have no effect - the specified time period to replace by will be applied to all the objects from the selected object type.

If you will select the radio button **Specific time periods**, then the time period replacement will be applied only to those statistical reporting objects, which have actual time period definition the same as to be searched for, and which type is the same as selected in the **Object type** combo box.

If a user needs to replace any specified time period data item in the statistical objects in that report, he will have to select time period defined to replace within the **Replace by time period** section below. Then, click on **Replace All** button and all the statistical objects, which use specified time period defined, will replace this specified time period inside their definition by the time period definition selected to be replaced by.

For details on how to define time, please, see [Time Period Definition](#) section of this manual.

### Search and Replace in the selected objects

If a user needs to search or replace some data not in the entire report, but in its part, i.e., if only some piece of data needs to be modified, then he should do the following:

1. Select the group of objects, where the data should be modified, and press “**CTRL-F**” hot key; or select from the content menu the **Search and Replace** option. When the mouse cursor is located on top of the selected objects, the standard **Search and Replace** dialog will be opened (as in the pic. above).
2. If a group of objects includes some non-dynamic objects, then it will be discarded from the search.



## Ocean Data Systems

3. If the Free (Draw) Table is selected, but none of the internal fields has been chosen, then **Search and Replace** will be done for the entire free table.

If the Free (Draw) Table is selected, but only some of its cells have been chosen, then **Search and Replace** will be done only for the selected cells from that Free table.

4. If, together with the Free (Draw) Table, some additional objects are selected, then **Search and Replace** will be done on top of the selected objects, also considering changes in the Free (Draw) Table (as described in p.3 of this section).

5. After **Search and Replace** operation is finished, the selected object will remain selected (as before the operation).

### Tag Dictionary and Virtual Report Instances

Two functionalities - **Tag Dictionary** and **Virtual Report Instances** - provide users with an advanced **Search and Replace** mechanism by using complete data source/data item and complete source type matching.

For details, please, go to the **Search and Replace** parts of the **Tag Dictionary/ Virtual Report Instances** sections.

### Search Object by UUID

If there is any problem with an object, which is used in WEB reports in Dream Report Web portal, then, in order to find this object, user should search for this object in the DR studio/report by this object's **UUID** (Universal Unique Identifier). This UUID is located in the "**dmlc.log**" log file, which is stored in the folder with the unique name, being generated by Dream Report at the moment of WEB Report generation

To search an object in the report by its UUID, right-click on the report page and select "**Search Object by UUID**" from the popup menu:

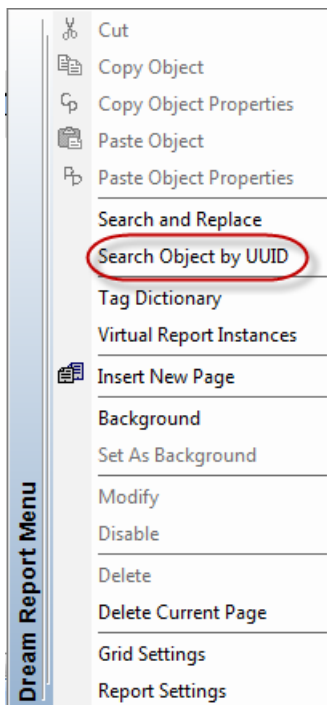

For details on WEB reports, please go to the **Web Portal** section of this manual.



## List of Dynamic Tokens

**Dream Report** provides a list of dynamic tokens to display in a specific context.

Below you can find the list of dynamic token, used in Dream Report, with the definition of their functions.

### List of Basic Dream Report Dynamic Tokens:

**[c#...]** - This dynamic token is used in Step tables to give possibility to calculate data between columns and to present this data as an additional column.

**[i#...]** - This dynamic token has the following format **[i#<Item Name>]** and can be used in 2 possible ways:

- To provide item name to the [Advanced SQL condition](#);
- To give currently calculated value to any part of Dream Report, which requests this value, via Analytical driver (i.e. Batch ID to the Report's file name).

**Example:** [i#Analytics.Report1:energy1]

**[f#...]** - This dynamic token has the following format **[f#Field Name]** and is used as a parameter that will be replaced dynamically by the value of the item specified in it. It can be used as a part of:

- [Advanced SQL condition](#);
- In [Expression Objects](#);
- In SQL [Single Data Objects](#) or in [SQL tables](#).

**Example:** [f#energy1]

**NOTE (TIP):** value of **f#** token can be used only as part of the current report. If user wants to get this value in another report, he can use **i#** token via analytical driver.

**[s#...]** - This dynamic token returns to the project different system information and can be used in [Dynamic Text Objects](#).

**Example:** s#ReportName.

**[dt#...]** - This is the **DateTime** token, which has the following format **[dt#<object\_name>]**, and can be used in [Expression Objects](#), in order to perform time-based calculation operations.

**Example:** [dt#energy5].

**[cb#...]** - This dynamic token has the following format **[cb#<object\_name>]** and can be used in 2 possible ways:

- For referencing Combo Box [objects](#) (where **<object\_name>** - is a name of the Combo Box object);
- In [Expression Objects](#). If the value of the combo box has to be used in the project, it is necessary to define an Expression object, that will contain **[cb#<object\_name>]** format. After that it will be possible to use this expression in other places where dynamic tokens can be used.

**Example:** [cb#maintenance1].

**[tp#...]** - This dynamic token has the following format **[tp#<object\_name>]** and can be used in 3 possible ways:

- For referencing [Timestamp Picker objects](#) (where **<object\_name>** is a name of the Timestamp Picker object);
- For time definition in [Calculated Time Period](#) and [Manual Input](#) modes;
- In [Expression Objects](#). As soon as it's referenced in Expression objects, it can be used in [Advanced SQL condition](#) and other places where dynamic tokens are used.

**Example:** [tp#Energy\_production].

**[#correction]** - This dynamic token is used for a special item name that has to be set in the [Manual Input](#) statistical function ([Single Data Objects](#)), if the Manual Input function will be used for correction operations.

**Example:** [#correction].

**[ipp#<parameter>]** - This dynamic token is used for accessing Internal Project Parameters defined in the project.

**Example:** [ipp#<Cycle 3>].



### List of Web Manual (Entry) Driver Dynamic Tokens (used in Advanced SQL Condition):

**[k#ONLY\_VALIDATED]** - This dynamic token is used when only validated values will be received from [Web Manual \(Entry\) Driver](#).

**[k#NOT\_VALIDATED]** - This dynamic token is used when only NOT validated values will be received from [Web Manual \(Entry\) Driver](#).

**[k#ORIGINAL]** - This dynamic token is used when only original submitted values will be received from [Web Manual \(Entry\) Driver](#).

**Example:** Tag\_Name=[f#exp\_tag\_name] AND [k#NOT\_VALIDATED].

### List of Preprocessor Dynamic Tokens

**[gen#BatchId]** - This dynamic token will be replaced by ID of the batch (Batch ID) for which the report is generated.

**[gen#ReportStartTime]** - This dynamic token will be replaced by **Report Start Time** as configured in the [dynamic generation](#) settings.

**[gen#ReportEndTime]** - This dynamic token will be replaced by **Report End Time** as configured in the [dynamic generation](#) settings.

**[file#<file\_name>#<param\_name>]** - This dynamic token will be replaced by the parameter value that will be found in the specified **<file\_name>**. The file has to have a special format in order to be used in [Report Preprocessor](#). The special file format is:

```
<ods_rpp_document ver = "1.00">
```

```
<ods_rpp_param_list>
```

```
<ods_rpp_param name = "param1" value = "value1"/>
```

```
<ods_rpp_param name = "param2" value = "value2"/>
```

```
<ods_rpp_param name = "param3" value = "value3"/>
```

```
</ods_rpp_param_list>
```

```
</ods_rpp_document>
```



## Using Dynamic Tokens in a Data Source Definition

**Dream Report** allows the use of dynamic tokens when specifying a Data Source or Item Name in a reporting object (e.g., Single Data Object, Line Chart, Item Table, etc.) This is useful if multiple data sources (e.g., redundant historians) have the same set of tag names, as you have the ability to dynamically switch data source, simply by referencing a **dynamic token** that contains the Data Source name. The data source might be user-selected from a **Combo box**, or assigned in a logical **Expression object**.

For example, a combo box with the list of data sources can be used on a Web report. Then, in the reporting objects, set a dynamic token ( `[f#..]` ) instead of an actual Data Source, which will use dynamic data source from the combo box selection during report generation on the web portal.

1. Add a **Combo box** to Display Data from a Data Source List:

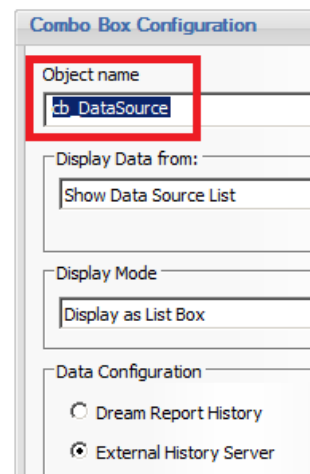
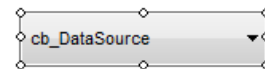

2. Add an **Expression** object to the report, which simply references the Combo box by name (note the single-quotes around the object name):

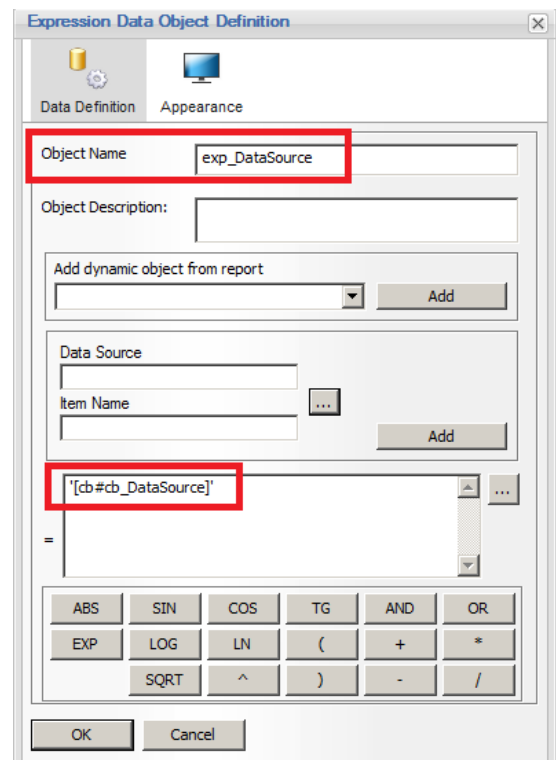





## Ocean Data Systems

- In a reporting object (e.g., a [Line Chart](#)) select an Item (tagname) from a Data Source, and then replace the actual Data Source name with a dynamic token reference to the Expression object name containing the dynamic Data Source name:

The screenshot shows the 'Chart' configuration window. On the left, a table lists items with 'N' in the first column and 'Item Name' in the second. The first row contains '1' and '[#exp\_tags]'. The main area has three tabs: 'Data Definition', 'Appearance', and 'Advanced SQL Condition'. Under 'Data Definition', there are two radio buttons: 'Dream Report History' (unselected) and 'External History Server' (selected). Below these are two text input fields. The 'Data Source' field contains '[#exp\_DataSource]' and is highlighted with a red box. The 'Item Name' field contains 'Tank1Level'.

**NOTE:** The same approach can be used for selecting/assigning a dynamic item/tagname, based on a user selection or other logic expression that assigns a tagname. In the following Chart example, both a dynamic Data Source and Item Name are used:

This screenshot is similar to the previous one, but the 'Item Name' field also contains a dynamic token '[#exp\_Tag]' and is highlighted with a red box. The 'Data Source' field also contains '[#exp\_DataSource]' and is highlighted with a red box.

The following matrix that shows which reporting objects support dynamic data sources and items.

Object	Data Source	Item
Item Table	Yes	Yes
Step Table *	Yes	Yes
AST Table	No	Yes
Chart	Yes	Yes
Bar	Yes	Yes
Pie	Yes	Yes
Single Data Object	Yes	Yes

\* Note that for the [Step Table](#), the dynamic replacements supported inside the column defined as a [Single Data Object](#), but not if tag is defined for the Step Table step.



# Simple Statistic Objects

## Designer Studio - Single Data Object

**Single Data Object** is a dynamic object, which performs statistical calculations with the textual output of the result.

To add this object, click on the **Single Data Object** button on the Report Designer Studio **Elements** toolbar:



Draw a rectangle in the workspace where the output data will be displayed.

The following dialog box will be opened:

**Object Name** must be a unique logical name, which will be used in further work with that object within the project. The object name can be up to 64 characters long. Only alphanumeric characters and "\_" are allowed. The first character cannot be a number.

**Object Description** allows users to quickly understand the use of the object. The description can be up to 256 characters long. Any characters are allowed.

In the **Select Data Item** section, select the data to display. The radio buttons "**Dream Report History**" and "**External History Server**" define whether historical data will be taken from Dream Report history or directly from the history of an external server using the history driver for that server.

If "**Dream Report History**" will be selected, the combo box "**Select Data Source**" will contain a list of data access drivers defined in the project. If "**External History Server**" will be selected, the "**Select Data Source**" combo box will contain a list of history access drivers defined in the project.

For **Data Source** and **Item Name**, select the source and item from which Dream Report will calculate values.

**NOTE:** If you will select "**Dream Report History**", then you will be prompted to select a data item only from the list of data items defined in one or more logging groups within the Dream Report logger.

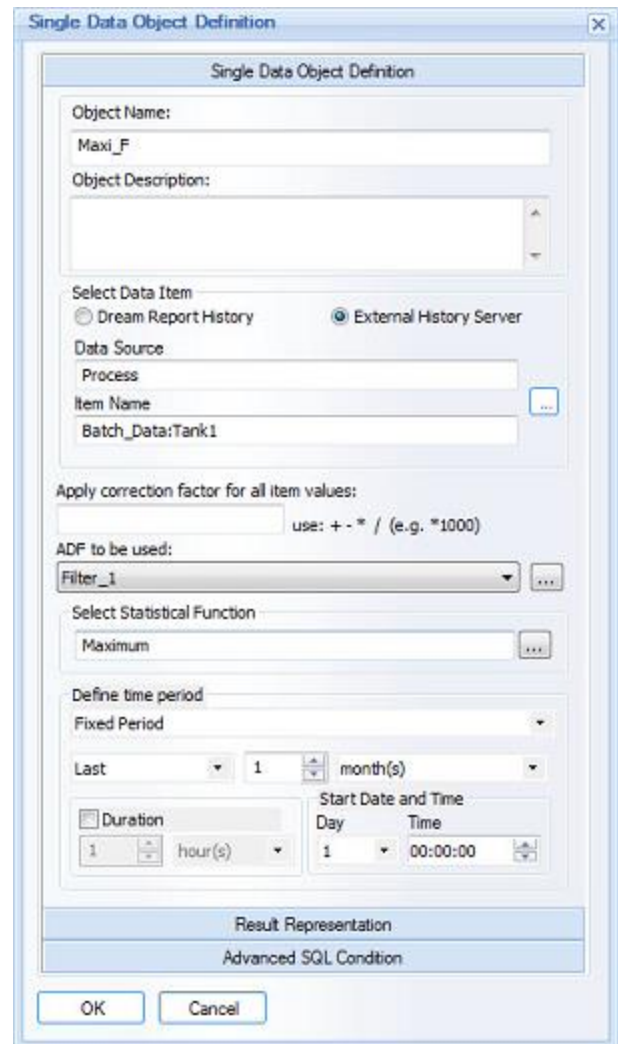

However, if the selected statistical function will be "**Current Value**", you will be prompted to select a data item from the list of all available data items within the selected source.

If you will select "**External History Server**", then you will be prompted to select a data item from the list of all available items within the selected history source.



**Apply correction factor for all item values** enables adding simple expression to a single data object. If the correction factor is set for a data item in a single data object, then, when retrieving value of that data item for that object, first of all, each retrieved value from a database will be re-calculated, applying the correction factor. Then the statistical functions will be performed on re-calculated values.

For more details, please refer to the Correction factor section.

**ADF to be used:** enables to select an aggregated data filter. "ADF to be used" combo box will contain all ADF definitions configured in the project. The default string will be "Not Used", i.e. no filter (ADF) is applied.

For details on ADF definition/configuration, please go to the Aggregated Data Filter section of this manual.

The **Select Statistical Function** combo box contains a list of statistical functions available for calculations.

In the **Select Statistical Function** dialog box all the statistical functions will be grouped according to their common performance characteristics, and will be displayed as a tree (please, see the pic. below):

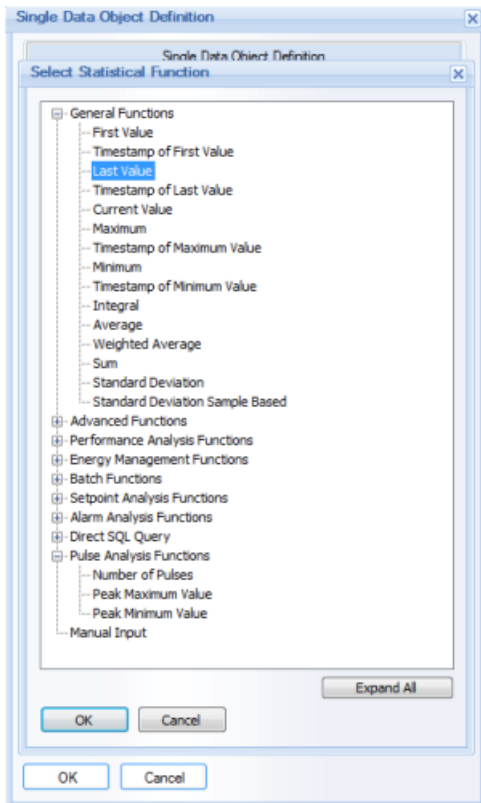

If a user needs to expand/collapse one of the groups in the Statistical Functions tree, he will only have to click on the corresponding group branch. If a user needs to see the whole tree displayed or collapsed, he will be able to do it by clicking the button in the bottom right corner of the **Select Statistical Function** dialog box. If the dialog box is opened with the expanded tree of the groups of statistical functions, then the button *Collapse All* will contract the tree. If the dialog box is opened with the collapsed groups, then, the button *Expand All* will open the Statistical Functions tree.

By default, when the **Select Statistical Function** dialog box is opened, the tree will appear partially expanded - only the group branch, from which this statistical function has been selected, will be expanded. All other groups will be collapsed.



The Statistical Functions tree will have the following groups:

### General Functions:

- **First value** - selects the first found value for the selected item from a database within the specified time period
- **Timestamp of first value** - displays the timestamp of the first value found during the specified time period. The timestamp has a configurable format of three options: [Date/time](#) or [Date](#) only or [Time](#) only.
- **Last value** - selects the last found value for the selected item from a database, which is within the specified time period
- **Timestamp of last value** - displays the timestamp of the last found value during the specified time period. The timestamp has a configurable format of three options: [Date/time](#) or [Date](#) only or [Time](#) only.
- **Current value** - selects current value for the selected item from a database.  
**NOTE:** If user will display current value in a web portal, there is a way to display real-time value changes. To enable that, user has to open a dialog window Report Settings -> File Format and then click on the button [Settings](#) and enable real-time value update in web. Also, real-time values update rate can be configured (in seconds). This functionality is described more in details in report settings section **Report File Format**.
- **Maximum** - retrieves the maximum value of the selected item within the specified time period
- **Timestamp of maximum value** - displays the timestamp of the maximum value during the specified time period. The timestamp has a configurable format of three options: [Date/time](#) or [Date](#) only or [Time](#) only.
- **Minimum** - retrieves the minimum value of the selected item within the specified time period
- **Timestamp of minimum value** - displays the timestamp of the minimum value during the specified time period. The timestamp has a configurable format of three options: [Date/time](#) or [Date](#) only or [Time](#) only.
- **Integral** - calculates the integral of all values during the specified time period
- **Average** - calculates the average value of the selected item during the specified time period
- **Weighted average** - calculates a time-weighted average of the value during the specified time period. *Weighted average* uses a different calculation than *average*, so do not use the two functions interchangeably. The weighted average function considers the values as well as the duration of each value
- **Sum** - calculates the sum of all values during the specified time period
- **Standard deviation** - calculates the standard deviation of all values during the specified time period
- **Standard deviation sample based** - calculates the standard deviation (sigma) not based on all values over the period, but by specific number of samples (e.g. on first 10 or 20 or 30 samples).



### Advanced Functions:

- **Logged Value Counter** - calculates how many times a value in the specified range was logged in the database within the specified period of time. If the **Logged Value Counter** function is selected, enter a range of values (filter) for the calculation. The values entered are inclusive, i.e. will both be included in the calculation. Negative and floating point values are accepted, however, only numeric values can be entered. This filter doesn't work with the text or symbolic values.

If the value filter is empty and doesn't contain any value range, the full value range (i.e. all values) will be counted.

- **Duration in the interval (hours)** - calculates the total time period when the values were within the specified value range, and returns the result in the format HH:MM:SS. When this statistical function is selected, a user will have to enter a value filter for the range of values. The values entered are inclusive, i.e. will both be included in the calculation. Negative and floating point values are accepted, however only numeric values can be entered. This filter doesn't work with text or symbolic values.

**Example:** If we calculate the "Duration in interval" between 12:00 and 14:00 with a value range of 10-20, where between 12:00 and 13:00 the value was "12" and between 13:00 and 14:00 the value was "22", then the value was only within the specified value range 1 hour (12:00-13:00), and the result will be **01:00:00**

- **Counter** - a statistical function, which is mainly used to count consumption (water, electricity consumption etc.). This function displays the difference between the last and the first value of the selected item during the specified period of time.

**Example:** If the counter function is applied to an item which had values: 30,40,50,60,70,80,90 - then this statistical function will return **60**, which is (90-30).

If the value counter has a maximum value, after which the counter resets, it can be configured as well. Specify the **Maximum** value, which the counter will reach before resetting, and also specify the **Start** value, i.e. the value, from which the counter starts to count after reset (e.g. from 0 or from 1)

**Example:** If you define a counter with a maximum of 1000 and a start value of 1 and your data has values 800, 900, 100, 200, then the result will be **399**, which is (1000-800) + (200-1)

**NOTE:** In order to avoid any mix up due to 0's at the start of Control Maestro (legacy Wizcon) application, a user should write "-1" in "**Start**" and "**Max**" combo boxes.

- **Mean Kinetic Temperature (MKT)** - this function performs a complex calculation with an array of temperature measurements, calculating the time interval for each temperature, and brings the array to the equivalent of one single temperature value during the period.

**Example:** If the dairy factory has produced milk, which was stored 1 hour at a temperature of +5C, then it was in a truck 1 hour at a temperature of +15C, and then it was in a shop for 10 hours at a temperature +3C, the MKT calculation will calculate the equivalent of storing the milk as at +6.7C for the entire period (12 hours).

(This example is theoretical and is provided only as an example - the result is not properly calculated using the complete set of input parameters)



## Ocean Data Systems

- **Advanced Mean Kinetic Temperature** calculation enhances precision of the calculated result and provides the calculation methodology, which is adopted by Eurotherm as a standard.

When the “**Advanced Mean Kinetic Temperature**” function is selected, a user has to click on “*Configure*” button and the following dialog window will be opened:

Calculation parameters

dH 83.144

Precision 1

T C

Use calculation algorithm

By number of samples

By number of periods (intervals)

By defined periods (intervals)

10

OK Cancel

In the “**Calculation parameters**” section a user has to enter constant parameters for the calculation and select the input temperature unit.

In the “**Use calculation algorithm**” section a user has to specify which data will be selected for the calculation and analysis:

1. If the “**By number of samples**” option is selected, then, a user will have to enter the number of samples to take for calculation into the edit box below. The number of samples has to be only non-zero and positive.
2. If the “**By number of periods**” option is selected, then, a user will have to enter the number of equal periods into the edit box below. Then, all the entire period, defined in the object, will be divided into that entered number of equal parts, and the calculation will be done accordingly. The number of periods has to be only non-zero and positive.
3. If the “**By defined periods**” option is selected, then the edit box below will be replaced by the time picker control, and a user will have to enter the number of **hours:minutes:seconds**, which will be considered as a time period unit. Then the entire time period of the object will be divided into equal parts, where the length of each will be equal to the entered one. The defined period length has to be only non-zero and positive.



**Calculation.** The calculation will be done according the formula below:

$$T_k = \frac{-\Delta H}{R} \ln \left( \frac{e^{\frac{-\Delta H}{RT_{1H}}} + e^{\frac{-\Delta H}{RT_{1L}}} + \dots + e^{\frac{-\Delta H}{RT_{nH}}} + e^{\frac{-\Delta H}{RT_{nL}}}}{2n} \right)$$

Where:

- $T_k$  = the mean kinetic temperature in K
- $\Delta H$  = the heat of activation, 83.144kJ.mole<sup>-1</sup>
- $R$  = the universal gas constant, 8.3144x10<sup>-3</sup>kJ.mole<sup>-1</sup>.K<sup>-1</sup>
- $T_{1H}$  = the high temperature in K in interval 1
- $T_{1L}$  = the low temperature in K in interval 1
- $T_{nH}$  = the high temperature in K in interval n
- $T_{nL}$  = the low temperature in K in interval n
- $n$  = the total number of samples in the calculation.

**NOTE:** 83.144 kJoules/mol is an average value based upon many common organic reactions.

#### Calculation methodology.

A) If the option “**By number of samples**” has been selected, Dream Report will assume that one period is taken into account. Start of that period will correspond to the start time of that object definition. Timestamp of the last considered value point will be taken as the end of the period. The minimum, the maximum values and all the Mean Kinetic Temperature calculation will be taken for that period, described above, regardless of the end of the period in object definition.

If the number of received values (from the database) for the Mean Kinetic Temperature calculation is less than the defined maximum of samples, then all the entire object period will be considered for calculation and all received available values will be used for calculation.

B) If the option “**By number of periods**” is selected, then Dream Report will consider the entire time period, defined in the object as the base period for the end calculation. Then it will split that entire time period into the number (defined in the Mean Kinetic Temperature configuration) of equal parts, calculate the minimum and the maximum values for each of those smaller parts (periods) and use that for the entire calculation.

C) If the option “**By defined periods**” is selected, then Dream Report will split the entire object time period into the number of equal parts, where the length of each part will be equal to the one, defined in the Mean Kinetic Temperature configuration (similar to the bar graph period split). Then the minimum and the maximum values will be calculated for every such a period part and they all will be considered for the entire result calculation.

#### NOTES:

- When either option “**By number of periods**” or “**By defined periods**” will be selected, Query with the previous point must be used, i.e. start of each sub-period should have the actual value for that point of time. **Min** and **Max** values will be calculated for each sub-period and then will be used within the main calculated formula.
- When option “**By defined periods**” is used, then only the whole complete sub-periods will be considered for calculation





**Example:** if the period is "18:00 – 21:30" and the sub-period is 1 hour, then only 3 sub-periods (18:00 - 19:00; 19:00 - 20:00; 20:00 - 21:00) will be used.

## Performance Analysis Functions:

- **ON Counter** - calculates how many times, during the specified time period, the value changed from zero to a non-zero value.

**Example:** If, during the specified period, the following values were found: 1, 0, 0, 1, 0, 1, 0 - then *ON Counter* will return 2, because the value changed from 0 to 1 only twice.

- **OFF Counter** - calculates how many times, during the specified time period, the value changed from a non-zero value to zero.

**Example:** If, during the specified period, the following values were found: 1, 0, 0, 1, 0, 1, 0 - then *OFF Counter* will return 3, because the value changed from 1 to 0 three times.

- **ON/OFF Counter** - calculates how many times, during the specified time period, the value changed from zero to a non-zero value and then changed back to zero.

**Example:** If, during the specified period, the following values were found: 1, 0, 0, 1, 0, 1, 0 - then *ON/OFF Counter* will return 2, because the value changed from 0 to 1 and back to zero twice.

**\*NOTE:** "Found Values" means those values, that are in the Dream Report database or the External History server with the correct timestamp and a "good" quality.

- **Running Time** - calculates the time period when the value was recorded into the database as 1 ("non-zero").

**Example:** if the motor was turned on during the period between 12.00 and 14.00, then the item value of the motor performance was recorded as "1" (non-zero) during this time period. So, the period of 2 hours will be considered as the running time (up time) of the motor performance.

- **Down Time** - calculates the time period when the value was recorded into the database as 0.

**Example:** if the motor was turned off during the period between 14.00 and 17.00, then, the item value of the motor performance was recorded as zero during this time period, So, the period of 3 hours will be considered as the down time of the motor performance.

- **System availability** - calculates and displays which part of the total defined period the system was available. The calculation is done as follows: first, calculate the duration when the selected item had a non-zero value. Afterwards this time period is divided by overall time period associated with that of the object and is multiplied by 100%. The result is the percentage (%) of the overall period the item had a non-zero value.

**Example:** If we calculate the system availability between 12:00 and 14:00, where between 12:00 and 13:00 the item value was "1" and between 13:00 and 14:00 item value was zero, then the time period, where this item was non-zero, is 1 hour (12:00-13:00) out of 2 hours in total (12:00-14:00), so  $(2/4) * 100\% = 50\%$ . So, the result of this example will be **50%**.

When the *System Availability* statistical function is used, "%" is automatically added as a unit if no other unit is specified. To remove % as a unit, please, define a space as the unit " ".





## Energy Management Functions:

- **Produced Energy** - calculates the amount of energy released during the period of some production process. If a user will select this statistical function for the report, then, he will have to select from the corresponding drop down boxes the type of fuel (gas, coal, mazout) and the type of units (MCal, GCal, Mj, Gj), which will measure the energy produced (see pic. below):

Select Statistical Function

Produced Energy Fuel type Gas Units MCal

- **Produced Emission** - calculates the amount of gases emitted during the period of some production process. If a user will select this statistical function for the report, then, he will have to select from the corresponding drop down boxes the type of fuel (gas, coal, mazout) and the type of gases, which will measure the emission produced. This section will have the same boxes as the **Produced Energy** option.

## Batch Functions:

- **Batch ID** - displays the ID of the batch, used as the time period for the calculation. If the range of batch IDs is used, then the ID of the first batch from the range will be displayed. And the total period will be taken for report generation.  
This function can be used only with batch-based time period and is not relevant for time-based periods.
- **Batch start time** - displays the start time of the batch, used as the time period for the calculation. If the range of batches is used, then the start time of the first batch from the range will be displayed.  
This function can be used only with batch-based time period and is not relevant for time-based periods.
- **Batch end time** - displays the end time of the batch, used as the time period for the calculation. If the range of batches is used, then the end time of the last batch from the range will be displayed.  
This function can be used only with batch-based time period and is not relevant for time-based periods.
- **Batch duration** - displays the duration of the batch, used as the time period for the calculation. If the range of batches is used, then the duration between the start time of the first batch and the end time of the last batch from the range will be displayed.  
This function can be used only with batch-based time period and is not relevant for time-based periods.

## Set Point Analysis Functions:

There is a group of statistical functions with a different configuration:

- **Start time of stable period**
- **End time of stable period**
- **Duration of stable period**
- **Setpoint stability result**
- **Counter of stable periods**
- **Rate of change before entering stability zone**
- **Rate of change after exiting stability zone**

If any of these statistical functions is selected, then, the button "[Select setpoints](#)" will appear next to the statistical function combo box:

Select Statistical Function

Duration of stable period Select setpoints

If a user clicks on the button "[Select setpoints](#)", the dialog box with setpoint selection will be opened, where a user will be able to select one or several setpoints:

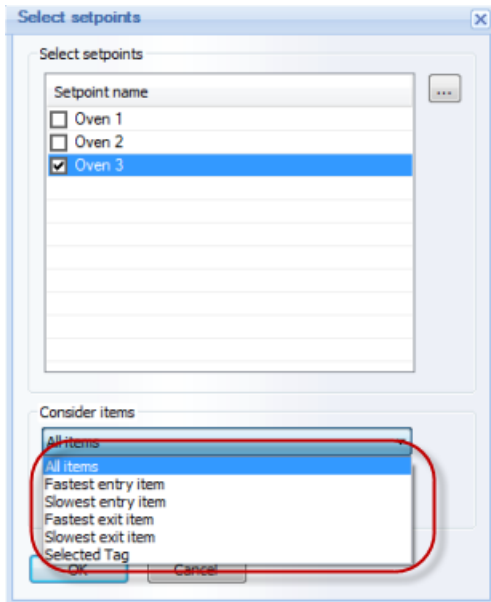

User can select one or more setpoints. Then the check box next to each setpoint will become checked.

If no setpoints have been selected, user can click on ... (browse) button on the right. Then the [Setpoint Analysis Configuration](#) dialog window will be opened.

(For details on how to create setpoint definitions, please, go to the section [Setpoint Stability Analysis](#).)

Group box “**Consider items**” will have a combo box with 6 entries: “**All items**”, “**Fastest entry item**”, “**Slowest entry item**”, “**Fastest exit item**”, “**Slowest exit item**” and “**Selected Tag**”. The default selection is “**All items**”.

If the “**All items**” option will be selected, then the function will calculate all items/ tags, which have entered and left the stability period. Then the function will do its main calculation for all the items from that setpoint.

If the “**Fastest entry item**” option will be selected, then the function will calculate the item/ tag, which has first reached the stability period (the one, which has the earliest timestamp of the first value within the stability period). Then the function will do its main calculation only for that item and not for all items from that setpoint.

If the “**Slowest entry item**” option will be selected, then the function will calculate the item/tag, which has last reached the stability period (the one, which has the latest timestamp of the first value within the stability period). Then the function will do its main calculation only for that item and not for all items from that setpoint.

If the “**Fastest exit item**” option will be selected, then the function will calculate the item/ tag, which has first left the stability period (the one, which has the earliest timestamp of the first value out of the stability range after stability period end time). Then the function will do its main calculation only for that item and not for all items from that setpoint.

If the “**Slowest exit item**” option will be selected, then the function will calculate the item/ tag, which has last left the stability period (the one, which has the latest timestamp of the first value out of the stability range after stability period end time). Then the function will do its main calculation only for that item and not for all items from that setpoint.



If the "Selected Tag" option will be selected, the "Setpoint Tags" selection box will appear:

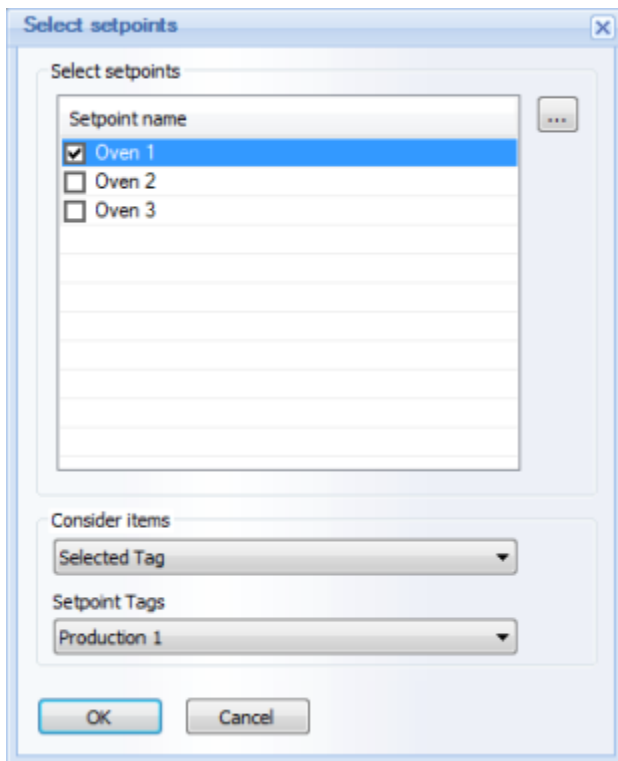

The dropdown menu will include all the items/tags for the setpoint selected.

When a user will select the item/tag he may need for the calculations, the function will calculate that item/tag, which has entered and left the stability period. Then the function will do its main calculation only for this item from that setpoint.

If a user will select one of the functions from the **Setpoint stability** group (please, see the list above), then, it will perform one of the statistical functions described below:

- **Start time of stable period** calculates the start time of stability period of the selected setpoint. It takes the selected setpoint and gets values of all items/tags defined for that setpoint for the calculation period, defined in that object. This function detects the time, when values of all tags have entered the "stability zone", e.g. are within setpoint value +/- tolerance. If more than one setpoint is selected, the function calculates start time for every defined setpoint and then displays the first one between all of them. If during the object calculation period all tag values have never entered together into the stability zone, the object result will be N/A.
- **End time of stable period** calculates the end time of stability period of the selected setpoint. End time of stability zone means the timestamp, when last item/tag value has left the stability zone. If it calculates the result for multiple selected setpoints, then it will calculate the result (end time) for each setpoint and then display the last one.
- **Duration of stable period** calculates start and end time for one or several setpoints, and then displays the period (duration) between start and end time.



- **Setpoint stability result** calculates the result, which is true or false. The function gets all values of each item/tag of the setpoint for the interval between start and end time of every setpoint, and checks if all values of all tags are within a setpoint value +/- tolerance. If multiple setpoints have been selected, this analysis will be executed separately for every setpoint. The result of this function will be TRUE if all values of all tags during a stable period of each zone are within the setpoint value +/- tolerance, and will be FALSE if any value is out of range during stability periods.
- **Counter of stable periods** calculates and then displays the number of the stable periods for one or several setpoints selected.
- **Rate of change before entering stability zone** calculates rate of change of item/tag values of the setpoint before entering stability zone (for details on how to configure the criteria for this statistical function calculations, please, see section [Setpoint Stability Analysis](#)).
- **Rate of change after exiting stability zone** calculates rate of change of item/tag values of the setpoint after exiting stability zone (for details on how to configure the criteria for this statistical function calculations, please, see section [Setpoint Stability Analysis](#)).

### Alarm Analysis Functions:

- **Counter of alarms** calculates the number of alarms, which occurred during the specified time period, and which match the selected alarm filter.  
If **Counter of logged alarms** is selected, click on **Filter**, and select an alarm filter from the dialog window **"Alarm Filter Manager"**, which is described in the [Alarm Filter](#) section:

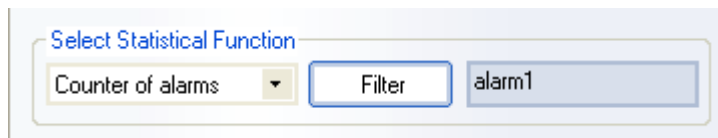

### Direct SQL Query:

- **SQL Query** performs a predefined SQL query in the selected database

If **SQL Query** is selected, click on **"Define SQL Query"**. In this case the result will be the result of the query - i.e. the history type, source, item and time period will not be applied.

Functionality of SQL query editor window is described in details in its dedicated section **Edit SQL Query**.

Any standard SQL query can be specified, but only the first row in the result set will be displayed. The value can be of any type. If received value type is not numeric, it will be displayed as a string.

### IMPORTANT NOTES:

- When using statistical function "SQL Query" in a Single Data Object and recording its values using analytical driver, the analytical item group in the data logger should be configured with a periodical record rate **"Each"** and not **"On Change"** or **On Update** - this is a limitation within the logger.
- When using an MS Access database and column names or table names starting with "\_" or other non alphanumeric character, enclose the name with square brackets (e.g. [\_MyTable] or [\_MyColumn]). This is not required for SQL Server databases.



### Pulse Analysis Functions:

- Number of Pulses** calculates and returns the counter of pulses during a specified period of time. If a user selects this statistical function for the report, then, he will have to select from the "Pulse type" combo box one of the options for the type of pulse wave to be considered: "+" ("positive", i.e. the upper pulse wave) or "-" ("negative", i.e. the lower pulse wave), and the value for this pulse wave from the "Value" ("Entry Value") edit box (this edit box can accept double values ("+", "-", whole and decimal)):

For pulse explanation and its detection display, please see the picture below:

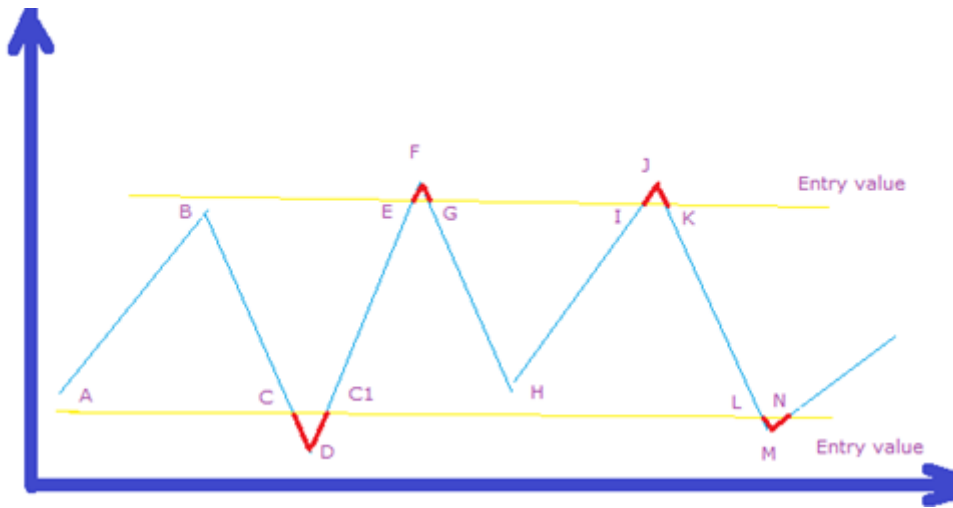

A pulse is counted only when the value crosses the "Entry Value" line.  
 A **positive pulse** is counted only when this pulse is in the top part (e.g. E-F-G and I-J-K)  
 A **negative pulse** is counted only when this pulse is in the bottom part (e.g. C-D-C1 and L-M-N)  
 Points A, B and H are not counted as pulses as they haven't reached the "Entry Value".

- Peak Maximum Value** calculates maximum value for **positive pulses** only.

If a user selects this statistical function for the report, then, he will have to define the value for the pulse wave from the "Value" edit box (this edit box can accept double values ("+", "-", whole and decimal)) and the pulse sequence during the process in the "Pulse ID" edit box (please see the pic. below):

**Example:** on the picture above E-F-G is the **positive pulse #1** and I-J-K is the **positive pulse #2**.

If this parameter is empty, the statistical function will calculate maximum for all pulses for the entire period, i.e. just a simple maximum value over the object period.

**NOTE:** Value and Pulse ID edit boxes can accept dynamic parameters (f#).

- Peak Minimum Value** calculates minimum values for **negative pulses** only.



If a user selects this statistical function for the report, then, he will have to define the value for the pulse wave from the "Value" edit box (this edit box can accept double values ("+", "-", whole and decimal)) and the pulse sequence during the process in the "Pulse ID" edit box (please see the pic. below):

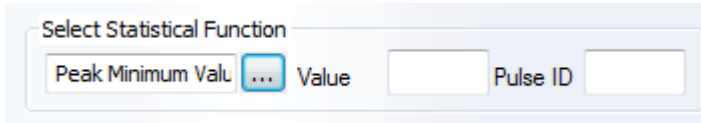

**Example:** on the picture above C-D-C1 is the *negative pulse #1* and L-M-N is the *negative pulse #2*.

If this parameter is empty, the statistical function will calculate minimum for all pulses for the entire period, i.e. just a simple minimum value over the object period.

**NOTE:** Value and Pulse ID edit boxes can accept dynamic parameters (f#).

### Manual Input:

- If **Manual Input** is selected, then the "Default Value" parameter combo box will be displayed next to the **Select Statistical Function** combo box:

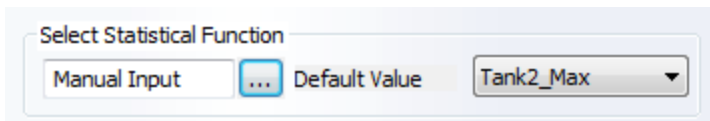

It will be filled with the list of all simple statistic objects (Single Data objects, Compound objects, Expression objects), defined in that report.

If a user will want to set a static value as default for **Manual Input**, then he can create an expression object, assign it a static value, and then select it as default for **manual input**.

When user will select a data item (**Select Data Item**), this data item will be used as a target to write input value into. Also the data validation will be done: if user will try to input a value and its target tag will be a manual parameter, the data validation parameters will be applied. If input value will be incorrect, the value will be displayed in the edit box as red, and if user will click on the push button with "Refresh report" function, an error message will be displayed and operation won't be undertaken.

### Result Representation

Such an object will be displayed in the report only as an edit box. User will be able to select it in the DR Designer Studio and change its size and font properties. When displayed in a report in the DR studio, it will contain a value of its statistical objects.

**Example:** If an object is displayed in the studio as **#object**, then edit box will contain the text "**#object**".

This edit box result representation will be available only in web reports. If report is opened in the DR Web Portal in the web format, the calculated/default value will be written in the edit box control. That value can be changed manually.

If an action button with "Refresh report" function is defined, then user will be able to enter different manual values and re-calculate report using those manual values.

If user enters manual value into the edit box, this object won't be re-calculated and manual value will be used instead of "Refresh report" action. If edit box is empty, then during "Refresh report" operation, the object value will be re-calculated according to its definition.



## Ocean Data Systems

If report is generated by schedule in PDF, the object value will be displayed in PDF (as default result representation) without any edit box.

For details on "[Refresh report](#)" action, please see [Action Button](#) section of this manual.

### NOTES:

- Single data objects with the "[Manual input](#)" statistical function will be displayed ONLY in a web report. When generating a regular PDF or Excel report those objects will be invisible.
- If [Manual Input](#) function is used in a Step table, then all input values will use a date for each value, which will correspond to the row, where that value was entered into.

After selecting the statistical function and data, select the [time period](#).

**NOTE:** For Single Data Objects the "[Manual Input](#)" time definition option is available.

The time period for a statistical calculation is described in details in the [Time Definition](#) section of this manual.

The period defined for the object can also be [Batch-based](#). This is also described in details in the sections [Batch Definition](#) and [Time Definition](#).

The [Result Representation](#) section describes how to format the results (decimal precision, added unit etc.).

The [Advanced SQL Condition](#) section describes how to configure advanced filters for the processed values.

### Examples of the Single Data objects:

Statistics	Absolute/Relative	Fixe Period	Batch Period	Batch ID	Timestamp
	From Jan 1st at Today	Last Month	Last Batch	Batch_56	
First Value	150 m3	1350 m3	1125 m3	31/05/2007 08:00:13	First Value
Last Value	975 m3	1350 m3	1485 m3	04/06/2007 15:13:00	Last Value
Maximum Value	1485 m3	1485 m3	1485 m3	02/06/2007 10:00:00	Maximum Value
Minimum Value	150 m3	150 m3	150 m3	02/06/2007 11:00:00	Minimum Value
Average Value	1139.81 m3	1136 m3	1248 m3		
Weighted Average	1133.46 m3	1149 m3	1264 m3		
Integral Value	53682482385	2923296990	469635975		
Sum Value	7502235 m3	409095 m3	69885 m3	103:12:47	Run Time
Standard Deviation	366	372	283		

(i) - Free table was used to present data

**NOTE:** This example of the single data objects in the generated report demonstrates different single data objects with different statistical functions selected like [First Value](#), [Last Value](#), [Maximum Value](#), [Minimum Value](#), etc. with different time periods defined. The results are represented in the format of the free table.





## Designer Studio - Compound Data Object

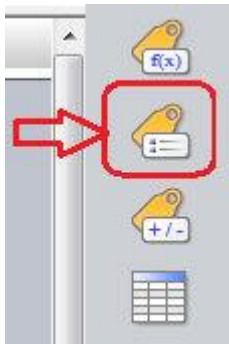

**Compound Data Object** is a statistical field, which performs analytical calculations between the results of two or more other statistical or analytical fields in the given report.

To add this object, please, click on the *Compound Object* button (second from the left) on the Report Designer Studio **Elements** toolbar. Mark in the workspace the rectangle where desired data will be displayed.

**Object Name** must be a unique logical name, which will be used in further work with that object within the project. The object name can be up to 64 characters long. Only alphanumeric characters and "\_" are allowed. The first character cannot be a number.

**Object Description** is a label to help users quickly understand purpose of the object. The description can be up to 256 characters long. All characters are allowed.

**Defined Object List** contains a list of all statistical objects in the report.

**Item Filter** is used to limit the items/tags for a specific object within the user-defined properties. If a user has many items/tags stored, and will need only some of them for this particular compound object display, he will only have to define in the **Item Filter** edit box the name for the items/tags he may need. They will be filtered according to the Item Filter name, and will appear in the **Available Data Items** box.

User can select two or more objects in the **Defined Object List** using the **CTRL** button. The object will perform the selected calculation between the selected objects.



**Select Function** contains a list of available statistical functions as follows:

- **Minimum** - calculates the minimum between the results of the selected data objects
- **Maximum** - calculates the maximum between the results of the selected data objects
- **Average** - calculates the average of values from the selected data objects
- **Sum** - calculates the sum of all values from the selected data objects.
- **Standard Deviation** – calculates standard deviation from the result values of all selected data objects.

The format of the result (decimal precision, added unit etc.) is described in details in the **Result Representation** section.





## Designer Studio - Expression Data Object

**Expression Data Object** is an object, which accepts a manually entered expression involving one or more statistical objects, mathematical operators and constants. Dream Report supports the use of the **Lua** scripting language for conditional calculations and functions in the **Expression Data Object**. Lua is a powerful scripting language that greatly extends the capabilities of Dream Report.

To add this object click on the **Expression Data** button on the Report Designer Studio **Elements** toolbar:

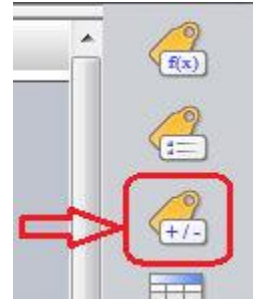

Then, draw a rectangle in the report page, where the object will be placed. The **Expression Data Object** definition dialog window will be opened:

**Object Name** must be a unique logical name, which will be used in further work with that object within the project. The object name can be up to 64 characters long. Only alphanumeric characters and "\_" are allowed. The first character cannot be a number.

**Object Description** allows users to quickly understand the use of the object. The description can be up to 256 characters long. All characters are allowed.

The **Add dynamic object from report** option allows users to select a data object to add to the expression. To use this, choose an object from the combo box and click the **Add** button. The object name will be added to the expression edit box. To remove the last object inserted from expression, click **Delete**. The selected dynamic object will be added in the format of **[f#<Field Name>]**.

Note that if any of the dynamic objects in an Expression Object shows N/A, then all values in this Expression Object will be shown as N/A.

**NOTE:** The **Expression Object** can perform calculations with the data from the footer of a **Step Table** in the report. If Step Table has the footer defined, objects from this footer will be added to the list of dynamic objects of the report (**Add dynamic object from report** section) in the format of **[footer#<Table Name>:<Object name>]** and they (objects) will be available for calculations in Expression Object. The footer will be added to the list of dynamic objects in the report only if Step Table has its name defined.

For details on footer definition, please go to the **Step Table** section of this manual.



If you wish to use the **Multi-Line Editor** in the **Expression** object, click the **[...]** button at the right of the expression. This will open an edit box with extended height and input text, and with multi-line editing capabilities. This edit box will display the inserted text in multiple lines, for improved readability and report layout:

```
Script editor
1 (function()
2 if [i#PLCData.InPressure.PV] < 20
3     AND [i#PLCData.FeedPump] == 0
4     AND [i#PLCData.Mixer] == 0
5 Then Return 1
6 Else Return 0
7 end)
8 ()
```

Show line number      Add Dynamic Token

OK      Cancel

The “**Add Dynamic Token**” will open a window to allow the user to select objects (“Dynamic Tokens”) from the report to include in the expression. Clicking the drop-down on that button will give the option to “**Add script function template**” - this is useful when starting to build an expression function from scratch. The following code will be added to the Script Editor:

```
Script editor
1 (
2 function()
3 --place your code here
4 end
5 ) ()
```

**NOTES:**

- If you add the **Date and Time** dynamic object, it will be added in the format of **[dt#<object name>]**
- If you add the **Combo Box** dynamic object, it will be added in the format of **[cb#<object name>]**
- If you add the **Timestamp Picker** dynamic object, it will be added in the format of **[tp#<object name>]**

For details, please see [List of Dynamic Tokens](#) section.



The [Select Data Item](#) section allows user to select and add any data item from any available data source to the expression. Click the [Add](#) button to add the selected item to the expression in the format **[i#<item name>]**, where "i" means "item name". When calculating the result for the expression, Dream Report will get the current value of the data item and replace **[i#<item name>]** with the current value.

For details, please see [List of Dynamic Tokens](#) section.

To add mathematical or logical operators, click on the appropriate button and it will be added to your calculation expression.

The calculation expression can be edited manually as well, directly in the expression edit box.

The functions Sin, Cos, Tg, SQRT, Ln, Log and Abs must be in the format: **Fn(x)**.

Where **Fn** - is one of those functions and (x) is a function argument, which can be either a constant or a data item value or a statistic object.

The **Log** function calculates a base 10 logarithm and **Ln** calculates a natural logarithm (with base **e**).

### Calculations with Times and Time value types:

An expression object supports calculations using Single Data Objects created with a statistical function "Timestamp of first value", "Timestamp of last value", "Timestamp of minimum value", "Timestamp of maximum value" or "Duration in the interval". In these cases, a user can make mathematical calculations with those objects and constants. During calculation, any such value of a date/time type will be converted into a long integer type representing the number of seconds since 1 January 1970 expressed in UTC, and then the calculations will be performed and the result converted back to a time format, again in UTC.

**Example 1:** A Single Data Object "On\_Duration" is defined to calculate "Duration in the interval" when the ventilator was running and then an expression object is defined to calculate an average running time of the ventilator per day, i.e. ("On\_Duration"/24). If result of calculation of "On\_Duration" is 06:00:00 (6 hours), then the result of expression object will be 00:15:00 (i.e. 06:00:00/24).

**Example 2:** If a user has to calculate the interval between the first value and the last value, define 2 Single Data Objects "TimeOfFirstVal" and "TimeOfLastVal", then the calculation can be done in an expression object, which will have the following definition: (TimeOfLastVal - TimeOfFirstVal).

If TimeOfLastVal = 12:30:00 and TimeOfFirstVal = 12:05:00, then the result value will be 00:25:00.

The format of the output (decimal precision, unit, advanced visualization etc.) is described in details in the [Result Representation](#) section.

### Operations with Strings:

Expression object allows few operations with strings, such as: concatenation string to a string, concatenation numeric result with a string, having result as a string, extraction left or right or mid part of a string, converting numeric value into a string. This can be done as follows:

- Concatenation. Strings concatenation is done using the operator.

**Example 1:** If you need to concatenate a string tag "BatchName" value with another string "MyString", then the syntax will be: **[i#OPC.BatchName] .. "MyString"**

**Example 2:** If you need to concatenate a numeric tag to a string, the syntax will be: **[i#OPC.Ana\_01] .. "\_MyString"** - the result will be: **10.00\_MyString**



- Extracting left or right part of a string is done using functions: `left(<argument>, <num of chars>` or `right(...)`. The result will be extracted string.  
**Example 1:** Extract 3 left chars from a string "3.1415". The syntax will be: `left("3.1415", 3)`. Result will be: "3.1"  
**Example 2:** Extract 3 right chars from a string "3.1415". The syntax will be: `right("3.1415", 3)`. Result will be: "415"  
**NOTE:** if you need to extract a part of value of statistical object or item value - then item name or statistical object name must be taken in quotation marks.  
Example: `left("[f#_sdo1]",3)`
- Converting numeric value into a string can be done using a function: `tostring(<numeric expression>)` - it will calculate a numeric expression and convert the end result into a string.  
**Example:** `tostring([f#_sdo1] + [f#_sdo2])` - it will calculate a sum of two numeric objects (`_sdo1` and `_sdo2`) and then return the result as a string.

### ToNumber() Function in Expression Objects

"ToNumber()" is a ToString() function, which converts its argument to a number. This function works as follows:

- "+" or "-" sign in front of a string are correctly handled  
**Example:** `ToNumber("+123")` or `ToNumber("-123")` will give a result of 123 and -123
- Spaces are accepted if they are at the start or end of the text or both  
**Example:** `ToNumber(" +123")` or `ToNumber(" -123")` as well as `ToNumber("+123 ")` or `ToNumber("-123 ")`, or `ToNumber(" +123 ")` and `ToNumber(" -123 ")` will give a result of 123 and -123
- All non-numerical characters inside the string result in a "N/A"  
**Example:** `ToNumber("+12 3")` will give N/A, `ToNumber("-12A5")` will give N/A
- The decimal sign must be '.' to be converted, N/A otherwise  
**Example:** `ToNumber("12.5")` will give 12.5 or 12,5 depending on Report Localization Settings, `ToNumber("12,5")` will give N/A even if user's PC regional settings are set to use the ',' as the decimal separator.

### Conditional calculations

Expression object also allows doing conditional calculation, i.e. set a condition, and if condition is true, use one calculation expression. If condition is false, use another calculation expression. The format for such an expression is the following:

`(function() if <condition> then return <calculation expression 1> else return <calculation expression 2> end end)()`

**Example 1:** `(function() if [f#_sdo1] < [f#_sdo2] then return "abc" else return "xyz" end end)()`

**Example 2:** `(function() if [f#_sdo1] == [f#_sdo2] then return "abc" else return "xyz" end end)()`

**NOTE:** For complete list of the conditional calculations and functions available in **Expression Data Object**, please see the reference manual at <http://www.lua.org/manual/5.2/>



Please find below examples of how LUA script can be used in a Dream Report Expression object:

Object Name	Expression Text	Result
expS	"string"	string
exp2	(function () local s, e = string.find("[#expS]", "t") return s end)()	2.00
exp2_1	(function () local s, e = string.find("[#expS]", "a") return s end)()	N/A
exp2_2	(function () local s, e = string.find("[#expS]", "tri") return s end)()	2.00
exp2_3	(function () local s, e = string.find("[#expS]", "tri") return e end)()	4.00
exp3	(function() return os.time({ year = 2012, month = 8, day = 30, hour = 6, min = 32, sec = 1, dst = true }) end)()	1 346 301 121.00
exp4	(function() return os.date("%Y-%m-%d %H:%M:%S", [#exp3]) end)()	2012-08-30 06:32:01

### Using a LUA Expression to Execute a SQL Statement

Dream Report includes a function that enables users to execute a SQL statement (SQL query or stored procedure) from inside a LUA script, and return the results as a comma-separated list. Any variables or reporting objects can be used as parameters in the SQL statement, making the SQL statement dynamic. Also, the results of SQL query can be received back to the Expression object, and processed by the script as required.

The **UserFuncSqlExecuteQuery()** function is included in the *User Lua Library*, located in the current Dream Report project folder - e.g., C:\ODS\Dream Report\Project\MyDR\_Project\UserLuaLib.lua, and is used in an Expression object as follows:

**UserFuncSqlExecuteQuery(<DSN>, '<SQL statement>')**

where <DSN> should be replaced with the name of a DSN defined in the Dream Report [DSN Manager](#), and <SQL statement> should be replaced with a valid SQL statement. The SQL statement can be dynamic, by referencing dynamic tokens on the report.

The following function call in an [Expression](#) object, which references a project DSN named "process":

**UserFuncSqlExecuteQuery('process', 'SELECT DISTINCT Material\_Desc FROM MES\_Data Order by Material\_Desc')**

Returns the following when the report generates:

Capsule Filling #1,Capsule Filling #2,Powder Fluid Mixing #1,Powder Fluid Mixing #3,Powder Fluid Mixing #5

**NOTE:** The use of square brackets to designate field names in a SQL query (e.g., - [Select \[Material\\_Desc\] From...](#)) is not supported in the LUA expression script. This is because Dream Report dynamic tokens are specified with square brackets (e.g., [\[#\\_MaxTemp\]](#)), and the script parser would consider the SQL field as a dynamic token delimiter.



### Dynamic Control for Reporting Objects Position by LUA Script

Dream Report scripting functionality enables controlling the position of reporting objects from LUA script. Using LUA script in an Expression object, a user can dynamically set the position of every object (which can be calculated) so the position of any object (e.g. picture, chart, etc.) on a report page will be defined at the moment of generation, depending on report values/calculations. The following functions can be used in LUA scripts to get and set object positions and properties on a report:

```
OdsLuaObjSetPropertyValue()  
OdsLuaObjSetPropertyValue()
```

#### Example

In the following example, the LUA script (below) in the **Expression** object (“#expr”) will get the integer value of the #valueExpr, and based on that value, will show/hide line segments, and locate the triangle accordingly:

Report configuration in Dream Report Studio:

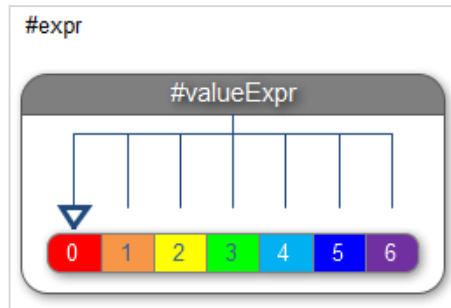

```
(  
function()  
  
item = [f#valueExpr]  
  
id = '[uuid#fb86c3c8-2574-469c-8837-c53ff707c97f]'  
  
-- Identify report objects by UUID  
lineid1 = '[uuid#2574c726-1cfb-4f9d-8760-c339bf4db561]'  
lineid2 = '[uuid#511652f0-1183-4e50-a8a5-2a52c3b60d93]'  
lineid3 = '[uuid#9cb53028-df27-4b2a-8910-9469dd07b135]'  
lineid4 = '[uuid#3e0140da-480b-4738-abf7-fa32eddb8f05]'  
lineid5 = '[uuid#a098d7ed-150b-4ed0-b25a-32156e747631]'  
lineid6 = '[uuid#39d1a72c-3bc2-495a-bfe9-89ed76e74db4]'  
lineid7 = '[uuid#6f72eea7-ea6e-4d29-a89e-efd3d44de02a]'  
  
lineids = {lineid1, lineid2, lineid3, lineid4, lineid5, lineid6, lineid7}  
  
if item > 0 then  
    val = math.floor(item + 0.5)  
else  
    val = math.ceil(item - 0.5)  
    val = -val  
end  
  
pos = OdsLuaObjGetPropertyValue('', id, 'Position')  
xpos = OdsGetAt(pos, 1)  
delta = 8  
  
lineid = -1  
  
if val == 0 then  
    xpos = xpos + 0  
    lineid = lineid1  
elseif val == 1 then  
    xpos = xpos + delta
```



## Ocean Data Systems

```
lineid = lineid2
elseif val == 2 then
xpos = xpos + delta*2
lineid = lineid3
elseif val == 3 then
xpos = xpos + delta*3
lineid = lineid4
elseif val == 4 then
xpos = xpos + delta*4
lineid = lineid5
elseif val == 5 then
xpos = xpos + delta*5
lineid = lineid6
elseif val == 6 then
xpos = xpos + delta*6
lineid = lineid7
end

for i = 1, 7, 1
do
    OdsLuaObjSetPropertyValue('', OdsGetAt(lineids,i), 'Visible', 0)
end

OdsLuaObjSetPropertyValue('', lineid, 'Visible', 1)
OdsLuaObjSetPropertyValue('', id, 'Position.x', xpos)

end
)()
```

The results on the report, depending on the integer value of *#expr*:

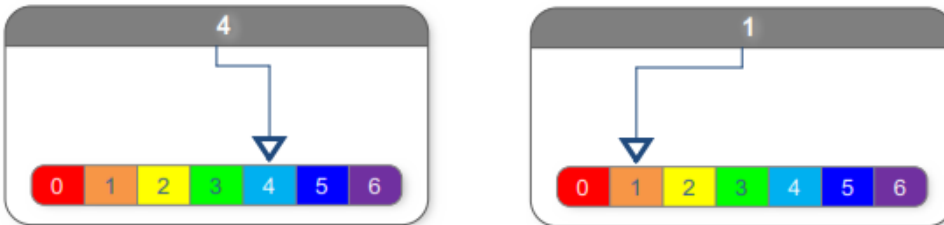

For more information on the use of these script functions, and reporting examples, please contact [ODS Support](mailto:support@dreamreport.net) at [support@dreamreport.net](mailto:support@dreamreport.net).



## Advanced Visualization

**Advanced Visualization** option allows you to enhance visualization of the results of the statistical calculations in your report.

You can specify a list of value ranges of data item, specified in that object, and the text, which will be displayed in the report instead of the result value.

Together with the displayed text, you can specify visual text properties: font size, style, color and background color.

The same text can be used for multiple value ranges (e.g. if you want to display the same text with a different color and font).

If no text is specified for a value range, then, the original result will be specified in the report, but the result representation will use font and text background properties, defined for that value range.

**Example1:** If you specify to display text **STOP** with the value range from 0 to 0, and **RUN** with the value range 1-1, then, if during report generation, the result is 1, then, instead of value 1, the PDF report will contain **RUN**.

**Example2:** If you specify no text and **red bold** font for value range 0-10, and no text and green font for value range 11-20, then, if the result value is 9 - you will see **9** in your report PDF file.

### Using tags to define limit range for Advanced Visualization

Values for advanced visualization can be taken dynamically from real-time tag values. For this, you have to enter tag names instead of values into the **From** or/and **To** edit boxes.

If you double-click on **From** or **To** edit box, the **Select Data Item** dialog box will be open, enabling selection of a tag from any real-time data source.

When generating report, this reporting object will read the real-time value of the selected tag, and then will use this value to define the limit range for advanced visualization.

**NOTE:** If there is an overlap of values in the list of ranges (e.g. ranges 0-10 and 8-15), then the first found suitable range will be considered.

From	To	Display text
0.000000	10.000000	Good
-30.000000	0.000000	Good
30.000000	100.000000	High variation
-100.000000	-30.000000	High variation
-500.000000	-100.000000	Abnormal varia
100.000000	500.000000	Abnormal varia





## Designer Studio - Batch Definition

**Batch Definition** enables users to define a rule to dynamically calculate time periods for report generation. If a report is for a batch process (process loop), where the exact time period and duration are not known in advance, use the batch mechanism of Dream Report.

Click on the command button "**Batch definition**" either on the **Connectivity** ribbon icon on the horizontal toolbar, or on the "**Batch Definition**" button also located on the left vertical toolbar either in the Dream Report Logger Studio or Dream Report Designer Studio menu (see pic. below):

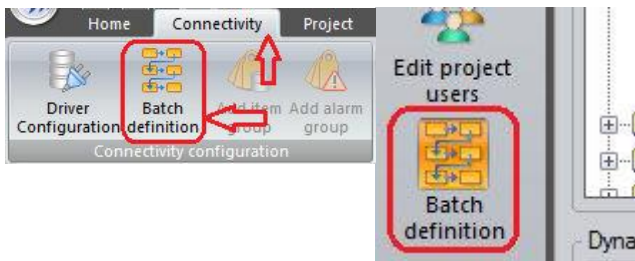

or **Batch definition** button in quick access bar.

The **Batch Definition** dialog window will be opened (see pic. on the right):

To add a new batch definition, click on the **New** button and a new batch definition will be added to the list.

In the **Name** edit box you can edit the name of the batch field (it will update the name in the batch list automatically).

The **Description** edit box can contain a brief explanation of the batch field.

Each batch process is marked by a **unique ID** as this ID will be used later to recognize and distinguish batches (process loops). So, in order to track batches, define the source for batch IDs.

Dream Report batch definitions allow tracking batch IDs by a tag from any real-time data source by logging batch information into internal Dream Report history or retrieving them from an external database in different formats.

Batch in Dream Report can be defined in 2 ways according to the way batch information is stored.

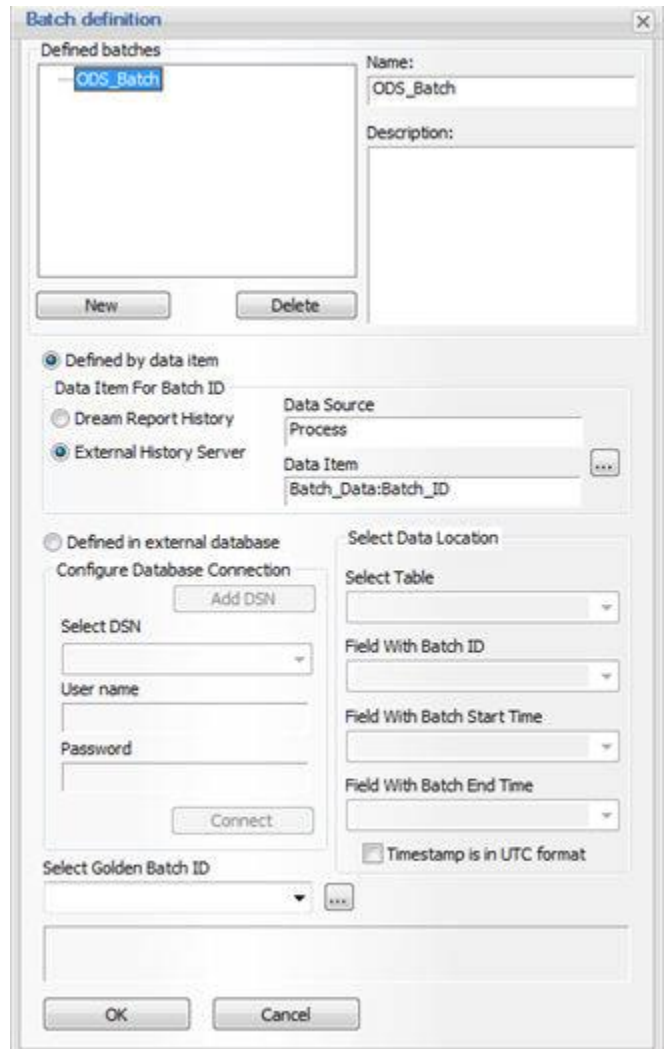



## Ocean Data Systems

1. If the table, where batch information is stored, includes columns corresponding to **Batch ID**, **Batch Start Time** and **Batch End Time**, then select the "**Defined in external database**" option.

Use Select DSN to select the database, where batch information is stored. If the DSN doesn't exist, create it and then continue the batch definition. If the DSN is protected with a login and password, then enter the login and password in the User name and Password text boxes. Click on the "**Connect**" button and Batch Manager will connect to your database via the selected DSN.

After connecting to a database, in the section "**Select Data Location**" specify the location of all data components needed to process the batch information:

- In the **Select Table** combo box select a table, which contains batch information (batch ID, start time and end time)
- In the **Field with Batch ID** combo box select a table column, which contains batch IDs
- In the **Field with Batch Start Time** and **Field with Batch End Time** combo boxes select the table columns, which contain the batch start time and end time.

2. If the table, where batch information is stored, doesn't include **Batch Start Time** and **Batch End Time** columns, select the "**Defined by data item**" option. This option will require only Batch ID column where Batch ID will be recorded periodically.

In the "**Data Item for Batch ID**" section select data source and data item containing batch ID. Then click **OK** and batch definition will be completed.

**NOTE:** Batch process must be continuous and there will be no time interval between consequent batches. **Batch Start Time** will correspond to the Timestamp of the first value of the defined batch (as explained in the formula below):

**Batch\_Start\_Time(Batch\_N)=Timestamp\_of\_First\_Value(Batch\_N)** (where Batch\_N is ID of the defined batch).

"**Batch End Time**" will correspond to the timestamp of the first value of the next batch with the difference of 1 second (as explained in the formula below):

**Batch\_End\_Time(Batch\_N)=(Timestamp\_of\_First\_Value(Batch\_N+1))-1s** (where Batch\_N is ID of the defined batch and Batch\_N+1 is ID of the next batch).

**Batch Start Time** and **Batch End Time** will have time resolution of 1 second (msec will be ignored).

Once batch definition is completed, click **OK** and continue designing your project. During report generation Dream Report will automatically go to the database, analyze the values of a tag defined for the batch, recognize the start and end times of the batch and will then apply those times to the object.

### Timestamp in external database is in UTC format

If batch information is retrieved from external database and batch timestamps are stored in UTC time format and have to be automatically converted to a local time - user has to check the check box "**Timestamp is in UTC format**". Then, Dream Report will know that all requests to the batch database have to be converted from local time to UTC and all timestamp data, read from that database has to be converted back from UTC to local for presentation in reports and Dream Report user interface.



## Golden batch

In the **Select Golden Batch ID** combo box (in the bottom part of the **Batch Definition** dialog window), please, enter the ID of the golden batch for the data comparison. To browse for a specific batch ID from the database, click on the "..."(browse) button, select the time period to search all available batch IDs from, (*Batch IDs in time range*) or select *All batch IDs*. Then the combo box **Select Golden Batch ID** will be automatically populated with all available batch IDs during the specified period. Select any of them to be the *Golden Batch ID*:

The screenshot shows a dialog window titled "Batch Definition". At the top, there is a dropdown menu labeled "Batch IDs in time range" which is currently open, showing two options: "All batch IDs" (which is selected) and "Batch IDs in time range". Below this, there is another dropdown menu labeled "Absolute or relative period definition". The dialog is divided into two main sections: "Start of report period" and "End of report period". Each section has a dropdown menu for "Absolute Date/Time". Under "Start of report period", the date is "3/18/2011" and the time is "09:54:38". Under "End of report period", the date is "5/19/2011" and the time is "09:54:50". At the bottom of the dialog, there are two buttons: "OK" and "Cancel".

As soon as the *Golden Batch ID* is selected, this batch ID will be taken for calculations in any statistical object throughout the reporting project, where time definition is configured for the Golden batch.



## Appearance - Result Representation

The format of results (decimal precision, added unit etc.) of statistical and analytical objects can be defined in the **Appearance** dialog box (in earlier Dream Report versions, this was known as the **Result Representation** configuration).

The **Visible** check box defines whether the result of the entire object will be published in the report or will remain invisible in the output report. This can be useful if object is created for internal calculations and is not intended directly for the report.

The **Select unit to add to result** combo box allows a user to select or enter a string, which will be added to the end result in the output report. The user can select or manually type any string. This can be used to display engineering units for better report readability.

The **Precision of result after decimal point** combo box defines the number of digits to the right of the decimal point. User can select a number between 0 - 6 from a combo box. Other values can't be entered manually.

The **Write Result Back to Data Item** group box enables users to define the output action of the result, i.e. which real-time data source and item the calculation result should be written back to when the report generates.

If the **Write Result Back to Data Item** check box is enabled, then, select the data source and item where calculated statistic result will be written to. The item selection will contain all available data items from all available real-time data sources.

The result will be written to the selected data item each time the statistical object is calculated during report generation.

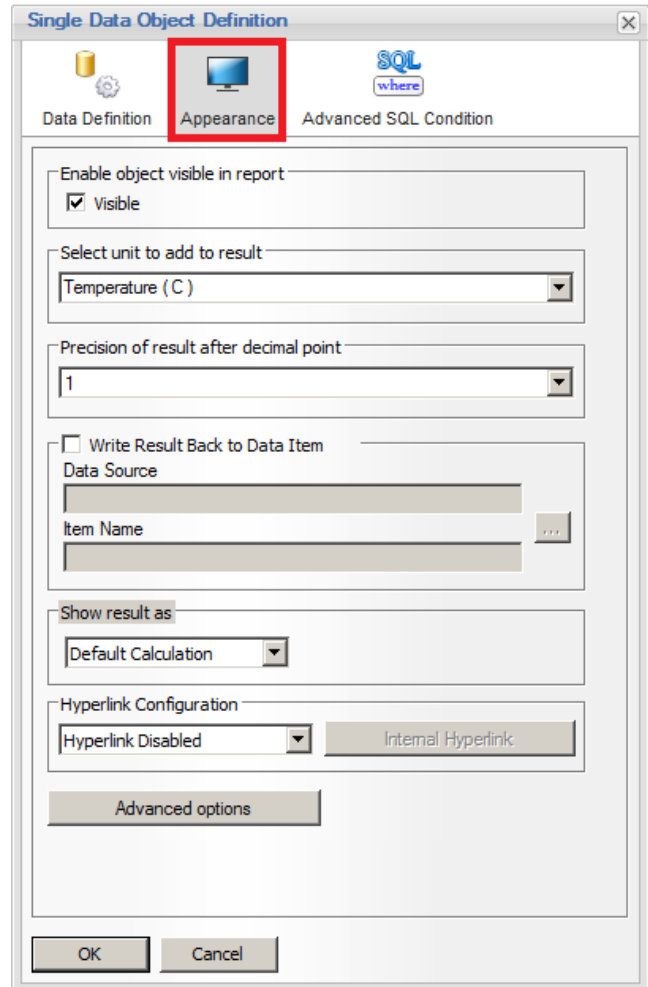

The **Show Result As** section controls the display format for the value. In the left combo box select a type of result output.

By default, the selection is **Default Calculation**. If this output type is selected, the result of statistical calculation will be displayed in its native format.

If **Show result as Barcode** option is selected, select a barcode type in the right combo box, as displayed on a picture above. Dream Report installs several types of barcodes, so a user doesn't have to install anything in addition to the Dream Report.

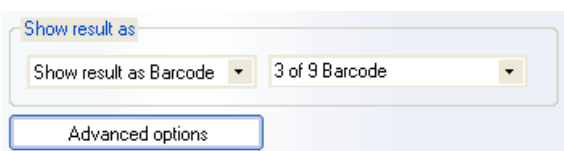



## Ocean Data Systems

If **Calculated as Duration in** option is selected, the result of the calculation will be displayed as a time period in seconds. User can select preferred output format, as shown below. The result can be re-used in other numeric calculations.

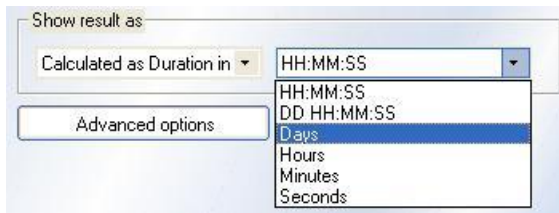

If **Timestamp** option is selected, then the result will be displayed as a timestamp of the report object event logged.

**NOTE:** a timestamp is the time at which an event is recorded by a computer, not the time of the event itself. The difference may be inconsequential: the time at which an event is recorded by a timestamp (e.g., entered into a log file) should be very, very close to the time of the occurrence of the event recorded.

If **Scientific notation** option is selected, then the result will be displayed as scientific format, e.g. if the result is 290472.00, then displayed result in scientific notation will be 2,9e5.

The number of digits after the decimal point will depend on the value, defined in the "**Decimal precision**" combo box, which is in the same window, above.

If **Engineering notation** option is selected, then the result will be displayed in the engineering representation format. The engineering representation format is very similar to the scientific format with the difference that the power value is always multiple of three, e.g. if the result is 290472.00, then the displayed result in the engineering notation will be 290e3, and the same result in scientific representation will be 2.9e5.

The number of displayed values after the decimal point depends on the decimal precision, defined in this object.

If **Display as Widget** option is selected, to the right of this combo box a new button "**Configure**" will appear.

When a user clicks on this button, the following configuration dialog box will be opened:

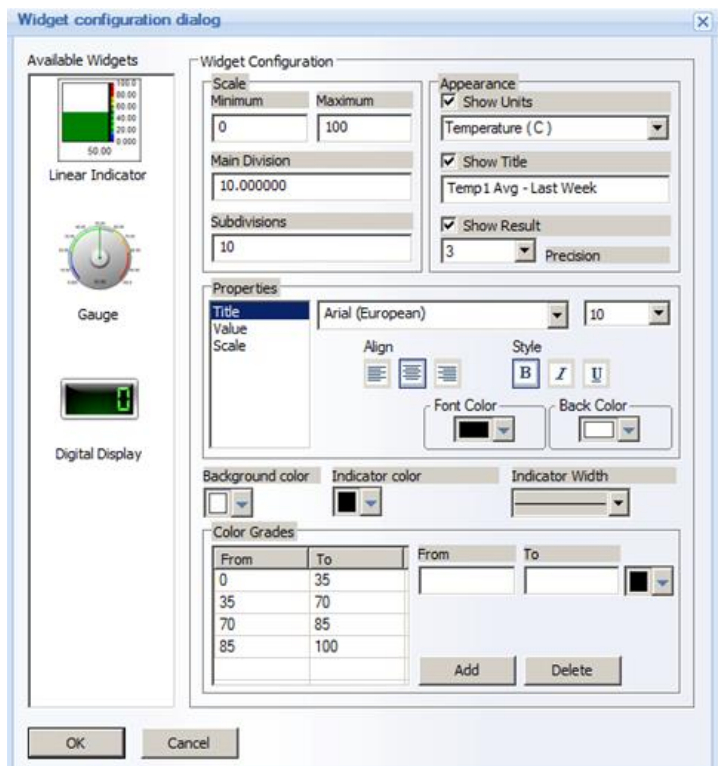



In the **Available Widgets** left-hand section, select a graphical display type: **Gauge**, **Linear Indicator** or **Digital Display**.

### Widget Configuration

#### Gauge and Linear Indicator

In the **Scale** settings section, define the minimum and the maximum values for the limits of the displayed scale on a widget object. This parameter may have any integer or float number. No string values are accepted.

Edit boxes for **Minimum** and **Maximum** value may have either manual static entry or get values from a tag in a standard format: [i#<source>.<tag>]. In this case, when generating report, the object will read values of specified real-time data source and use it for scale limits. For example, user can calculate min and max temperature and use it for scale limits by analytical driver.

By default minimum will be set to 0 and maximum to 100.

The **Main Division** section defines the range between 2 neighbor valued ticks on a scale (major ticks, next to which scale numbers are drawn). This parameter may contain only positive number (integer or float). By default it will be set to 10, e.g. scale will be display 0, 10, 20,... 100 scale ticks.

The **Subdivisions** section defines how many small horizontal lines (scale divisions) will be drawn between 2 neighbor ticks. This parameter may contain only positive number (integer or float). By default this will be set to 10, e.g. 10 tick divisions between 2 scale marks.

The **Linear Indicator** display type will have the following graphical representation (see image on the right):

The **Main Division** here is defined as 10, i.e., the scale displays 0, 10, 20,...100 scale ticks.

**Subdivision** is defined as 5, i.e., there are only 5 small horizontal lines between each of the two neighbor ticks (eg. between 10 and 20, 20 and 30, etc.)

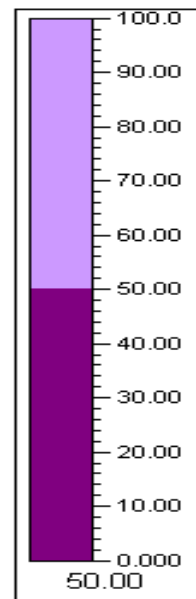



## Ocean Data Systems

The **Gauge** display type will have the following graphical representation:

The **Main Division** here is defined as 10, i.e., the scale displays 0.000, 10.00,...50.00 scale ticks.

**Subdivision** is also defined as 10, i.e., there are 10 small horizontal lines between each of the two neighbor ticks (eg. between 0 and 10.00, 10.00 and 20.00, etc.).

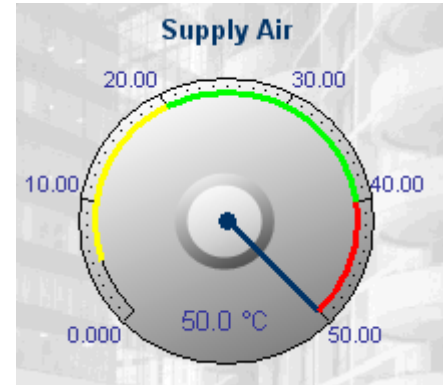

In the **Appearance** section, set visual settings for a gauge or linear indicator object display.

The **“Show Units”** parameter will enable/disable display of a measurement unit on a gauge or a linear indicator object shown. Units can be selected from a standard unit selection combo box or typed in (as it's normally configured in other Dream Report objects). If this option is enabled, then the unit selection combo box will be enabled as well. If this option is disabled, then, the unit selection combo box will be disabled. By default this option is disabled.

The **“Show Title”** parameter will enable/disable display of the object title. If this option is enabled, then, the widget title will be displayed on top of the object. Object title can be specified in the edit box right below the **“Show Title”** check box. If that check box is checked, then, the object title edit box will be enabled. If that check box is unchecked, then, the object title edit box will be disabled.

The **“Show Result”** option will enable/disable digital display (as a digit) of the calculated displayed value in the center of the object. For example, if the displayed value is 60, then, gauge or linear indicator will display 60 units, but also in the middle of the object the number 60 will be displayed as well. By default this option is enabled.

The **“Precision”** combo box will be always enabled and a user can select the required decimal precision. This decimal precision from this combo box will be used both for scale tick marks decimal precision and also for displayed result decimal precision.

If the calculated object (Single Data Object/Compound/Expression object), which includes this widget, already has decimal precision defined in the **Result Representation** section, that decimal precision will be inherited and set in the widget dialog. If a user changes it here, then it will be changed in the **Result Representation** dialog as well.

In the **Properties** section, specify font and background settings for different display parts of that widget objects exactly the same way as it works in other objects.

In the **Color Grades** section, if a user wishes to color some value segments on a scale, he can specify some value ranges and set color for those value ranges. If this is done, then this color will be used as a scale background for this value range on top of the main scale background.

If the **Smooth color transition** option is checked, then on the border between different colored segments, there will be no sharp borders, but color will smoothly transit from one color to another.





## Digital Display

The **Digital Display** widget displays integer or decimal analog values in a digital display format. The **Resolution** option controls the maximum number of digits to display on the widget - this number includes both integer and decimal parts of the number. The number of decimal places to show is set in the object's **Appearance** setting for **Precision of result after decimal point**. For example, if you knew that an analog real tag had a range of 0-250, and you wanted to show a 2 decimal point precision, you'd set the widget's Resolution to "5" - the resulting displayed format would be ###.## (up to 3 digits for the integer part, and 2 digits for the decimal part.) **Note** that if there is a possibility that a signed number (e.g., -97.461) will be displayed, the **Resolution** setting should be increased by 1 digit to account for the "-" sign.

The **Background** color for the digital display is black by default, but can be changed by selecting the **Indicator color**.

The **Digit Height**, **Width** and **Interspaces** can be set in the **Digital Display Sizes** section, and the digital display's border thickness can be set in the **Borders** section.

Finally, the **Digit Color** can be set in the **Digit** section.

Two examples:



Precision of result after decimal point: **2**

Widget Resolution: **5**



Precision of result after decimal point: **3**

Widget Resolution: **6**

## Hyperlink Configuration

The **Hyperlink Configuration** section allows the resulting value on the report to be configured as hyperlink on Web reports. The **Hyperlink Disabled** is the default setting, with **Internal Hyperlink** and **Raw Data Hyperlink** as the additional options.

**Internal Hyperlink** Provides the option to open/generate a report when clicked

**Raw Data Hyperlink** Provides a "raw data" view (in tabular or chart format) of the raw data for that object

### Internal Hyperlink

If **Internal Hyperlink** is selected, the "**Internal Hyperlink**" button will be activated. When clicked, the **Internal Hyperlink Parameters Configuration Dialog** window will open, as shown in the following image:



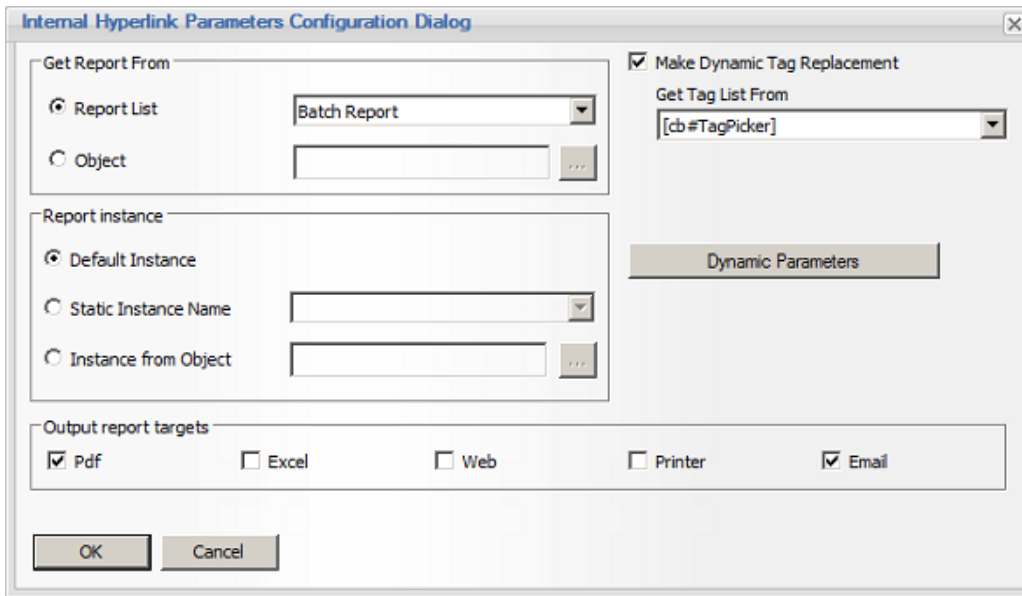

In the “**Get Report From**” section, select the report to open, when the hyperlink is clicked. A specific report name can be selected from the **Report List** option; or, if the **Object** option is selected, a list of dynamic tokens from the current report (combo box, expression object, etc.) or **IPP’s** (internal project parameters) displayed. Select the dynamic object that will contain a valid report name when the report is generated.

If a report contains Virtual **Report Instances** (VRI’s), select either the **Default Instance**, a **Static Instance Name** from the list of available instances, or select the **Instance from Object**, where a list of dynamic tokens from the current report (combo box, expression object, etc.) or **IPP’s** (internal project parameters) displayed. Select the dynamic object that will contain a valid report instance name when the report is generated.

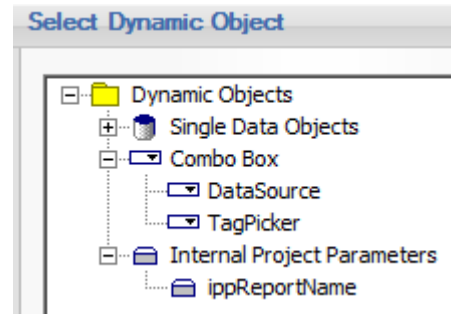

By default, when the hyperlinked-report runs, it will generate with data from the tags defined on the report. By checking the **Make Dynamic Tag Replacement** option, the **Get Tag List From** option will be enabled. Select a **Combo box** object from the main report that contains a list of tags that a user can select from.

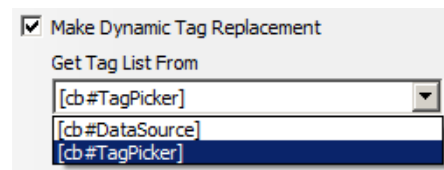



## Dynamic Parameters

The “**Dynamic Parameters**” button opens the **Internal Hyperlink Parameters Configuration Dialog** window, from which various dynamic parameters can be specified to pass into the target (hyperlinked) report - Time Period, BatchID, and any other Parameter(s) needed on the target report:

Parameter Name	Parameter Type
ippReportName	String
ippTankID	Number
ippProductCode	String

In the **Dynamic Generation** section, select either **Time-based period** or **Batch-based period**. If **Time-based period** is selected, select dynamic objects from the report for the **Start** and **End** times. These dynamic objects can be **Timestamp Picker** web elements, or object that contain valid date/time values (e.g., a Single Data object the gets the “Timestamp of First Value” for some tag.) **If Batch-based period** is selected, select a dynamic object from the report which will contain a valid batch ID or list of batch ID’s (e.g., a **Combo Box**).

If other project parameters (IPP’s) need to be passed into the target report (e.g., *Product Code*, *Tank ID*, etc.), these parameters can be specified in the **Pass Parameters Information** section. This sets up a “mapping” IPP’s to specific objects on the source report, so that when the target report opens, all parameters will be set.

The combo box **Set Parameter** will contain the list of all available defined internal project parameters (IPPs). The combo box **Select Parameter Data Source** will contain the list of all relevant objects defined in the (source) report (i.e. with the following object types: Single Data Objects, Compound Data Objects, Expression Data Objects, Combo boxes, Date/Time pickers).

When the “**Add**” button is clicked, the selected parameter with the selected corresponding object will be added to the list.



**NOTES:**

- The list of parameters can't have the same parameter defined twice. However, it may have the same report object defined several times for multiple parameters.
- Report parameters using hyperlinks will work only for web report formats in Dream Report Web Portal. Only WEB report formats (Report Output File) will be generated using hyperlinks. PDF and Excel report formats will not be generated using hyperlinks.

For details on internal project parameters (IPP) configuration, please refer to the [Project Parameters](#) section of this manual.

**Raw Data Hyperlink**

If **Raw Data Hyperlink** is selected in the **Hyperlink Configuration** section, then when Web report is generated, the resulting **Single Data** object value will be shown with a hyperlink that, when clicked, will display the raw data for the time period of the object. The raw data can be shown in a **Table** format or a dynamic **Chart** format, by clicking the appropriate radio button. No additional configuration is required for the Table and Chart pop-ups:

**Table View Data:**

Timestamp	Value
17/12/15 12:45:27	197.26
17/12/15 12:45:42	199.153
17/12/15 12:45:57	202.471
17/12/15 12:46:12	183.252
17/12/15 12:46:27	151.21
17/12/15 12:46:42	118.11
17/12/15 12:46:57	82.5258
17/12/15 12:47:12	48.0482
17/12/15 12:47:27	20.8262
17/12/15 12:47:42	18.8656
17/12/15 12:47:57	18.8362
17/12/15 12:48:12	42.309

**Advanced Options**

The **“Advanced options”** button will open the **Advanced Visualization settings** window, which is described in detail in the **Advanced Visualization** section.

**View Type (enabled with “Manual Input”)**

If **“Manual Input”** is selected in the **Select Statistical Function** section of the **Single Data Object’s “Data Definition”** tab, an additional setting is available on the **Appearance** configuration - the **View Type**. The three View Type options for Manual Input are **Default**, **Multiline** and **Checkbox**:

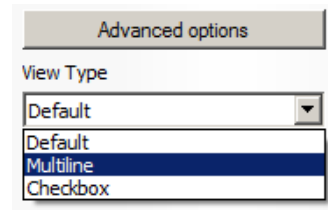



## Ocean Data Systems

- Default** On the web report, a simple, a single-line data entry will field will be available for data entry: pH:
- Multiline** When configuring the report, size the [Single Data Object](#) to an appropriately-sized textbox. Then, on the web report, the textbox will accommodate multiple lines of text, and will automatically provide a slider if the text exceeds the a space available in the textbox:  

**Supervisor Comments:**  
Each public water system that operates a surface water treatment plant to produce drinking water from surface water, or from groundwater that is under the direct influence of surface water, must submit monthly data to the Dept. of Environmental Quality. Make sure to only use Dream Report for the Surface Water Monthly Operating Report
- Checkbox** If the Manual Data entry item is defined as “Boolean” data type, a Checkbox is useful for data entry. Simply size the [Single Data Object](#) as a square, and then the user will be able to use that as a checkbox when entering data on the web report: Tank Clean?



## Alarm Filter Manager

**Alarm Filter Manager** is used to limit the alarms included in calculations for a specific object within the user-defined properties. A Dream Report project has one global per-project list of alarm filters, which is accessible from any object within any report in the project.

The purpose of this window is to define alarm filters and to select existing filters for specific objects as needed.

The left part of the window, **List of defined alarm filters**, is used to define a new alarm filter or edit the properties of an existing alarm filter.

The **Name** field should contain any unique logical name. Adding a new filter with the same name as an existing filter will replace the existing one. The filter name can be up to 64 characters long and can contain spaces. No *wildcard characters* are allowed.

**Description** allows users to quickly understand the use of the object. The description can be up to 256 characters long. Any characters can be used.

**Priority range** specifies the priority range of alarms, which will be included in the filter.

The **Source** combo box contains a complete list of alarm sources in the project.

If external history server is defined, then the **Source** combo box will include alarm history access drivers defined in the project.

If Dream Report History is defined, then the **Source** combo box will include a list of real-time alarm sources.

Each filter can only be applied to a single data source.

To add a filter, click the **Add Filter** button. The Alarm filter manager will get all data from the filter definition part and add appropriate filters to the **Alarm Filter List**.

To modify an existing filter, select the filter in the list. The filter definition will be updated with the selected filter data. To change the filter click on the **Modify** button. The filter configuration will be updated with your new data.

To delete an existing alarm filter, press the **Delete** button.



## Dynamic Text Object

**Dynamic Text Object** enables users to display a text in a report, where the value will be determined during report generation.

To add this object, click on the *Dynamic text* button on the Report Designer Studio **Elements** toolbar:

Draw a rectangle in the workspace where the output data will be displayed.

The following dialog window will be opened:

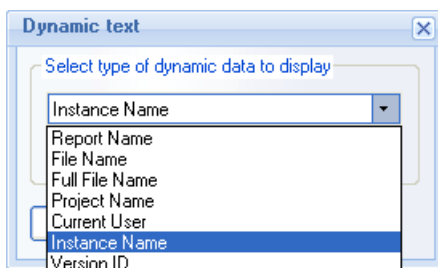

You can select one of the following types of Dynamic Text:

- **Report Name** - the name of the actual report.
- **File Name** - the name of the generated report PDF file.
- **Full File Name** - the name of the generated report PDF file, including its file path.
- **Project Name** - the name of the actual reporting project.
- **Current User** - the name of the user, who has generated that report.
- **Instance Name** - the name of the instance of the generated report.
- For details of report instances (**Instance Name**), please, go to the Virtual Report Instances section.
- **Version ID** - ID of the report version a user will need (please, see the description of the **Version ID** section below).

**NOTE:** The selected dynamic object will be added in the format of **[s#<Field Name>]**.

For details, please see [List of Dynamic Tokens](#) section.

**Dynamic text visual properties** can be edited (in the font toolbar) like the properties of other text objects: font size, colour and style.

### Version ID

If a user selects the **Version ID** option, but **Version Control(VC)** is disabled, then, the message box "*Version control is disabled in your project. Do you want to enable version control and add this object type into report?*" will pop up.

If a user will click on **Yes**, the Version Control will be enabled, and the dynamic text object with the **Version ID** type will be added to the report. If a user will click on **No**, the Version Control option will remain disabled and no dynamic object will be added to the report.

Then, if a user will enable the option "**Enable user comments**" in the Version Control dialog box, each time the report is saved, the following window will pop up:

A screenshot of a 'User Comments' dialog box. The dialog has a title bar with the text 'User Comments' and a close button (X). Inside the dialog, there is a large, empty text input field. Below the text field is a 'Save' button. The dialog box is set against a light blue background.

It will be empty, the [Save](#) button will be disabled. A user will have to enter the version comment, otherwise, he will not be able to continue.

For details, please, go to the [Version Control](#) section.



## Page Number Object

**Page Number** object allows a user to display the number of the current page or the total number of pages in a report.

To add this object to a report, click on the *Page number* button on the Report Designer Studio **Elements** toolbar :



Draw a rectangle in the workspace where the page number will be displayed.

Then the **Page Number** dialog window will be opened (please, see pic. below):

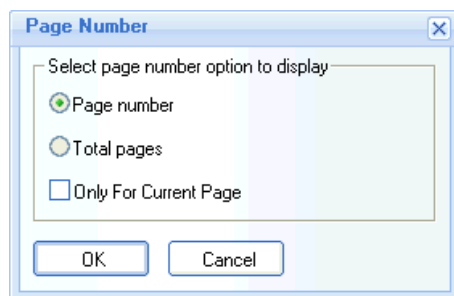

Select the desired option: **Page number** or **Total pages** and click **OK**.

The "**Page number**" option will add the number of the current page.

The "**Total pages**" option will add the total number of pages in the report.

The **Total pages** object will be calculated dynamically during report generation based on the number of dynamically generated number of pages.

If the check box **Only for current page** will be checked, then the page number will be displayed only on the page, where the object definition is added. If this check box will not be checked, then the page number will be automatically added to every page of that report.

By default, the **Only for current page** check box is not checked.

The text properties of the object can be changed using the studio font toolbar, e.g. font size, color, style.

When copying/pasting this object on another page, it will automatically display the number of the new page.

When adding **Page Number** to a page template and then applying that page template to another multi-page report, the "**Page Number**" object will automatically update the page number in each place in the report.





## Advanced SQL Condition

The **Advanced SQL condition (SQC)** enables you to apply additional filtering to the data.

Advanced SQL condition is configured as the "WHERE clause" of an SQL command, and will be added to the main conditions, defined in the data object, such as the time period, source, item name etc.

User can enter any valid SQL condition using any field or column from the table, which is included in the main definition of the data object.

**NOTE:** SQC cannot contain conditions, which are related to data tables other than the one associated with the data object.

Data item and item(s) from SQL condition should be located in the same table row.

To simplify entering a condition, pick the condition from the **Select Data Item** group of controls. Just select the data source, item name and click on the **Add** button. The item name will be inserted in the format: **[i#<Item Name>]**. Afterwards, it will automatically be converted into a valid SQL expression.

For details, please see [List of Dynamic Tokens](#) section.

You can set conditions, which refer to the value of a statistical field rather than the constant value. Select an existing data object in the same report from the combo box, just below the SQL condition edit box, and click on the **Add** button. The selected field will be added to the SQL condition in the format of **[f#<Field Name>]**.

If the SQC contains a field name, then the object value will be calculated as follows: first Dream Report will calculate the values of all objects included in the SQC string, then it will compile the SQC string using the actual object values. Finally, it will calculate value of the entire object.

For details, please see [List of Dynamic Tokens](#) section.

**NOTE:** Using the name of the entire object in its own SQC may cause deadlock and therefore is not supported.

Creating two objects, where each of them contains an SQC with the name of the other, may also cause deadlock and therefore is not supported.

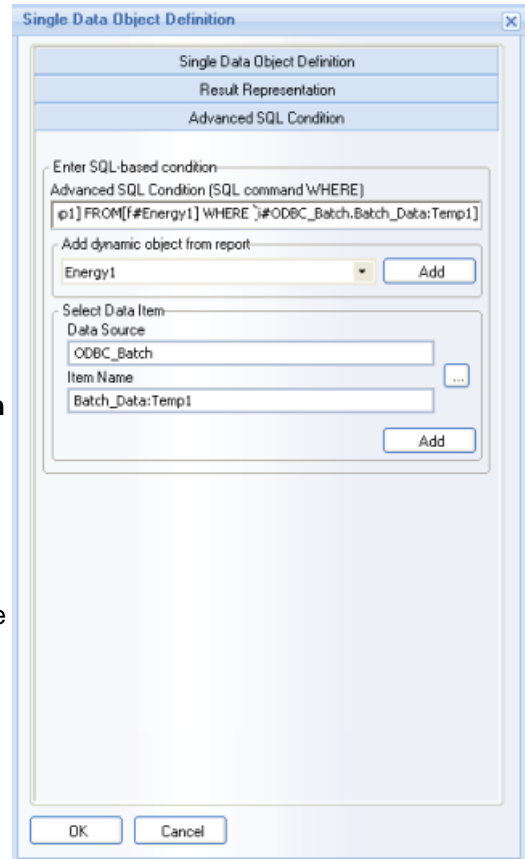



## Date & Time Object

**Date and Time** object displays dynamic date and/or time in the desired format.

To add this object, click on the *Date/Time* button on the Report Designer Studio **Elements** toolbar:

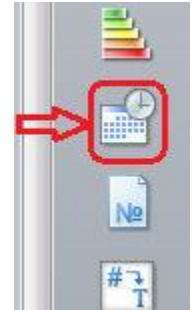

Draw a rectangle in the workspace where the data will be displayed.

Then the following dialog box will be displayed:

In the **Object Name** section a user will define the name for the selected object.

The **Option for Dynamic Generation** section defines the behaviour of date/ time if a report is generated by the Dynamic Report Generator with dynamic period replacement. When the period is replaced dynamically, the Date/Time object can display either start or end time of the report period or timestamp of report generation according to the selected radio button. Then the "**Time Definition**" section of this dialogue will be ignored and only dynamic report generation settings will be considered.

If there is no dynamic time replacement, this object will present time defined in the "**Time Definition**" section of this dialog window.

The **Time Definition** combo box has 4 options: *Absolute or relative period definition*, *Fixed period*, *Batch-based* and *Calculated time period*.



The time period configuration is described in details in the **Time Period Definition** section of this manual.

If a user enables **OS Time Format**, then the computer operational system time settings will be automatically applied to the Date/ Time object settings.

If a user selects **Custom Time Format**, then **Date/Time Appearance** and **Set Date/Time Format** combo boxes will appear (please, see the pic. above).

The **Date/Time Appearance** section defines which data will be displayed:

- **Date** - displays only the specified date
- **Time** - displays only the specified time
- **Date and Time** - displays both the date and time
- **Week Number** - displays only the week number, where Monday is treated as the beginning of the week and the week containing January 1 is "Week 1"
- **Day of the week** - displays the name of the day of the week (e.g. "Monday")
- **Day of the week number** - displays the number of the day of the week, where 1=Monday and 7=Sunday



## Ocean Data Systems

- **Month** - displays the name of the month, e.g. "January"
- **Month Number** - displays a two-digit number for the month, where January is "01"
- **Year only** - displays the four-digit year
- **Hour only** - displays the two-digit hour, applying the "24 hour" or "AM/PM" selection, but without the "PM" designation (e.g. 15:00 will be displayed as "03")
- **Minute only** - displays the two-digit minutes

The **Set Date/Time Format** section defines the format in which the date and time will be displayed, e.g. dd/mm/yyyy or mm/dd/yyyy or dd/mm/yy etc. for the date format, and 24h format or am/pm for the time format.



## Time Period Definition

**Time period** can be defined in 4 ways. You can:

- define the start and end of time period;
- select a periodic interval (e.g. hourly);
- use a batch definition (for batch process reporting);
- define timestamp manually (is possible only in dynamic (WEB) reports).

**Time Period Definition** has 5 options to define time in Dream Report: **Fixed Period**, **Absolute or relative period definition**, **Batch based**, **Calculated time period** and **Manual Input**.

- If you select **Fixed Period** from the Define time period combo box you will have another combo box from which to select a fixed period as seen below:

The screenshot shows a dialog box titled "Define time period". It has a dropdown menu for "Fixed Period" which is currently set to "Fixed Period". Below this, there are two main sections. The first section has a dropdown for "Last" (selected), a numeric input field with "1", and a dropdown for "month(s)". The second section has a checked checkbox for "Duration", a numeric input field with "2", and a dropdown for "week(s)". To the right of this is a "Start Date and Time" section with a "Day" dropdown set to "3" and a "Time" input field set to "14:00:00".

**Last** means "previous complete", i.e. if the current time is 14:32, then the Last hour will be 13:00 - 14:00

**Current** means incomplete, "in progress" period. If the current time is 14:32, then the Current hour will be 14:00 - 14:32.

Combining a mode (**Last/Current**), time unit and number of units you can compile any time period (i.e. Last 3 years, Current 6 months etc.).

If the check box **Duration** is checked, then you must specify how long the duration of the fixed period will be and it will modify appropriately the end time.

**Example:** If today is *April 29* and you specify the fixed period "*Last 2 months*" and Duration *1 month*, then:

*Start period* will be defined by "*Last 2 months*", i.e. *Feb.* and *March*, i.e. start of the period will be *February 1*;

*End of the period* will be defined by Duration, i.e. *1 month*, i.e. the end date will be: *February 1 + 1 month = March 1*.

The section **Start Date/Time** may define when the start and end date and time for the specified fixed period are.

For example, the **Last 1 day** period means the period from midnight last day until midnight today. Using start date, you can count 1 day not from midnight to midnight, but from and to the time, specified in the Start Date/Time field, e.g. if the start time is 07:00:00 then Last 1 day period will be accounted not from midnight last day until midnight today, but from 07:00:00 last day until 07:00:00 today.

If the user specifies last or current day, week, then only **Start time** is available. If the user specifies period **Last** or **Current month** or **quarter** or **year**, then both **Start Date** and **Time** will be available.

- If you select **Absolute or relative period definition** in the Define time period combo box, then you must specify the start and end time for the period:



The Start and End of time of the period can be defined using 4 options:

- Absolute date/time
- Relative date/time
- Absolute date/Relative time
- Relative date/Absolute time

If the **absolute** option is selected, then specify the calendar date and time.

If the **relative** option is selected, then specify the time offset, i.e. a number of days or hours, minutes and seconds back from the time of the report definition. If the time period is defined in the relative mode, then the time will be defined as follows: during report generation, the current time will be captured as the end time and the time offset will be deducted from it as the start time. E.g. If the time is defined in relative mode as 00:10:00 (hh:mm:ss), then it will mean 10 minutes before report generation.

The **Start** and **End of period** may have separate modes (any of four possible).

- If you select the **Batch based** option, then the following period definition control will appear:

Here you can select a batch definition, which will be used to calculate the period for your object. The **Batch** combo box will contain a list of previously defined batch definitions. If you need to edit that list, click on the browse button ("...") and the **Batch definition** window will be opened, where you can edit the existing batch definitions. Batch definition is described in detail in the Batch Definition section.

Then, after selecting a batch definition, select the mode (**Last/Current**) and the batch count.

**Last batch** means the most recently completed batch ID, i.e. at the time of the report generation it has valid start time and end time.

**Current batch** means batch ID, which is being processed at present, i.e. at the time of the report generation it has a valid start time and no end time yet.

**Absolute batch ID** will enable user to enter any specific absolute batch ID, and their start and end time will be considered as the time period for that statistical object.

**Golden batch** will use start and end time of the golden batch ID, defined in the selected batch definition (in the batch configuration dialog window).

The **Absolute batch ID** and the **Golden batch** options are similar. The difference between them is that the **Golden batch** is defined once per reporting project. Then, since the user has defined the Golden batch ID once (in the batch definition window), then it will be used for all the reporting objects, throughout the entire project. If the user changes it, it will be automatically applied to all reporting objects as well. The Absolute batch ID is applied to one specific reporting object and will not affect any other objects. If the user wants to modify the absolute batch ID, it will have to go through every reporting objects, where the absolute batch ID is used and to change each of them.



**Example:** Last 2 batches will mean 2 last batches, which have been completed at the time of generation, but not including the one which is in-process now. The current 2 batches will mean the last 2 batches, including the one which is in process now.

- If you select **Calculated time period** option, the following period definition control will appear:

This option allows you to set start and end of period using the result of calculation. You can select any statistical object from the combo box to calculate start and end of the period, where those objects must have statistical function, returning a timestamp: *Timestamp of first value* or *Timestamp of last value* or *Timestamp of min value* or *Timestamp of max value* or *Batch Start time* or *Batch end time*. Also, it can be an expression object, which was doing operations with timestamp, and which result is also a timestamp.

- If you select **Manual Input** from the Define time period combo box, you will be able to select a Timestamp Picker object for **Date** and for **Time** (as seen below):

**Date** and **Time** drop down boxes contain the list of manual Timestamp Picker objects, defined in that specific report.

If Timestamp Picker, selected in the “**Date**” combo box, has **Date and Time** format defined, then the “**Time**” combo box can include the same selection as in the “**Date**” combo box, or can have selection **<Not Used>**.

If user has selected **<Not Used>** in the “**Time**” combo box and the Timestamp Picker, selected in the “**Date**” combo box, has only **Date** format, then the current time “**hh:ss:mm**” will be used as default time.

For details on how to configure Timestamp Picker objects, please go to the [Timestamp Picker](#) section of this manual.

**NOTE:** If objects with the **Manual time input** option will be used in static (PDF/Excel) reports, where manual input is not possible, then the default values of the selected Timestamp Pickers will be taken for calculation.



## Apply Correction Factor

**Correction Factor** is a simple expression, which can be added to any statistical object with the selected data item. If a statistical object contains several data items, then, the correction factor can be set for every data item separately.

If the correction factor is set for a data item in a statistical object, then, when retrieving value of that data item for that object, first of all, each retrieved value from a database will be re-calculated, applying the correction factor. Then the statistical functions will be performed on re-calculated values.

If a chart is displayed on item with the correction factor, then, first, all values will be re-calculated, applying correction factor and then, the chart will display re-calculated data.

Correction factor must have a clear syntax: `<operator><value>`, where operator can be: `+` or `-` or `*` or `/` and value can be any numeric value. For example: `*1000` or `+10` (see pic. below)

Apply correction factor for all item values:

use: + - \* / (e.g. \*1000)

Value for the correction factor can be also dynamic, i.e. taken from a real-time item value or another statistical object.

If you double-click on the edit box with the correction factor, an item browse window will be opened, where you can select a real-time data source and data item. Then, during report generation, the real-time value of the selected item will be read and used as a value for the correction factor.

If the correction factor contains invalid syntax or invalid value or invalid operator, it will be ignored and all values will be taken for consideration as they are.



# Tables

## Item Table (Raw Values)

**Item table** is an object, which displays an array of values from one or more data items within a specified value range, which were logged during the specified time period.

To add this object, please click on the *Item Table* button on the Report Designer Studio **Elements** toolbar:

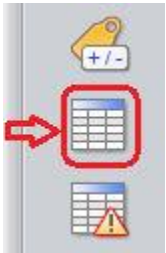

Mark in the workspace the rectangle, where desired data will be displayed.

The **Item Table** definition dialog window will be opened (see pic. on the right):

### Item Table Data Definition

In the **Get Data From** dialog box, select which history type will be used to extract data from: *Dream Report History* or *External History Server*.

To add data items to the **Selected List** table, click on the *Edit List* button, and the **Select Data Items** dialog window will be opened.

If "*Dream Report History*" radio button will be enabled, then, the combo box "**Select Data Source**" will contain a list of data access drivers defined in the project. If "*External History Server*" will be selected, the "**Select Data Source**" combo box will contain a list of history access drivers defined in the project.

In **Select Data Source** and **Available Data Items**, select the source and item from which Dream Report will calculate values, and add them to the list. Data source name and data item name of the selected tags will appear in the **Selected List** table.

If a user will enable **Column-Item orientation** check box, then the table columns will display item values from the selected list.

**Apply correction factor for all item values** enables adding simple expression to an item table.

If a user needs to display item table on item(s) with the correction factor, then, first, all values of the selected item(s) will be re-calculated, applying correction factor, and then, the item table will display re-calculated data.

For more details, please, refer to the **Correction Factor** section.

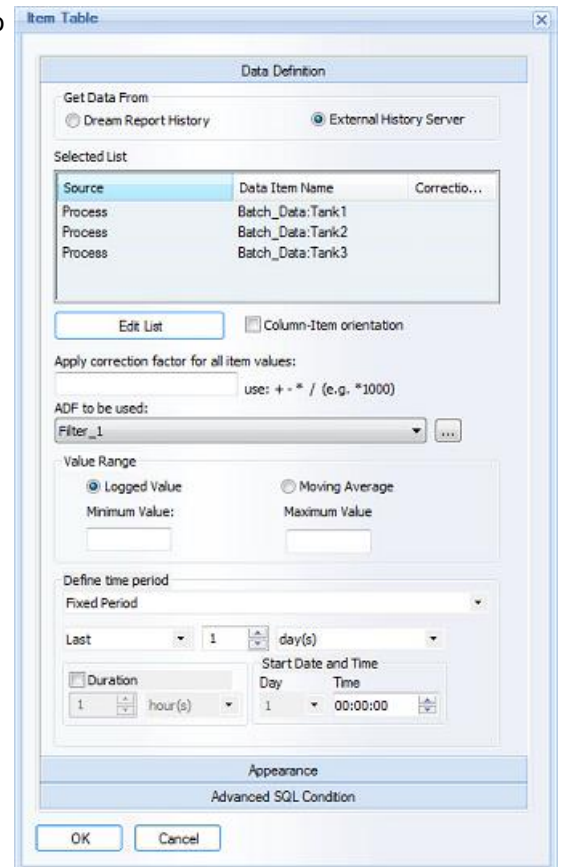

**ADF to be used:** enables to select an aggregated data filter. "**ADF to be used**" combo box will contain all ADF definitions, configured in the project. The default string will be "**Not Used**", i.e. no filter (ADF) is applied.





For details on ADF definition/configuration, please go to the Aggregated Data Filter section of this manual.

In the **Value Range** filter section, specify the range of values you wish to include in your table. For example, you can create a table only for a critical value range and see only those values.

The value filter accepts negative and floating point values, but it only supports numeric values and not strings.

If you use an Item Table to display string item values, the value filter will be ignored.

The Item table is able to display 2 kinds of data: **Logged Value** (raw data) or **Moving Average**.

If **Logged Value** will be selected, data will be extracted from history and displayed exactly as it is according to the definition.

If **Moving Average** will be selected, then each raw data array will be automatically recalculated into a moving average array, when each array element is an average of all previous array members, including itself. In case of **Moving Average**, the value filter will be ignored.

**Time Definition**, which defines the period for statistical calculations for this object, is described in the **Time Definition** section of this manual.

### Item Table Appearance

To adjust the formatting of the table, click on the **Appearance** floating splitter and the **Table Appearance** dialog window will be opened (see picture on the right):

The **Table Name** field will contain a name, which will be displayed.

The **Display Table Name** check box will enable or disable table title display.

The **Display Columns** list defines which columns will be displayed as well as their order, size, width and caption.

The left row of check boxes enables and disables the appropriate column display in the table.

The **Caption** column defines the caption of each column of the table. If you wish to change the caption of any column, double-click on the appropriate caption inside the column and it will be available for editing.

Selecting any column and clicking **Move Up** or **Move Down** buttons will change the order of the selected column.

The right set of check boxes - **Sort By** - will define by which column the data will be sorted. Only one column can be selected.

Radio buttons below (**Sort In**) will define the sorting direction, **ascending** or **descending**.

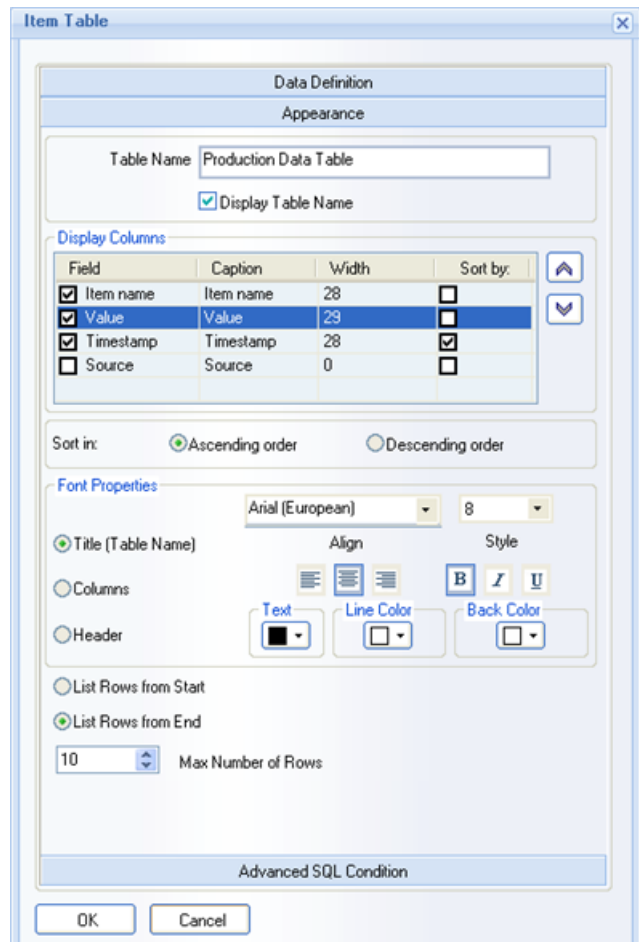

The **Font Properties** controls enable you to set different font properties for the table title, table header and displayed data (in columns).



## Ocean Data Systems

When you define a table, you never know how many rows will actually be displayed. It may be few, but may also result in dozens of pages in a report. Therefore the **Max Number of Rows** edit box allows you to specify the maximum number of rows to display in the table. This enables the user to protect the report from an overflow.

When defining the maximum number of rows, you can set which "cut" of all the data set you would like to display: the first or the last block of data. This can be defined by selecting an appropriate radio button: **List rows from Start** or **List rows from End**.

### Examples of Item tables:

**Column based - When logging is the same for each Tag**

Timestamp	Tank1	Tank2	Tank3
02/07/07 18:00:00	150.00	30.00	1500.00
02/07/07 17:00:00	1485.00	750.00	1170.00
02/07/07 16:00:00	1470.00	900.00	1395.00
02/07/07 15:00:00	1455.00	1050.00	1500.00
02/07/07 14:00:00	1440.00	1200.00	1485.00
02/07/07 13:00:00	1425.00	1350.00	1425.00
02/07/07 12:00:00	1410.00	1500.00	1200.00
02/07/07 11:00:00	1395.00	1200.00	900.00
02/07/07 10:00:00	1380.00	900.00	450.00
02/07/07 09:00:00	1365.00	525.00	225.00
02/07/07 08:00:00	1350.00	825.00	75.00
02/07/07 07:00:00	1320.00	975.00	225.00

**All Tanks Together**

Timestamp	Tank Name	Values
02/07/07 18:00:00	Tank3	1500.00
02/07/07 18:00:00	Tank2	30.00
02/07/07 18:00:00	Tank1	150.00
02/07/07 17:00:00	Tank3	1170.00
02/07/07 17:00:00	Tank2	750.00
02/07/07 17:00:00	Tank1	1485.00
02/07/07 16:00:00	Tank1	1470.00
02/07/07 16:00:00	Tank2	900.00
02/07/07 16:00:00	Tank3	1395.00
02/07/07 15:00:00	Tank2	1050.00
02/07/07 15:00:00	Tank1	1455.00
02/07/07 15:00:00	Tank3	1500.00
02/07/07 14:00:00	Tank2	1200.00
02/07/07 14:00:00	Tank1	1440.00
02/07/07 14:00:00	Tank3	1485.00
02/07/07 13:00:00	Tank3	1425.00



## Free Table

**Free Table** is an object that combines different static and dynamic statistical objects into a table.

To add a free table to the project, click the *Free Table* button on the Report Designer Studio **Elements** toolbar:

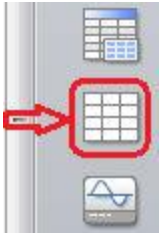

Mark in the workspace the rectangle, where desired data will be displayed.

The following dialog box will be opened:

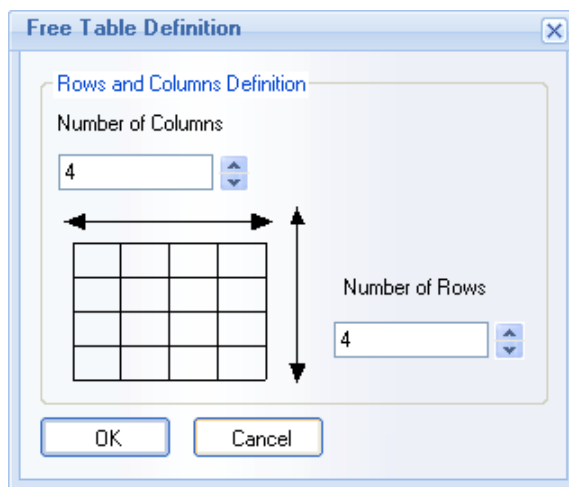

Enter the number of rows and columns for the table. The maximum size is 50 rows and 50 columns.

When a free table is added to the project, it can be filled with the following types of data:

To add a statistical object, user has to right-click on a cell and select required object type from a context menu (see pic. below), which can be:

- Static text
- Date/Time Object
- [Single Data](#) Object
- [Compound Data](#) Object
- [Expression Data](#) Object

To open text input for a cell, double-click the cell.

Right-click on a cell to open the context menu as shown:

Use the [Single Data](#) or [Compound Data](#) or [Expression Data](#) menu item to open the corresponding dialog box to configure an object and attach it to the selected cell.

To delete a free table, right-click on any cell in the table and select *Delete Table*. Or select a table, clicking on the table border, and press the *Delete* key.

### Example of Free table:

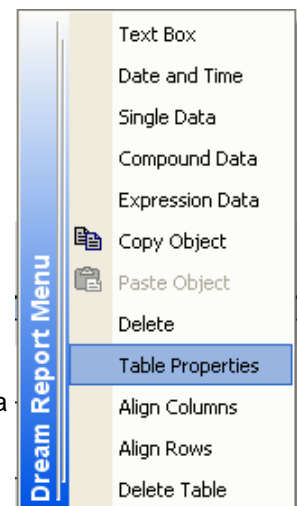



## Ocean Data Systems

Statistics	Absolute/Relative	Fixe Period	Batch Period	Batch ID	Timestamp
	From Jan 1st at Today	Last Month	Last Batch	#Batch_ID	
First Value	#First m3	#First_F m3	#First_B m3	#First_B_TS	First Value
Last Value	#Last m3	#Last_F m3	#Last_B m3	#Last_B_TS	Last Value
Maximum Value	#Maxi m3	#Maxi_F m3	#Maxi_B m3	#Maxi_B_TS	Maximum Value
Minimum Value	#Mini m3	#Mini_F m3	#Mini_B m3	#Mini_B_TS	Minimum Value
Average Value	#Average m3	#Average_F m3	#Average_B m3		
Weighted Average	#W_average m3	#W_average_F m3	#W_average_B m3		
Integral Value	#Integral	#Integral_F	#Integral_B		
Sum Value	#Sum m3	#Sum_F m3	#Sum_B m3	#RT_B	Run Time
Standard Deviation	#Deviation	#Deviation_F	#Deviation_B		



## Automatic Statistical Table

**Automatic Statistical Table** (AST) is a table object, which allows you to quickly create and modify a table in a few clicks. Select a list of tags, select a list of statistical functions for each of them, and define a common time period.

Click on the *Automatic Statistical Table* button on the statistical object toolbar in the Dream Report Designer Studio:

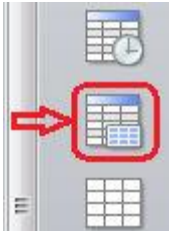

Draw an area for your table in the report workspace. The **AST Data Definition** dialog window will be opened:

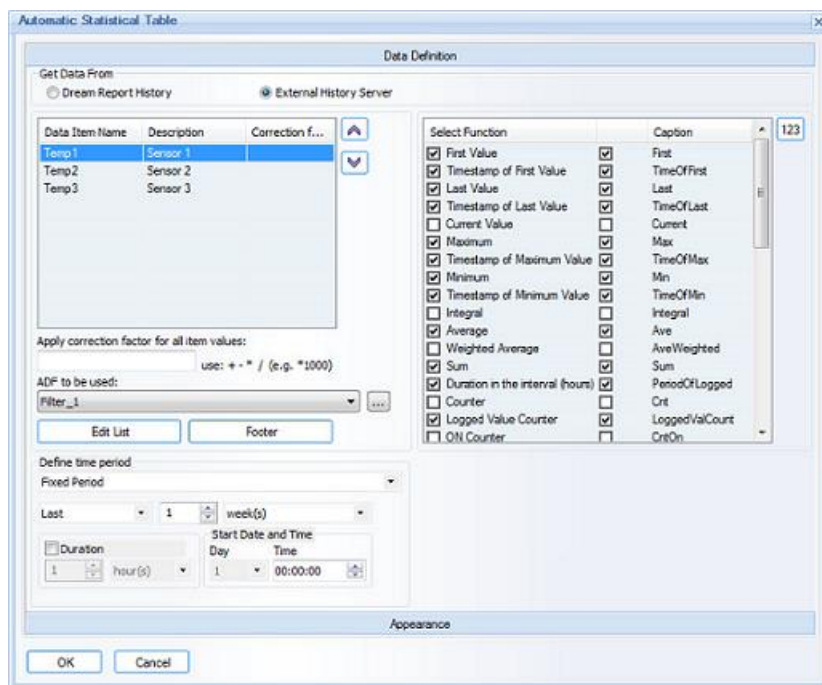

### Automatic Statistical Table Data Definition

In the **Get Data From** dialog box select which history type will be used to extract data from: *Dream Report History* or *External History Server*.

To add data items/tags to the **Selected List** table, click on the *Edit List* button, and the **Select Data Items** dialog window will be opened.

If "*Dream Report History*" radio button will be enabled, then, the combo box "**Select Data Source**" will contain a list of data access drivers defined in the project.

If "*External History Server*" will be selected, the "**Select Data Source**" combo box will contain a list of history access drivers defined in the project.

In the **Select Data Source** and **Available Data Items** combo boxes, select the source and item from which Dream Report will calculate values, and add them to the list. Data source name and data item name of the selected tags will appear in the **Selected List** table.



When you have selected a data item/tag, choose the statistical functions you will need to perform for the textual output of the report result. The list of all available statistical functions for the AST calculations is the same as for the Single Data Object calculations:

- **Last value**
- **Maximum value**
- **Minimum value**
- **Sum value**
- **Integral value**
- **Average value**
- **Weighted Average**
- **Duration**
- **Counters**
- ...

For detailed information about these statistical functions, please, go to the Single Data Object section.

**Apply correction factor for all item values** enables adding simple expression to an automatic statistical table. If a user needs to display automatic statistical table on item(s) with the correction factor, then, first, all values of the selected item(s) will be re-calculated, applying correction factor, and then, the automatic statistical table will display re-calculated data.

For more details, please refer to the [Correction Factor](#) section.

**ADF to be used:** enables to select an aggregated data filter. "ADF to be used" combo box will contain all ADF definitions configured in the project. The default string will be "**Not Used**", i.e. no filter (ADF) is applied.

For details on ADF definition/configuration, please go to the Aggregated Data Filter section of this manual.

For each selected function you can define the format by clicking on the selected statistical function and double-clicking the "..." button for the following advanced settings:

- **Column Caption**
- **Settings**
- **Units** (For details, please, see the [Result Representation](#) section)
- **Precision of result after decimal point** (For details, please, see the [Result Representation](#) section).
- **Show result as** (For details, please, see the [Result Representation](#) section).
- **Advanced options** (For details, please, see the [Advanced Visualization Settings](#) section).
- **Advanced SQL Conditions** (For details, please, see [Advanced SQL Condition](#) section).

The Automatic Statistical Table enables you to add a **Footer**. This footer can have multiple lines, which can include static text, Expression or Compound data objects.

Data from all table cells (objects) can be stored in the Dream Report database for further use using the analytical driver.

**Time Definition**, which defines the period for statistical calculations for this object, is described in the [Time Definition](#) section of this manual.



### Automatic Statistical Table Appearance

The **Appearance** section contains column definitions as well as formatting options (font properties, colors, background etc.).

Here you can format the properties of an AST object. The orientation of a table can be specified by the “**Show Table Horizontally**” check box.

By default 2 options **Show Item Name** column and **Show Description** are enabled.

User can hide the item name column and the description column by disabling the corresponding edit boxes.

Both columns can be defined accordingly in the **Data Definition Tab**.

The user can set the table name and then decide to display it or not by selecting “**Display Table Name**”.

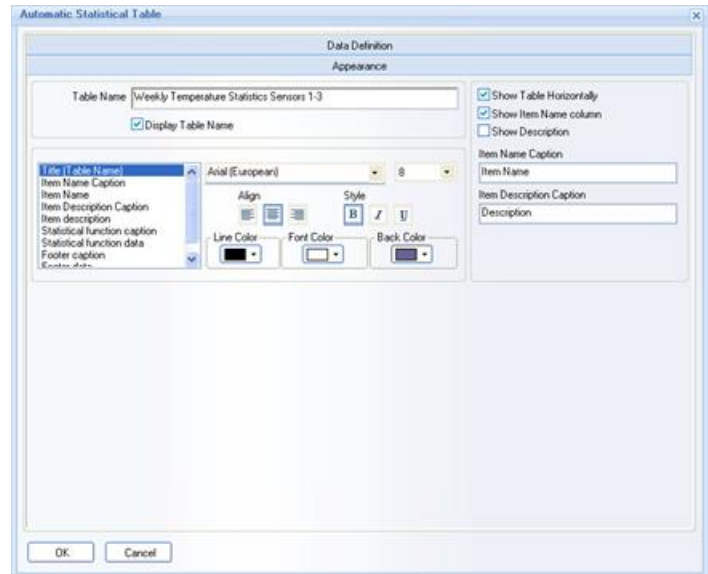

### Example of Automatic Statistical table:

Weekly Temperature Statistics Sensors 1-3						
	Temp1	Sensor 1	Temp2	Sensor 2	Temp3	Sensor 3
First	86.00		45.00		25.00	
TimeOfFirst	18/02/2008 07:00:00		18/02/2008 07:00:00		18/02/2008 07:00:00	
Last	50.00		25.00		10.00	
TimeOfLast	24/02/2008 18:00:00		24/02/2008 18:00:00		24/02/2008 18:00:00	
Max	99.00		100.00		100.00	
TimeOfMax	19/02/2008 12:00:00		19/02/2008 07:00:00		19/02/2008 10:00:00	
Min	11.00		2.00		5.00	
TimeOfMin	19/02/2008 13:00:00		19/02/2008 13:00:00		18/02/2008 09:00:00	
Ave	74.74		45.45		49.73	
Sum	6278.00		3818.00		4177.00	
PeriodOfLogged	155:00:00		155:00:00		155:00:00	
LoggedValCount	84.00		84.00		84.00	
Deviation	25.47		23.66		35.14	



## Designer Studio - Step Table

**Step Table** is an object, which creates a table automatically with a predefined time for each row in the table.

**Example:** Create a table for 1 day making 1 row for each hour.

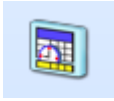

Click on the "Step Table" button on the Report Designer Studio **Elements** toolbar (pic. above). Draw a rectangle where you want to place the table in the report workspace.

**Step Table Data Definition** dialog window will be opened (see pic. on the right):

### Step Table Data Definition

In the **Object Description** section you can specify general information related to an object.

To create a step table, define how many columns that table will contain, what the content of each column will be, and also the general table time period and the period for each row (1 step).

In the **Number of columns** edit box enter a number of columns the table will contain.

The data definition of each column is defined in the **Appearance** section of the **Step Table** definition window.

The **Define time period** group box defines a time period for the entire table. Time period definition is described in detail in the Time Period Definition section.

The **Step Period** section defines a period for each row of the table. It has 6 options: **Time-based**, **Batch-based**, **Step number is value range based**, **Step number is value based**, **Step number is based on all item values**, and **Step number is based on item value change**.

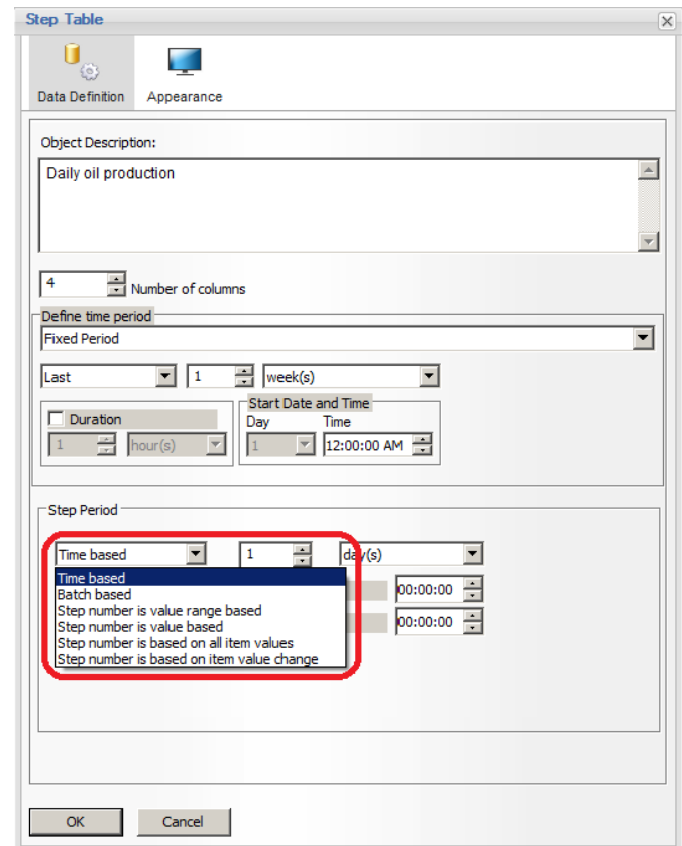

If **Time-based** option is selected, you can enter any integer number from 1 to 86400, and time (**second(s)**, **min(s)**, **hour(s)**, **day(s)**, **week(s)**, **month(s)**, **quarter(s)**, **year(s)**) in the time unit combo box.

**Example:** If you define a time period of 1 day and a step period of 1 hour, you will have a table for the last 24 hours with 24 rows, where each row will correspond to 1 hour and will contain statistical calculations of data for that corresponding 1 hour.

**Batch-based** option configuration is described in details in the Batch Definition section.





**NOTE:** When batch is defined in the external database (see [Batch definition](#) section) - then, if, in the Step table, the time period is defined as **Absolute/Relative/Fixed** or **Calculated**, and the Step period is defined as **batch-based**, the first step of the table will be the beginning of the first batch, which started within the time period defined for the step table. The last step of the table will end with the end of the time period defined.

If **Step number is value range based** option is selected, then user will be able to select a tag (from a real-time or historical data source) and specify **full** or **half empty** value range:

- **Full value range** means that “**From**” and “**To**” value range parameters will have the entered values. In this case Step table will read values of a ranged tag (“ODBC:Batch\_Data:Motor 1” as in the picture above), and find time periods when the value of this ranged tag complies with the specified range. Every such a time period found (Start and End time) will be used as a step.

**Example:** Let's suppose that the tag "Batch\_Data:Motor 1" has the following values in the duration of 1 hour:

Timestamp	Value
11:00	10
11:10	12
11:20	20
11:30	21
11:40	11
11:50	12
11:59	30

If **Full range** option is defined with the range of "From" 9 "To" 19, then the step table will have 2 steps for that period: 11:00 – 11:20 and 11:40 – 11:59.

- **Half empty value range** means that one of the value range parameters (“**From**” or “**To**”) is empty. If “**From**” is empty and “**To**” has value, this will mean the following condition: **ranged tag < “To**”. If “**To**” is empty and “**From**” has a value, this will mean the following condition: **raged tag > “From**”. In this case Step table will read values of a ranged tag (“ODBC:Batch\_Data:Motor 1”), and find time periods when the value of this ranged tag complies with the specified range condition. Every such a time period found will be used as a step.

**Example:** Let's suppose that the tag "Batch\_Data:Motor 1" has the following values in the duration of 1 hour:



Timestamp	Value
11:00	10
11:10	12
11:20	20
11:30	21
11:40	11
11:50	12
11:59	30

- If **Half empty value range** option is defined with the range of "From " "To" 20, then the step table will have 2 steps for that period: 11:00 – 11:20 and 11:40 – 11:59.
- If **Half empty value range** option is defined with the range of "From " "To" 40, then the step table will have 1 step for the entire period of 11:00 - 11:59: The whole table period will be one step only.
- If **Half empty value range** option is defined with the range of "From "20" "To " , then the step table will have 2 steps for that period: 11:20 – 11:40 and 11:59 – <end of the period>.

If **Step number is value based** option is selected, then the **Select the object for step number value** combo box will be filled with the list of reporting simple objects (Single Data objects, Compound objects, Expression objects,...etc.):

Step Period

Step number is value ▼

Select the object for Step number value

Pulse\_Number ▼

After an object has been selected, later, when report is generated, the object calculation result will be taken as a number of steps.

**Example:** If the object "Pulse\_Number" has a value "4", then, the Step table will have 4 rows. Each row will have the same time period and the difference will be only the **Step ID**, which can be used as an argument for statistical calculations inside the table (please see **Column Type Settings** section below).

**NOTE:** This option enables to create steps (rows) by calculated number, where time period for each step is the same and the difference between steps is not time, but the number of rows.

If **Step number is based on all item values** option is selected, then all tag values will be considered. In this mode the Step table will work exactly as an Item table. It will ignore statistical functions, read all values of tag(s), selected in a column. Then it will consider every value as a momentary step where Start and End of a step is the timestamp of that value, and will just list all found tag values over the table period. It will use the function "**Last Value**" for every timestamp period and get all tag values, i.e. for each column definition it will get only the tag name, and the function will be always ignored with the "**Last Value**" used instead.

**Example:** Let's suppose that the tag "Batch\_Data:Motor 1" has the following values in the duration of 1 hour:



Timestamp	Value
11:00	10
11:10	12
11:20	20
11:30	21
11:40	11
11:50	12
11:59	30

In this case the step table will display 7 steps with every timestamp, i.e. it will work just as a usual item table for tags, selected in the columns. If tags in the columns have different timestamps, they will be all put together and make one common value array, and if another column doesn't have a value at that time, it will display N/A (according to "No value" definition") (exactly as it works in the item table). If step table has, for example, 3 columns with Min, Max and Avg of the tag "Batch\_Data:Motor 1", then all 3 columns will just list all values of the same tag.

If the **Step number is based on item value change** option is selected, the **Step** table will read all values of a specified tag, and each time a tag value was changed (with or without a tolerance, as specified) a new step will be created in the resulting table. The tolerance can be set as in absolute units, or a percentage change. Additionally, an **SQC** (SQL Query Condition) can be applied to the "step tag" to filter the data based on an SQL condition. Start and End time for each such a step will be the start and end times of each distinct value (e.g. batch ID, phase change, etc.)

Step Period

Step number is based on: [Step number is based on] External History Server: [External History Server]

Data Source: [TankSystem\_1]

Item Name: [Reactor 1/Misc Tags/StepNo] [Browse]

Tolerance: [0] [ABS] [SQC]

### Step Table Appearance

The **Appearance** section contains the definition of the table columns as well as the formatting options (font properties, colors, background etc.).

The **Table Name** field will contain a name, which will be displayed.

The **Display Table Name** check box will enable or disable table title display.

The **Display Columns** list defines which columns will be displayed as well as their order, size, width and caption.

The check box in the **Field** column enables and disables the appropriate column display in the table.

The **Caption** column defines the caption of each column of the table. If you wish to change the caption of any column, double-click on the appropriate caption inside the column and it will be available for editing.

The set of check boxes - **Sort By** - will define by which column the data will be sorted. Only one column can be selected.

Radio buttons below (**Sort In**) will define the sorting direction, *ascending* or *descending*.



Radio buttons **Vertical orientation** and **Horizontal orientation** below the **Sort In** section will define the graphical layout of the table columns.

### Column Type Settings

Use the **Column Type** settings to define the statistical data for each column. If you will click in the list in that column, you will see a small "..." button. Click on that button and you will see a popup menu:

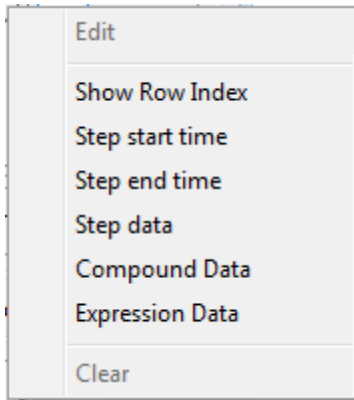

#### Show Row Index

Select this menu to display a row incrementing number (from 1, 2, ...) in the column.

#### Step start time

Select this menu to insert the start time of each step period for each row of the table.

**Example:** if you define a table from 12:00 until 15:00 with 1 hour for each step (row), then **Step start time** will display **12:00, 13:00, 14:00** for 3 rows of the output table.

#### Step end time

Select this menu insert the start time of each step period for each row of the table.

**Example:** if you define a table from 12:00 until 15:00 with 1 hour for each step (row) then **Step end time** will display **13:00, 14:00, 15:00** for 3 rows of the output table.

#### Step data

Select this menu to define the statistical calculation for the selected column. When you select this menu, the Data Definition dialog window will be opened. It is totally identical to the **Single Data Object Definition** window, and is described in details in the Single Data Object section.

The only difference between the Single Data Object Definition and the Step Table Data Definition window is that in the Step Table Data Definition there is no time period to be configured. The selected statistical function will be calculated for the selected data item separately for each row of the table.

**Example:** if you define a table from 12:00 until 15:00 with 1 hour for each step (row), then your defined statistical object will be calculated 3 times for time periods: **12:00-13:00, 13:00-14:00, 14:00-15:00** for 3 rows of the output table.

Also, in the **Appearance** section of the Step Table such options, for the data definition, as **"Visible"** and **"Write back"** are not available, because they cannot be applied to a step table.

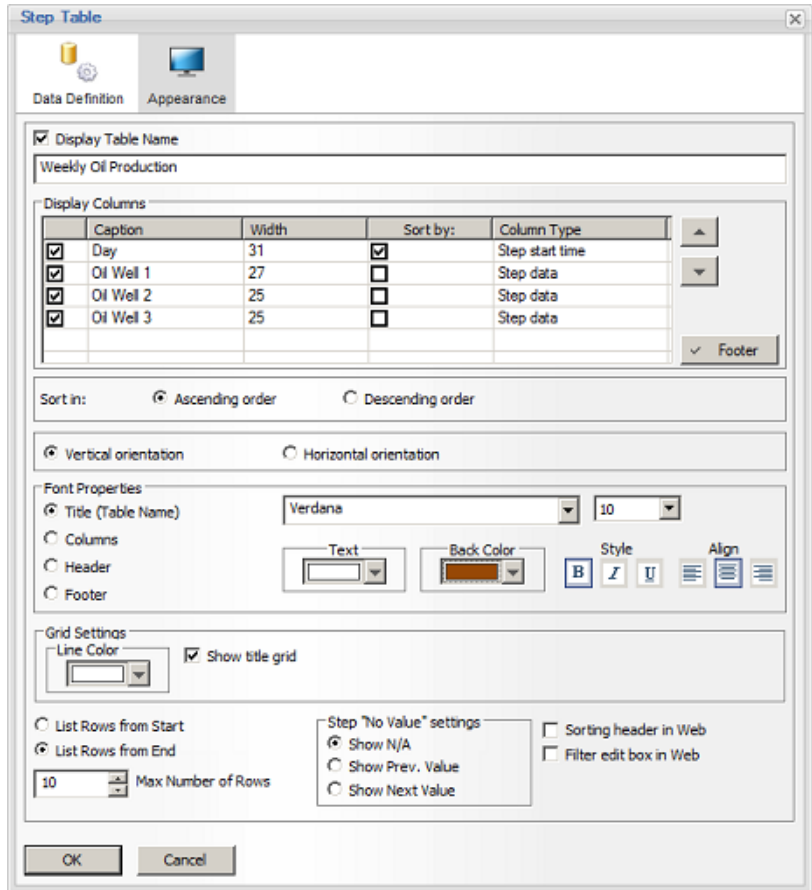



**NOTE:** When using the following **Pulse Analysis** statistical functions: **Peak Minimum Value** or **Peak Maximum Value**, it's important to note that column value (e.g. column ID) will be available as dynamic token parameter for the statistical function input parameter "**Pulse ID**" in the format [c#<column name>].

- **Compound Data**

Select this menu to define the statistical calculation for the selected column. When you select this menu, the Data Definition dialog window will be opened.

It is totally identical to the **Compound Data Object Definition** window, and is described in details in the **Compound Data Object** section.

In the **Appearance** section of the step table such options, for the data definition, as "**Visible**" and "**Write back**" are not available, because they cannot be applied to a step table.

- **Expression Data**

Select this menu to define calculations for the selected column. When you select this menu, the Data Definition dialog window will be opened. It is totally identical to the **Expression Data Object Definition** window, and is described in details in the **Expression Data Object** section.

In the **Appearance** section of the step table such options, for the data definition, as "**Visible**" and "**Write back**" are not available, because they cannot be applied to a step table.

- **Clear** will erase data definition of the column.
- **Edit** will edit the statistical data that has already been entered in that column type.

Step Table enables you to add a **Footer**. This footer can have multiple lines, which can include static text, table start time, table end time, Expression or Compound data objects. Click on the "**Footer**" button to open the Footer configuration window. Refer to the **Footer** section of this document for detailed configuration details.

**NOTE:** The data from the footer can be used in Expression Object calculations. If Step Table has the footer defined, this footer will be added to the list of dynamic objects of the report in the Expression Object (**Add dynamic object from report** section) in the format of [f#<Step Table Object Description>] and its data will be available for calculations.

The footer will be added to the list of dynamic objects in the report only if the Step Table has object description defined.

For details on Expression Object calculations, please go to the **Expression Object** section of this manual.

The **Font Properties** controls enable you to set different font properties for the table title, table header and the displayed data (in columns).

The **Max Number of Rows** edit box allows you to specify the maximum number of rows to display in the table. This enables a user to protect the report from an overflow. When defining the maximum number of rows, you can set which "cut" of all data set you would like to display: the first or the last block of data. This can be defined by selecting an appropriate radio button: **List rows from Start** or **List rows from End**.

## Enhanced Display Options

If any specific step cell in the step table has no value, the desired behavior of a step table in this case can be configured by using the "**Step "No value" settings**" option. It has 3 radio-buttons: **Show N/A**, **Show Previous value** and **Show Next Value**.

**Show N/A** option is selected by default. In this case, if any specific cell in the step table has no value, the step table will display N/A value. Please see an example below:



## Ocean Data Systems

Day	Min	Max	Avg
Monday	1	2	1.5
Tuesday	2	3	2.5
Wednesday	NA	NA	NA
Thursday	NA	NA	NA
Friday	NA	NA	NA
Saturday	3	4	3.5
Sunday	4	5	4.5
<b>TOTAL:</b>	<b>1</b>	<b>5</b>	<b>3</b>

If **Show Previous value** option is selected, then the last valid step value will be displayed instead of N/A value. In this sample step table the N/A value is replaced by “2” – the last available value before N/A. Please see an example below:

Day	Min	Max	Avg
Monday	1	2	1.5
Tuesday	2	3	2.5
Wednesday	2	3	2.5
Thursday	2	3	2.5
Friday	2	3	2.5
Saturday	3	4	3.5
Sunday	4	5	4.5
<b>TOTAL:</b>	<b>1</b>	<b>5</b>	<b>2.785714</b>

**NOTE:** The last valid step value, which will be displayed instead of N/A value, must be available in the range of the existing values of this Step table, i.e. it should be present among the values existing inside the table. Otherwise it will display N/A.

If **Show Next Value** option is selected, then the next valid step value will be displayed instead of N/A value. Please see an example below:

Day	Min	Max	Avg
Monday	1	2	1.5
Tuesday	2	3	2.5
Wednesday	3	4	3.5
Thursday	3	4	3.5
Friday	3	4	3.5
Saturday	3	4	3.5
Sunday	4	5	4.5
<b>TOTAL:</b>	<b>1</b>	<b>5</b>	<b>3.214286</b>

In this sample step table the N/A value is replaced by “3” – the next available value after N/A.

**Special mark.** If the step value is not real (original), but is last or next available, then, such a cell will have a small red mark in the cell corner, like on the picture below:

Day	Min	Max	Avg
Monday	1	2	1.5
Tuesday	2	3	2.5
Wednesday	3	4	3.5
Thursday	3	4	3.5
Friday	3	4	3.5
Saturday	3	4	3.5
Sunday	4	5	4.5
<b>TOTAL:</b>	<b>1</b>	<b>5</b>	<b>3.214286</b>



Ocean Data Systems

**NOTE:** For footer and inter-column calculation, if cells have values, which are not real values (but last or next available), all the calculation is done using those values, regardless to their nature and origin.

**Example of a step table**

Step Table Settings		Weekly Oil Production			
Time Period:	Last Week	Day	Oil Well 1	Oil Well 2	Oil Well 3
Splitted:	By day	25/06/2007	1290.0 Brls	902.5 Brls	868.8 Brls
		26/06/2007	892.5 Brls	483.8 Brls	826.3 Brls
		27/06/2007	1172.5 Brls	650.0 Brls	506.3 Brls
		28/06/2007	1290.0 Brls	750.0 Brls	562.5 Brls
		29/06/2007	1143.8 Brls	802.5 Brls	1031.3 Brls
		30/06/2007	1087.5 Brls	606.3 Brls	593.8 Brls
		01/07/2007	1367.5 Brls	937.5 Brls	617.5 Brls
		<b>Weekly Production</b>	<b>8244 Barrels</b>	<b>5133 Barrels</b>	<b>5006 Barrels</b>
			44.85 %	27.92 %	27.23 %
		<b>Total Production</b>	<b>18382.5 Barrels</b>		

**Option**

Step Table enables to add "Footer".

This footer can have multiple lines to insert, Text, Expression or Compound data.

Batch Production				
Batch ID	Start	End	Run Time (hh:mm:ss)	Production
Batch_51	08/04/2007 13:00:13	13/04/2007 16:08:00	121:59:47	1350.00
Batch_52	13/04/2007 17:11:03	29/04/2007 07:09:09	360:48:57	225.00
Batch_53	29/04/2007 08:00:12	15/05/2007 13:09:59	387:59:48	150.00
Batch_54	15/05/2007 14:00:11	23/05/2007 10:10:59	186:59:49	450.00
Batch_55	23/05/2007 11:00:12	31/05/2007 07:11:59	174:59:48	375.00
Batch_56	31/05/2007 08:00:13	04/06/2007 15:12:59	101:59:47	1395.00
Batch_57	04/06/2007 16:00:14	30/06/2007 23:59:59	625:59:46	75.00
			<b>Total</b>	<b>4020</b>



## SQL Query Table

**SQL Query Table** is an object that allows you to connect to any ODBC compatible database and display data from it in a report.

To add this object, click on the *SQL Query Table* button on the Report Designer Studio **Elements** toolbar:



Using the Free SQL Table, you can specify any query and visualize the result as a table with predefined parameters.

To define a Free SQL Table, select the DSN for the database and write an SQL query.

The SQL Table also supports the command "**SELECT \* ...**". In this case, draw a table in the Designer Studio as one single column and then, during report generation, it will automatically expand to the right, where the number of columns will correspond to the number of the columns in the database table. The width of each column will be equal to the width of the table you have drawn in the Designer Studio. If the width of the SQL Table at report generation time is too wide, it will be truncated.

Any valid SQL commands can be specified in the **SQL Query** edit box. If you need to use dynamic values in your SQL condition, based on your statistical calculations, you can add any valid object name in the format **[f#<field name>]**, which can be either a Single data object, a Compound object or an Expression object. In this case, during report generation, the value of the specified object will be calculated and the result will replace the **[f#<field name>]** in the query.

For details, please see [List of Dynamic Tokens](#) section.

Such dynamic objects can be selected from the list and will be automatically added to the SQL query in required format. If user will click on *Select Dynamic Token* button, then window with the list of available dynamic objects will be opened and user can select required object and add it to the query as dynamic token. Detailed information on dynamic objects selection can be found in the dedicated section Dynamic objects selection.

### Visual Query Builder

Now, if user doesn't have deep knowledge of SQL language or would like to use visual tool to design SQL query, user can click on *Visual Query Builder* button and then visual SQL query builder window will be opened, where user can create and edit his SQL query in a user-friendly manner. More in details Visual query builder is described in its section **Visual Query Builder**

### Using pre-defined SQL queries

User has also the ability to use predefined complete SQL queries or used pre-defined queries as any integral part of the entire query. The SQL Query manager module allows users to The *Select existing SQL query* drop down list contains the list of all already defined SQL queries. Detailed description of SQL Query Manager can be found in its dedicated section





## SQL Query Manager

In the **Appearance** section you can define the formatting for your table, such as the maximum number of columns, sorting (if not defined in a query), font, background color, etc.

### SQL Table Data Definition

The **SQL Query Table** must configure the SQL table settings as follows:

- Select the DSN (for details please see the **DSN Manager** section of this manual)
- Define the Query:

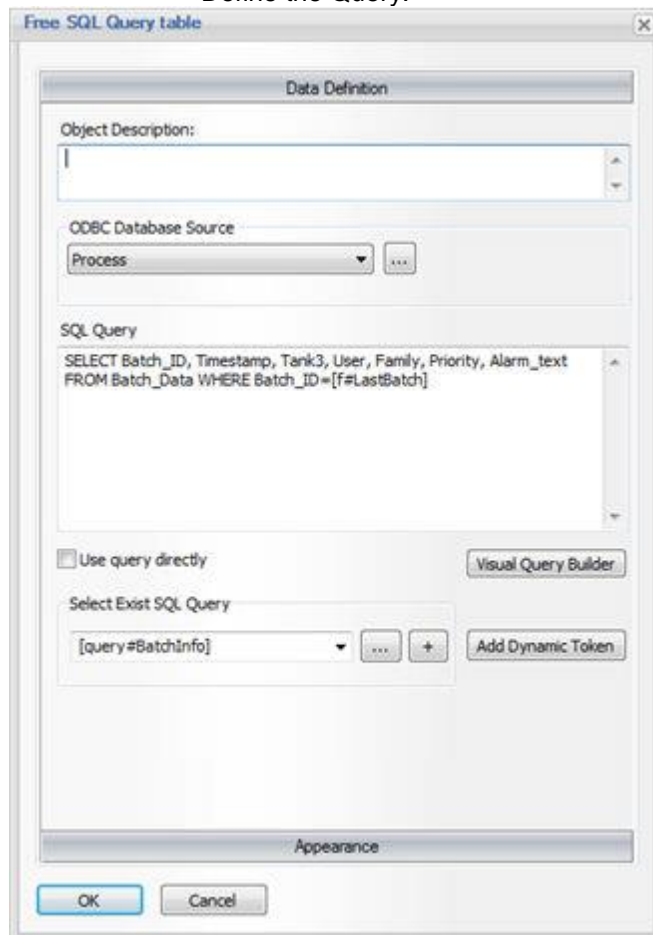

SQL Query table can automatically recognize the list of SQL columns, which will be retrieved from the database and the internal SQL query parser has certain limitations, described below. If you mark the check box **Use query directly** (below the SQL query edit box), then the SQL query will be executed exactly as it is, without trying to parse it.

### Case Example:

You need to extract from the Batch Database Tank Level values for the batch number 4 under condition, when Motor 1 is On (1)

You must define the DSN for the database and select it in the **ODBC Database Source** combo box (see **DSN Manager**).



### Ocean Data Systems

TIMESTAMP	BATCH	Motor1	Motor2	Motor3	Temp1	Temp2	Temp3	TankLevel	TankLevel2	TankLevel3
01/01/2005 03:50:18	1	1	0	1	10	2	100	560	668	1130
01/01/2005 09:45:02	1	0	1	1	20	5	50	375	440	770
01/01/2005 15:56:10	1	1	1	0	30	10	25	325	370	680
01/01/2005 19:25:04	1	0	0	0	40	15	15	350	390	740
02/01/2005 07:50:12	1	1	1	1	50	25	10	425	460	900
02/01/2005 12:15:18	1	0	1	0	60	30	9	495	534	1050
02/01/2005 16:30:28	1	1	1	1	65	35	8	540	578	1145
02/01/2005 21:00:00	1	0	0	0	70	40	7	585	622	1240
03/01/2005 02:20:21	1	1	1	1	75	45	6	630	666	1335
03/01/2005 10:50:18	1	1	1	1	80	50	5	675	710	1430
03/01/2005 12:32:05	1	1	1	1	82	55	4	705	736	1492
03/01/2005 14:50:09	1	0	0	0	84	25	3	560	622	1204
04/01/2005 08:00:00	1	0	0	0	86	45	2	665	708	1416
04/01/2005 11:50:12	2	1	0	1	88	65	1	770	794	1628
04/01/2005 13:53:18	2	0	0	0	90	55	0	725	760	1540
04/01/2005 23:50:18	2	1	1	1	91	35	5	655	716	1401
05/01/2005 08:05:00	2	1	1	1	92	60	10	810	852	1712

Enter the right SQL query: **SELECT** TIMESTAMP, BATCH\_NUM, Motor1, TankLevel1 **FROM** Batch **WHERE** BATCH\_NUM=4 **AND** Motor1=1

Then you will get the following result in your report:

TIMESTAMP	BATCH_NUM	MOTOR1	TANKLEVEL1
2005-01-18 08:00:00	4.00	1.00	1201.04
2005-01-17 15:50:18	4.00	1.00	1134.32
2005-01-17 09:50:18	4.00	1.00	916.84
2005-01-16 16:50:18	4.00	1.00	628.39
2005-01-16 12:50:18	4.00	1.00	535.32
2005-01-15 15:39:18	4.00	1.00	626.28
2005-01-15 09:21:18	4.00	1.00	678.21
2005-01-14 18:50:18	4.00	1.00	394.62
2005-01-14 16:23:33	4.00	1.00	688.57



## SQL Table Appearance

### SQL Query Parser

When you enter the SQL query, by default it will be automatically parsed. When you open the **Appearance** section, you will see the list of columns to be selected, where you can edit column captions in an easy way, as displayed on the picture below:

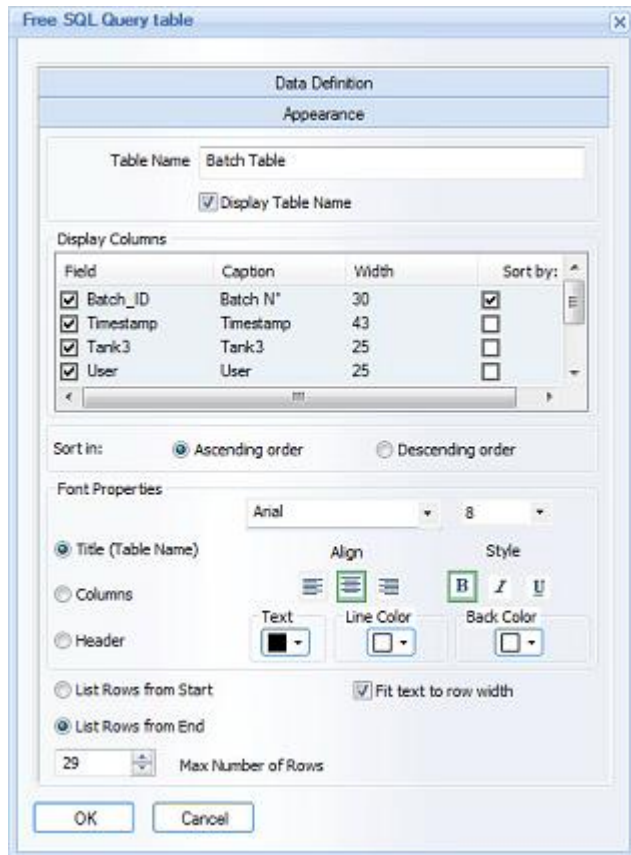

However, SQL Query table parser has the limitation of SQL functions, which it is able to recognize. Please, find below the list of supported and unsupported functions.

#### Supported and Unsupported Functions:

The following SQL statements (actions and manipulations) are not supported by SQL table :

UPDATE, DELETE, INSERT INTO, CREATE DATABASE, ALTER DATABASE, CREATE TABLE, ALTER TABLE, DROP TABLE, CREATE INDEX, DROP INDEX, OPENQUERY (from InSQL syntax)

SQL Table also do not support JOIN or UNION, however you can create a table like:

**SELECT \* From Tbl1 Where <condition>**

**SELECT DISTINCT column\_name(s)From Tbl1 Where <condition>**

Operators Allowed in the WHERE section:

=, <>, >, <, >=, <=, BETWEEN, LIKE, IN, AND, OR, NOT, IS

Condition can also include select clause, for example this query will also work well:



```
SELECT Timestamp, User, Temp1 FROM Batch_Data WHERE Temp1>(SELECT AVG(Temp1) FROM Batch_Data)
```

Supported functions:

SQL avg()  
SQL count()  
SQL first()  
SQL last()  
SQL max()  
SQL min()  
SQL sum()  
SQL Group By  
SQL Having  
SQL round()  
SQL now()  
SQL format()  
SQL Convert()

### Disabling Query Parser

If you want to enter the SQL query, which contains functions, unsupported by the table parser, please, check the check box **Use query directly**, and the SQL Query parser will be disabled and the query will be launched as it is.

### Calling a stored procedure from Free SQL Query Table

It's possible to call a stored procedure using Free SQL Query table. To do that:

- Create SQL Table, select required DSN and specify user name and password for that DSN (if required).
- Inside the SQL query edit box write the following command:

```
{CALL ProcedureName (Parameter)}
```

#### **Example:**

```
{CALL sp_GetNameById ( 1 )}
```

Where:

`sp_GetNameById` - name of the stored procedure

`1` - the parameter for the stored procedure

It's very important not to put space between the first curly brace and the **CALL** keyword.

It's not that important for the last curly brace.

The result of the stored procedure will be displayed in that SQL table.

#### **IMPORTANT NOTES:**

- When using an MS Access database and column names or table names starting with "\_" or other non-alphanumeric symbols, enclose the column or table names in square brackets (e.g. [MyTable] or [MyColumn]). This is not required for SQL Server or other database types.
- Statement **SELECT \*** can be used also. Then in the Designer Studio, you will see the table with a single column and, when generating the report, the table will be created according to the number of the retrieved columns.
- Statement **AS** is not supported by the query parser, so SQL queries such as: **SELECT abs AS 'Param1' ...** shouldn't be used.



## Ocean Data Systems

The **Display Columns** list defines which columns will be displayed as well as their order, width and caption.

The left row of check boxes enables and disables the appropriate column display in the table.

The **Caption** column defines the caption of each column of the table. If you wish to change the caption of any column, double-click on the appropriate caption inside the column and it will be available for editing.

The right set of check boxes - **Sort By** - will define by which column the data will be sorted. Only one column can be selected. Radio buttons below (**Sort In**) will define the sort direction, *ascending* or *descending*.

The Font Properties controls enable you to set different font properties for the table title, table header and the displayed data (in columns).

The **Max Number of Rows** edit box allows you to specify the maximum number of rows to display in the table. This enables a user to protect the report from an overflow.

When defining the maximum number of rows, you can set, which "cut" of all data set you would like to display: the first or the last block of data. This can be defined by selecting an appropriate radio button: **List rows from Start** or **List rows from End**.



## Designer Studio - Alarm Table

**Alarm Table** is a dynamic object, which displays, in a selected format, a list of alarms according to the specified time period and the selected alarm filter.

Click on the "*Alarm Table*" button on the Report Designer Studio **Elements** toolbar:

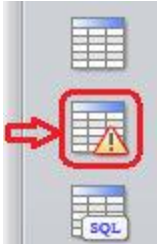

Then draw a rectangle where you want to place the table in the report workspace. The **Alarm Table Data Definition** dialog window will be opened:

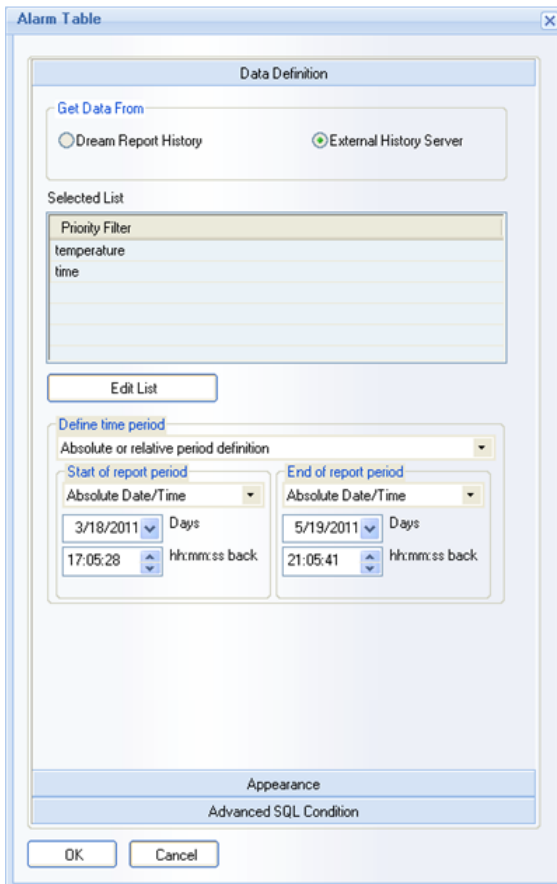

### Alarm Table Data Definition

In the **Get Data From** section you can select which history type you will use to extract alarms from: **Dream Report History** or **External History Server**.

The alarm table will display a list of alarms, which have occurred during the defined period after applying one or more selected alarm filters.



To define an alarm filter, please, click on the **Edit List** button. The **Alarm Filter Manager** window will be opened.

For details on how to configure alarm filters, please, see the **Alarm Filter Manager** section.

When you select one or more alarm filters for the table, please define the time period as described. **Time Definition** is described in details in the **Time Definition** section of this manual.

### Alarm Table Appearance

To adjust the format of the table, click on the **Appearance** floating splitter and the **Alarm Table Appearance** dialog window will be opened (see pic. below):

The **Table Name** field will contain a name, which will be displayed if the **Display Table Name** check box is enabled.

The **Display Columns** list defines which columns will be displayed as well as their order, size, width and caption.

The left row of check boxes enables and disables the appropriate column display in the table.

The **Caption** column defines the caption of each column of the table. If you wish to change the caption of any column, double-click on the appropriate caption inside the column and it will be available for editing.

Selecting any column, and clicking **Move Up** or **Move Down** buttons will change the order of the selected column.

The right set of check boxes - **Sort By** - will define by which column the data will be sorted. Only one column can be selected. Radio buttons below (**Sort In**) will define the sorting direction, **ascending** or **descending**.

The **Font Properties** controls enable you to set different font properties for the table title, table header and the displayed data (in the columns).

When you define a table, you never know how many rows will actually be displayed. It may be few, but may also result in dozens of pages in a report. Therefore the **Max Number of Rows** edit box allows you to specify the maximum number of rows to display in the table. This enables a user to protect the report from an overflow.

When defining the maximum number of rows, you can set which "cut" of all data set you would like to display: the first or last block of data. This can be defined by selecting the appropriate radio button: **List Rows from Start** or **List Rows from End**.

**Note:** Please, always keep in mind that an Alarm table will display a number of alarms, not more than the defined as maximum, therefore make sure to define the **Max Number of Rows** as high as needed.

At the same time, if your report contains alarm tables with several dozens thousands of lines, which will result in several hundreds pages report, generation of such report may take very long generation time or fail.

User will be able to select the way the report alarm data will be displayed in the alarm table. There are 3 options that can be selected by checking: **"Display every alarm once"**, **"Fit rows to text"**, **"Display as event list"**.

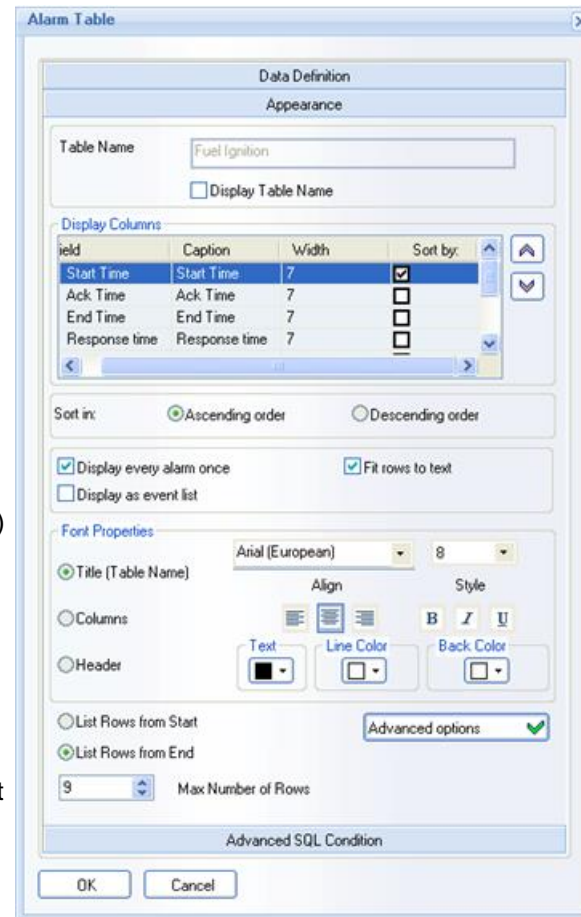





**Display every alarm once.** If this check box will be checked, then, if the same alarm will occur multiple times over the period, it will be presented in the list by one (first) occurrence line only. The criteria to compare alarms to identify the same alarms will be the combination of **Alarm text** and alarm **Priority**. If an alarm will have the same text and the same priority, it will be considered as the same alarm. If priority is not available, then the alarm text will only be used for analysis. Timestamp of the last occurred alarm will be shown. If for the last started alarm there is no acknowledged time or/and end time, the corresponding columns will be empty.

The **Duration** column will show accumulated duration time for all alarm occurrences. If there is no end time for the last occurrence, the **Duration** column will show duration for previous occurrences. If there is only one alarm without end time, the **Duration** column will be empty. The **Response Time** column will show response time for the last occurrence only. If the last occurrence doesn't have an acknowledged time, the **Response Time** column will be empty.

**Number of occurrences.** The list of available alarm table columns will have a new column: **Number of occurrences**. This will be the calculated column (like **Duration** or **Response time**), and it will display how many times the same alarm occurred during the alarm table period. The criteria to compare alarms to identify the same ones will be – by **Alarm text** and **Priority**. If **Priority** is not available, then the alarm text only will be used for analysis.

**NOTE:** This column is available only in mode “**Display every alarm once**”.

**Fit rows to text.** By default this display option will be enabled. If it is enabled, the height of the header cells will increase and the data cells part of the table will have less size to fit the text. If this option is disabled, the height of the data cells part of the table will increase, thus giving more size to the text so that maximum fits.

**Display as event list.** If this check box will be selected, then, the alarm table will automatically unselect display of the following table columns: **Ack time, End time, Duration, Response time**. The message list table style will have only the following table columns available: **Start time, Alarm text, Priority**. This mode can be possibly selected in the combination with the “**Display every alarm once**” mode. In this combination single line for alarm will be shown, and the criteria to compare will be the same. In this case the column **Number of occurrences** will also be available.

### Advanced Visualization

If a user will click the button **Advanced Options**, the **Advanced visualization** dialog window will be opened:

The check box **Enable advanced visualization** defines if the advanced visualization mode is enabled or disabled. If you have created all the logic of advanced visualization and then disabled that mode – the entire definition won't be deleted. It will be automatically saved and will just not be used for reporting. You can enable that definition again if you need, without its re-definition.

The **Alarm property** combo box has the following options in its list: **Priority, Duration, Number of alarm occurrences**.

The **Duration** column will be available only in normal mode.

The **Number of Occurrences** column will be available only if “**Display single alarm**” mode will be selected. The Property filter will define the property value range. The font style will define the text and the background color and style for all alarms, which will apply to that property range.

**NOTE:** If the same alarm is applied to the multiple defined filters, which exclude each other, then the first one will be taken.

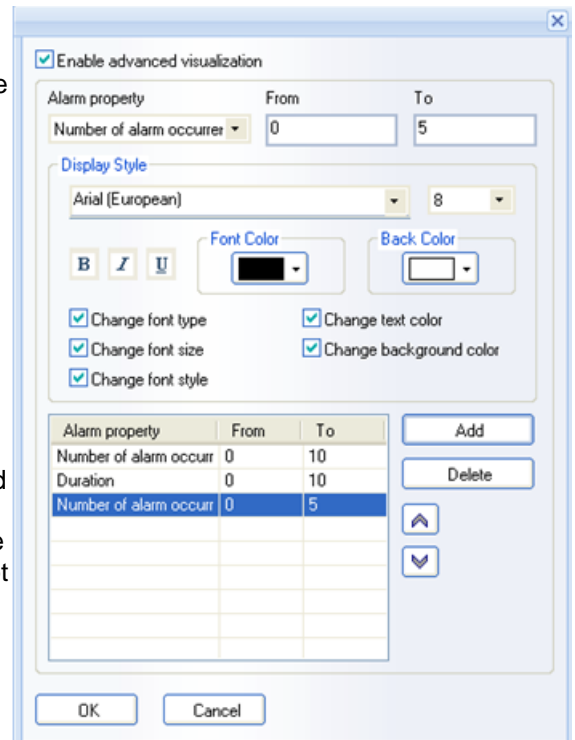





## Ocean Data Systems

If the same alarm is applied to different filters, which do not exclude each other, then both visual properties will be applied.

If a user will enable advanced visualization, then the “**Advanced Options**” button will have additional **OK** icon on it, indicating, that **Advanced visualization** is enabled in this object:

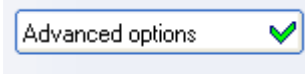

### Example of Alarm table:

All Alarms				
Heure de début	Heure Acq.	Heure de Fin	Champ Priorité	Texte de l'Alarme
30/06/07 14:00:00	30/06/07 14:30:00	30/06/07 15:00:00	8	Production Starts
30/06/07 15:00:00	30/06/07 15:30:00	30/06/07 16:00:00	9	Starts System
30/06/07 16:00:00	30/06/07 16:30:00	30/06/07 17:00:00	6	Valves Open
30/06/07 17:00:00	30/06/07 17:30:00	30/06/07 18:00:00	8	Mixer runs
30/06/07 18:00:00	30/06/07 18:30:00	30/06/07 19:00:00	7	Enter Settings Value
01/07/07 07:00:00	01/07/07 07:30:00	01/07/07 08:00:00	6	Batch can Progress
01/07/07 08:00:00	01/07/07 08:30:00	01/07/07 09:00:00	5	Motor Runs
01/07/07 09:00:00	01/07/07 09:30:00	01/07/07 10:00:00	3	Timer in Progress
01/07/07 10:00:00	01/07/07 10:30:00	01/07/07 11:00:00	9	Valve Open
01/07/07 11:00:00	01/07/07 11:30:00	01/07/07 12:00:00	8	Production Starts
01/07/07 12:00:00	01/07/07 12:30:00	01/07/07 13:00:00	5	Valve Closed
01/07/07 13:00:00	01/07/07 13:30:00	01/07/07 14:00:00	2	Pumps 100%
01/07/07 14:00:00	01/07/07 14:30:00	01/07/07 15:00:00	7	in Progress
01/07/07 15:00:00	01/07/07 15:30:00	01/07/07 16:00:00	8	Valve In Closed
01/07/07 16:00:00	01/07/07 16:30:00	01/07/07 17:00:00	8	Tank Filled 60%
01/07/07 17:00:00	01/07/07 17:30:00	01/07/07 18:00:00	9	Confirm Settings
01/07/07 18:00:00	01/07/07 18:30:00	01/07/07 19:00:00	5	Tank Filled



## Table Footer

The [Step](#), [SQL](#) and [Automatic Statistical](#) tables all include a **Footer** option. This footer can have multiple lines, which can include static text, table start time, table end time, Expression or Compound data objects. Click on the “**Footer**” button in the [Appearance](#) settings of the specific table object to open the **Footer** configuration window:

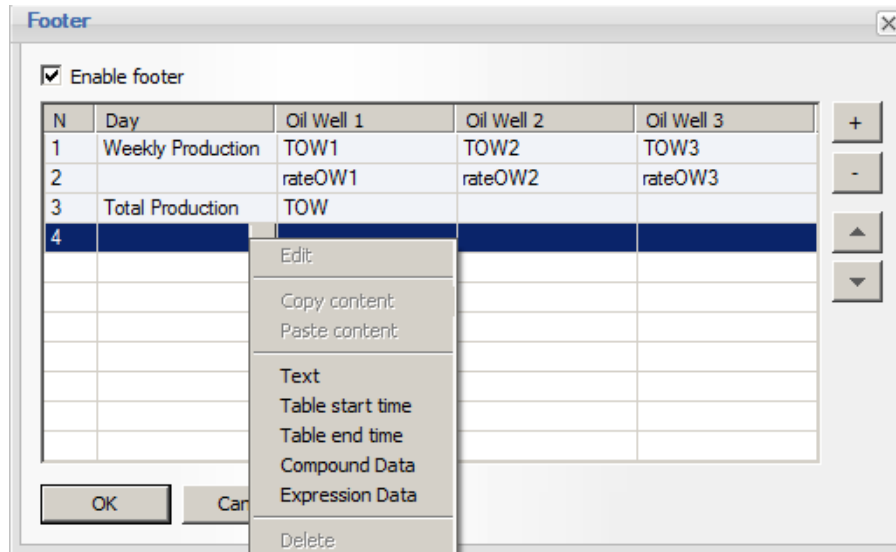

To configure a table Footer, check the **Enable Footer** option to include the footer in the table.

Click the “+” or “-” buttons to add or remove footer lines - for instance, if you needed a footer to include a Min, Max and Avg value under each column, click the “+” three times to have a three-line footer.

After adding blank footer lines, you can choose what content to include in each footer “cell”. Click the “[...]” button in each cell to add one of the following items: [Text](#) (e.g., a “label”), [Table Start Time](#), [Table End Time](#), [Compound Data](#), or [Expression Data](#).

**Text:** Type in a static text label (e.g., “Minimum”)

**Table Start Time:** This will open the [Date/Time Definition](#) window, where you can specify the date/time format to display in the footer

**Table End Time:** This will open the [Date/Time Definition](#) window, where you can specify the date/time format to display in the footer

**Compound Data:** This opens the [Compound Data Object Definition](#) window, which is configured as described in the [Compound Object](#) section. Enter a unique name for that footer item, and optionally, a description. Note that the names of all the table fields, and all the table footer cells are available for the Compound object calculation. For example, if you wanted to display the maximum value of all values in a column (field), select that field name from the list (e.g., [Temp1]) and then in the [Select Function](#) section below, select “[Maximum](#).” Click the [Appearance](#) tab to configure the result representation and [Advanced](#) display options for that specific footer value.

**Expression Data:** This opens the [Expression Data Object Definition](#) window, which is configured as described in the [Expression Object](#) section. Enter a unique name for that footer item, and optionally, a description. Build the mathematical or logical (using Lua script) expression. Click the [Appearance](#) tab to configure the result representation and [Advanced](#) display options for that specific footer value.



## Ocean Data Systems

If you wish to copy the content of one footer cell to another footer cell, right-click on the appropriate cell, and select either “Copy Content” or “Paste Content”. You can edit the pasted content by right-clicking on the appropriate cell and selecting “Edit”.

Finally, to change the order in which the footer lines are displayed, select the appropriate footer line, and click the **Up** or **Down** arrow to move that line. Repeat for any other footer lines you wish to re-order.

The Footer configuration shown at the start of this section results in the following table output - note the mix of **Text**, **Compound** and **Expression** objects in the footer:

Weekly Oil Production			
Day	Oil Well 1	Oil Well 2	Oil Well 3
12/14/2015	838.8 Brls	501.3 Brls	806.3 Brls
12/15/2015	1,380.0 Brls	956.3 Brls	833.8 Brls
12/16/2015	851.3 Brls	452.5 Brls	791.3 Brls
12/17/2015	1,022.5 Brls	621.3 Brls	587.5 Brls
12/18/2015	1,002.5 Brls	525.0 Brls	600.0 Brls
12/19/2015	1,245.0 Brls	737.5 Brls	675.0 Brls
12/20/2015	845.0 Brls	515.0 Brls	793.8 Brls
Weekly Production	7,185 Barrels	4,309 Barrels	5,088 Barrels
	43.33 %	25.99 %	30.68 %
Total Production	16,581.3 Barrels		

Table Footer

Static Text

Expression Object - Calculate % of total

Compound Object - "Sum" of column



# Charts and Graphs

## Pie Graph

**Pie Graph** is an object that displays data in a pie chart. The data can be either a data value, a counter of logged values or a counter of logged alarms.

To add a pie chart to a report, click the **Pie Graph** button on the Report Designer Studio **Elements** toolbar:



Draw a rectangle where you would like to place the chart in the report workspace, and the **Pie Graph Definition** dialog window will be opened:

### Pie Graph Definition

The upper combo box "**Chart Based On**" defines the kind of data that will be displayed in the chart. You can select:

**"Value"** - to display a raw data item or a statistical value for a defined period

**"Counter of Logged Values"** - to display the number of times the selected data item was logged into the database and its value matched a specified value range.

**"Alarm Count per Period"** - to display the number of alarms during a specified period of time, which matched the selected alarm filters.

The **Get Data From** radio buttons specify the kind of data source for the chart: **Dream Report History** or **External History Server**.

To create a new chart, select a list of data items and a slice color for the data item in the chart, enter a label for the legend (if needed), and click the **Add** button.

The data source and data item can be selected from the relevant combo boxes in the **Select Data Item** group.

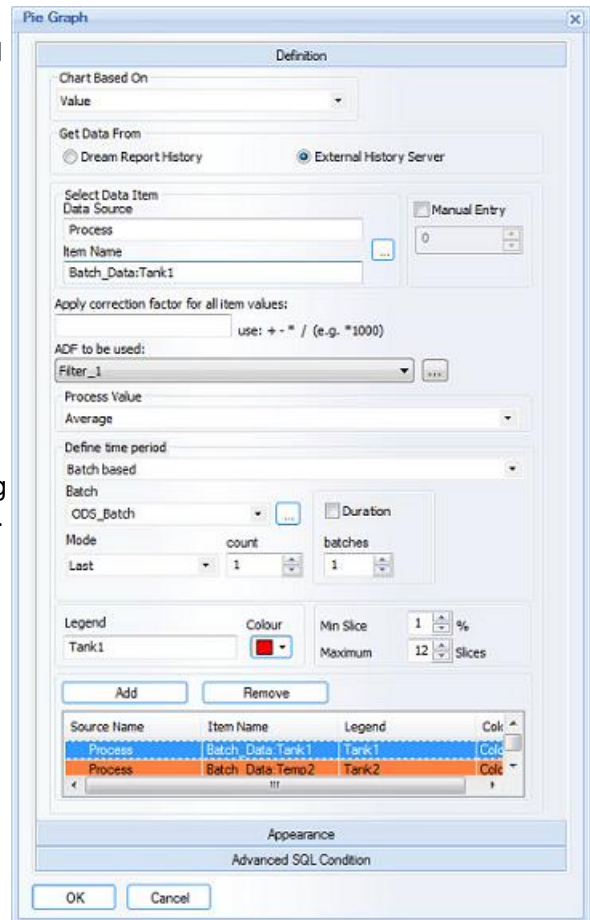

**Apply correction factor for all item values** enables adding simple expression to a pie graph. If a user needs to display pie graph on item(s) with the correction factor, then, first, all values of the selected item(s) will be re-calculated, applying correction factor, and then, the pie graph will display re-calculated data.

For more details, please refer to the **Correction Factor** section.



**ADF to be used:** enables to select an aggregated data filter. "ADF to be used" combo box will contain all ADF definitions configured in the project. The default string will be "Not Used", i.e. no filter (ADF) is applied.

For details on ADF definition/configuration, please go to the Aggregated Data Filter section of this manual.

When displaying data item values for a specified period, in the **Process Value** combo box you can select one of the options to display. It can be either:

- **Last value** - the last raw value from the database
- **Current value** - the current value for the specified data item from the real-time data driver
- **Average** - the average value for this data item, calculated for the specified time period
- **Minimum** - the minimum value for this data item, calculated for the specified time period
- **Maximum** - the maximum value for this data item, calculated for the specified time period

The **Define time period** section defines the time period for statistical calculations for this object and is described in detail in the **Time Definition** section of this manual.

The **Manual Data Entry** check box supports entering a static numeric value that will be constant during report generation. This allows users to create a pie graph combining statistical data and static reference data.

In order to add manual data, check the **Manual Data Entry** check box, enter the constant in the edit box below, select the desired color for the corresponding slice, enter a label for the legend, if needed, and click the **Add** button.

Please, note that when the **Manual Data Entry** check box is checked, all data definition controls, like data item selection, time definition etc., will be disabled. To enable those controls again, uncheck the check box.

### Counter of Recorded Values

If you select a chart type of **Counter of recorded values**, enter a range of values **FROM** and **TO** on which to filter the data in the edit boxes. *Dream Report* will go to the history and count how many times the selected data item's values matched the value filter, and display the result in the chart.

### Alarm Count per Period

If you will select a chart type of **Alarm Count per Period**, the **Define Alarm Filter** button will appear:

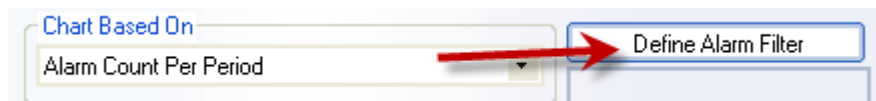

Click on the **Define Alarm Filter** button and the **Alarm Filter Manager** dialog window will be opened. You can select one alarm filter, pick a desired color, enter the label for the legend (if desired), and press the **Add** button. If this pie function is selected, *Dream Report* will go to the alarm history and count how many alarms matched the selected alarm filter, and will display the result in the chart.

#### NOTES:

- Pie configuration cannot include different pie functions - one pie graph can only include slices with the same pie function.
- Pie configuration doesn't include slices with different time periods - one time period applies to the entire pie chart for all slices.



## Pie Graph Appearance

The **Appearance** section of the **Pie Graph** definition window contains formatting options for the chart.

The optional **Pie Graph Name** edit box will contain the title, which will be displayed above the chart.

The **"Display Name"** check box will enable or disable the title display (make it visible or invisible).

The **Display Options** section defines which pie object properties will be displayed in a report:

- **Display Legend** - displays a legend box. It can be displayed on the right side or on the bottom of the pie.
- **Display Border** - displays a line between pie slices and on its edges. The line color for the border can be adjusted.
- **Display Value** - displays numeric value for each slice. The value is placed inside each slice and the font properties, decimal precision and measure units are adjustable.
- **Display Percentage (%)** - displays percentage of each slice within 100% for all slices. The percentage is displayed next to each slice.
- **Show Values in Legend** - displays numeric value for each slice in the graph Legend. Font properties are adjustable in the **Display Style** (described below).

- **Show Percentage in Legend** - displays percentage of each slice within 100% for all slices in the graph Legend. Font properties are adjustable in the **Display Style** (described below).
- **Pie Graph Style** - select the style of the Pie Graph to be displayed. Options are **"Pie"**, **"3D Pie"** and **"Doughnut"**. Settings for each option are as follows:
  - **Pie**: **"Pie Depth"** in mm
  - **3D Pie**: **"Pie Depth"** in mm; **"Pie Angle"** in degrees
  - **Doughnut** Style: **"Flat Doughnut"**; **"In Gradient Doughnut"**; **"Out Gradient Doughnut"**; **"Rounded Doughnut"**

**Display Style** defines text display options for different parts of the chart:

- **Title** - when this radio button is selected, you can specify the font type and size for the chart title. Also you can select text alignment, font style, font color and background color for the title text. To use a transparent background color for the title, open the background color palette and select **"No color"**. This option is only applicable when **"Display Name"** check box is enabled.
- **Legend** - when this radio button is selected, you can specify the font type and size for the legend. Also you can select the position of the legend - either on the bottom or on the right side of the chart. Also you can specify the font style, font color and background color for the legend. To use a transparent background for the legend, open the background color palette and select **"No color"**. This option only applies when the **"Display Legend"** check box is enabled.





## Ocean Data Systems

- **Values** - when this radio button is selected, you can specify the font type and size for slice values. You can also select text alignment, font style, font color and background color for the value text. This option only applies when the "[Display Value](#)" check box is enabled.
- **Percentage** - when this radio button is selected, you can specify the font type and size for slice percentages. You can also select the text alignment, font style, font color and background color for percentage text. This option only applies when the "[Display Percentage \(%\)](#)" check box is enabled.

The [Select unit to add to result](#) defines which engineering unit to display after the decimal point in slice values. This option makes sense only when the [Display Value](#) check box is selected.

[Precision of result after decimal point](#) defines how many digits after the decimal point will be displayed. This option can only be applied when the [Display Value](#) check box is selected.

The [Advanced SQL Condition](#) section is described in details in the [Advanced SQL Condition section](#).

### Examples of "3D Pie" and "Doughnut" Graphs:

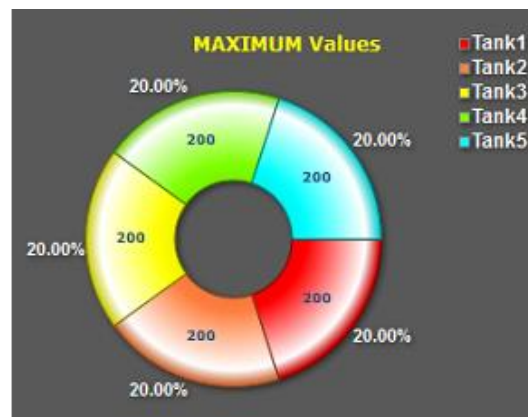
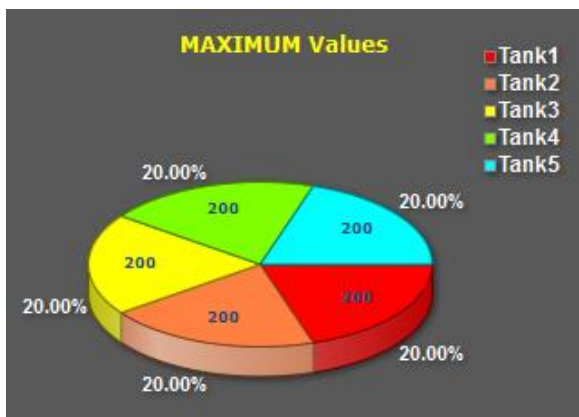



## Bar Graph

**Bar graph** displays data in a bar chart. The data can be either a data value, a counter of logged values or a counter of logged alarms.

To add a bar chart to a report, click the **Bar Graph** button on the Report Designer Studio **Elements** toolbar:

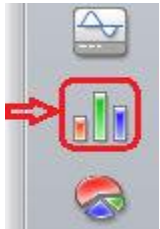

Draw a rectangle where you would like to place the chart in the report workspace, and the **Bar Graph** definition dialog box will be opened.

### Bar Graph Definition

The upper combo box "**Chart Based On**" defines the kind of data that will be displayed in the chart. You can select:

**"Value"** - to display a raw data item or a statistical value for a defined period

**"Counter of Recorded Values"** - to display the number of times the selected data item was logged into the database and its value matched a specified value range.

**"Alarm Count"** - to display the number of alarms during a specified period of time, which matched the selected alarm filters.

**"SQL Query"** - to use the results of an SQL Query to display values for a defined time period.

The **Get Data From** radio buttons specify the kind of data source for the chart: **Dream Report History** or **External History Server**.

To create a new chart, select a list of data items and a bar color for the data item in the chart, enter a label for the legend (if needed), and click the **Add** button.

The data source and data item can be selected from the relevant combo boxes in the **Select Data Item** group.

**Apply correction factor for all item values** enables adding simple expression to a bar graph. If a user needs to display bar graph on item(s) with the correction factor, then, first, all values of the selected item(s) will be re-calculated, applying correction factor, and then, the bar graph will display re-calculated data.

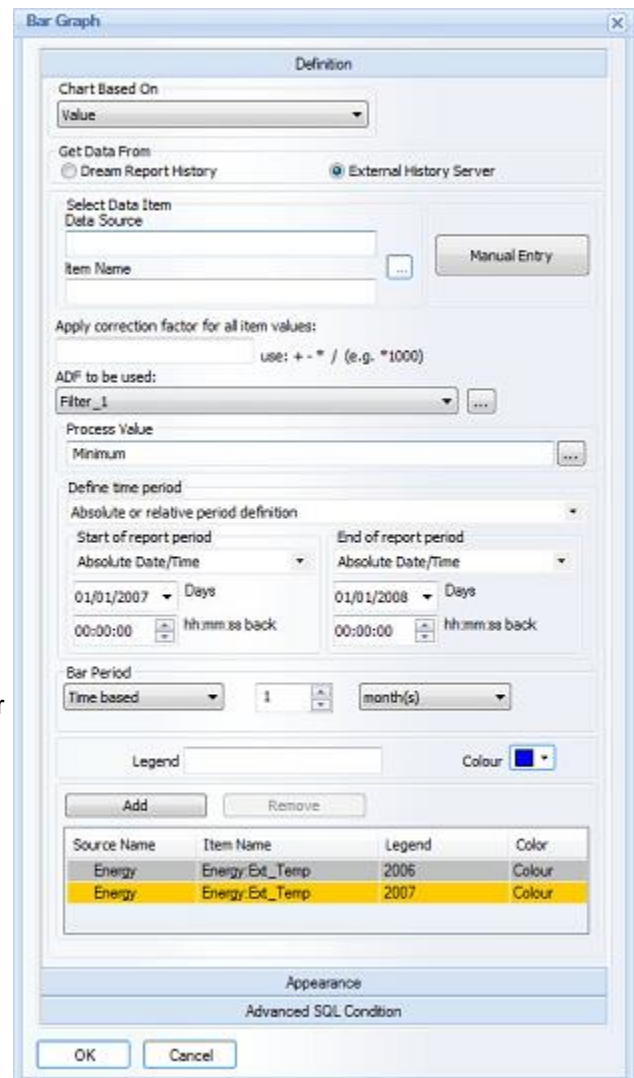

For more details, please refer to the **Correction Factor** section.





**ADF to be used:** enables to select an aggregated data filter. "ADF to be used" combo box will contain all ADF definitions, configured in the project. The default string will be "Not Used", i.e. no filter (ADF) is applied.

For details on ADF definition/configuration, please go to the Aggregated Data Filter section of this manual.

When displaying data item values for a specified period, in the **Process Value** combo box you can select one of the options to display. It can be either:

- **First value** - the first found value for the selected item from a database within the specified time period;
- **Last value** - the last raw value from the database;
- **Current value** - will read and display the current value from the specified data item from real-time data driver;
- **Average** - the average value for this data item, calculated for the specified time period;
- **Maximum** - the maximum value for this data item, calculated for the specified time period;
- **Minimum** - the minimum value for this data item, calculated for the specified time period;
- **Sum** - calculates the sum of all values of this data item during the specified time period;
- **Integral** - calculates the integral of all values of this data item during the specified time period;
- **Standard deviation** - calculates the standard deviation of all values of this data item during the specified time period;
- **Weighted average** - the weighted average value for this data item, calculated for the specified time period;
- **Duration in the interval (hours)** - calculates the duration (in hh:mm:ss) when values of this data item were in the specified value range during the specified time period;
- **Counter** - calculates the counter value from values of this data item during the specified time period;
- **ON Counter** - calculates the ON Counter from all values of this data item during the specified time period;
- **OFF Counter** - calculates the OFF Counter from all values of this data item during the specified time period;
- **ON/OFF Counter** - calculates the ON/OFF Counter from all values of this data item during the specified time period;
- **System availability** - calculates the system availability (in %) using all values of this data item during the specified time period;
- **SQL Query** - performs a predefined SQL query in the selected database.

**NOTE:** For more details on each of the statistical functions, listed above, please, go to the Single Data Object section.

The **Define time period** section defines the time period for statistical calculations for this object and is described in detail in the **Time Definition** section of this manual.

The period can be time-based or **Batch-based**. This is described in detail in the Batch Definition section .

The **Bar Period** section will allow you to define the period of time per bar group. The bar graph will draw a graph window for a time period, defined in the **Time Definition** section. This window will be split into sections with the length of each section based on the **Bar Period** definition. All bar slices will be calculated and displayed separately for each period.

The **Manual Entry** check box supports entering a static numeric value that will be constant during report generation. This allows users to create pie graph combining statistical data and static reference data.

In order to add manual data, check the **Manual Entry** check box, enter the constant in the edit box below, select the desired color for the corresponding bar, enter a label for the legend, if needed, and click the **Add** button.

Please, note that when the **Manual Entry** check box is checked, all data definition controls, like data item selection, time definition etc., will be disabled. To enable those controls again, uncheck the check box.



## Counter of Recorded Values

If you select a chart type of **Counter of Recorded Values**, then in the edit boxes enter the range of values which will be used for data filtering. Dream Report will go to the history and count how many times the selected data item's values matched the value filter and display the result in the chart.

## Alarm Count

If you will select a chart type of **Alarm Count**, the **Define Alarm Filter** button will appear:

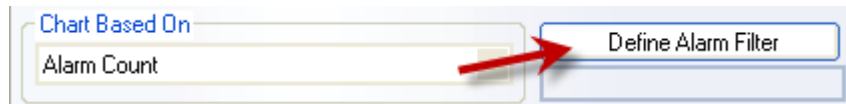

Click on the **Define Alarm Filter** button, and the **Alarm** Filter Manager dialog window will be opened. You can select one alarm filter, pick a desired color, enter the label for the legend (if desired,) and press the **Add** button. If this bar function is selected, *Dream Report* will go to the alarm history and count how many alarms matched the selected alarm filter and will display the result in the chart.

### NOTES:

- Bar configuration cannot include different bar functions - one bar graph can only include bars with the same function.
- Bar configuration doesn't include bars with different time periods - one time period applies to the entire chart for all bars.



## Bar Graph Appearance

The **Appearance** section of the **Bar Graph** definition window contains formatting options for the bar graph object.

The **Bar Graph Name** edit box can contain an object title.

The **Display Options** define which bar graph object properties will be displayed in the report:

- **Display Name** - displays a title for the chart (make it visible or invisible).
- **Display Legend** - displays a chart legend. It can be displayed on the right side or on the bottom of the chart.
- **Display Values on Y Axis** - displays values labels on the Y-axis. Axis lines and values will have the same color as the bar color.
- **Display Timestamp on X axis** - displays the timestamp on the X-axis of the chart. The timestamp may have a different format, defined in the **Timestamp Format** combo box below the check boxes.
- **Display Value** - displays numeric value for each bar. The value is placed inside each bar.
- **Single-column** option will change visual representation of data. When this option will be selected, all defined bars, which have to be displayed next to each other, will be displayed in one bar column, one above another, so that each bar group will be represented by one single column bar for each bar, as displayed in the image below:



## Ocean Data Systems

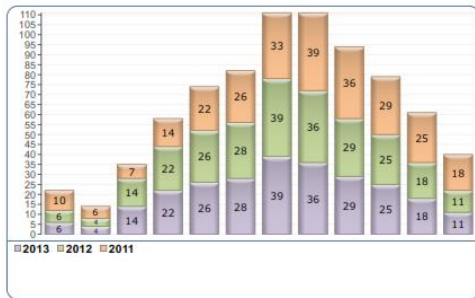

- **Pareto graph** option enables bar graph to display all bar graphs in one group, sorted by its value, as displayed in the image below:

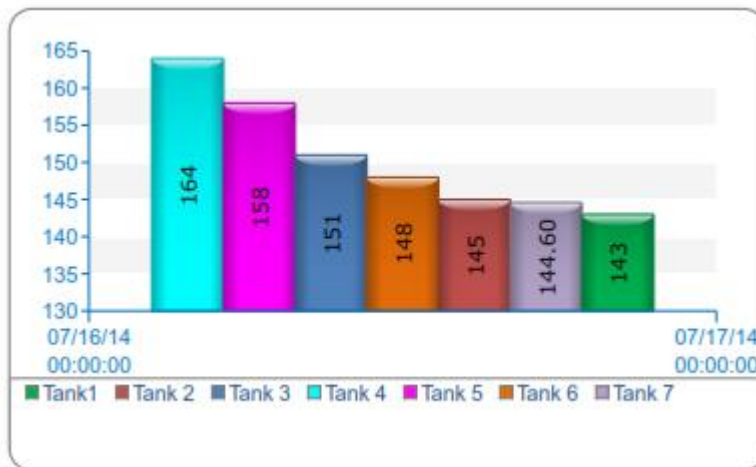

- **Show Bar Border** option, when checked, will draw a solid black border around each plotted bar.
- **Show Bar Interspace** option, when checked, will separate each "Bar Period" with a space. If left unchecked, all bars will be plotted next to each other without any spacing between bars.
- The **Bar Type** combo box enables selection of one of the following options for the visual bar representation:



# Ocean Data Systems

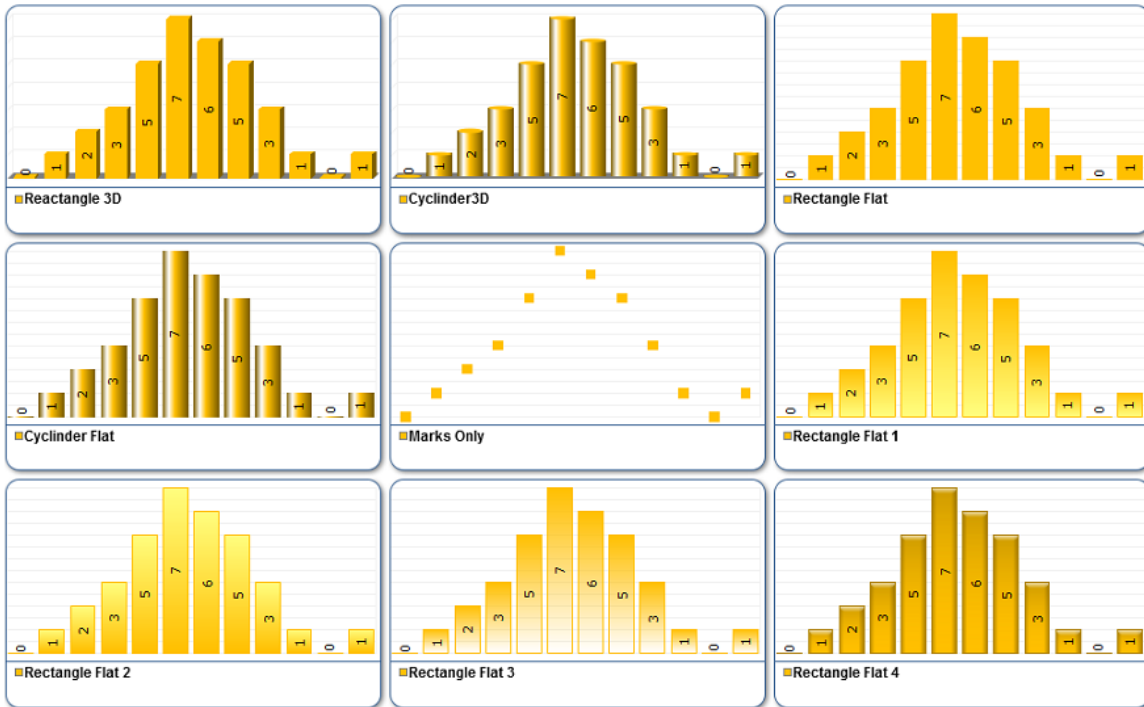



**NOTE:** If **Marks Only** bar representation type is selected, then in the **Bar Graph Definition** dialog window (below the "Color" section) a new combo box will appear (please see the picture below):

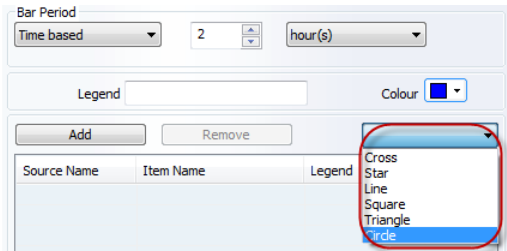

User will be able to select an option for the type of marks which will visualize the bar defined. There are 6 mark options available: **Cross**, **Star**, **Line**, **Square**, **Triangle** or **Circle**.

In the **Timestamp Format** combo box a user can configure the timestamp format to be displayed on the bar graph.

### Grid settings

By enabling the **Display Grid on Y Axis** edit box, a user can define if the grid will be shown on the Y Axis of the bar graph object.

Then, a user can define any of three available grid setting options for the bar graph:

- **Fine:** If this option will be selected, the grid will subdivide the bar graph object into small cells via fine-grid parameters. Values offered by default have been preset in such manner, that for most usual cases none of them needs to be adjusted.
- **Normal:** If this option will be selected, the grid will subdivide the bar graph object into small cells via normal-grid parameters. Values offered by default have been preset in such manner, that for most usual cases none of them needs to be adjusted.
- **Manual:** If this option will be selected, the grid will subdivide the bar graph object into small cells, which will have the Y-Axis value parameter (in mm) entered manually by the user.

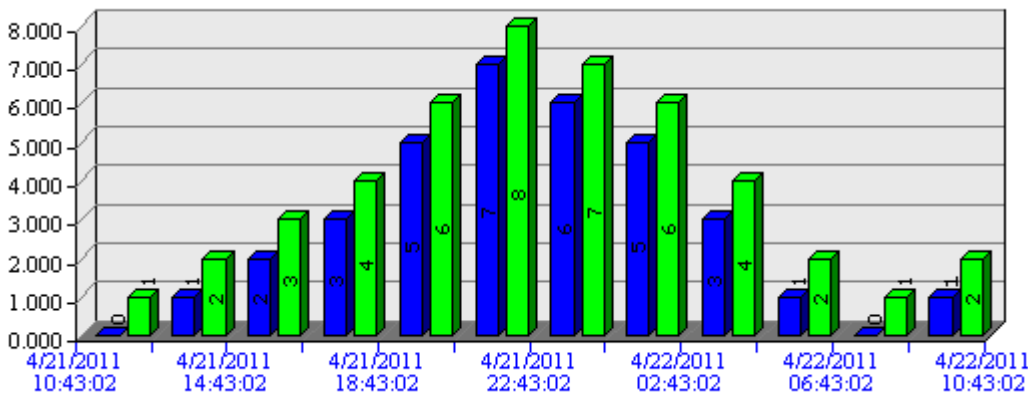



## Scale limit mode

User can define any of 3 available scale limit modes:

- **Automatic:** If this mode will be selected, the bar graph object will automatically detect minimum and maximum of all values, which have to be displayed in the bar line, and then set scale limits automatically according to that.
- **Automatic zero-based:** If this mode will be selected, the bar graph object will automatically detect maximum of all values, which have to be displayed in the bar line, and then set maximum scale limits automatically according to that. Minimum scale limit will be always zero.
- **Manual or item based:** If this mode will be selected, a user can manually enter a value for minimum and maximum limit for a scale. If you wish to use real-time tag values to set scale limits dynamically during report generation, you can double-click directly on a **From** or/and **To** edit box, and tag selection dialog window will be opened, where you will be able to select any available real-time data source and select any tag. Then, at the moment of report generation, the bar graph object will read the actual real-time value of that defined tag and use it to define limits of that scale.

The **Display Style** options define formatting for different bar properties:

- **Title** - when this radio button is selected, you can specify the font type and size for the chart title. Also you can select text alignment, font style, font color and background color for the title text. To use a transparent background color for the title, open the background color palette and select "No color". This option is only applicable when "**Display Name**" check box is enabled.
- **Legend** - when this radio button is selected, you can specify the font type and size for the legend. Also you can select the position of the legend - either on the bottom or on the right side of the chart. Also you can specify the font style, font color and background color for the legend. To use a transparent background for the legend, open the background color palette and select "No color". This option can only be applied when the "**Display Legend**" check box is enabled.

The **Advanced SQL Condition** section is described in details in the [Advanced SQL Condition section](#).



## Line Chart

**Line Chart** is an object that displays data in a chart.

To add a chart to a report, click the **Chart** button on the Report Designer Studio **Elements** toolbar:



Draw a rectangle where you would like to place the chart in the report workspace, and the **Chart definition** dialog box will be opened.

### Chart Definition

The **Get Data From** radio buttons specify the kind of data source for the chart.

The data source and data item can be selected from the relevant combo boxes in the **Select Data Item** group.

Select the desired data source and item, select the line color, line width and style, specify the line legend, if desired, and then click on the **Add Line** button. The line will be added to the chart.

**Apply correction factor for all item values** enables adding simple expression to a chart. If a user needs to display a chart on item(s) with the correction factor, then, first, all values of the selected item(s) will be re-calculated, applying correction factor, and then, the chart will display re-calculated data.

For more details, please refer to the [Correction Factor](#) section.

**ADF to be used:** enables to select an aggregated data filter. "ADF to be used" combo box will contain all ADF definitions, configured in the project. The default string will be **"Not Used"**, i.e. no filter (ADF) is applied.

For details on ADF definition/configuration, please go to the Aggregated Data Filter section of this manual.





**Process Value** section enables to select a statistical function for the chart object and has 6 available options:

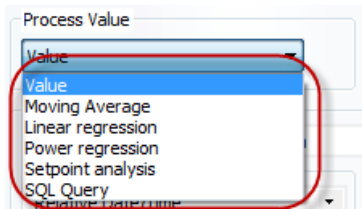

**Value** will display a chart object according to the report item values selected.

**Moving Average** will display a chart object as an analyzed set of data items having created a series of averages of different values of a defined data value set. When you select **Moving Average** function in the **Process Value** section, an additional data box will appear:



You can enter a predefined number of values previous to the current one in this box. They will be taken for the calculation of the series of averages of the predefined data value set including the current one.

**NOTE:** If you leave the mentioned data box blank, the calculation will take the full data set in the defined period of time.

**Linear Regression** will display a chart object as a linear model, where data items are modeled using linear functions, and their model parameters are estimated from the data values set.

**Power Regression** will display in curved lines in a chart object the data sets, which compare measurements that change at a specific rate. The mathematical algorithm will analyze entered values in order to define "a" and "b" coefficients, so that when the curved line (matching the appropriate power regression function  $y = a \cdot x^b$ ) will be added, this line will display item values with the highest level of data approximation.

If a user selects the statistical function **Setpoint Analysis**, then the button "..." will appear next to the combo box with the statistical function, which a user has to click and select setpoints that he would like to analyze and display on the chart. Then, in the same window of the setpoint selection, user has to select which data items should be displayed on a chart. There are the following options available:

**All items.** The chart will display all items, defined for the selected setpoint.

**Fastest entry item.** The chart will display only one item of those, defined in the selected setpoint, which was the first to enter the stability zone of the setpoint.

**Slowest entry item.** The chart will display only one item of those, defined in the selected setpoint, which was the last to enter the stability zone of the setpoint.

**Fastest exit item.** The chart will display only one item of those, defined in the selected setpoint, which was the first to exit from the stability zone of the setpoint

**Slowest exit item.** The chart will display only one item of those, defined in the selected setpoint, which was the first to exit from the stability zone of the setpoint.

**Selected Tag.** The chart will display the result of the calculations of the selected item/tag, which has entered and left the stability period.

When displaying the setpoint analysis, the chart will display a dash line to display a setpoint value and two horizontal dash lines to display min and max of tolerance. Stability zones will be marked with two small triangles and also put two vertical dash lines, which will help to detect start and stop of the stability zone.



**SQL Query** will enable users to execute SQL query or stored procedure and display the result of that query in a chart. To define the SQL query, user will have to click on the "..." (browse) button next to the SQL Query option (please see the picture below):

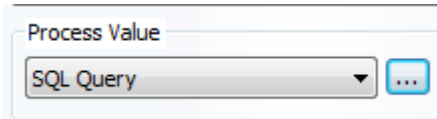

The standard "SQL Query Definition" window will be opened. Its configuration will be the same as the standard SQL Query definition in Single Data Objects (for details, please refer to the "Direct SQL Query" section of the Single Data Object Definition configuration window).

**NOTE:** SQL query in charts can return one of 2 types of data sets:

1. Timestamp and Values (one or multiple columns);
2. Values only (one or multiple columns)

The **Manual Data Entry** section supports entering a static numeric value that will be constant during report generation. This allows users to create a chart combining statistical data and static reference data.

In order to add manual data, click on **Add** button, enter the **value/timestamp** data for the selected item in the **Manual Data Entry** browse window that will be opened. If a user wants to change the data that have been entered manually, he will only have to click on **Edit** button, and make any changes in the data item selected.

Then, select the desired color for the corresponding line, enter a label for the legend, if needed, and click the **Add** button.

A line may have 3 possible **styles**, which can be selected from the combo box:

- **Line with mark** (default)
- **Line**
- **Marks only**

Styles are specified globally for all lines of a chart and cannot be assigned to individual lines.

**Time Definition** defines the time period for statistical calculations for this object and is described in detail in the **Time Definition** section of this manual.

Time period definition can be defined for each line separately, i.e. each line may have its own time period, which may be different from periods of other lines.

The period can be time-based or **Batch-based**. This is described in detail in the Batch Definition section

**X Axis settings** section allows you to configure settings for X scale.

Upper combo box in this section offers two modes for X scale display: **Date and Time** and **Data Item** modes.

- If **Data Item** mode is selected, then this section will display data item selection control, which enables you to select a data item, which will be assigned to X scale. In this case, Dream Report will display X/Y chart, and display a line, based on the correlated points between values of an item, defined for X scale, and values of an item, defined for Y scale. You can also assign string type data to X scale. In this case, Dream Report will display X/Y chart with a line, based on the correlated points between string values of an item, defined for X scale, and values of an item, defined for Y scale.
- If **Date and Time** option is selected, then X scale will display a timestamp. User will be able to select a timestamp format from a combo box.



Check box **Show absolute time on X axis** enables displaying timestamp in absolute format (e.g. 'April 29, 2008 07:28:00')

Check box **Show relative time on Y axis** enables displaying timestamp in relative format (e.g. 00:00 ; 00:10 ; 00:20 etc.) - it will display amount of hours, minutes, seconds from the starting point of the time of that line. Time format will be automatically set, depending on the time value, which has to be displayed (e.g if timestamp doesn't contain hours, then only minutes and seconds will be displayed).

If both check boxes are checked, then two X-scales will be displayed, showing both absolute and relative time.

**Enable scale X/ Enable scale Y** check boxes allow to display on the X/Y axis of the chart data items configured.

User can select items to be displayed on the X/Y axis in the **Attach X axis to/ Attach Y axis to** combo boxes.

### Line Chart Appearance

If a user clicks on the **Appearance** bar, the **Chart Appearance** configuration tab will be opened:

The **Display Options** section contains the list of check boxes, which display/hide chart appearance elements.

The **Chart window option** combo box offers 2 user modes of drawing a chart window during run-time:

- **Fit to time period** option will force a chart to display full time period, which is defined for that line. If the chart is defined for a long time period and data for its data item exists only for a smaller period, then, the full time period will be displayed anyway.
- **Fit to data** option will draw a chart window only for a period of time, when values for its data item exist. If the chart window is configured for 1 week and during report generation, its data item has values only during 1 day, then, the chart window will automatically be drawn for 1 day only. This option is very useful to display charts on batches.

The screenshot shows the 'Chart' configuration window with the 'Appearance' tab selected. On the left, a table lists data items: 'Batch\_Data.Tank1', 'Batch\_Data.Motor1', and 'Batch\_Data.Temp1'. The 'Display Options' section has several checked boxes: 'Display Name', 'Display Legend', 'Display Values on Y Axis', 'Display Timestamp on X Axis', 'Display Grid on X Axis', and 'Display Grid on Y Axis'. The 'Chart window option' is set to 'Fit to time period'. The 'Chart type' is 'Value Based'. The 'Chart Orientation' is 'X Axis bottom, right orientation;'. The 'Display Style' section has 'Title' selected with 'Arial (European)' font and size '10'. The 'Chart Area Properties' section has 'Zebra' fill type and two color pickers.



## Ocean Data Systems

The **Chart type** combo box offers 3 modes of drawing a chart line:

- **Value based** mode will draw a regular chart line, which connects all value points, as shown below:

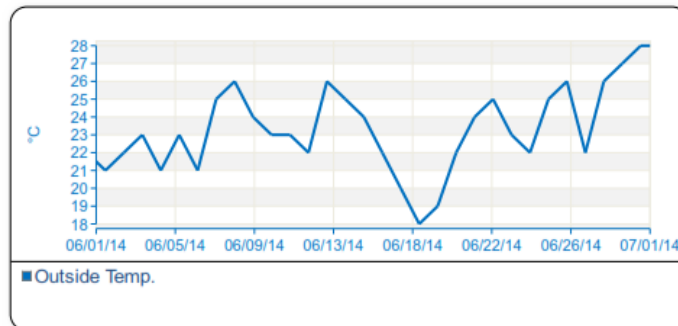

- **Time based** mode will draw a horizontal line of a value until the time point, when the value is changed. This line type is usually used to display line chart for binary values (chart of run time of a motor or valve state, etc.) or analog setpoint changes, as shown below:

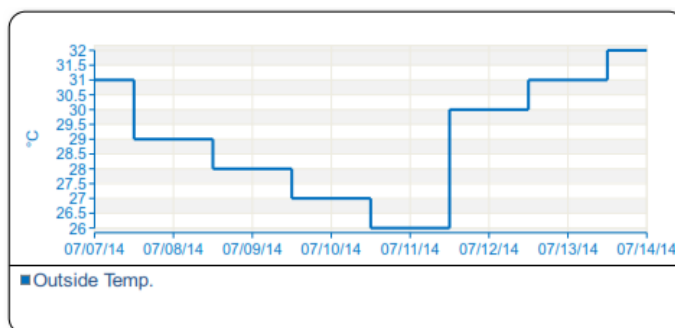

- **Spline value based** mode will draw a spline chart line, which connects all value points applying spline interpolation, as shown below:

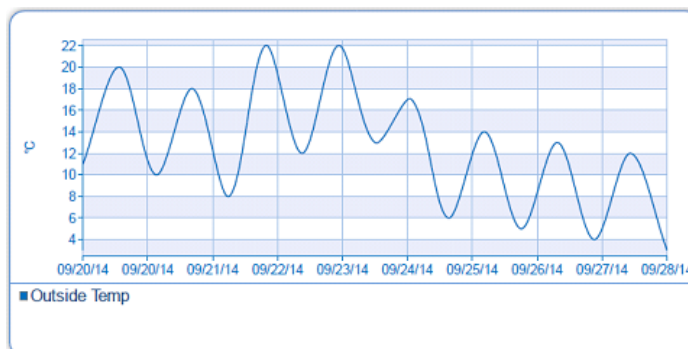

The **Deviation section** enables a user to filter all item values and draw a line only on key values, optimizing a chart line and avoiding numerous minor value changes.

**Deviation in %** will analyze array of item values and each next value will be ignored if its difference is less % from value of previous valid point, than defined % of deviation.



### Chart Orientation

Dream Report 4.7 introduced a **Chart Orientation** option, which allows for the X-axis to be shown on the left or right side of the chart (instead of along the bottom). This is useful when you need to configure a “long chart” (possibly even spanning multiple pages) and orient the X-axis vertically.

The following examples illustrate the various **Chart Orientation** options:

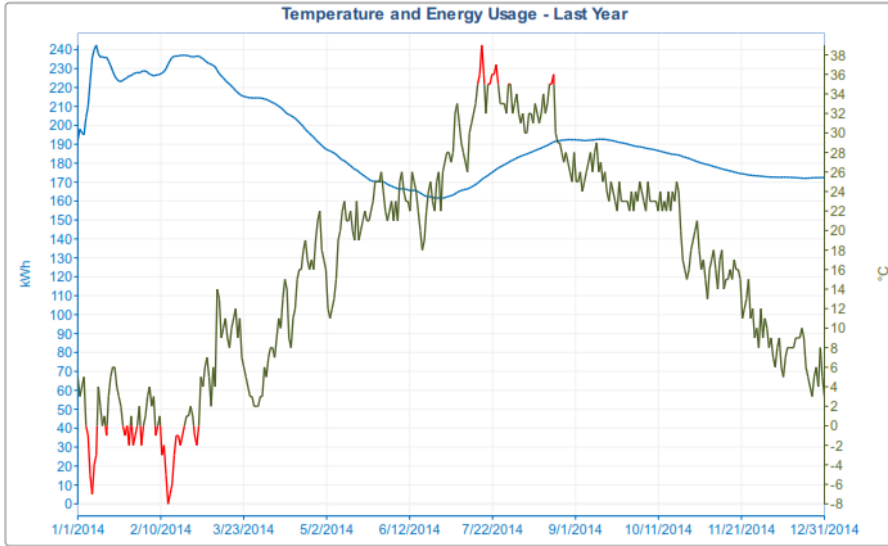

X Axis bottom, right orientation;  
Y Axis left, up orientation

(this is the default layout)

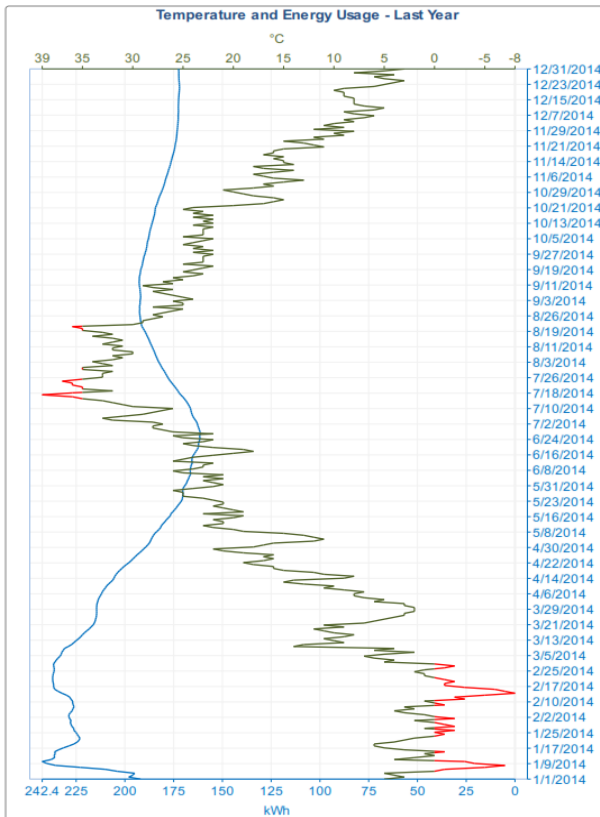

X Axis right, up orientation;  
Y Axis bottom, left orientation

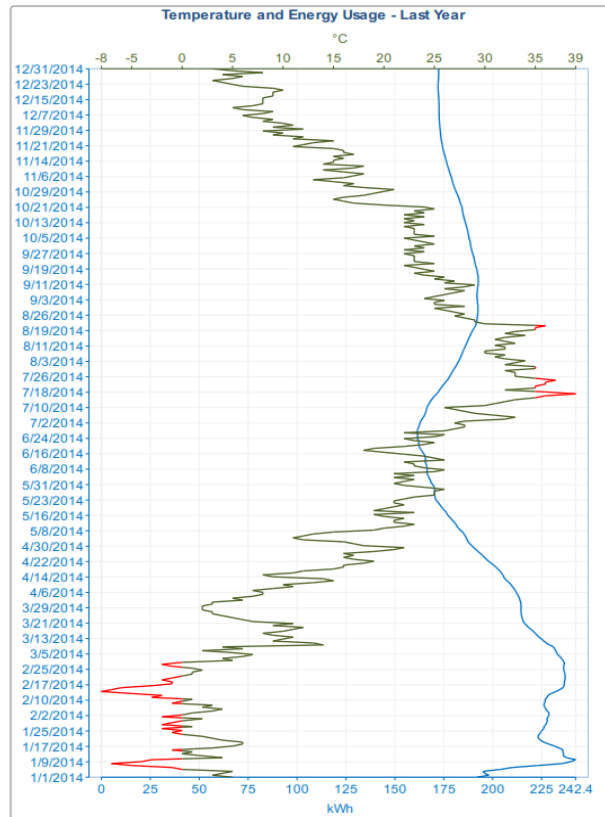

X Axis left, up orientation;  
Y Axis bottom, right orientation

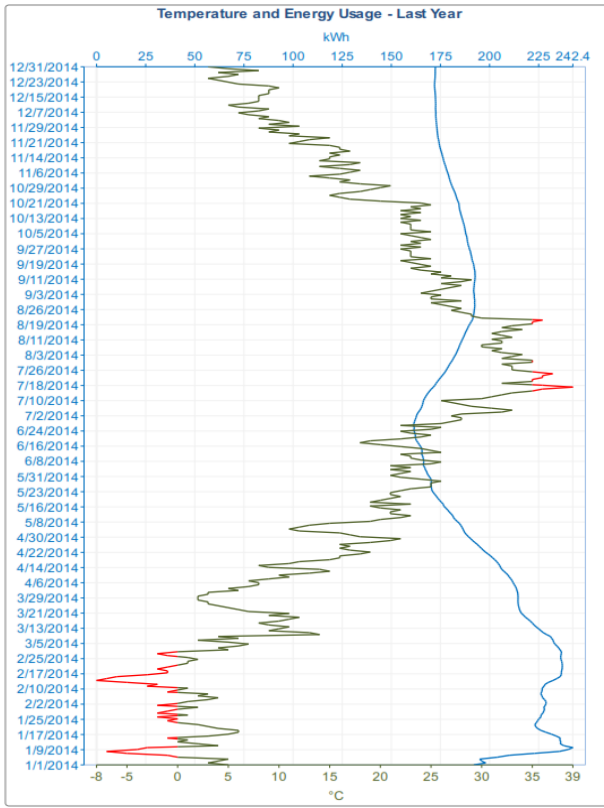

X Axis left, up orientation;  
Y Axis top, right orientation

It is possible to have the “long” chart span multiple pages by creating a Pivot Group on the chart object -e.g., show the chart for the last 1 month, with each page showing 1 week’s data.

## Grid settings

User can define any of 4 available grid setting options for the chart object:

- **Fine:** If this option is selected, the grid will subdivide the chart object into small cells via fine-grid parameters. Values offered by default have been preset in such manner, that for most usual cases none of them needs to be adjusted.
- **Normal:** If this option is selected, the grid will subdivide the chart object into small cells via normal-grid parameters. Values offered by default have been preset in such manner, that for most usual cases none of them needs to be adjusted.
- **Manual:** If this option is selected, the grid will subdivide the chart object into small cells, which will have the X /Y Axis value parameters entered manually by the user.
- **Aligned to value:** If this option is selected, the grid will subdivide the chart object into small cells, which will have the X/Y Axis value parameters entered manually by the user and adjusted according to the values set.

## Scale limit mode

User can define any of 4 available scale limit modes:

- **Automatic:** If this mode is selected, chart object will automatically detect minimum and maximum of all values, which have to be displayed in the chart line and then set scale limits automatically according to that.
- **Automatic zero-based:** If this mode is selected, chart object will automatically detect maximum of all values, which have to be displayed in the chart line and then set maximum scale limits automatically according to that. Minimum scale limit will be always zero.



## Ocean Data Systems

- **Auto-centered:** If this mode is selected, chart object will automatically detect minimum and maximum of all values, which have to be displayed in the chart line, and then will automatically center scale limits.
- **Manual or item based:** If this mode is selected, user can manually enter a value for minimum and maximum limit for a scale. If you wish to use real-time tag values to set scale limits dynamically during report generation, you can double-click directly on a From or/and To edit box and tag selection dialog window will be opened, where you can select any available real-time data source and select any tag. Then, at the moment of report generation, chart object will read the actual real-time value of that defined tag and use it to define limits of that scale.

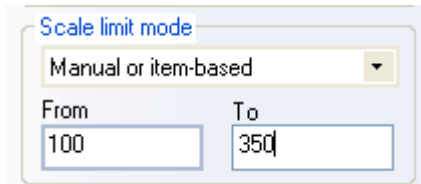

Scale limit mode

Manual or item-based

From: 100 To: 350

All scale limits are set separately for each line, so, in order to change a scale limit for any specific line, a user has to select that line in the list and then edit its scale definition.

### Advanced Visualization

If a user clicks on the **Advanced options** button, the **Advanced visualization** dialog box will be opened:

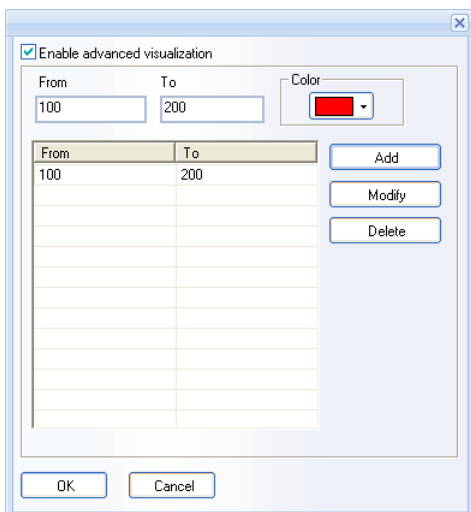

Enable advanced visualization

From: 100 To: 200 Color: █

From	To
100	200

Add  
Modify  
Delete

OK Cancel

Here a user can enter one or several value ranges and corresponding colors. Then, when displaying a line in a chart, if a line value will be in a range, defined in the advanced visualization, then, the line will change a color to the one, defined for that value range in the **Advanced Visualization** section. As soon as the line value exits from that range, it will change its color back to the original one.

User can define one or multiple value range definitions.

### Using tags to define limit range for Advanced Visualization

Values for advanced visualization can be taken dynamically from the real-time tag values. To do so, select tag names, instead of values, for **From** or/and **To** edit boxes. If you double-click on **From** or **To** edit box, the tag selection dialog box will be opened, enabling selection of a tag from any real-time data source.





## Ocean Data Systems

When generating report, the chart object will read the real-time value of the selected tag and then use this value to define limit range for advanced visualization.

The **Display Style** section enables formatting of the chart's **Title** and **Legend**. Formatting options include font styles, text alignments, text and background colors and Legend placement (below or to the right of the chart area.)

The **Chart Area Properties** section enables formatting of the chart's plot area "background" - the **Chart Area Fill Type**. Fill Type options include:

- **Solid**
- **Zebra**
- **Vertical Gradient**
- **Horizontal Gradient**
- **Diagonal Gradient LT to RB** (Left Top to Right Bottom)
- **Diagonal Gradient LB to RT** (Left Bottom to Right Top)

Once a Chart Area Fill Type has been selected, make the appropriate color selection(s) to be associated with the fill type.

## Web Report Options

If the report's format is set to "Web Report", additional interactive options are available on the Line Chart at runtime:

- **Chart Web Interactive** If checked, at runtime (on the web report) a user can dynamically show or hide pens (tags), use the mouse-wheel to zoom in/out on the chart, and hover over a point on the chart to display the tagname, timestamp, and the value at that point

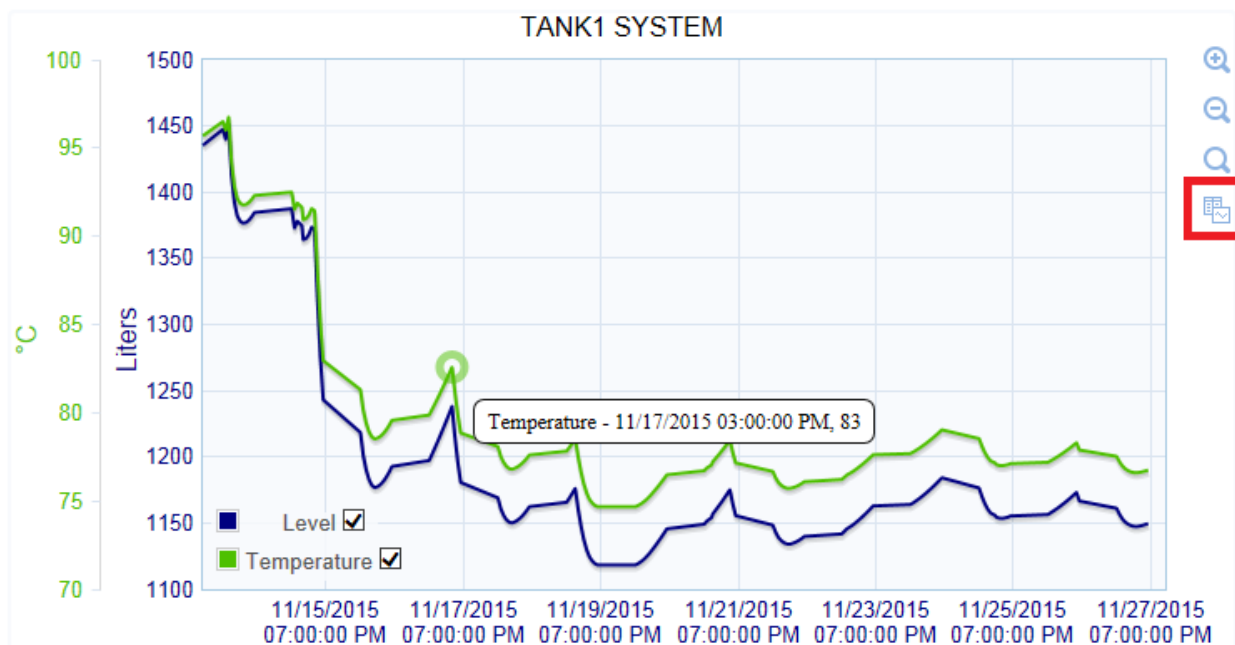





## Ocean Data Systems

- **Web Chart - Show Raw Data** If checked, the user can click on the "Raw Data" icon on the web interactive chart (highlighted in the red block above) and a pop-up window will appear over the chart. The user can select which of the tags' raw data they want to review, by selecting the tag(s) from the drop-down list, and then closing the drop-down list - the raw data will be displayed. The raw data can also be saved to a CSV file for further off-line analysis by clicking the "CSV" button:

Timestamp	Batch_Data Batch_Data:Tank1	Batch_Data Batch_Data:Temp1
11/13/2015 06:00:00 PM	1425.00	95.00
11/14/2015 07:00:00 AM	1447.50	96.50
11/14/2015 08:00:00 AM	1440.00	96.00
11/14/2015 09:00:00 AM	1451.25	96.75
11/14/2015 10:00:00 AM	1413.00	94.20
11/14/2015	1392.50	92.82

2 selected

Batch\_Data:Tank1

Batch\_Data:Temp1

CSV Close

The [Advanced SQL Condition](#) section is described in details in the [Advanced SQL Condition](#) section. Please note that if an Advanced SQL Condition is defined, the filter condition will apply to all the lines on the chart.



## Indicator

**Indicator object** is an object that displays calculated data in the new standard representation way according to the latest energy reporting standards (eg. Energy Performance Charts (EPCs)).

An indicator object will calculate the value according to the defined function or calculation, grade the result according to the preset grade of value ranges, and display the result with the grade mark.

To add an indicator object to a report, click on the **Indicator** button on the Report Designer studio Elements toolbar:



As soon as user clicks on the button and marks the area on the report workspace, the **Indicator Object Definition** dialog window will be opened.

The **Indicator Object Definition** dialog window consists of 2 parts: **Data Definition** and **Appearance**.

### Data Definition

The **Data Definition** dialog enables users to create one or several indicator definitions and display results accordingly.

Every indicator object can have (but not necessary) a name. If a user wants, he can type a name in the **Object name** edit box, and this name can be then displayed on top of the object.

To the left of the **Object name** edit box, there is a list with defined indicators. As soon as a user creates a new indicator definition, he will click on **Add** button, and the definition will be added.

Every indicator definition has a logical name and will be added to the list by its name.

Any indicator definition can be deleted by clicking on **Delete** button.

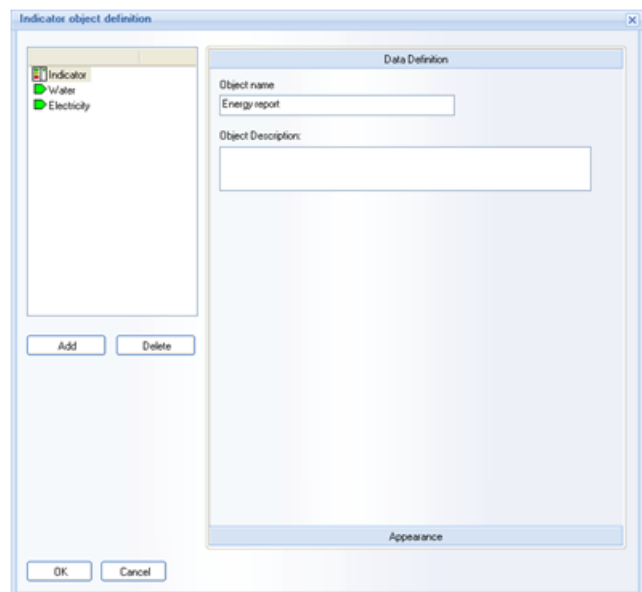



## Create a new indicator

To create a new indicator, a user has to enter a logical name for this indicator, and then to select its type from the list of the defined indicators. The following dialog window will be opened:

The **Pointer Type** combo box will have 4 values: 3 pre-configured types and the custom one. This combo box will have the following selection: **Energy indicator**, **Eco (CO2) indicator**, **Water indicator**, **Custom indicator**.

When a user has selected the required indicator type, he can then configure it. The preset indicator types and the custom one will have different configuration dialog boxes (*please see the corresponding sections below*).

### Energy/Eco/Water indicators configuration

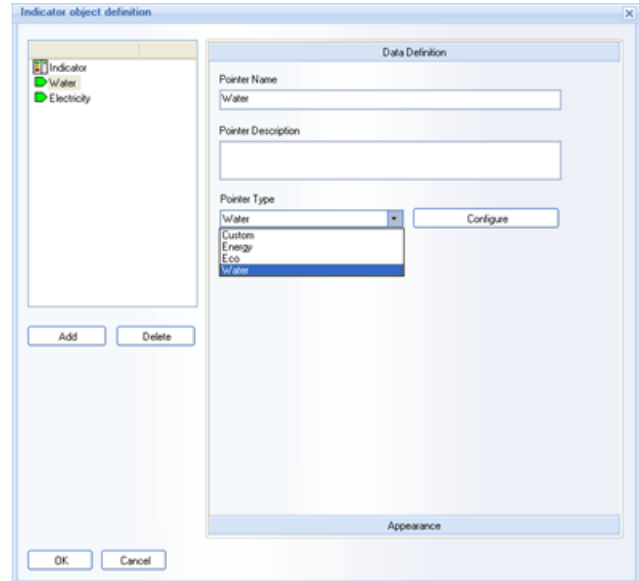

**Energy Indicator** will display how much energy was spent per m2 per year. Therefore, to calculate this indice, select an existing statistical object for energy consumption, select a time period, which is referenced to that object and has a possibility to enter the area (in m2 or /ft2). The selected statistical object value will be divided by area and then interpolated for 1 year according to the associated period (e.g. if the associated period is 1 year, the result will be multiplied by 12).

**Eco Indicator.** This indicator will display how much CO2 was emitted per m2 per year. Therefore, to calculate this indice, select an existing statistical object, which calculates CO2 emission, select a time period, which is referenced to that object and has a possibility to enter the area (in m2 or /ft2). The selected statistical object value will be divided by area and then interpolated for 1 year according to the associated period (e.g. if the associated period is 1 year, the result will be multiplied by 12).

**Water Indicator.** This indicator will display how much water was spent per m2 for per 1 year. Therefore, to calculate this indice, select an existing statistical object for water consumption, select a time period, which is referenced to that object and has a possibility to enter the area (in m2 or /ft2). The selected statistical object value will be divided by area and then interpolated for 1 year according to the associated period (e.g. if the associated period is 1 year, the result will be multiplied by 12).

User can configure any of those preset types (**Energy Indicator/ Eco Indicator/ Water Indicator**) in the **Configuration** dialog window, which will appear after clicking on **Configure** button, next to the **Pointer Type** combo box:

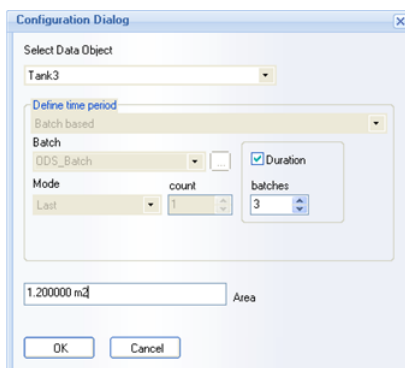



The **Select Data Object** combo box in this dialog box will contain the list of **Single Data Objects**, **Compound** and **Expression objects**, already existing in that report. As soon as any one of the existing objects has been selected, the **Time Period Definition** combo box will appear, showing the original time period settings of the data object selected. This time definition will be taken for the indicator. Then, define the area, which the selected object may enter during the defined time period, click **OK**, and the configuration of this type of indicator (**Eco/Water/Energy**) will be finished.

### Custom Indicator Configuration

**Custom Indicator.** This indicator will display how much energy was spent to heat/cool 1 m2 for 1C degree. Therefore, to calculate this indice, select a tag for energy consumption, select a tag for a temperature, that has a possibility to enter an area (m2). As soon as a user selects this type, the following dialog window will appear:

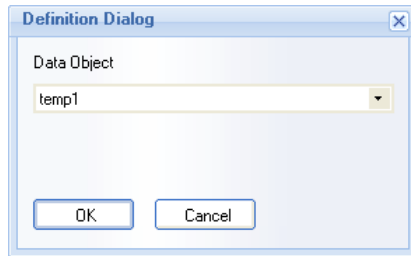

The combo box in this dialog box will contain the list of **Single Data Objects**, **Compound** and **Expression objects**, already existing in that report. Select one of the existing objects and its result will be taken for the indicator.

### Appearance

If a user will click on the **Appearance** float bar, the following **Appearance** dialog window will be opened:

All **Appearance** configuration is saved separately per each indicator definition.

Grade definition is done in the "**Grade definition**" section.

User will add limits (**High – Low**), define grade color and add segment to the list. By default all added grades will get alphabetic enumerated Grade letter: A, B, C, D, ...

If a user wishes to replace letter label by another one, he can double-click in the list control and edit the grade label (e.g. like it works in item or alarm table for table column caption).

If a user wants the name of the indicator to appear on the picture, he will have to enable the **Show object name** box.

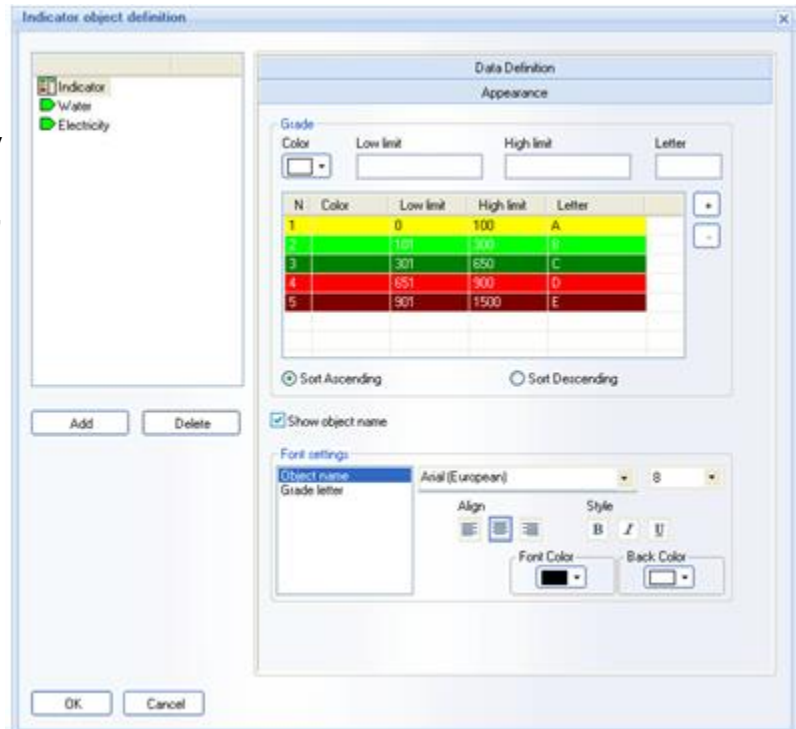

User can also define typeface for the defined objects in the **Font settings** part of the **Grade definition** dialog window.

**NOTE:** **Grade definition** dialog window will appear if Indicator object on the **defined indicators tree** is selected.



The grades and the indicators defined will be displayed as on the picture below:

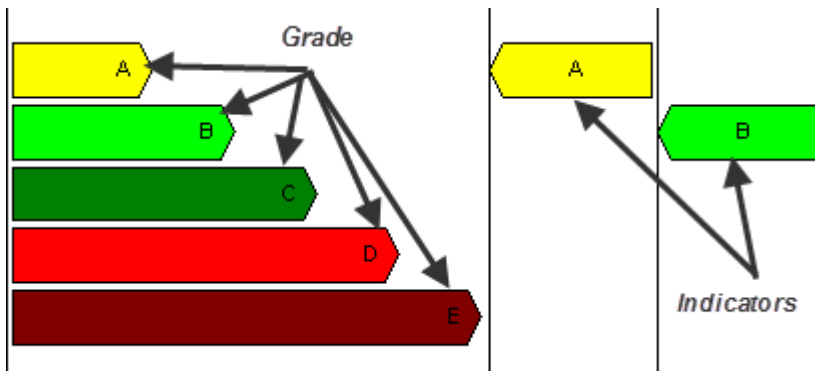

If a user will select one of the indicators from the list, then, the following dialog window will be opened:

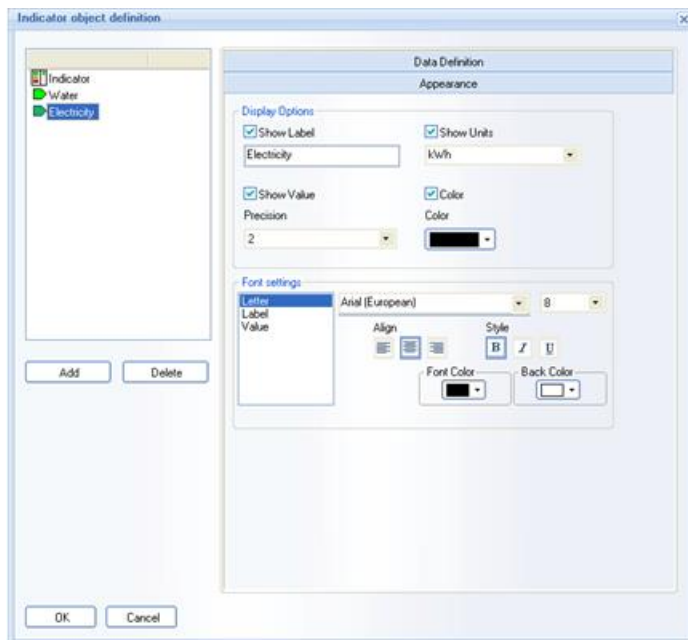

In the **Display Options** section a user can enable displaying labels, units, values and the color for each indicator selected from the list.

The typeface for each indicator object selected can be defined in the **Font Settings** section of the **Appearance** dialog window.

Click **OK**, and the picture of the result indicator object will appear as displayed on the picture below:

Energy report	Water m3	Electricity kWh
A	A	
B		B
C		
D		
E		



## Ocean Data Systems

This picture is an example of the *Indicator Object*, where **Energy report** is the **object name**; **Water**, **Electricity** are **pointer names**; **m3**, **kWh** are **pointer units** (with enabled display); **A**, **B** indicators on the right correspond to each of the **pointers** defined in the *Appearance* dialog box; **A,B,C,D,E** grades on the left correspond to the indicator appearance



# Dynamic Interactive Objects

## Timestamp Picker

**Timestamp Picker** is a dynamic interactive object, which enables users to select timestamp for association with the entered values, and is available ONLY in WEB reports (please also see [Manual Data Entry](#) section).

To add this object, click on the command button *Timestamp Picker* on the *Web Elements* ribbon icon on the horizontal toolbar in the Dream Report Designer Studio menu (see pic. below):

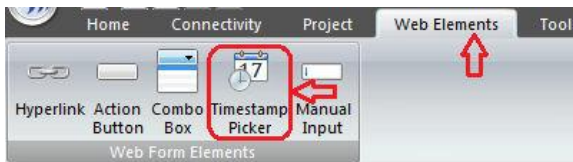

Draw a rectangle in the workspace where the output data will be displayed.

The following **Timestamp Picker Configuration** dialog box will be opened:

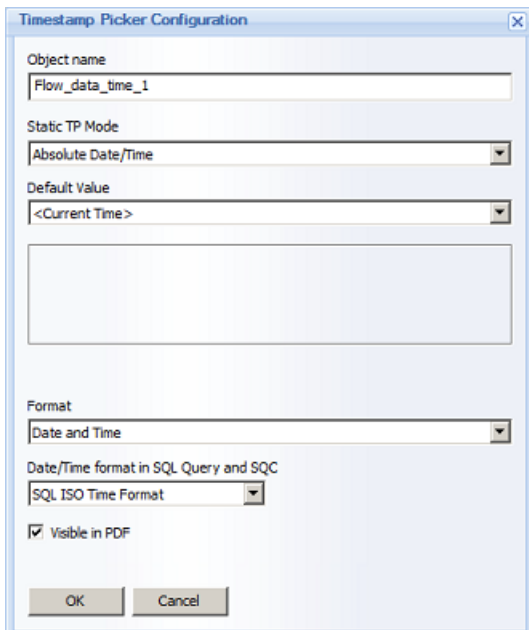

**Object Name** must be a unique logical name, which will be used for each Timestamp Picker object in order to be able to reference any of those specific date/time objects in the data entry objects.

**Default Value** allows users to configure which timestamp value this object will display as a default. The **Default Value** combo box has the list of all Timestamp Picker objects and simple statistical objects (Single Data Objects, Compound and Expression Objects), already defined in that report, so that the user can select one object to control default values in others. Also the **Default value** combo box has an entry "**Current time**", so every Timestamp Picker object will always display current time by default. This entry will be displayed by default when a user will add a new object to the report.

**Format** enables users to select specific format of date and time for each Timestamp Picker. This combo box has 3 options available: "**Date and time**", "**Date**" and "**Time**".



## Ocean Data Systems

The “**Visible in PDF**” option controls whether this Timestamp Picker object will be displayed in the generated PDF report or not. If this object is defined as invisible, then it will be initialized with its default value and then all data input objects that will be based on that object, will get its default value.

The “**The Date/Time format in SQL Query and SQC**” option allows the user to set the date/time format that may be required by a SQL query or SQC condition. At report generation time, the user-selected date/time value in the Timestamp Picker will be converted to the format specified in this option. Options available are:

- “**SQL ISO Time Format**” (default)
- “**Seconds from 01/01/1970**”
- “**Custom Time Format**” (user specified format)

**Example** of the Timestamp Picker object in the runtime mode:





## Hyperlink

**Hyperlink** is a dynamic interactive object, which enables users to add a text and turn it into a hyperlink, and is available ONLY in WEB reports (please also see [Manual Data Entry](#) section)

To add this object, click on the command button *Hyperlink* on the *Web Elements* ribbon icon on the horizontal toolbar in the Dream Report Designer Studio menu (see pic. below):



The following **Hyperlink Configuration** dialog box will be opened:

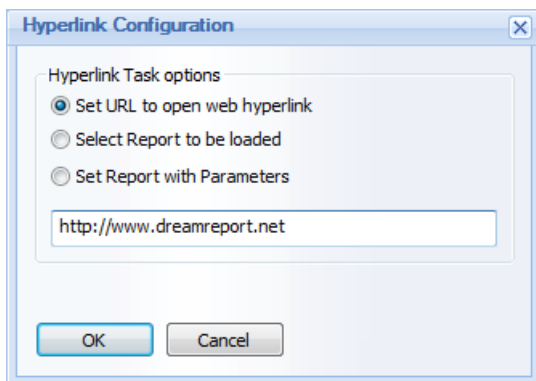

If “**Set URL to open web hyperlink**” option is selected, user **MUST ENTER A WEB PAGE ADDRESS (http://)**, and then, after clicking on that hyperlink, a new web page will be opened, navigated to a specified hyperlink (please see the pic. above).

If “**Select Report to be loaded**” option is selected, the dialog will display a combo box with the list of all reports, available for that user, and he/she will be able to select which report will be opened upon clicking on that hyperlink (please see the pic. below):

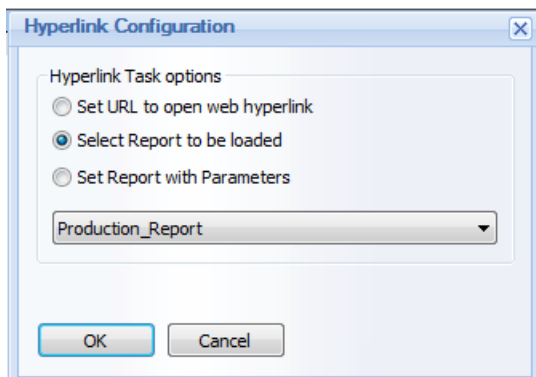



If “**Set Report with Parameters**” option is selected, user will have to click on the *Configure* button in order to enable internal hyperlink for the project report (please see the pic. below):

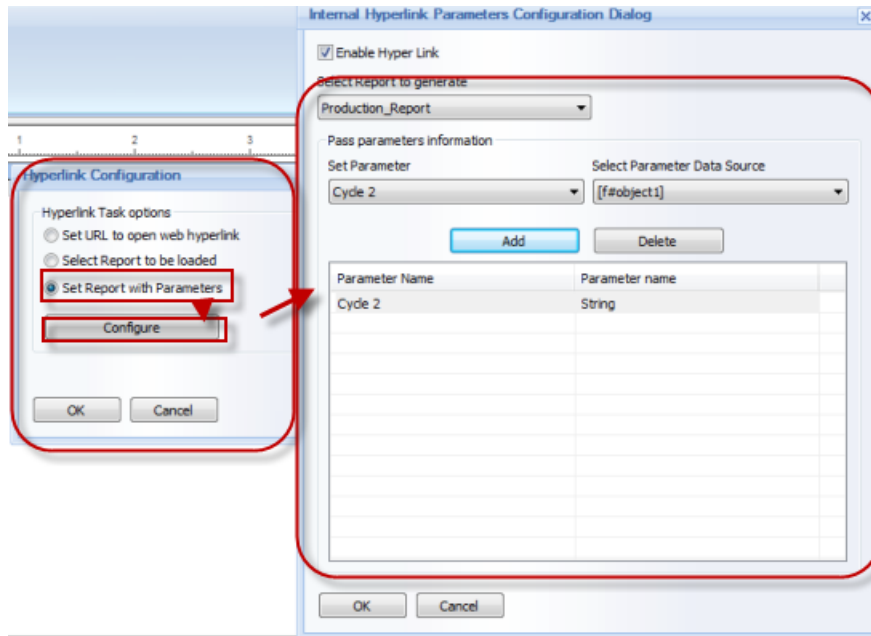

By default this option will be disabled.

In the “**Enable Hyperlink**” check box user can enable/disable object as internal hyperlink

Combo box “**Select Report to generate**” will be filled with the list of all project reports including current report.

Combo box “**Set Parameter**” will be filled with the list of all available defined internal project parameters (IPPs).

Combo box “**Select Parameter Data Source**” will be filled with the list of all relevant objects defined in that report (i.e. with the following object types: Single Data Objects, Compound Data Objects, Expression Data Objects, Combo boxes, Date/Time pickers).

When user will click on “*Add*” button, the selected parameter with the selected corresponding object will be added to the list.

**NOTES:**

- The list of parameters can't have the same parameter defined twice. However, it may have the same report object defined several times for multiple parameters.
- Report parameters using hyperlinks will work only for web report formats in Dream Report Web Portal. Only WEB report formats (Report Output File) will be generated using hyperlinks. PDF and Excel report formats will not be generated using hyperlinks.

For details on internal project parameters (IPP) configuration, please refer to the Project Parameters section of this manual.



### Text Object Hyperlink Definition

If a text object is defined as a hyperlink, its caption is not linked to the object's hyperlink configuration. So, if a user will change the text, it will have no influence on a hyperlink definition. To edit hyperlink, user will have to select that text object and click on the **Hyperlink** button or select **Hyperlink** from the right-click context menu (please see the pic. below):

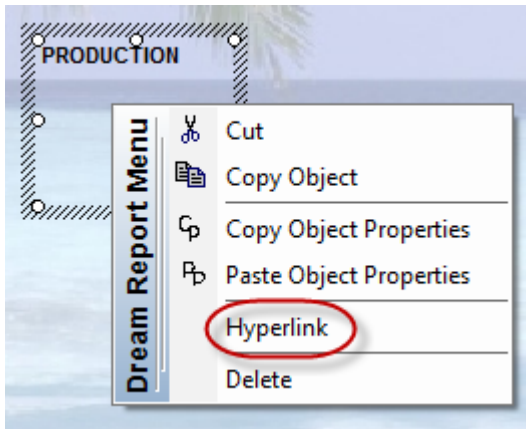

To remove hyperlink from the text object, select **Delete** from the right-click Dream Report context menu.

Dream Report Context (right-click) Menu for the text object has 6 entries: **Cut**, **Copy Object**, **Copy Object Properties**, **Paste Object Properties**, **Hyperlink**, **Delete**.



## Combo Box

**Combo Box** is a dynamic interactive object, which enables users to select values from a predefined list, and is available ONLY in WEB reports (please also see [Manual Data Entry](#) section)

The **Combo box** object will be visible only in web reports and will not be displayed in PDF/Excel reports.

To add this object, click on the command button *Combo Box* on the *Web Elements* ribbon icon on the horizontal toolbar in the Dream Report Designer Studio menu (see pic. below):

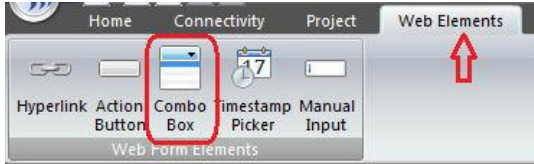

Draw a rectangle in the workspace where the output data will be displayed. The following **Combo Box Configuration** dialog box will be opened:

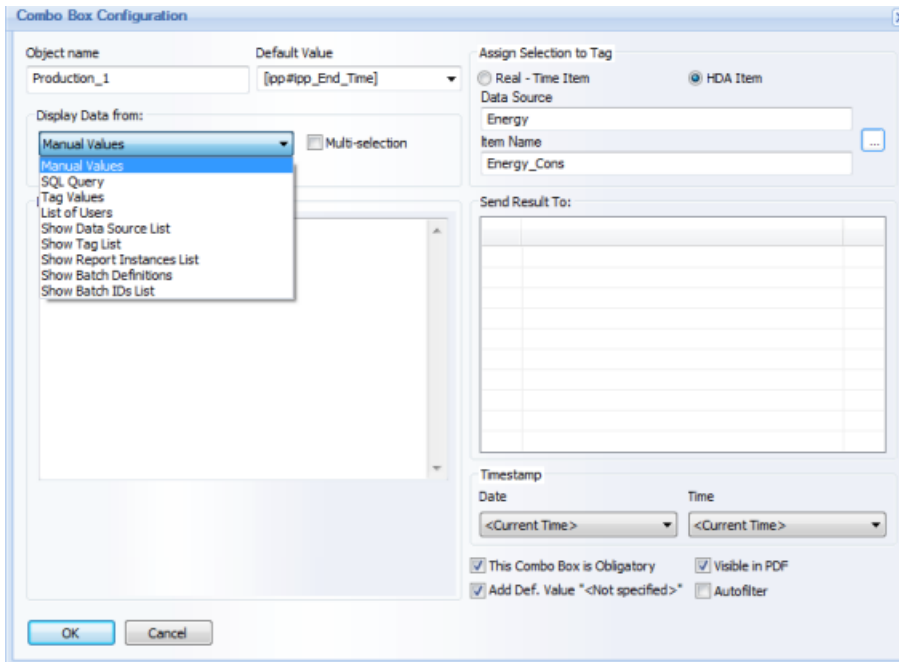

**Object Name** must be a unique logical name, which will be used in further work with that object within the project.

**Default Value** enables to set value which will be displayed as default in the Combo Box object in WEB reports in Dream Report Web Portal.

### Data Display Configuration

The **Display Data from:** combo box has 9 source types of data to display: **Manual values**, **SQL query**, **Tag values**, **List of users**, **Show Data Source List**, **Show Tag List**, **Show Report Instances List**, **Show Batch Definitions** and **Show Batch IDs List**.

- **Manual values** data display. In the **Data Configuration** section user has to specify manually a set of values (text or numeric), separated by comma or (“,”) or semi-column (“;”) (please see the pic. below):



## Ocean Data Systems

Combo Box Configuration

Object name: Production\_1      Default Value: [jpp#pp\_End\_Time]

Display Data from: Manual Values       Multi-selection

Data Configuration: Tank2, Tank3, Tank4

Assign Selection to Tag:  Real - Time Item       HDA Item

Data Source: Energy

Item Name: Energy\_Cons

Send Result To:

Timestamp: Date: <Current Time>      Time: <Current Time>

This Combo Box is Obligatory       Visible in PDF

Add Def. Value \*<Not specified>\*       Autofilter

OK      Cancel

**Combo Box Object** will display entered values in the same order as they have been entered in the **Combo Box Configuration** dialog box, without doing any sorting.

- **SQL Query** data display. In the **Data Configuration** section user has to **select the DSN** (see explanations below), and specify the **SQL Query**, which will be launched at the report start and the query result will be displayed in the combo box (please see the pic. below):

Combo Box Configuration

Object name: Production\_1      Default Value: [jpp#pp\_End\_Time]

Display Data from: SQL Query       Multi-selection

Data Configuration: Select DSN: Process

SQL Query: SELECT Tank1, Tank2, Tank3 FROM Table 1

Assign Selection to Tag:  Real - Time Item       HDA Item

Data Source: Energy

Item Name: Energy\_Cons

Send Result To:

Timestamp: Date: <Current Time>      Time: <Current Time>

This Combo Box is Obligatory       Visible in PDF

Add Def. Value \*<Not specified>\*       Autofilter

OK      Cancel

By default the **Select DSN** combo box will be empty. If any DSNs have already been configured in the Project DSN Manager, then user will be able to select one of the DSNs from that list. If no DSNs have been configured yet, or, if user needs to configure a specific DSN, he will have to click on the "..." (browse) button in the **Select DSN** combo box and the **Project DSNs Configuration** dialog window will be opened.

For details on how to configure DSN, please go to the **DSN Manager** section of this manual.



## Ocean Data Systems

- **Tag values** display. In the **Data Configuration** section user has to select the tag and then, when initializing the report, Dream Report will read all available values of a selected tag for the defined time period from the database and display those values in the combo box:

The screenshot shows the 'Combo Box Configuration' dialog box. It has a title bar with 'Combo Box Configuration' and a close button. The main area is divided into several sections:

- Object name:** Production\_1
- Default Value:** [pp#pp\_End\_Time]
- Assign Selection to Tag:** Radio buttons for 'Real - Time Item' and 'HDA Item' (selected).
- Data Source:** Text field with 'Energy' and a browse button (...).
- Item Name:** Text field with 'Energy\_Cons' and a browse button (...).
- Display Data from:** A dropdown menu showing 'Tag Values' and a 'Multi-selection' checkbox.
- Data Configuration:** Radio buttons for 'Dream Report History' and 'External History Server' (selected).
- Data Source:** Text field with 'Process' and a browse button (...).
- Item Name:** Text field with 'Batch\_Data:Tank1' and a browse button (...).
- Define time period:** A dropdown for 'Absolute or relative period definition'. Below are two columns for 'Start of report period' and 'End of report period', each with 'Absolute Date/Time' dropdowns, date pickers (10/1/2012 and 10/16/2012), and time pickers (13:00:00 and 13:00:00) with 'hh:mm:ss back' labels.
- Send Result To:** An empty table with multiple rows and columns.
- Timestamp:** Two dropdowns for 'Date' and 'Time', both set to '<<Current Time>'. Below are checkboxes for 'This Combo Box is Obligatory', 'Visible in PDF', 'Add Def. Value \* <Not specified> \*', and 'Autofilter'.
- Buttons:** 'All Values' checkbox, 'Advanced SQL' button, 'OK' button, and 'Cancel' button.

User has to select a tag (**Data Source/Item name**) and time period (**Define time period**), and then the combo box will be filled with all values extracted for the specified tag for the specified time period.

If user wants to display all existing values, he can check the **All values** check box, and then the time period definition control will become disabled and all tag values will be extracted. If more than one same value exists in the database, only one will be displayed in the combo box (it will operate similar to the “**SELECT DISTINCT ...**” SQL query).

If a user wants to apply additional filtering to the data, he/she can click on the **Advanced SQL** button. The **Advanced SQL Condition** dialog window will be opened (for details, please see [Advanced SQL Condition](#) section of this manual).

- **List of users** display. When this option is selected, the combo box will be filled with the list of all available users.

If Windows user management system is used (Active directory or local windows users list), then Dream Report will retrieve the list of all users from Windows and fill the combo box with that list (for details, please see [User Management](#) section of this manual).



## Ocean Data Systems

- **Show Data Source List.** This option will have 2 radio-buttons: “**Dream Report History**” and “**External History Server**” (please see the pic. below):

Combo Box Configuration

Object name: Production\_1    Default Value: [[pp#pp\_End\_Time]]

Display Data from: Show Data Source List    Multi-selection:

Data Configuration:  
 Dream Report History  
 External History Server

Assign Selection to Tag:  
 Real - Time Item     HDA Item  
Data Source: Energy  
Item Name: Energy\_Cons

Send Result To:

Timestamp:  
Date: <Current Time>    Time: <Current Time>

This Combo Box is Obligatory     Visible in PDF  
 Add Def. Value \*<Not specified>\*     Autofilter

OK    Cancel

In a web report the web combo box will be filled with a list of data sources of the corresponding type.

- **Show Tag List.** If this display option is selected, its configuration will be the following:

Combo Box Configuration

Object name: Production\_1    Default Value: [[pp#pp\_End\_Time]]

Display Data from: Show Tag List    Multi-selection:

Data Configuration:  
 Select Data Source below  
 Select Data Source from another Combo box

Display Data from:  
 Dream Report History     External History Server  
Process

Assign Selection to Tag:  
 Real - Time Item     HDA Item  
Data Source: Energy  
Item Name: Energy\_Cons

Send Result To:

Timestamp:  
Date: <Current Time>    Time: <Current Time>

This Combo Box is Obligatory     Visible in PDF  
 Add Def. Value \*<Not specified>\*     Autofilter

OK    Cancel

The "Data Configuration" section will have 2 radio-buttons: "Select Data Source below" and "Select Data Source from another Combo box".



## Ocean Data Systems

If **Select Data Source below** option is selected, then the "**Display Data from**" combo box will contain the list of data sources by the selected type: **Dream Report History** or **External History Server** (please, see the pic. above).

If **Select Data Source from another Combo box** option is selected, then the "**Display data from**" combo box will contain the list of web combo box objects, defined in that report (please, see the pic. below):

The screenshot shows a configuration window for 'Display Data from:'. At the top, there is a dropdown menu currently showing 'Show Tag List' and a checked checkbox for 'Multi-selection'. Below this is a section titled 'Data Configuration' with two radio button options: 'Select Data Source below' (unselected) and 'Select Data Source from another Combo box' (selected). At the bottom, there is another 'Display Data from:' dropdown menu showing 'Production2'.

The "**Show Tag List**" combo box will be a drop down list where users will be able to select one or multiple tags in one selection. The "**Show Tag List**" combo box in a web report will have no default selection.

If a report is generated from Web and this report has the "**Show Tag List**" combo box with no selection, then all reports will be generated by default using tags, originally defined in all report objects. But if report is generated and the "**Show Tag List**" combo box has some tags selected, then, the report will be generated for the selected tags using the tag replacement mechanism (used in [Report Pre-processor](#)).

- **Show Report Instances List** display. If this option is selected, then, in real-time, it will be filled with the list of report instances defined for that report.
- **Show Batch Definitions** display. If this option is selected, the combo box in a web report will be filled with a list of batch definition names defined in the project. Report may have multiple combo boxes with this function defined.





## Ocean Data Systems

- **Show Batch IDs List** display. If this option is selected, its configuration will have the following design:

The "**Data Configuration**" section will have 2 radio-buttons: "**Select Batch Definition below**" and "**Select Batch Definition from another Combo box**". Both options define the source for retrieving and building the **Batch ID list**.

If "**Select Batch Definition below**" option is selected, then the combo box will be filled with the list of the actual (existing) batch definitions, defined in the project.

If "**Select Batch Definition from another Combo box**" option is selected, then the combo box below that radio-button will be filled with the list of all web combo box objects, defined in this report. User will be able to select a web combo box object, which will have the "**Batch Definition**" function (described above in the "**Show Batch Definitions**" section), and then the batch ID list for that given web combo box will be filled with batch IDs taken from the batch definition, which has been selected in a corresponding "**Show Batch Definitions**" web combo box.

The "**Show Batch IDs List**" combo box in the web report will have no default selection.

If report is generated from Web and report has the "**Show Batch IDs List**" combo box, then, if it has no selection, the report will be generated using the default time period, defined in its objects. If the "**Show Batch IDs List**" combo box has any selection, the report will be generated for the selected batch ID.

Check box "**Multi-selection**" will define if the combo box will be opened in a **multi-selection** mode (drop-down list with check-boxes). If this option will be disabled, then the combo box will be opened as a regular **single-selection** drop-down list combo box.

By default this check box is unchecked.

In the **Assign Selection to Tag** section user has to select either a real-time (**Real-time Item**) or history data (**HDA Item**) value parameter, which will get the selected value of the combo box when the report is completed.



## Ocean Data Systems

Combo box **"Send Result To:"** specifies an action for any selected entry of this combo box. This combo box will be filled with the list of other combo boxes, defined in this report, and user can select any of them. As soon as any selection has been done in this combo box in real-time, the selected "child" combo box data will be refreshed.

In the **Timestamp** section user can define timestamp (**Date** and **Time**) for the defined entered values.

If check box **"This combo box is obligatory"** is checked, then selecting a value from this combo box is required for successful report validation. If a user will not select any value, he will not be able to complete the report. If this check box is checked, then a red **"\*\*"** mark will be displayed to the left from the combo box and, as soon as a user selects any value from the combo box, the **"\*\*"** will change its color to green.

If check box **"Add Default Value "<Not specified>"** is checked, then the combo box will be filled with all values according to its data configuration and one more entry- **<Not specified>** - will be entered in addition.

The **"Visible in PDF"** option controls whether this Combo Box object will be displayed in the generated PDF report or not.

If check box **"Autofilter"** is checked, then values in the combo box will be filtered automatically.

### Display mode

User is able to display a list box on a web report either as a standard list box or as a selection list. This can be configured by "Display mode" control:

The screenshot shows the 'Combo Box Configuration' dialog box. The 'Display Mode' section is highlighted with a red box. It contains a dropdown menu set to 'Display as List Box' and a checked 'Multi-selection' checkbox. Other sections include 'Object name' (TP\_TagSelector), 'Default Value', 'Display Data from:' (Show Tag List), 'Assign Selection to Tag' (Real - Time Item, HDA Item), 'Data Source', 'Item Name', 'Send Result To:' (TP\_TagSelector), 'Data Configuration' (Select Data Source below, Select Data Source from another Combo box, Display Data from: Dream Report History, External History Server, Process), 'Favourite tags list', 'Timestamp' (Date: <Current Time>, Time: <Not Used>), 'This Combo Box is Obligatory', 'Visible in PDF', 'Add Def. Value "<Not specified>"', and 'Autofilter'. 'OK' and 'Cancel' buttons are at the bottom.

If "Display as List box" option is selected, then a standard list box will be displayed.

If "Display as selection box" is selected, then each entry in a list box will be displayed as a selection button (radio-button, if "Multi-selection" check box is unchecked, or as check boxes, if "Multi-selection" check box is checked).



## Action Button

**Action Button** is a dynamic interactive object, which enables users to perform a pre-defined action, and is available ONLY in WEB reports (please also see [Manual Data Entry](#) section)

To add this object, click on the command button *Action Button* on the *Web Elements* ribbon icon on the horizontal toolbar in the Dream Report Designer Studio menu (see pic. below):

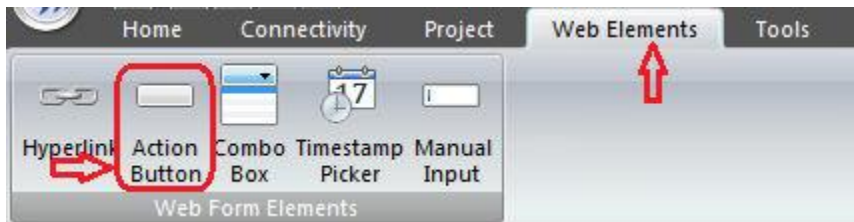

Add a button to the report and the following **Action Button Configuration** dialog box will be opened:

**Action Button Configuration**

Button Caption  
Validate Production Data

Select Action  
Validate Data

Action Parameters  
Validate Source  
Tank1\_Avg

OK Cancel

In this dialog window user has to define the name for the caption (**Button Caption**), select an action to be done when this button will be pushed (**Select Action**) and also configure **Action Parameters** (if needed).

Each defined action has its proper parameters for action. There are 10 actions available: **Validate data**, **Submit Correction**, **Submit**, **Refresh report**, **Generate report**, **Login with different user**, **Logout**, **File transfer**, **Generate PDF** and **Reset web report data**.



## Ocean Data Systems

- If “**Validate data**” action is selected, there will be no special action parameters to configure. Access to the data validation action will be managed on the level of configuration of a user access to that report – only the supervisor login can access the validation of the report data.
- If “**Submit Correction**” action is selected, there will be no special action parameters to configure. User will only have to select the source (**Submit Source**) and the report fields will be checked for correct data in that source. If report validation has passed, the data will be recorded into the database (please see the pic. below):

Select Action

Submit Correction

Action Parameters

Submit Source

Energy

- If “**Submit**” action is selected, there will be no special action parameters to configure. Report fields will be checked for correct data, and if report validation has passed, the data will be recorded into the database.
- If “**Refresh report**” action is selected, Dream Report will read all data entered manually (in edit boxes, combo boxes, tables etc.), calculate all statistical objects, located in the actual displayed report using that data, and refresh the data of all objects in the currently displayed web report. Dialog has 2 additional options for refreshing a report: **Make Dynamic Tag Replacement** and/or **Configure dynamic parameters** (please, see the pic. below):

Action Button Configuration

Button Caption

Generate

Select Action

Refresh Report

Action Parameters

Make Dynamic Tag Replacement

Get Tag List From

TP\_TagSelector

Dynamic Parameters

OK Cancel

By default both check boxes will be disabled.

If **Make Dynamic Tag Replacement** option is enabled, then the "**Get Tag List From**" combo box below will be filled with the list of all web combo box objects, which have the "**Tags List**" and "**Report Instances**" functions.



## Ocean Data Systems

If in real-time (in a web report), the selected web combo box object has no selected value, the report will be generated without any dynamic replacement.

If, during report generation, the selected combo box has the value(s) selected, the report will be generated with original tags replaced by the web combo box selection: either by other tags (tag set), selected in a web combo box object, or by virtual report instance(s).

If user will click on **Dynamic Parameters** button, then the following window will be opened:

Parameter Name	Parameter Type

This window allows user to set dynamic time period parameters (either batch based or report start and time, coming from dynamic/calculation objects) as well as pass values to Internal Project Parameters for report generation.

The upper list box "Generate report using dynamic time period" has three available values:

- **Dynamic period is not used** - this option disable dynamic parameters for report generation.
- **Batch-based period**. This option enables users to specify object, which value will hold a batch ID. This list box will automatically contain the list of all *Single Data Object*, *Expression Object* and *List Box* object types, existing in that report. Content of any such an object can be used as a source for batch ID for report generation.
- **Time-based period**. This option enables to generate report using dynamic time period. If this option is selected, then user will be able to select the object for report start time and the object for report end time. *Single Data Object*, *Expression Object*, *Date/Time picker* and *List Box* object types are available for selection.



- If “**Generate report**” action is selected, user will have to select a report and report instance (if defined), which will be generated (please, see the picture below):

Dialog has the additional options for report generation: **Make Dynamic Tag Replacement**.

By default this option is disabled.

If **Make Dynamic Tag Replacement** option is enabled, then the "**Get Tag List From**" combo box below will be filled with the list of all web combo box objects, which have the "**Tags List**" and "**Report Instances**" functions.

If in real-time (in a web report), the selected web combo box object has no selected value, the report will be generated in a hard copy (PDF/Excel) format without any dynamic replacement.

If, during report generation, the selected combo box has the value(s) selected, the report will be generated in a hard copy (PDF/Excel) format with original tags replaced by the web combo box selection: either by other tags (tag set) selected in a web combo box object, or by virtual report instance(s).

The report will be generated in PDF/Excel format for the selected batch definition.

Dynamic parameters button has the same functionality and enables the same operations, as described above in "Refresh" button function.



## Ocean Data Systems

- If “**Generate PDF**” action is selected, then, when user will select this option, current report view will be saved as PDF in a PDF file in the reports folder. Report file name and location will be taken from the corresponding report settings.

**NOTE:** If you have Microsoft XP operating system installed on your PC, then, in order to define correct path to the place where generated PDF files will be stored, please go to the [Web Configuration](#) section of [Project Settings](#) and click [OK](#).

- If “**Login with different user**” action is selected, there will be no special action parameters to configure. The current user will be logged out. The general “Login” page (Web Portal Welcome page) will be opened, where user will have to enter login credentials.
- If “**Logout**” action is selected, there will be no special action parameters to configure. The current user will be logged out, and the Web Portal Welcome Page will be opened.
- If “**Reset web report data**” action is selected, Dream Report will read all data entered manually (in edit boxes, combo boxes, tables etc.), calculate all statistical objects (located in the actual displayed report using that data), and update/change the data of all objects accordingly in the currently displayed web report.
- If “**File Transfer**” action is selected, user will have to select a folder, where all client's selected files will be transferred to:

Select Action

File Transfer

Action Parameters

Select Folder to Transfer

C:\Data\DEF

When user will click on the “...” (browse) button, a standard Windows “**Browse for Folder**” window will be opened, where user can select any Windows folder, where files, selected on a web client side, will be transferred.

**NOTE:** When user will click on the “...” (browse) button on a web report, the “**Select file**” window will be opened, where user can select any single file (no filter by extension), and as soon as the file has been selected, it will be transferred to the server. A window with a progress bar and the “*Cancel*” button will be displayed until the operation is completed. **The maximum size of an uploaded file is 51200kB.**



## Ocean Data Systems

- If "**SQL Query**" action is selected, then user can set SQL query and execute that SQL query when that button is clicked in a web portal. With that selected action, button will have the following configuration:

Select Action

Execute SQL Query

Action Parameters

Edit SQL Query

DSN: Process

SQL Query:

```
SELECT batchID, Username, Lot, Phase ID FRO
```

To edit SQL query user has to click on "Edit SQL query" button. Then selected DSN and selected SQL query will be displayed in the window above, just for information and for quick edit.

When user click on Edit SQL query, he will receive a standard "Edit SQL query" dialog window, which is described in details in its own section **Edit SQL Query**.





## Tree Object

The **Tree Object** is a dynamic interactive web object, which enables users to display the folder structure of a hierarchical tag source. The selected group, or sub-group, can then be used to filter an associated **Combo Box** which has been configured to display a tag/item list. The **Tree Object** is available ONLY in WEB reports. The **Tree Object** will be visible only in Web reports and will not be displayed in PDF/Excel reports.

**NOTE:** *In the current version of Dream Report (4.6 R4), only External History data sources are supported, in which the tags are organized or exposed in a “hierarchical” structure (as opposed to a simple or “flat” structure.)*

To **add** this object, click on the “**Tree Object**” command button on the **Web Elements** ribbon icon in the horizontal toolbar of Dream Report **Designer Studio**:



Draw a rectangle in the report workspace where the **Tree Object** will be displayed. The following **Tree Configuration** dialog box will be opened:

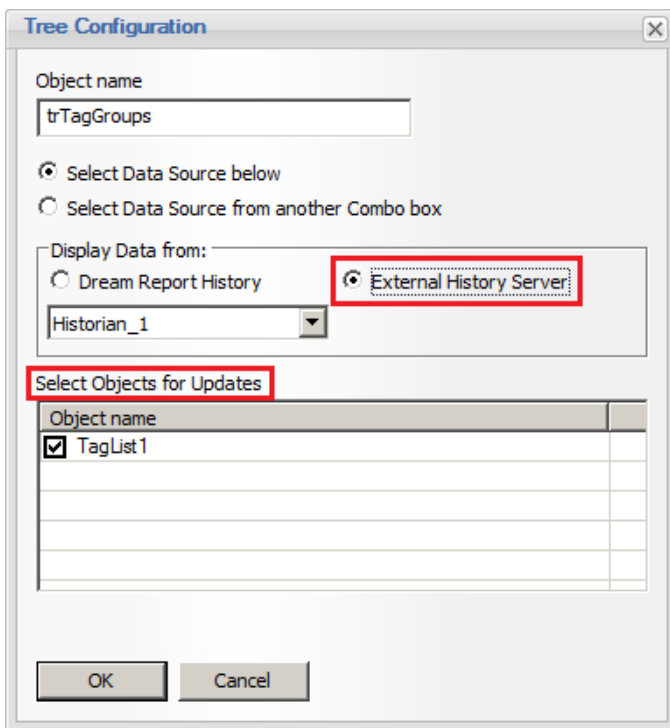

**Object Name** must be a unique logical name, which can be referenced by other objects within the project.

The **Tree Object** can either access a specific data source, by selecting “**Select Data Source below**” option, or by selecting a data source dynamically at runtime, by selecting the “**Select Data Source from another Combo box**” option. Depending on which option is selected for the **Data Source**, select the appropriate **Data Source (External History Server)** or **Combo Box** from the “**Display Data from:**” section.

Finally, if you wish to dynamically update any associated objects (e.g., a list of tags in a **Combo Box** on the web report), make sure to **Select Objects for Updates**.



## Ocean Data Systems

Click “OK” to close the **Tree Configuration** window. The **Tree Object** will display on the report, as shown in the left image below (“trTagGroups”). The “TagList1” Combo Box object shown on the right of this image is associated with the “trTagGroups” Tree object.

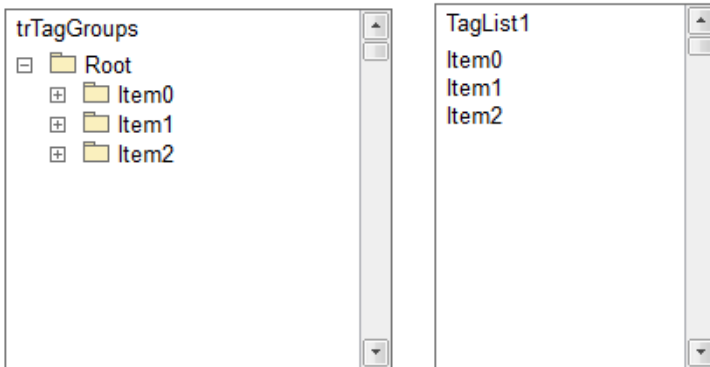

At runtime, on a **Web report**, the **Tree Object** will be populated according to the hierarchical structure of the data source. Double-clicking on a folder will either expand the folder to the next level, or display any tags/items contained in that group in any associated object(s), as shown below:

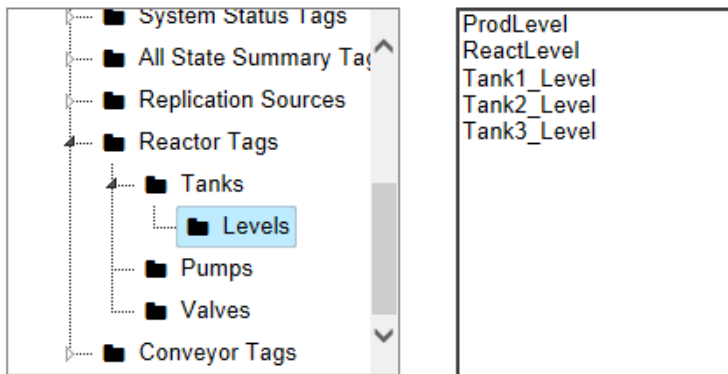



# Report and Page Templates

## Page Templates

**Page template** allows users to create page templates that can be easily reused within reports. A page template is similar to the headers and footers of a page in other software. It allows a user to create a template with a common visual layout for every report page.

A page template will save all static objects, including images, pictures, backgrounds, static drawings, static text, and some dynamic objects, such as page number, dynamic text and date/time.

If a user will save any existing report page as a template, all static objects will be saved, and all dynamic statistic and analytic objects will be ignored.

In order to **save the current page as a template**, click the right mouse button on the context menu on report in the report list.

You can also click on the command button *Page Template* on the **Home** ribbon icon on the horizontal toolbar in the Report Designer Studio (see pic. below):

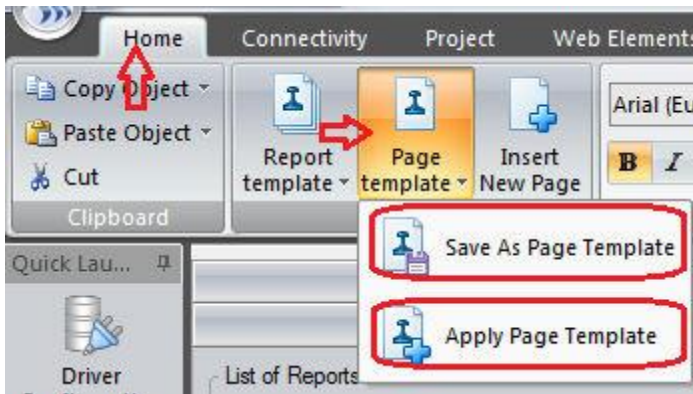

Select **Save as Page Template** option. Page template file will be created with **\*.ptdr** extension.

**NOTE:** Users can also save the current report page as a template by clicking on the ODS button in the upper left part of the Dream Report Designer Studio.

By default page template files are saved in the **Templates** folder within the Dream Report installation directory.

To **apply a page template** to a report, click the right mouse button on the context menu on a report in the report list.

You can also click on the command button *Page Template* on the **Home** ribbon icon on the horizontal toolbar. Select **Apply Page Template** option. The standard Windows *File Open* dialog box will be opened, and a user can select any page template to apply to the current page.

Once the template is added to a report, each template element (pictures, background, graphic objects etc.) will be available for editing as independent objects

If a user applies a page template to an existing report, it will add all template elements to the report page and will not damage the existing report content.



## Creating a Footer and a Header

When you save your page as a template, it will be replicated for every new created page of that report. When making reports with long tables, which create and jump to the new pages, user may need to keep some upper area of every page free of any objects. Then, when objects start to jump to a new page, they will start it only from some area, keeping the certain upper section free. For this, users have to define header.

To create a header, you have to place all your header objects to their places, drag down a small green triangle on a vertical ruler (on the top left side of the workspace) and place it below your header objects, as displayed on the picture below:

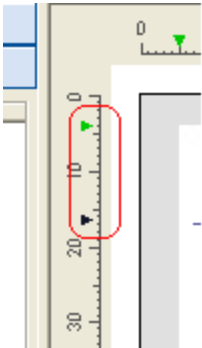

Then, all the area above that triangle will be greyed, and all objects, located in that grey area will be kept clean from any overlaying tables or other objects.

Please, note that, when you drag down the green triangle, it will create the header area not only on the page, where you drag it, but also on every page of that report, including all new pages, which will be dynamically created while generating that report.

Creating a footer should be done using exactly the same procedure, but just dragging up the green triangle on the left bottom part of the vertical ruler.

**NOTE:** Report pages can be also saved as templates by clicking on the DR Main Button in the upper left part of the Dream Report Designer Studio (please see the picture below):

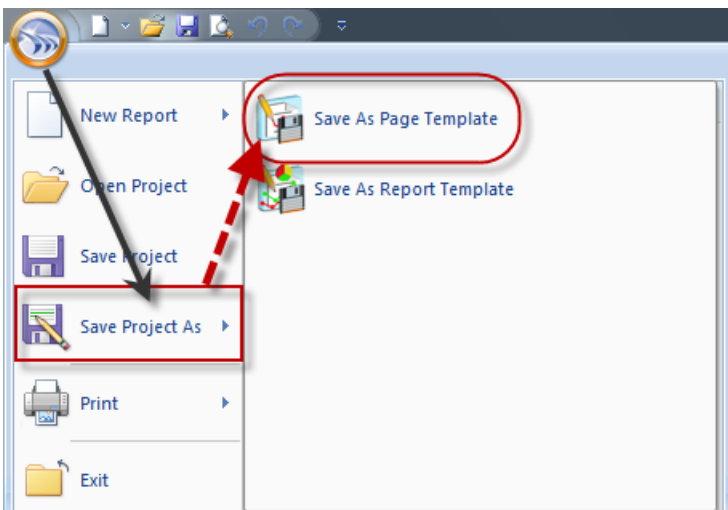



## Report Templates

The **Report Template** mechanism allows users to create templates of entire reports to be used for creating other reports. It can be reused to build similar reports.

A report template will save all static, dynamic statistic and analytic objects within the report, but also will include report settings and Excel report configuration.

If users will save an existing report as a template, the overall report content will be saved as a template.

To save the current report as a template, right-click on the report in the report list and select menu **Save as Report Template** (see pic. below):

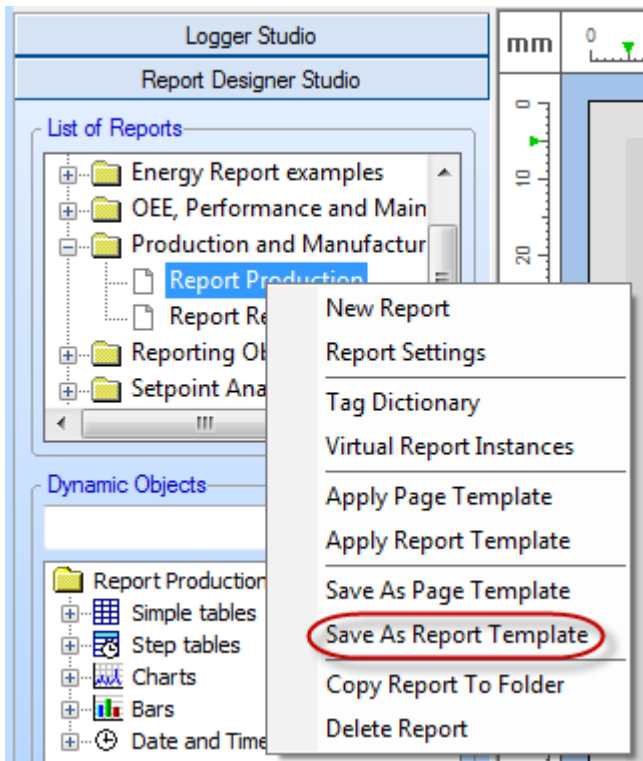

You can also click on the command button **Report Template** on the **Home** ribbon icon on the horizontal toolbar in the Report Designer Studio (see pic. below):



The report template file will be created with a **\*.tdr** extension.

**NOTE:** Users can also save the current report as a template by clicking on the ODS button in the upper left part of the Dream Report Designer Studio.

By default report template files are saved in the **Templates** folder within the Dream Report installation directory.



When a user *saves a report as report template*, the following **Save Report Template** window will be opened:

In the **Set Path** edit box user will have to select the desired report template (\*.tdr files) by browsing for such a template using "..."  
(browse) button on the right from the combo box.

**Include in Template** section contains 3 check boxes (**Report Settings**, **Tags Dictionary**, **Excel Export Settings**), which will define which report information will be saved with the template. If any of those check boxes are unchecked, then this part of the report information will not be saved.

### Tag dictionary

The control list **"Tags dictionary"** will be filled with all tags, which are used in this report in various objects. Columns **"Data Source"** and **"Item Name"** will be filled with relevant tag information. The column **"Description"** will be empty. User can click or double-click into the **"Description"** column and the field will be opened for inserting or editing a text with the logical description of this tag. All the list of source/tag names and their descriptions will be saved inside the report template file. When saving the report template, the tag dictionary will save **ONLY** tag descriptions and their reference associations with statistical objects in the template. Data sources and tag names will not be saved in the template.

**To apply report template** to an existing report, right-click on the report in the report list and select menu **Apply Report template**:

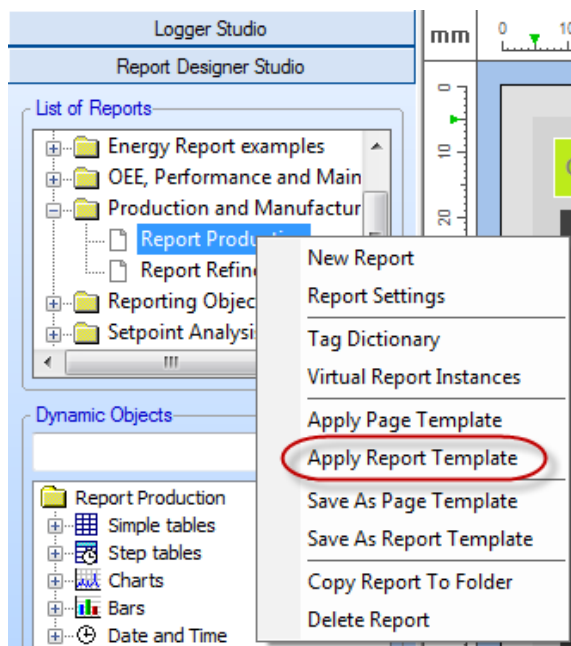
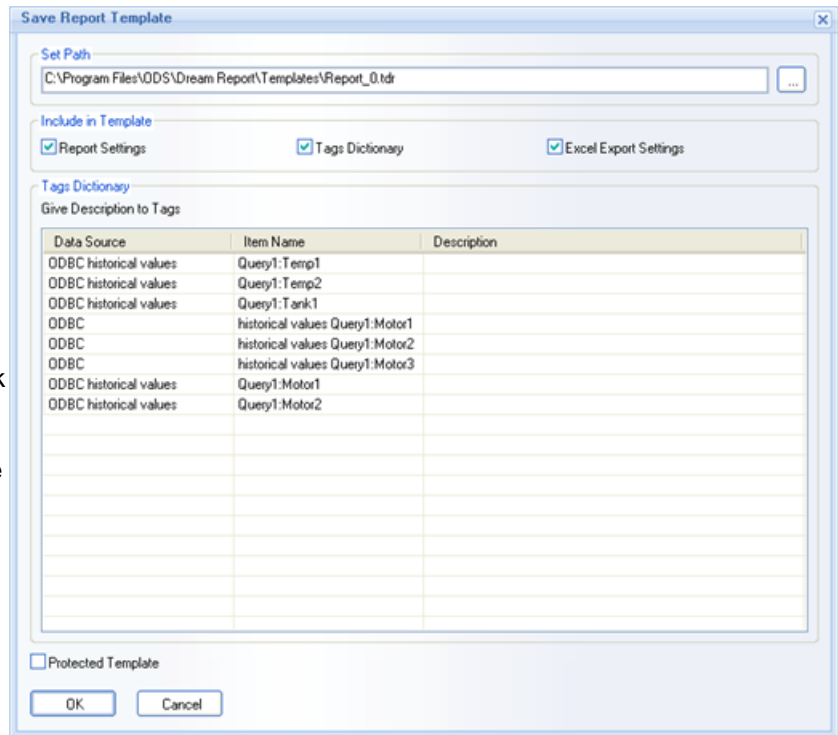



You can also click on the command button *Report Template* on the *Home* ribbon icon on the horizontal toolbar in the Report Designer Studio (see pic. below):

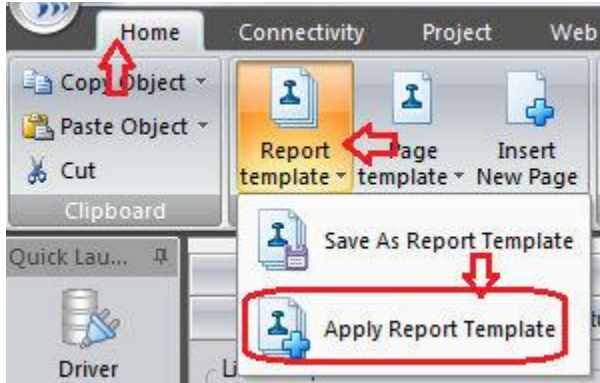

Then *Apply report template* dialog window will be opened:

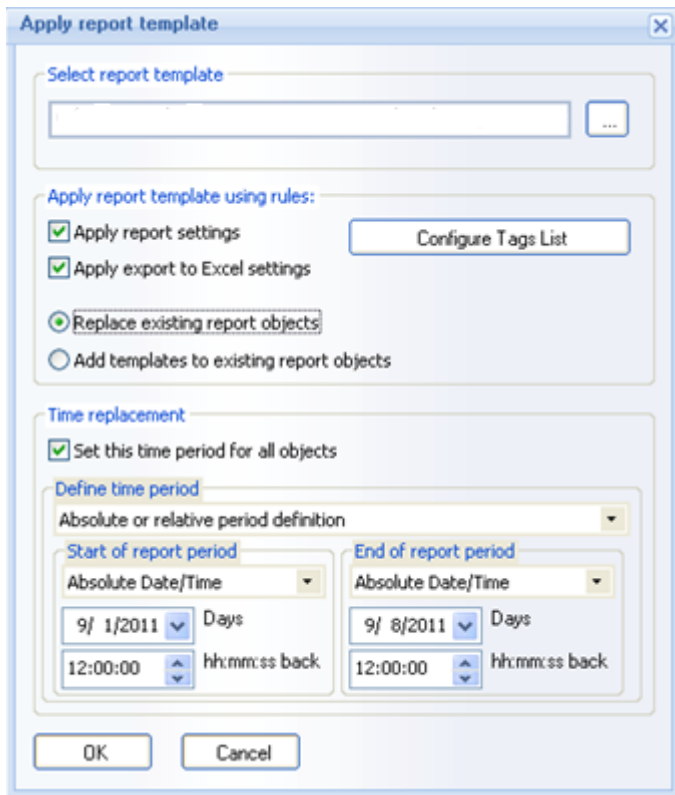

User can choose the desired report template and also configure applying settings as follows:

In *Select report template* edit box, the report template has to be selected (\*.tdr files). One can browse for such a template using "." (browse) button on the right from the combo box.

If the current loaded template has any entry(ies) in the tag dictionary, then the *Configure Tags List* button will become enabled.

If the current template has no tag dictionary defined, or it's originated from older versions, then the *Configure Tags List* button will be disabled.





## Ocean Data Systems

When user clicks on the “[Configure Tags List](#)” button the “[Project Tag Dictionary](#)” window will be opened (please, see [Tag Dictionary](#) section).

If this dialog is opened from the existing report template, which has tag dictionary defined, then it will be filled with tag descriptions from the template. “[Source](#)” and “[Item name](#)” columns will contain a small button “...” (browse). When user clicks on it, the following [Data Item Picker](#) dialog window will appear:

The screenshot shows a dialog box titled "Data Item Picker". It contains a "Select Data Item" section with two radio buttons: "Dream Report History" (unselected) and "External History Server" (selected). Below the radio buttons are two text input fields: "Data Source" with the text "ODBC historical values" and "Item Name" with the text "Query1:Temp1". The "Item Name" field has a small "..." button to its right. At the bottom of the dialog are "OK" and "Cancel" buttons.

If a user will click **OK** in this item selection dialog window, source name and item name will be set into the list control. The source type ([Dream Report History](#) or [External History Server](#)) will be saved for each entry separately as well.

If source name or/and item name is defined in the list control and user calls the item selection dialog window, then [Select Data Item](#) window will be opened with existing selection filled in.

If a user will double-click either into the “[Source name](#)” column or into the “[Item name](#)” column, the cell will be opened for manual text editing.

In the top-right corner of the tag dictionary dialog window, there is a button “[Print](#)”. If a user will click on it, it will open Windows print dialog box and user can select printer (or the file) and print the list of Source/item names and their descriptions.

For details on how to configure tag dictionary, please, go to the [Tag Dictionary](#) section.

### Apply report template rules:

**Apply report settings** check box defines report settings, such as report naming rule, generation schedule, report target configuration etc. If this check box is checked, then report settings from the report template will overwrite actual reports settings. If this check box will be unchecked, then the report will remain with the original report settings.

**Apply export to Excel settings** check box defines if Excel report configuration will be applied from report template to your report. If this check box is enabled, then Excel report configuration will be applied to your report and overwrite existing Excel configuration (if it exists). If this check box is unchecked, then Excel report configuration will not be applied to your report from the report template.

If the option [Replace existing report objects](#) will be selected, then all the entire content of the applied report template will replace all existing objects in the report and will make that report the exact copy of the applied template.

If the option [Add templates to existing report objects](#) will be selected, then the report objects will be added to your report in addition to the existing ones. If position of any existing object will be the same as from any new object from the template, such objects will be overlaid one on top of the other.

**Time replacement** option enables users to apply report template, applying desired time period to all template objects.





## Ocean Data Systems

If **Set this time period for all objects** check box is checked, then user can specify time period definition, which will be set for all objects, which will be added to the report from the template.

For details on time period definition, please, see [Time Period Definition](#) section.

If this check box will be unchecked, then time period replacement will be disabled and all template objects will be added to the report with their original time definitions.

Once the selected template is added to the report, each template element will be available for editing as an independent object.

Further report modifications will not affect its report template design and also further template modifications will not affect design of that report.

### Moving reports from one project to another

If you need to move the report from one project to another, please, do the following:

1. Save the report, that you want to move, as a report template.
2. Load the project, where you want to move this report.
3. Define a new report, and apply to it that saved report template.

**NOTE:** Reports can be also saved as templates by clicking on the DR Main Button in the upper left part of the Dream Report Designer Studio (please see the picture below):

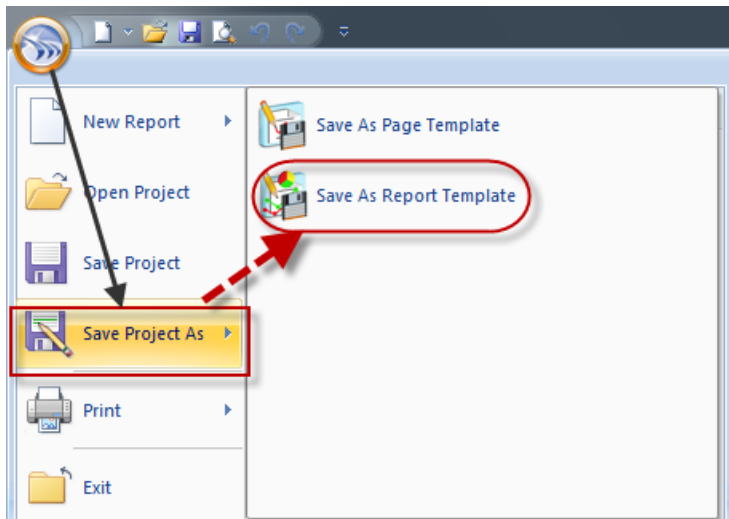

### Private Code Protected Templates

Reports templates developers are able to save report template and lock it by any private code.



# Tools

## Tag Dictionary

The **Tag Dictionary** module enables users to create tag dictionary for multiple reports.

With the right button of the mouse, click on the report context menu. The report list will have a new entry: **Tag dictionary**.

You can also click on “*Configure Tags List*” button in the “**Apply report template**” dialog window (see **Report Templates** section).

Or you can click on the command button *Tag Dictionary* on the **Tools** and **Project** ribbon icons on the horizontal toolbar in the Dream Report Designer studio menu (see pic. below):

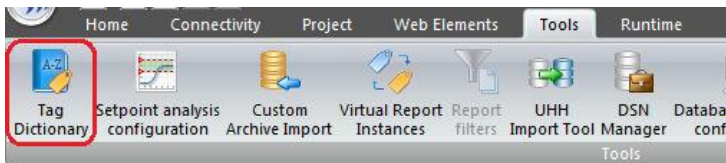

The following “**Project Tag Dictionary**” dialog window will be opened:

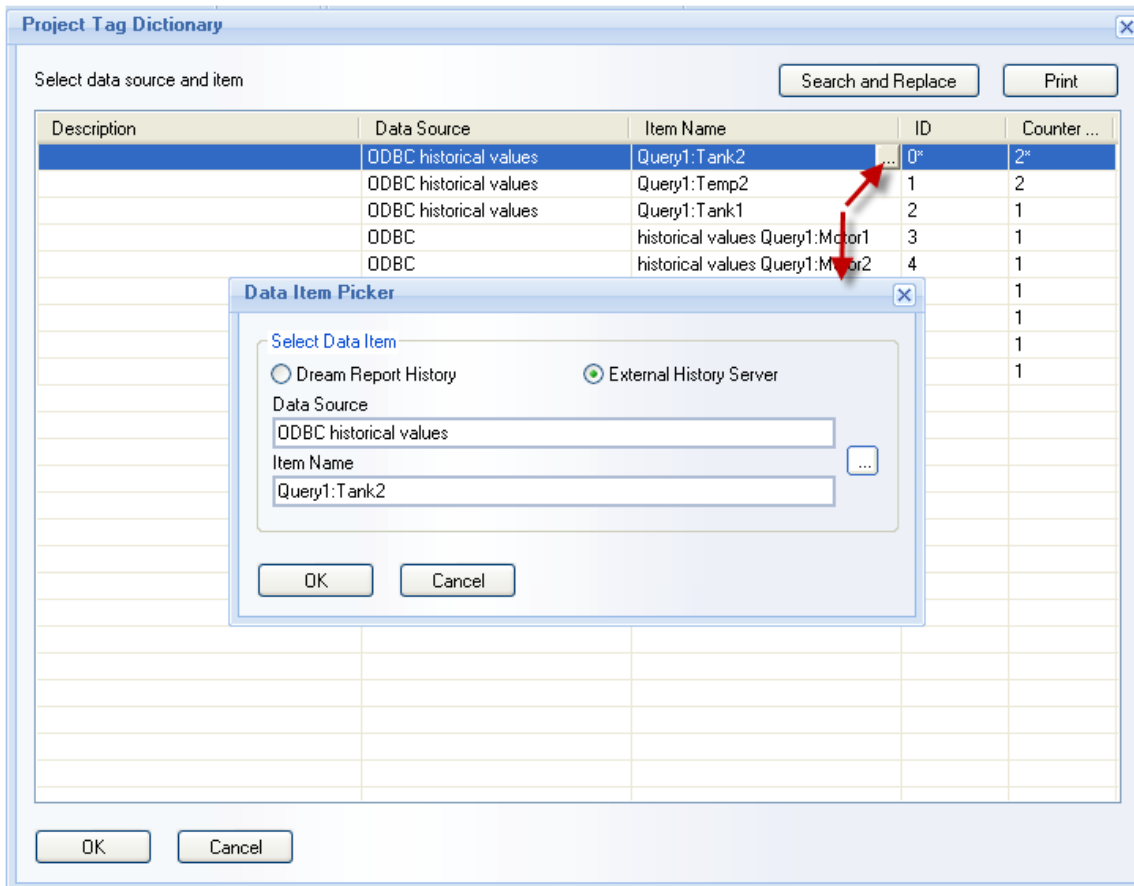



**Tag Dictionary** will be filled with all tags, which are used in this report in various objects. Columns **“Data Source”** and **“Item Name”** will be filled with the relevant tag information. The column **“Description”** will be empty. User can click or double-click into the **“Description”** column, and the field will be opened for inserting or editing a text with the logical description of this tag. All the list of source/tag names and their descriptions will be saved inside the report template file together with the reference information on the objects and the names defined.

### Tag Dictionary Configuration

If this dialog is opened from the existing report template, which has tag dictionary defined, then it will be filled with tag descriptions from the template. **“Data Source”** and **“Item Name”** columns will contain a small button **“...”** (browse). When a user clicks on it, the following **Data Item Picker** dialog window will appear:

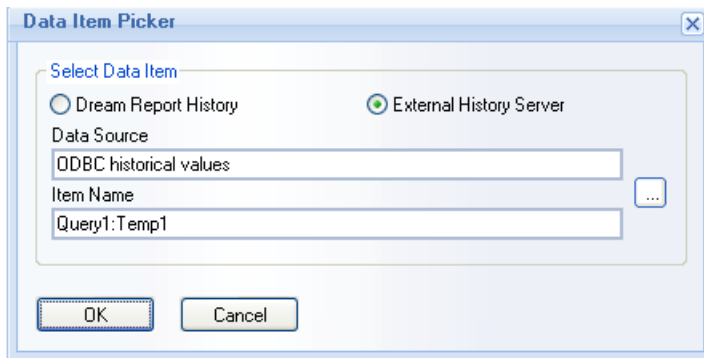

If a user will click **OK** in this item selection dialog window, the source name and the item name will be set into the list control. The source type (Dream Report history or External History Server) will be saved for each entry separately as well.

If a source name or/and item name is defined in the list control and user calls the item selection dialog window, then the **Select Data Item** window will be opened with the existing selection filled in.

If a user will double-click either into the **“Data Source”** column or into the **“Item Name”** column, the cell will be opened for manual text editing.

In the top-right corner of the tag dictionary dialog window, there is a button **“Print”**. If a user will click on it, it will open Windows print dialog box.

Select printer (or the file) and print the list of Source/item names and their descriptions.

### Report Tag Dictionary

If this report has been created from the report template, using tag dictionary, then it will be saved for this report as well. When a user will open **Tag dictionary** from the context menu, it will be filled with the relevant information.

If this report doesn't have tag dictionary information yet, then this window will have the list of all tags, used in the project. User can enter the best fit description for every such a tag.

Tag dictionary will be saved into the encrypted **XML file** with the name of report and extension **\*.tdi**. This file will contain the list of source name; item name; description, and, for every such an entry – the list of references of objects, where this tag is used.

If you apply report template to the report and tag dictionary is not empty, then this file will be automatically created.

### Search and Replace

Users can change tag items in the tag dictionary clicking **Search and Replace** button in the top right-hand part of the **Tag dictionary** window. The following **Search and Replace** box will pop up:



To search for the specific tag item, a user will have to type that tag name in the **Item Name** box of the **Select Data Item to be searched** section. If the project tag dictionary contains a large number of tag items, and a user defines only part of the whole name, then, when he clicks on the **Search Next** button, the search and replace mechanism will find all tag items that have this part of the item name in their names.

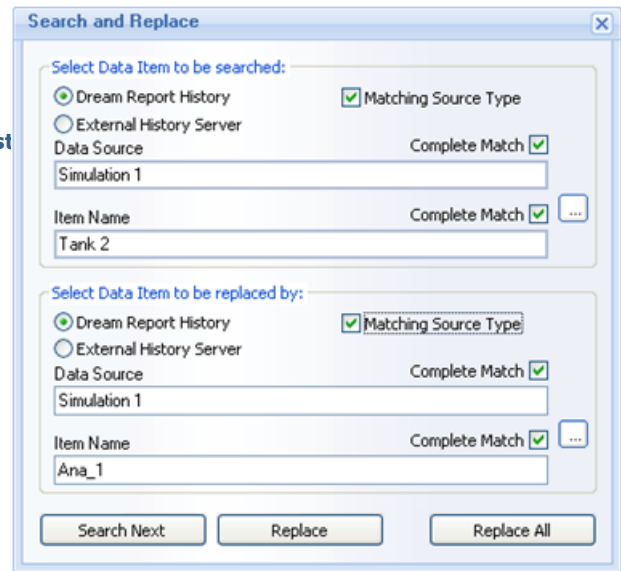

**Example:** If you want to search for tag items with the name *Tank* (Tank 1, Tank 2, Tank 3 etc.), type in the **Item Name** box the word *Tank*, click **Search Next**, and all tag items that have the word *Tank* in their names will be shown.

If you need to find the specific tag with the **complete** name, please, check the corresponding **Complete Match** check box. Then, while searching for the selected item, the search and replace mechanism will show only the tag items that have this complete name.

**Example:** If you want to find tag items, that have the name *Tank 2*, then, if you type only the word *Tank* for the item name, and click **Search Next**, the message box "**No Data Address was found**" will pop up. You will then have to type the complete tag name *Tank 2* to be searched.

If you search for the specific tag item from the specific data source, you can type part of the name of the data source you need in the **Data Source** edit box, and, when you click **Search Next**, the search and replace mechanism will show all tag items and all the data sources where these items have been found (both external and Dream Report).

**Example:** If you have tag item *Tank 1* recorded both into the Dream Report and external historian simulation drivers, then, if you type *Sim* into the **Data Source** edit box, and click **Search Next**, the search and replace mechanism will show all tag items with the name *Tank 1* in all drivers, that have the part of the name *Sim* in their driver logical name (both from Dream Report and External History).

If you need to find the specific tag item from the specific data source, check the **Matching Source Type** check box. Then, while searching for the selected item from the selected database, the search and replace mechanism will show only the data sources that have the same complete data source name as defined in the **Data Source** edit box.

**Example:** If you want to find tag items, that have the name *Tank 2*, and are recorded into the Dream Report simulation driver for real-time values (and this driver has *Simulation 1* as its driver logical name), then, if you type only part of the name *Sim* in the **Data Source** edit box and check **Matching Source Type** check box, then, when you click **Search Next**, the message box "**No Data Address was found**" will pop up. You will then have to type the complete driver name *Simulation 1* to be searched.

The same mechanism should be applied when a user needs to replace tag items in the Project Tag Dictionary (**Select Data Item to be replaced by** section).



## Setpoint Stability Analysis

**Setpoint analysis** is a special module, which allows smart analyzing of thermal and other processes, where the process is based on a setpoint stability analysis. It allows automatic detection of the stability periods, entry and exit points of those stability periods.

To use **Setpoint Analysis**, user has to create setpoint definitions. Then the analysis result can be used in a chart and in statistical functions.

You can create setpoint definitions in the **Setpoint analysis configuration** window. To open it, click on the command button **Setpoint analysis configuration** on the **Tools** ribbon icon on the horizontal toolbar either in the Dream Report Logger Studio or Dream Report Designer Studio menu (see pic. below):

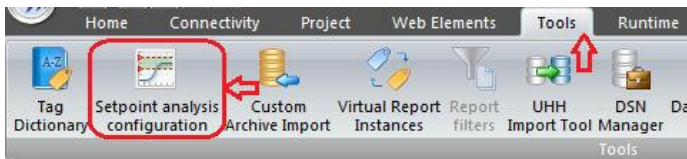

The following dialog window will be opened:

Name	Value	Upper Toler...	Lower Toler...
Dven1 - 700C		10	5

To define a setpoint, enter a logical **Name** (logical name is unique and can't be the same for different setpoints).

Then, enter **Setpoint Value** and its **Bandwidth**. **Bandwidth** defines high ("**Upper Tolerance**") and low ("**Lower Tolerance**") levels for the stability. This enables to resolve the task, when high and low tolerance values are different. Both "**Upper Tolerance**" and "**Lower Tolerance**" values can be defined as a tag – then real-time tag value at the moment of report generation will be used for the corresponding parameter. Double-click on **Upper Tolerance** or **Lower Tolerance**, and the **Select Data Item** dialog will be opened.



## Ocean Data Systems

Select any available real-time driver and select a tag, which real-time value will be taken during report generation for the corresponding tolerance.

In the right-hand part of the dialog window select one of the sources to obtain data from: *Dream Report History* or *External History Server*. Select data source and data items, which will be used as a source for the data for setpoint analysis.

If setpoint configuration has already got some setpoint definition with required data source and tags, select such a setpoint from the combo box next to the button "*Copy from*" and click on that button. This new setpoint definition will copy all defined items from the selected setpoint.

Then click on the button "*Select Data Items*". The *Select Data Items* dialog window will be opened.

Select items/tags, which will be used for this setpoint analysis.

If "*Dream Report History*" radio button will be enabled, then, the combo box "*Select Data Source*" will contain a list of data access drivers defined in the project. If "*External History Server*" will be selected, the "*Select Data Source*" combo box will contain a list of history access drivers defined in the project.

In *Select Data Source* and *Available Data Items*, select the source and item from which Dream Report will calculate values.

Click on the button "*Add*" in the *List of defined setpoints* section and a new setpoint definition will be added to the project. Its name, value and tolerance will appear in the table in this section.

*Consider Stable Period if Values are Stable for at least* enables users to define the stability period by setting the time period when the values will remain stable.

### Rate of Change (ROC)

If you are interested in measuring the rate of change of your values before entering the stability zone and after exiting it - you can set the criteria for the rate of change measurement.

There are 2 sections:

*Rate of change before setpoint* - contains the criteria for the rate of change measurement before entering the stability zone.

*Rate of change after setpoint* - contains the criteria after exiting the stability zone.

Both sections have the same configuration parameters and controls.

*Rate Of Change (ROC)* has 2 sections to be defined:

**Value** - you have to specify the expected rate of change (units (e.g. degrees C) per time unit (e.g. per hour, per minute)).

**Criteria** - to start/stop the rate of change measurement. For the measurement criteria there are 3 options available:

- Start/End of period.** This means that the start time (for ROC before setpoint), or the end time (for ROC after setpoint), will be start/end of the calculation period, defined in the statistical object (e.g. start or end of the batch).
- Start/End of changes** - means that the rate of change measurement will be not calculated from the start or until the end of an object calculation period, but only from the point of time when values started to change (or until values are changing). If this option is selected, the edit box will appear, where a user can enter the *minimum change of value*, from/until which ROC will be calculated.
- Specific value.** This option sets a specific value, so that the rate of change will start/stop its calculation only when the item value will reach this value. If this option is selected, the edit box will appear, where a user can enter the *control value* for start/stop of ROC calculation.



**Example:** If a user sets this option with a specific value of 30, then, the rate of change before setpoint will start its calculation only when the item value (for setpoint) has reached value 30, and will calculate it until the start of the setpoint stability zone.

Setpoint stability zone is a time period, where all values of all items, defined for that setpoint are within the corridor of a setpoint value +/- tolerance.

### Dynamic values

Almost all the parameters, such as: **Setpoint value**, **Upper Tolerance**, **Rate of change value**, **Lower Tolerance**, **Specific value**, **Min rate of change** - can be set as a static number (e.g. 10), or can be set as a real-time tag value. For this, a user can double-click on the needed edit box and the item browse window will be opened. Select the required item and then, in the runtime, when the report is generated, the setpoint module will read the current real-time value of the defined tag, and use its value as a value for that parameter for this specific report generation.

**NOTE:** If you need to enter manual data (from the "Manual Data Entry real-time values" driver), you will have to do the following:

1. Create **Single Data Object** in the report.
2. In this **Single Data Object** select the manual data item from the "**Manual Data Entry real-time values**" driver, which you need for your setpoint module.
3. Select the "**Last Value**" statistical function for this **Single Data Object**.
4. When double-clicking on the needed edit box in the setpoint module configuration, select from **Analytical** driver this **Single Data Object**. The setpoint module will then read the last value for the manual tag entered.

### Process Success Criteria

This section contains the set of options, which will be used to define automatic process validation.

**All values are within defined bandwidth during stability period** option controls the situation when one or multiple values will fall out of stability bandwidth. If this option is enabled, the process result will be "**Failed**". If this option is disabled, then the process result will be "**Succeed**".

**Rate of change is not less than expected/Rate of change is not more than expected** option controls how rate of change influences the result.

- If rate of change is less than expected and the option "**Rate of change is not less than expected**" is enabled – the process will fail, and if this option is unchecked – the process will succeed.

- If rate of change is more (faster) than expected and the option "**Rate of change is not more than expected**" is enabled – the process will fail, and if this option is unchecked – the process will succeed.

**Exclude failure from calculated stability period** option influences only calculation of duration of stability period and no other influence.

This option controls the situation when, during the stability period, one or multiple points will exit from the stability bandwidth and then return back into the stability corridor. If this option is enabled, then the time period, when one or multiple values will be out of range, will be excluded from the calculated duration of stability. If this option is not checked, the full stability period will be taken for duration calculation.

**Example:** The stability period started at 10:00 and finished at 11:00. During this period one data item exited from the stability bandwidth at 10:10 and then returned back into the stability corridor at 10:30. If this option is enabled, the duration will be 40 min, and if it will be unchecked, the duration will be 1 hour.

**Ignore rate of change before stability/Ignore rate of change after stability** options define if rate of change should be considered for the process validation ("Stability result" function).





## Ocean Data Systems

If any of those check boxes will be checked, the rate of change will be ignored during calculation of the “Stability result” function.

**Ignore out of the range item(s)** option enables to discard from the setpoint calculation the items with the values, which are either higher or lower than the ones defined in the setpoint.

When this option is selected, a user will be able to set Low (**From**) and High (**To**) limits for the setpoint definition.

Any calculated statistical function or a chart, where the setpoint with such definition is used, will check if the entry value of every item, defined in the setpoint for the specified/selected time period, is in the range. If the item is out of the range, it will be excluded from the calculation. If the item, which is used in the setpoint, has no value available for the specified period, it will also be considered as an item, which is out of the range.

By default this option will be unchecked. If this option is checked, but no working range has been set, a user will get the warning message asking to define the range.





## Custom Archives Import Tool

This tool enables users to access any available external archive (using any defined HDA driver) and periodically import its data (values) into the Dream Report internal database, which makes this data available for reporting from the standard Dream Report database.

To configure custom archive import, click on the command button *Custom Archive Import* on the **Tools** ribbon icon on the horizontal toolbar either in the Dream Report Logger Studio or Dream Report Designer Studio menu (see pic. below):

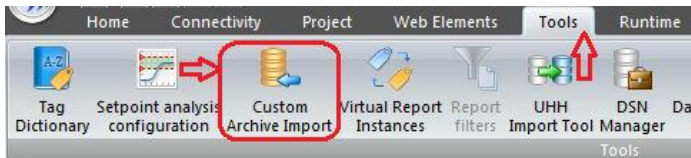

The **Custom Archive Import Tool Configuration** dialog window will be opened:

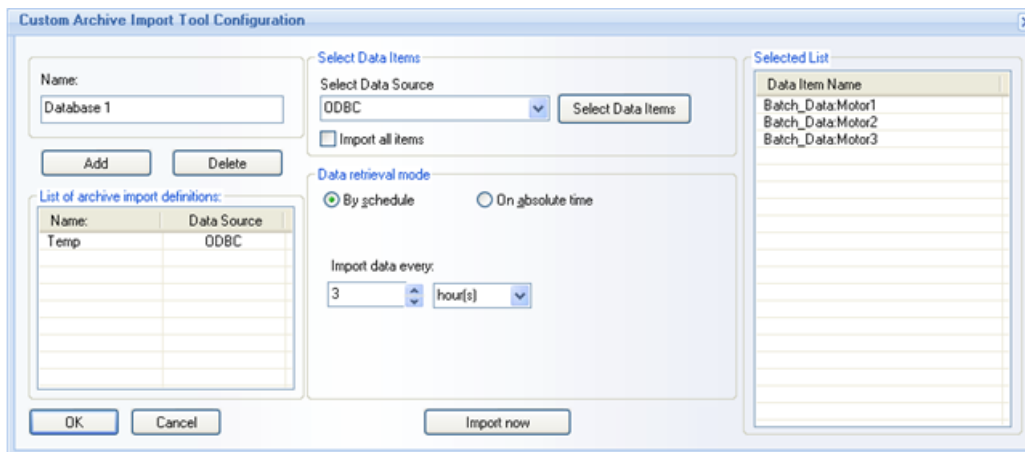

User can create one or multiple archive import definitions.

To *create a definition*, user has to:

1. Put a logical name of that import definition into the **Name** edit box. Import definition name is unique and can't be the same for multiple import definitions.
2. In the "**Select Data Source**" combo box, select required *History access data source*, which will point to the needed external archive.
3. Select data items, which values you need to import. To do it, click on "*Select Data Items*" button and the item selection window, where you can select all needed items, will be opened.

All the selected items will appear in the **Selected List** of Data item names.

If you want to import data from all data items, available at the data source, you don't need to open the item selection window. Just check the check box "**Import all items**" and Archive Import will import all values from all found items.

4. Set **Data retrieval mode**. It has 2 options: **by schedule** and **on absolute time**.

If **by schedule** radio button will be enabled, then, each defined period the archive import tool will connect to the external archive and import all new values (see the pic. above).

If **on absolute time** option is enabled, then, the archive import tool will connect to the external archive and import all new item values at an exact time specified in the combo box (see example below):



Data retrieval mode

By schedule  On absolute time

14:00:00

14:00:00

Add

Modify

Delete

5. Click on the button "*Add*".

Now the archive import definition is ready.

6. If user needs to import item values as soon as the archive import definition has been created, he can click *Import Now* directly in the Dream Report Studio and data archiving will be started.

**NOTE:** In order to launch data archiving immediately, the archive import definition must be first saved (by clicking "*OK*" button). Only then user can open **Custom Archive Import Tool Configuration** dialog window again and start data item import directly in the DR Studio.

### Functionality

When starting the runtime manager, it will detect that there are Archive Import definitions available and it will launch the **Archive Import Engine** (AIE). The AIE will launch a timer and each time, as soon as the period, defined in an archive import definition, has passed, the following operations will be performed:

AIE will check in the Dream Report database the last value and timestamp available with the data imported from that Archive import definition. If no data is available, AIE will know that it's the first import and all data available at external server will be imported into the Dream Report database. If AIE detects that some data is available, then it will import all data, available in the external server, starting from the timestamp of the last value, available in the Dream Report database and until the current (import) time. So, this way, if during any importing session the connection to the external server was not available, the data will not be lost. They will be automatically imported during the next session.

### Using Archive Imported data in reports

When user has added one or several archive import definitions, then, when selecting a list or real-time data source in every statistical objects the list of available data sources will contain both - the real-time data source and the list of archive import names. When a user selects an Archive Import definition as a data source, then browse of data items will display the list of all data items, selected for that archive import. Or, if Archive Import definition has "*Import all items*" enabled, then the list of all items, available at the external data source will be displayed in the item browse window.

**NOTE:** **Runtime configuration control options** ("**Run as service**" or "**Run as application**") can influence the performance of Custom Archive Import Tool (CAIT). If CAIT is launched via Runtime Manager and import is performed to/from SQL Server, please make sure that Runtime Manager is running under user who has an authorized access to SQL Server.



## Virtual Report Instances

**Virtual Report Instances** is a module, which enables to create multiple pre-defined instances of the same report template, where each instance will use the same template with different pre-defined tags. This will allow users to reduce the design time for cases where the same template should be used with different tags.

### Virtual Report Instance Configuration

User can create a **Virtual Instance**. It is one or multiple instance definitions, which includes the list of tags, used for that report instance, and the logical name for that definition.

To create **Virtual Instance**, click the right mouse button either on the context menu on report in the report list, or on the context menu on the report page in the **Report Designer** studio.

You can also click on the command button "**Virtual Report Instances**" on the **Tools** ribbon icon of the horizontal toolbar, or on the **Virtual Report Instances** command button on the vertical toolbar in the Dream Report Designer Studio menu (see pic.below):

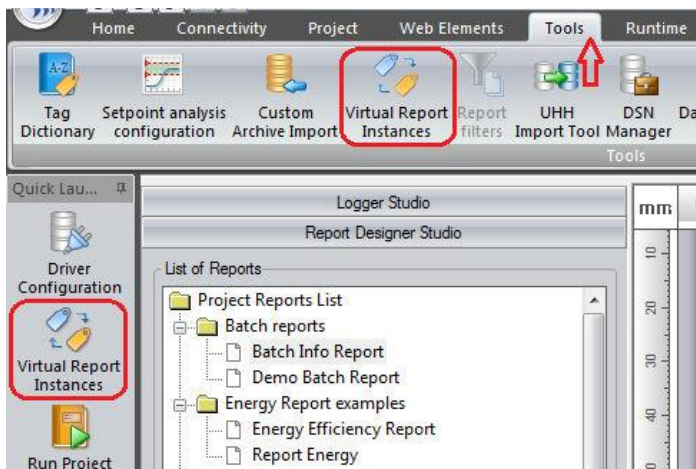

The **Virtual report instances** dialog window will be opened (see pic. below):

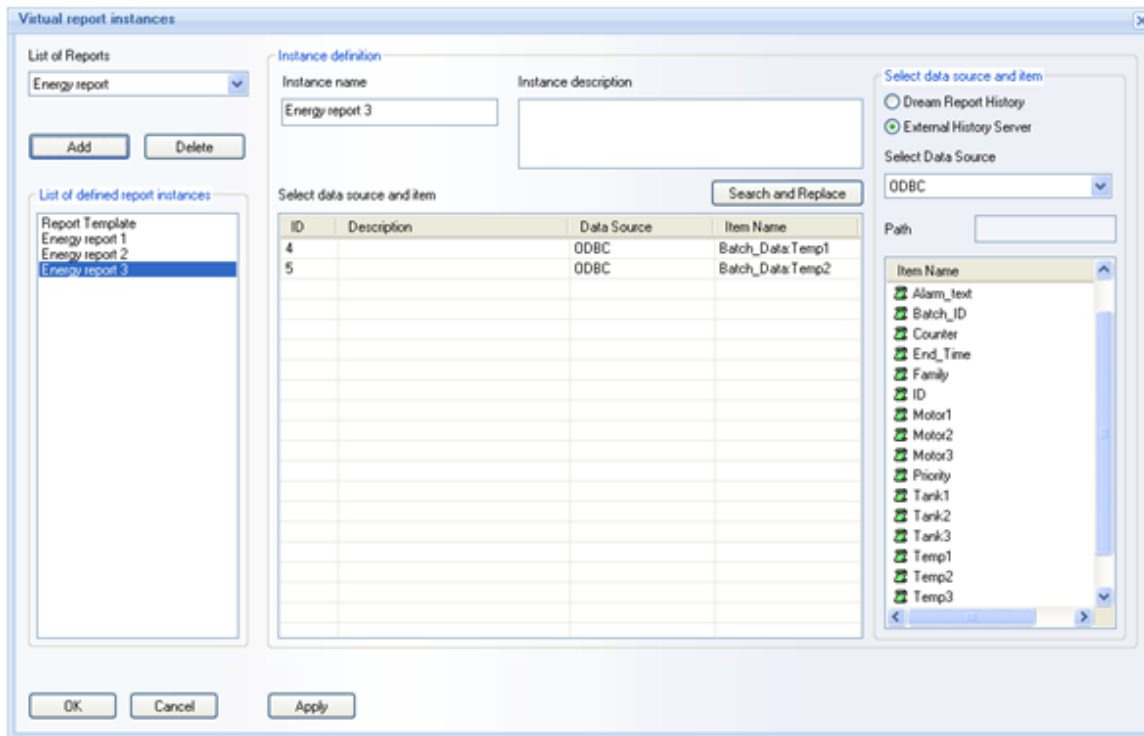

If a user opens this **Virtual report instances** window for report with no instances defined, then, this window will show the default instance entry with all originally defined tags. Any time, when user clicks on it, he will see the tag dictionary or just the list of tags, defined in that report.

If a user modifies tag descriptions or any tag in the default instance, and clicks **OK**, then, the popup message box will appear, asking *“You are about to change tag dictionary or replace one or several tags, used in that report. Do you want to continue? Yes/No”*. If a user clicks on **“No”**, all changes will be discarded. If **“Yes”**, then the tag dictionary of that report will be modified accordingly.

For details on how to define/ configure Tag Dictionary, please, see [Tag Dictionary](#) of this manual.

To *create a new instance*, in the **Instance definition** combo box user has to:

1. Enter **Instance name**, which has to be unique for that report.
2. Enter **Instance description** into the corresponding edit box (optional, not required).
3. Select required **data sources** and **items/tags** for each dictionary entry.
4. Click on **Add** button.

To *delete the instance*, user has to:

1. Select any defined instance in the list.
2. Click on the button **“Delete”**. Then a message box will appear, asking: *“Do you want to delete the virtual instance “...” ? (Yes/No)”*. If user clicks on **Yes**, the instance will be deleted.

To *modify existing instance*, user has to:

1. Select any defined instance in the list
2. Make required modification.



If you change selection to another instance or click [OK](#), changes will be automatically applied to the selected report.

The “[List of Reports](#)” combo box in the upper left corner of the window contains the list of all reports, available in the current project. The current selection will always show the report, that this window has been opened for.

If a user changes selection to another report, then the tag dictionary and instances configuration of another report will be opened here. However, all modifications, done for the previous report, will be not canceled. They will be stored in the memory. Only when the user clicks on [Apply](#), all current changes (to all reports) during this working session (since this window was opened), will be saved into the configuration file. By clicking [OK](#) all changes will be saved and the window will be closed. If a user clicks on [Cancel](#), then all changes will be ignored and the window will be closed.

All virtual instances configuration will be saved in the XML file “[rvi.xml](#)”. This file will be saved in the project folder and will contain all virtual instance definitions for all reports in the project.

### [Dynamic Token object](#)

The [Dynamic token object](#) will have a new entry in its combo box: “[Instance name](#)”. If it’s selected and the report is generated, its displayed value will be the name of a virtual instance, which was currently generated. If report is generated for generic template, then the string “Default” will be displayed.

### [Search and Replace](#)

Users can change data items by clicking [Search and Replace](#) button below the [Instance Description](#) edit box.

For details on how to find and replace data items, please, see the corresponding part of the [Tag Dictionary](#) section of this manual.



## DBatch

**DBatch module** enables users to log and track batch data and batch process data.

Due to the DBatch mechanism all batch information (including Batch ID, Batch start and end time, Batch process values) is logged into a special table in a project database and can be used further for reporting within Dream Report or can provide data to external applications.

To configure DBatch in the project you can click on the command button *DBatch Configuration* on the *Connectivity* ribbon icon on the horizontal toolbar in the Dream Report studio menu (see pic. below):

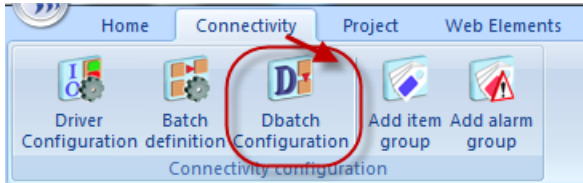

The "**DBatch Configuration**" dialog window will be opened (please see the picture below):

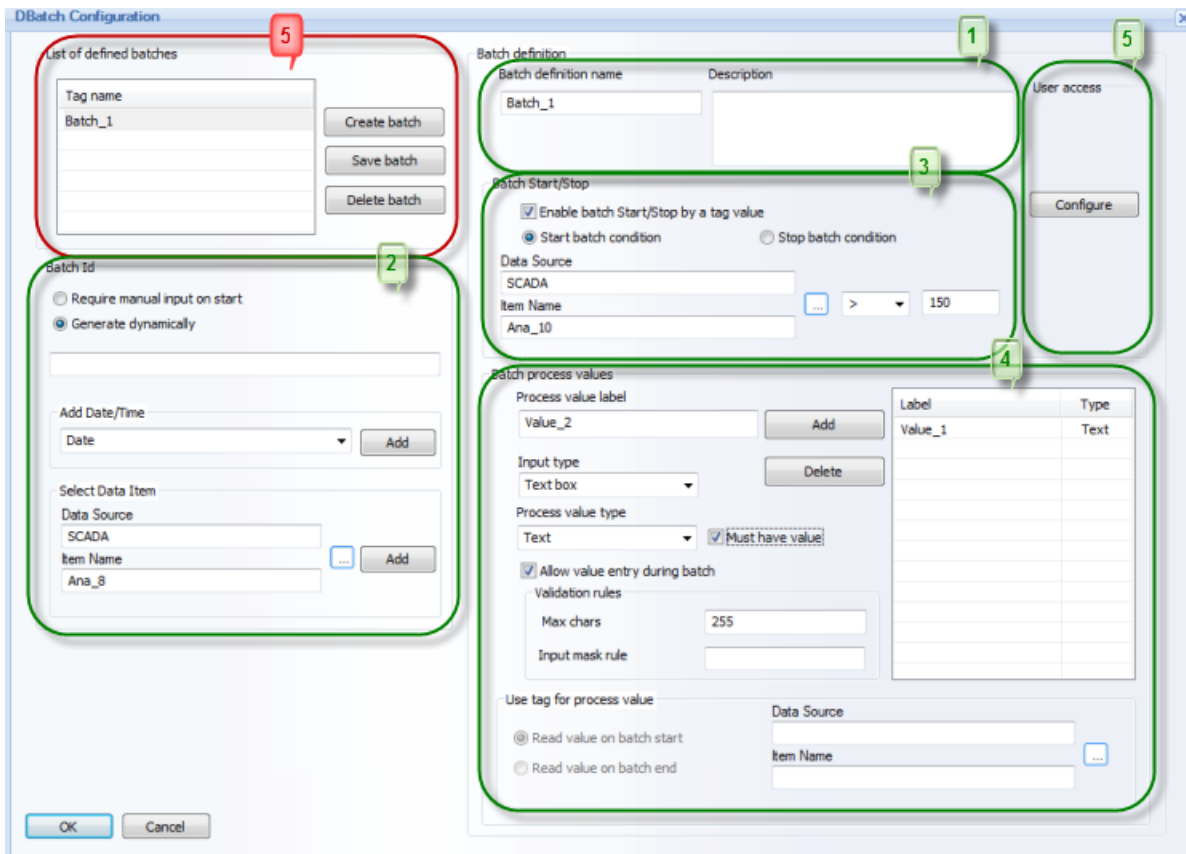

To configure Batch definition, please click on the "*Create batch*" button and a new batch definition will be added for configuration. By default each new batch definition will have the following names: **Batch\_1**, **Batch\_2**, etc.

### Batch Definition Configuration

Batch definition has the following properties to be configured:



1. **Batch definition name** (logical name of the batch definition) and **Description** (description of the batch) (please see the picture above);

2. **Batch ID**. There are 3 options for batch ID definition available: **Require manual input on start**, **Generate dynamically**, **Get Batch ID from a tag value** (please see the picture above).

- **Require manual input on start** – if this option is selected, then you will need to manually enter a new batch ID for the new starting batch. Otherwise you won't be able to start batch recording. No additional configuration is needed for this option.
- **Generate dynamically** – if this option is selected, the following configuration controls will be enabled (please see the picture below):

Batch Id

Require manual input on start

Generate dynamically

NNN"\_[DATE]"\_[!#SCADA.Ana\_2]

Add Date/Time

Date [v] [Add]

Select Data Item

Data Source

SCADA

Item Name [v] [Add]

Ana\_2

There are 2 options available for the dynamic generation of Batch ID:

a) **Generate dynamically** using a mask - a new batch ID will be generated automatically using a mask. In the edit box, please define a mask for automatic dynamic batch ID generation. A mask can contain:

- static text in double quotes,
- letters "N", i.e. numeric increment (starting from number "1");
- number of "Ns", i.e. number of digits that will be displayed (e.g. NNN will start numeric increment from 001);
- letters "A", i.e. increment by letters (starting from letter "A");
- number of "As", i.e. number of letters that will be displayed (e.g. AAA will start incrementing index from "AAA");
- Timestamp (**Date**, **Time**, **Date/Time**);
- Data Item (**Data Source/Item Name**).

b) **Get batch ID from a tag value** - below the radio button *Generate dynamically* in the "Select Data Item" section you can select a tag from any real-time data source. When a new batch is started, DBatch will read that tag value and use it as a batch ID.

3. **Batch Start/Stop** (rules for start/stop registration of batch data) (please see the picture above).

By default this can be done manually in real time using "Start"/"Stop" buttons in the DBatch runtime window (for details please see the "DBatch Runtime Window" section below).

You can enable automatic control of batch start/stop recording using a real-time tag value. To do this, please enable check box "Enable batch start/stop by a tag value" and select a tag ("Data Source/Item Name") and condition (=, !=, >, >=, <, <=) for batch start ("Start batch condition") and stop ("Stop batch condition") event.

**NOTE:** Tag browse will provide tags only from real-time data sources.



**4. Batch process values** (pre-defined list of process values related to the batch) (please see the picture above). Each process value can have a **Process value label** (logical ID), **Process value type** (numeric or text) and **Validation rules** (data validation). These parameters depend on the type of process value input (**Input type**). If you select "**Text box**" as an input type and **Text** as a process value type, then you will have to define maximum number of characters (**Max chars**) and the mask (**Input mask rule**) for those string values (please see the picture below):

Label	Type
Value_1	Text

If you select "**Text box**" as an input type and **Numeric** as a process value type, then you will have to define the minimum (**Min value**) and the maximum (**Max value**) values for those numeric values (please see the picture below):

Label	Type
Value_1	Numeric





## Ocean Data Systems

Check box “**Allow value entry during batch**” defines if edit box for the batch process value will be enabled or disabled during a batch (i.e. allow or restrict value change/entry when a batch is running).

If you select “**Real-time data source**” as an input type, then **Use tag for process value** check box will become enabled (please see the picture below):

Batch process values

Process value label  
Value\_1

Input type  
Real-time data source

Process value type  
Text  Must have value

Allow value entry during batch

Validation rules  
Max chars   
Input mask rule

Label	Type
Value_1	Text

Use tag for process value

Read value on batch start  Read value on batch end

Data Source  
SCADA

Item Name  
Ana\_8

Check box “**Use tag for process value**” enables to select a real-time tag, and then its real-time value will be used as an automatic value during batch process.

If “**Read value on batch start**” is selected, then when batch is started, the selected tag value will be read at the moment of batch start and will be filled into the parameter value edit box. Then, during batch process, it will be available for modifications.

If “**Read value on batch end**” is selected, then, when batch is ended, the selected tag value will be read at the moment of batch end and will be filled into the parameter value edit box and logged into the database.

After a new batch definition has been defined, click “**Save batch**” button to save this batch definition and to add it to the **List of defined batches**.

All configurations will be saved into the project database.

**NOTE:** When a new batch definition is added, its configuration will be first validated to check that all property options are filled correctly and there are no parameters which have empty value.

### 5. User Access

If you click on “**Configure**” button in the “**User access**” section, the following **DBatch User Access Configuration** window will be opened (see the pic. below):

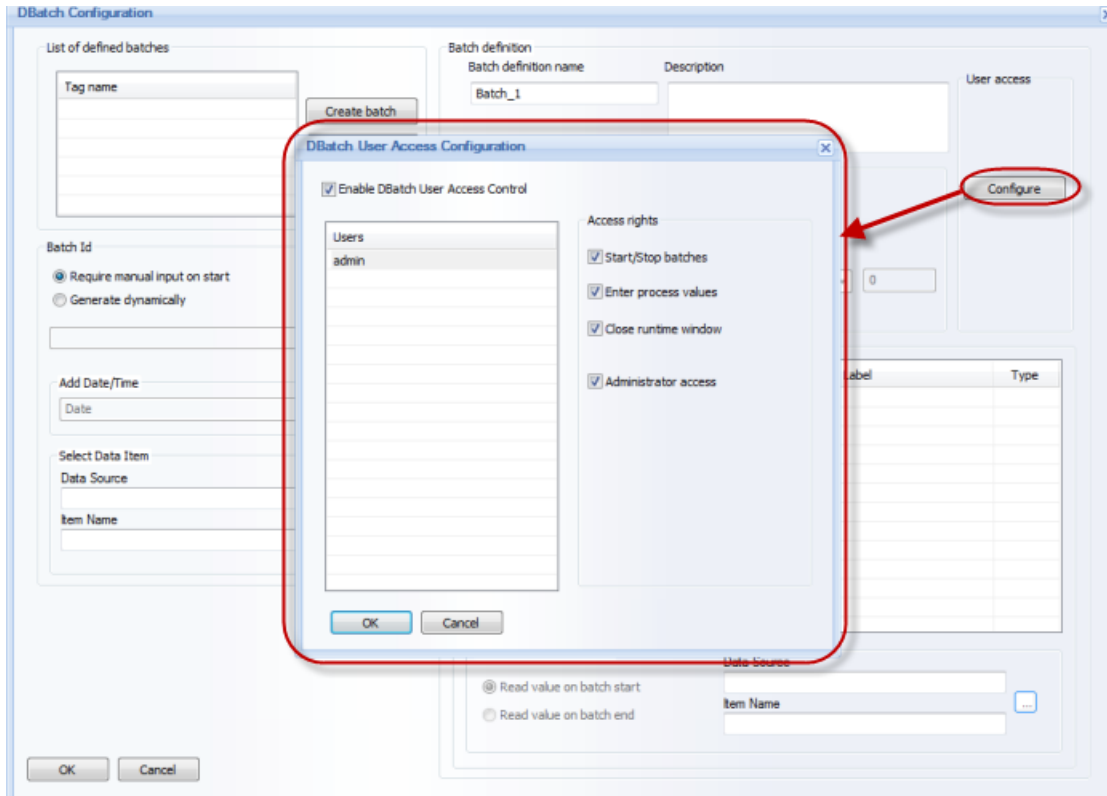

If check box **“Enable DBatch User Access Control”** is unchecked, then all other controls in this window (except for **OK** and **Cancel** buttons) will be disabled. On checking this check box all other controls will become enabled.

The **“Users”** list control will contain all users defined and/or used in the project. You can select a user from the **“Users”** list control and assign different access rights by checking the corresponding check boxes in the **“Access rights”** section. There are 3 options available: **Start/Stop batches**, **Enter process values**, **Close runtime window**. You can select **Administrator access** option and the user will automatically receive all DBatch access rights (i.e. **Start/Stop batches**, **Enter process values**, **Close runtime window**) and the corresponding access rights check boxes will automatically become checked.

**NOTE:** If user management is enabled in the project but no user with administrator rights has been defined, you won't be able to save DBatch user access rights configuration.

### DBatch Runtime Window

DBatch mechanism can also be managed via special runtime window. The **DBatch** runtime window can be launched from **“Start”** menu (please see the picture below):



## Ocean Data Systems

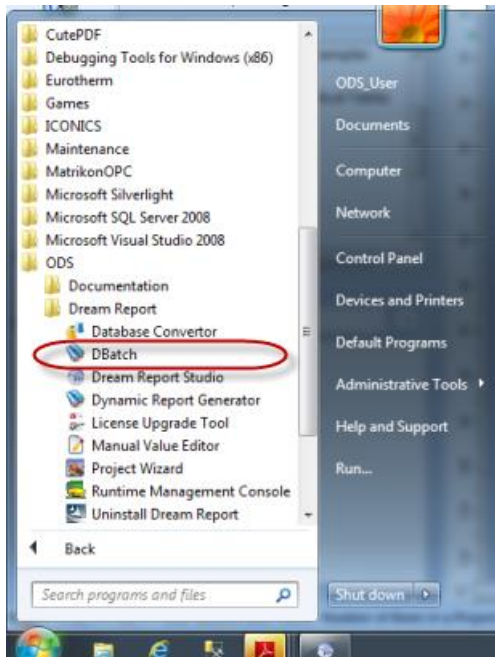

**DBatch** runtime window has the following design (please see the picture below):

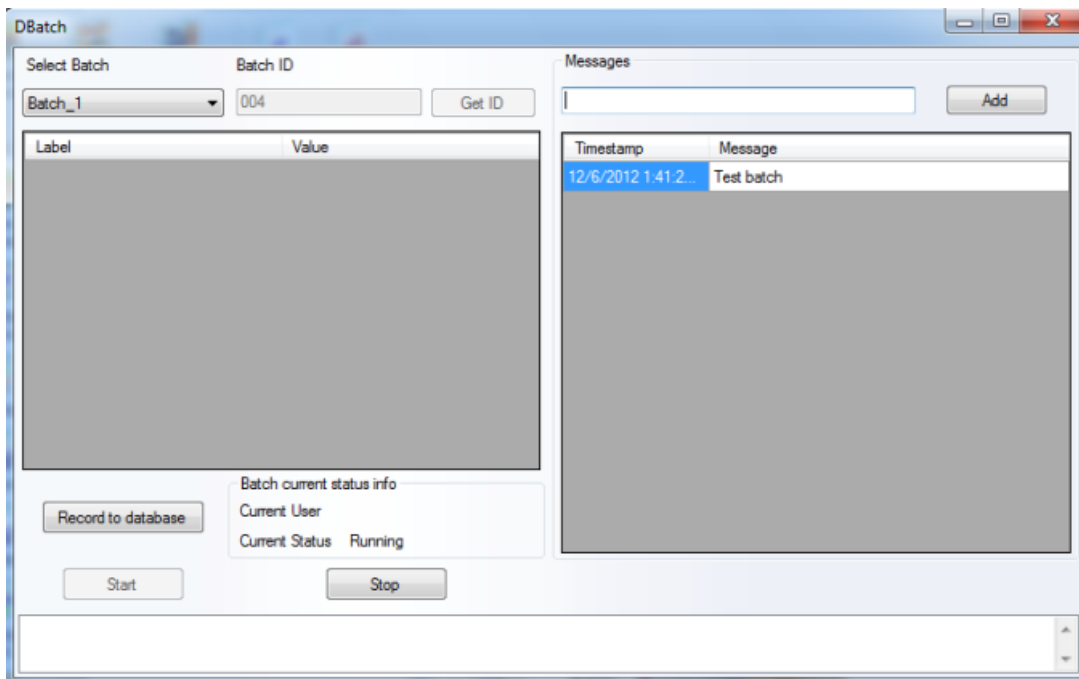

**DBatch** runtime window enables user to:

- Select batch definition from the pre-defined list (**Select Batch**).
- Get dynamic batch ID according to the defined rule by either entering Batch ID (**Batch ID**) or clicking on “**Get ID**” button.
- Check for the unique batch ID

When batch starts, before recording a new batch start, DBatch will check if batch ID, which is going to be used, already exists. If batch starts and input batch ID (either from user input or tag value or command line) already exists in the database, then DBatch will automatically increment it (adding `_1` in the end of the batch ID) and check that this incremented batch ID is unique. If “`<batch ID>_1`” already exists, then it will change increment to `_2` etc., so the



## Ocean Data Systems

unique batch ID will be preserved and, if batches are running with the same batch ID, which remains the same, DBatch will always check that every batch will be logged with the unique batch ID.

If no batch record is running, then button “*Stop*” will be disabled and “*Start*” will be enabled. When you click on “*Start*” button, batch recording will start. Button “*Start*” and “**Batch ID**” field will become disabled until this batch is stopped. When you click on “*Stop*”, batch recording will stop and batch info (**Batch ID, start time, stop time and process values**) will be recorded into the project database.

If DBatch has multiple batch definitions running, then if batch is running for a current batch definition and you change batch selection for another batch definition, the DBatch runtime window will display the status of a new selected batch definition. Multiple batch definitions will be enabled in the same window simultaneously.

If you change process values during batch, the project database will also be changed. Values will be considered only on batch stop moment and will be recorded into the database only at that moment of batch stop.

### Command line control

DBatch provides users with a possibility to control it from a command line. The format of the command line is the following:

```
“dbatch.exe -batchDef <name of batch definition> -command <”start” or “stop”> -batchID <”batch Id”>”
```

You can also pass process values using the following command line format:

```
“dbatch.exe -param <parameter name> -value <value>”
```

### DBatch historical values driver

**DBatch historical values** driver enables users to connect directly to a special project batch database and use its data for reporting within Dream Report or in external applications. The project batch database is created when the DBatch mechanism (described in this section above) is configured. Then the DBatch historical values driver will be configured automatically and you will not need any additional configuration in the Communication Configuration Wizard (please see the picture below):

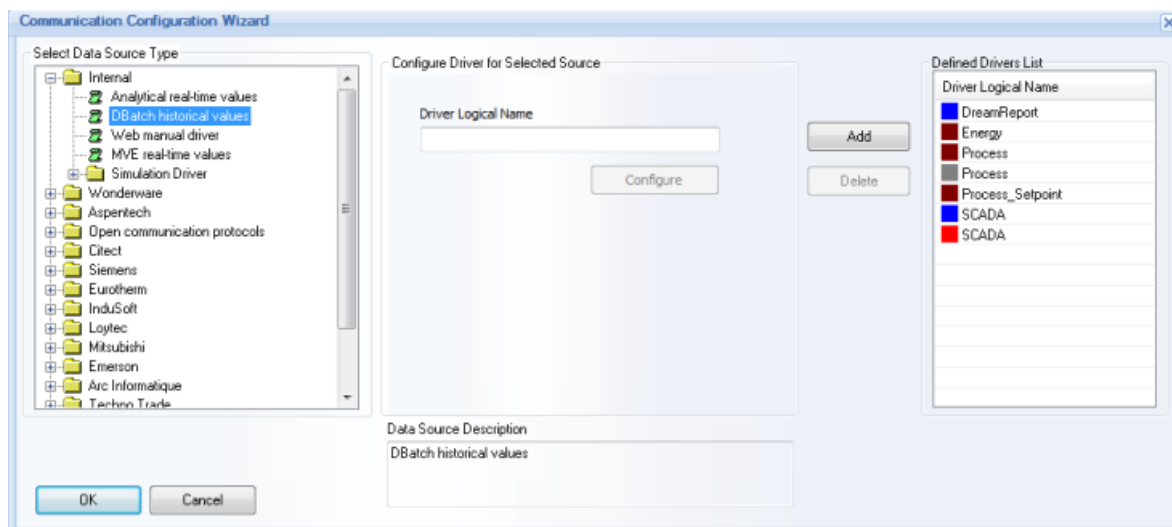



## Database Archiving

**Database Archiving** enables users to perform periodic archiving of internal Dream Report database and to automatically manage that archiving library.

This functionality enables automatic transfer of aged data from the main database to an archive in order to reduce the main database size and improve data logging and report generation performance.

To configure database archiving you can click on “*Advanced Options*” button in the “**Database Definition**” dialog of Project Settings (see [Database Configuration](#) section of this manual).

Or you can click on the command button *Database archiving configuration* on the **Tools** ribbon icon on the horizontal toolbar in the Dream Report studio menu (see pic. below):

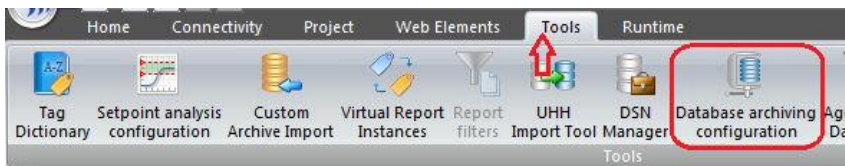

The “**Database archiving configuration dialog**” window will be opened (please see the picture below):

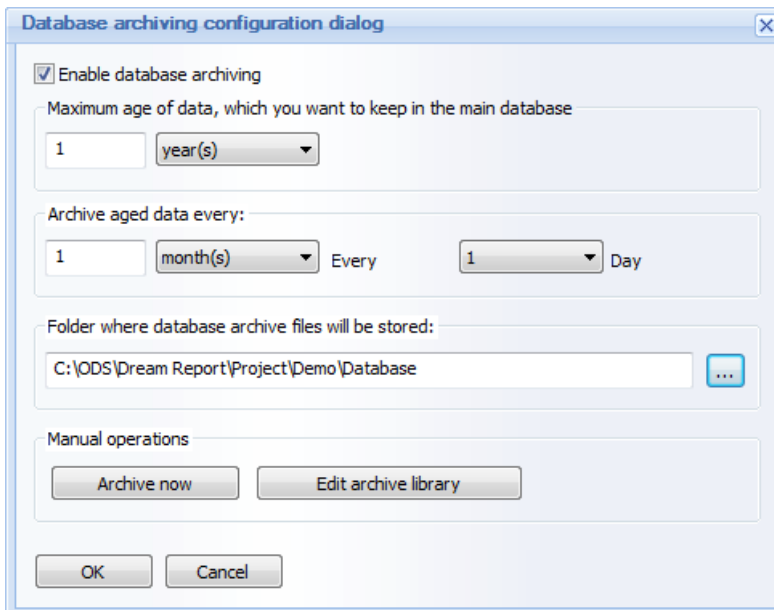

By default database archiving configuration will be disabled (all configuration dialog box controls will be also disabled except for **OK** and **CANCEL** buttons). If the “**Enable database archiving**” check box is checked (thus enabling database archiving), all configuration dialog controls will also become enabled.

### Database Archiving Configuration

To configure database archiving all configuration dialog controls need to be defined (as explained below):

**Maximum age of data which you want to keep in the main database** section enables to define maximum data age to be kept in the project main database.

In the edit box, please enter any unsigned integer number (between 0 to 5000) and in the combo box with time units select one of the following entries: “**Day(s)**”, “**Month(s)**” or “**Year(s)**”.

The default value is: “**1 year(s)**”.



**Archive aged data every** section enables to select frequency and schedule of performing archiving operation.

In the edit box, please enter any unsigned integer number (between 0 to 5000) and in the combo box with time units select one of the following entries: “**Day(s)**”, “**Month(s)**”, “**Year(s)**”.

The default value is: “**every 1 month(s)**”. The default date is “**1 Day**”.

When any of the time units has been selected, you can define schedule for the performance of archiving operation:

- If in the time unit combo box the “**Day(s)**” option is selected, then in the time picker edit box (see the picture below) you can select time (hour and minutes) when every selected number of days the archiving operation will be performed:

Archive aged data every:  
1 day(s) Every 11:11:31 AM

- If in the time unit combo box the “**Month(s)**” option is selected, then in the combo box (see the picture below) you can select a day of month (with numbers from 1 to 31) when every selected number of months archiving operation will be performed:

Archive aged data every:  
1 month(s) Every 3 Day

- If in the time unit combo box the “**Year(s)**” option is selected, then in two combo boxes (see the picture below) you can select a day of the month and month when every selected day of the month the archiving operation will be performed:

Archive aged data every:  
1 year(s) Every 10 April

**Folder, where database archive files will be stored** section enables you to select a folder where database archive files will be located.

The default folder is: <**Project database folder**>.

When clicking on the “...”(browse) button, the standard “**Browse for folder**” dialog window will be opened. Select a folder where database archives will be stored.

As soon as this folder has been defined, user can open and change the folder according to his needs. if the archive folder is changed, Dream Report will not automatically copy all archive files, existing in the previous folder to the new folder (it will have to be done by the user). Dream Report will only start looking for archive files folder during the next operation.

**Manual operation** section allows you to perform one of the following manual operations:

1. trigger archiving operation immediately (click on the “**Archive now**” button to trigger the archive operation);
2. manually register new archive files immediately. To do this, please click on the “**Edit archive library**” button. The “**Database archive files library**” edit window will be opened:





## Aggregated Data Filter

**Aggregated Data Filter** enables Dream Report to connect to any external history (HDA) data source, and not only to retrieve all values as an array of raw values, but to do smart data retrieval (i.e. extract key values, aggregated values etc.). This mechanism allows smart aggregation extraction from any custom proprietary data source (e.g. binary files etc.).

To configure an aggregated data filter, click on the command button **Aggregated Data Filter** on the **Tools** ribbon icon on the horizontal toolbar either in the Dream Report Studio menu (see pic. below):

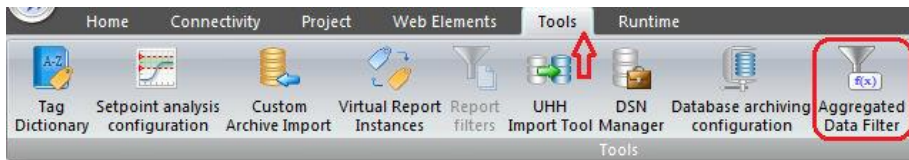

The **"ADF Configuration"** dialog window will be opened (please see the picture below):

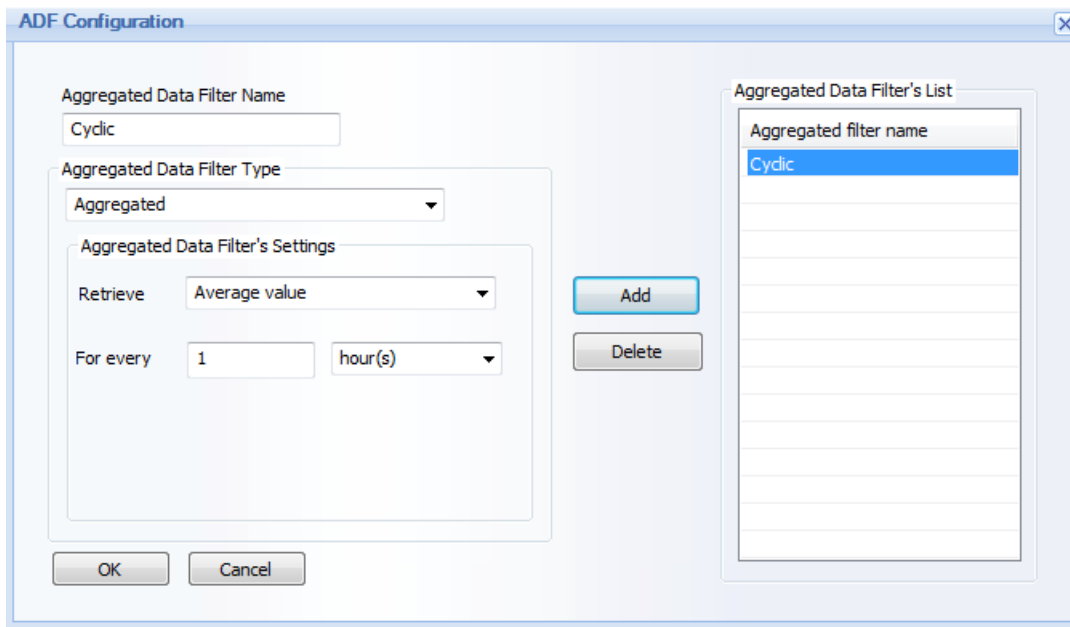

**"Aggregated filter name"** edit box of the **"Aggregated Data Filters List"** section will contain the list of all aggregated data filters (ADFs) defined in the project.

To configure ADF user will have to:

1. Enter ADF Name (**"Aggregated Data Filter Name"**);
2. Select ADF type (in the **"Aggregated Data Filter Type"** combo box). There are 2 options available: **"Sample based"** and **"Aggregated"**.
  - If **"Sample based"** mode is selected, then, please:
    - a) in the **"Retrieve"** combo box select among the available options (**"First"**, **"Last"**, **"Key"** and **"Distributed"**) which values should be retrieved;
    - b) in the **"Samples"** edit box enter a number of samples (whole non-zero numeric value);
    - c) in the **"For every"** combo boxes select step period for data retrieval (please see the picture below):



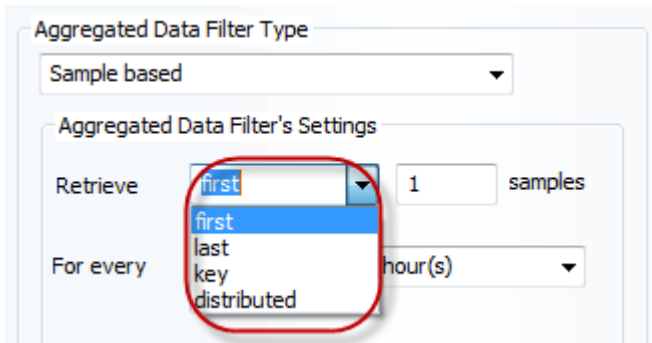

Step period for data retrieval can have the following options: “**second(s)**”, “**minute(s)**”, “**hour(s)**”, “**day(s)**”, “**week(s)**”, “**month(s)**”, “**year(s)**”.

- If “**Aggregated**” mode is selected, then, please:
  - a) in the “**Retrieve**” combo box select statistical function which will be calculated for every defined period. Statistical function selection has the following statistical functions available: “**First Value**”, “**Last Value**”, “**Maximum Value**”, “**Minimum Value**”, “**Integral Value**”, “**Weighted Average Value**”, “**Average Value**”, “**Sum Value**” and “**Moved Average Value**” (for details on the definition of each of these statistical functions, please go to the [Single Data Object](#) section of this manual);

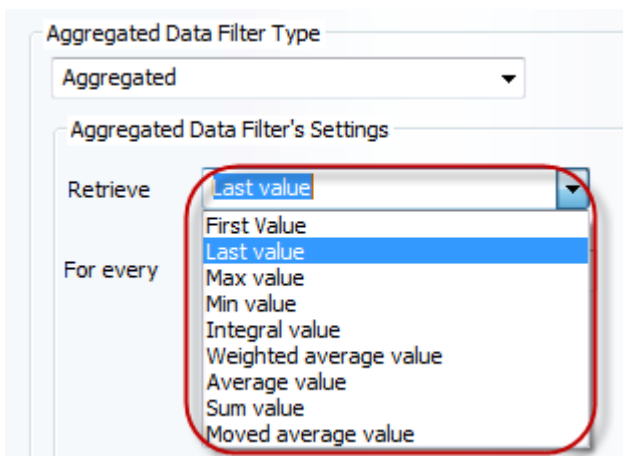

b) in the “**For every**” combo boxes define time period. Time period unit has the same options as the step period data retrieval option described above, i.e.: “**second(s)**”, “**minute(s)**”, “**hour(s)**”, “**day(s)**”, “**week(s)**”, “**month(s)**”, “**year(s)**”

3. Click on the button “**Add**” and the new filter will be added to the [Aggregated Data Filters List](#).

All project ADF filters list will be saved in the project database.



## ADF Functionality Performance Overview

ADF functionality works as follows:

1. Any HDA driver should be configured for the project.
2. "Aggregated data filter" should be defined for that project (in the ADF configuration the data retrieval mode is selected).
3. When designing reports, any tag in any object can be selected and ADF can be applied to this tag ("**ADF to be used**" option in the Designer Studio data objects).
4. During report generation, ADF will be used to get aggregated data and will perform statistical calculation on that aggregated data (and not on raw values).



## Multi-Tag Aggregation

**Multi-Tag Aggregation** allows Dream Report statistical objects to perform operations not only with one tag, but to perform operations with arrays of values from different tags. Once a Multi-tag Expression (MTE) has been created, it can be used in any chart, table or item field. For example, there might be a requirement to plot a “total quantity on hand” of four storage tanks over the course of a week. You could create an MTE named “QtyOnHand”, with the expression (T1\_Level + T2\_Level + T3\_Level + T4\_Level), and then reference this expression for a pen on a Line Chart. Additionally, you can apply an Aggregated Data Filter (ADF) when configuring the Multi-tag expression. In the above example, if the requirement was to plot the daily average quantity on hand for the four storage tanks, you would create the above MTE, and include an ADF of “1 Day Average” applied to the expression.

### Multi Tag Aggregation Configuration

To configure Multi-tag expressions, click on the “**Multi Tag Aggregation**” command button on the “**Tools**” ribbon icon on the horizontal toolbar in the Dream Report Studio menu (see picture below):

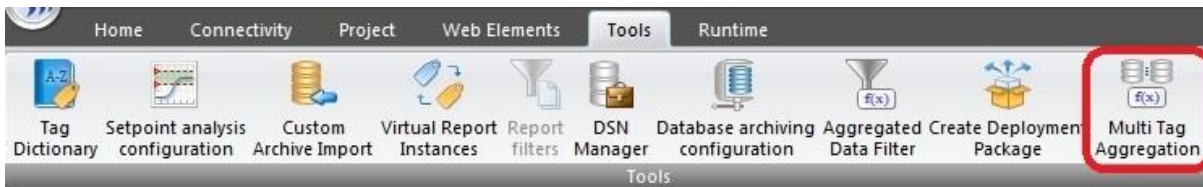

The “**Muti-tag Expression**” dialog will open:

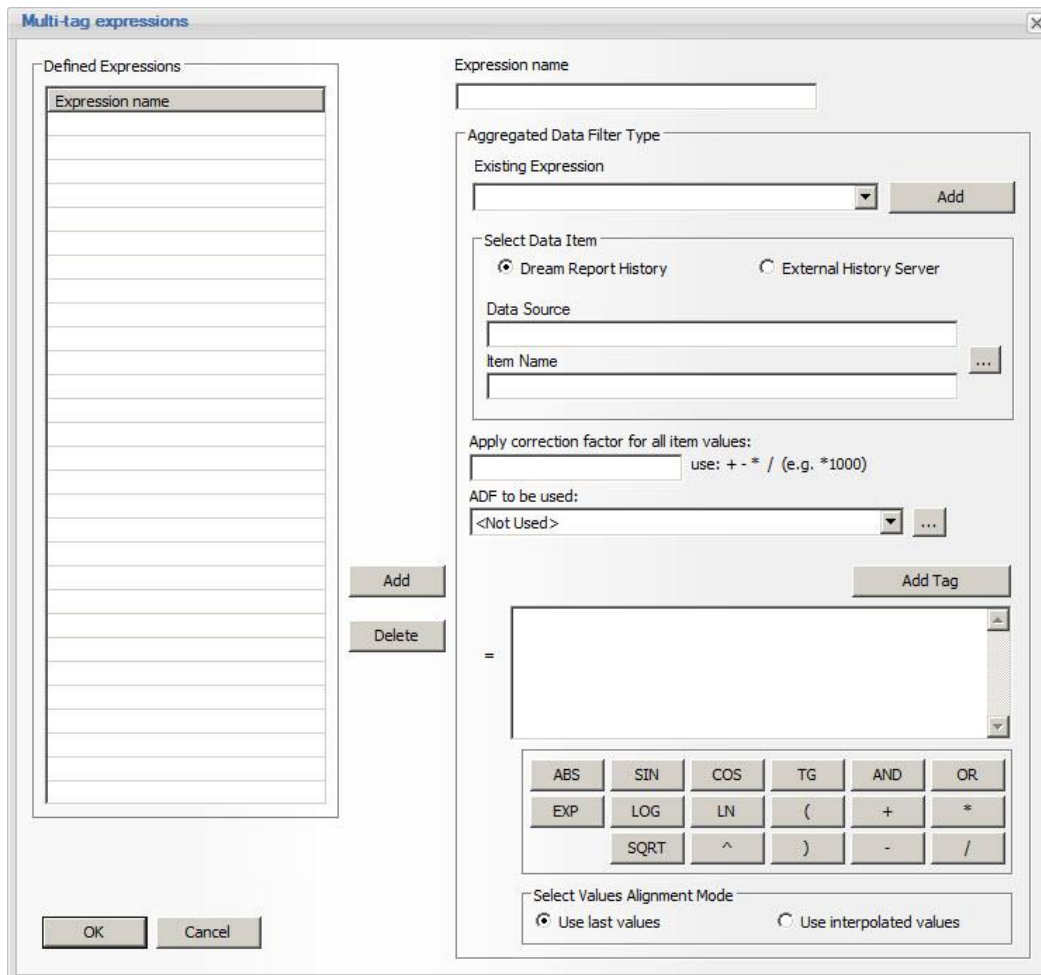



Enter an **Expression Name**, which must be a unique name which describes the expression.

The **Existing Expression** option allows users to select an existing expression from any report, or an existing MTE to the new Multi-tag expression. To use this, choose an object from the list-box and click, the **Add** button. The object name will be added to the expression edit box. The selected dynamic object will be added in the format of [f#<Field Name>] or [arr#MultiTagAggregation.<MTENAME>#HDA].

The **Select Data Item** section allows the user to select and add any data item from any available data source to the expression. Click the **Add Tag** button to add the selected item to the expression in the format [arr#<item name>]. When calculating the result for the expression, Dream Report will get the value of the data item and replace [arr#<item name>] with that value. To add mathematical or logical operators, click on the appropriate button and it will be added to the expression. The calculation expression can be edited manually as well, directly in the expression edit box.

**Apply correction factor for all item values** enables adding a simple expression to all tag values, before they are used in the calculation expression. For more details, please, refer to the **Correction Factor** section.

**ADF to be used** enables the user to select an aggregated data filter to be applied to the expression. "ADF to be used" combo box will contain all ADF definitions configured in the project. The default string will be "Not Used", i.e. no filter (ADF) is applied.

For details on ADF definition/configuration, please go to the **Aggregated Data Filter** section of this manual. Once an ADF has been applied to the Multi-value expression, the expression will be calculated over the time interval defined in the ADF, with the sampling/aggregation rule applied.

**Select Values Alignment Mode** enables the user to select whether the MTE should **Use Last Value** for the MTE calculation period (e.g., if a daily aggregate, and the last value was logged at 23:30, use that value) or **Use Interpolated values**.

Once the Multi-tag expression has been created, click the **Add** button to add it to the list of Defined Expressions. You can define as many expressions as are needed in the project. Click the **OK** button to close the Multi-tag Expressions dialog.

### To use a Multi-tag Expression in a Reporting Object

Once a Multi-tag Expression (MVE) object has been defined, it can be used in an Item field, Step table, Chart, Bar, Pie, or Automatic Statistical Table. In the **Select Data Item** section of the reporting object, select the **External History Server** option, and then select **MultiTagAggregation** in the list of available data sources. Select the desired MTE from the list of defined expression:

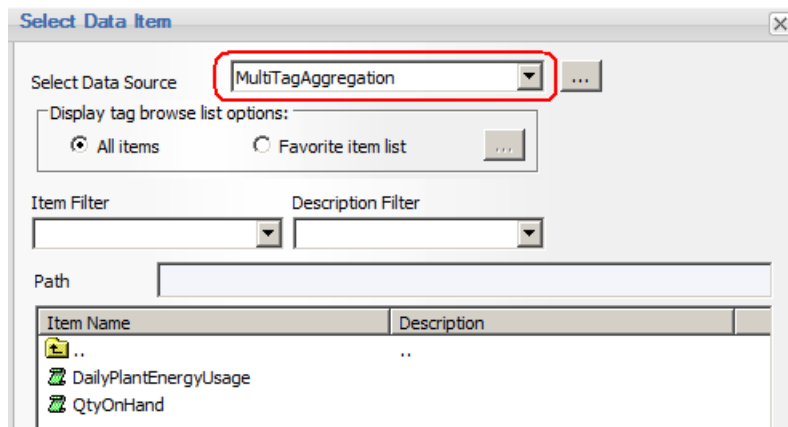

Once selected, the MTE will be used as if it were a single data item in the report object - e.g., plotted in a Line Chart, aggregated in an Automatic Statistical Table, etc.



## Tag Helper (Tag Selection)

**Tag Helper** is a new module that allows users to pre-select tags, which will be very often used in a reporting project, and then to select tags for reporting objects from this pre-selected list. This function will help users to avoid selecting tags from thousands of tags from the server and save a lot of engineering time.

**NOTE:** This option works only with historical drivers and is not relevant to DA drivers as DA items browse already shows the list of tags used only for logging.

If user has selected an HDA (**External History Server**) driver in any object, the following "**Select Data Item**" (tag selection) window will be opened:

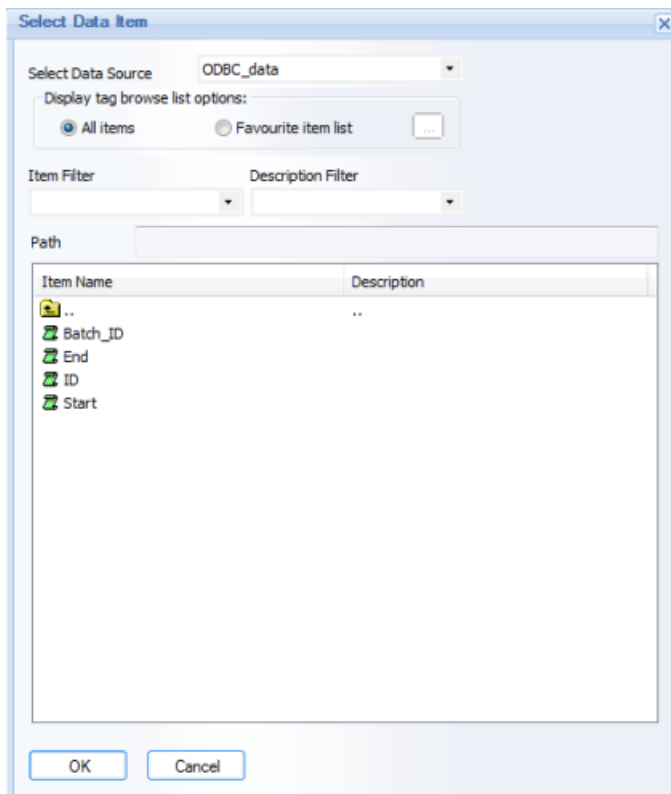

It has two radio-buttons: "**All tags**" and "**Favorite tag list**". The default selection is: "**All tags**". When this radio-button is selected, then the items browse will work as in the standard "**Select Data Item**" window.



If the "Favorite tag list" radio-button is selected, then:

- first, the small button "...", next to the radio-button, will become enabled. When the "Favorite tags list" option is selected, the item (Item Name) browse will display only the list of pre-selected tags for the selected data source (please, see the pic. below):

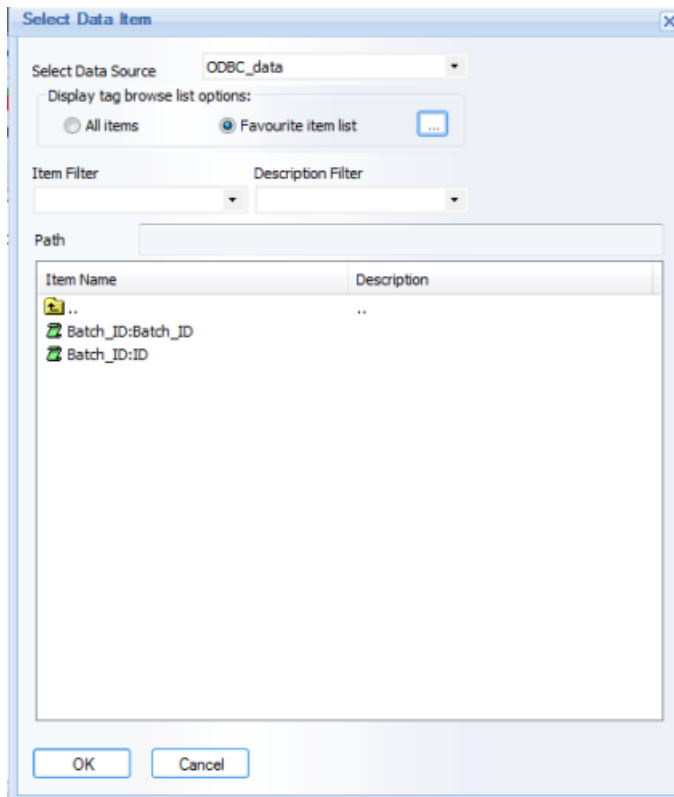

- to pre-select favorite tags, user will click on the "..." button and the standard Dream Report multi-tag selection (Select Data Items) window will be opened (please, see the pic. below):

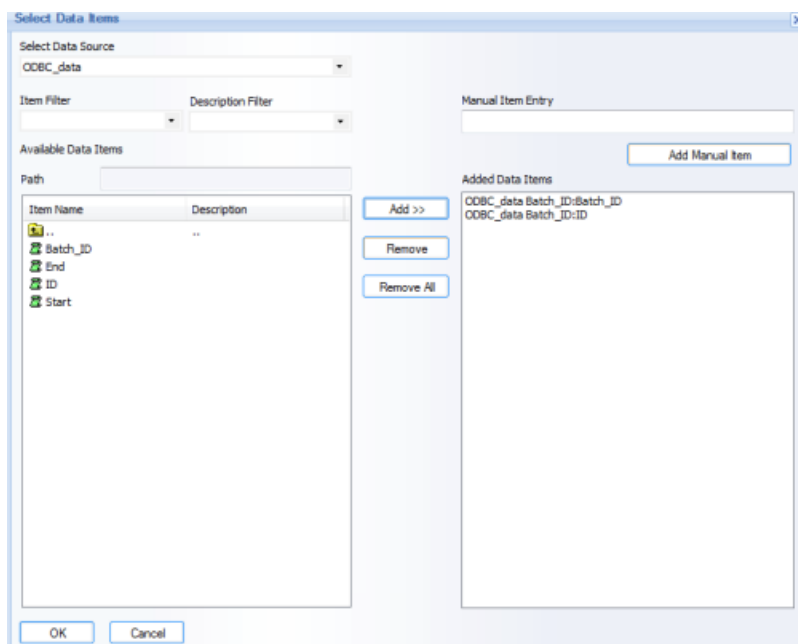



## Ocean Data Systems

This window will automatically select the driver, which has been selected in the "Select Data Item" (tag selection) window. User will be able to select any other HDA driver, defined in the project, and pre-define the list of favorite tags for all defined/required data sources in the same window, without closing and re-opening it. (If the "Select Data Item" (tag selection) window has no driver selected yet, then the "Select Data Items" (multi-tag selection) window will have no driver selected as well).

- When user will close the "Select Data Items" (multi-tag selection) window and select "Favorite tags list" in the "Select Data Item" (tag selection) window, the tag browser ("Item Name") will not display all the entire list of tags from the data source, but will display only the list of pre-defined tags (please, see the pic. below):

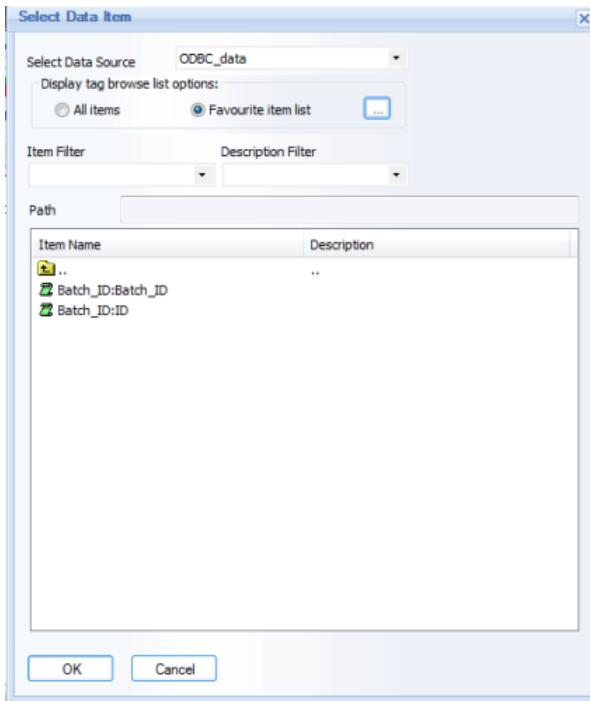

**NOTE:** This option will also be available in the "Select Data Items" (multi-tag selection) window (please, see the pic. below):

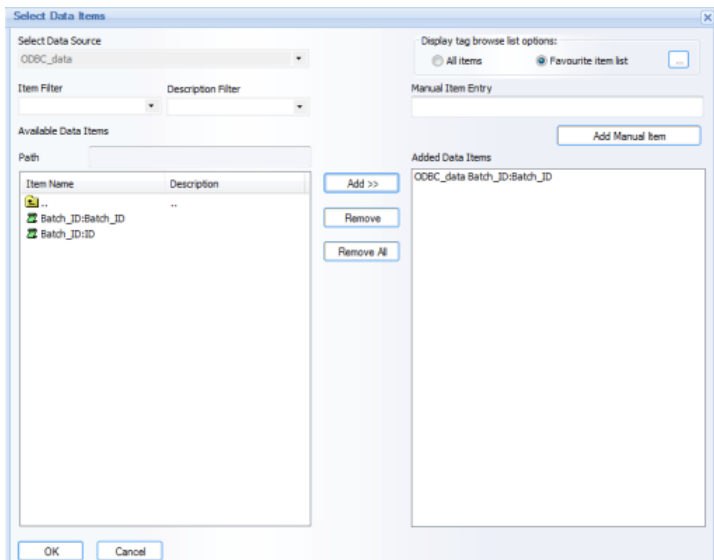



## Pivot Groups

The **Pivot Group** function provides user the ability to repeat one or several objects (group) for pre-defined steps (time sub-periods or other conditions) on a report. This functionality is similar to a **Step Table**, However, while a Step Table can repeat lines ("steps") with predefined calculations for each time-sub-period, (Step) **Pivot Groups** will repeat complete a group of objects for each predefined step.

### Examples

One example of using a Pivot Group is if you need to repeat an entire chart or table for each day of a week, with each chart or table only showing data/calculations for each day (the "step") over the report period. Another example might be to display detailed batch report data for every batch over the past month - in this case, the group's time period would be the last 1 month, and the step period will be by batch.

### Configuring a Pivot Group

To configure a **Pivot Group**, in Designer Studio, select one or more objects on a report, and right-click to open the **Context Menu**. Select the option "**Create Pivot Group**":

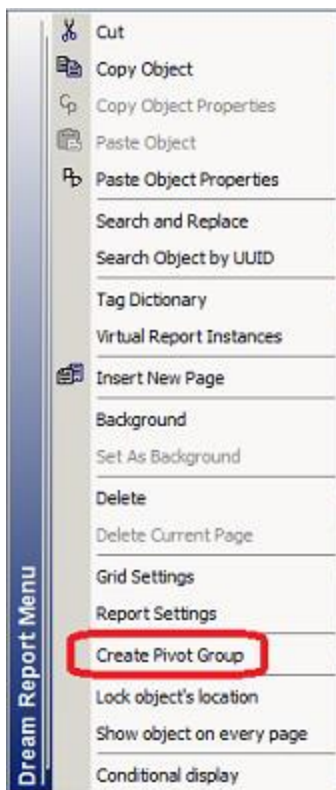

The following **Pivot Group** configuration window will open:





Enter the **Group Name** (must be unique to that report) and an optional **Description**.

The **Time Period** and **Step Period** work in a similar manner to the way in which they work in a [Step Table](#). The **Time Period** parameter defines the overall time period over which the **Pivot Group** will operate. In the Batch example above (analysis by batch over the past month), the Time Period might be defined as a "*Fixed Period*" for the "*Last 1 month(s)*".

The **Step Period** can be based on one of the following options:

- **Time Based** - behaves the same as in a Step Table
- **Batch Based** - behaves the same as in a Step Table
- **SQL Period Based** - this mode will retrieve step periods from the results of a SQL query:

- Click the **Edit SQL Query** button to open the [SQL Query Definition](#) window.
- Create a SQL query in which each row returned by the query will contain a start and end period (according to the SQL mapping - see below). For the time period returned in each row of the SQL query, a new step group will be created at report generation.
- Click the **SQL Map Parameters** button to map fields from the SQL query to be used to define the step period:

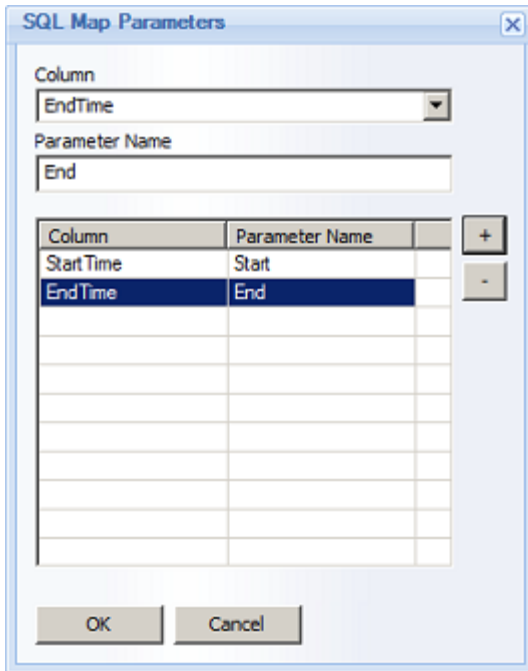

The "Enable display on condition" option will be unchecked by default for a new **Pivot Group**. This means that, by default, the **Pivot Group** will be visible on the report at generation time. Check the "Enable display on condition" if you wish to set the conditional display for the group. Click the "Select Dynamic Token ..." button to select any Single Data object on the report, the evaluation type (=, >, <, !=, >= or <=) and then set the value to be evaluated against. If you require a **Pivot Group's** visibility to be set by **multiple conditions**, you would use an Expression or Compound data object to evaluate/calculate the conditions, and then reference that object in the conditional display.

If you wish to **remove (ungroup) a Pivot Group**, select the group, and right-click to open the Context Menu. Select the option "**Ungroup Pivot Group**". Please note that when you ungroup a **Pivot Group**, all group settings will be removed.



## Pivot Tables (SQL Table Row Grouping)

The **Pivot Table** function provides the user the ability to perform **Group By** operations in the **SQL Table** object, displaying "data blocks" for each grouped data sub-set, as well as intermediate aggregations (on sub-groups) for such groups. For example:

Batch ID	Tank Family	Batch Start	Batch End	Temp1	Temp2	Temp3	
Batch_477	Tank2	6/22/2015 12:00:00 PM	6/26/2015 11:59:58 AM	94.00	100.00	80.00	
		6/22/2015 12:00:00 PM	6/26/2015 11:59:58 AM	95.00	90.00	95.00	
		6/22/2015 12:00:00 PM	6/26/2015 11:59:58 AM	97.00	70.00	100.00	
		6/22/2015 12:00:00 PM	6/26/2015 11:59:58 AM	94.00	100.00	80.00	
		6/22/2015 12:00:00 PM	6/26/2015 11:59:58 AM	97.00	70.00	100.00	
	<b>Tank Avg:</b>				<b>95.40</b>	<b>86.00</b>	<b>91.00</b>
	Tank1	6/22/2015 12:00:00 PM	6/26/2015 11:59:58 AM	96.00	80.00	99.00	
		6/22/2015 12:00:00 PM	6/26/2015 11:59:58 AM	94.00	100.00	80.00	
		6/22/2015 12:00:00 PM	6/26/2015 11:59:58 AM	95.00	90.00	95.00	
		6/22/2015 12:00:00 PM	6/26/2015 11:59:58 AM	97.00	70.00	100.00	
		6/22/2015 12:00:00 PM	6/26/2015 11:59:58 AM	95.00	90.00	95.00	
	<b>Tank Avg:</b>				<b>95.40</b>	<b>86.00</b>	<b>93.80</b>
	Tank3	6/22/2015 12:00:00 PM	6/26/2015 11:59:58 AM	96.00	80.00	99.00	
		6/22/2015 12:00:00 PM	6/26/2015 11:59:58 AM	96.00	80.00	99.00	
<b>Tank Avg:</b>				<b>96.00</b>	<b>80.00</b>	<b>99.00</b>	
<b>Batch MIN:</b>				<b>94.00</b>	<b>70.00</b>		
<b>Batch MAX:</b>				<b>97.00</b>	<b>100.00</b>		
Batch_478	Tank1	6/26/2015 12:00:00 PM	6/29/2015 03:59:58 PM	94.00	100.00	80.00	
		6/26/2015 12:00:00 PM	6/29/2015 03:59:58 PM	94.00	100.00	80.00	
	Tank2	6/26/2015 12:00:00 PM	6/29/2015 03:59:58 PM	95.00	90.00	95.00	
		6/26/2015 12:00:00 PM	6/29/2015 03:59:58 PM	97.00	70.00	100.00	
	<b>Tank Avg:</b>				<b>96.00</b>	<b>80.00</b>	<b>97.50</b>
	Tank3	6/26/2015 12:00:00 PM	6/29/2015 03:59:58 PM	96.00	80.00	99.00	
		6/26/2015 12:00:00 PM	6/29/2015 03:59:58 PM	96.00	80.00	99.00	
<b>Tank Avg:</b>				<b>96.00</b>	<b>80.00</b>	<b>99.00</b>	
<b>Batch MIN:</b>				<b>94.00</b>	<b>70.00</b>		
<b>Batch MAX:</b>				<b>97.00</b>	<b>100.00</b>		
Batch_479	Tank3	6/29/2015 04:00:00 PM	7/3/2015 06:59:58 AM	94.00	100.00	80.00	
		6/29/2015 04:00:00 PM	7/3/2015 06:59:58 AM	96.00	80.00	99.00	
	<b>Tank Avg:</b>				<b>95.00</b>	<b>90.00</b>	<b>89.50</b>
	Tank1	6/29/2015 04:00:00 PM	7/3/2015 06:59:58 AM	94.00	100.00	80.00	
		6/29/2015 04:00:00 PM	7/3/2015 06:59:58 AM	94.00	100.00	80.00	
	<b>Tank Avg:</b>				<b>94.00</b>	<b>100.00</b>	<b>80.00</b>
	Tank2	6/29/2015 04:00:00 PM	7/3/2015 06:59:58 AM	95.00	90.00	95.00	
6/29/2015 04:00:00 PM		7/3/2015 06:59:58 AM	97.00	70.00	100.00		
<b>Tank Avg:</b>				<b>96.00</b>	<b>80.00</b>	<b>97.50</b>	
<b>Batch MIN:</b>				<b>94.00</b>	<b>70.00</b>		
<b>Batch MAX:</b>				<b>97.00</b>	<b>100.00</b>		

### To Configure Data Grouping:

1. Add and configure the SQL Query Table object with a SQL query. When you click on the "Appearance" tab, you will have the option to configure data grouping:

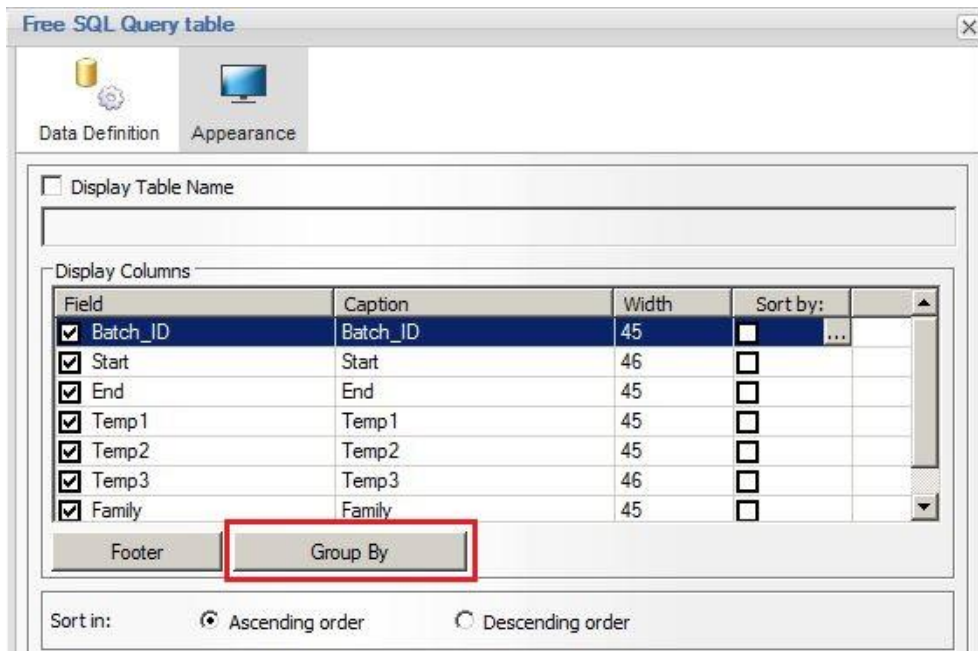



## Ocean Data Systems

- Click the "Group By" button to open the **Group By Configuration** dialog box:

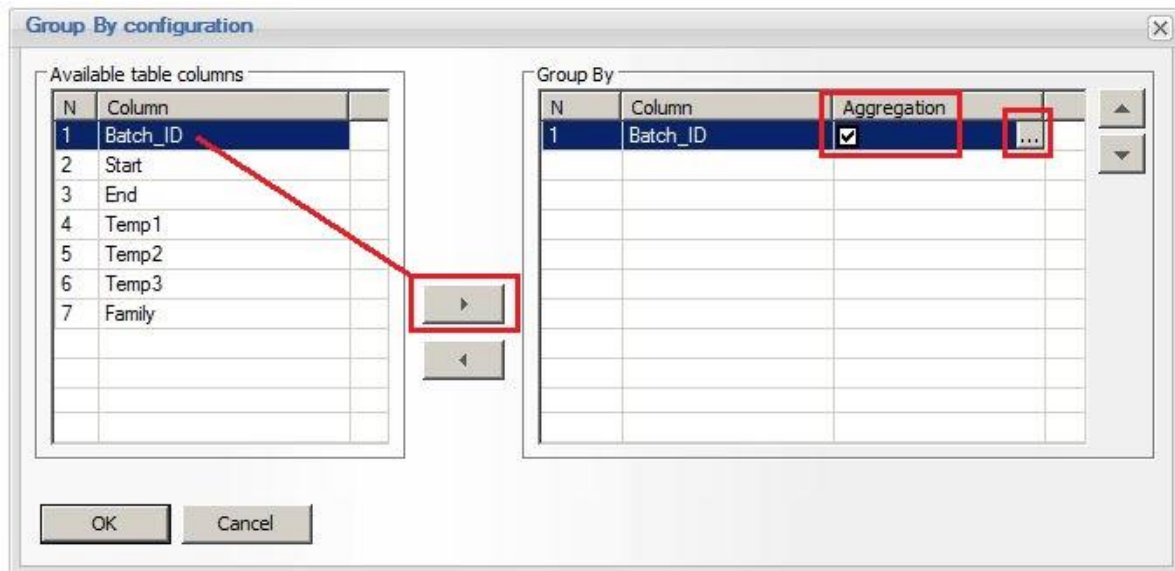

- In the **Available Table Columns** list, select the field (column) to group on, and then click the ">" button to add that column to the **Group By** list
- Check the **Aggregation** option to configure group aggregates (e.g., Min, Max, Avg over the group). If **Aggregation** is left unchecked, the resulting data in the table will simply be grouped by the selected column
- If **Aggregation** is checked, click the [...] button to configure the aggregates in the group's footer. The **Footer** configuration dialog box will open:

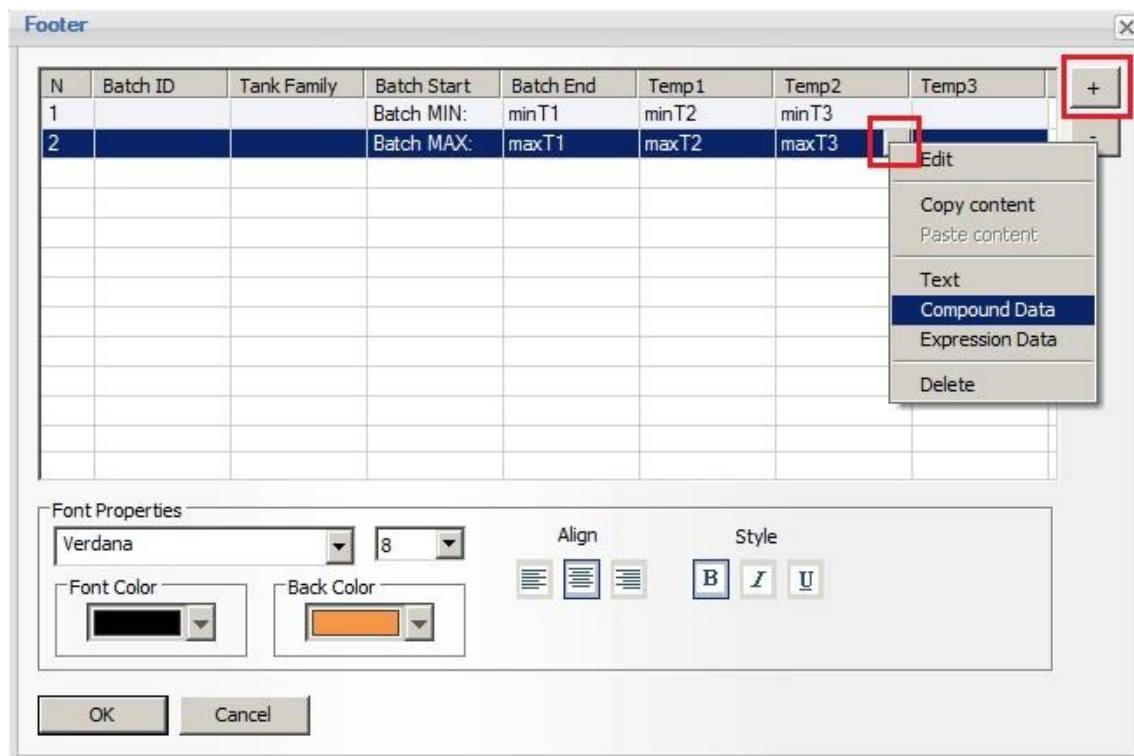

- Click the "+" button to add one or more **Footer** lines.



### Ocean Data Systems

7. Configure each footer line as needed, adding **Text** (labels), **Compound Data** or **Expression Data** objects, just as you would when configuring a footer in other table objects like the *Step Table* or *Automatic Statistic Table*.
8. To add **additional grouping levels** (sub-groups), repeat steps 3 - 7. You can use the up and down arrows shown in the image on step 2 to **set the grouping order**, where the primary grouping is first, with subsequent sub-group(s) below.
9. Click "**OK**" to close the **Group By** configuration, and then close the *SQL Query Table* object



## Project Deployment Tool

**Project deployment tool** enables Dream Report users to create complete and fully automatic packages to deploy software at end-user site.

There are two types of deployment packages:

- Initial deployment package and
- Existing project update deployment package

To create project deployment package, click on the command button *Project deployment tool* icon on the **Tools** ribbon on the horizontal toolbar in the Dream Report Studio menu (see pic. below):

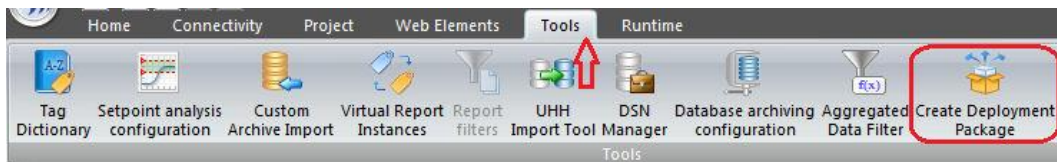

The "**Project deployment**" configuration dialog window will be opened (please see the picture below):

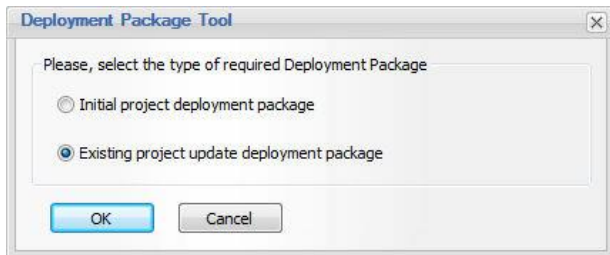

**Initial deployment package** is used if user want to create a package, which will include both, installation of Dream Report software and Dream Report project. If user has selected it - the result of that action will be generated EXE file, which by default will be saved in `C:\ODS\Dream Report\Project`, but user can select another location to save the deployment package. file.

This result deployment package EXE file can be sent directly to end user and when end user will launch it, it will automatically install Dream Report, install project and launch the project. So, that system integrator will not have to do anything manual.

### Note:

- If the project uses one or multiple DSNs - creating required DSNs on end-user machine has to be pre-done manually.
- All drivers will use original project settings, such as login, password to database, server name, etc.

**Existing project update package** is used to update existing running project at end-user site. When user will select this option, it will generate an EXE file, which will include all updated files of the currently opened project. When end user will launch this EXE file on his machine, that deployment package will:

- Stop currently running project
- Update project files
- Start the project again.

So, like that system integrator will not need to travel on end user site and can update end user project remotely.





## Dynamic Objects Selection

The text of SQL query can be either static or it may contain dynamic objects. If user will click on **Add dynamic token** button, then dynamic object selection window will be opened:



This window will contain the list of all dynamic objects, such as:

- *Single Data Objects*
- *Compound Objects*
- *Expression Objects*
- *Combo boxes (selection boxes)*
- *"Date and time" objects*
- *Timestamp pickers*
- *Internal project parameters*

The list of dynamic objects will be populated with objects from currently opened report (report, opened in Dream Report studio).

If defined SQL query contains dynamic objects, then during report generation value of each such an object will be calculated and placed into the query before its execution.

**IMPORTANT NOTE:** If you use such an SQL query in multiple reports and the query contains dynamic objects - you need to make sure that all those corresponding objects with the same appropriate names have to be defined in each such report, where the SQL query is used.

**Export to file** option can export all defined SQL queries to a text file, where users can manually edit all SQL queries in a fast way. The format of the text file is the following:

**[BatchInfo]**

**Description=**retrieve batch information

**Query=**SELECT batchID, Username, Lot, Phase ID FROM Batch\_Data

**[Users]**

**Description=**retrieve user information

**Query=**SELECT Username, address, Phone ID FROM Users\_Data

Were [...] - is query name, then the next line contains description and then there is the query body. Like that user can manually edit SQL queries and then import it back.

**Import from file** button will allow user to select a text file with SQL queries and then read it and import into SQL query manager. If any query section will fail to be read and parsed, such a query will be skipped.



## Electronic-Signature

The **Electronic-Signature (e-Signature)** feature provides the user the ability to electronically sign generated PDF reports. The e-Signature feature is only enabled with the Dream Report "Life Sciences" license option.

The **User Management Configuration Window** includes an **e-Signature** button, from which to configure the electronic signature properties for each user:

The screenshot shows the 'User Management' window with the 'Users And Groups' tab selected. The 'User Information' section contains fields for 'Login' (druser), 'Password', and 'Confirm Password'. A checkbox for 'Account is disabled' is present. The 'e-Signature' button is highlighted with a red box. The 'List of Users' section shows a table with 'Defined Users' (dradmin, druser). The 'List of Groups' section is empty. The 'User Authorization' section includes a language dropdown set to '<Default>' and an 'Account expires on' dropdown set to '10/ 9/2014'. The 'Windows Authentication' section has a checkbox for 'Use Windows Authentication'. The 'Authorization' section at the bottom has 'Add' and 'Delete' buttons. The window has 'OK', 'Cancel', and 'Apply' buttons at the bottom.

Clicking the **e-Signature** button will open the **User e-Signature** window:

The screenshot shows the 'User e-Signature' window. It has fields for 'Name (as it will be printed in report)' (Martin Gadget), 'PIN code:' (four dots), and 'Confirm PIN:' (four dots). There are fields for 'Title (as it will be printed in report)' (Inspector Gadget) and 'Select image with scanned signature:' (C:\Users\Administrator\Pictures\E-sig Scan.jpg). A preview of a handwritten signature is shown. There is also a field for 'User private e-Signature certificate:'. The window has 'OK' and 'Cancel' buttons at the bottom.





## Ocean Data Systems

Enter the user's **Name (as it will be printed in report)** - this should be the user's full name, and does not need to match the Dream Report/Windows login/username.

Enter the user's **Title (as it will be printed in the report)**.

If you wish to use a scanned signature to include with the electronic signature, please **Select image with scanned signature** -

.bmp, .png, gif and .jpeg formats are supported. This image file will be saved with the user information and will not be linked to an external image.

If a **User private e-Signature certificate** was previously created, you can browse for that certificate file and include it in the e-Signature configuration for this user.

Enter and confirm a **PIN code** if desired. The PIN code is an additional user validation criteria. It can be any numeric combination with up to 32 digits, and can only accept only digits.

Click **OK** to close the **User e-Signature** window. Repeat the above procedure for any other users for which you wish to create an electronic signature.

### Adding an e-Signature Object to a Report

To add an e-Signature object to a report, click on the **e-Signature** button on the Report Designer **Elements** (right-side)



toolbar, and then drag a "rectangle" in the location on the report for the e-Signature. Once the e-Signature is created, a configuration window will open:

The screenshot shows the "e-Signature Configuration" dialog box. It has a title bar with a close button. The dialog is divided into several sections:

- Signature object name:** A text input field.
- Cells layout:** A dropdown menu set to "Image and Stamp at the bottom".
- Display options:** A list of checkboxes: "Signature image" (checked), "Allow Watermark Stamp" (unchecked), "Name of signee" (checked), "Title of signee" (checked), "Date and time" (checked), and "Comment" (checked).
- Font settings:** A list of text elements (Name, Title, Date and Time, Comment) with a font dropdown set to "Arial" and a size dropdown set to "8". Below this are "Align" (left, center, right), "Style" (Bold, Italic, Underline), "Font Color" (black), and "Back Color" (white) options.
- Authorized for:** A table with a header "Authorized users" and two rows: "dradmin" (unchecked) and "druser" (checked).
- Buttons:** "OK" and "Cancel" buttons at the bottom.

**Signature Object Name** must be a unique logical name which will be used in further work with that object within the project. The object name can be up to 64 characters long. Only alphanumeric characters and "\_" are allowed.



## Ocean Data Systems

The **Cells Layout** option allows the user to select one of two predefined layout formats for the e-Signature grid on the report. The first option with layout the cells with the *Image and Stamp at the bottom*:

Name Of Signee
Title Of Signee
Date And Time
Comment
Signature Image

The second option with layout the cells with the *Signature Image and Stamp on the right*:

Name Of Signee	Signature Image	Stamp Image
Title Of Signee		
Date And Time		
Comment		

If a signature image was defined with a user's e-Signature configuration, select the **Signature image** option to include the image in the e-Signature grid on the report.

Select the **Allow Watermark Stamp** option to include an image for a watermark stamp like "Passed", "Failed", "Approved", "Rejected" or "Confirmed" in the e-Signature grid.

Select the **Name of signee** option to include the Name defined in the user's e-Signature configuration.

Select the **Title of signee** option to include the Title defined in the user's e-Signature configuration.

Select the **Date and time** option to include the Date and Timestamp when the electronic signature was entered.

Use the grid formatting option to specify how sections of the e-Signature grid will be displayed, including font and background colors, font styles, and text alignment.

Select the defined Dream Report users from the list who will be **Authorized for** performing an electronic signature on this report.

Click the **OK** button to close and save the e-Signature object configuration.

Finally, if an e-Signature is required for the report to be generated, open the **Report Settings** for the report and select the **Report File Format** tab. Select the **e-Signature required** option.

### Applying an Electronic-Signature at Runtime

When a report is generated that requires an e-Signature, the resulting (PDF) output will be saved to a directory under the defined **Reports** folder named `\UnsignedReports\[ReportName]`. The PDF will be "unsigned" - i.e., it will contain the empty e-Signature "grid". To sign the report electronically, the (authorized) user should take the following steps:

1. Open the e-Signature Console, launched from either the **Runtime Management Console (RMC)**, or from **Start > All Programs > ODS > Dream Report > e-Signature Console**:



## Ocean Data Systems

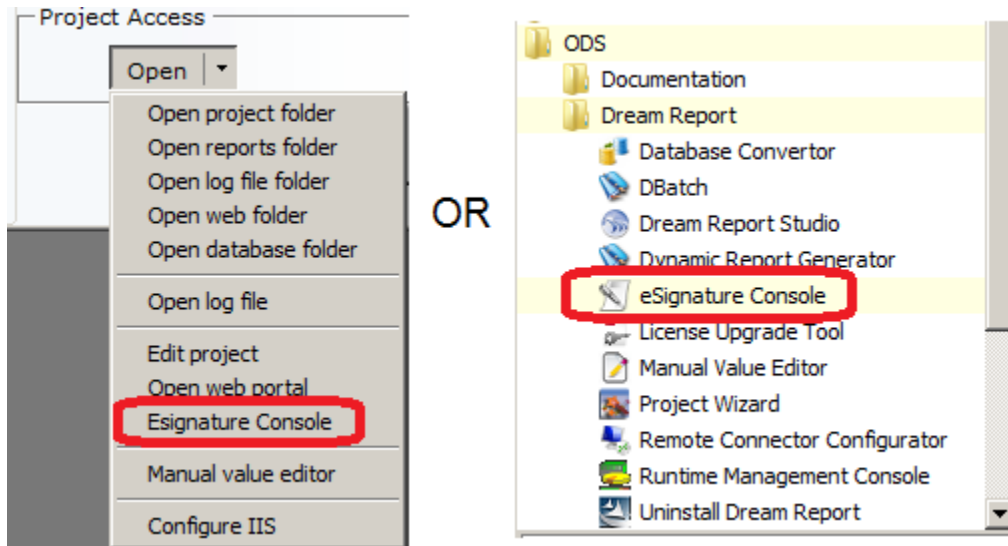

2. The **e-Signature user authentication** window will open:

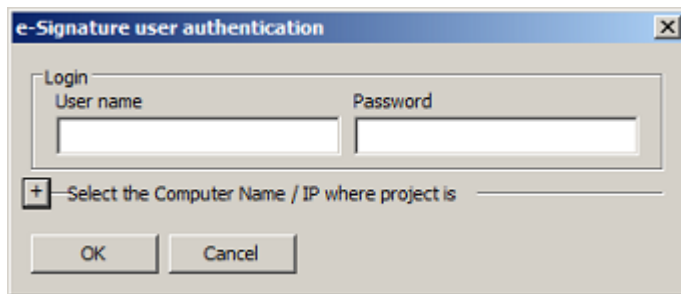

3. **Login** with the User name and Password of the electronic signer. If the Dream Report project is running on a remote machine, **Select the Computer Name / IP where project is** to specify the node. Click "**OK**" to log in.
4. If successfully logged-on, the e-Signature Console window will open:



5. Click the "..." browse button to **Select Report File** you wish to sign. Select the appropriate report from the list of available unsigned reports, and then click "OK":

6. The name of the e-Signature object will be listed in the **Select Signature** section. Select that **Signature**, and optionally add a **PIN code** (if defined for that user), select a display **Stamp**, and **Add Comments**:



## Ocean Data Systems

Signature
<input checked="" type="checkbox"/> esig

7. Click the "Sign" button, and if all credentials are met, the report will be electronically signed and a message will pop up that the "Report was Electronically Signed". That specific report will be removed from the "Unsigned Reports" folder.
8. Continue signing any other reports, and then click "Close".
9. If you then open an e-signed report, the e-Signature grid will be displayed with electronic signature completed:

Martin Gadget	
Inspector Gadget	
07/18/14 17:01:43	
Released to QA	



## Data Modeler

The Dream Report **Data Model** feature provides the ability to organize and structure tags (data items) from one or more data sources in a required structure, as well as dynamically substitute tags for report generation. Tags can be organized in a meaningful hierarchical (folder-based) structure (e.g., by equipment, processing unit, tag types, etc.) which adds context to tags, regardless of the capabilities of the data source. The data sources might be simple "flat" structures such as realtime data, CSV files, or traditional HMI log files; or complex, folder-based tag structures that do not necessarily reflect a practical tag organization. Using the **Data Modeler**, tag "sources" are hidden from users, and tags can be renamed with meaningful "aliases." Additionally, tags in the data source(s) that are not needed for reporting can be hidden from the user.

The **Data Modeler** configuration can be accessed from the **Data Model** icon on the horizontal **Tools** toolbar, or from the **Data Model** icon on the left side **Quick Launch Bar** in the *Dream Report Designer Studio* (see images below):

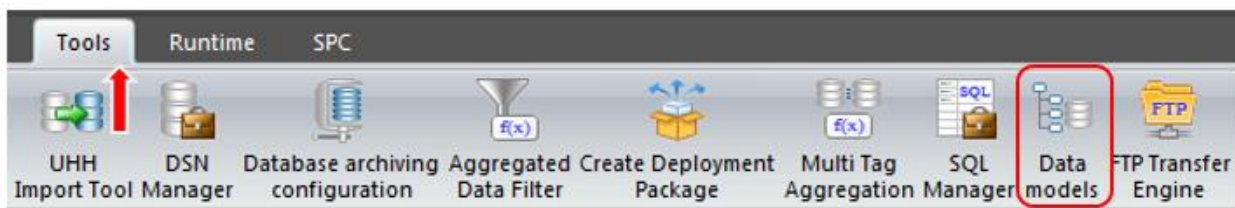

or

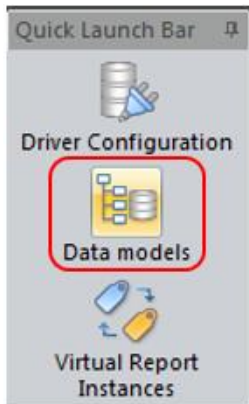

The **Data Models** icon opens a user interface which allows for creating and editing one or more data models:

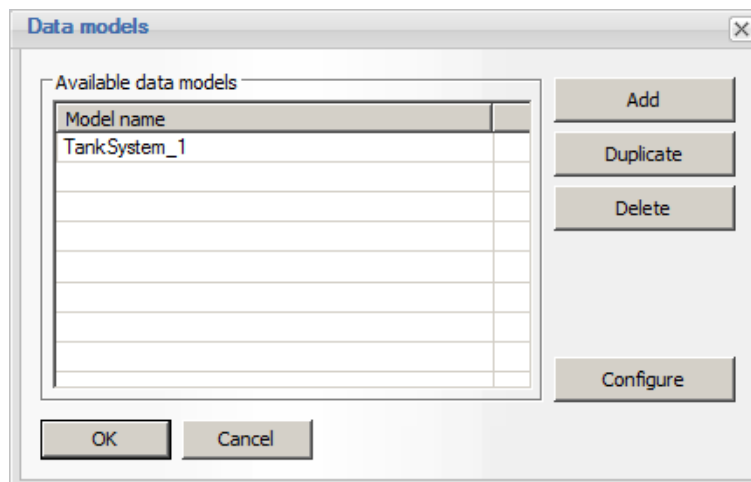



### To Create, Copy or Delete a Data Model

From the **Data Models** user interface:

1. Click the “**Add**” button to **add** a new blank data model. The **Model Name** will be automatically generated as “DataModel\_x”.
2. Double-click on the newly-created **Model Name** to rename it to something meaningful. The model name may not contain any spaces.
3. If you wish to use an existing Data Model as the basis for a new Data Model, highlight the desired model, and click the “**Duplicate**” button. A **copy** of the model will be created with a new name, at which time it should be renamed with a unique data model name.
4. To **delete** a Data Model, highlight that model and click the “**Delete**” button, and then click “**Yes**” to confirm

### To Configure a Data Model - using the Data Model Driver Configuration

Before creating a Data Model, it is a good idea to have a “sketch” of the needed folder structure. From the **Data Models** user interface:

5. Select (or **Add**, as detailed in the section above) a **Model Name**, and click the “**Configure**” button. The **Data Model Driver Configuration** user interface will open:

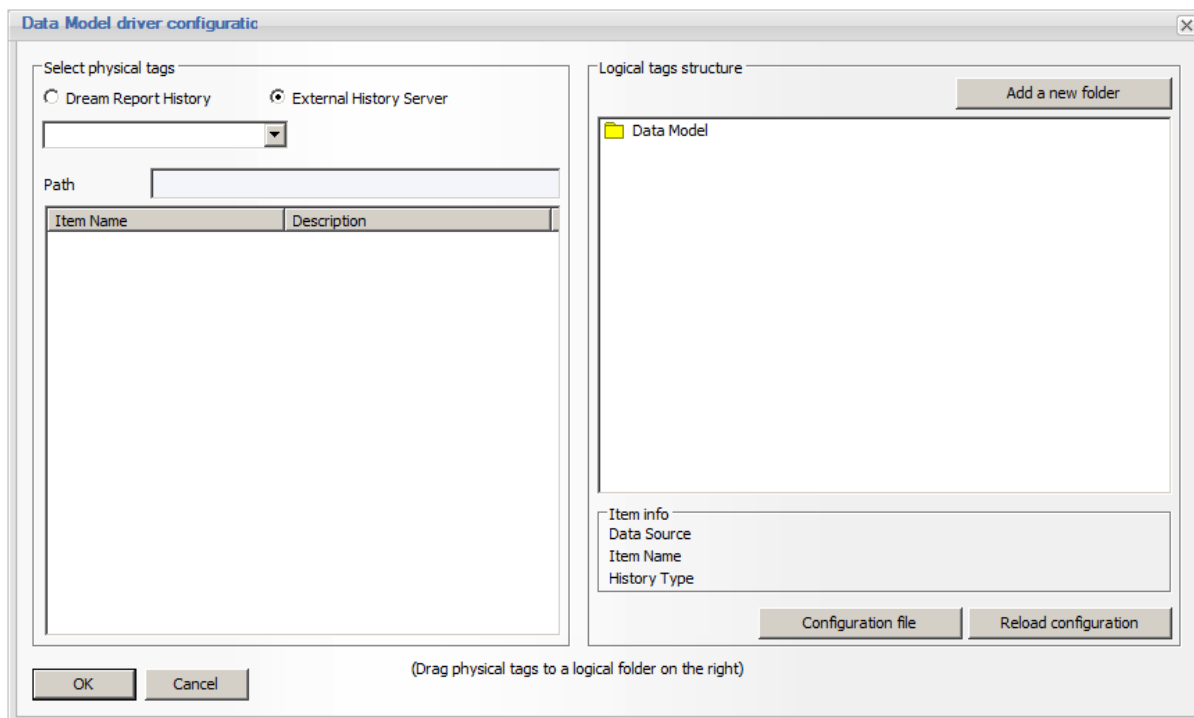

6. On the **Logical Tags Structure** panel on the right side, right-click on the top-level “**Data Model**” folder, and click the “**Insert a new folder**” option. A new (numbered) sub-folder will be created.
7. Double-click the folder number, and enter a **logical name** for the folder.
8. At this point, you can either start adding physical tags to the newly-created folder, or repeat steps 6. and 7. until the desired folder is created. Remember that folders can be multiple levels deep

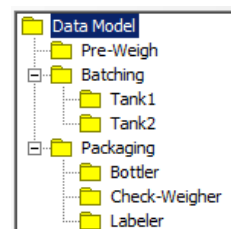



9. To **Add** tags to a data model folder, in the **Select Physical Tags** left-side panel, select either the *Dream Report History* or *External History Server* option, and then select the appropriate Data Source from the list
10. When a Data Source is selected, a list of physical tags (data items) will be displayed. Select the tag or multiple tags (using the *Shift* or *Control* keys), and then drag-and-drop the tag(s) into the appropriate **Logical Folder** in the data model. The same tag(s) can be dragged into multiple folders.
11. Repeat steps 9. and 10. with tags from different data sources, until the data model is populated with tags, as needed. At this point, logical folders might contain tags from different data sources, and of different types (Dream Report history and External History servers.)
12. Tags in the data model can be **renamed** by double-clicking on the tagname, or selecting the tagname and pressing the “**F2**” button. Type in the new **Logical Name** for the physical tag. Note that the original Data Source name, Item name, and Data Source type for each Logical Tagname can be referenced in the **Item Info** section below the Data Model

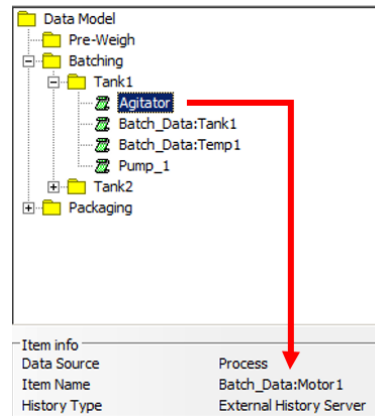

13. Tags can be moved (dragged) from one logical folder to another, and logical folders (already containing tags) can be moved (dragged) to other folders.
14. To **Save** the configured **Data Model**, click the “**OK**” button, or select “**Cancel**” to discard changes to the model.
15. Click the “**OK**” button to save and close the Data Models window.

### To Configure or Edit a Data Model from an XML File

The structure of each Data Model is contained in an **XML file** stored in the specific Dream Report project folder. This file can be edited (using Notepad, for example), which provides an alternate method of configuring the folder structure. The file name for each data model is named according to the following format: *Logic\_drv\_[DataModelName].xml*, where [DataModelName] is the actual data model name. In the example at the start of this model, data model name is “TankSystem\_1”, so the corresponding file name would be *Logic\_drv\_TankSystem\_1.xml*. The following XML file correlates to the above data model:

```
<?xml version="1.0" encoding="utf-8" ?>
<DataModel>
  <Structure Name="Pre-Weigh" />
</Structure>
  <Structure Name="Batching">
    <Structure Name="Tank1">
      <Attribute Name="Agitator" Address="Batch_Data:Motor1" DataSource="Process" History="External" />
      <Attribute Name="Batch_Data:Tank1" Address="Batch_Data:Tank1" DataSource="Process" History="External" />
      <Attribute Name="Batch_Data:Temp1" Address="Batch_Data:Temp1" DataSource="Process" History="External" />
      <Attribute Name="Pump_1" Address="Pump_1" DataSource="PLC_Data" History="Internal" />
    </Structure>
    <Structure Name="Tank2">
      <Attribute Name="Batch_Data:Motor2" Address="Batch_Data:Motor2" DataSource="Process" History="External" />
    </Structure>
  </Structure>
</DataModel>
```





## Ocean Data Systems

```
<Attribute Name="Batch_Data:Tank2" Address="Batch_Data:Tank2" DataSource="Process" History="External" />
<Attribute Name="Batch_Data:Temp2" Address="Batch_Data:Temp2" DataSource="Process" History="External" />
<Attribute Name="Pump_2" Address="Pump_2" DataSource="PLC_Data" History="Internal" />
</Structure>
</Structure>
<Structure Name="Packaging">
  <Structure Name="Bottler" />
  <Structure Name="Check-Weigher" />
  <Structure Name="Labeler" />
</Structure>
</DataModel>
```

To edit the XML file:

1. In the [Data Model Driver Configuration](#) user interface, click the “**Configuration File**”.
2. The data model's XML file will open in the *Notebook* editor
3. In Notebook, you can edit sections, rename folders, add new folder sections, rename logical tags, etc. You can also copy and paste sections (indicated by <Structure Name=...> in the file, and rename copied sections (folders) as needed.
4. After saving and closing the XML file, return to the [Data Model Driver Configuration](#) user interface, and click the “**Reload Configuration**” button - any changes made to the XML file will be loaded and reflected in the logical data model.

**Note:** It is advisable that you do not manually add/type tags (data items) in the XML file, as tags are referenced in a specific format and are case-sensitive.

## Dynamic Tag Substitution

Instead of configuring a report to reference physical drivers and physical tags, it can be configured to rather reference only a logical driver and logical tags. Then, before report generation, the appropriate XML file containing the actual (physical) tags to be reported on, can be copied into the project folder. The file can be manually copied into the folder, or, using the report's “Macro” configuration, a batch file can be called which copies the XML file. The report will be generated using the dynamic tags substitution map.

## Using Logical Tags in a Report

When configuring a report object such as Single Data Object or a Table, a Data Model is referenced as an “External History Server” (regardless if the Data Model contains “Dream Report History” source tags), and logical tags are selected in the same way as with physical tags:

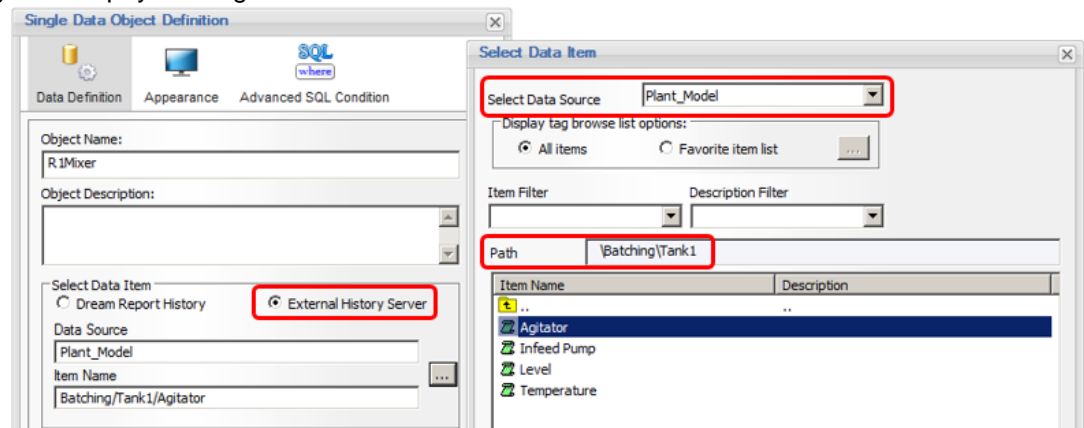



## FTP Transfer Engine

The *FTP Transfer Engine* is a utility which enables Dream Report to periodically download data files from FTP server(s) for reporting in Dream Report.

To define an FTP transfer, click on the command button *FTP Transfer Engine* on the **Tools** ribbon icon on the ribbon toolbar either in Dream Report Studio menu (see pic. below):

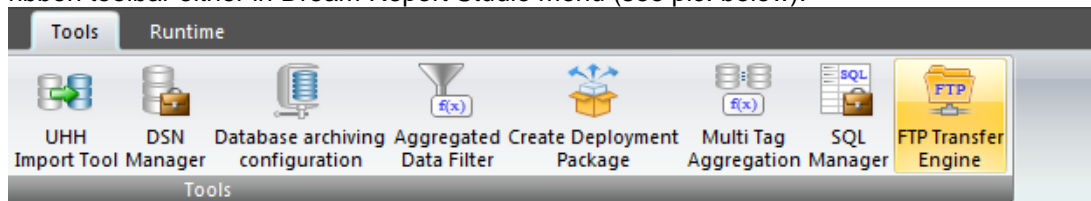

The *FTP Transfer Engine Configuration* dialog window will be opened:

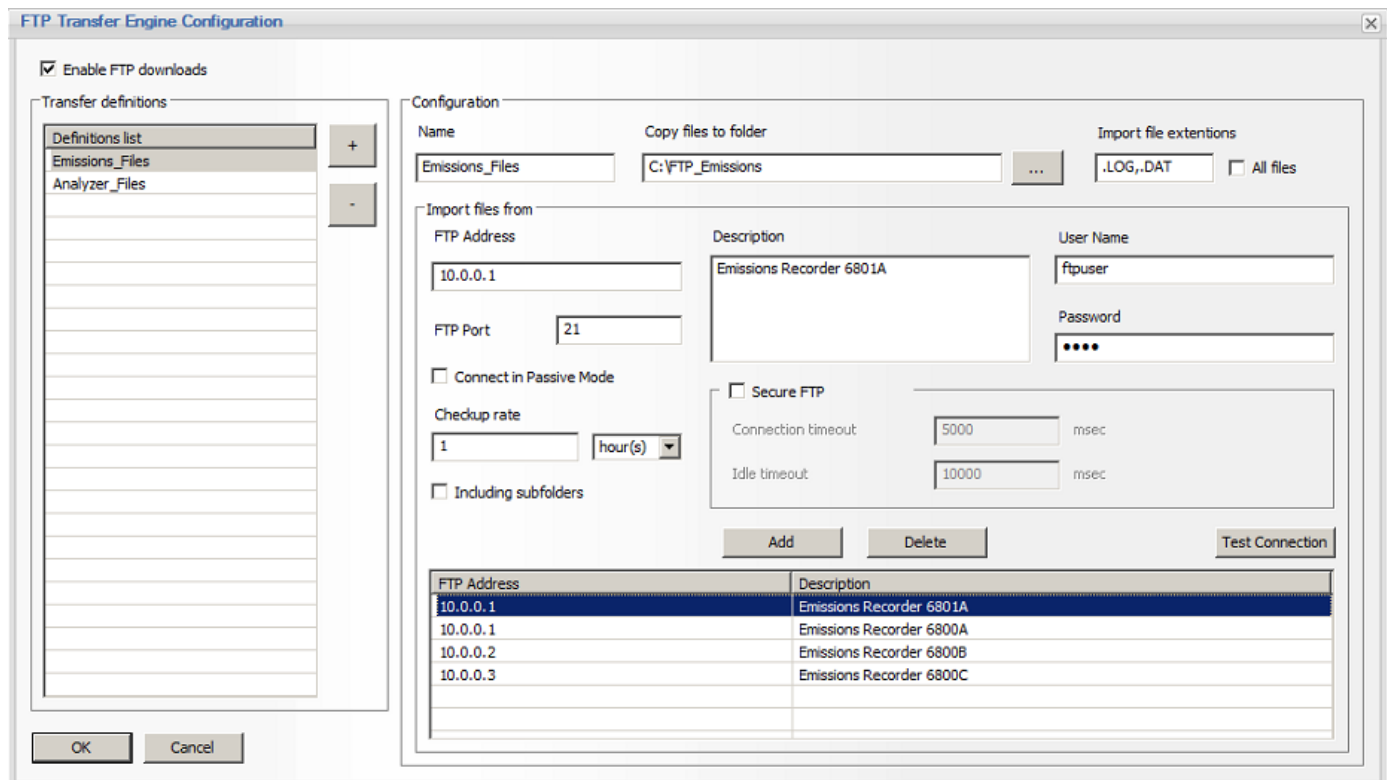

The “**Enable FTP Transfers**” option must be checked for the FTP Transfer Engine to work. When the project is loaded (at runtime), the FTP engine will be started, and start downloading files at the defined frequency (as described below.)

The user can create one or more FTP Transfer definitions from this **Configuration** screen. Typically, an FTP definition is a collection of one or more FTP sites containing the same type of files to be transferred - for instance, if there are number of distributed recorders all logging the same type of data (e.g., CSV files from emissions recorders, DAT files from temperature recorders, etc.)



To create a definition:

1. **Name:** Enter a logical Name of that FTP definition into the Name edit box. The Transfer definition name must be unique.
2. **Copy files to Folder:** Enter or browse to a valid path on the Dream Report computer to where all the downloaded files (in this FTP Transfer definition) will be copied. If the same folder is defined for several FTP Definitions, then a warning message will appear.
3. **Import File Extensions:** Enter a file extension type, or multiple file types (separated by commas) than can be downloaded as part of this Transfer definition. Dream Report will recognize the file extensions formatted, with a wildcard, a “dot” prefix, or only the file type - e.g., \*.CSV, .CSV or CSV. If you wish to import all file types stored in the FTP location, simply check the “All Files” option. This will be common to all FTP transfers in this Transfer Definition
4. The **Import Files From section** allows to user to define one or more FTP sites and transfer scheduled to be associated with this Transfer Definition
5. **FTP Address:** the address of the FTP site.
6. **FTP Port:** the port number of the FTP site. Default is “21”
7. **Connect in Passive Mode:** Depending on how the FTP server has been configured, you may need to use a *Passive* connection. In the Active mode, the client (Dream Report) initially specifies which client-side port it has opened up for the data channel, and the FTP server initiates the connection. In Passive mode, the FTP server specifies which server-side port the client should connect to and the client (Dream Report) initiates the connection.
8. **Description:** enter a description for this specific FTP connection
9. **User Name:** enter a valid User Name for the FTP connection
10. **Password:** enter a valid Password for the FTP connection
11. **Secure FTP:** for secured FTP connections, you may need to provide Connection and Idle timeout values to handle FTP connection time out issue.
12. **Checkup Rate:** enter the frequency (in hours, minutes or seconds) at which the Dream Report FTP Transfer Engine will connect to the FTP server and download files
13. **Including Subfolders:** if checked, any appropriate files contained in any subdirectories on the FTP location will be transferred

Click “Add” to add the FTP definition to this Transfer Definition. Repeat steps 4-13 to add additional FTP definitions. You can modify a definition by selecting that definition in the list below, and make the needed changes. To delete a definition, select it from the list, and click “Delete”.

Finally, click the “+” button to add this Transfer Definition to the Definitions List.

At runtime, after each download, the FTP transfer engine will maintain a transfer log (including the timestamp of the last successful transfer and transferred files list). At the next transfer event, only files with a creation date or modification date later than retained data, or a new file name, which did not exist during the last transfer, will be downloaded. If downloading a file to a destination folder with the existing file having the same name, then the new file will overwrite the existing one.



## Ocean Data Systems

The *FTP Transfer Engine* will log messages into the standard Dream Report log file – start, end and the result (succeeded or failed) of each transfer will be logged. If the transfer failed, the error details will be logged as well.

**NOTE:** If you receive an FTP connection “timed out” error while testing the connection (“Test Connection” button in the FTP Transfer Configuration screen), or a similar message reported at Runtime in the Dream Report log file, there may be several reasons of that, including:

- Your Internet Service Provider might be blocking the port you're trying to use to connect via FTP - Port 21.
- The FTP client is not set to work in “Passive” mode - uncheck the “Connect in Passive Mode” option
- The FTP domain name is expired or is resolving incorrectly. Best practice is to access the FTP server directly via its IP address (e.g., 10.0.0.1, instead of <ftp.mysite.com>)



# SPC Module

The **SPC** module is a license-enabled add-on option which provides a set of functions, charts and tables for Statistical Process Control (SPC) reporting:

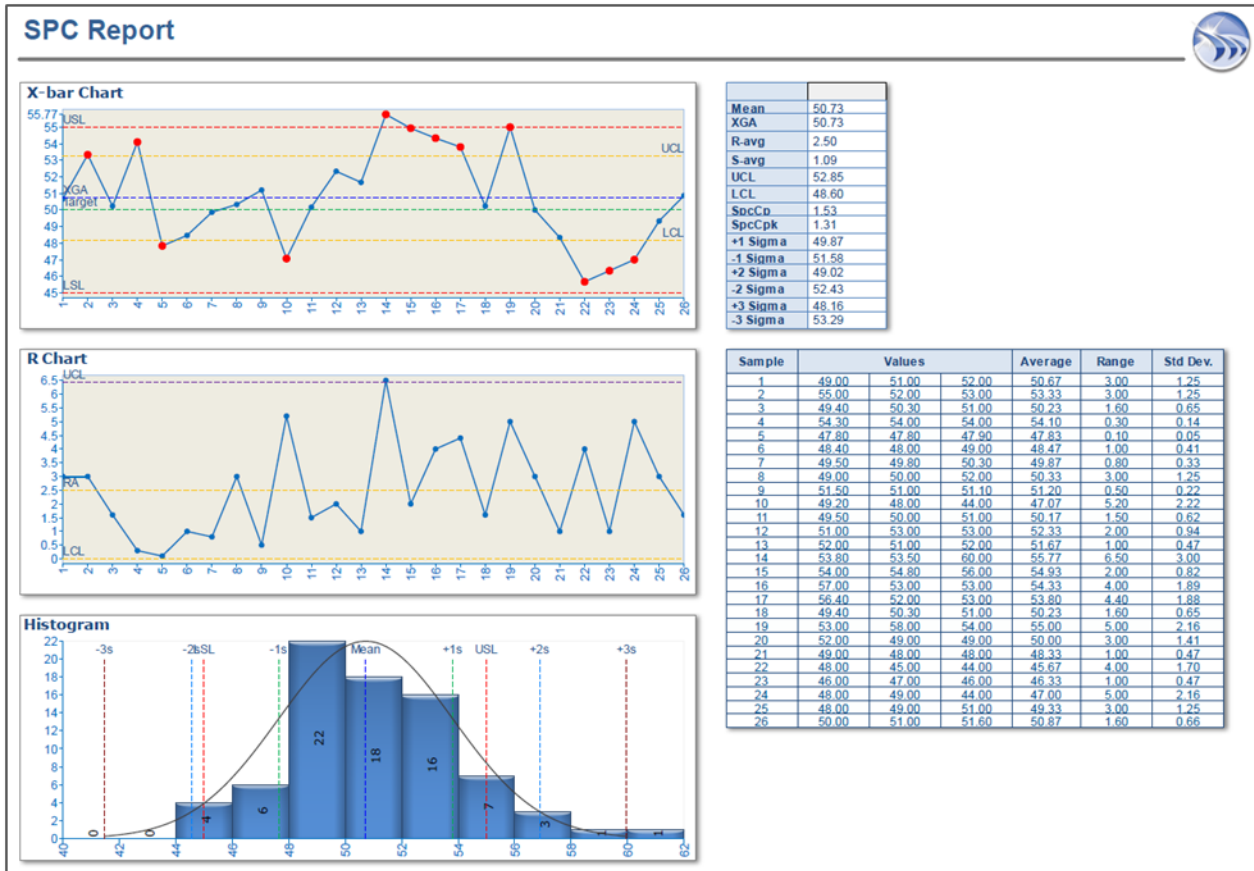

The SPC features are accessed from the **SPC** ribbon icon on the horizontal toolbar in the *Dream Report Designer Studio* menu (see pic. below):

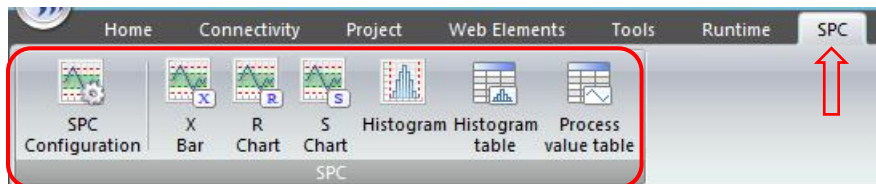

The **SPC Configuration** icon opens a user interface which allows for the definition of SPC data collection parameters for variable data items. All other SPC objects and functions reference the SPC definitions configured in the **SPC Configuration** interface.

The **X-Bar**, **R-Chart**, **S-Chart** and **Histogram** icons allow a user to configure and place the appropriate SPC charts on a report.

The **Histogram Table** and **Process Value Table** icons allow a user to configure and place the appropriate SPC data tables on a report.



Additionally, the **Single Data object**, the **Automatic Statistical Table (AST)** and the **Step Table** can be configured to calculate and display any of the twenty included SPC statistical functions (X-bar, LCL, UCL, Cp, Cpk, etc.)

## SPC Configuration

Before using any SPC objects or statistical functions in Dream Report Studio, one or more SPC definitions should be created in the **SPC Configuration** interface. Click the **SPC Configuration** icon on the **SPC** ribbon bar. The following interface will open:

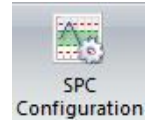

### To Create an SPC Configuration/definition:

1. Enter a unique **Name** for the SPC configuration
2. An SPC configuration (“Name”) can be based on a data item from any configured Dream Report data source, or from the results of a SQL query. In the **Get Data From** section, select either “**Tag**”, or “**SQL Query**”
  - If “**Tag**” is selected, the standard Dream Report “Select Data Item” options will be displayed. Select either “**Dream Report History**” or “**External History Server**” to select the appropriate data source and data item (tag) that contains the data you wish to perform the SPC analysis on. Additionally, a **Correction Factor**, **Aggregated Data Filter (ADF)** and **Advanced SQL Condition** can be applied to the raw data before the SPC analysis is performed.
  - If “**SQL Query**” is selected, the standard Dream Report SQL Query interface will be displayed. Select an ODBC Database Source, and create a SQL query that will return data in two columns - one containing a date/timestamp, and one containing the data to be analyzed. All the SQL functionality described in the “SQL Development Tools” section are available here.
3. Dream Report can use either a “**Time-based**” or “**Sample-Based**” **SPC calculation methodology**:
  - **Sample-Based** (the default) will group the raw data in “X measurements per sample” (i.e., the “**Sample count**”) as the SPC sample in all SQL objects and functions.
  - For **Time-based** sampling, enter the “**Step Interval**” (e.g., every 15 minutes) and the **Sample count**, which will be the first “X” values (measurements) in the defined “**Step Interval**”, to be used as the SPC “sample” in all SQL objects and functions. If a different sampling interval is needed - e.g., for each 1 hour period, take the first 4 measurements at 5 minute intervals - an Aggregated Data Filter (ADF) can be used to generate desired data set (also, use last values, averages, or others).



## Ocean Data Systems

4. **Specification Limits** - i.e., the **Target**, **Lower Specification Limit (LSL)** and **Upper Specification Limit (USL)** - can be hard-coded by entering the values in the appropriate fields, or, if you double-click in a field, you have the ability to reference a **Dynamic Object** (Single Data, Compound or Expression object) from a specific report for any of the limits. This is useful if you want to use the same SPC definition (e.g., "*Inside\_Diameter*") but have the target and spec limits be dynamic, depending on a specific product being run at that time.
5. The **Control Limits Calculation Method** option allows you to specify which industry-accepted calculation method will be used when calculating the **Upper** and **Lower Control Limits** for this specific SPC configuration:
  - **Based on Standard Deviation**
  - **Based on Range Average with coefficients** (*default*)
  - **Based on Standard Deviation Average with coefficients**
  - **Based on Specification Limits**
6. Click the "+" to **Add** the SPC configuration to the list of defined SPC configuration **Names**
7. To **Delete** an SPC configuration Name, select the **Name** in the list, and click the "-" button

## SPC Control Charts - X-bar, R and S

SPC Control Charts are used to graphically display how a process changes over time, and monitors the stability of a process - i.e., whether the process is in or out of control. The most commonly used control charts are "X-bar" charts, along with a corresponding Range (R) chart and/or Standard Deviation (S) Chart, can be selected from the **SPC menu** bar in Dream Report Studio.

**X-bar Chart** Plots the process mean ("X Bar") over time for subgroups of variable data

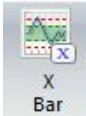

**R (Range)** Plots the range (R) of variation among the individual measurements of SPC samples.



**S (Std. Dev)** Plots the standard deviation (S) over time of multiple subgroups of variable data

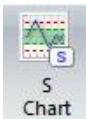

The following is an example of an **X-bar** and **R Chart** in Dream Report:



## Ocean Data Systems

### X-Bar Chart - Inside Diameter (mm)

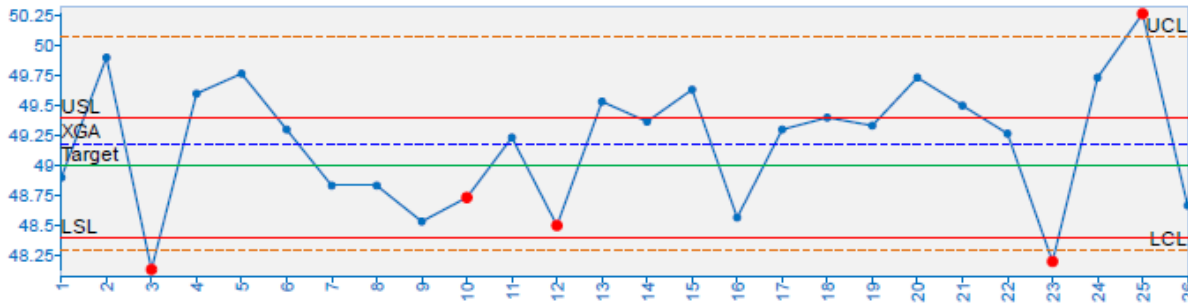

### Range Chart - Inside Diameter (mm)

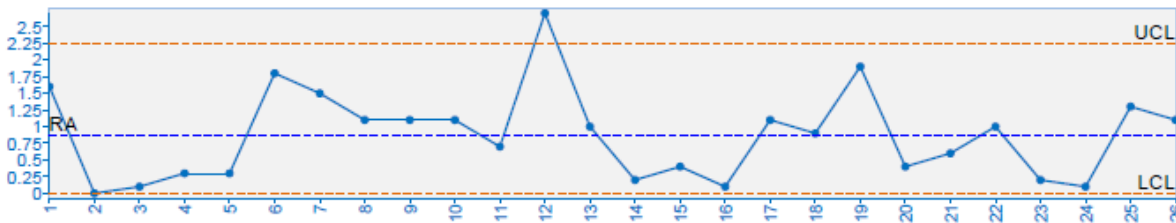

After creating one or more SPC configurations, an SPC Control Chart can be added to a report by selecting one of the **X-bar**, **R Chart** or **S Chart** icons from the **SPC** tab in Dream Report Studio, and selecting an area on the report on which to place the chart. While the X-bar, R and S control charts are configured independently of each other, they share a common interface, and as such, are configured similarly:

The screenshot shows the 'X Bar' configuration dialog box. It has two tabs: 'Data Definition' and 'Appearance'. The 'Data Definition' tab is active, showing 'SPC Parameters'. Under 'Define time period', 'Fixed Period' is selected. The 'Last' dropdown is set to '1' and the unit is 'month(s)'. There is a 'Duration' checkbox which is unchecked, with a value of '1' and unit 'hour(s)'. The 'Start Date and Time' section has 'Day' set to '1' and 'Time' set to '12:00:00 AM'. The 'Line Style' section shows a blue line with a solid circle marker. The 'Legend' section is empty. 'OK' and 'Cancel' buttons are at the bottom.





Before using any SPC objects or statistical functions in Dream Report Studio, one or more SPC definitions should be created in the **SPC Configuration**, or, the **SPC Configuration** interface can be launched from within the SPC chart object. To select (or configure) an SPC configuration for the Control Chart, select the “**SPC Parameters**” button on the “**Data Definition**” tab of the chart object. The following **SPC Parameters** window will open:

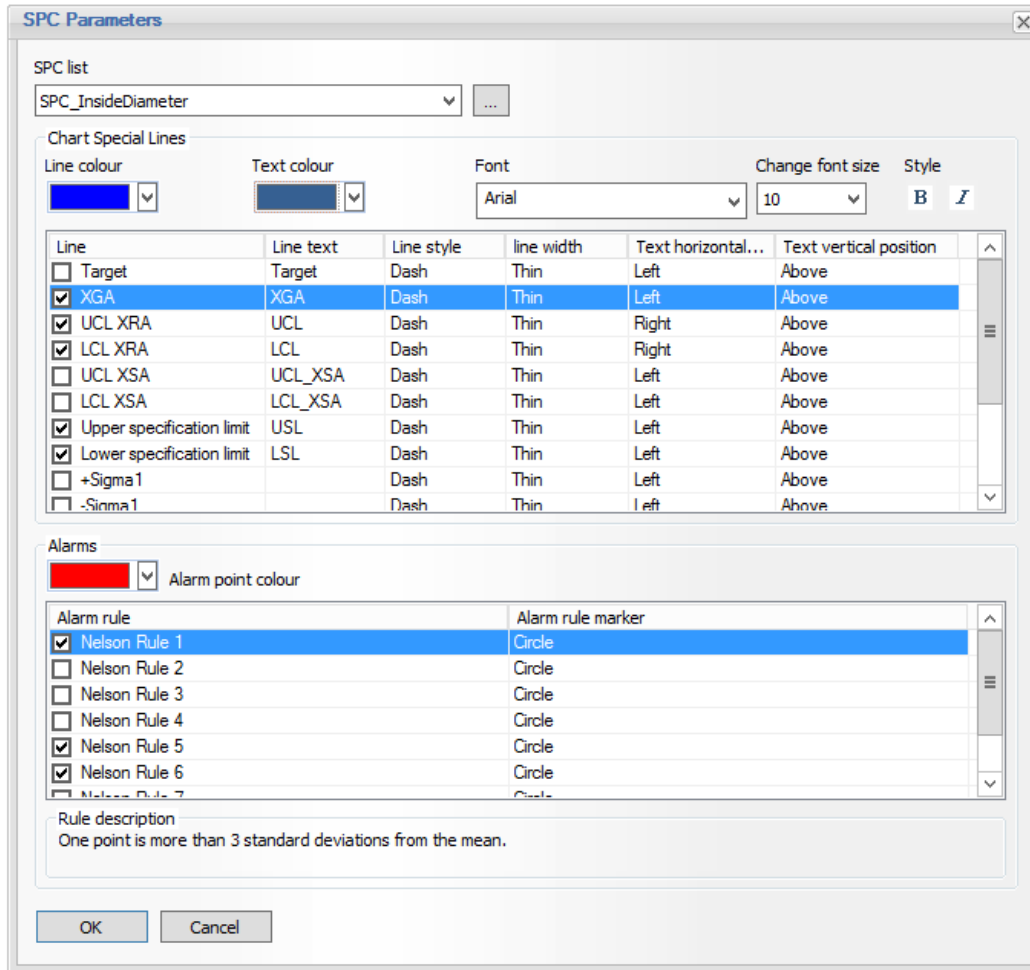

Select an existing SPC configuration from the **SPC List**, or click the [...] button to open the **SPC Configuration** window to create a new configuration. After selecting an SPC configuration to show on the control chart, select which of the **Chart Special Lines** to show on the chart, along with configuring the line color, style, caption and font for each line. The following **Chart Special Lines** are available for each specific control chart:

**X-bar Chart**

- Target** The Target Specification Limit, as defined in the SPC configuration
- XGA** The Grand Average (mean) of all samples shown on the control chart
- UCL RA** Upper Control Limit line, calculated based on the RA (Range Average)
- LCL RA** Lower Control Limit line, calculated based on the RA (Range Average)
- UCL SA** Upper Control Limit line, calculated based on the SA (Std. Dev Average)
- LCL SA** Lower Control Limit line, calculated based on the SA (Std. Dev Average)
- USL** Upper Specification Limit, as defined in the SPC configuration
- USL** Upper Specification Limit, as defined in the SPC configuration
- +Sigma1** +1 Standard Deviation (Sigma) from the Grand Average (mean)
- Sigma1** -1 Standard Deviation (Sigma) from the Grand Average (mean)
- +Sigma2** +2 Standard Deviation (Sigma) from the Grand Average (mean)
- Sigma2** -2 Standard Deviation (Sigma) from the Grand Average (mean)



## Ocean Data Systems

- +Sigma3** +3 Standard Deviation (Sigma) from the Grand Average (mean)
- Sigma3** -3 Standard Deviation (Sigma) from the Grand Average (mean)

### R (Range) Chart

- RA** The Average of the sample ranges of all samples shown on the control chart
- UCL RA** Upper Control Limit line, calculated based on the RA (Range Average)
- LCL RA** Lower Control Limit line, calculated based on the RA (Range Average)

### S (Standard Deviation) Chart

- SA** The Average of the sample standard deviations of all samples shown on the control chart
- UCL SA** Upper Control Limit line of Standard Deviations, calculated based on the SA (Std. Dev Average)
- LCL SA** Upper Control Limit line of Standard Deviations, calculated based on the SA (Std. Dev Average)

Additionally, the X-bar chart allows for the evaluation and **SPC Alarm** of a sample against any of the eight “Nelson” SPC rules. The Nelson SPC rules are almost identical to the combination of the four basic/core and four supplemental “Western Electric Company” (WECO) SPC rules. If an SPC sample violates any of the selected SPC rules, that sample will be highlighted (alarmed) with the specified **Alarm Point color** and **marker**.

### Nelson Rules

- Rule 1** 1 point is more than 3 standard deviations from the mean.
- Rule 2** 9 (or more) points in a row are on the same side of the mean.
- Rule 3** 6 (or more) points in a row are continually increasing (or decreasing).
- Rule 4** 14 (or more) points in a row alternate in direction, increasing then decreasing.
- Rule 5** 2 (or 3) out of 3 points in a row are more than 2 standard deviations from the mean in the same direction.
- Rule 6** 4 (or 5) out of 5 points in a row are more than 1 standard deviation from the mean in the same direction.
- Rule 7** 15 points in a row are all within 1 standard deviation of the mean on either side of the mean.
- Rule 8** 8 points in a row exist with none within 1 std. dev. of the mean and the points are in both directions of the mean.

Click “**OK**” to close the **SPC Parameters** window.

Configure the **Define Time Period** option to set the time period over which to chart the SPC samples. The Time Period is defined in the same way as all other Dream Report objects, and can be *Relative*, *Absolute*, *Fixed*, *Calculated* or *Batch-based*.

The **Line Style** settings allow you to specify how the SPC samples will be plotted on the Control chart - line color, thickness, style (solid or dashed), with or without a line marker, and marker shape.

If needed, a static text **Legend** can be entered as well, on the **Data Definition** screen.

Click the **Appearance** tab to set the general appearance settings of the Control chart, including background color, chart title and font, axis fonts, chart grid lines, axis units, etc.



## Histogram Chart

A **Histogram** shows the distribution of the data provided from the samples over a given time period. To add a Histogram chart to a report, select the **Histogram** icon from the **SPC menu bar**, and select an area on the report on which to place the chart.



After placing the **Histogram** object on the report, the following Histogram configuration window will open:

Before using any SPC objects or statistical functions in Dream Report Studio, one or more SPC definitions should be created in the **SPC Configuration**; or, the SPC Configuration interface can be launched from within the SPC Histogram object. To select (or configure) an SPC configuration for the Histogram, select an existing SPC configuration name from the **SPC List**, or click the **[...]** button to open the **SPC Configuration** window to create a new configuration.

Using the **Bar Value Range** option, the bars on a Histogram can be configured to represent either the frequency (number of occurrences) of individual values in the data set, or the frequency of value ranges in the data set.

- **Bar for Each Value** Each bar in the Histogram will represent the frequency of occurrence of individual values in the data set selected, with values analyzed at the **Value Precision** selected. For example, if a



Value Precision of "1" were selected, and the following raw data values were included in the data set (42.123, 42.033, 42.098, 42.144, 43.09, etc.) the number "42.1" would have a frequency of "3" on the Histogram, due to the rounding to 1 decimal place.

- **Bar for Value Range** Each bar in the Histogram will represent the frequency of occurrence of a range of values (either in Absolute units or a Percentage range) for the data set selected

Click the "Bar Specification Lines" button to select which "special" SPC vertical lines should be included on the Histogram (e.g., Target, Mean, USL, LSL, -2Sigma, +2 Sigma, etc.), line and font formatting options, as well as whether to include the Normal Distribution Line on the Histogram:

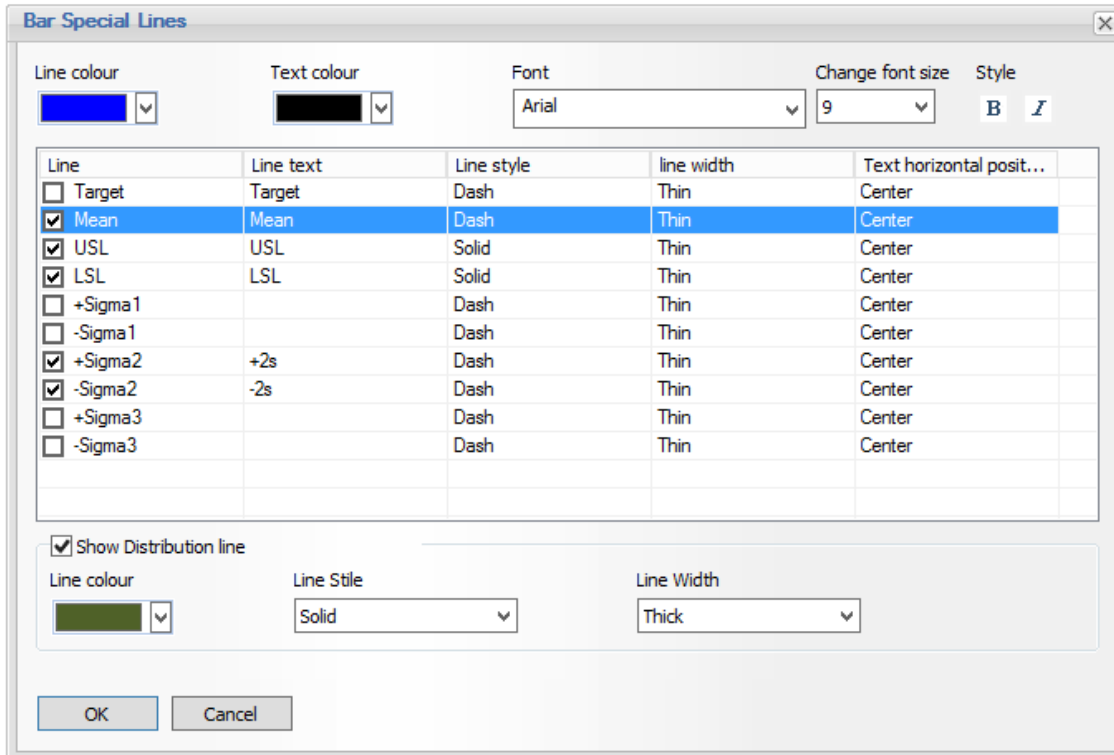

The following image shows several of the bar special lines and Histogram formatting options:

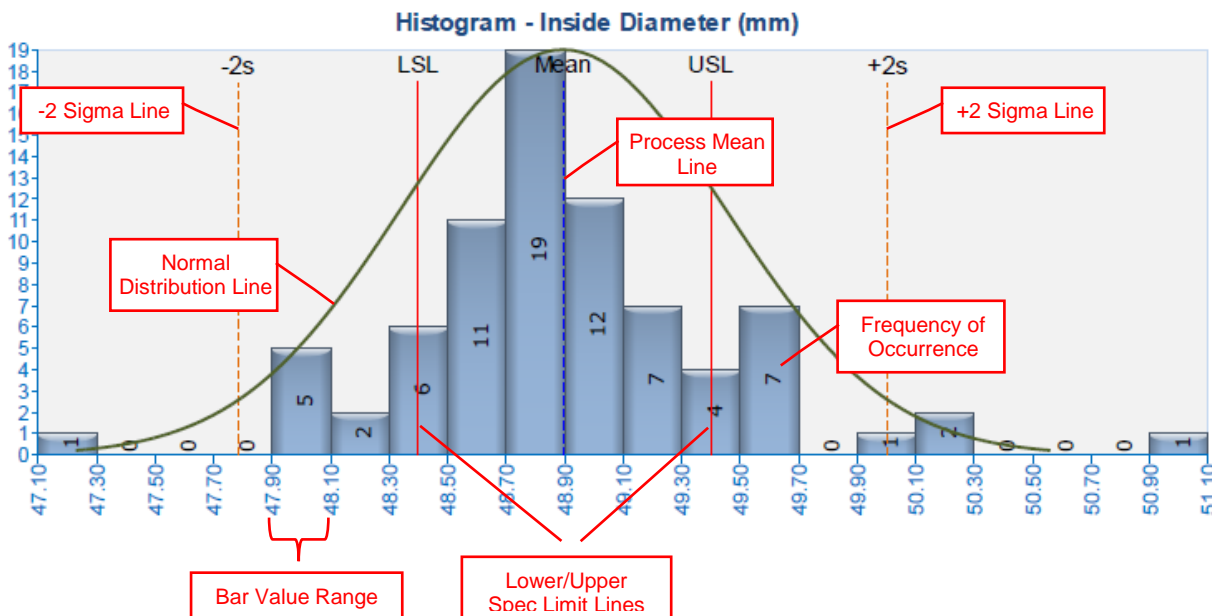



After selecting the [SPC Configuration](#) and specifying the Histogram [bar lines](#), configure the [Define Time Period](#) option to set the time period over which to chart the SPC samples. The Time Period is defined in the same way as all other Dream Report objects, and can be [Relative](#), [Absolute](#), [Fixed](#), [Calculated](#) or [Batch-based](#).

Finally, click the [Appearance](#) tab to set the general appearance settings of the Histogram, including bar type and color, background color, chart title and font, axis fonts, chart grid lines, axis units, etc.

## Histogram Table

A [Histogram Table](#) shows the distribution of the data provided from the samples over a given time period:

**Histogram Table - Inside Diameter (mm)**

Data Range	Frequency
47.10 - 47.30	1
47.30 - 47.50	0
47.50 - 47.70	0
47.70 - 47.90	0
47.90 - 48.10	5
48.10 - 48.30	2
48.30 - 48.50	6
48.50 - 48.70	11
48.70 - 48.90	19
48.90 - 49.10	12
49.10 - 49.30	7
49.30 - 49.50	4
49.50 - 49.70	7
49.70 - 49.90	0
49.90 - 50.10	1
50.10 - 50.30	2
50.30 - 50.50	0
50.50 - 50.70	0
50.70 - 50.90	0
50.90 - 51.10	1

Before using any SPC objects or statistical functions in Dream Report Studio, one or more SPC definitions should be created in the [SPC Configuration](#); or, the SPC Configuration interface can be launched from within the [SPC Histogram Table](#) object.

To add a [Histogram Table](#) to a report, select the [Histogram Table](#) icon from the [SPC menu bar](#), and select an area on the report on which to place the table.



After placing the [Histogram Table](#) object on the report, the following [Histogram Table](#) configuration window will open:



To select (or configure) an SPC configuration for the Histogram Table, select an SPC configuration name from the **SPC List**, or click the [...] button to open the **SPC Configuration** window to create a new configuration.

After a specific SPC configuration has been selected for the table, using the **Value Range** option, the rows on a Histogram Table can be configured to represent either the frequency (number of occurrences) of individual values in the data set, or the frequency of value ranges in the data set.

- **Row for Each Value** Each row in the Histogram Table will represent the frequency of occurrence of individual values in the data set selected, with values analyzed at the **Value Precision** selected. For example, if a **Value Precision** of “1” were selected, and the following raw data values were included in the data set (42.123, 42.033, 42.098, 42.144, 43.09, etc.) the number “42.1” would have a frequency of “3” on the Histogram
- **Row for Value Range** Each row in the Histogram Table will represent the frequency of occurrence of a range of values (either in **Absolute** units or a **Percentage** range) for the data set selected

In the **Columns** section, choose which of the fields (columns) you want to include in the table. The two available fields are:



## Ocean Data Systems

- **Range** Depending on the option selected in the **Value Range** section (described above) the individual data value, or value range, will be displayed under this column in each row of the table
- **Value** The frequency (number of occurrences) for each data value/value range will be displayed.

Each row in the Histogram Table will represent the frequency of occurrence of individual values in the data set selected, with values analyzed at the **Value Precision** selected. For example, the column titles (**Caption**), and for the **Range** field, the data **Precision**. For example, if Precision is set to “2” (decimal places), the ranges in each row might show something like “48.10 - 48.30”, “48.30 - 48.50”, etc...

In the **Outline Rules** section, you have the ability to set the **background color of a table row**, based on the value (range) frequency. For instance, if less than between 5 and 10 occurrences of a data value or value-range is reported, set the background color to yellow; and if greater than 10 and 15, set the background color to green. Click the “+” (or “-”) to add or (remove) conditions. Value ranges (lower and upper values) can be explicitly specified, or by double-clicking in the **From** or **To** cells, you can browse for dynamic objects on the report to reference:

And the report output:

Data Range	Frequency
47.10 - 47.30	1
47.30 - 47.50	0
47.50 - 47.70	0
47.70 - 47.90	0
47.90 - 48.10	5
48.10 - 48.30	2
48.30 - 48.50	6
48.50 - 48.70	11
48.70 - 48.90	19
48.90 - 49.10	12
49.10 - 49.30	7
49.30 - 49.50	4
49.50 - 49.70	7
49.70 - 49.90	0
49.90 - 50.10	1
50.10 - 50.30	2
50.30 - 50.50	0
50.50 - 50.70	0
50.70 - 50.90	0
50.90 - 51.10	1

Configure the **Define Time Period** option to set the time period over which to report the SPC samples. The Time Period is defined in the same way as all other Dream Report objects, and can be *Relative*, *Absolute*, *Fixed*, *Calculated* or *Batch-based*.

Finally, set the general appearance settings of the Histogram Table, including table grid and background color, fonts, table name, etc.



## Process Value Table

A **Process Value Table** shows a matrix of the values (measurements) taken for the SPC analysis, along with the calculated Average (X-bar), Range and Standard Deviation over a given time period:

SPC Samples - Inside Diameter (mm)

Sample	Values			Average	Range	Std. Dev
1	49.00	48.30	48.50	48.60	0.70	0.29
2	49.00	49.00	49.00	49.00	0.00	0.00
3	48.20	48.80	48.10	48.37	0.70	0.31
4	48.90	49.50	49.50	49.30	0.60	0.28
5	48.70	49.00	48.90	48.87	0.30	0.12
6	49.00	49.00	48.60	48.87	0.40	0.19
7	48.70	48.10	48.80	48.53	0.70	0.31
8	48.70	49.20	49.20	49.03	0.50	0.24
9	48.10	48.30	49.20	48.53	1.10	0.48
10	49.20	48.10	48.90	48.73	1.10	0.46
11	48.70	49.20	48.90	48.93	0.50	0.21
12	48.90	47.10	48.60	48.20	1.80	0.79
13	49.20	50.20	49.20	49.53	1.00	0.47
14	49.30	49.50	49.30	49.37	0.20	0.09
15	49.50	49.00	49.50	49.33	0.50	0.24
16	48.50	48.60	48.60	48.57	0.10	0.05
17	48.70	48.60	48.80	48.70	0.20	0.08
18	48.80	48.80	48.80	48.80	0.00	0.00
19	48.30	49.50	50.20	49.33	1.90	0.78
20	49.50	49.00	48.90	49.13	0.60	0.26
21	48.80	48.80	49.10	48.90	0.30	0.14
22	49.40	48.80	48.70	48.97	0.70	0.31
23	48.20	48.30	48.10	48.20	0.20	0.08
24	48.80	48.90	48.80	48.83	0.10	0.05
25	48.80	51.00	50.10	49.97	2.20	0.90
26	49.40	48.30	48.30	48.67	1.10	0.52

To add a **Process Value Table** to a report, select the **Process Value Table** icon from the **SPC menu bar**, and select an area on the report on which to place the table.

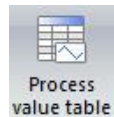

After placing the **Process Value Table** object on the report, the following **Process Value Table** configuration window will open:





**Process Value table**

Display Table Name      SPC list

SPC Samples - Inside Diameter (mm)      SPC\_InsideDiameter

Display Columns

Field	Caption	Width	Precision
<input checked="" type="checkbox"/> Sample	Sample	19	
<input checked="" type="checkbox"/> Values	Values	18	2
<input checked="" type="checkbox"/> Average	Average	18	2
<input checked="" type="checkbox"/> Range	Range	18	2
<input checked="" type="checkbox"/> Standard deviation	Std. Dev	19	2

Footer

Font Properties

Title (Table Name)      Calibri      9

Columns

Header

Footer

Change text color      Back Color      Style      Align

Grid Settings

Line Color       Show title grid

Fit rows to text

Define time period

Fixed Period

Last      1      month(s)

Duration      1      hour(s)

Start Date and Time

Day      Time

1      12:00:00 AM

OK      Cancel

To select (or configure) an SPC configuration for the Process Value Table, select an SPC configuration name from the **SPC List**, or click the [...] button to open the **SPC Configuration** window to create a new configuration.

After a specific SPC configuration has been selected for the table, select which columns to display; the column name captions; and the data precision for each data column, in the **Display Columns** section.

Depending on the number of measurements defined per SPC sample (in the **SPC Configuration**), the number of “Values” columns needed will be automatically be set when the report generated. In the example shown at the start of this section, 3 columns are shown under the “Values” heading, as the SPC Configuration was defined with 3 measurements per sample.

A table **Footer** can be included in the **Process Value Table** by clicking the “**Footer**” button, and adding the required number of footer lines by clicking the “+” button. The footer is configured in the same way as is done in the **Step Table** and **SQL Table** objects.

Configure the **Define Time Period** option to set the time period over which to report the SPC samples. The Time Period is defined in the same way as all other Dream Report objects, and can be *Relative*, *Absolute*, *Fixed*, *Calculated* or *Batch-based*.

Finally, set the general appearance settings of the Process Value Table, including table grid and background color, fonts, table name, etc.



## SPC Statistical Functions

The Dream Report SPC module includes a set of twenty SPC statistical functions that can be used in [Single Data](#), [Automatic Statistical Table \(AST\)](#) and [Step Table](#) objects.

<b>XGA</b>	The Grand Average (mean) of all samples of the selected data set, over the defined time period
<b>RA</b>	The Standard Deviation of the sample Standard Deviations of the selected data set, over the defined time period
<b>SA</b>	The Average of the sampled Ranges of the selected data set, over the defined time period
<b>UCL_XRA</b>	Upper Control Limit value in the X-bar Chart, calculated based on the RA (Range Average)
<b>LCL_XRA</b>	Lower Control Limit value in the X-bar Chart, calculated based on the RA (Range Average)
<b>UCL_XSA</b>	Upper Specification Limit value in the X-bar Chart, calculated based on the SA (Std. Dev Average)
<b>LCL_XSA</b>	Upper Specification Limit value in the X-bar Chart, calculated based on the SA (Std. Dev Average)
<b>UCL_RA</b>	Upper Control Limit value in the Range (R) Chart, calculated based on the RA (Range Average)
<b>LCL_RA</b>	Lower Control Limit value in the Range (R) Chart, calculated based on the RA (Range Average)
<b>UCL_SA</b>	Upper Control Limit value in the Standard Deviation (S) Chart, calculated based on the SA (Std. Dev Average)
<b>LCL_SA</b>	Lower Control Limit value in the Standard Deviation (S) Chart, calculated based on the SA (Std. Dev Average)
<b>CP</b>	Process Capability calculation of the selected data set, over the defined time period
<b>CPK</b>	Process Capability Index of the selected data set, over the defined time period. Adjustment of Cp for the effect of non-centered distribution.
<b>+Sigma1</b>	+1 Standard Deviation (Sigma) from the Grand Average (mean) of the selected data set, over the defined time period
<b>-Sigma1</b>	-1 Standard Deviation (Sigma) from the Grand Average (mean) of the selected data set, over the defined time period
<b>+Sigma2</b>	+2 Standard Deviations (Sigma) from the Grand Average (mean) of the selected data set, over the defined time period
<b>-Sigma2</b>	-2 Standard Deviations (Sigma) from the Grand Average (mean) of the selected data set, over the defined time period
<b>+Sigma3</b>	+3 Standard Deviations (Sigma) from the Grand Average (mean) of the selected data set, over the defined time period
<b>-Sigma3</b>	-3 Standard Deviations (Sigma) from the Grand Average (mean) of the selected data set, over the defined time period

When using any of the SPC statistical functions in a Single Data object, Automatic Statistic Table or Step Table, first select the item in question, the specific SPC Configuration name, and the time period over which to perform the statistical calculation.



# SQL Development Tools

## DSN Manager

**DSN Manager** enables users to manage configuration of all Data Source Names (DSN's) used in the project from a single interface. Dream Report supports ODBC, OLE-DB and "DSN-less" connections.

**DSN Manager** includes a user interface (**DSN Manager** window) for configuring DSNs, and a Combo Box control, which enables the selection of pre-defined DSNs in SQL tables, Combo Box objects (SQL Query data display), and Single Data Objects (SQL Query statistical function).

You can create DSN definitions in the **DSN Manager** window. To open it, click on the command button **DSN Manager** on the **Tools** ribbon icon on the horizontal toolbar either in the Dream Report Logger Studio or Dream Report Designer Studio menu (see pic. below):

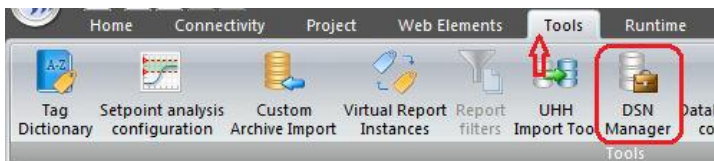

Additionally, when any of the configuration windows of either SQL table or SQL Query data display option in Combo box objects, or **SQL Query** statistical function in **Single Data** objects is opened, then the DSN selection combo box will be replaced by the following standard control.

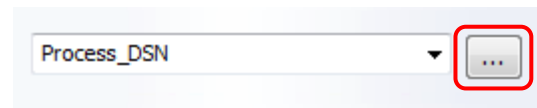

By default this control will be empty. Combo box will **not** have the list of all DSNs available in the system (i.e., defined in the Windows ODBC Manager). It will only display the list of project DSNs configured in the Dream Report **DSN Manager**, specific to this project. To open the **DSN Manager**, click on the "[...]" (browse) button. The **DSN Manager** dialog window will open:

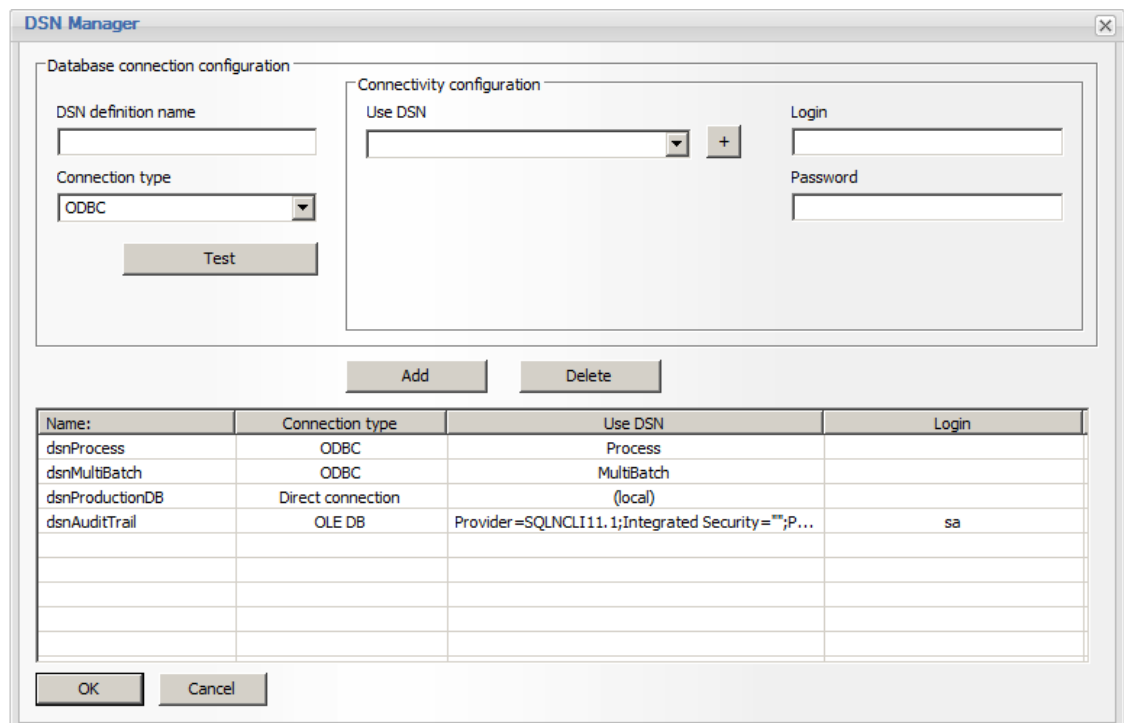



## To Configure a Database Connection

In the **DSN definition name** section, enter a unique logical name for the database connection (DSN), which will be used in further work with that DSN within the project.

In the **Connection Type** section, the user has the option of using an **ODBC**, **OLE-DB** or **Direct Connection** to connect to each database:

- **ODBC:** The **Use DSN** combo box will be filled with all DSN's (Data Source Names) defined in Windows. If using **ODBC**, select the appropriate DSN, and specify **Login** and **Password** (if needed). Click the **"Add"** button to add the database connection to the list of configured DSN's below.
- **OLE DB:** In the Use **OLE DB Provider** section, click the **"[...]"** (browse) button. The Microsoft **Data Link Properties** window will open, allowing the user to configure the connection to the specific database using **OLE DB**. **Note** - other non-SQL databases, such as process historians, can also be used, if the appropriate OLE DB driver is installed on the Dream Report machine). Once configured, click **"OK"** to close the **Data Link Properties** window, and then click the **"Add"** button to add this data source definition to the list of configured DSN's. The DSN definition (**DSN definition name**, **Use DSN** and, optionally, its **Login**) will be added to the list of project DSNs.
- **Direct Connection:** Using this option, Dream Report can use an ODBC driver to connect directly to a SQL database, without the need for first creating an ODBC DSN in the Windows ODBM Manager. This significantly simplifies project deployment to a production environment, as there is no need to re-create DSNs outside of Dream Report. Select the **Database type** (**MS SQL Server**, **MS Access**, **Oracle** and **MySQL** databases are natively supported, and other ODBC connections can be created using the **ODBC Manual Connection string** option). Depending on which **Database type** is selected, enter or select the required connection parameters. Or, if **ODBC Manual Connection string** is selected in the **Database type** list, manually enter the Connection String (you will need to know the correct syntax for the connection string - reference <http://www.connectionstrings.com/> for details on connection to most databases.) Click the **"Add"** button to add the database connection to the list of configured DSN's below.

To delete a **DSN** from a Dream Report project, select a **DSN definition** in the list and click on **"Delete"** button. A confirmation message box **"Do you want to delete selected DSN definition?"** will appear, and if **"Yes"** is clicked, the selected **DSN** will be deleted.

Clicking on the **"Test"** button will check if the connection to the selected DSN succeeded or failed. If DSN connection has failed, a message box with error will be opened. User will have to check the reasons for the DSN connection failure.

If user wants to add a **new DSN** in Windows to use in the project, click the **"+"** (add DSN) button. The standard Windows wizard **"Create New Data Source"** window will be opened and user will be able to create a new DSN definition, and then use it in the Dream Report **DSN Manager**.

### NOTES:

- All DSN configurations will be stored in the project database in the table **"Project\_DSNs"**. Login and password for each DSN will be saved in **BASE64** encoding.
- Dream Report uses the Windows **32-Bit ODBC drivers**. On 64-Bit operating systems, the 32-Bit ODBC Data Source Administrator should be used to create new data sources, which can be opened from <C:\Windows\SysWOW64\odbcad32.exe>.



## Edit SQL Query

If user clicks on [Define SQL Query](#), the dialog window, where SQL query can be defined will be opened:

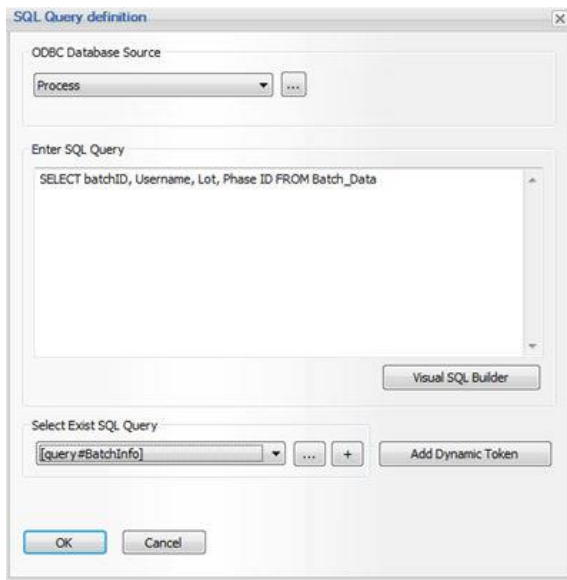

On the top of this window user has to select a DSN. If required DSN is not in the list, user can click on a button "...", and DSN manager window will be opened, where user can define required SQL query. Functionality of DSN manager is described in details in its dedicated section [DSN Manager](#).

If user want to write an SQL query by hand - he do so - just write required SQL query directly in the text box "Enter SQL query".

If user would like to build his SQL query using visual query builder tool, he has to click on the button Visual Query Builder and then visual query builder window will be opened where one can edit SQL query in a user-friendly manner.

Detailed description of visual SQL query builder can be found in its dedicated section [Visual SQL Query Designer](#). **NOTE:** Before calling visual query builder, user has to select the DSN first, otherwise, visual query builder will be opened without any database connection.

When user selects an existing data object in the same report from the combo box, just below the [Enter SQL Query](#) edit box, and clicks on the [Add](#) button, the selected field will be added to the SQL condition in the format of **[f#<Field Name>]**.

For details, please see [List of Dynamic Tokens](#) section.

User can also select any statistical object, available in the current report, and add it to the SQL query as dynamic token. TO do so, one has to click on the button "Add Dynamic Token" and then the window with the tree with all available statistical elements will be displayed, where user can select what he needs and add that selection to his SQL query.

More detailed description of selecting dynamic tokens can be found in its dedicated section [Dynamic objects selection](#).



## SQL Query Manager

**SQL Query Manager** enables Dream Report users to create the list of complete SQL queries or any parts of SQL queries and then dynamically select one-defined queries or their parts in reporting objects. This mechanism allows users to pre-define SQL query one time and then use it multiple times.

### How it works:

When defining SQL query in a statistical object, there the new section "Select existing SQL query". This section has a drop-down list with the selection of existing queries, where user can select pre-defined ready query or any sub-part of query and add it to the list. In order to edit the list of pre-defined SQL queries, user has to click a button "..."  
(browse):

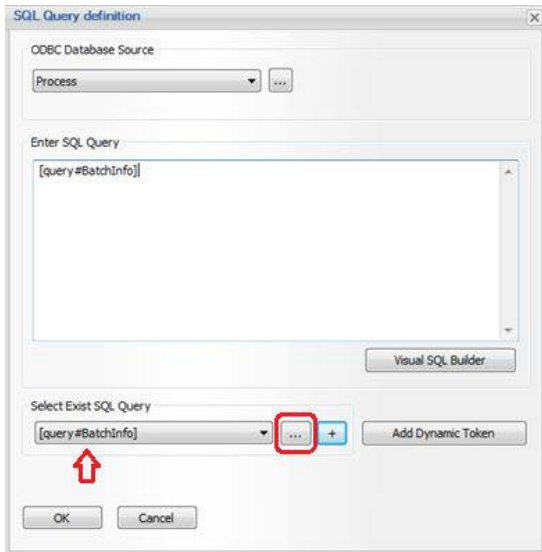

and SQL Query manager window will be opened:

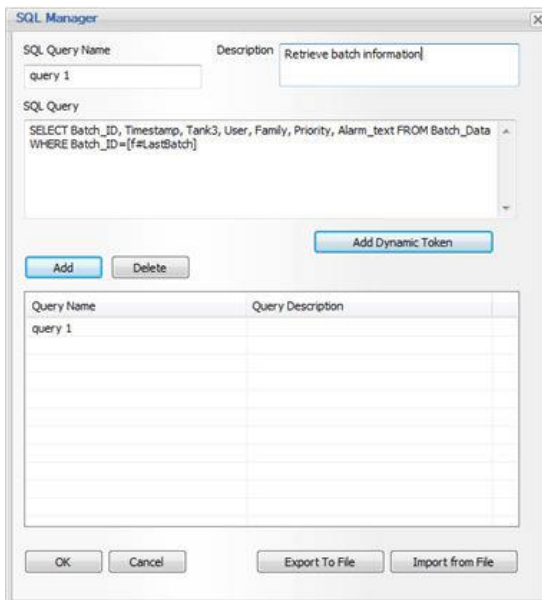



## Ocean Data Systems

In SQL manager window user can create a list of pre-defined strings, which will be then added as they are, to the result SQL query in statistical object, where that query is used.

Each entry in this list has a unique logical name, which has to be entered in **SQL query name** edit box; **Description**, which can briefly describe the purpose of that query or sub-query.

The text of **SQL query** can include any content (SQL query or any of its part or call SQL stored procedure or any other string).

The text of SQL query can be either static or it may contain dynamic objects. If user will click on **Add dynamic token** button, then dynamic object selection window will be opened, where user can select dynamic statistical reporting objects and add them to the SQL as dynamic objects. Dynamic object selection is described in details in its dedicated section [Dynamic Objects Selection](#).



## Visual SQL Query Designer

Visual SQL query designer enables Dream Report users to create and edit SQL queries using visual tools. Visual SQL query designer visually presents selected database schema and allows using mouse to set links between database tables and select which columns user wishes to select in his SQL query.

This visual query designer can be opened in any window, where SQL query has to be defined (SQL table, single data object with SQL query function, as well as pie, bar graph, button, combo box and chart).

The visual query designer window has the following design:

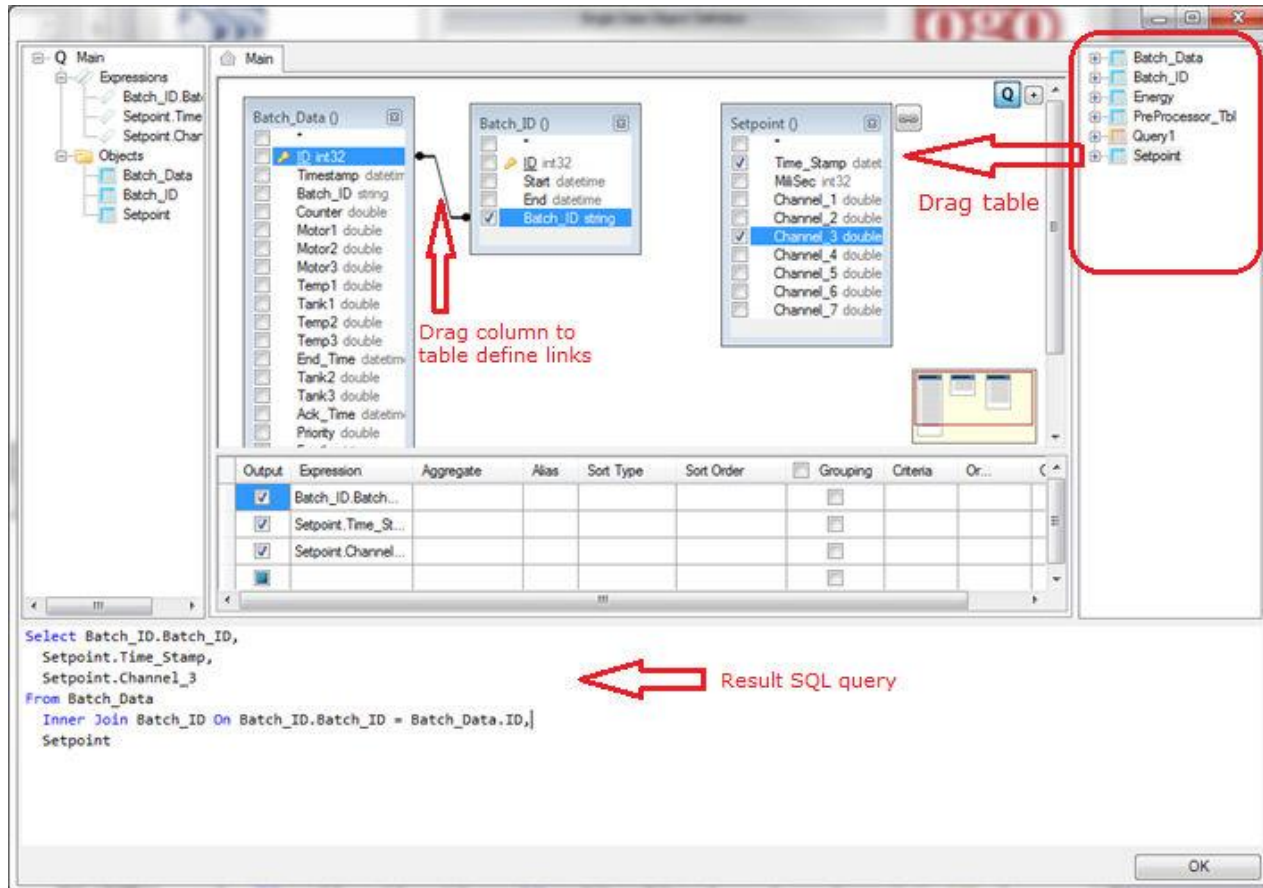





# Runtime Manager

## Runtime Management Console

Any Dream Report project can run by means of a special module - Runtime Manager (Runtime control service). This module can run either as a service (launched on the PC start) or as an application (launched on a user Windows login). To control all operations, related to the Runtime Manager (runtime service) and report generation, the Runtime Management Console (RMC) is used.

Runtime Management Console enables managing the project in Runtime, i.e. reloading the project/reports, shutting the project, providing access to different project options (project folders, Web portal, IIS configuration), Dream Report license info, help documentation, report generation on demand, while the project is running.

**Runtime Management Console (RMC)** can be launched in 3 ways:

- Double-click on the **Runtime Management Console** icon on the desktop;
- From the **Runtime Management Console** shortcut in the Startup menu;
- Click on the **Run Project** command button either on the **Runtime** ribbon icon on the horizontal toolbar, or on the vertical toolbar both in the Dream Report Logger Studio and Dream Report Designer Studios (see pic. below):

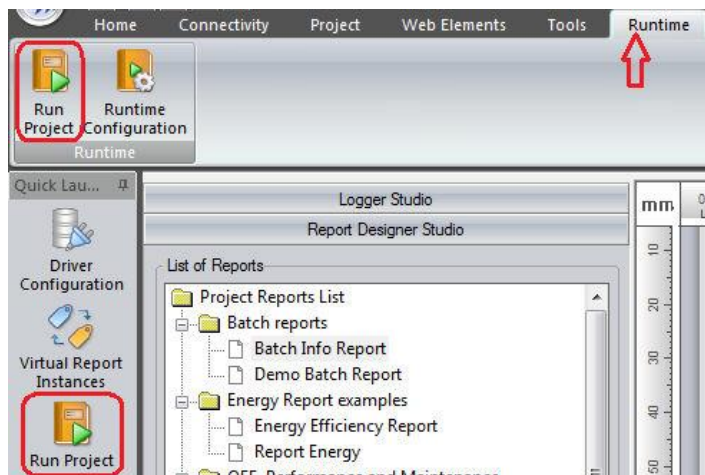

**NOTE:** If RMC is minimized, then it will hide in the system tray. If a user wants to maximize it, he can double-click on the RMC icon in the system tray or right-click it in the system tray ( then the “Open RMC” context menu will be started).

If the currently running project was modified, press the **Reload Project** button to reload the project and start using the updated project. Reloading a project has the same effect as restarting the runtime manager - the previous project will be completely closed and opened again.

**NOTE:** If, when the runtime is loaded, the following message box will pop up (please see the pic. below), user will need to install **.NET Framework 3.5 SP1**:

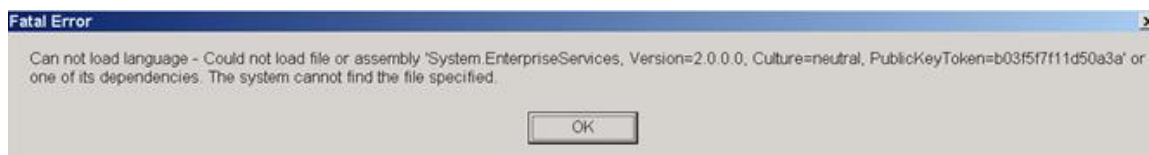



When the **Runtime Management Console (RMC)** is launched, the following dialog window will be opened:

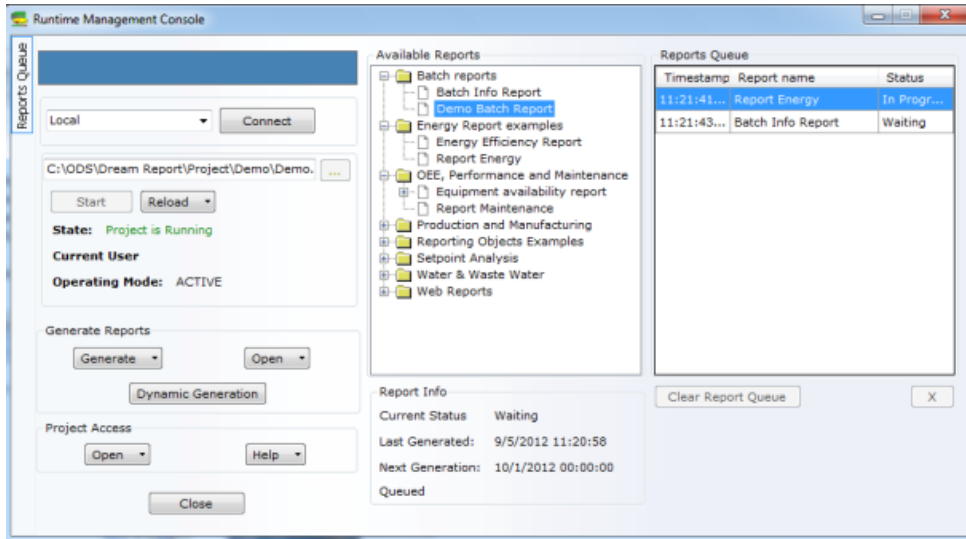

## Project Selection

The section in the left upper corner enables users to select a project, to which the RMC will be connected. There are 2 options available: “**Local computer**” and “**<Browse for more>**”.

By default it will be connected to the local computer.

If RMC is connected to the local computer, then a user can click on the “...” button. Standard Windows *Open File* dialog window will be opened, which will filter files by \*.drpj extension. User can select any \*.drpj file and start it or connect to it.

When starting the RMC, it will check if there’s any project currently running. If yes, then it will connect to it and display automatically the currently running project path in the local computer section.

If a user selects an option “**<Browse for more>**”, the network browse dialog window will be opened. There a user can select a PC, which he wishes to connect to. When the PC name is selected, the user has to click on the “**Connect**” button and the RMC will try to connect to the runtime control service, which is running on that PC. If connection can’t be established, the user will get a message box with an appropriate error. If the connection has been established, the RMC window will be updated with the information from the new project, which it’s connected to.

RMC also visualizes the following information about the project:

**State** - the status of the project performance - *Running* or *No Project is Running*.

**Current User** - the name of the project user ( if defined).

**Operating Mode** - the mode for the project, which is running, - *Active* (as master, i.e. connected to the main station) or *Passive* (in the backup mode, if the hotbackup node is configured).

The button “**Reload**” will have a drop-down menu, which will have the following entries: “**Reload project**”, “**Reload reports**”, “**Close project**”.

**NOTE:** You can also *reload project/reports* directly from the Dream Report Studio by clicking on the *Reload project* or *Reload reports* command buttons on the vertical toolbar both in the Dream Report Logger Studio and Dream Report Designer Studios (see pic. below):



If you log data into the Dream Report internal history and want to change data logging conditions for your project, please select "**Reload project**" option.

If you want to change anything in the report(s) in the project without changing/stopping data logging, please select "**Reload reports**" option.

If a user wants to shut down a project in a runtime service, then he should select the "**Close project**" option in a dropdown menu of the "**Reload**" button.

Button "**Generate**" has a drop down menu with 3 entries: "**PDF**", "**Excel**" and "**PDF and Excel**". "**PDF**", "**Excel**" and "**PDF and Excel**" entries mean which report (or instance) format will be generated. The "**Generate**" button will generate the selected report. However this will not cancel normal scheduled report generation, i.e., on demand generation is done outside the scheduling framework and will have no impact on it.

The "**Dynamic Generation**" button enables to open Dynamic Report Generator window for dynamic report generation.

**NOTE:** In Dream Report version 3.43 user could enable or disable report generation on event or on schedule directly from the Runtime Engine (by using the **Activate** column of the list control). In the new completely redesigned Runtime Manager, in order to disable automatic report generation (either on event or by schedule), user will have to go to the corresponding dialog boxes ("**Report Time Definition**" or/and "**Generate Report on Event**") of the **Report Settings** section in the Dream Report Designer Studio.

Button "**Open**" has a drop down menu with 3 entries: "**PDF**", "**Excel**" and "**PDF and Excel**". Each entry here means which report (or instance) format will be opened.

In the "**Project Access**" combo box a user can select one of the options from the drop down menu to have access to while the project is running:

- **Open project folder/Open reports folder/Open log file folder/Open web folder/Open database folder** options allow a user to have access to one of the selected project folders.
- **Open log file** option enables to open directly the log file, which has traces about errors and information of the running project.
- **Edit project** option opens Dream Report Designer studio.
- **Open web portal** option enables a user to have direct access to the Dream Report web portal.
- **Manual Value Editor** option allows direct access to the Manual Values Editor window, if, during running a project, user must enter new/ updated manual values. The **Manual values editor** window will be opened. For details, please, see **Manual Values Editor** section.
- **Configure IIS** option enables a user to configure IIS directly from the RMC.



**NOTE 1:** To have access to a project in the Dream Report Web Portal, each time a new project is started, user will have to configure IIS (Internet Information Services) for that project manually, by clicking on the **Configure IIS** button. If the IIS configuration process has succeeded, user will get the message "**IIS configuration has been successfully completed**". Otherwise, he will have to check the reason for the IIS configuration failure.

**NOTE 2:** If Internet Information Services (IIS) are not installed in your operating system, you will get the message box "**Can't configure IIS. Web portal is not enabled**". You will have, first, to instal IIS, and then, configure IIS (for details, please, see Installation Tips).

**NOTE 3:** If you upgrade Web Portal to Dream Report version 4.6, when you click "**Configure IIS**" button, you will have to agree to save the backup of your Web Portal configuration. Please, click "**Yes**" in the **IIS configurator** window, which will pop up asking: "**Do you want to backup the actual content of your project web files?**"

**NOTE 4:** IIS should be enabled on the PC before installation of MS SQL Server 2005 in Windows XP so that the different MS SQL components can be used as a service.

In the "**Help**" combo box there are 2 options, which allow:

1. Direct access to the online Dream Report help documentation ("**Help**" option).
2. Complete information about the installed Dream Report and the license, i.e. Dream Report version number, license type, license ID, company name, number of tags and concurrent web clients used in this product ("**About RMC**" option).

**NOTE:** If the license is upgraded, its data will be automatically updated by the Runtime Manager, but in the "**About RMC**" section of the "**Help**" combo box this updated information won't be shown. To see the updated license data in the "**About RMC**" section, user will need to reboot the computer.

The list of reports will be displayed in the **Available reports** list as a tree. If any report has virtual instances defined, that report will be displayed in a list as an expandable nod. When a user expands it, the list of available instances for that report will be displayed.

If a user will select any report or its instance, the section "**Report info**" will display its related information.

### Reports Queue

The **Reports Queue** section of RMC displays current status of report generation queue. The extended list will contain the list of reports which are being generated now in runtime or are waiting in the queue for generation (please see the picture below):

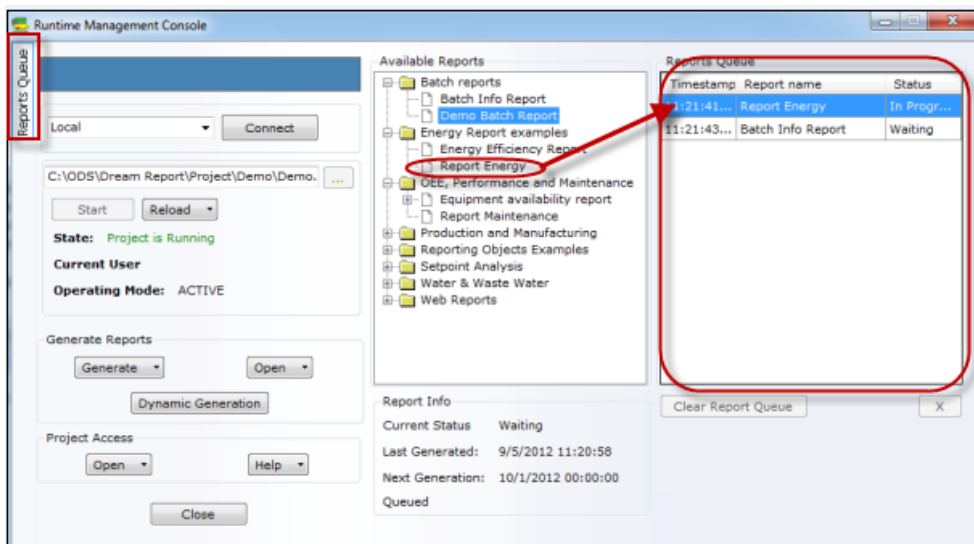



## Ocean Data Systems

To delete one or more reports from the list, click on the button “*Delete*” on the PC keyboard to remove reports from the generation queue.

If report is being generated, it will not be available for removal.

Before removing reports from the screen, a confirmation message box will be displayed: “*Do you want to remove selected reports from the generation queue?*” (Yes/No) and if you click *OK*, the selected reports will be removed from the generation queue.

If you want to close the **Reports Queue** section, click on the *Reports Queue* button in the top left corner of the RMC configuration window (as shown on the picture below):

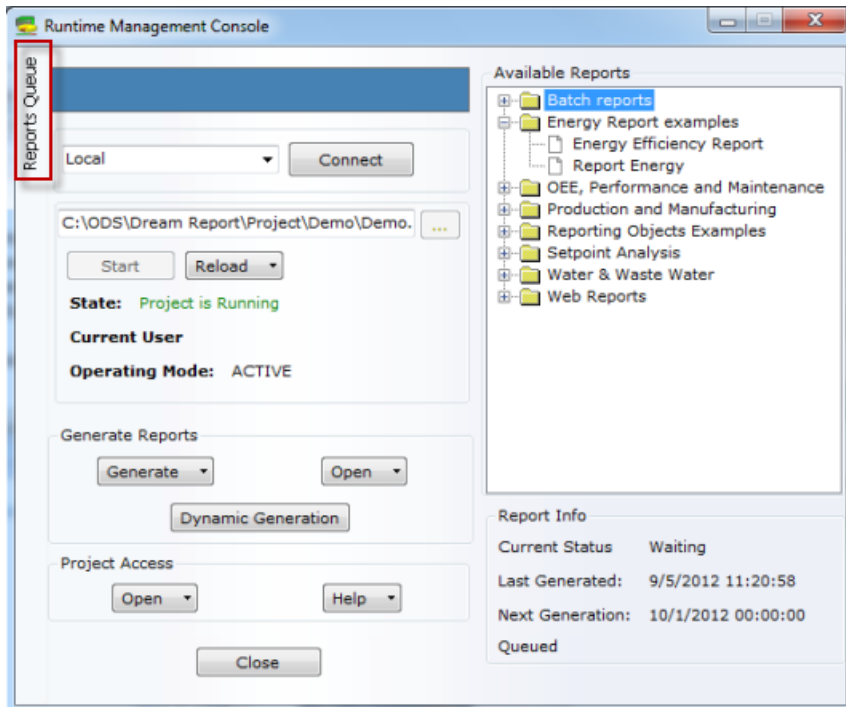

Correspondingly, if you need to open **Reports Queue**, click on the *Reports Queue* button in the top left corner of the RMC and the RMC configuration window will be expanded.

By default RMC will be opened with the **Reports Queue** section (expanded).

### User Management

If a project, which RMC is trying to connect to (either on a local or remote PC) has *User Management* enabled, then user will be prompted to enter a username and password. If login failed, the connection will be denied.

If a user tries to launch a new project and user login failed, then the project will be started anyway (in the runtime control service), but the RMC will not be connected to it.

**NOTE:** If *User Management* is activated and the RMC is minimized, then, if a user wants to maximize it, he will have to enter the login and password again.

### Switching between projects

If a project is running and a user needs to stop it and switch to another project, he will have to stop the currently running project, browse for another project and click on “*Start*”.



## New Runtime Tools - Management Console (RMC) and Dynamic Report Generator (DRG)

The Dream Report **Runtime Management Console (RMC)** has been updated in version 4.7 with a modernized “look-and-feel”:

The screenshot shows the Runtime Management Console (RMC) interface. It is divided into several sections:

- RTM CONTROL:** Shows the connection status to 'localhost', which is 'Project is running'. The project name is 'DR47\_Demo.drpj'.
- PROJECT CONTROL:** Contains a file path 'C:\ODS\Dream Report\Project\DR47\_Demo\DR47\_Demo' and four icons: Run (play), Reload (refresh), Reload Reports (refresh with document), and Stop (X).
- REPORTS:** A section with two rows of icons for generating reports in PDF, XLS, or PDF & XLS formats. A callout points to these icons with the text 'Generate: PDF, XLS, or PDF & XLS'. A larger callout points to a circular icon with a document and a plus sign, labeled 'Open Dynamic Report Generator (DRG)'. Another callout points to a circular icon with a document and a refresh symbol, labeled 'Double-Click to View Active Reports Queue'.
- AVAILABLE REPORTS:** A list of reports including 'Air Quality Report', 'Water Quality Report', 'Ad Hoc Report', 'Batch Report', 'SPC Report - Tube Height (mm)', and 'SPC Report - Tube Thickness (mm)'.
- PROJECT ACCESS:** Includes 'Open log file' and 'Help' dropdown menus, and an 'Exit' button.
- REPORT INFO:** A table showing details for the 'Air Quality Report'.
- REPORTS QUEUE:** Shows a count of '0' reports in the queue.

REPORT INFO	
Report name	Air Quality Report
Report formats	PDF
Current Status	Waiting
Last Generated:	Not Generated
Next Generation:	01/01/16 1:00:00

REPORTS QUEUE
0

The **PROJECT CONTROL** section provides functionality for running and reloading the Dream Report project:

- Run** the currently selected project
- Reload** the currently running **project**
- Reload** the **reports** in the currently running project
- Stop** the currently running project



The “**Debug Level**” of the project’s runtime engine - *Normal* or *Debug* - can be set dynamically from the RMC. From the drop-down list in the **PROJECT ACCESS** section, select either *Set Debug level of log messages* or *Set Normal Level of log messages*.

If you wish to view the list of active reports in the reports queue, double-click the **REPORTS QUEUE** text in the lower right of the RMC. The Reports Queue will then be shown on the left side of the RMC. Queued reports can be deleted, if needed, by selecting the specific report, and clicking the red “**X**” next to that report. The Report Queue can be closed by clicking the **←** button:

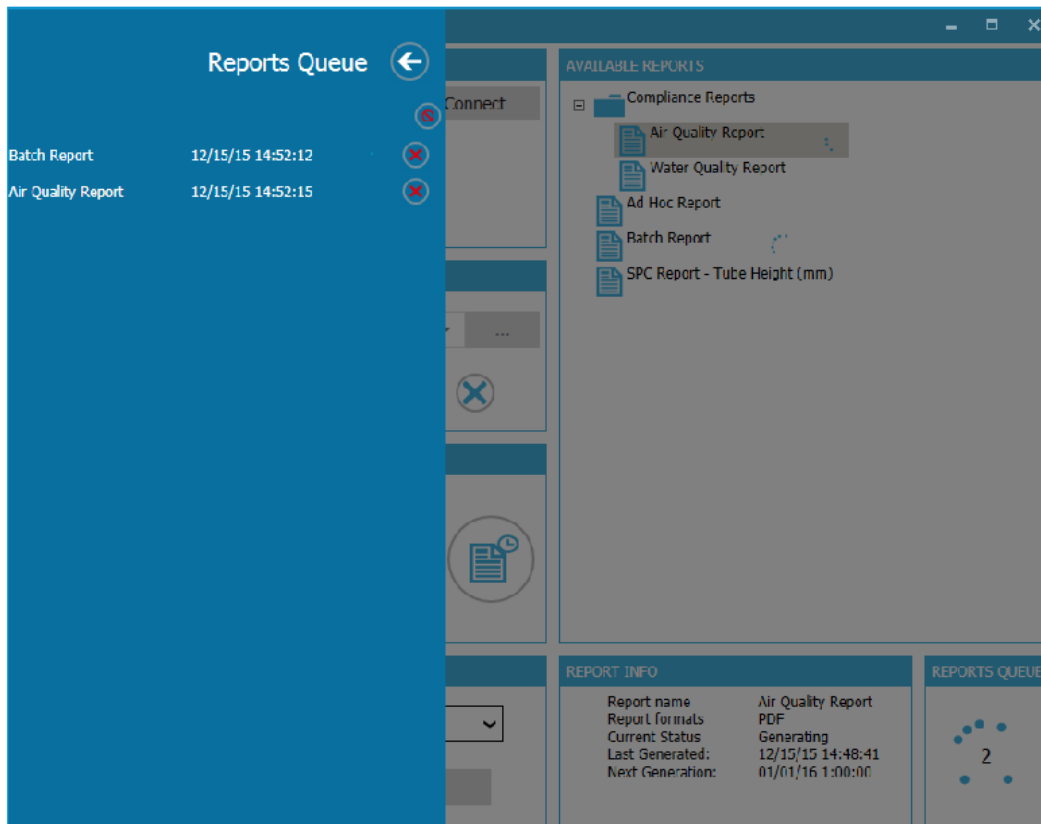

To open the new **Dynamic Runtime Generator**, click the  button in the **REPORTS** section of the **Runtime Management Console**.

## Command Lines in Runtime Manager

Dream Report Runtime Manager can execute a number of command lines. The **Command line** has the following **available formats** for generation requests:

- generate** This argument will say that generation request will be performed. The following parameters are possible:
- name** Report name
- instance** Report instance name
- fixPeriod** This argument will indicate that the fixed time period is used
- absPeriod** This argument will indicate that the absolute time period is used
- relPeriod** This argument will indicate that the relative time period is used





- batchRelPeriod** This argument will indicate that the batch-based relative time period is used
- batchAbsPeriod** This argument will indicate that the batch-based absolute time period is used
- timeStart** Time that defines start of period
- timeEnd** Time that defines end of period
- batchDef** Name of the batch definition to be uses
- batchRel** Mode for the relative batch ID (it can be "last" or "current")
- batchCount** Number of batches to count
- batchIdStart** ID of the batch for the report start
- batchIdEnd** ID of the batch for the report end
- currentTime** This argument will set the current time for the report.  
Target for the report can be "**pdf**", "**email**", "**printer**", "**excel**" (see examples below)
- fileParam** File to be used as a file with the parameters for preprocessor

**NOTE:** If **-fixPeriod** is used, then **-timeStart** has to provide one of the following arguments: "**last day**", "**last n days**", "**last hour**", "**last n hours**", "**last week**", "**last n weeks**", "**last month**" and "**last n months**", "**Current day**", "**Current hour**", "**Current week**", "**Current month**", "**Current quarter**", where **n** is a number from 1 to 500.

#### Examples:

- **rtm.exe -generate -name Report\_1 -instance Instance\_1 -fixPeriod "last 10 hours"**
- **rtm.exe -generate -name Report\_1 -instance Instance\_1 -absPeriod -timeStart "31/12/2010 00:00:00" -timeEnd "01/01/2011 00:00:00"**
- **rtm.exe -generate -name Report\_1 -instance Instance\_1 -relPeriod -timeStart 10-2:30:30 -timeEnd 5-2:30:30**
- **rtm.exe -generate -name Report\_1 -instance Instance\_1 -batchRelPeriod**
- **-batchDef MyBatch -batchRel last -batchCount 2**
- **rtm.exe -generate -name Rep1 -instance Inst1 -batchAbsPeriod -batchDef MyBatch -batchIdStart 120 -batchIdEnd 130**
- **rtm.exe -generate -name Rep1 -instance Inst1 -currentTime 2010-12-02 18:00:20**
- **rtm.exe -generate -name Rep1 -instance Inst1 -target pdf excel email printer**
- **rtm.exe -generate -name Rep1 -instance Inst1 -fileParam "C:\Data\params.xml"**

#### Examples of targets for the report:

- t pdf
- t pdf excel
- t pdf excel email
- t pdf excel email printer

#### **NOTES:**

- Report target "**printer**" will send output files for printing according to the printer settings of the report file format of the Dream Report Studio. It means that no matter which targets have been defined in the cmd command, printer will receive only those files which have been defined in the Dream Report Studio [Report Settings](#).
- If the generated report needs to be delivered to the email, user must always add the generated report output format (PDFor/and Excel) to the "**-t email**" command line.

**Example:** "**-t pdf email**" - report will be sent to the defined email with the report generated in PDF format;

"- t excel email" - report will be sent to the defined email with the report generated in Excel format;

"- t pdf excel email" - report will be sent to the defined email with the report generated in PDF and Excel format.





"Starting the Project" command line:

In order to be able to start project from the command line the following command has to be run:

"<path to RTM>\rtm.exe" -control -startproject "full project path"

Example: "C:\ODS\Dream Report\System\RTM.exe" -control - startproject "C:\ODS\Dream Report\Project\Demo\Demo.drpj"

Backward Compatibility Command Formats

For backward compatibility Runtime Manager also accepts old command formats:

generate.exe <report name> -f <period>;

generate.exe <report name> [-a, -r] <start of period> <end of period>

List of accepted parameters:

<report> - is the name of report to be generated

-f : is a fixed period for report generation.

<period> : is a period for report generation. It can have the following values: "last day", "last n days", "last hour", "last n hours", "last week", "last n weeks", "last month" and "last n months", "Current day", "Current hour", "Current week", "Current month", "current quarter" where n is a number from 1 to 500.

-a : is absolute date and time mode

<start of period> : defines the start date and time. Its format is : dd.mm.yy-hh:mm:ss, or dd/mm/yy-hh:mm:ss.

<end of period> : defines the end date and time. Its format is : dd.mm.yy-hh:mm:ss, or dd/mm/yy-hh:mm:ss.

-r is relative date and time mode

<start of period> : defines the start date and time. Its format is : dd-hh:mm:ss.

Where dd-hh:mm:ss is a number of days-hours:minutes:seconds back from the current time.

<end of period> : defines the end date and time. Its format is : dd-hh:mm:ss.

Where dd-hh:mm:ss is a number of days-hours:minutes:seconds back from the current time.

Batch-based command-line parameters:

generate.exe <report name> -br <"Batch Name"> <mode> <count> - batch-based report generation.

<"Batch Name"> - specifies name of batch definition, which will be used to get batch IDs for report generation

<mode> - specifies batch mode. It can have 2 possible values: Last or Current

<count> - specifies how many batch IDs to include into the range. It may have only positive whole values, e.g. 1, 2, 3...

Example: generate.exe "Energy Report" -br "Prod\_Batch" Last 1 - will generate report for 1 last batch, using "Prod\_Batch" batch definition.

generate.exe <report name> -ba <"Batch Name"> <"StartBatchID"> <"EndBatchID"> - absolute batch-based report generation.

<"Batch Name"> - specifies name of batch definition, which will be used to get batch IDs for report generation

<"StartBatchID"> - specifies start batch ID

<"EndBatchID"> - specifies end batch ID

This option will generate report for the range of batches between <"StartBatchID"> and <"EndBatchID">. DRG will identify the start time of the <"StartBatchID"> and the end time of the <"EndBatchID"> and generate report for that time period.

User can also specify the same batch ID both for <"StartBatchID"> and <"EndBatchID">, then the report will be generated for that 1 specified batch ID.

Example: generate.exe "Energy Report" -ba "Prod\_Batch" "10-9937" "10-9937" - will generate the report for batch ID "10-9937" using "Prod\_Batch" batch definition.



## Runtime Configuration

**Runtime Settings** enable users to configure controls, which will be applied to the runtime service and RMC. Click on the **Runtime Configuration** command button on the Runtime ribbon icon on the horizontal toolbar both in the Dream Report Logger Studio and Dream Report Designer Studios (see pic. below):



The **Runtime Settings** dialog window will be opened:

**Start mode** section contains configuration controls, which will be applied to the runtime service (Runtime Manager), which it's currently connected to.

The option **“Run as application”** or **“Run as service”** is applicable to the PC, which Runtime Manager is currently connected to. This setting is saved on a PC, where the Runtime Manager is connected to. The runtime control service (RM) will run either as an application or as a service.

If **“Run as service”** option is selected, then the runtime control service will write itself into Windows startup and will be launched on a PC start. If **“Run as application”** option is selected, then the runtime control service will be launched on a user Windows login.

Default selection for the **“Start mode”** section is: **“Run as application”**.

**NOTE:** Runtime configuration control options (**“Run as service”** or **“Run as application”**) can influence the performance of Custom Archive Import Tool (CAIT) and **UHH Import Tool**. If either CAIT or UHH Import Tool is launched via Runtime Manager and import is performed to/from SQL Server, please make sure that Runtime Manager is running under user who has an authorized access to SQL Server.

**Startup Options** section enables to set automatic startup runtime service and select the project that will be launched on a PC start.

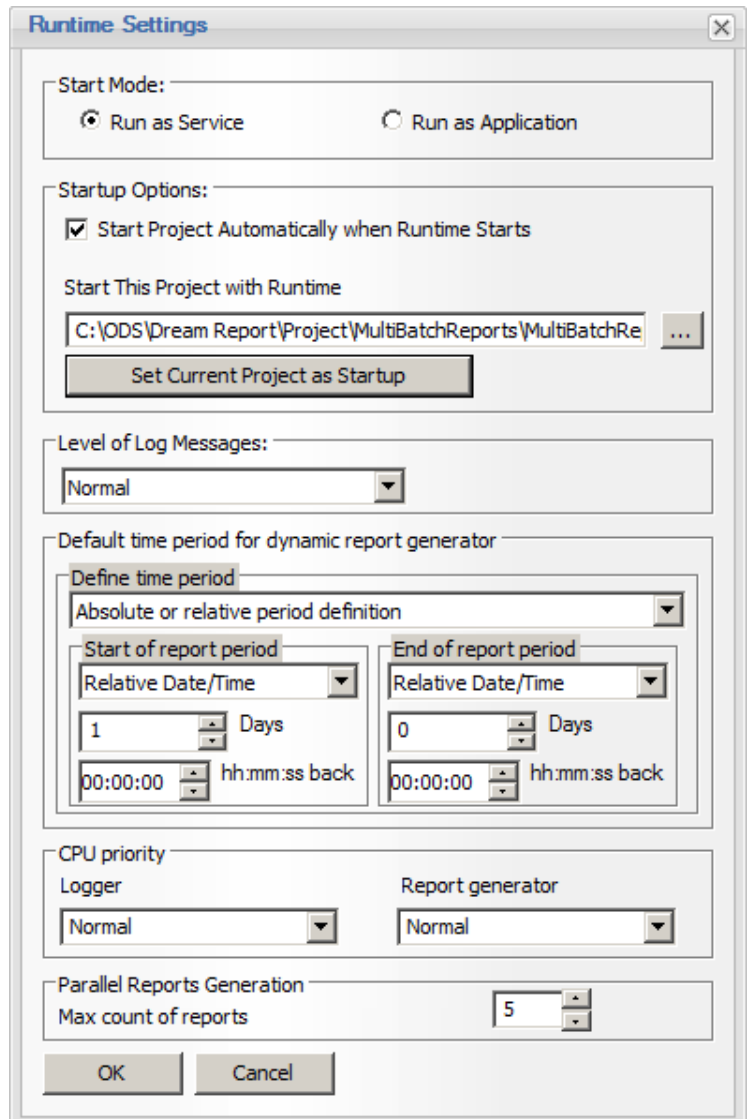



## Ocean Data Systems

If the check box "[Start Project Automatically When Runtime Starts](#)" is checked, the runtime service will be added to the Windows startup section and will be automatically launched either in the **Run as service** or **Run as application** mode. Then, on a PC start, the runtime service will be launched with the last launched project.

In the "[Start this project with runtime](#)" edit box a user can select with the "..." (browse) button the path of the project, that will be launched with the runtime service on a PC start.

If a user clicks on the button "[Set current project as startup](#)", the current project path will appear in the "[Start this project with runtime](#)" edit box. Then, on a PC start, the runtime service will be launched with this current project.

**Default time period for dynamic report generator** section enables to define time period which will be displayed as default when the Dynamic Report Generator will be opened.

**Level of log messages** combo box enables configuring the level to control which message of the severity of the event, that has occurred, will be actually printed out to the log.

2 options are available:

- Normal** - it is the default log level, where only the events with a severity of NOTICE or greater will be logged.
- Debug** - it is the level, where all events will be logged, and its debugging messages will be very important for diagnosing configuration problems

### CPU Priority

The **CPU priority** for different Dream Report runtime tasks can be adjusted, if necessary, to balance resources on a machine running other processes.

The default priority for all processes is "**Normal**".

If user wants to modify CPU priority, there is the ability to set CPU priority for data logger and for report generator. There are 5 levels of CPU settings:

- Critical high
- High
- Normal
- Low
- Very low

If the CPU priority will be set to a certain level, than the process may gain more performance or lose performance comparing to other running processes.

If you modify CPU priority - that change will take effect only after PC restart. Restarting PC is required to change CPU priority.

### Parallel Reports Generation

The **Parallel Reports Generation** option allows the user to specify how many reports can run (generate) simultaneously. The default is **5 reports**. If more than the specified number of reports are triggered at the same time (e.g., multiple reports scheduled to run at midnight) then the additional reports will be queued to run upon completion of one of the reports running in parallel. In larger reporting applications - i.e., applications either with a large number of reports scheduled to run at the same time, or a large number of active DRWeb users - it is advisable to increase the **Max count of Reports** option to allow for faster report generation. Please note that the higher number of simultaneously generated reports will impact CPU usage, so make sure that there is sufficient CPU bandwidth available.



## Dynamic Report Generator

**Dynamic Report Generator (DRG)** is a module that generates reports on demand, where the time period for the report is selected by a user at runtime or the list of tags, which will be used for specific report generation, is selected manually in runtime.

DRG is implemented as a standard Windows application (**generate.exe**).

**NOTE:** While installing Dream Report® DRG will be also installed as ActiveX component, and user will be able to integrate it as part of the HMI System.

**Dynamic Report Generator** window can be opened either from the Windows start menu “**Dynamic Report Generator**” or from Runtime Management Console (RMC).

To open Dynamic Report Generator from RMC user will have to click on "**Dynamic Generation**" button.

The following **Dynamic Report Generator** configuration window will be opened:

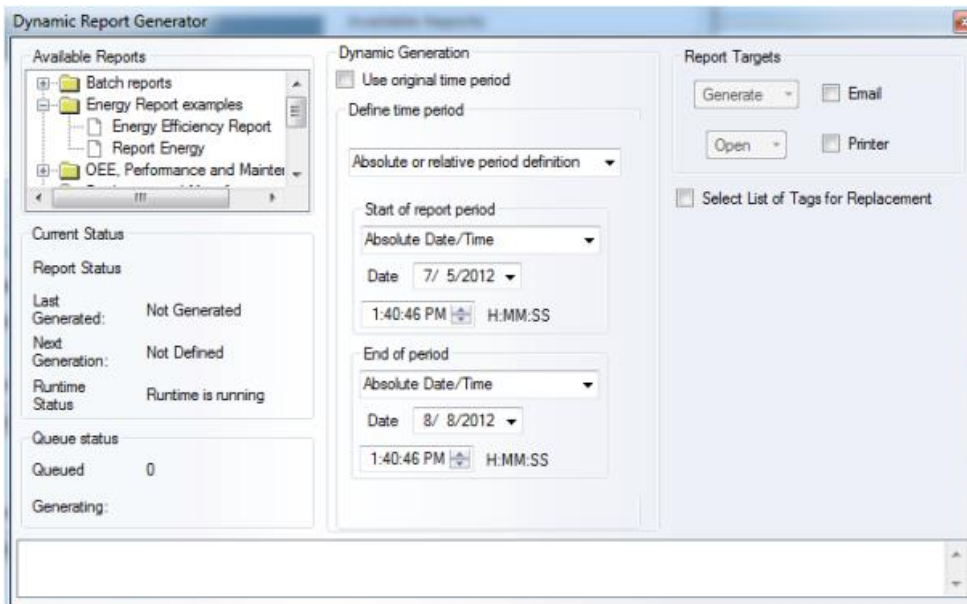

### Purpose of use:

The DRG can generate predefined reports for the currently running project, changing report definition properties at runtime, such as the time period and item. All dynamic modifications of the report properties will be done only for that specific report execution and will not be saved in the report layout. If you have a running project containing a daily report, and you generate this report using DRG, applying a new period of 1 hour, it will generate an hourly report file from it. The original report will continue to run and generate daily reports as before.

The Dream Report **Dynamic Report Generator** has been updated in version 4.7 with a modernized “look-and-feel”:



DRG has 2 working modes: **Silent** and with **User interface**.

### Silent Mode

If a user runs generation command with additional command line parameters, DRG will not open any user interface and will execute the command in a silent mode, i.e. pass command to the runtime manager to generate the selected report for the specified period.

The **Command line** has the following **available formats** for generation requests:

- generate** This argument will say that generation request will be performed. The following parameters are possible:
- name** Report name
- instance** Report instance name
- fixPeriod** This argument will indicate that the fixed time period is used
- absPeriod** This argument will indicate that the absolute time period is used
- relPeriod** This argument will indicate that the relative time period is used
- batchRelPeriod** This argument will indicate that the batch-based relative time period is used
- batchAbsPeriod** This argument will indicate that the batch-based absolute time period is used
- timeStart** Time that defines start of period
- timeEnd** Time that defines end of period
- batchDef** Name of the batch definition to be uses



## Ocean Data Systems

- batchRel** Mode for the relative batch ID (it can be "last" or "current")
- batchCount** Number of batches to count
- batchIdStart** ID of the batch for the report start
- batchIdEnd** ID of the batch for the report end
- currentTime** This argument will set the current time for the report.  
Target for the report can be "**pdf**", "**email**", "**printer**", "**excel**" (see examples below)
- fileParam** File to be used as a file with the parameters for preprocessor

**NOTE:** If **-fixPeriod** is used, then **-timeStart** has to provide one of the following arguments: "**last day**", "**last n days**", "**last hour**", "**last n hours**", "**last week**", "**last n weeks**", "**last month**" and "**last n months**", "**Current day**", "**Current hour**", "**Current week**", "**Current month**", "**Current quarter**", where **n** is a number from 1 to 500.

### Examples:

- **rtm.exe -generate -name Report\_1 -instance Instance\_1 -fixPeriod "last 10 hours"**
- **rtm.exe -generate -name Report\_1 -instance Instance\_1 -absPeriod -timeStart "31/12/2010 00:00:00" -timeEnd "01/01/2011 00:00:00"**
- **rtm.exe -generate -name Report\_1 -instance Instance\_1 -relPeriod -timeStart 10-2:30:30 -timeEnd 5-2:30:30**
- **rtm.exe -generate -name Report\_1 -instance Instance\_1 -batchRelPeriod -batchDef MyBatch -batchRel last -batchCount 2**
- **rtm.exe -generate -name Rep1 -instance Inst1 -batchAbsPeriod -batchDef MyBatch -batchIdStart 120 -batchIdEnd 130**
- **rtm.exe -generate -name Rep1 -instance Inst1 -currentTime 2010-12-02 18:00:20**
- **rtm.exe -generate -name Rep1 -instance Inst1 -target pdf excel email printer**
- **rtm.exe -generate -name Rep1 -instance Inst1 -fileParam "C:\Data\params.xml"**

### Examples of targets for the report:

- t pdf
- t pdf excel
- t pdf excel email
- t pdf excel email printer

### **NOTES:**

- Report target "**printer**" will send output files for printing according to the printer settings of the report file format of the Dream Report Studio. It means that no matter which targets have been defined in the cmd command, printer will receive only those files which have been defined in the Dream Report Studio [Report Settings](#).
- If the generated report needs to be delivered to the email, user must always add the generated report output format (PDFor/and Excel) to the "**-t email**" command line.

**Example:** "**-t pdf email**" - report will be sent to the defined email with the report generated in PDF format;  
**"- t excel email"** - report will be sent to the defined email with the report generated in Excel format;  
**"- t pdf excel email"** - report will be sent to the defined email with the report generated in PDF and Excel format.

### **"Starting the Project" command line:**

In order to be able to start project from the command line the following command has to be run:

**"<path to RTM>\rtm.exe" -control -startproject "full project path"**

**Example:** "C:\ODS\Dream Report\System\RTM.exe" -control - startproject "C:\ODS\Dream Report\Project\Demo\Demo.drpj"

### **Backward Compatibility Command Formats**

For backward compatibility DRG also accepts old command formats:

**generate.exe <report name> -f <period>;**





**generate.exe <report name> [-a, -r] <start of period> <end of period>**

**List of accepted parameters:**

**<report>** - is the name of report to be generated

**-f** : is a fixed period for report generation.

**<period>** : is a period for report generation. It can have the following values: "last day", "last n days", "last hour", "last n hours", "last week", "last n weeks", "last month" and "last n months", "Current day", "Current hour", "Current week", "Current month", "current quarter" where n is a number from 1 to 500.

**-a** : is absolute date and time mode

**<start of period>** : defines the start date and time. Its format is : *dd.mm.yy-hh:mm:ss*, or *dd/mm/yy-hh:mm:ss*.

**<end of period>** : defines the end date and time. Its format is : *dd.mm.yy-hh:mm:ss*, or *dd/mm/yy-hh:mm:ss*.

**-r** is relative date and time mode

**<start of period>** : defines the start date and time. Its format is : *dd-hh:mm:ss*.

Where *dd-hh:mm:ss* is a number of days-hours:minutes:seconds back from the current time.

**<end of period>** : defines the end date and time. Its format is : *dd-hh:mm:ss*.

Where *dd-hh:mm:ss* is a number of days-hours:minutes:seconds back from the current time.

**Batch-based command-line parameters:**

**generate.exe <report name> -br <"Batch Name"> <mode> <count>** - batch-based report generation.  
<"Batch Name"> - specifies name of batch definition, which will be used to get batch IDs for report generation

<mode> - specifies batch mode. It can have 2 possible values: **Last** or **Current**

<count> - specifies how many batch IDs to include into the range. It may have only positive whole values, e.g. 1, 2, 3...

**Example:** `generate.exe "Energy Report" -br "Prod_Batch" Last 1` - will generate report for 1 last batch, using "Prod\_Batch" batch definition.

**generate.exe <report name> -ba <"Batch Name"> <"StartBatchID"> <"EndBatchID">** - absolute batch-based report generation.  
<"Batch Name"> - specifies name of batch definition, which will be used to get batch IDs for report generation  
<"StartBatchID"> - specifies start batch ID  
<"EndBatchID"> - specifies end batch ID

This option will generate report for the range of batches between <"StartBatchID"> and <"EndBatchID">. DRG will identify the start time of the <"StartBatchID"> and the end time of the <"EndBatchID"> and generate report for that time period.

User can also specify the same batch ID both for <"StartBatchID"> and <"EndBatchID">, then the report will be generated for that 1 specified batch ID.

**Example:** `generate.exe "Energy Report" -ba "Prod_Batch" "10-9937" "10-9937"` - will generate the report for batch ID "10-9937" using "Prod\_Batch" batch definition.

**User Interface Mode**



## Ocean Data Systems

In the user interface window, as shown on the picture below, user can define the period and type of report generation:

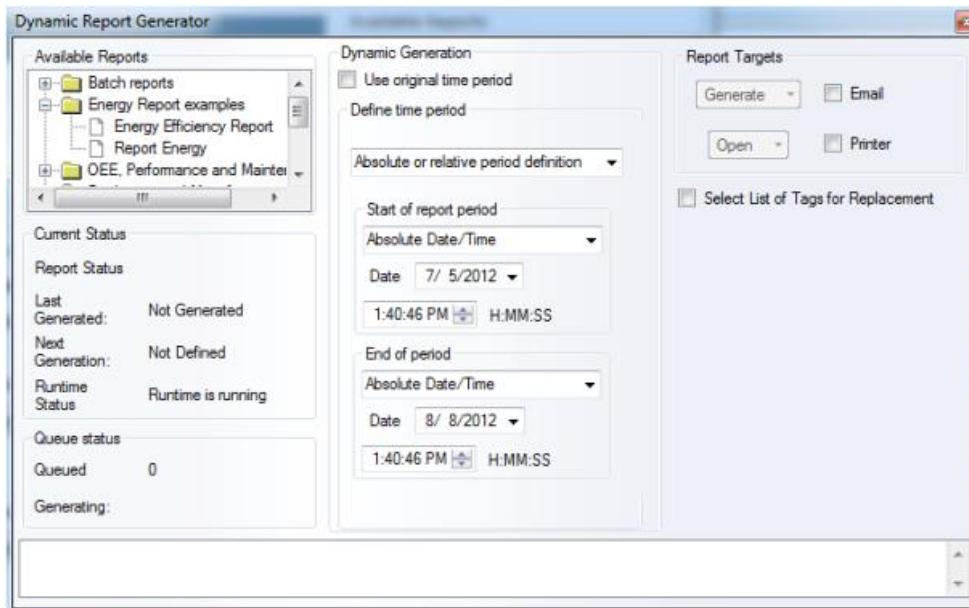

First, from the **Available reports** list, select the report you will need to generate.

If you wish to dynamically modify the time period for the report for the entire report generation, specify a new report period in the "**Define time period**" section. For complete description of the time period definition, please, go to the Time Period Definition section of this manual.

If you wish to generate report with original settings (as it is defined in the Designer Studio), enable "**Use original time period**" check box (please, see pic. below):

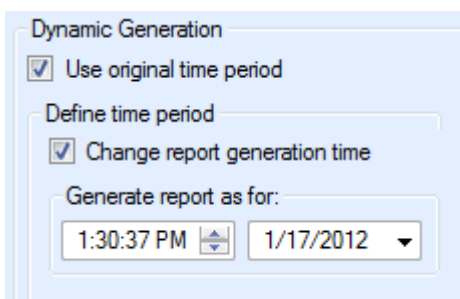

If you wish to "replay previous reports", i.e. to generate a report with the original period definition but using an earlier generation time (generate the report as if it was another date or another time), please, enable the option "**Use original time period**" and enable the option "**Change report generation time**". Then set the date and time for which you would like to generate reports.

**Example:** If you have a weekly report, and you are generating the report on 27 January, and originally your report would display data from 20-27 of January, then, if you set **Change report generation** option to 17 January, it will display data from 10-17 of January.

The **Current Status** section will display the status of the report defined for generation ("**Report Status**") and the status of the defined report in the queue of reports that are being generated ("**Queue Status**").

In the **Report Targets** section you can select the format for the report generation: **PDF**, **XLS (Excel)**, **PDF and XLS**, **Printer**, **Email** (please, see pictures below):



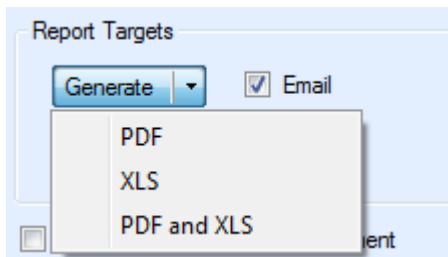
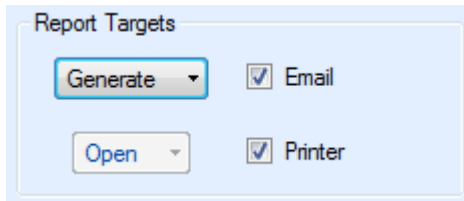

After having selected the report, the desired time option, time period and format for report generation, click the [Generate](#) button, and the report will be generated forcing all objects from the specified report to use time period, defined here by the user.

#### NOTES:

- You can select one of these options: **PDF**, **XLS**, **PDF and XLS** by clicking on the option, that you need, on [Generate](#) button, and the report will be generated in the format you have chosen;
- If you want to use any of the following report target options - **Email/Printer/Excel** - for dynamic report generation, they need to be enabled and configured in the [Report File Format](#) section of Report Settings in the Designer Studio.

#### Dynamic Tag Selection

Dynamic tag selection in Dynamic Report Generator allows to manually select the list of tags, which will be used for specific report generation.

**NOTE:** Dynamic tag selection can be applied only to Item Tables, Automatic Statistical Tables (ASTs) and Charts.

If the "[Select List of Tags for Replacement](#)" check box is checked, then the [Dynamic Tags' List](#) control will appear (please see the pic. below):



## Ocean Data Systems

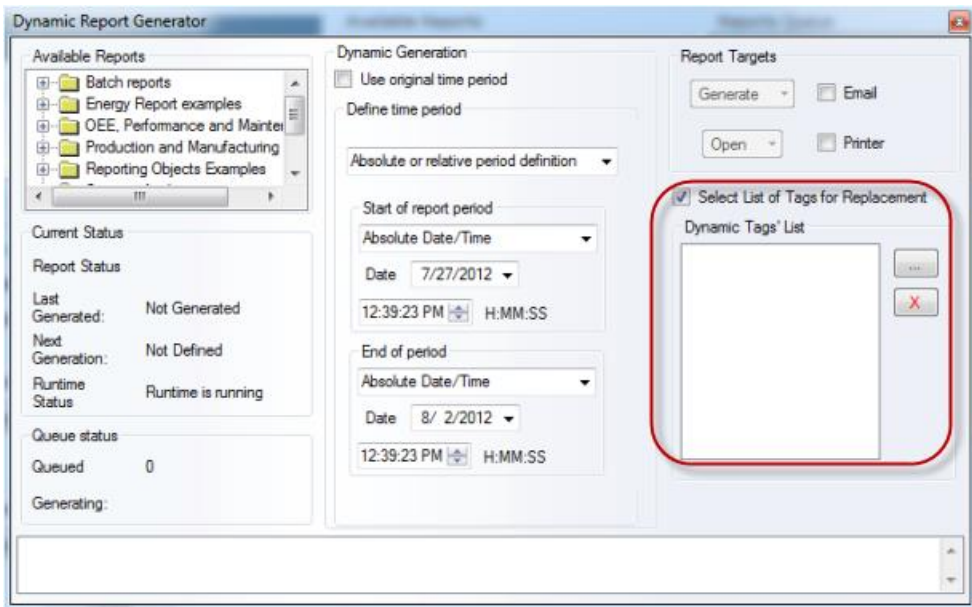

If you click on the "..." (browse) button next to the **Dynamic Tags' List**, the following **Select Data Items** dialog window to browse and select tags for the list will be opened:

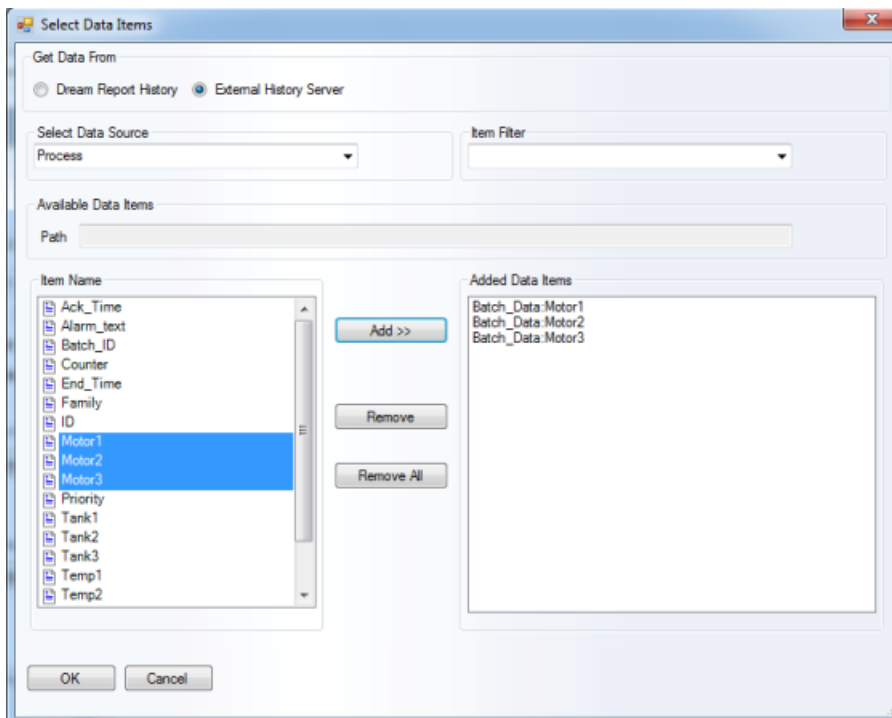

Select data source type (**Get Data From**) and then the combo box with data sources will be filled with the list of available drivers of that type (**Select Data Source**). As soon as the driver has been selected, the left list control (**Item Name**) will be filled with the complete list of tags from the selected driver.



## Ocean Data Systems

The list can display a folder (branch) or a tag (leaf). **Path** edit box displays the current path from the browse root. **Item Filter** can filter an item list using all available wild characters (\*, ?).

After selecting tags click **OK** – and they will be filled in the **Dynamic Tags' List** part of the Dynamic Report Generator window (please see the pic. below):

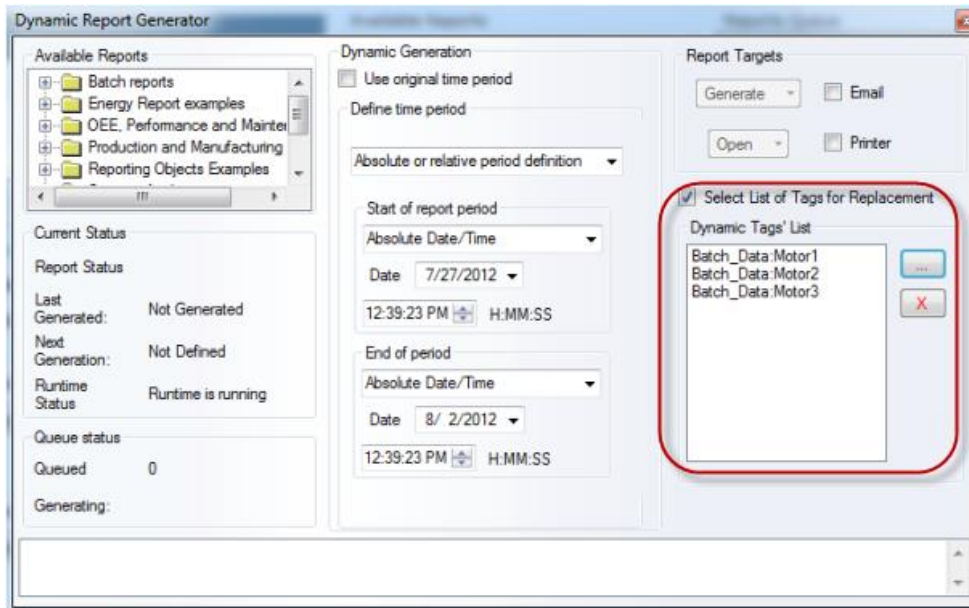

When the report will be generated, the Runtime Manager will fill the list of tags into the report generation command and the report will be generated for the selected tags.

If the tag list is empty, the report will be generated as it is.

If you click on  button (**Clear list**), the list of selected tags will be cleared.



# Communication Drivers

## List of Communication Drivers

Dream Report enables you to connect to the various heterogeneous data sources and acquire real-time data, real-time alarms and also access external proprietary history servers in order to avoid duplication of the historical data.

Therefore, Dream Report has three types of drivers:

- [Real-Time Data Access Drivers](#)
- [Real-Time Alarm Access Drivers](#)
- [External History Access Drivers](#)

### Open communication protocols:

- [OPC Data Access \(DA\) driver](#)

Supports standard OPC DA 1.0 and 2.0. Detailed description can be found in the section [OPC Drivers](#).

- [OPC Alarm & Event \(AE\) driver](#)

Supports standard OPC AE. Detailed description can be found in the section [OPC Drivers](#).

- [OPC History Data Access \(HDA\) driver](#)

Supports standard OPC HDA 1.2. Detailed description can be found in the section [OPC Drivers](#).

- [BACnet \(Building Automation Control Networks\)](#)

BACnet driver provides complete integration of Dream Report and BACnet data systems. It provides access to real-time data of all standard data objects. It also provides access to BACnet alarms and BACnet native history (trend objects), and generating reports directly from it.

- [ODBC driver](#)

Provides automated access to any automation open database, which supports ODBC interface (e.g. SQL Server, Oracle, MySQL, MS Access etc.). Easy configuration interface is provided. Detailed description can be found in the section [ODBC Driver](#).

- [OLE DB driver](#)

Provides automated access to any automation open database, which supports OLE DB interface (e.g. SQL Server, Oracle, MySQL, MS Access as well as PI, iHistorian etc.). Easy configuration interface is provided.

- [CSV/Text Data and Alarm Collector](#)

The driver provides automated browse of data items and automated periodical data extraction from any types of text files. The driver periodically checks for data updates in specified data file(s), and converts this data into the Dream Report database. Then it's available for fast and efficient report generation as well as can be accessed in an open standard database for any third party application.

- [Excel Data Import \(EDI\) driver](#)

Provides periodical access to specific Excel file(s) or checks for specific folder(s) (optionally including subfolders) and imports all new data.



## Proprietary and Custom communication drivers:

- **DeltaV** (Emerson Process Management) - **Full Set**

Based on OPC with customized connection mechanism, DeltaV driver includes real-time data, real-time alarm and native history access.

- **Wonderware OPC driver** - **Data Access (DA)**

This driver allows connecting to the Wonderware data servers (e.g. Application Server, InTouch, etc.) via FS Gateway OPC server and exchange data with it (read values, receive value updates, write values back to it). Wonderware OPC driver has special functionality to connect to FS Gateway server only once from both the Runtime manager and the Designer studio using only one client connection, complying with FS Gateway single client limitation. Detailed description can be found in the section [Wonderware OPC Driver](#).

- **Eurotherm Review** (Eurotherm) - **History Access (HDA)**

Proprietary history access driver for Review product line of Eurotherm. This driver enables history data extraction, history messages extraction and has also support for native batch of Review. **NOTE:** This driver is protected by special license option and is not available for open use. To obtain license option for Eurotherm Review, please, contact Eurotherm HQ (Worthing UK) or your Dream Report distributor.

Detailed description can be found in the section [Eurotherm Review/UHH Driver](#).

- **iFix** (GE Fanuc/Intellution) - **Full Integration**

iFix driver provides complete integration of Dream Report and iFix SCADA system. This driver provides access to real-time data, real-time alarms for logging into the Dream Report database as well as access to proprietary history of iFix (HDA/HDD).

- **iHistorian** (GE Fanuc/Intellution) - **History Access (HDA)**

The proprietary history access driver for iHistorian database of Intellution. This driver provides automated item browse as well as enables history data extraction, history alarm extraction from local or remote iHistorian server. No configuration is needed except for IP address of remote history server (if server is located on the remote machine).

- **PC Vue** (Arc Informatique) - **Full Integration**

PC Vue driver provides complete integration of Dream Report and PC Vue SCADA system. The driver provides access to real-time data, real-time alarms for logging into the Dream Report database as well as an access to the proprietary history of PC Vue. The driver is web-enabled, i.e. is using web services for communication and can provide data acquisition over the Internet.

- **TVIEW** History Access Driver - **History Access**

The proprietary history access driver for TVIEW SCADA system of TechnoTrade.

- **Wizcon** (Wizcon Systems) - **Full Integration**

Wizcon driver provides complete integration of Dream Report and Wizcon SCADA system. The driver provides access to real-time data, real-time alarms for logging into the Dream Report database as well as access to the proprietary history of Wizcon.

- **SNMP** (Simple Network Management Protocol) - **Real-Time Data Access**

SNMP driver for Dream Report provides you with an automatic browsing of network devices, exchanging SNMP data and trap messages.



Dream Report Driver Listing

Company	Product	Connectivity
<b>ARC Informatique</b>	PcVue	Real-time Data Real-time Alarms Historical Data HDS Items HDS Alarms
<b>Aspentech</b>	IP 21 Plant Historian	Historical Data
<b>B-SCADA</b>	Status Enterprise Edition Status Machine Edition	Real-time Data Real-time Alarms Historical Data Historical Alarms
<b>BACNET Standard</b>	BACNET	Real-time Connectivity Real-time Alarms Historical Values and Trend Objects
<b>CSV (Comma Separated Variable) Standard</b>	CSV and other Delimited Files	Tags and Data Values Alarm Listings
<b>Echelon</b>	iLON SmartServer	Real-time Data Real-time Alarms Historical Data Historical Alarms
<b>ELUTIONS (Wizcon)</b>	ControlMaestro	Real-time Data Real-time Alarms Historical Data Historical Alarms
<b>Emerson Electric</b>	Delta-V	Real-time Data Real-time Alarms Historical Data Historical Alarms
<b>Eurotherm</b>	Eurotherm Recorders	Real-time Data (MODBUS)
<b>Eurotherm</b>	Review Historian	Historical Data Historical Alarms & Messages Real-time Batch Monitor
<b>Eurotherm</b>	UHH History Files UHH DB	Historical Messages Historical Data Batch Data
<b>GE Intelligent Platforms GE-IP</b>	Proficy Historian (iHistorian)	Historical Data Historical Alarms
<b>GE Intelligent Platforms GE-IP (GEFANUC)</b>	Proficy HMI/SCADA CIMPLICITY	Historical Data Historical Alarms
<b>GE Intelligent Platforms GE-IP (Intellution)</b>	Proficy HMI/SCADA iFIX	Real-time Data Real-time Alarms Historical Data Historical Alarms Historical Alarms
<b>Honeywell/Gamewell</b>	FCI Fire Control Instruments, 7100, 7200, E3	Real-time Data
<b>Loytec</b>	LWEB-801 Database Server LWEB-801/900	Historical Data Historical Alarms



## Ocean Data Systems

Company	Product	Connectivity
<b>Microsoft Excel Files</b>	Excel Workbooks	Extract Real-time Values
<b>Microsoft SQL Server</b>	Relational Database	Historical Data Historical Alarms Record Data Batch Data
<b>Mitsubishi</b>	Mitsubishi M-Net Protocol for HVAC	Real-time Data
<b>MODBUS Standard</b>	MODBUS Ethernet MODBUS Serial	Real-time Data
<b>MySQL</b>	Relational Database	Historical Data Historical Alarms Record Data Batch Data
<b>Ocean Data System</b>	Remote Driver Access (Remote Web Services Connection to Dream Report Drivers)	Real-time Data Historical Data
<b>Ocean Data Systems</b>	Dream Report	Simulated Real-time Data Simulated Real-time Alarms Simulated History Data Simulated History Alarms LUA Simulated History
<b>ODBC Standard</b>	ODBC Open DataBase Connectivity	Real-time Data Historical Data Historical Alarms
<b>OLE DB Standard</b>	OLE DB (Object Linking and Embedding for Databases)	Real-time Data Historical Data
<b>OPC Foundation Standards</b>	OPC UA (Real-time) OPC DA (Data Access) OPC AE (Alarms and Events) OPC HDA (Historical Data)	Real-time Data Real-time Alarms Historical Data
<b>Oracle</b>	Relational Database	Historical Data Historical Alarms Record Data Batch Data
<b>OSI Software</b>	PI Historian	Historical Data
<b>Rockwell Automation</b>	RSView32	Historical Data
<b>Schneider Electric</b>	PowerLogic ION	Historical Data
<b>Schneider Electric</b>	StruxureWare Historian	Historical Data
<b>Schneider/Citect</b>	Citect	Native Historical Data Native Historical Alarms Real-time Data Real-time Alarms
<b>Schneider/Citect</b>	Citect Historian	Historian Data Historian Alarms
<b>Schneider/Indusoft</b>	Indusoft Studio	Real-time Data Historical Data Historical Alarms
<b>Schneider/Wonderware</b>	FS Gateway OPC	OPC DA Interface
<b>Schneider/Wonderware</b>	Wonderware Application Server (MX)	Real-time Data



## Ocean Data Systems

Company	Product	Connectivity
<b>Schneider/Wonderware</b>	Wonderware Historian	Historical Data Historical Alarms
<b>Schneider/Wonderware</b>	Wonderware WWALM Historical Alarms	Historical Alarms
<b>Schneider/Wonderware</b>	InTouch Local/Remote Nodes	Real-time FS Gateway Data
<b>Schneider/Wonderware</b>	IntelaTrac History	Historical Data
<b>Schneider/Wonderware</b>	InTouch LGH History Files	Historical Data
<b>Semaphore Software</b>	TView	Historical Data Historical Alarms
<b>Siemens</b>	WIN-CC	Real-time Data Real-time Alarms Historical Data Historical Alarms
<b>Siemens</b>	SIMATIC S7 200, 300, 400	Real-time Data
<b>Siemens</b>	DesigoV4PX	Historical Data
<b>SNMP Standard</b>	SNMP (Simple Network Management Protocol)	Real-time Data Trap Data
<b>Trihedral</b>	VTScada	Historical Data
<b>Yokogawa</b>	DX, FX, FX GP Recorders	Real-time Data (MODBUS) Historical Data Batch Data Historical Alarms and Event





## Data Source Definition

Dream Report logger has ability to connect to one or multiple data sources and to collect online data, alarms and to have direct history access for data and alarms.

**Data source (driver)** definition can be done in the **Communication Configuration Wizard** dialog box, which can be opened from either Logger Studio or Report Designer Studio menu. Click on the command button *Driver Configuration* either on the **Connectivity** ribbon icon or the *Driver Configuration* button also located on the left vertical toolbar:

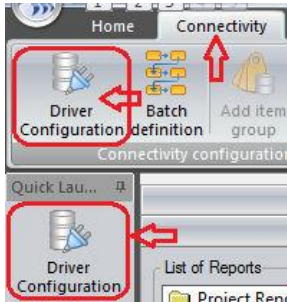

Data source selection will be displayed as a tree:

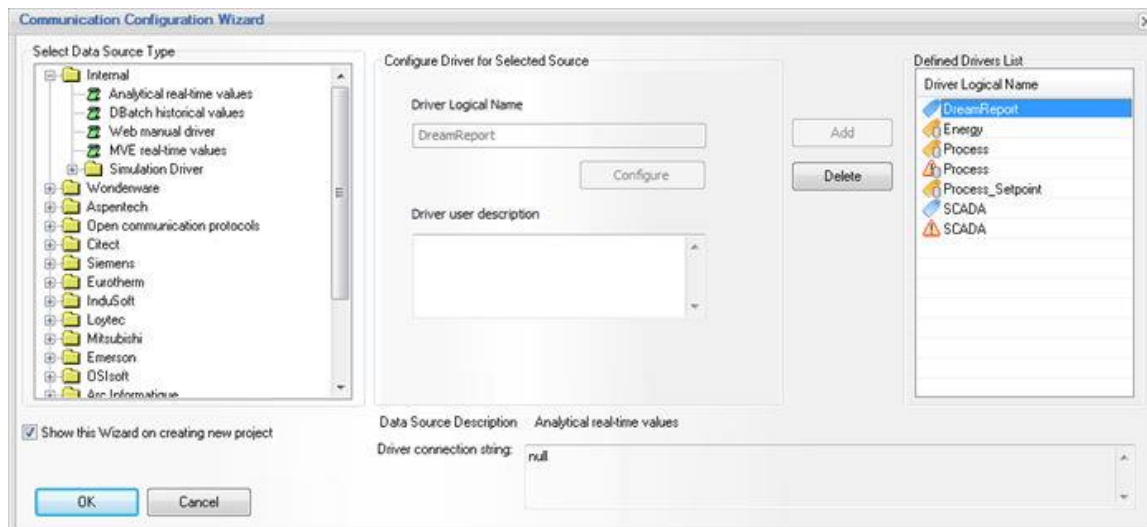

The first browse level will be the list of data source vendors. All first level browse will be displayed as folders.

**NOTE:** In Dream Report version 3.43 each driver, when configured, had only one driver instance with one, two or three subdivisions (according to the types of data to access) for configuration, i.e., the driver could have maximum three options available for configuration: **Data Driver (real-time values)**, **Alarm Driver** and **History Driver**.

**Example:** The ODBC History Access driver had one instance both for historical data and historical alarms configuration.

The Eurotherm (Review) driver had one instance for both real-time and historical data access configuration.

Now, in this new version of Dream Report, each driver has separate instances for each type of data to access ( real-time, alarms, historical values), which should be configured separately.

**Example:** The ODBC driver has now two instances and should be configured separately as "**ODBC historical values**" (for historical data) or/and "**ODBC historical alarms**" (for historical alarms).

The Eurotherm (Review) driver has now three instances and should be configured separately as "**Historical values in Review or UHH database**", "**Historical alarms/messages in Review or UHH database**" or "**Real-time batch monitor**".



When you open "**Internal**" folder, the following list when expanded will be displayed:

- **Analytical** real-time values
- **Web** manual driver
- **Simulation Driver** (displayed as a folder):
  - Simulation Driver real-time values
  - Simulation Driver real-time alarms
  - Simulation Driver historical values
  - Simulation Driver historical alarms
- "**Open communication protocols**" folder will display the following list of open communication protocols:
- **CSV** (displayed as a folder). List when expanded:
  - Tag values in CSV files
  - Alarms in CSV files
- **Excel** Data Import real-time values
- **FCI** real-time values
- **Modbus** (TCP/IP, RS232, ASCII) (displayed as a leaf node)
- **ODBC** folder will display two entries:
  - ODBC historical values
  - ODBC historical alarms
- **OLE DB** folder will display:
  - OLE DB historical values
  - OLE DB historical alarms
- **OPC driver** (displayed as a folder). List when expanded:
  - OPC DA (real-time values)
  - OPC AE (real-time alarms)
  - OPC HDA (history data access)
- **SNMP** real-time values and traps V1 and V2
- **BACnet** driver (displayed as a folder). List when expanded:
  - BACnet real-time values
  - BACnet real-time alarms and events
  - BACnet historical values from trend objects
- "**Wonderware**" folder will display:
  - Application Server (local or remote)
  - WW Historian
  - InTouch historical values (LGH files)
  - InTouch Native/ SuiteLink Protocol over TCP/IP real-time values
  - WWALM Historical Alarms



- "**Aspentech**" folder will display only one entry:

- Aspen IP 21 database access

- "**Citect**" folder will display:

- Citect real-time values
- Citect real-time alarms
- Citect historical values
- Citect historical alarms

- "**Siemens**" folder will display:

- Desigo historical values

- **WinCC**

- WinCC real-time values
- WinCC real-time alarms
- WinCC historical values
- WinCC historical alarms

- "**Emerson**" folder will display:

- OPC DeltaV real-time values
- OPC DeltaV real-time alarms
- OPC DeltaV historical values
- OPC DeltaV historical alarms

- "**Wizcon**" folder will display:

- Wizcon Native real-time values
- Wizcon Native real-time alarms
- Wizcon Native historical values
- Wizcon Native historical alarms

- "**Echelon**" folder will display:

- iLon SmartServer real-time values
- iLon SmartServer real-time alarms
- iLon SmartServer historical values
- iLon SmartServer historical alarms

- "**Loytec**" folder will display:

- LWEB-801 database access

- "**Mitsubishi**" folder will display:

- Mitsubishi real-time values

- "**Arc Informatique**" folder will display:

- PcVue HDS Alarms
- PcVue HDS Items
- PcVue real-time values (using Web Services)
- PcVue real-time alarms (using Web Services)
- PcVue historical values (using Web Services)
- PcVue real-time values (using OPC)



- **"Techno Trade"** folder will display:
  - TView historical values
  - TView historical alarms
- **"Intellution"** folder will display:
  - iFix Native real-time values
  - iFix Native real-time alarms
  - iFix Native historical values
  - iFix Native historical alarms
  - iHistorian Connectivity historical values
  - iHistorian Connectivity historical alarms
- **"Eurotherm"** folder will display:
  - Real-time values in controllers (using Modbus)
  - Historical values in Review or UHH database
  - Historical alarms/messages in Review or UHH database
  - Real-time batch monitor
  - UHH DB historical messages
  - UHH DB historical values
  - UHH DB batch monitor

When configuring any historical driver (values or alarms in Eurotherm Review/UHH), user will see a check box, asking to create automatically batch definitions for every Instrument/Group. If checked, then, on adding a driver, Dream Report will automatically generate batch definitions for every instrument/group, found in selected Review/UHH database.

When the type of driver is selected from the Data source tree, it will automatically appear in the **Driver Logical name** box for configuration. To configure driver communication parameters, button *Configure* will open driver configuration dialog box. If driver doesn't have any configuration interface, that button will be disabled.

Data access, alarm and history access drivers have to be configured separately and independently.

OPC DA driver can be configured differently from the OPC AE driver.

History access enables using proprietary history of external data server for report generation.

When source is configured, it can be added to a general list of data sources, defined in a project, by clicking on *Add* button. The source configured will appear in the **Defined drivers list**. Button *Delete* will delete selected source from the list.

**NOTE:** If you need to configure the same driver more than once, then, after having configured it the first time, you'll just need to click in the **"Select Data Source Type"** field on any other driver and then go back to the driver that you need to configure.

When all the communication settings for the project are done, click *OK*, and the driver configuration will be finished.

For detailed information on how to configure different types of drivers, please, see related parts of the [Communication Drivers](#) section.



## Supported GE Intelligent Platforms Software

The following versions of GE Intelligent Platforms software are supported in Dream Report:

**Proficy Historian**

Versions 3.5, 4.5 and 5.0

**Proficy iFix**

Version 3.5 and later, up to and including 5.8

**Proficy Cimplicity**

Version 6.1 and later, up to and including 9.0



## Cimplicity historical values driver

This driver provides automated values browse and extraction from local or remote SQL server.

To configure **Cimplicity historical values driver**, first, open the **Communication Configuration Wizard** dialog window. In the **General Electric** folder, please, select the Cimplicity historical values driver from the **Select data source type** section, and click on "**Configure**" button:

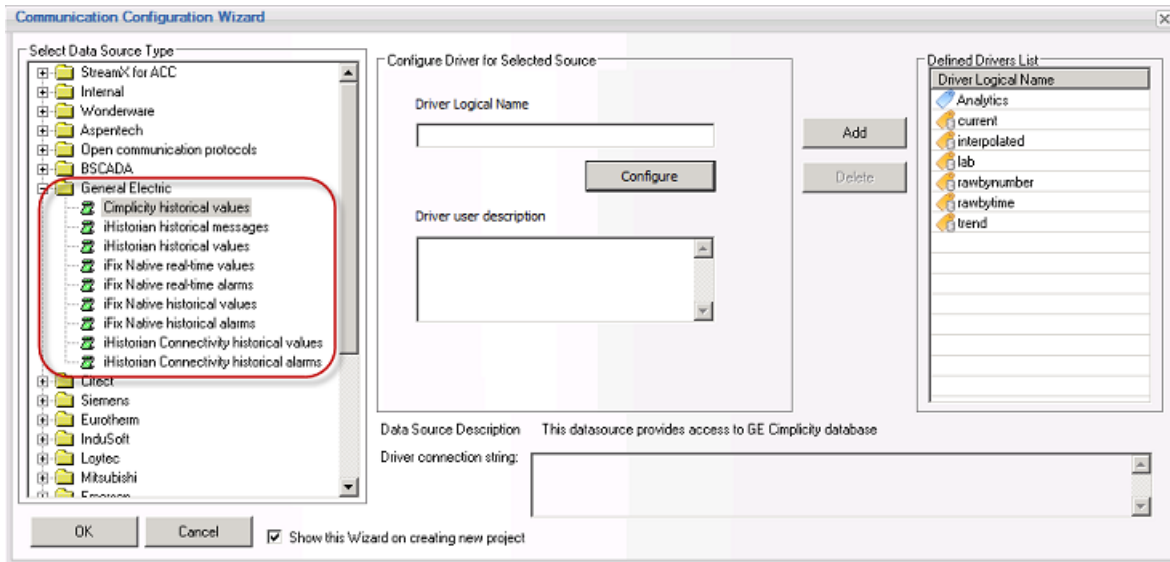

If **Cimplicity historical values** communication driver is selected, then, as soon as you click on "**Configure**" button, the following **Cimplicity Historical Driver Configuration Dialog** window will be opened:

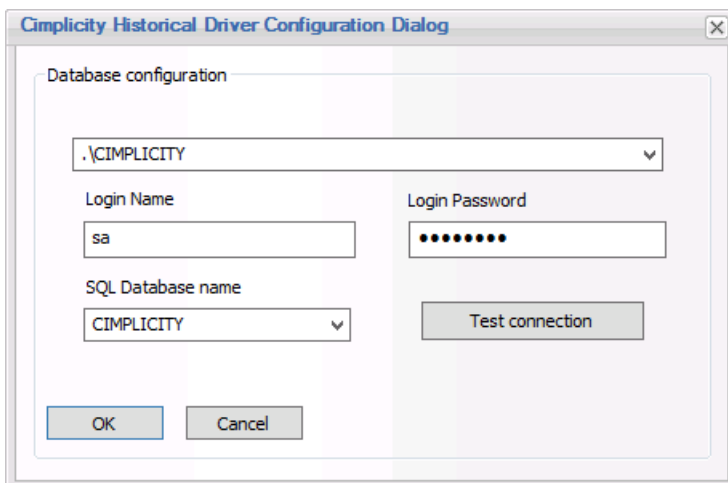

This window allows you to define database configuration for getting access by **Cimplicity historical values driver**.

The upper popup box gives you the opportunity to determine either local or remote SQL server instance. Please click on the "**Down**" arrow at the right side of the popup box and you will see the list of available SQL server instances, both local and network.

If the SQL server is configured with user authentication, then enter "**Login Name**" and "**Login Password**" for the SQL Server into the corresponding edit boxes.

If your SQL Server is configured with Windows Authentication mode, leave the "**Login Name**" and "**Login Password**" edit boxes blank.



## Ocean Data Systems

Then you need to select proper **"SQL Database name"** from the popup box list by clicking on the **"Down"** arrow at the right side of the popup box.

The **"Test Connection"** button will try to establish communication to the selected database based on SQL Server.

After clicking on **"OK"** button you will return to the **"Communication Configuration Wizard"**. Then you need to assign **"Driver Logical Name"** for the selected data source. When the source is configured, it should be added to a general list of data sources, defined in a project, by clicking on **"Add"** button. The configured source will appear in the **Defined drivers list**. Button **"Delete"** will remove selected source from the list.

When all the communication settings for the project are done, click **"OK"**, and the data source configuration will be finished.



## GE Proficy Historian Historical Messages driver

This driver provides automated history alarms and events extraction from a local or remote Proficy Historian server.

**NOTE:** If you have already been using the **iHistorian Connectivity historical messages** driver in your project with an older version of Dream Report you will need to reconfigure your **"Defined Drivers List"** in your project after the Dream Report version upgrade to **Proficy Historian historical messages driver** (i.e. remove **iHistorian Connectivity historical messages** driver from the list and add a properly configured **Proficy Historian historical messages** driver to it). Please make sure that the **"Driver Logical Name"** for the new driver is the same as the **"Driver Logical Name"** as the old one, in order to avoid internal project logical inconsistency.

The driver can be configured to expose historical messages (*Alarm* or *Event*) values, found under the **"General Electric"** section of the **Dream Report Communication Configuration Wizard**:

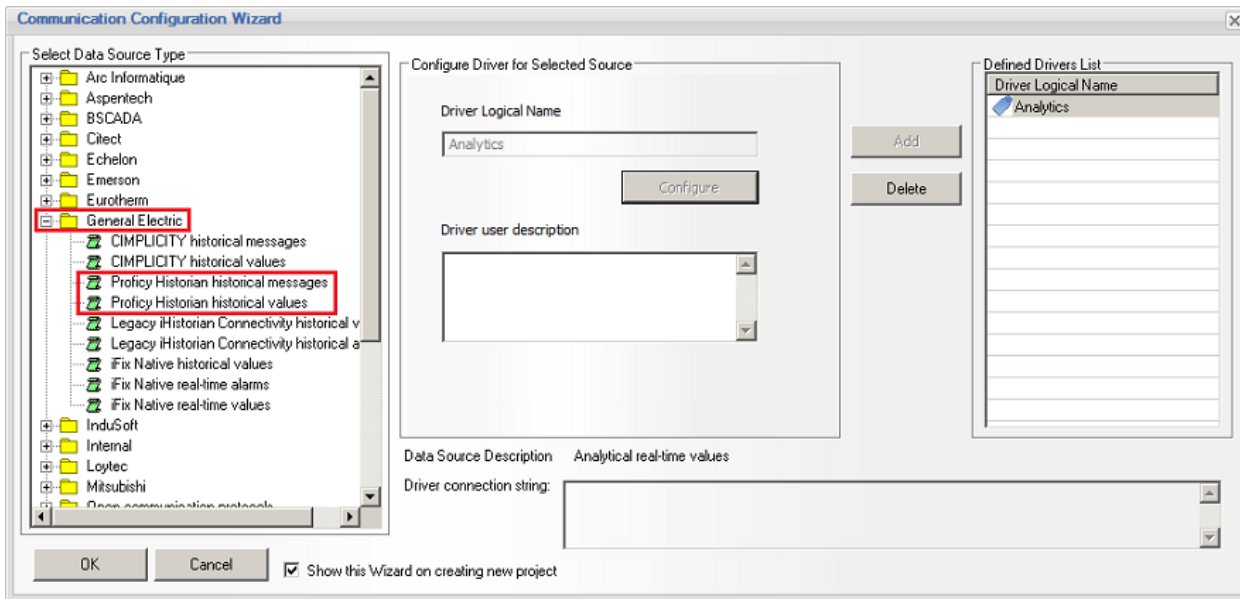

Select the **Proficy Historian historical messages** driver from the **General Electric** drivers folder of the **Select Data Source Type** section (as shown in the image above).

The **"Configure"** button will be enabled, which, when clicked, will open the GE Proficy **iHistorian driver settings** dialog window:

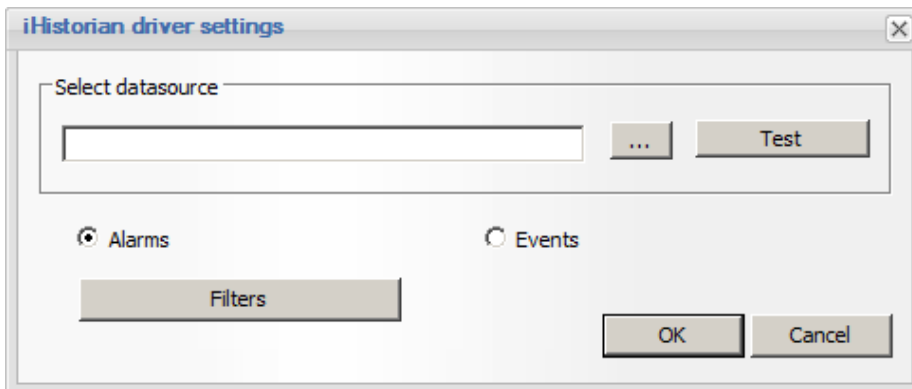





## Ocean Data Systems

1. In the **Select Datasource** section, click the browse button [...] to select the iHistorian OLE DB Provider:

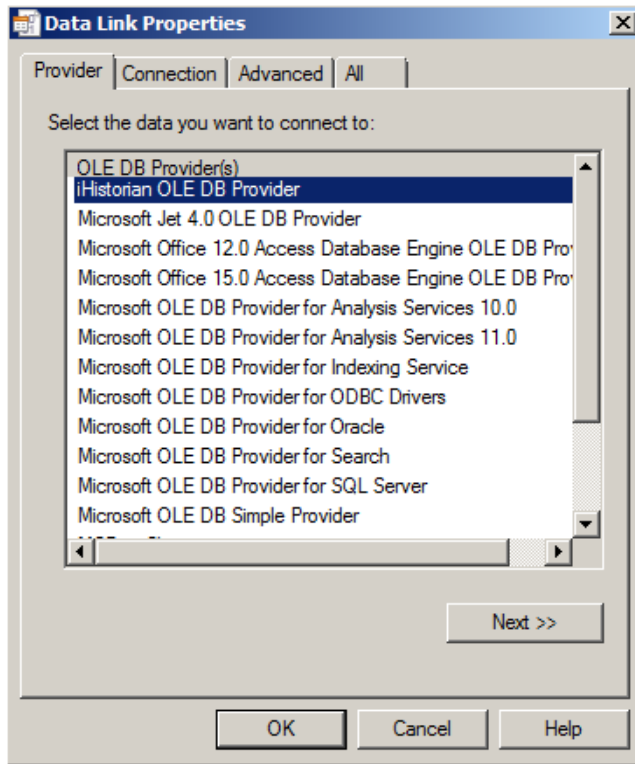

Click the “**Next >>**” button to specify the connection details. If Proficy Historian is on the same computer as Dream Report, then no additional configuration is needed for the OLE DB provider. If Proficy Historian is on a remote computer, please enter the computer name or IP address for the **Data Source:**, and then click “**Test Connection**” to verify the connection. Click “**OK**” to close the OLE DB configuration window. The connection string will then be added to the Proficy Historian Driver Settings:

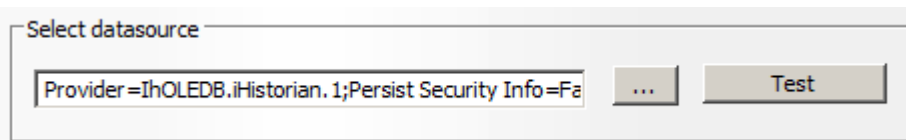

Finally, click the “**Test**” button to verify the connection.

2. Select either Proficy **Alarms** or **Events** for this driver's configuration



## Ocean Data Systems

- Click the “**Filter**” if you wish to “pre-filter” this instance of the driver with specific alarms or events. The following configuration window will open:

	Property	Condition	Value1	Value2
AND	Message	LIKE	.*	

- Under the **Filter Configuration** section, enter a new **Filter Name**, and then click the “**Save**” button
  - Select the **Filter Name** on the left panel, and then add a filter **Property** (e.g., by *Level*, *Tagname*, *Event Category*, etc.), setting any relevant condition(s) for that property
  - Select **OR** or **AND** depending on the logic to be evaluated for this specific file
  - Click the “**Save**” button (in the *Filter Configuration*) section to add the condition to this filter
  - Repeat steps 4.i through 4.iv to add additional condition(s) to this filter definition
- Click “**OK**” to save the Alarm (or Event) filters
- Click “**OK**” to close the Proficy Historian driver configuration
- Enter a unique **Driver Logical Name** for this configured instance of the driver
- Click “**Add**” to add it to the **Defined Drivers List**.



## GE Proficy Historian Historical Values driver

The GE Proficy Historian driver enables users to directly access GE Proficy Historian and extract data using native retrieval and sampling modes of Proficy Historian. The driver utilizes the GE *iHistorian OLEDB Provider*

**NOTE:** If you have already been using the **iHistorian Connectivity historical values** driver in your project with an older version of Dream Report you will need to reconfigure your "Defined Drivers List" in your project after the Dream Report version upgrade to **Proficy Historian historical values driver** (i.e. remove **iHistorian Connectivity historical messages** driver from the list and add a properly configured **Proficy Historian historical values** driver to it). Please make sure that the "Driver Logical Name" for the new driver is the same as the "Driver Logical Name" as the old one, in order to avoid internal project logical inconsistency.

The driver can be configured to expose historical numeric values, or historical message/string values, which are found under the "General Electric" section of the Dream Report **Communication Configuration Wizard**:

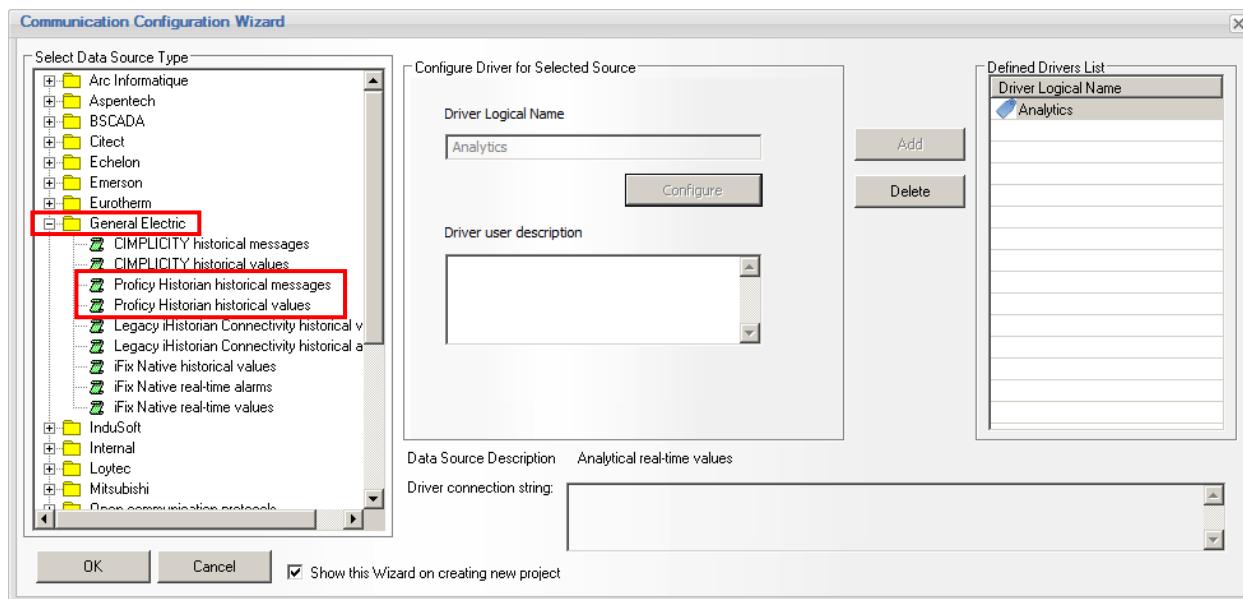

### Configuring GE Proficy Historical (Numeric) Values

Select the **Proficy Historian historical values** driver from the **General Electric** drivers folder of the **Select Data Source Type** section (as shown in the image above).

The "Configure" button will be enabled, which, when clicked, will open the GE Proficy **iHistorian driver settings** dialog window:



## Ocean Data Systems

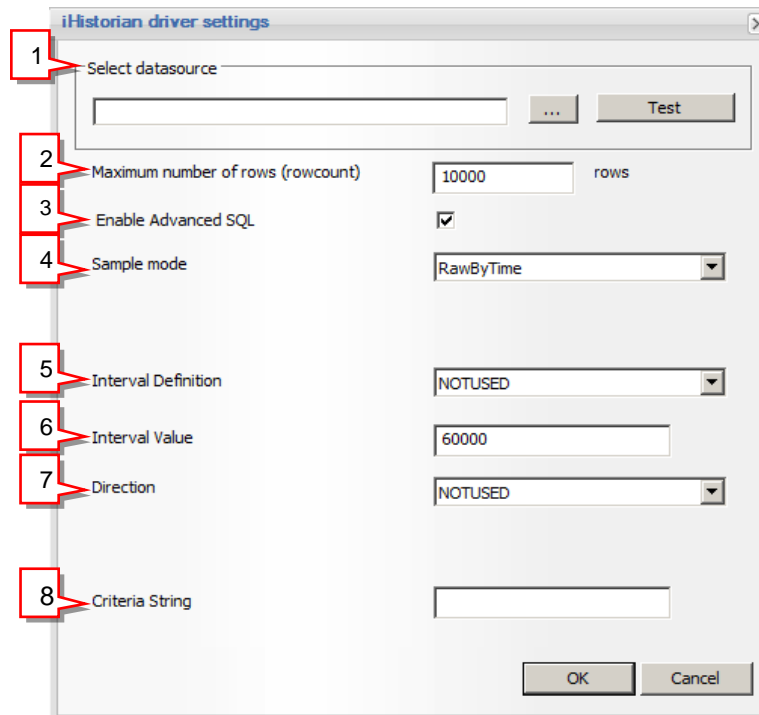

1. In the **Select Datasource** section, click the browse button [...] to select the **iHistorian OLE DB Provider**:

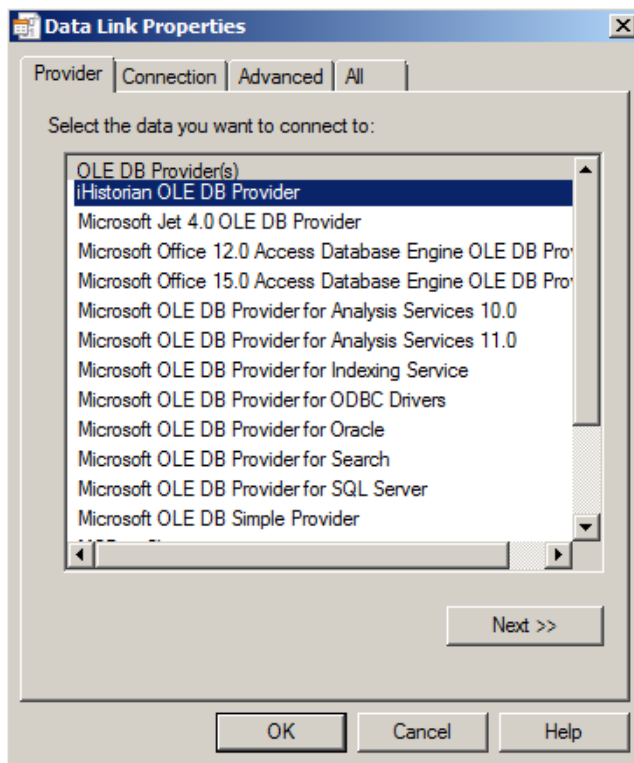



## Ocean Data Systems

Click the “**Next >>**” button to specify the connection details. If Proficy Historian is on the same computer as Dream Report, then no additional configuration is needed for the OLE DB provider. If Proficy Historian is on a remote computer, please enter the computer name or IP address for the **Data Source:**, and then click “**Test Connection**” to verify the connection. Click “**OK**” to close the OLE DB configuration window. The connection string will then be added to the Proficy Historian Driver Settings:

Finally, click the “**Test**” button to verify the connection.

2. Enter the **Maximum Number of Rows (rowcount)**. This parameter will limit the number of rows returned from the Historian to the first “x” number of values (as determined by the retrieval/sampling mode defined below). The default is 10,000 rows, and can be modified here.
3. The **Enable Advanced SQL** option allows the user to provide additional SQL-type filtering capabilities to the Proficy Historian connection.
4. **Sample Mode** -when retrieving data from Historian, you specify either a “raw” or “non-raw” sampling mode. Non-raw retrieval can include a calculation mode, so that calculations are performed at the Historian side prior to data being returned to Dream Report. The available sample modes are as follows:
  - **CurrentValue**
  - **Interpolated**
  - **RawByTime**
  - **RawByNumber**
  - **Calculated**
  - **Lab**
  - **Trend**
- i. **Current Value** sampling mode retrieves the data sample value with newest timestamp of any quality that was received by the Historian. This is not the same as retrieving the newest raw sample stored in the archive, since archive compression sometimes discards raw samples sent by the collector during the compression process. **Current Value Sampling** retrieves a single sample containing the current value of the tag, not a series of historical samples.
- ii. Using **Interpolated** mode, on retrieval, interpolation is performed to produce an evenly spaced list of the most likely real-world values. Even if you are not using compression at the Historian side, you can use interpolation if you want samples spaced on intervals other than the “true” collection rate. An **Interval Definition [5.]** can be specified either in **Milliseconds**, or in an equal (time-) spaced **NumberOfSamples**, with the value being specified in the **Interval Value [6.]** field.
- iii. **RawByTime** retrieval mode returns all raw samples of all qualities with a timestamp greater than the start time and less than or equal to the end time. It will not return a raw sample with same time stamp as the start time. The **NumberOfSamples** is ignored and all raw samples will be returned (up to the number of rows specified in the **Maximum Number of Rows (rowcount) [2.]** option.
- iv. **RawByNumber** retrieval returns “x” number of raw samples (**Interval Definition, [5.]** set to **NumberOfSamples**, with a value specified in **Interval Value, [6.]**) of all qualities, starting from a time stamp of the indicated start time, moving in the specified **Direction [7.]** - “Forward” or “Backward”. It will return a raw sample with the same timestamp as the start time. If there is no sample at the specified start time, the retrieval count begins at the next sample.
- v. **Calculated** modes can be separated into 3 main categories:
  - **Raw** calculation modes, where only raw points are used to determine calculated value. These include:
    - **Count**
    - **RawTotal**
    - **RawAverage**
    - **RawStandardDeviation**



## Ocean Data Systems

- **Interpolated** calculation modes use both raw and interpolated data points to determine a value. These include:
  - Minimum
  - MinimumTime
  - Maximum
  - MaximumTime
  - TimeGood
- **Time-Weighted** calculation modes use both time-weighting and interpolated points to determine a value. These include:
  - Average
  - Total
  - StandardDeviation
- **Other** calculation modes include:
  - StateCount
  - StateTime

For all of these **Calculated** modes, you have the option of providing an **Interval Definition** [5.] can be specified either in *Milliseconds*, or in an equal (time-) spaced *NumberOfSamples*, with the value being specified in the **Interval Value** [6.] field. Additionally, you can provide a **State Value** and/or **Criteria String**, where applicable, for any of these modes [8.]

5. Click “**OK**” to close the Proficy Historian driver configuration
6. Enter a unique **Driver Logical Name** for this configured instance of the driver
7. Click “**Add**” to add it to the **Defined Drivers List**.

### NOTE:

Please refer to the GE Proficy Historian “*Advanced Topics*” documentation for more details on the various Proficy Historian sampling and calculation modes



## iFix Native real-time values driver

**iFix Native real-time values** communication driver enables users to connect directly to iFix SCADA, browse tags, extract values and log them in real time into the Dream Report internal history.

**NOTE:** **iFix Native** drivers can provide connection only to a local data sources, i.e. on the same specific PC where iFix SCADA and Dream Report are running.

To configure **iFix Native real-time values driver**, first, open the **Communication Configuration Wizard** dialog window. In the **General Electric** folder, please, select the iFix Native real-time values driver from the **Select data source type** section.

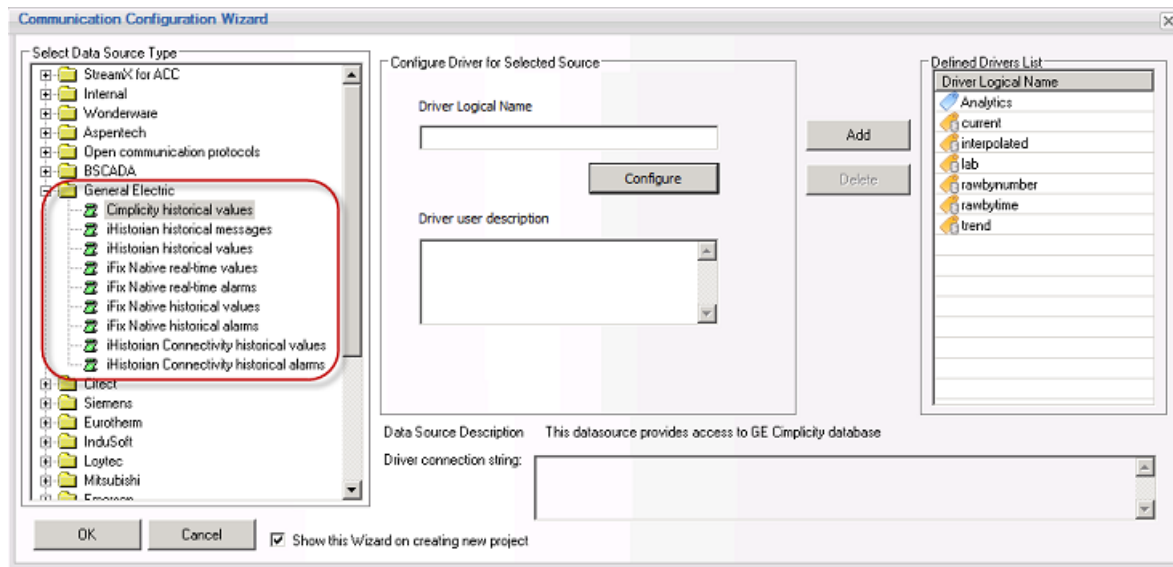

Then you need to assign **"Driver Logical Name"** for the selected data source. When the source is configured, it should be added to a general list of data sources, defined in a project, by clicking on **"Add"** button. The configured source will appear in the **Defined drivers list**. Button **Delete** will delete selected source from the list.

When all the communication settings for the project are done, click **"OK"**, and the data source configuration will be finished.



## iFix Native real-time alarms driver

**iFix Native real-time alarms** communication driver enables users to connect directly to iFix SCADA, browse, extract alarms and log them in real time into the Dream Report internal history.

**NOTE:** **iFix Native** drivers can provide connection only to a local data sources, i.e. on the same specific PC where iFix SCADA and Dream Report are running.

To configure **iFix Native real-time alarms driver**, first, open the **Communication Configuration Wizard** dialog window. In the **General Electric** folder, please, select the iFix Native real-time alarms driver from the **Select data source type** section.

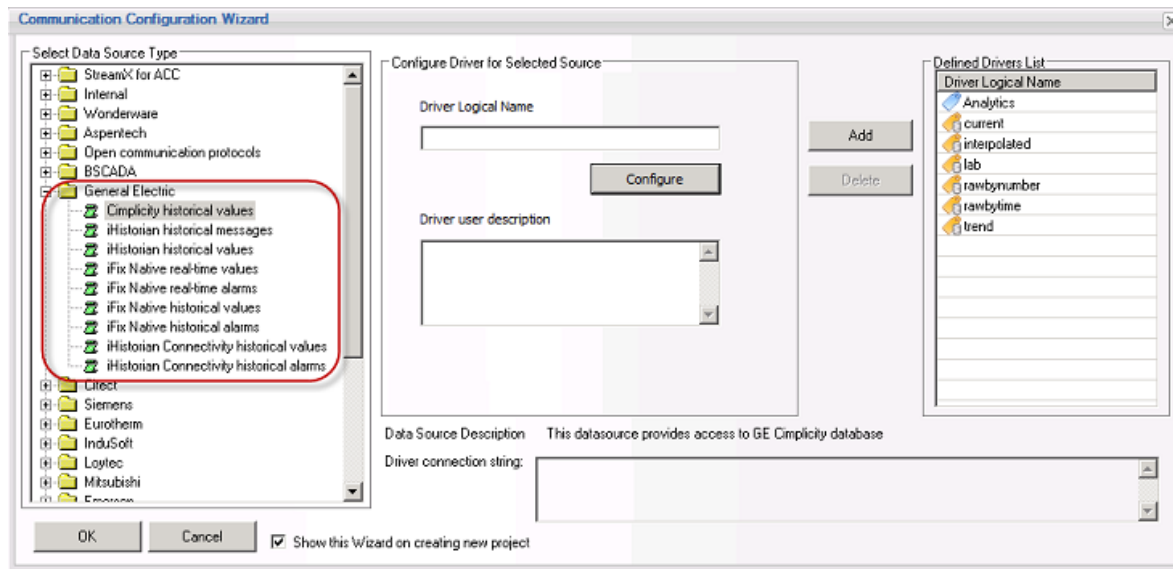

Then you need to assign **"Driver Logical Name"** for the selected data source. When the source is configured, it should be added to a general list of data sources, defined in a project, by clicking on **"Add"** button. The configured source will appear in the **Defined drivers list**. Button **Delete** will delete selected source from the list.

When all the communication settings for the project are done, click **"OK"**, and the data source configuration will be finished.





## iFix Native historical values driver

**iFix Native historical values** communication driver provides automated values browse and extraction from local iFix database.

**NOTE:** **iFix Native** drivers can provide connection only to a local data sources, i.e. on the same specific PC where iFix SCADA and Dream Report are running.

To configure **iFix Native historical values driver**, first, open the **Communication Configuration Wizard** dialog window. In the **General Electric** folder, please, select the iFix historical values driver from the **Select data source type** section, and click on "**Configure**" button:

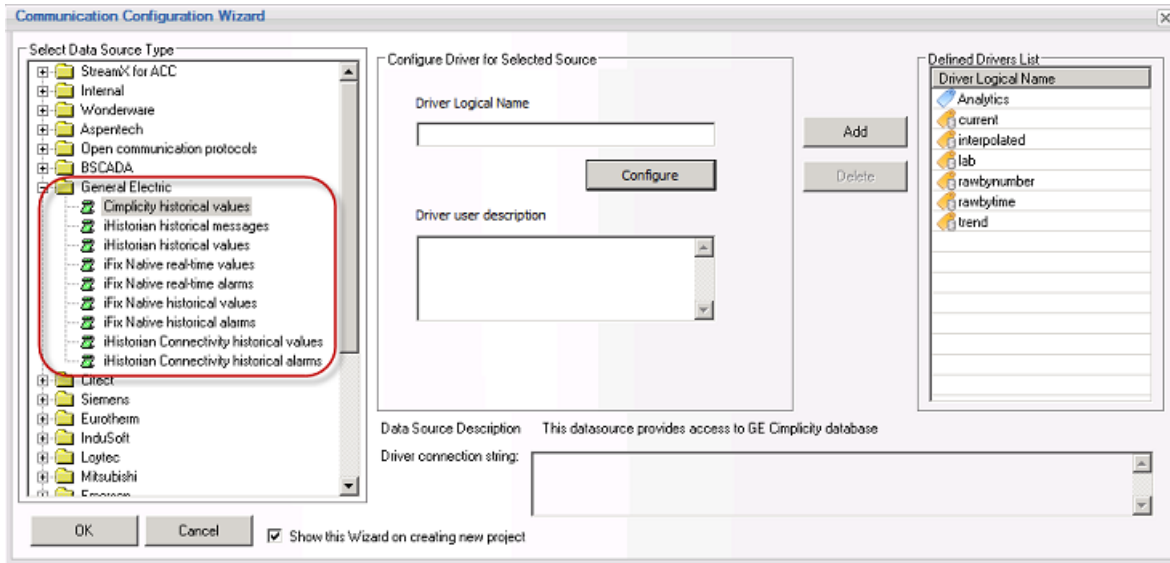

If **iFix Native historical values** communication driver is selected, then, as soon as you click on "**Configure**" button, the following **Configuration** dialog window will be opened:

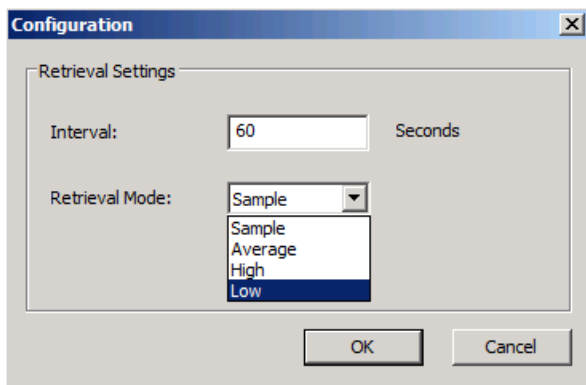

This window gives you an opportunity to define the mode of extracting values from database:

- in the "**Interval**" field you may determine the interval of data timestamp acquired from the source in seconds;
- in the "**Retrieval Mode**" popup field you may set how the data in the defined interval will be processed ("**Sample**" is the latest value in the interval, "**Average**" is a calculated average value of the interval data values, "**High**" is the highest value in the interval and "**Low**" is the lowest value in the interval).



## Ocean Data Systems

When you click on **"OK"** button in this window, your driver settings configuration is accomplished and you return to **"Communication Configuration Wizard"**. Then you need to assign **"Driver Logical Name"** for the selected data source. When the source is configured, it should be added to a general list of data sources, defined in a project, by clicking on **"Add"** button. The source configured will appear in the **Defined drivers list**. Button *Delete* will delete selected source from the list.

When all the communication settings for the project are done, click **"OK"**, and the data source configuration will be finished.



## iFix Native historical alarms driver

**iFix Native historical alarms** communication driver provides automated history alarms extraction from local iFix database.

**NOTE:** **iFix Native** drivers can provide connection only to a local data sources, i.e. on the same specific PC where iFix SCADA and Dream Report are running.

To configure **iFix Native historical alarms driver**, first, open the **Communication Configuration Wizard** dialog window. In the **General Electric** folder, please, select the iFix Native historical alarms driver from the **Select data source type** section.

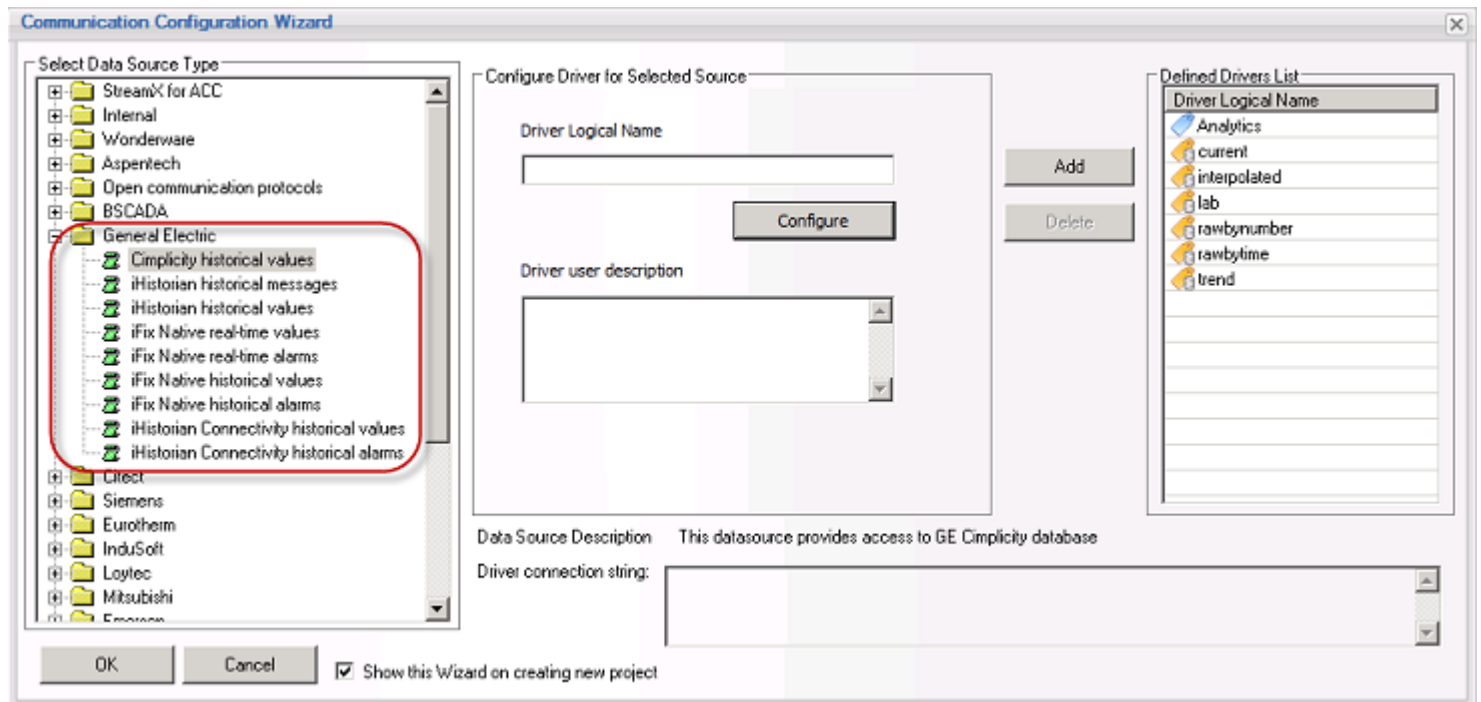

Then you need to assign **"Driver Logical Name"** for the selected data source. When the source is configured, it should be added to a general list of data sources, defined in a project, by clicking on **"Add"** button. The configured source will appear in the **Defined drivers list**. Button **Delete** will delete selected source from the list.

When all the communication settings for the project are done, click **"OK"**, and the data source configuration will be finished.



## ODBC Driver

Dream Report includes **ODBC driver**, which enables connectivity to any external databases which support ODBC connectivity and have supported data structure.

ODBC driver of Dream Report provides automatic tag browsing, tag and alarm data extraction.

To configure **ODBC driver**, first, open the **Communication Configuration Wizard** dialog window:

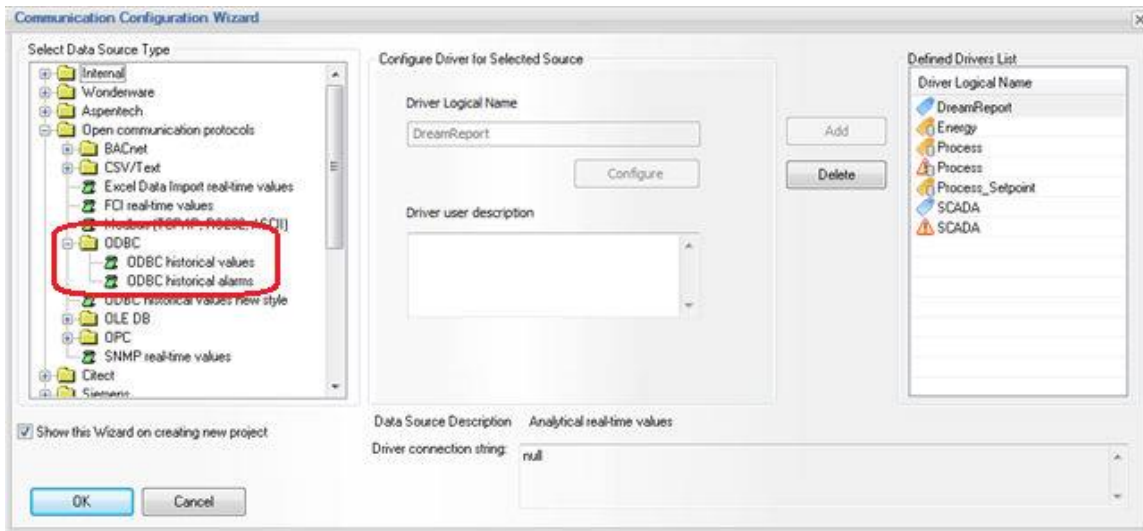

Select either **ODBC historical values** driver or **ODBC historical alarms** driver from the **ODBC** subfolder of the **Open communication protocols** folder in the **Select data source type** section. Click on **Configure** button and the following configuration window will be opened:

**NOTE:** In Dream Report version 3.43 the ODBC History Access driver had one instance both for historical data and historical alarms configuration.

Now, in this new version of Dream Report, the ODBC driver has two instances and should be configured separately as "**ODBC historical values**" (for historical data) or/and "**ODBC historical alarms**" (for historical alarms).

### Configuration Steps:

1. Open **DSN File** combo box and select a DSN, which is configured to your database.

If DSN requires login and password, enter user name and password in appropriate edit boxes below DSN combo box.

**NOTE:** All DSNs defined in the project are saved and can be managed from one place (for details, please see the **DSN Manager** section of this manual).





2. Click **Connect** button. The driver will connect to a database, read a list of its tables and fill table lists for tag values data extraction and alarms data extraction.

**NOTE:** When displaying a list of available tables in the selected database, the ODBC driver will display all tables (user and system tables) and all views, available in that database.

3. Select database type. The ODBC driver proposes the following types of database:

- Internal database
- Column-Item structure
- Any database (AnyDB structure)
- InSQL database
- PcVue HDS database
- Aspen InfoPlus.21

**Internal database** enables connectivity to the internal Dream Report database, created by Dream Report.

**Column-Item database** enables connectivity to the database tables with the structure, where data is recorded in a table, where there is a column for a timestamp (optional - 2 columns for timestamp and milliseconds), and value for each tag is recorded in a separate column, where the name of the column is considered as a tag name. Below you can see an example of a data table with the **Column-item** architecture:

ID	Time	Batch_T	Counter	Motor1	Motor2	Motor3	Temp1	Temp2
8658	23.12.2007 12:00:00	Batch_84	649	1	1	1	94	
8659	23.12.2007 13:00:00	Batch_84	650	0	0	0	95	
8660	23.12.2007 14:00:00	Batch_84	651	1	1	1	96	
8661	23.12.2007 15:00:00	Batch_84	652	0	0	0	97	
8662	23.12.2007 16:00:00	Batch_84	653	1	1	1	98	
8663	23.12.2007 17:00:00	Batch_84	654	0	0	0	99	
8664	23.12.2007 18:00:00	Batch_84	655	1	1	1	10	
8665	24.12.2007 7:00:00	Batch_84	656	0	0	0	20	
8666	24.12.2007 8:00:00	Batch_84	657	1	1	1	30	
8667	24.12.2007 9:00:00	Batch_84	658	0	0	0	40	
8668	24.12.2007 10:00:00	Batch_84	659	1	1	1	50	

**Any database** enables connectivity to the database tables with the structure, where data is recorded in 3 or 4 columns: **Tag name**, **Tag value**, **Timestamp** (optional - 2 columns for timestamp - time and milliseconds). Below you can see an example of a data table with the **Any database** architecture:

TagName	LogDate	Value
WxCarrBhillRwsChldl	07/09/08 12:52:00	0,38375
WxCarrBhillRwsReslev	07/09/08 12:52:00	3,1125
WxCarrCamWtpCramm	07/09/08 12:52:00	0,4125
WxCarrCamWtpCrdl8	07/09/08 12:52:00	-0,000625
WxCarrCamWtpCrph	07/09/08 12:52:00	6,864375
WxCarrCamWtpCrtur	07/09/08 12:52:00	1,25
WxCarrCamWtpDnamm	07/09/08 12:52:00	0,26875

**InSQL** option enables automatic connection to InSQL database. This option provides automatic tag browse and data extraction from InSQL database.

**PcVue HDS database** enables connectivity to the PcVue historical database server.

**Aspen InfoPlus.21** enables connectivity to the Aspen IP21 historical database server.

#### 4. Data mapping for tag values

From the right table list (**Item History Data**), select a table, which contains your tags values. As soon as you have selected a table, combo boxes below this list will be automatically filled with names of all the columns from the selected table.



## Ocean Data Systems

Select appropriate column names from the combo boxes with column names as follows:

- If you have selected **Internal database** - no column mapping is required. Dream Report will know by itself how to get tag names and data.
- If you have selected **Column-Item structure** type, please, select only a column with **Timestamp** from the combo box **Table field for date**.
- If you have selected **Any database** - please, select:
  - **column name**, containing tag names in the combo box **Table field for item names**
  - **column name**, containing tag values in the combo box **Table field for item values**
  - **column name**, containing timestamps in the combo box **Table field for date**
- If you have selected **InSQL database** - no column mapping is required. Dream Report will know by itself how to get tag names and data.
- If you have selected **PcVue HDS database** - no column mapping is required. Dream Report will know by itself how to get tag names and data.
- If you have selected **Aspen InfoPlus.21** - no column mapping is required. Dream Report will know by itself how to get tag names and data.

### 5. Timestamp management

In order to comply with different timestamp formats of different databases, ODBC driver has a powerful mechanism to configure timestamp format, which will be received from a database. ODBC driver can process timestamps in SQL Date/Time format or as a string.

If timestamp is stored in one column, then, if you use **Column-Item** or **Any database** type, select only a column with **Timestamp** from the **Table field for date** combo box.

If timestamp is stored in two columns, then, if you use **Column-Item** or **Any database** type, select only a column with date from the **Table field for time** combo box.

#### Timestamp properties

If timestamp is used in local time zone, timestamp will be accepted as it has been retrieved from the database. If timestamp is used in GMT format, check the **Database uses UTC time format** check box. Then all timestamps, received from a database, will be automatically converted into a local time zone.

If date format has a special (non-standard SQL) format, a user can select a format from the date format selection combo box (**Date format**). If timestamp with that date contains only date (no time), then, check the **"Date only"** check box, next to the **Date format** combo box.

### 6. Browsing from a text file

If you connect ODBC driver to a big database, where getting browse of tags takes a lot of time, in order to avoid losing time for each browse, ODBC driver offers a function to save list of all found tags into a text file during the first connection. Then it will not connect to a database each time when tag browse is requested. It will take it from that text file. In order to switch on this option, please, check the **Use text file to save item list** check box.

In order to reset a browse from the text and refresh it, delete a text file (it's created in the System directory), and then, during next database connection, the driver will establish database connection, create a new tag browse file and save list of tags in it again.

### 7. Data mapping for alarms

If you connect ODBC driver to an alarm database, please, select a table with alarm archive from the left table list (**Alarm History Data**). Then select appropriate column names from the combo boxes below as follows:





## Ocean Data Systems

- **Table Field for Alarm ID** - column, which contains alarm IDs (optional) (has to be numeric).
- **Table Field for Alarm Text** - column, which contains alarm text.
- **Table Field for Alarm Priority** - column, which contains alarm priority (has to be numeric).
- **Table Field for Start Time** - column, which contains alarm start time.
- **Table Field for Ack Time** - column, which contains alarm acknowledge time (optional).
- **Table Field for End Time** - column, which contains alarm end time (optional).

**NOTE:** timestamp format for alarm timestamps (**star/ack/end** time) will be used in the same way as configured in the **Date timestamp format** configuration section (please, refer to the **Timestamp management** paragraph (paragraph 5) above).

**NOTE:** Data mapping for **InTouch alarms** database:

To pick up alarms from the InTouch alarm SQL Server database, please:

1. Select DSN for InTouch alarm SQL Server database.
2. Click **Connect** button
3. Select **AlarmEventHistory** as alarm table in the left list of the tables map fields to retrieve alarm data as follows:
  - As InTouch alarms don't have ID, select **Priority** field for alarm ID
  - For alarm text select **Description** field
  - For alarm priority select **Priority** field
  - For alarm start, ack and end time select **EventStamp** field
4. In your alarm table in Dream Report, please, uncheck (disable) **Ack time**, **End time**, **Duration** and **Response time** columns for proper display.

### **DSN/ODBC when using 64bit OS**

If Dream Report is installed on 64 bits Operating System (i.e. Windows 7 or Windows 2008 Server), DSN/ODBC may not work with 64bit ODBC. In this case, please use **ODBCad32**, which is located in **C:\Windows\SysWOW64** directory, to create a 32bit DSN to work with Dream Report.

For details please see **[Using Dream Report in 64-Bit OS](#)** section.

### **DSN settings (SQL Server connection) in Version 4+**

If, before upgrading to version 4.6, the Dream Report project DSN was defined in order to connect to SQL databases (SQL Server 2008, SQL Server 2005, SQL Server 2000, 7.0), then, in version 4+, the driver in the DSN definition should be changed for the SQL Native Client 10.0 driver.

For details, please see the **[Project Upgrade Procedure](#)** section of this manual.

### **Application tips:**

- ODBC driver has been qualified and used with MS SQL Server, MySQL, MS Access, Oracle, InSQL.
- In order to retrieve data from Oracle database, the following timestamp format has to be configured: YYYY-MM-DD HH:MM:SS.
- ODBC driver can extract and process numeric and string values.
- Null values are always ignored.

**NOTE:** If you need to configure the same driver more than once, then, after having configured it the first time, you'll just need to click in the **"Select Data Source Type"** field on any other driver and then go back to the driver that you need to configure.



## Excel Data Import Driver

Dream Report includes **Excel Data Import (EDI) driver**, which enables to periodically access specific Excel file(s) or check for specific folder(s) (optionally including subfolders) and import all new data.

EDI driver will permanently run with Dream Report and look after specific Excel file or all files in a specific folder (optionally including subfolders). As soon as the file modify time has changed or new files have appeared in the folder, EDI driver will access that file or the newly created files, read data according to its configuration and log that data into the standard Dream Report database.

In order to import data from Excel you need to define logging group from EDI source with record rate "**On Update**".

### EDI Driver Compatibility

EDI driver is compliant with the following MS Excel versions:

- MS Excel 2000
- MS Excel 2003
- MS Excel 2007
- MS Excel 2010
- MS Excel 2013

MS Excel is not required to be installed on the PC, where EDI driver will work. EDI driver includes a special integrated library to access MS Excel files without MS Excel software itself.

### EDI Driver Configuration

To configure **EDI driver**, first, open the **Open communication protocols** section of the **Communication Configuration Wizard** dialog window:

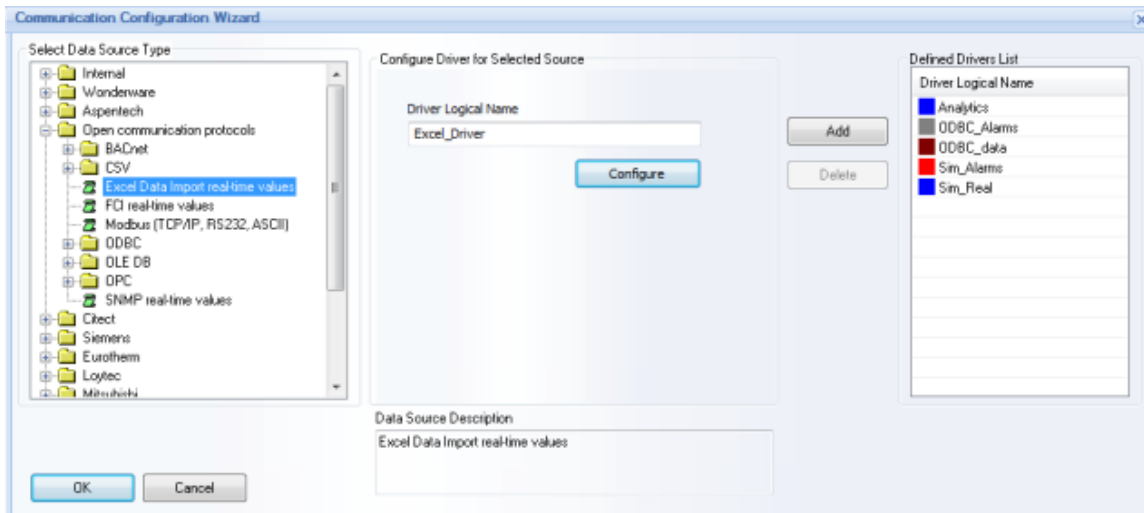

Click on **Configure** button and the following dialog window will be opened:





The dialog box is titled "Excel Data Import Configuration". It is divided into several sections:

- Read data from Excel file(s) from:** A text box containing "C:\Data\DEF.xls" with a browse button (...). Below it are checkboxes for "Including subfolders" (checked), "Use Default Spreadsheet" (selected), and "Select Spreadsheet" (disabled).
- Check for new data every:** A numeric input box with "1" and a dropdown menu set to "min(s)".
- Values in excel file data blocks are recorded:** Radio buttons for "Vertically (top - down)" and "Horizontally (Left to Right)" (selected). A checkbox "Do not import data blocks" is checked.
- Excel layout configuration:** Dropdowns for "Timestamp format in data block" (Time), "Time format" (hh:mm:ss), and "Date format" (dd/MM/yyyy). Below are pairs of dropdowns for "Timestamps start from the cell", "Date is located in the cell", and "Tag names start from the cell".
- Single tags definition:** Radio buttons for "Read from the cell" (selected) and "Manual name". Below are dropdowns for "Tag name", "Tag value read from the cell", and "Tag value type".
- Single tag Timestamp definition:** Dropdowns for "Date is located in the cell" and "Timestamps start from the cell".
- Buttons:** "Add" and "Delete" buttons are located below the timestamp definition section.
- Table:** A table with columns: Tag name, Value in:, Type, Date in:, Time in:.

Tag name	Value in:	Type	Date in:	Time in:
Operator	A2	Text	D6	D7
- Buttons:** "Save" and "Cancel" buttons are at the bottom left.

In the Read data from Excel file(s) from: section, please select a specific file with the extension “.xls” or “.xlsx”. Then the EDI driver will periodically check the timestamp of the modification of that selected file with the period defined below. As soon as the file modification timestamp has been changed, the driver will read file data and all new values will be archived into the database.

If you have entered the folder name (but not the file name), the driver will periodically scan for the entire folder and keep the list of the last processed files and their modification timestamp. As soon as a new file has been found or the modification timestamp of any existing file has been changed to a newer one, the driver will process all these files and all new data will be archived into the standard Dream Report database.

Check box "Including subfolders" will be enabled only if the edit box with the file/folder name contains a folder name. If you have entered only a file name, this check box will be disabled.

If this check box is enabled, then EDI driver will check not only all files in the selected folder, but also in all subfolders located under that selected folder.

You can specify the spreadsheet from where all the data will be transferred into Dream Report. There are 2 options available: Use Default Spreadsheet and Select Spreadsheet.

- Use Default Spreadsheet radio button is enabled by default when the Excel Data Import Configuration dialog window will be opened the first time. When the configuration of all the rest of the EDI driver’s parameters continues, it will always refer to this default Excel spreadsheet.
- If Select Spreadsheet radio button is enabled, then you will be able to select a specific spreadsheet.

In the Check for new data every section, specify the period for a new data check. You can enter any integer number from 1 to 86400, and time (second(s), min(s), hour(s), day(s), month(s)) in the time unit combo box. The timer will start when the project is started, and then each defined number of time units, EDI driver will check for the new data.



## Ocean Data Systems

In the **Values in Excel file data blocks are recorded:** section you can configure how to import data in blocks. First, select the type of data layout – Vertically (top-down) or Horizontally (left to right). The data layout type defines the direction of values, which are listed after their corresponding tag name cell. In the horizontal orientation values are listed to the right from their tag name. In vertical orientation values are listed down from their tag name.

If there is no need to import data from data blocks, please check the Do not import data blocks check box. Then both radio-buttons will be disabled.

In the **Excel layout configuration** section, first select timestamp format in a data block in the Timestamp format in data block: combo box. This combo box has 3 entries: “Time”, “Date” and “Date and Time”. Each of them sets the timestamp format, which will be used next to each value in data blocks. The default timestamp format value is Time.

**Time format** combo box enables to select time format and has 9 entries: “hh”, “hh am/pm”, “mm”, “hh:mm”, “hh:mm am/pm”, “hh:mm:ss”, “hh:mm:ss am/pm”, “hh:mm:ss.msec”, “hh:mm:ss.msec am/pm”. The default time format value is hh:mm:ss.

Date format combo box enables to select date format for the values timestamp. This combo box has exactly the same entries and functions as the date format combo box (Set Date Format) in the Project Settings Localization section in the Dream Report studio.

In the combo boxes Timestamps start from the cell, please select a cell where timestamps values start. If an Excel file has the vertical layout type, please select the first cell from the top, containing Timestamp. If an Excel file has horizontal orientation, please select first cell from the left, containing Timestamp.

If the **timestamp format** in the **Timestamp format in data block** combo box is “Date and time”, then please ignore section “Date is located in cell”.

	A	B	C	D	E	F
4						
5		Timestamp	Tank1	Tank2	Tank3	
6		31/03/2013 12:00:00	1170	1350	1500	
7		31/03/2013 13:00:00	1455	1425	1350	
8		31/03/2013 14:00:00	1320	1395	1125	
9		31/03/2013 15:00:00	1185	1470	750	
10		31/03/2013 16:00:00	1380	1500	375	
11		31/03/2013 17:00:00	1425	1350	1200	
12		31/03/2013 18:00:00	1485	1305	1500	
13		01/04/2013 07:00:00	1335	1335	1350	
14		01/04/2013 08:00:00	1305	1350	1425	
15		01/04/2013 09:00:00	1425	1365	1170	







The dialog box is titled "Excel Data Import Configuration" and contains several sections:

- Read data from Excel file(s) from :** A text box containing "C:\Date.xls" and a browse button "...".
- Including subfolders
- Use Default Spreadsheet
- Select Spreadsheet: [dropdown]
- Check for new data every : [10] [second(s)] [dropdown]
- Values in excel file data blocks are recorded :**
  - Vertically ( top - down )
  - Horizontally (Left to Right)  Do not import data blocks
- Excel layout configuration :**
  - Timestamp format in data block : [Date] [dropdown]
  - Time format : [hh:mm:ss] [dropdown]
  - Date format : [dd/MM/yyyy] [dropdown]
  - Timestamps start from the cell : [B] [dropdown] [6] [dropdown]
  - Date is located in the cell : [ ] [dropdown] [ ] [dropdown]
  - Tag names start from the cell : [C] [dropdown] [5] [dropdown]
- Single tags definition :**
  - Tag name :  Read from the cell : [ ] [dropdown] [ ] [dropdown]
  - Manual name : [ ] [text box]
  - Tag value read from the cell : [ ] [dropdown] [ ] [dropdown]
  - Tag value type : [Number] [dropdown]
  - Single tag Timestamp definition**
    - Date is located in the cell : [ ] [dropdown] [ ] [dropdown]
    - Timestamp is located in the cell : [ ] [dropdown] [ ] [dropdown]
  - [Add] [Delete] buttons
- Table:** A table with columns: Tag name, Value..., Type, Date in:, Time in:.
- [Save] [Cancel] buttons

In the **Tag names start from the cell** combo box select the start place to read tag names and their values - i.e. specify a cell, which is the start for tag names.

- If the table is vertical, select the first left cell of the row, which has tag names. Then EDI driver will know that all other tag names are located to the right of that cell.
- If the table is horizontal, select the first top cell of the column, which has tag names. Then EDI driver will know that all other tag names are located below that cell.

The EDI engine will assume that all values are started just next to the corresponding tag name. If any tag name cell is empty, its data block will be ignored

### Single Tags Definition

Data can be also taken from particular cells. For this purpose, please select cells one by one and define a name for a value from that cell (Tag name) and a type for that value (Tag value type).

Tag name can be also taken as a value of another cell. Enable the radio-button Read from the cell and select the address of the cell, which will contain the name of the desired tag. Or enable the radio-button Manual name and enter the name of the tag manually into the edit box next to it.

Having defined a single tag name (Tag name), select the address of the cell, which will contain value (Tag value read from the cell), and then select its type from the corresponding combo box (Tag value type). The Tag value type combo box has 3 entries: Number, Boolean and Text.

As soon as a new single tag has been defined, add it to the tags list by clicking the Add button. You can always remove the single tags definition by clicking the Delete button.

When single tags' definitions will be added to the Database, timestamps for the value(s) of those tags will be taken from the **Single Tag Timestamp Definition** section:







## OPC Drivers

Dream Report has the **OPC drivers** set, which includes:

- **OPC DA** (Data Access),
- **OPC AE** (Alarm and Event) and
- **OPC HDA** (History Data Access) drivers.

**OPC DA** driver supports OPC 1.0 and OPC 2.0 standards.

**OPC HDA** driver supports OPC 1.20 standard.

OPC driver can be configured to any local or remote OPC server, having flat or hierarchical architecture.

### OPC Client Configuration

To configure **OPC driver**, first, open the **Communication Configuration Wizard** dialog window:

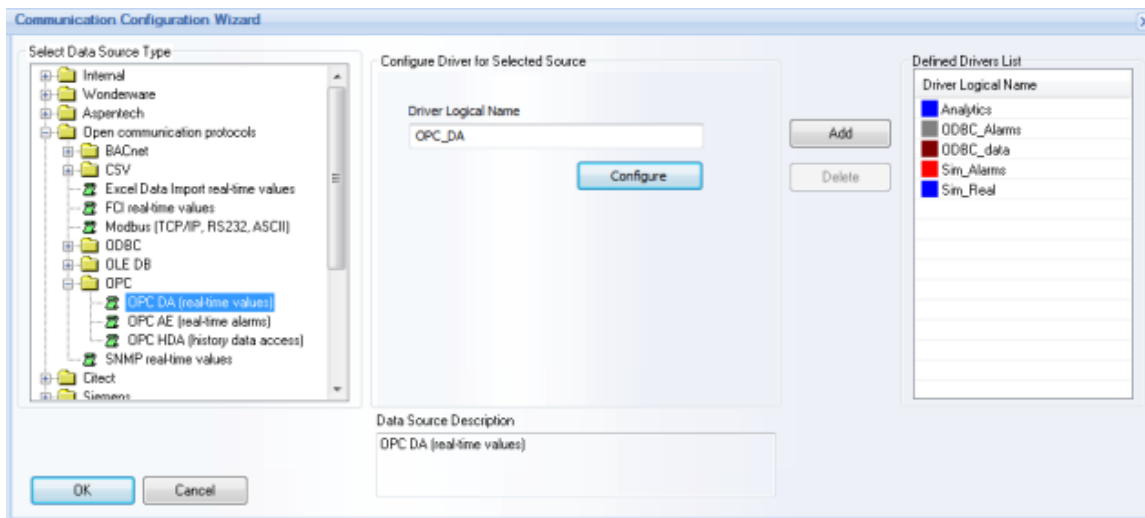

Select one of 3 **OPC** drivers (**OPC DA (real-time values)**, **OPC AE (real-time alarms)**, **OPC HDA (history data access)**) from the **OPC** subfolder of the **Open communication protocols** folder in the **Select data source type** section. Click on **Configure** button, and the OPC driver configuration dialog box will be opened.

**NOTE:** In Dream Report version 3.43 the OPC driver had one driver instance for real-time data, historical data and alarms configuration.

In later versions of Dream Report, the OPC driver has three driver instances and should be configured separately as **OPC DA (real-time values)**, **OPC AE (real-time alarms)** or **OPC HDA (history data access)**.



**OPC DA (real-time values)** configuration:

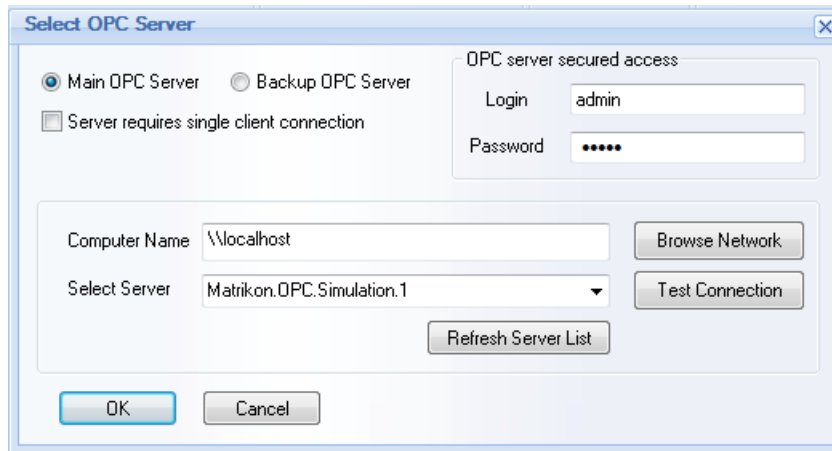

This dialog window has 2 options (radio buttons: **Main OPC Server** and **Backup OPC Server**), that allow OPC driver to work in a hot-backup mode and automatically switch from one OPC server to another in case of communication error, being able to connect to the secured OPC servers.

If the "**Main OPC Server**" radio button is enabled, you can select the computer name and the OPC server.

If the "**Backup OPC Server**" radio button is enabled, the **Computer Name** edit box and the **Select Server** combo box will be empty. You will be able to make another selection for the backup OPC server.

If the OPC server has secured (password protected) connection, it will be possible to specify, in the **OPC server secured access** section, login and password for the connection for the selected OPC server. Login and password will be set and saved separately for the main and backup servers.

**NOTE:** If OPC server definition contains login and password, the OPC browser and client will use it every time, when connecting to the OPC server.

If no login and password is defined, then the OPC browser and the client will be connecting to the server as usual, in anonymous mode.

In the **Select Server** section, select an OPC server, to which you would like to connect.

In the **Computer Name** field, specify the name of the PC, where OPC server is running. By default it is "**\\localhost**", which means a local PC. If another PC in a network has to be specified, click on **Browse Network** button, and then select the needed computer name from a network.

You can refresh server list from the specified PC by clicking on the button "**Refresh Server List**". It will get a list of OPC servers, installed on the specified PC, and update the list of servers in the combo box.

When the OPC server is selected, click the button "**Test Connection**" to test communication between Dream Report OPC client and your OPC server.

**OPC HDA (history data access)** driver configuration:

**Note:** In Dream Report 4.x versions prior to 4.6 R4 (4.64), the OPC DA and OPC HDA drivers are configured identically. In DR 4.64, the OPC HDA driver has been updated to include integrated data aggregation and data retrieval modes. So, users can select whether to retrieve all raw values or use data aggregation retrieval modes.





## Ocean Data Systems

Select **HDA (history data access)** driver (under *Open Communication Protocols > OPC*) and click on "Configure" button. The following OPC driver configuration dialog box will be opened to configure the Dream Report **OPC HDA** client:

This dialog window has 2 options (radio buttons: **Main OPC Server** and **Backup OPC Server**), that allow OPC driver to work in a hot-backup mode and automatically switch from one OPC server to another in case of communication error, being able to connect to the secured OPC servers.

If the "**Main OPC Server**" radio button is enabled, you can select the computer name and the OPC server.

If the "**Backup OPC Server**" radio button is enabled, the **Computer Name** edit box and the **Select Server** combo box will be empty. You will be able to make another selection for the backup OPC server.

If the OPC server has secured (password protected) connection, it will be possible to specify, in the **OPC server secured access** section, login and password for the connection for the selected OPC server. Login and password will be set and saved separately for the main and backup servers.

**NOTE:** If OPC server definition contains login and password, the OPC browser and client will use it every time, when connecting to the OPC server.

If no login and password is defined, then the OPC browser and the client will be connecting to the server as usual, in anonymous mode.

In the **Select Server** section, select an OPC server, to which you would like to connect.

In the **Computer Name** field, specify the name of the PC, where OPC server is running. By default it is "**\\localhost**", which means a local PC. If another PC in a network has to be specified, click on **Browse Network** button, and then select the needed computer name from a network.

You can refresh server list from the specified PC by clicking on the button "**Refresh Server List**". It will get a list of OPC servers, installed on the specified PC, and update the list of servers in the combo box.

When the OPC server is selected, click the button "**Test Connection**" to test communication between Dream Report OPC client and your OPC server.

If needed, specify a **Data Retrieval Mode** for this instance of the **OPC HDA** driver from the list, and if time-based (e.g., extract 10 minute averages) specify the option to **Retrieve data each "x" Seconds**.



### OPC AE (real-time alarms) driver configuration:

If you select **OPC AE (real-time alarms)** driver and click on "*Configure*" button, the following OPC driver configuration dialog box will be opened to configure **OPC AE** client:

The **OPC AE (real-time alarms)** driver is configured in the same way as **OPC DA (real-time values)** and **OPC HDA (history data access)** drivers.

**NOTE:** The **Event mode** option in the **OPC AE (real-time alarms)** driver configuration window allows users to record incoming messages not as alarms but only as events.

#### NOTES:

- If you need to configure the same driver more than once, then, after having configured it the first time, you'll just need to click in the "**Select Data Source Type**" field on any other driver and then go back to the driver that you need to configure.
- If Runtime Manager runs as service, then the OPC connection will work over DCOM and the OPC Server may not be fast enough to supply to the OPC client (Dream Report) the requested amount of data.

If such weak OPC driver performance may occur, in order to improve it a user will have to set Runtime Manager as an application (for details on Runtime mode settings, please see [Runtime Configuration](#) section of this manual).

### Main/Backup server management

A) When loading an OPC driver, it will initiate connection to the main OPC server. If suddenly communication with the main server has been broken and the driver detects communication error, it will start a new thread, which will cyclically try to re-establish connection with the main OPC server and also open the second connection to the backup server. If connection to the backup server has succeeded, it will use the backup server as the data server until communication with the main server in re-connection thread. As soon as re-connection with the main server is established, the connection to the backup server will be immediately closed and connection to the main server will be used for communication.



## Ocean Data Systems

B) If there's communication error with the main server and connection with the backup server can't be established, then the driver will try to re-establish connection with both servers. As soon as any of the connections has succeeded, it will be taken and used for communication. In that case, if connection to the main server succeeded first, the driver will continue to work in a normal way. If communication to the backup server succeeded first, then it will be taken for communication and the parallel thread to re-connect to the main server will be running in parallel.

**NOTE:** During installation of Dream Report, additional OPC component will be installed - OPC Core Component Redistributable 2.20 from OPC Foundation. It's supposed to repair or possible problems in OPC servers registrations and repair windows OPC component installation.



## Modbus Communication Driver

**Modbus** driver enables connecting to one or several devices, which are able to communicate using Modbus protocol, receive real-time values and write values back to a Modbus compliant device.

**Modbus** driver can be selected from the **Open communication protocols** folder in the **Select Data Source Type** section in the **Communication Configuration Wizard** dialog window:

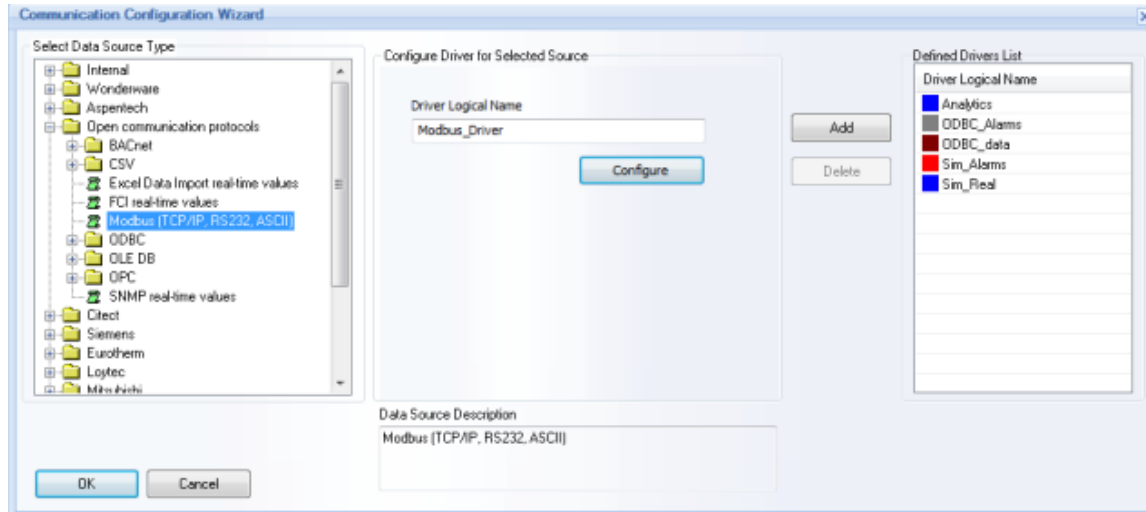

If you select **Modbus** driver, and click on "**Configure**" button, the **Modbus driver configuration** window will be opened:

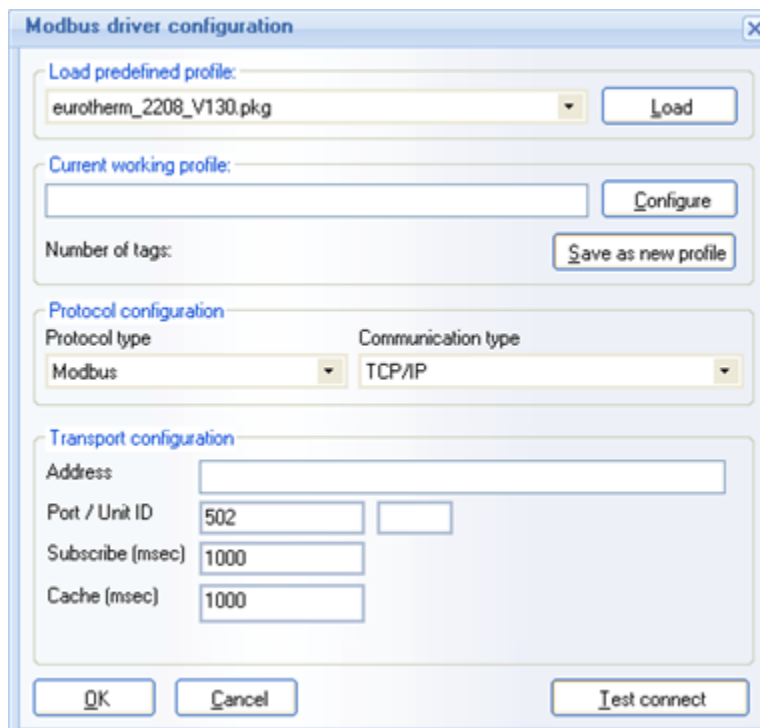

This window provides users with the possibility to configure communication parameters to a Modbus device and also data points in that device for communication.



## Modbus Profiles

There are pre-configured profiles in the product installation, supplied with the product. When installing the product, there is a folder "Modbus" in the System folder in the product installation (e.g. *C:\Program Files\ODS\Dream Report\System\Modbus*). All profile files are located there, where the name of a profile file is the displayed name of a profile in the profile list.

Profile is a ready set of data points: their name, Modbus address, data type etc.

### Load existing profile

The combo box "Load predefined profile" contains the full exhaustive list of all available predefined Modbus profiles. If there is any profile, which you want to load, please, select this profile in the combo box and then click on the "Load" button. The driver configuration engine will load the selected profile and the section "Current working profile" will display the loaded Modbus profile data, such as: Profile description will be written in the edit box, and the "Number of tags" string will display the number of tags, defined in the selected profile. Now all list of predefined tags will be loaded.

### Create and save new profile

If you are not using any predefined profile and you have already configured once your list of Modbus data points, and you will use the same profile in the future, you can type a description for the new profile, click on the button "Save as a new profile" and then you can type the profile name in the "Save file" dialog window. The profile file has to be saved in the Modbus folder in the "System" directory (then it will become available in the profile selection list with its list of data points and their addresses).

If you are using an existing predefined Modbus profile and you have edited/modified it and wish to save it under a new profile name, you also need to enter a profile description, click on a button "Save as a new profile", and then the new predefined Modbus profile will be created.

## Configuring Modbus (Protocol Configuration)

If you have selected a predefined Modbus profile or defined tags manually, please, configure the communication to your Modbus device.

**Protocol type** combo box contains available protocols: **Modbus** and **JBus**. Please, select which communication protocol will be used.

**Communication type** combo box enables users to specify the way how to connect to a Modbus device. There are two options available: **TCP/IP** and **Serial**.

Default selection is **TCP/IP**. If this option is selected, enter your Modbus device IP address or host name into the **Address** edit box.

The **TCP/IP** port number and the Modbus unit ID (address), which can be 1 to 255, have to be specified in the **Port/Unit ID** edit box.

The **Subscribe** parameter determines how often the driver will sample Modbus device for new values. If any data points are defined to be sampled in unsolicited mode (which is not supported by Modbus protocol), then, this driver will periodically scan Modbus device with the period, defined in the "Subscribe" edit box and in this way it will emulate unsolicited way of communication to a Modbus device (please, see the picture above).



If a user selects the "Serial" communication type, then the driver configuration window will have the following display:

Modbus driver configuration

Load predefined profile: eurotherm\_0316\_V0.pkg Load

Current working profile: eurotherm\_0316\_V0 Configure

Number of defined data points: Save as new profile

Protocol configuration

Protocol type: Modbus Communication type: Serial

Transport configuration

Port / Unit ID	1	1	Mode	Serial RTU
Interval (msec)	100		Baud rate	9600
Timeout (msec)	1000		Byte size	8
Subscribe (msec)	1000		Stop bits	1
Cache (msec)	1000		Parity	None

OK Cancel Test connect

In this case, please, enter parameters for serial communication. **Port** value has the COM number (e.g. "1" will mean COM1), **Unit ID** is the Modbus unit ID (address), which can be 1-255.

**NOTE:** Connection to devices on serial ports does not support multi-drop (multiple instruments on the same port). Serial Modbus communication supports one device per serial port.

**Subscribe** parameter will have the same meaning and will work the same way as it was described in the **TCP/IP communication** type section.

### Testing Connection

If the "TCP/IP" communication type is selected, then, the "Test Connect" button will try to establish communication to the selected Modbus device and then will display the appropriate message box according to the result: either *Test connection succeeded* or *Test connection failed*.

If the "Serial" communication type is selected, then, the "Test Connect" button will check connection to the COM port.



## Configure data points

To configure Modbus data points, click on "*Configure*" button, and the **Modbus Profile Configuration** window will be opened:

Name	Type	Tdata	Table	Address	Unit	Op
Access_Edit_Mode.AL1*ALA1	Bit field 16 bit	1	Input registers	63802		Enu
Access_Edit_Mode.AL1*ALA2	Bit field 16 bit	1	Input registers	63846		Enu
Access_Edit_Mode.AL2*ALA1	Bit field 16 bit	2	Input registers	63802		Enu
Access_Edit_Mode.AL2*ALA2	Bit field 16 bit	2	Input registers	63846		Enu
Access_Edit_Mode.AL3*ALA1	Bit field 16 bit	3	Input registers	63802		Enu
Access_Edit_Mode.AL3*ALA2	Bit field 16 bit	3	Input registers	63846		Enu
Access_Edit_Mode.AL4*ALA1	Bit field 16 bit	4	Input registers	63802		Enu
Access_Edit_Mode.AL4*ALA2	Bit field 16 bit	4	Input registers	63846		Enu
Access_Edit_Mode.AL.AL	Bit field 16 bit	0	Input registers	63802		Enu
Access_Edit_Mode.AL1*ALA1	Bit field 16 bit	1	Input registers	63802		Enu

In this window a user has to define his data points one by one, specifying a data point logical name (in the "**Name**" edit box), its logical Modbus address (in the "**Address**" edit box) using standard Modbus conventional addressing, the ID of the Modbus device unit in the Modbus network (in the "**Unit**" edit box), and then click on "*Add*" button. The new data point will be added to the list.

If a list of data points is too long, a user can filter the items list by name, using a name mask with wild characters.

**NOTE:** If you need to configure the same driver more than once, then, after having configured it the first time, you'll just need to click in the "**Select Data Source Type**" field on any other driver and then go back to the driver that you need to configure.



## Analytical Driver

**Analytical driver** of Dream Report is an internal module, which is responsible for recording statistical data, calculated by Dream Report to the database.

Each textual statistical object, defined in the report, such as **Single data object**, **Compound data object** and **Expression object** can be considered by Dream Report as internal variables, and their values can be recorded to the Dream Report database as values of any other data source.

To use this module:

1. Open the **Communication Configuration Wizard** dialog window:

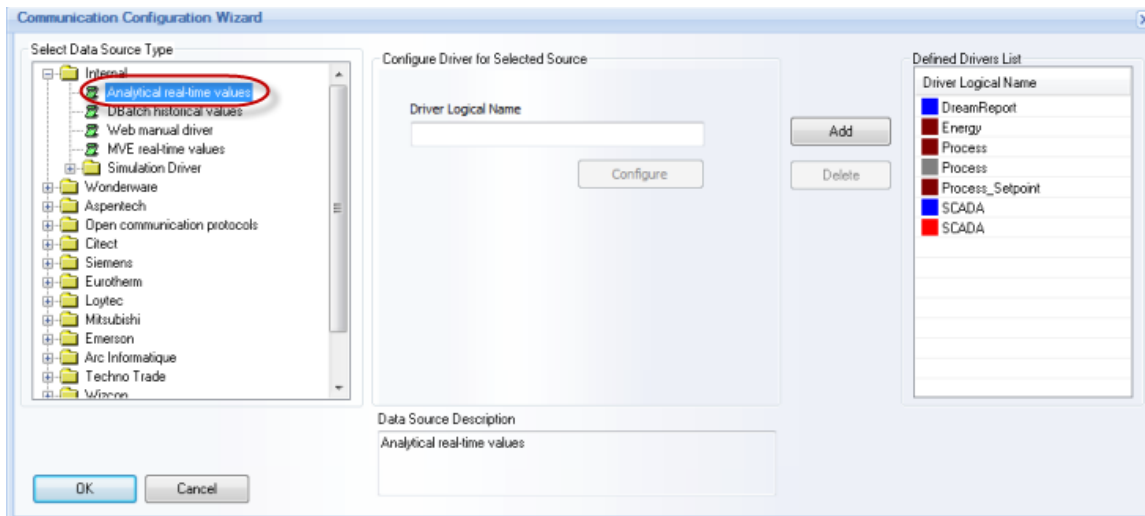

When the driver configuration window is opened in the **Driver Logical Name** section, the Dream Report analytical driver (**Analytics**) will be automatically configured, and you will not need to do its configuration again.

2. Create new data logging group

- When you want to add items to your group, you will see that the list of available items is the actual list of data objects, defined in your project. You can select list of any items and add to that new analytical group.
- If group record mode is "**On Update**" or "**On Change**", Dream Report will calculate values of the statistical objects and record them into the database during each report generation. If group record mode is "**Every**", then Dream Report will re-calculate values of the statistical objects each defined period and record those values into the database, independently of report generation.

At this stage, your analytical module is already defined and is ready to use.

**NOTE:** If you need to configure the same driver more than once, then, after having configured it the first time, you'll just need to click in the "**Select Data Source Type**" field on any other driver and then go back to the driver that you need to configure. Project may contain as many item logging groups with the analytical driver, as it may be needed.

### NOTES:

- We don't recommend to change the report name after analytical groups are created as **Analytical driver** uses report name and item name in its items names.
- When using **Analytical driver**, analytical items and analytical data can be used in any item-related Dream Report object, i.e. Single Data, Item Table, Pie Graph, Bar Graph, Line Chart.
- We recommend to define analytical groups and objects with analytical data only after regular objects are completely defined. This part has to be the last stage of project development.





## Web Manual Driver

Dream Report includes **Web Manual** driver, which enables connectivity to any external databases, which support ODBC connectivity and have supported data structure.

To configure **Web Manual driver**, first, open the **Internal** folder of the **Communication Configuration Wizard** dialog window:

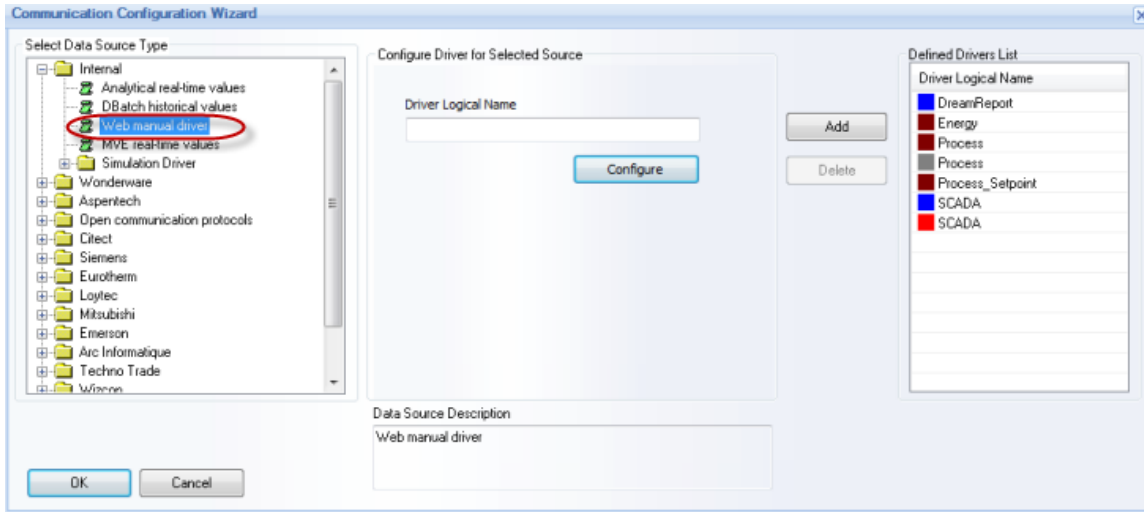

Click on **Configure** button and the following dialog window will be opened:

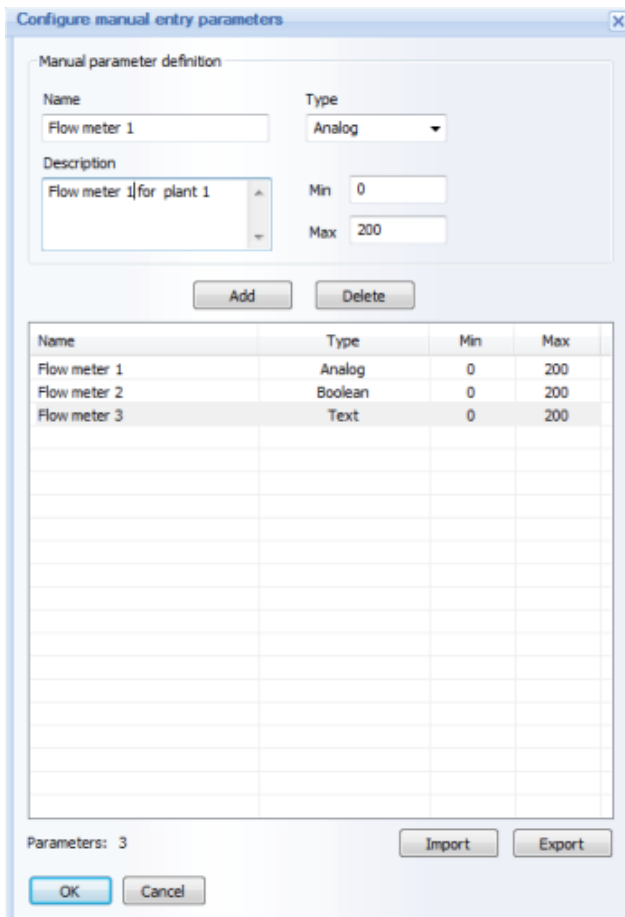



## Ocean Data Systems

Define tags for the selected data source. Every manual tag must have its **Name** and **Type**. Optional information can be also added in the **Description** box (any free text) or for the data validation criteria (**Min** and **Max** values).

The defined manual tag can be one of three types available: **Analog** (default selection), **Boolean** and **Text**.

**NOTE:** The data validation criteria input is available only for the **Analog** type tags. If other type is selected, validation criteria input controls will be hidden.

Values for both **Min** and **Max** for the validation criteria are expected as integer or float numbers. They will be saved and displayed as a double format number. If **Min** or **Max** value edit boxes remain empty, the corresponding **Min** or **Max** double value will be considered.

The amount of manual tags defined in the **Manual Entry Parameters** configuration window will be displayed in the **Parameters:** section below the manual tags list.

If you click "**Export**" button, the standard Windows "**Save As**" window will be opened, where you can select location and name for the list export file. A list export file format is **csv** with semi-column used as a separator. A list export file will have a header, as the first row, and data starting from the second row. It will have 5 columns: **Name**, **Type**, **Min**, **Max**, **Description**. **Name** and **Type** fields are obligatory and others are optional.

If you click "**Import**" button, the standard Windows "**Open file**" window will be opened, where you can select location and name for the list import file. "**Open file**" will be filtered by "**\*.csv**" extension.

The format of the import file list will be exactly the same as described in the "**Export**" section. Only 2 columns - **Name** and **Type** are obligatory. If a list file with only these 2 columns has been created, such an import file should be imported as well.

When a file will be imported, the message box will pop up, asking: "*Do you want to replace existing tags by the importing list?*" The corresponding operation will be done according to a user's choice.

**NOTE:** If you try to import tags, appending the list to the existing one, and the imported tag will have the same name as an already existing one, a message box will pop up saying that the duplicated tag name has been found, specifying the name of that tag and proposing a user to choose either to "use an existing tag definition", or "delete an existing one and use an imported tag definition. The corresponding action will be done according to the user's choice.

There is no limit in term of the number of tags, defined in the **Web manual driver** configuration dialog window.

**NOTE:** If you need to configure the same driver more than once, then, after having configured it the first time, you'll just need to click in the "**Select Data Source Type**" field on any other driver and then go back to the driver that you need to configure.



## Rockwell RSView Historical Values Driver

The Rockwell **RSView Historical values** driver allows Dream Report to access RSView32 internal proprietary history archives (.DBF files), and generate reports directly from that archive, without the necessity of first exporting data into an open database or other format.

This driver allows connecting to either local or remote **.DBF** historical archives.

To add this driver to the project, select the **RSView Historical values** driver from the list of Rockwell drivers folder in the section, as shown below:

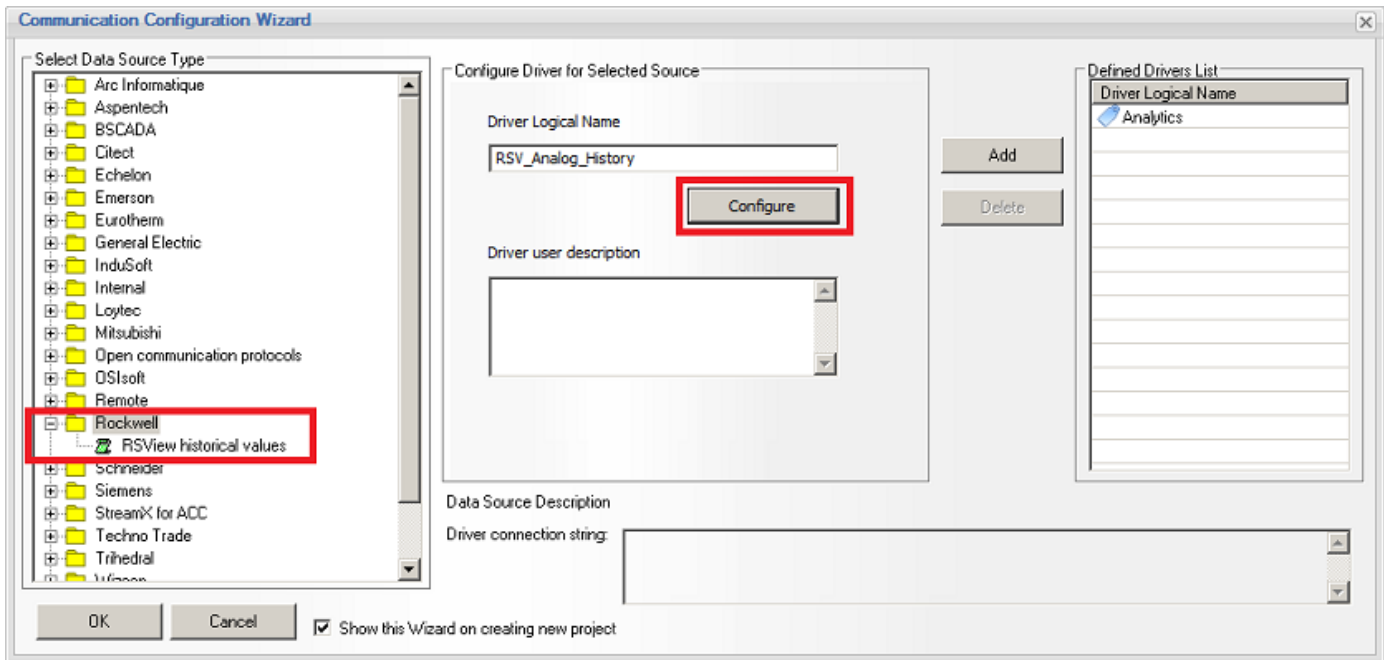

Once the driver is selected, the **"Configure"** button will become enabled. Enter a **Driver Logical Name**. Click the **"Configure"** button, and the following **RSView DriverSettings** configuration window will be opened:

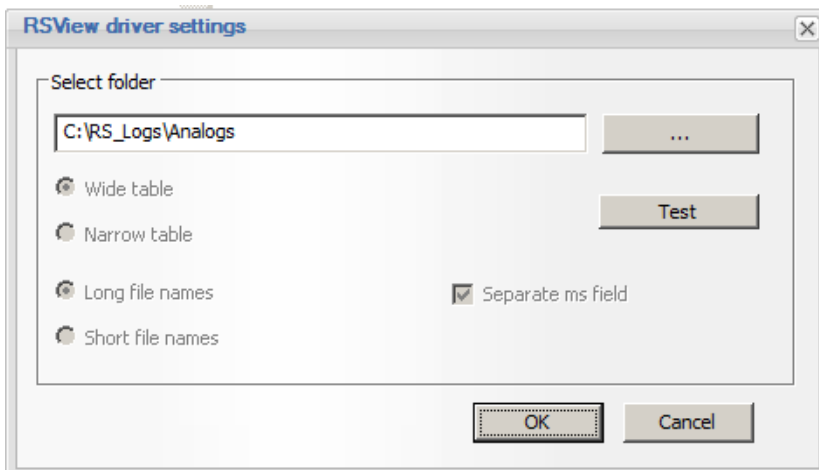



## Ocean Data Systems

By default the folder path will be blank in the [Select Folder](#) section. Click the [...] button in to browse for a path containing RSView *.DBF* log files. Click the "Test" button to verify that valid files exist in the selected directory. Click "OK" to close the driver configuration.

Make sure to click "Add" to add the configured driver to the Defined Drivers List.

### Tag Browsing

RSView historical log file data can be accessed from any reporting object when creating a report, by selecting [External History Server](#) and then clicking "Edit List" button to select the configured data source - all tagnames contained in the log files will be available to select for reporting. When opening the history tag browser for the first time, the driver will get the list of all tags and save it in a static tag array. On subsequent tag browsing, a cached list of tagnames will be immediately available.



## InTouch Native Driver

Dream Report includes native **InTouch drivers** for data and alarms. Those drivers allow connecting Dream Report to InTouch, receiving list of tags from the local InTouch HMI project, receiving tag values from InTouch, writing values back to InTouch and also receiving real-time alarms from InTouch.

**NOTE:** The **InTouch Native Driver** configuration described in this section is valid for earlier Dream Report versions. In the new version 4.5 of Dream Report it has been replaced by **SuiteLink driver**. For details on SuiteLink driver configuration, please go to the **SuiteLink Driver** section of this manual.

- **Adding InTouch driver to a project and driver configuration**

In order to add InTouch driver to the Dream Report project, in the **Wonderware** folder of the **Select Data Source Type** section of the **Communication Configuration Wizard** select "**Real-time connection to InTouch local node**" (please see the picture below):

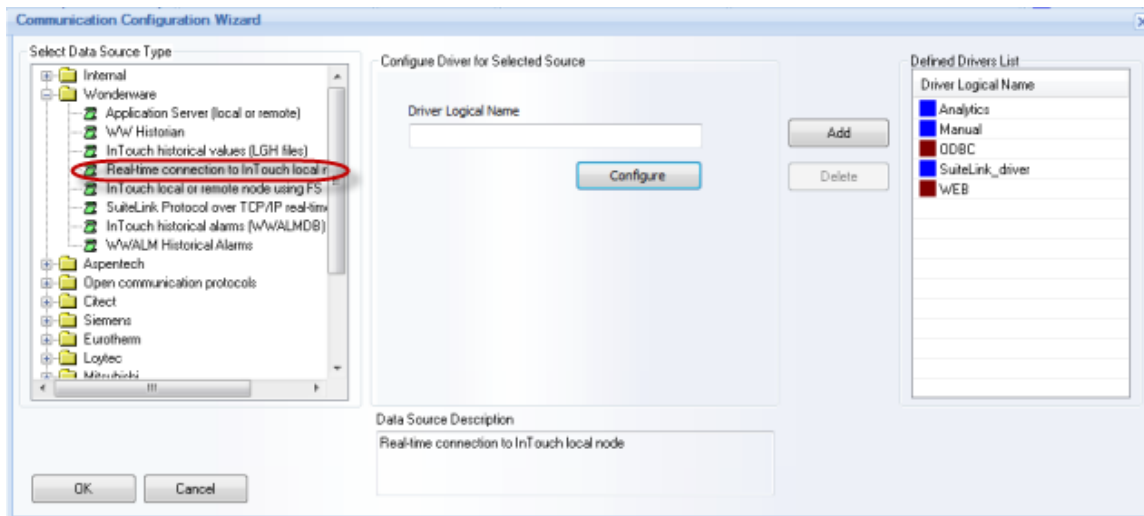

The "**Configure**" button will be enabled. Click on it to configure the driver.

- **Driver configuration**

Data access and Alarm drivers have different configuration windows and must be configured separately, so if both drivers have to be used - they both have to be configured one after one.

Data Access driver can provide a list of tags, available in a local InTouch project. It enables Dream Report reading tag values from InTouch (pooling mode), writing values into InTouch tags and subscribing and receiving tag value change events from InTouch (unsolicited mode)



**Configuring data access driver (browser):**

1. When clicking on **Configure** button for the Data Access driver, the following configuration window will be opened:

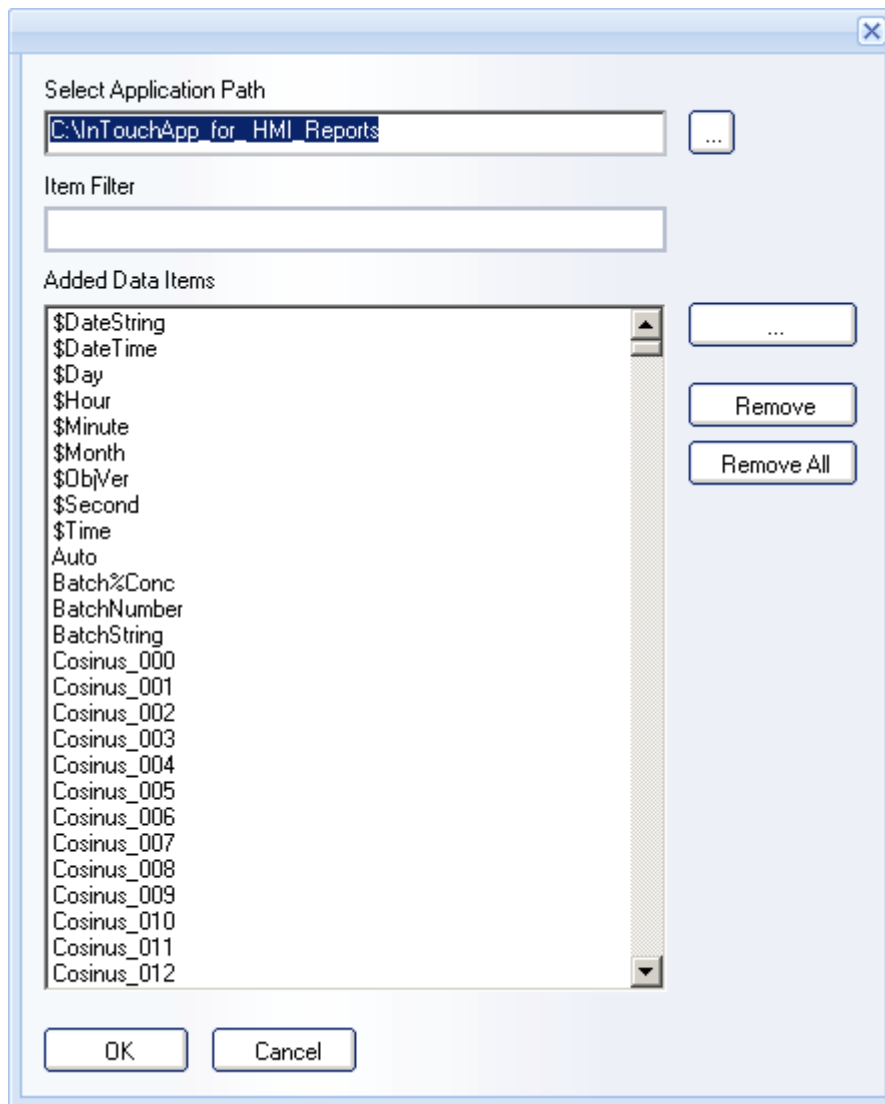

2. In edit box **Select Application Path**, in a top left corner, you have to enter a path to InTouch project. If you wish to browse for that folder - click on **...** button and folder browse dialog window will be opened.

3. As soon as the project folder has been entered, you have to click the button **"..."** (browse) to the right of the list box, and the window, filled with a list of tags, available in selected InTouch project, will be opened:

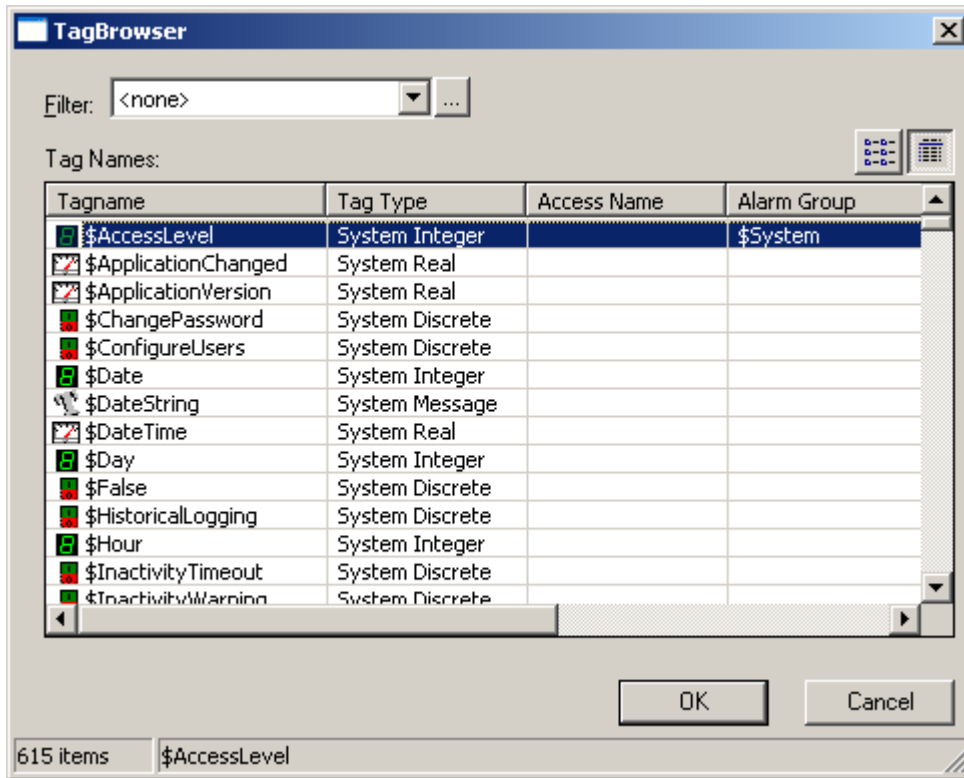

You have to select all tags, required in Dream Report project by selecting a tag in the list box. You can also select several tags in one shot, by selecting a first tag of required list and then, pressing Shift button, select the last tag of the list.

The browse list of tags can be also filtered by selecting appropriate filter from a [Filter](#) combo box in the top left part of the browser window.

When all required tags are selected, click [OK](#) button, and the list of selected tags will be saved in the project and the tag selection window will be closed.

When you have completed tag selection for Dream Report project, click [OK](#) button and driver configuration window will be closed.

**NOTES:**

- Only tags, selected in the driver configuration window and listed in the right list box, will be available inside Dream Report.
- If InTouch is not installed on a same machine with Dream Report, when clicking on [Configure](#) button, no configuration window will be opened, but an error message box will be displayed, saying that no InTouch installation was found and driver cannot be configured and used in a project.
- If you need to configure the same driver more than once, then, after having configured it the first time, you'll just need to click in the "**Select Data Source Type**" field on any other driver and then go back to the driver that you need to configure.



## Wonderware OPC Driver

**Wonderware OPC** driver of Dream Report has to be used to connect Dream Report to FS Gateway OPC Server, which enables connectivity to the Application Server or other Wonderware product.

The Wonderware OPC driver is based on the OPC technology, and is specially designed to work with FS Gateway OPC server with a limited number of concurrent OPC clients.

It's impossible to communicate with FS Gateway OPC server using regular OPC driver due to the following reason: FS Gateway allows only 1 simultaneous OPC client connection and Dream Report can establish up to 3 client connections (Designer studio: 1 connection for tag browser and 1 connection for data access client; Logger studio: 1 connection for OPC Client to get value updates). FS Gateway doesn't support simultaneous connection of 2-3 and more OPC Clients.

In order to adapt the OPC client of Dream Report to work normally with such OPC server, this Wonderware OPC driver has been designed. It's based on the regular OPC client with a modified mechanism of tag browsing and establishing connections to server.

As soon as you add the Wonderware OPC driver to your project - the Studio will establish only 1 client connection (for tag browsing only), and the OPC client will not be loaded into the Studio. During the first connection to FS Gateway, tag browser will request and save the entire list of items from the OPC server into a text file in the System folder of the Dream Report installation. The name of that file will be **<address of your OPC server>.DATA**. Then, each time, when you open the Designer studio, Dream Report will not establish a new connection to the OPC server, but will provide a browse from an existing text file. This will enable you to edit your project, while Runtime Manager is running, without damaging its client connection.

**The order of using this driver** is the following:

1. Add Wonderware OPC driver to your project.
2. Design your project.
3. Save your project and close the Designer studio.
4. Start runtime.

Now you can also open the Designer studio while runtime is running - the client connection will not be damaged.

In order to refresh the list of browsed items from the OPC server, you have to delete manually or rename the existing browse text file, close Runtime Manager, and then load the Designer studio again. Then, the Studio will get a new browse list of items from the OPC server, and create a new browse text file.

All the communication with the data server is done using the regular standard OPC communication protocol.

Wonderware OPC driver supports OPC 1.0 and OPC 2.0 standards. The driver can be configured to any local or remote OPC server, having flat or hierarchical architecture.

### Driver Configuration

1. In order to configure the Wonderware OPC driver, please, open the **[Communication Configuration Wizard dialog window](#)**, select Wonderware OPC driver (**InTouch local or remote node using FS Gateway OPC** or **Application Server (local or remote)**) from the Wonderware folder of the **Data Source Selection** tree (please see the picture below):



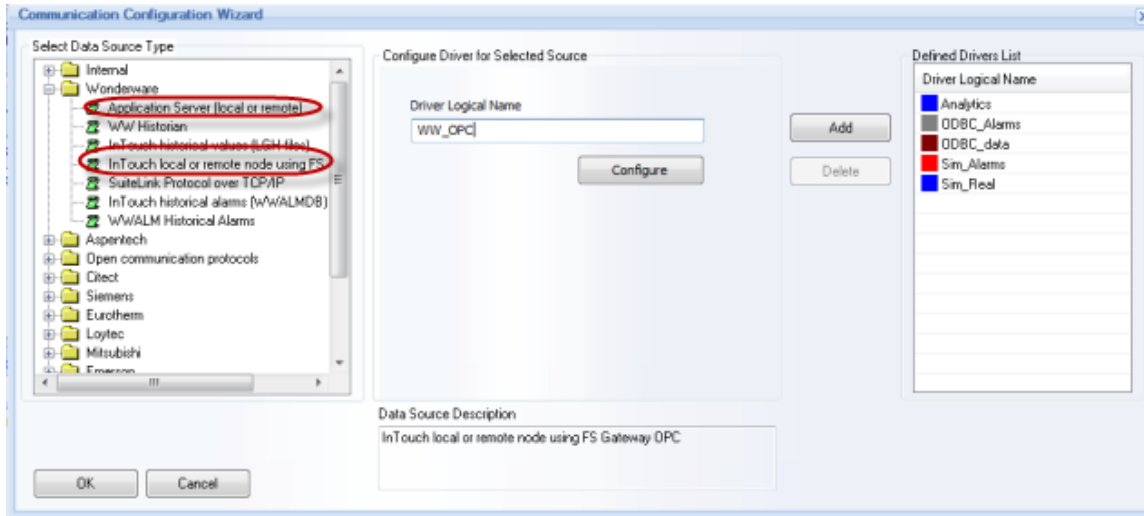

Click on *Configure* button. The OPC driver configuration window will be opened:

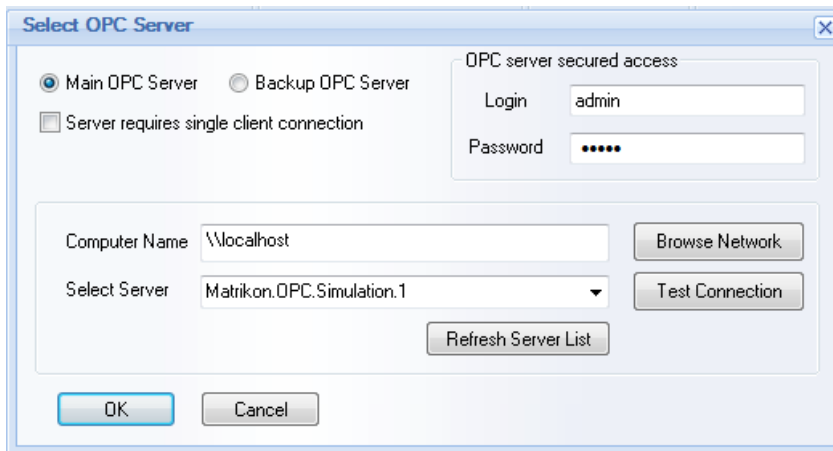

This dialog window has 2 options (radio buttons: **Main OPC Server** and **Backup OPC Server**), that allow OPC driver to work in a hot-backup mode and automatically switch from one OPC server to another in case of communication error, being able to connect to the secured OPC servers.

If the **“Main OPC Server”** radio button is enabled, you can select the computer name and the OPC server.

If the **“Backup OPC Server”** radio button is enabled, the **Computer Name** edit box and the **Select Server** combo box will be empty. You will be able to make another selection for the backup OPC server.

If the OPC server has secured (password protected) connection, it will be possible to specify, in the **OPC server secured access** section, login and password for the connection for the selected OPC server. Login and password will be set and saved separately for the main and backup servers.

**NOTE:** If OPC server definition contains login and password, the OPC browser and client will use it every time, when connecting to the OPC server.

If no login and password is defined, then the OPC browser and the client will be connecting to the server as usual, in anonymous mode.



## Ocean Data Systems

In the **Select Server** combo box, please, select the required OPC server, to which you would like to connect (FS Gateway) from the selected PC.

In the **Computer Name** field, specify the name of the PC, where OPC server is running. By default it is "**Vocalhost**", which means a local PC. If another PC in a network has to be specified, click on **Browse Network** button, and then select the needed computer name from a network.

You can refresh server list from the specified PC by clicking on the button "**Refresh Server List**". It will get a list of OPC servers, installed on the specified PC, and update the list of servers in the combo box.

When the OPC server is selected, click the button "**Test Connection**" to test communication between Dream Report OPC client and your OPC server.

### NOTES:

- During installation of Dream Report, additional OPC component will be installed - OPC Core Component Redistributable 2.20 from OPC Foundation. It's supposed to repair all possible problems in the OPC servers registrations and repair the Windows OPC component installation.
- If you need to configure the same driver more than once, then, after having configured it the first time, you'll just need to click in the "**Select Data Source Type**" field on any other driver and then go back to the driver that you need to configure.

### Wonderware OPC Driver Configuration in Wonderware License Migration

If a customer upgrades Wonderware Quick Reports (either production or consignment) license to a Wonderware Dream Report license, this upgraded Wonderware Dream Report license doesn't allow using OPC drivers from **Open Communication Protocols** any more. Customer has limited access only to OPC drivers allowed by Wonderware and located in the **Wonderware** folder in Dream Report driver configuration section ("**Application Server (local or remote)**" or "**InTouch local or remote using FS Gateway**").

If a customer has an OPC driver configured in the **Open Communication Protocols** in the Wonderware Quick Reports license and he wants/needs to use it in the upgraded Wonderware Dream Report license, he can use one of the following options described below:

**A.** Delete an OPC driver, which has been configured in the **Open Communication Protocols** in Wonderware Quick Reports license, and configure a new OPC driver in the **Wonderware** folder in Dream Report driver configuration section ("**Application Server (local or remote)**" or "**InTouch local or remote using FS Gateway**"). In this case all existing log groups (data) for this driver will be lost.

**B.** Perform the following actions for changing driver configuration (in this case all log groups (data) won't be lost):

1. Configure Wonderware OPC driver in the **Wonderware** folder in Dream Report driver configuration section ("**Application Server (local or remote)**" or "**InTouch local or remote using FS Gateway**");
2. Close Dream Report studio;
3. In the Project folder open **ProjectCfg.mdb** file and select the table "**Data Sources**" where all data about the drivers, which have been configured in the project, are stored;
4. In the "**Data Sources**" table select this newly configured Wonderware OPC driver and copy data from all sections (except for the "**Driver Definition**" section, it must remain unchanged) into the corresponding sections of the configured OPC driver which you want/need to keep for your project;
5. Delete the configured Wonderware OPC driver from the "**Data Sources**" table.
6. Now, the OPC driver, which has been defined in the project with the Wonderware Quick Reports license, will have the configuration of a Wonderware OPC driver allowed by Wonderware in the Wonderware Dream Report license and all the existing data (log groups) won't be lost.



## Ocean Data Systems

**Example:** if you have "**OPC DA real-time values**" driver with the name "**OPC\_DA**" configured in the project in Wonderware Quick Reports and you upgrade your license to Wonderware Dream Report and you don't want to lose your data (log groups) from the driver "**OPC\_DA**", please do the following:

1. Configure a new Wonderware OPC driver (for example, with the name "**WW\_OPC**") in the **Wonderware** folder in Dream Report driver configuration section ("**Application Server (local or remote)**" or "**InTouch local or remote using FS Gateway**");
2. Close Dream Report studio;
3. In the Project folder open **ProjectCfg.mdb** file and select the table "**Data Sources**";
4. In the "**Data Sources**" table select "**WW\_OPC**" driver and copy data from all sections (except for the "**Driver Definition**" section) into the corresponding sections of the "**OPC\_DA**" driver.
5. Delete the "**WW\_OPC**" driver from the "**Data Sources**" table.
6. Now the "**OPC\_DA**" driver will have the configuration of the "**WW\_OPC**" driver (allowed by Wonderware) but the existing log groups (data) from the "**OPC\_DA**" driver won't be lost.



## Wonderware Historian driver

**Wonderware Historian** driver enables users to directly access Wonderware Historian and extract data using WW Historian's native retrieval modes. The driver exposes historical data from both the History/WideHistory tables, and the AnalogSummary/StateSummary (aggregation) tables.

The driver does not require creating an ODBC DSN connection. Select **Wonderware Historian** driver from the list of **Wonderware** history access drivers in the **Wonderware** folder of the **Select Data Source Type** section (please see the picture below):

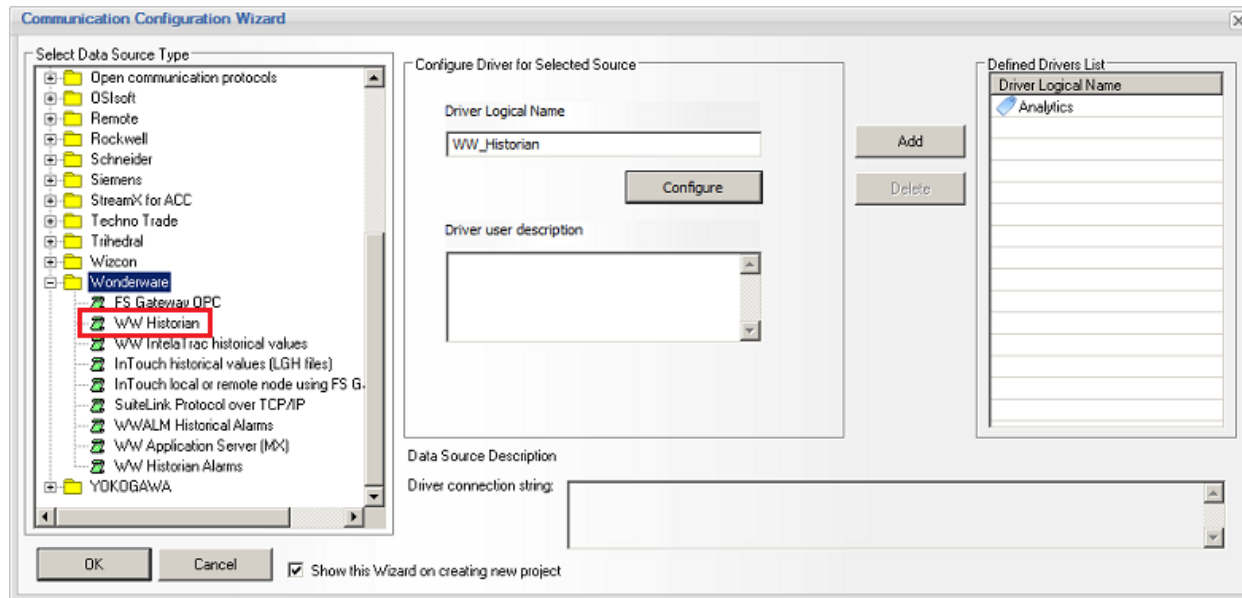

The **"Configure"** button will be enabled. Click on it to setup the driver configuration. If you click on **"Configure"** button, the **Wonderware Historian access configuration** dialog window will be opened:

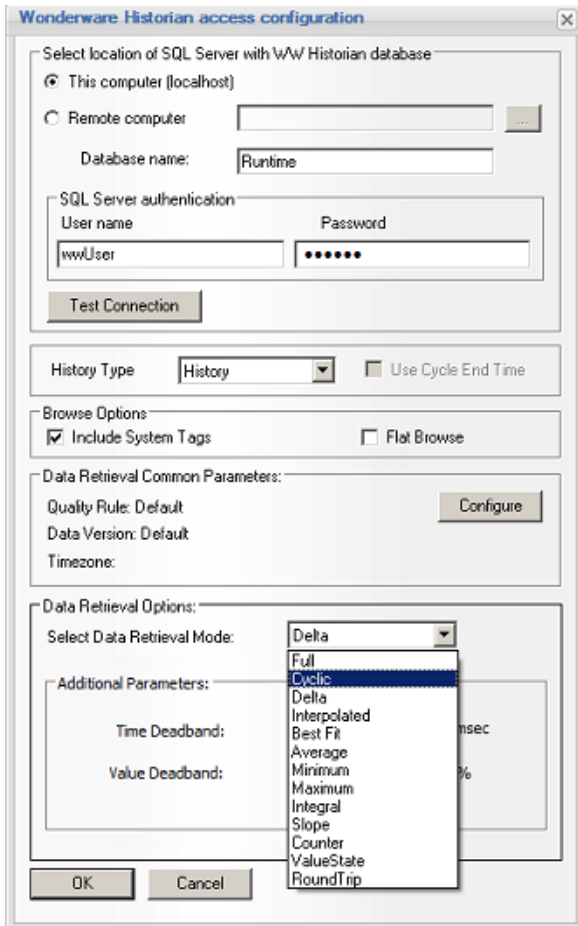

First, in the **Select location of SQL Server with WW Historian Database** section, specify the Wonderware Historian to connect to. This can be either a local computer or remote. If it's a local PC, you just have to keep the option **"This computer"** selected. If you need to connect to a remote WW Historian server, you have select the **"Remote computer"** option. Then click on **"..."** (browse) button and select a remote PC, where your WW Historian server is running. Or, simply enter the server name or IP address of the appropriate WW Historian.

Once you have selected the location of your WW Historian server, enter a valid **User name** and **Password** to the SQL Server with WW Historian. If your SQL Server has Windows Authentication mode and if your Windows account has access to the "Runtime" database, then you can leave the **"User name"** and **"Password"** edit boxes empty (Windows authentication of the current user will be used.)

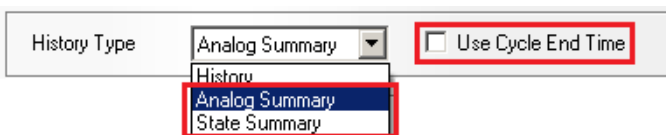

In the **History Type** section, select either *History*, *Analog Summary* or *State Summary*:

**History** - the instance of the WW Historian driver will query and extract data from the "raw" history tables or views such as *"History"* and *"WideHistory"*

**Analog Summary** - the instance of the WW Historian driver will query and extract data from the "AnalogSummary" aggregate table, which contains a set of summary data (min, max, avg, integral, etc.) for analog tags defined in Historian for analog summary replication



**State Summary** - the instance of the WW Historian driver will query and extract data from the "StateSummary" aggregate table which contains a set data aggregates (time in state, number of occurrences, etc.) for discrete and integer tags defined in Historian for state summary replication

If either **Analog Summary** or **State Summary** are chosen, then the option "**Use Cycle End Time**" will be enabled. The Historian "Summary" tables include a "**StartDateTime**" and "**EndDateTime**" for each row of data, indication the time period over which the summary/aggregates are calculated. This check box will allow the user to specify which timestamp field Dream Report should use when querying the database.

The **Browse Options** allows the user to specify if Dream Report should **Include System Tags** when browsing the Historian's tags. The **Flat Browse** option enables tag browsing in a simple or "flat" structure, or expose the tags as organized in Historian's tag grouping structure contained under the main ("Public") tag group/folder.

If you wish to test connection to your selected WW Historian server, click on "**Test Connection**" button, and the message box with the appropriate result of test connection will be displayed.

In the "**Data Retrieval Common Parameters**" section, define the rules for specifying the **Quality**, **Data Version** and **Time Zone** for retrieving data from the WW Historian.

In the "**Data Retrieval Options**" section, select an available data "retrieval mode" (i.e., the way the data should be retrieved by this driver from the WW Historian.) These retrieval modes are specific to WW Historian. For example, you can configure the driver to extract the data from Historian in 1 minute "**Cyclic**" intervals, by specifying the following parameters:

Data Retrieval Options:

Select Data Retrieval Mode: Cyclic

Additional Parameters:

Select Cycle definition type: Resolution Value: 60000 msec

Select Timestamp Rule: Default

For more information about the data retrieval quality rules and the data retrieval modes, please, refer to the "Retrieval Modes" section of the Wonderware Historian user manual.

**NOTE:**

Dream Report allows for multiple instances of the WW Historian driver to be configured to the same Historian. This is useful if you need to use Historian's different retrieval modes in a reporting project. **For example**, you might name one instance *WW\_Hist\_Delta*, defined with "Delta" retrieval mode; one instance *WW\_Hist\_1minCyc*, defined with "Cyclic - 1 minute" retrieval mode; and one instance *WW\_Hist\_1dayMax*, defined with "Maximum - 1 day" retrieval mode. All instances will point to the same Historian and will browse the same tag configuration, but at report generation time, the data will be retrieved from the WW Historian using the specified retrieval mode.

In many cases, it is highly recommended that you take advantage of Historian's retrieval modes to "pre-process" the data, allowing for much faster report generation in Dream Report. For instance, a daily "totalization" report over a month would need to integrate a flow-meter tag on a daily basis for a month. Using a "full" or "cyclic" retrieval mode to extract the data would result in millions of rows of data being returned and needing to be totalized in Dream Report (using the Dream Report "Integral" statistical function.) However, if you configure the Historian driver in Dream Report to use Historian's "Integral" retrieval mode, at 1 Day resolution (86,400,000 msec), Historian will calculate the integrals, and simply return one value per day (i.e., the integral) to Dream Report to report on.

If you need to configure the same driver more than once, then, after having configured it the first time, you'll just need to click in the "**Select Data Source Type**" field on any other driver and then go back to the driver that you need to configure.



## InTouch Historian Driver (LGH files)

**InTouch historical values (LGH files)** driver allows Dream Report to access InTouch internal proprietary history archive, which is saved in LGH binary files, and make reports directly out of that archive, without the necessity of exporting data into an open database. This driver allows connecting to either local or remote LGH historical archives.

To add this driver to the project, a user has to select **InTouch historical values (LGH files)** driver from the list of Wonderware history access drivers in the **Wonderware** folder of the **Select Data Source Type** section (please see the picture below):

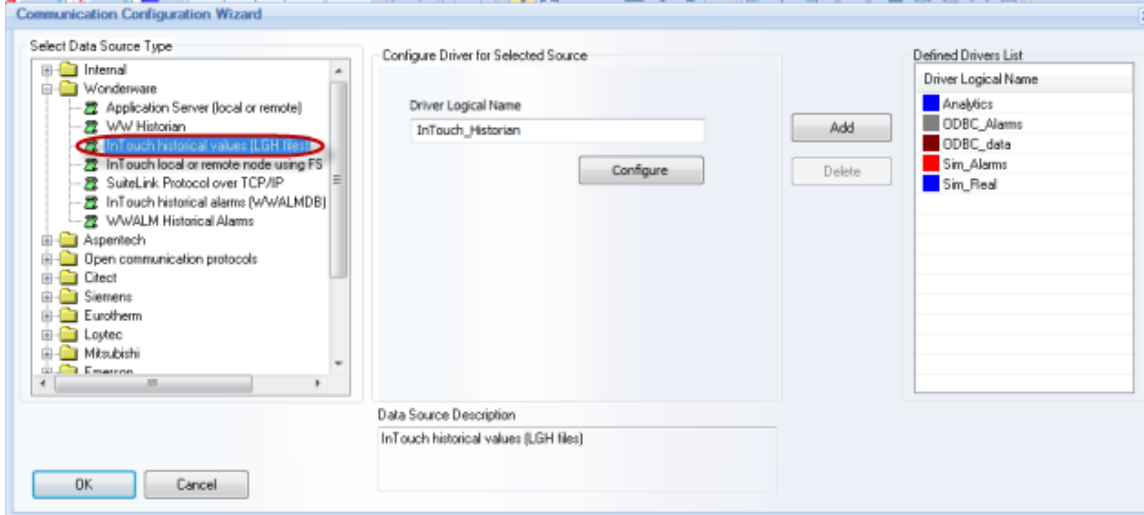

Then button "**Configure**" will become enabled. Click on "**Configure**" button, and the following driver configuration window will be opened:

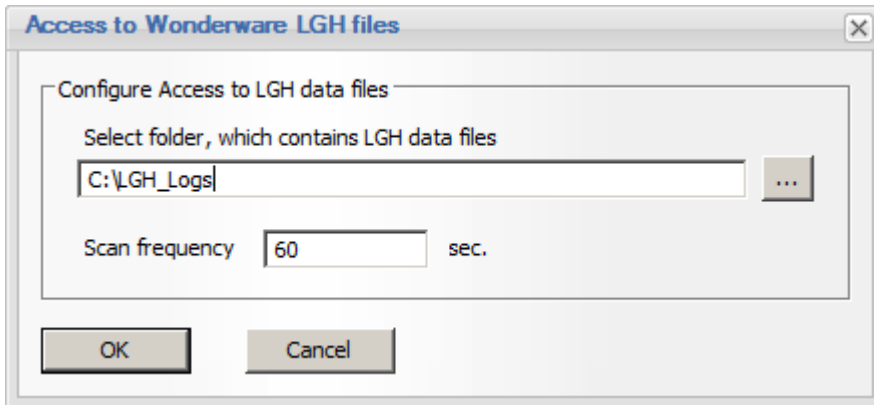

In the **Access to Wonderware LGH files** dialog window, browse or enter the path containing the LGH files. By default the LGH path will be empty. If real-time InTouch driver is enabled and configured in the project, then the default path to LGH files will be taken as follows: "**<InTouch project path>/LGH**". If a user will click on the "... " button in the "**Configure Access to LGH data files**" section, then the standard "Select folder" dialog window will be opened (it will be the same as the one which is opened when a user clicks on the button to browse for an InTouch project).

## Tag Browser

When opening the history tag browser for the first time, the driver will get the list of all tags and save it in a static tag array. Then, when another call to get a browse of the list of tags will come, the driver will return immediately the ready content of the tag array. This array will be kept until the driver "Shut()" function is called.



## Data extraction

When the request to get the list of values arrives from the History Manager, the driver will open appropriate LGH files, will extract all values of the specified tag for the specific period of time, and will return it.

Following the common design of all Dream Report data access drivers, when extracting all tag values from the LGH archive, the driver will fill the values vector, which is provided by the History Manager, with the maximum of 100 values, and will remove those provided from its internal record set. Then, when the History Manager will call the driver again to receive the next portion (100 values), the driver will just fill the array with the next 100 values and also delete them from its internal record set. This will be called in a loop until the History Manager stops receiving all available values by those 100 values portions. If the amount of extracted values is too big, the driver will extract the maximum of 200,000 values. If this limit is reached, all other remained values will be skipped.

**NOTE:** Please note that LGH history does not include the string tags.





## Wonderware WWALM Historical Alarms Driver

The **WWALM Historical Alarms** driver of Dream Report allows connecting to a local or remote SQL Server database (WWALMDB, or user-specified database name) with Wonderware alarms, make alarms extraction and provide them for reporting.

To add this driver to the project, please select **WWALM Historical Alarms** driver from the list of Wonderware history access drivers in the **Wonderware** folder of the **Select Data Source Type** section (please see the picture below):

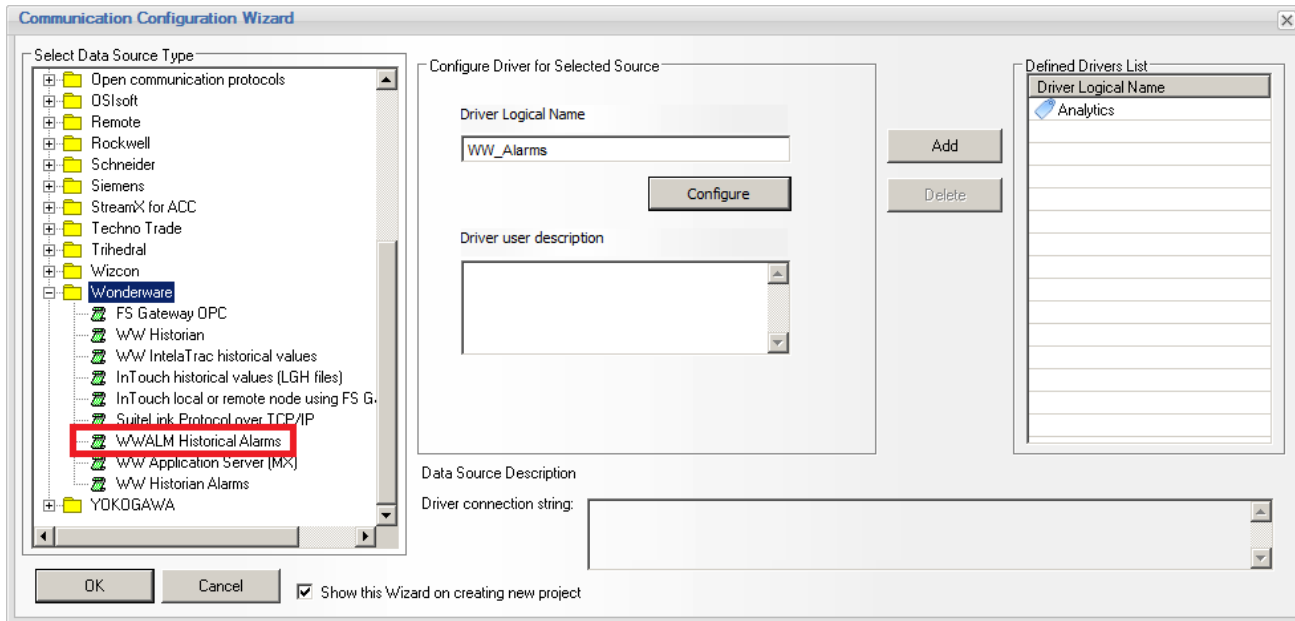

### WWALM Historical Alarms driver Configuration

If **WWALM Historical Alarms** communication driver is selected, then, as soon as you click on "**Configure**" button, the following **WWALM Historical Alarms** driver configuration dialog window will be opened:

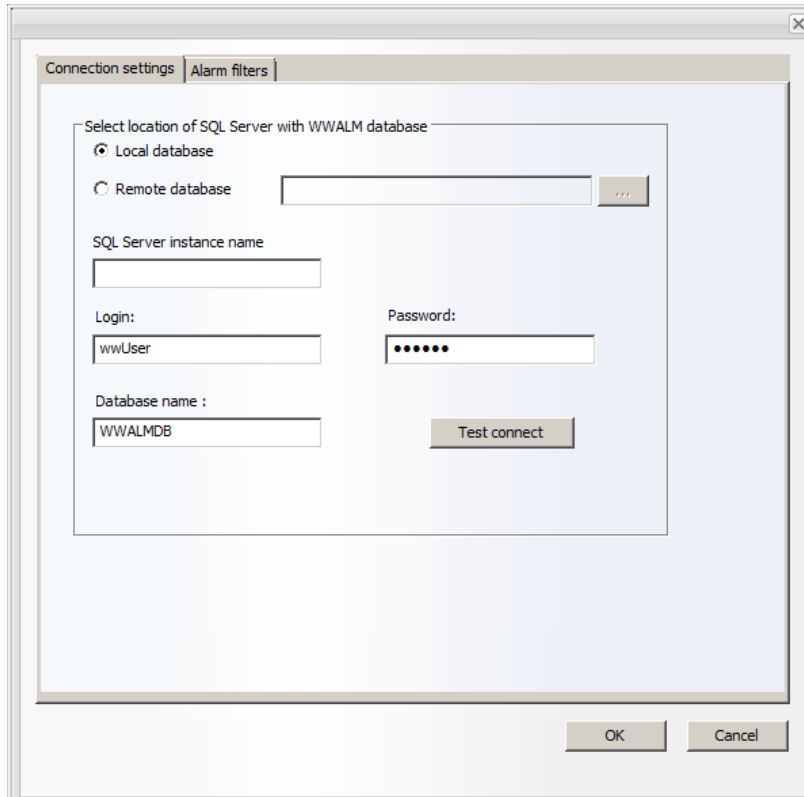

### Connection Settings

In this window user can define connection to the **WWALMDB** (Wonderware Alarms Database) database. The connection to the WWALMDB database can be configured either by using the SQL Server database locally ("**Local database**") or remotely ("**Remote database**").

If the SQL server, which is running the WWALMDB database, is configured with user authentication, then enter **login** and **password** for the SQL Server into the corresponding edit boxes.

If your SQL Server is configured with Windows Authentication mode, leave the user name and password edit boxes empty.

The "**Test Connect**" button will try to establish communication to the WWALMDB database based on SQL Server.

### Alarm Filters

In this window user can define alarm filters and alarm filtering conditions (please see the following image):

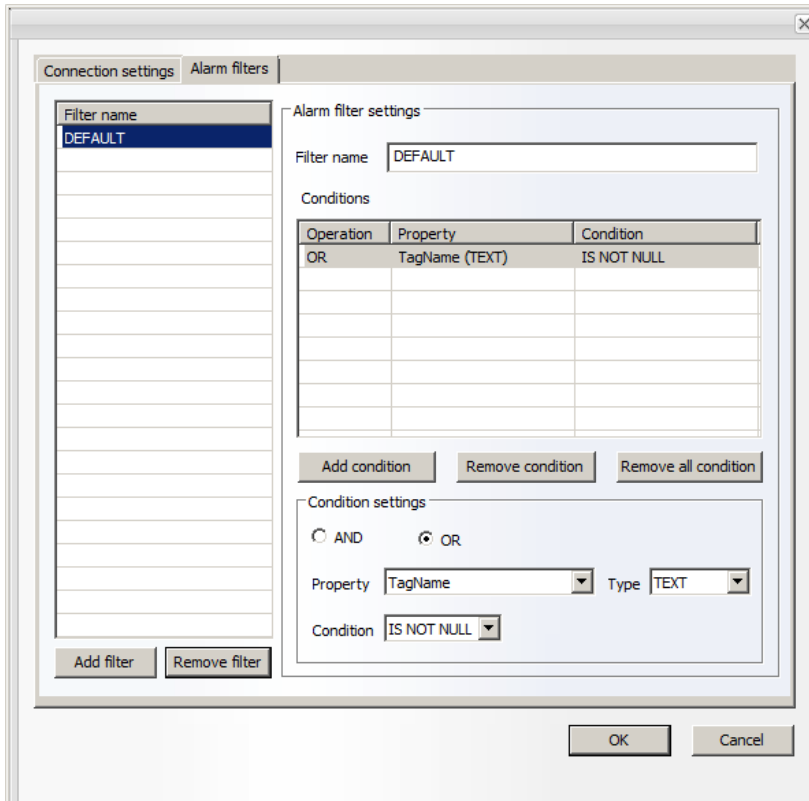

In the "Filter Name" section user can define the name of the alarm filter (which should be unique).

**NOTE:** By default, when the "Alarm filters" window is opened, the WWALMDB filter will be configured with the name "DEFAULT" and with the following filtering conditions as: "OR" (Operation), "TagName (TEXT)" (Property) and "IS NOT NULL" (Condition).

This default alarm filter will display all alarms without filtering them.

### Condition Settings

The "Property" combo box will include the list of all properties which exist in the alarm table.

The "Type" combo box will include 3 options: **Numeric**, **Text** and **Boolean**.

If the **Numeric** type is selected, the **Condition** combo box will have the following options: **!=", =, >, >=, <, <=, BETWEEN**.

If the **Text** type is selected, the **Condition** combo box will include the following options: **!=", =, IS NOT NULL, IS NULL, LIKE**.

If the **Boolean** type is selected, the **Condition** combo box will include only one option: **=, !=**.

After having defined the **Condition**, user will select **AND** or **OR** and click on **Add condition** button.



## Ocean Data Systems

When all conditions have been added, user will click *Add filter* button and the defined filter will be added to the list of filters (in the "Filter Name" table).

**NOTE:** If user selects filter from the list, the "Conditions" list will be filled with the filter settings.

If user selects condition from the list of conditions, all dialog controls will be filled according to the defined condition.

If user has defined the alarm filter without clicking on *Add filter* button and clicks *OK* button, the filter, which has not been added before, will be automatically added to the list of alarm filters.



## WW Historian Alarms Driver

The Dream Report **Wonderware Historian Alarms** driver allows for connecting to and reporting on high-speed alarms and events that have been logged to history blocks in Wonderware Historian from Application Server (available in *Wonderware System Platform 2014 R2* and later.) The Historian containing these alarm logs can be either local (on-premise), remote, or even Cloud-based. Access to on-premise Historian alarms is done natively using the Wonderware *SDK* and communication to a cloud-based Historian is implemented using the *oData* protocol.

To add this driver to the project, please select the **WW Historian Alarms** driver from the list of drivers in the **Wonderware** folder of the **Communication Configuration Wizard** (please see below):

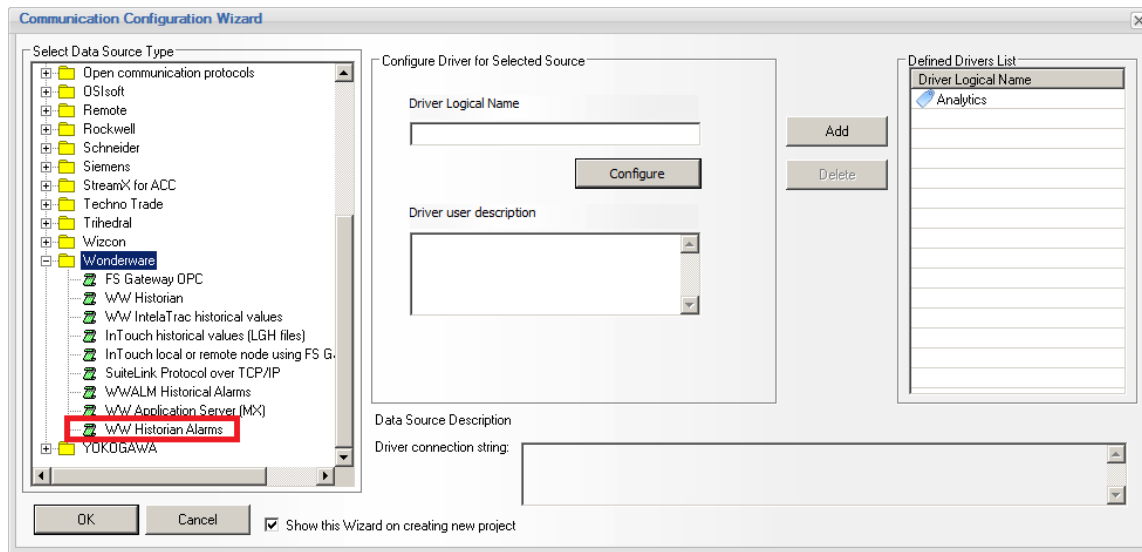

### WW Historian Alarms Driver Configuration

Select the **WW Historian Alarms** communication driver and click on the "**Configure**" button. The following configuration dialog window will be opened:

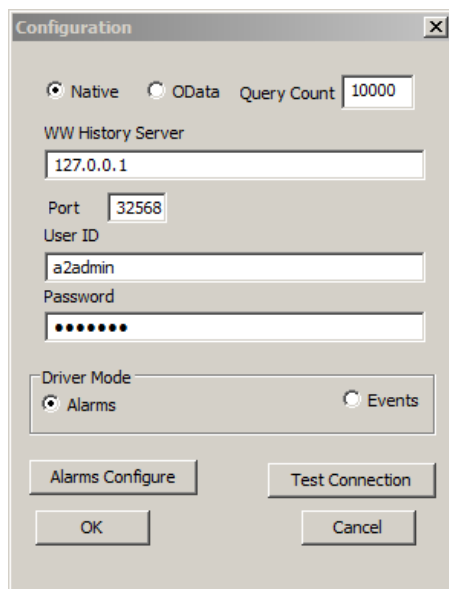



### Connection Settings

There are two ways in which this communication driver can connect to the Wonderware Historian alarm files - either using the “**Native**” option (using the Wonderware Historian SDK) or using “**OData**” calls (Open Data Protocol.)

The **Query Count** option can be set to limit the number of rows returned from an alarm query in this connection - the default is 10,000 rows.

Enter the **Wonderware History Server** (Wonderware Historian) name or IP address. IP address is preferable for remote Historian connections.

The default **Port** number used for this connection is **32568**. For remote connections, make sure that this port is opened. This port number can be changed if necessary, to match the appropriate firewall port. For **OData**, port **32569** is more commonly used.

Enter a **User ID** and **Password** for the Historian server. Note that these credentials are *Windows* credentials, and not SQL Server credentials.

Click the “**Test Connection**” button to verify connection to the Historian. If the test is not successful, the most common things to check are the user credentials entered; the port number being used is being blocked by a firewall; or try using the “other” connection protocol (Native vs. OData).

### Configuring Alarm Filters

Click the “**Alarms Configure**” button to open the configuration window, where a user can define alarm **filters** and alarm filtering **conditions**, as shown below:

The Configuration dialog box shows a list of filters on the left and configuration options on the right. The 'All Tank HI Alarms' filter is selected. The conditions table shows two conditions: Alarm\_Type contains HI and Source\_Area begins Tank. The static configuration at the bottom shows Source\_Area as the column, Tank as the value, and Begins as the condition.

Property	Operator	Value
Alarm_Type	Contains	HI
Source_Area	Begins	Tank



## Ocean Data Systems

Enter a **Filter Name** that describes this specific alarm filter. Next, you will need to specify what **Conditions** (alarm properties) to filter on for this alarm filter.

The **Property** section lists all properties for this specific alarm filter. The list will initially be blank, so you can define and add conditions in the section below. Please refer to *Wonderware* documentation for a detailed description of all available alarm properties.

Choose an alarm table **Column** (property) to filter on. Once selected, enter a numeric value or string to evaluate from the **Condition** list. For instance, if you were defining a “High Priority Tank” filter, you might set the filter conditions as follows:

**Column:** *Priority*  
**Value:** *100*  
**Condition:** *LessThan*

Click the “**Add Condition**” button to add this condition to the filter. Then, define the next condition:

**Column:** *Source\_Area*  
**Value:** *Tank*  
**Condition:** *Contains*

Click the “**Add Condition**” button to add this condition to the same filter, and then click “**Add Filter**” to add this filter to the list of defined **Filter Names**.

Many different Alarm Filter names (and associated conditions) can be created, that can then be used in an **Alarm Table** object, where the filter(s) can be selected to filter the alarm report as needed.

Click the “**OK**” buttons to close the **Alarm Filter Configuration** window, and the **WW Historian Alarms** configuration window.

### NOTE:

1. If more than one condition is defined in a specific **Alarm Filter**, all conditions defined will be “AND’ed” when evaluated - i.e., all defined conditions must be met for the alarm rows to be returned. In the above example, only alarm records with the *Source\_Area* column containing the text “*Tank*” and the associated alarm *Priority < 100* will be returned.
2. If, in the **Alarm Table**, more than one **Filter Name** is selected, the all alarm records associated with each Filter Name will be returned in the report - i.e., Filter Names will be “OR’ed” with each other. In the Alarm Table configuration below, all “*Reactor Alarms*” as well as all “*Tank HI Alarms*” will be returned at runtime:



## OPC Offline Driver

**OPC Offline** driver of Dream Report is a modified OPC driver, which is specially designed for OPC servers with a limited number of available OPC clients, e.g. FS Gateway of Wonderware or DeltaV of Emerson.

This means that if the OPC server allows only 1 simultaneous OPC client connection (for technical or marketing reasons), then the Dream Report studio establishes 2 client connections (1 connection for OPC browser and 1 connection for OPC client - to provide value updates in the Logger studio). Also, if runtime manager is running, another OPC client connection is opened. So, in total, Dream Report can open and maintain up to 3 concurrent connections with 1 OPC server, which cannot work with OPC servers, mentioned above.

In order to be able to work normally with such OPC servers, this OPC Offline driver must be used. As soon as you add OPC driver to your project, the studio will establish only 1 client connection (for browsing only), and OPC client will not be loaded for the studio. During the first connection to a server, the studio will save the entire list of items from the OPC server into a text file in the System folder of Dream Report installation. The name of that file will be *<address of your OPC server>.DATA*. Each next time, when you open the studio, Dream Report will not establish a new connection to OPC client, but will provide a browse from that text file. This will enable you to edit your project, while runtime manager is running, without damaging its client connection.

The order of driver use is the following:

1. Add **OPC Offline** driver to your project.
2. Design your project.
3. Save your project and close the Designer studio.
4. Start runtime.

Now you can also open the Designer studio while runtime is running - client connection will not be damaged.

In order to refresh the list of browsed items from the OPC server, delete manually or rename an existing browse text file, close runtime manager and then load the Designer studio again. Then, the studio will get a new browse list of items from the OPC server and create a new browse text file.

All the communication with data server is done using regular standard OPC communication protocol.

OPC DA driver supports OPC 1.0 and OPC 2.0 standards. OPC driver can be configured to any local or remote OPC server, having flat or hierarchical architecture.

To configure **OPC Offline** driver, first, open the **Communication Configuration Wizard** dialog window:

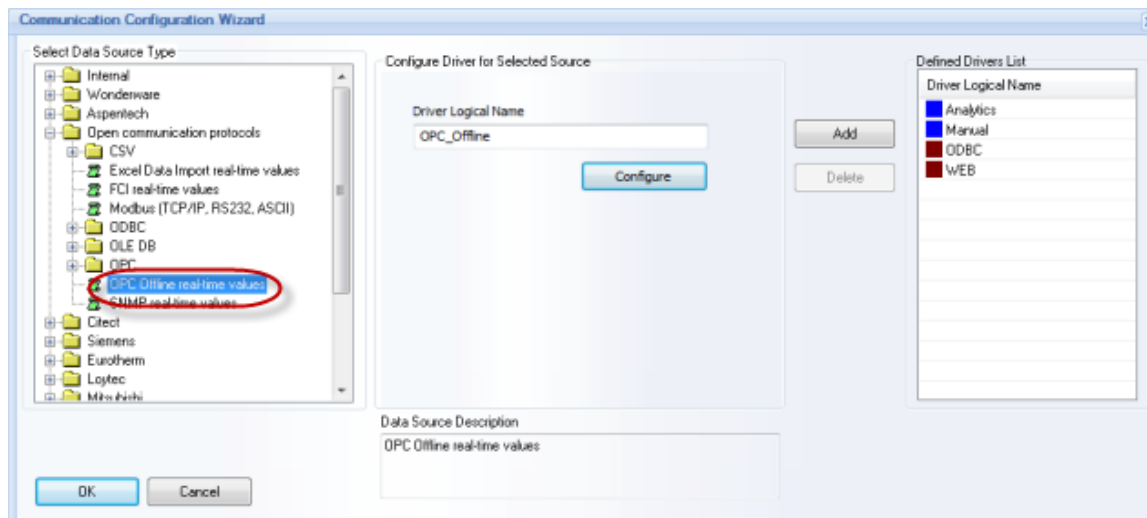





## Ocean Data Systems

Select **OPC Offline** driver from the **Open communication protocols** folder in the **Select Data Source Type** section. Click on **Configure** button and the OPC driver configuration dialog box will be opened:

In this dialog window select an OPC server, to which you would like to connect.

In the **Computer Name** field, specify the name of the PC, where OPC server is running. By default it contains "**\\localhost**", which means a local PC. If another PC in a network has to be specified, click on **Browse Network** button, and then select the needed computer name from a network.

You can refresh server list from the specified PC by clicking on the button "**Refresh Server List**". It will get a list of OPC servers, installed on the specified PC and update the list of servers in the combo box.

When the OPC server is selected, click the button "**Test Connection**" to test communication between Dream Report OPC client and your OPC server.

### NOTES:

- During installation of Dream Report, additional OPC component will be installed - OPC Core Component Redistributable 2.20 from OPC Foundation. It's supposed to repair or possible problems in OPC servers registrations and repair windows OPC component installation.
- If Runtime Manager runs as service, then the OPC connection will work over DCOM and the OPC Server may not be fast enough to supply to the OPC client (Dream Report) the requested amount of data.

If such weak OPC driver performance may occur, in order to improve it a user will have to set Runtime Manager as an application (for details on Runtime mode settings, please see [Runtime Configuration](#) section of this manual).

- If you need to configure the same driver more than once, then, after having configured it the first time, you'll just need to click in the "**Select Data Source Type**" field on any other driver and then go back to the driver that you need to configure.



## Eurotherm Review Communication Driver

**Eurotherm Review** communication driver enables connecting to one or several Review databases.

This driver is available in the **Eurotherm** folder of the **Select Data Source Type** section of the **Communication Configuration Wizard** (please see the (picture below):

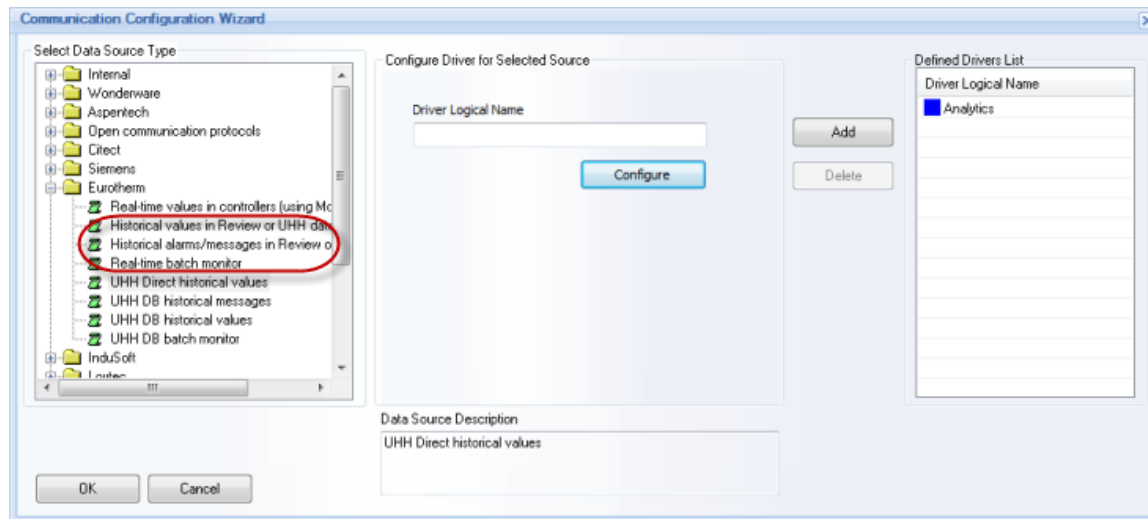

**NOTE:** In Dream Report version 3.43 the Eurotherm (Review) driver had one driver instance for both real-time and historical data access configuration.

Now, in this new version of Dream Report, the Eurotherm (Review) driver has three instances and should be configured separately as "**Historical values in Review database**", "**Historical alarms/messages in Review database**" or "**Real-time batch monitor**".

### Real-time batch monitor driver

This driver can periodically query Review database, detect start of a new batch or end of currently running batch, and assign a corresponding pre-defined value to the logical data point according to the event type (e.g. value '0' if a new batch is started, and value '1' if the actual batch is ended).

If a user has selected the **Real-time batch monitor** driver from the **Eurotherm** folder in the **Select Data Source Type** section of the **Communication Configuration Wizard**, and clicks on the button "**Configure**", then, the **Eurotherm data access driver configuration** window will be opened:



In the **Select database location** section user will have to select whether the default **Review** database (e.g. *C:\Program files\Eurotherm\Review\Review.erv*) or any other **Review** (custom) database will be used for connection. If a user selects option "Use Review database from custom location", then the "..." (browse) button will become enabled, and a user can browse and select the required **Review database** file (with \*.erv extension).

**Data access parameters** section defines which value will be assigned to a selected data point when a new batch will be started, and which value will be assigned to that data point, when the actual running batch will be ended.

**Checkup frequency rate** parameter defines how often the driver will check Review database for batch events. Default value is 20 seconds, i.e. by default every 20 seconds this driver will open connection to the Review database and check for start/stop batch events.

In order to make automatic batch report generation from Review database, user has to:

1. Add Eurotherm Review data access driver to the project
2. Create a batch definition, based on that driver (item-based, external data source, select any data item from required area and dataset)
3. Go to report settings ==> Generate on event section and select any data item from the same area and dataset, which was used for the batch definition, and assign the required value according to the required event type (end of a batch or start of a new batch).

### History Data/Alarms Access Eurotherm Review driver

This driver enables having direct and automatic access to the Review archives, and making reports out of that.

If a user has selected either the **Eurotherm Historical values in Review database** driver, or **Eurotherm Historical alarms/messages in Review database** driver in the the **Eurotherm** folder of the **Select Data Source Type** section of the **Communication Configuration Wizard**, and clicks on the button "*Configure*", then the following **Eurotherm data access driver configuration** dialog window will be opened:



The dialog box is titled "Eurotherm data access driver configuration" and contains two main sections. The first section, "Select database type", has two radio buttons: "Review" (selected) and "UHH history files". The second section, "Select database location", has two radio buttons: "Use Review database from default location" (selected) and "Use Review database from custom location". Below the second section is a text input field with a browse button ("..."). At the bottom of the dialog are "OK" and "Cancel" buttons.

In this window user can select the type of the archives, which need to be accessed, and the location of those archives. User doesn't need to create and configure a DSN or do any configuration other than just pick up the archive selection.

**NOTE:** If you need to configure the same driver more than once, then, after having configured it the first time, you'll just need to click in the "**Select Data Source Type**" field on any other driver and then go back to the driver that you need to configure.



## PcVue Communication Drivers

**PcVue driver** of Dream Report enables you to connect to PcVue SCADA using web services communication, and get access to real-time data, real-time alarms and historical data of PcVue running project.

To configure **PcVue drivers**, first, open the **Communication Configuration Wizard** dialog window. In the **Arc Informatique** folder, please, select the PcVue driver you need from the **Select data source type** section, and click on **Configure** button:

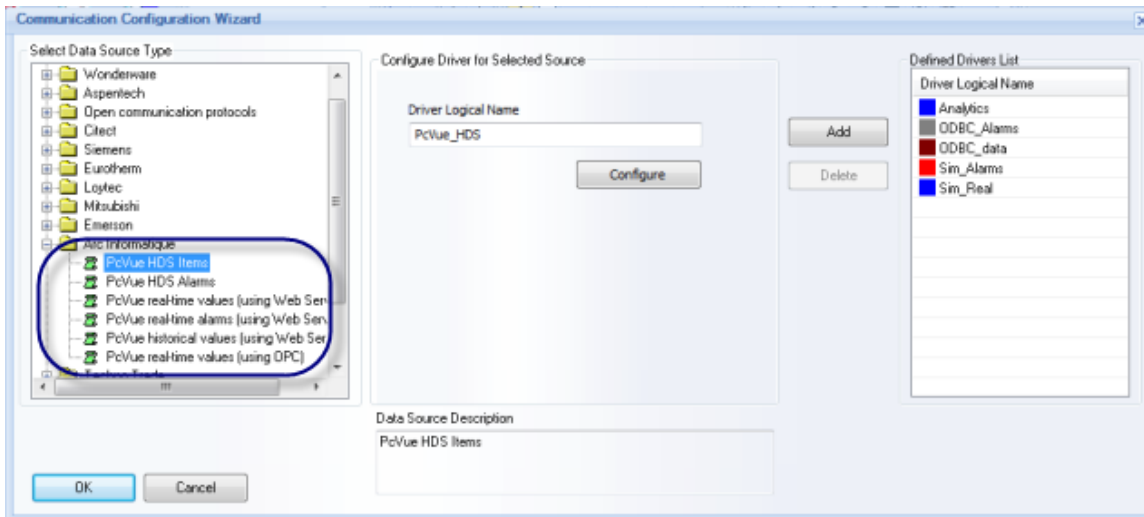

**NOTE:** In Dream Report version 3.43 the PcVue Web Services driver had one driver instance for real-time data, historical data and alarms configuration.

Now, in this new version of Dream Report, the PcVue Web Services driver has three driver instances and should be configured separately as **PcVue real-time values (using Web Services)**, **PcVue real-time alarms (using Web Services)**, and **PcVue historical values (using Web Services)**.

### PcVue HDS Items driver configuration

If **PcVue HDS Items** communication driver is selected, then, as soon as you click on "**Configure**" button, the following **PcVue HDS Historian access configuration** dialog window will be opened:

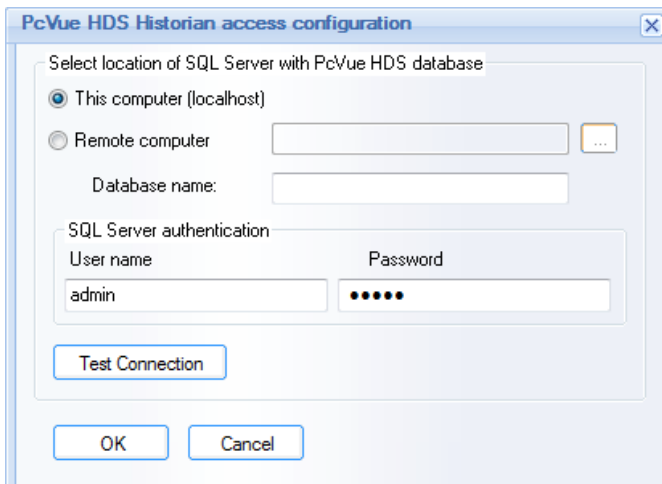



### Select Location of SQL with PcVue HDS Database

Select the radio-button option **This computer (localhost)** if your PcVue HDS database is located on the same computer with the Dream Report project.

Select the **Remote computer** option if your HDS database is located on a remote PC. If this option is selected, then in the edit box next to that option, you have to type in the name or address of a remote PC, where the HDS database is located. In order to browse for a PC, you can click on the "..." (browse) button and then select your desired PC in a browse dialog box.

### SQL Server Authentication

If the SQL server, which is running the PcVue HDS database, is configured with user authentication, then enter **user name** and **password** for the SQL Server into the corresponding edit boxes in the section **SQL Server authentication**. If your SQL Server is configured with Windows Authentication mode, leave the user name and password edit boxes empty.

The "**Test Connect**" button will try to establish communication to the selected PcVue HDS database based on SQL Server.

### PcVue HDS Alarms driver configuration

If **PcVue HDS Alarms** communication driver is selected, then, as soon as you click on "**Configure**" button, the following **PcVue HDS Alarms** driver configuration dialog window will be opened:

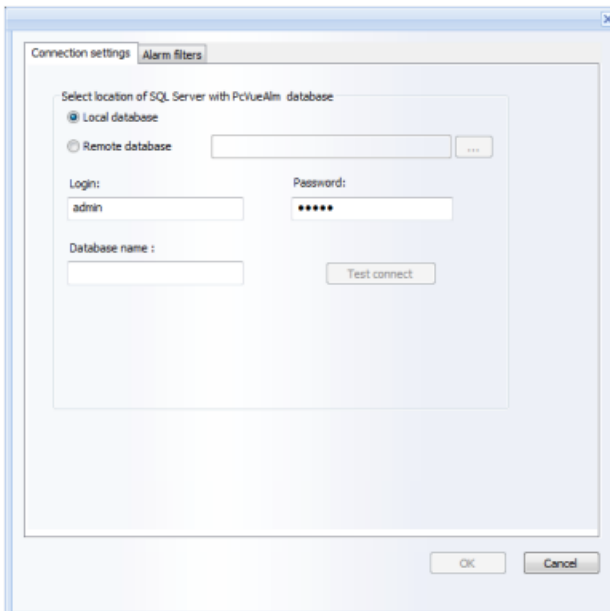

### Connection Settings

In this window user can define connection to the PcVue alarms database which needs to be accessed. The connection to the PcVueAlm database, based on SQL Server, can be configured either by using the SQL Server database locally ("**Local database**") or remotely ("**Remote database**").

If the SQL server, which is running the PcVueAlm database, is configured with user authentication, then enter **login** and **password** for the SQL Server into the corresponding edit boxes. If your SQL Server is configured with Windows Authentication mode, leave the user name and password edit boxes empty.



The "**Test Connect**" button will try to establish communication to the PcVueAlm database based on SQL Server.

## Alarm Filters

In this window user can define alarm filters and alarm filtering conditions (please see the picture below):

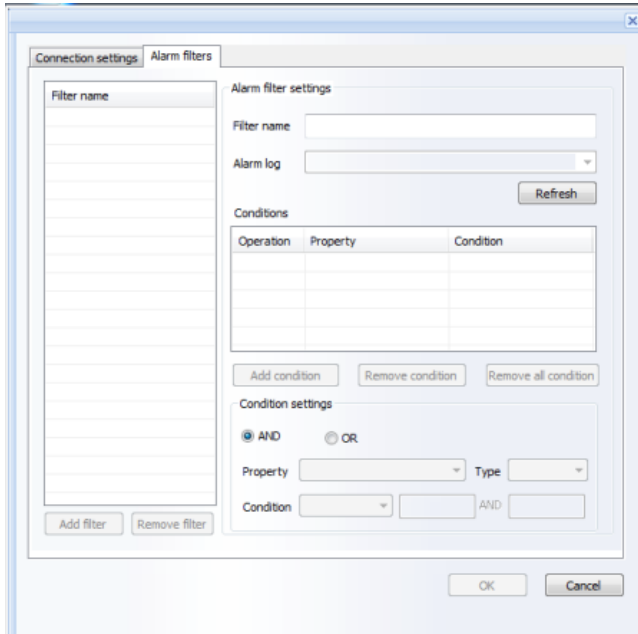

When the dialog window will be opened, it will connect to the Database and get the list of alarm logs. This list will be available in the "**Alarm log**" combo box for selection. In the "**Filter Name**" section user will have to define the name of the alarm filter (which should be unique).

## Condition Settings

The "**Property**" combo box will include the list of all properties which exist in the alarm log selected from the "**Alarm Log**" combo box.

**NOTE:** "**Property**" is a list of all columns from the **Alarm log** table without the timestamp (**Alarm log** is a table where the list of its columns includes the column "LogList". The name of the table is the name of the alarm log).

If user clicks **Refresh** button, the **Alarm log** combo box will be filled with the updated list of the tables.

If any alarm log has been selected in this combo box, then the "**Property**" combo box will be filled with the list of alarm properties of the selected alarm log.

If, before clicking the **Refresh** button, any alarm property has been selected, this selection will remain unchanged.

The "**Type**" combo box will include 3 options: **Numeric**, **Text** and **Boolean**.

If the **Numeric** type is selected, the **Condition** combo box will have the following options: = , > , >= , < , <=, **BETWEEN**.

If the **Text** type is selected, the **Condition** combo box will include the following options: **IS**, **IS NOT**, **LIKE**.

If the **Boolean** type is selected, the **Condition** combo box will include only one option: =.

After having defined the **Condition**, user will select **AND** or **OR** and click on **Add condition** button.



## Ocean Data Systems

When all conditions have been added, user will click *Add filter* button and the defined filter will be added to the list of filters (in the "**Filter Name**" table).

**NOTE:** If user selects filter from the list, the "**Conditions**" list will be filled with the filter settings.

If user selects condition from the list of conditions, all dialog controls will be filled according to the defined condition.

If user has defined the alarm filter without clicking on *Add filter* button and clicks *OK* button, the filter, which has not been added before, will be automatically added to the list of alarm filters.

### PcVue real-time values (using web services) driver configuration

If **PcVue real-time values (using web services)** communication driver is selected, then, as soon as you click on "*Configure*" button, the following PcVue driver configuration dialog window will be opened:

The dialog window is titled "PcVue real-time values (using web services) driver configuration". It contains the following fields and controls:

- Host address:
- Proxy address:
- Proxy Port:   HTTPS
- Username:
- Password:
- Update Rate:  in seconds
- Use alternative language:

Buttons: OK, Test Connector, Cancel

In this window, please, specify:

**Host address:** The IP address of PcVue server, to which the driver will be connected.

**Proxy address:** The address of a proxy server (if exists).

**Proxy port:** Proxy port.

**HT TPS:** This option defines if HTTP or secure HTTP (HT TPS) will be used for data transfer.

**Username:** Username for login to PcVue server.

**Password:** Password for PcVue server connection.

**Update Rate:** This option specifies time period for cyclical check of values and alarm updates. Though PcVue web services driver doesn't support unsolicited mode of data acquisition, all data updates are not received automatically, but are checked periodically with rate, defined in this option.

**Use alternative language** option defines whether primary or secondary language will be used for tag description and other text data properties.





When all configuration is properly set, a user can test connection with a server by clicking on [Test Connection](#) button in the bottom part of the driver configuration window.

### PcVue real-time alarms (using Web services) driver configuration

If **PcVue real-time alarms (using Web services)** communication driver is selected, then, as soon as you click on "[Configure](#)" button, the following PcVue driver configuration dialog window will be opened:

The dialog window contains the following fields and options:

- Host address: [Text input field]
- Proxy address: [Text input field]
- Proxy Port: [Text input field]  HTTPS
- Username: [Text input field]
- Password: [Text input field]
- Update Rate: [Text input field with value 10] in seconds
- Use alternative language:
- Use associated label:
- Use variable title:

Buttons at the bottom: OK, Test Connector, Cancel

In this window, please, specify:

**Host address:** The IP address of PcVue server, to which the driver will be connected.

**Proxy address:** The address of a proxy server (if exists).

**Proxy port:** Proxy port.

**HT TPS:** This option defines if HTTP or secure HTTP (HT TPS) will be used for data transfer.

**Username:** Username for login to PcVue server.

**Password:** Password for PcVue server connection.

**Update Rate:** This option specifies time period for cyclical check of values and alarm updates. Though PcVue web services driver doesn't support unsolicited mode of data acquisition, all data updates are not received automatically, but are checked periodically with rate, defined in this option.

**Use alternative language** option defines whether primary or secondary language will be used for tag description and other text data properties.

**Use variable title:** This option enables/disables the use of the name for the alarm updates.

When all configuration is properly set, a user can test connection with a server by clicking on [Test Connection](#) button in the bottom part of the driver configuration window.



### PcVue historical values (using Web services) driver configuration

If **PcVue historical values (using Web services)** communication driver is selected, then, as soon as you click on "**Configure**" button, the following PcVue driver configuration dialog window will be opened:

The dialog window is titled "PcVue historical values (using Web services) driver configuration". It features a standard Windows-style title bar with a close button (X) in the top right corner. The main area contains the following elements:

- Host address:** A text input field.
- Proxy address:** A text input field.
- Proxy Port:** A text input field.
- HTTPS:** A checkbox labeled "HTTPS".
- Username:** A text input field.
- Password:** A text input field.
- Use alternative language:** A checkbox.
- Buttons:** Three buttons at the bottom: "OK", "Test Connection", and "Cancel".

In this window, please, specify:

**Host address:** The IP address of PcVue server, to which the driver will be connected.

**Proxy address:** The address of a proxy server (if exists).

**Proxy port:** Proxy port.

**HT TPS:** This option defines if HTTP or secure HTTP (HT TPS) will be used for data transfer.

**Username:** Username for login to PcVue server.

**Password:** Password for PcVue server connection.

**Use alternative language** option defines whether primary or secondary language will be used for tag description and other text data properties.

When all configuration is properly set, a user can test connection with a server by clicking on **Test Connection** button in the bottom part of the driver configuration window.



### PcVue real-time values (using OPC) driver configuration

If **PcVue real-time values (using OPC)** driver is selected, then, as soon as you click on "[Configure](#)" button, the OPC driver configuration dialog box will be opened for the OPC driver configuration.

For details, please, see the [OPC Drivers](#) section.

### Handling of Communication errors and re-connections

PcVue driver has an embedded function to re-establish connection in case of communication error. While requesting data from the remote PcVue server, when an error is received, the driver will try first to re-initiate the communication session again and, if succeeded, will request the needed data again. Only after the failure again, it will return the communication error. Each next reading, the driver will retry to initiate the connection again.

#### NOTES:

- When selecting PcVue driver during Dream Report installation, it's recommended to select also installation of Visual C++ 2005 redistributable component in the Components section of the same window of Dream Report installation.
- If you need to configure the same driver more than once, then, after having configured it the first time, you'll just need to click in the "**Select Data Source Type**" field on any other driver and then go back to the driver that you need to configure.



## Control Maestro (legacy Wizcon) communication driver

**Wizcon drivers** of Dream Report enable you to connect to Wizcon SCADA using native connection and get access to the real-time data, real-time alarms and historical data and alarms of the Wizcon running project.

When you select any Wizcon driver from the **Wizcon** folder in the **Select Data Source Type** section of the **Communication Configuration Wizard** dialog window (see the picture below), there is no need to make any special configuration, unless you want to configure collection of real-time network alarms from Wizcon network.

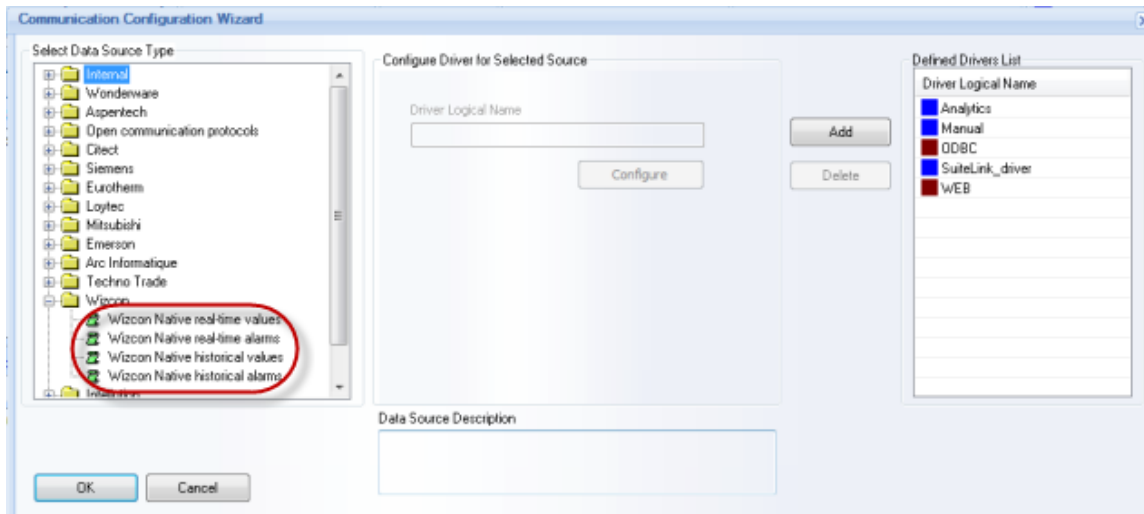

In case you wish to do that, click on **Configure** button and the dialog box with 2 vertical lists will be opened. The left list will contain a list of available Wizcon network stations. Select Wizcon stations, from which you wish to collect real-time alarms, and click on **Add** button. They will be added to the right list - the list of Wizcon stations from which alarms will be collected.

When you have finished station selection, click on **OK** button and the configuration will be completed. No other configuration is needed.

### Access real-time Wizcon tags

When browse of the list of Wizcon tags is opened and Wizcon network is enabled, you will see automatically a tree of Wizcon network stations and expanding a tree, you will get a list of Wizcon tags from the selected station.

If a network station has more than a thousand tags, it can take several seconds (up to a minute) to get a list of tags from the selected station. (**Note:** Receiving a list of 65000 tags from remote station can take up to 7-10 minutes, depending on the PC resources and network load).

### Access Wizcon history of tags and alarms

When you configure Dream Report object to get historical data from the external history server and select Wizcon driver, then, during report generation, Dream Report will automatically connect to Wizcon and access its history in a completely transparent way to a user.

History of remote tags or remote alarms can be accessed only if it is stored in the local Wizcon project (due to the limitation of Wizcon itself).



## LUA Script Historical Data Access driver

The **LUA Script Historical Data Access (HDA) Item** driver is an internal driver which can generate a simple or complex set of calculated data. This driver can be used for simulation, to build “ideal profiles” for comparison or other tasks, which require generating specific datasets with certain rules. A user can write any script which can generate and manipulate data using simple or complex rules, using all the power of the “open” LUA scripting language.

To configure the **LUA Script HDA Item** driver, first select it from the list of **Open Communication Protocols** drivers in the Dream Report **Communication Configuration Wizard**:

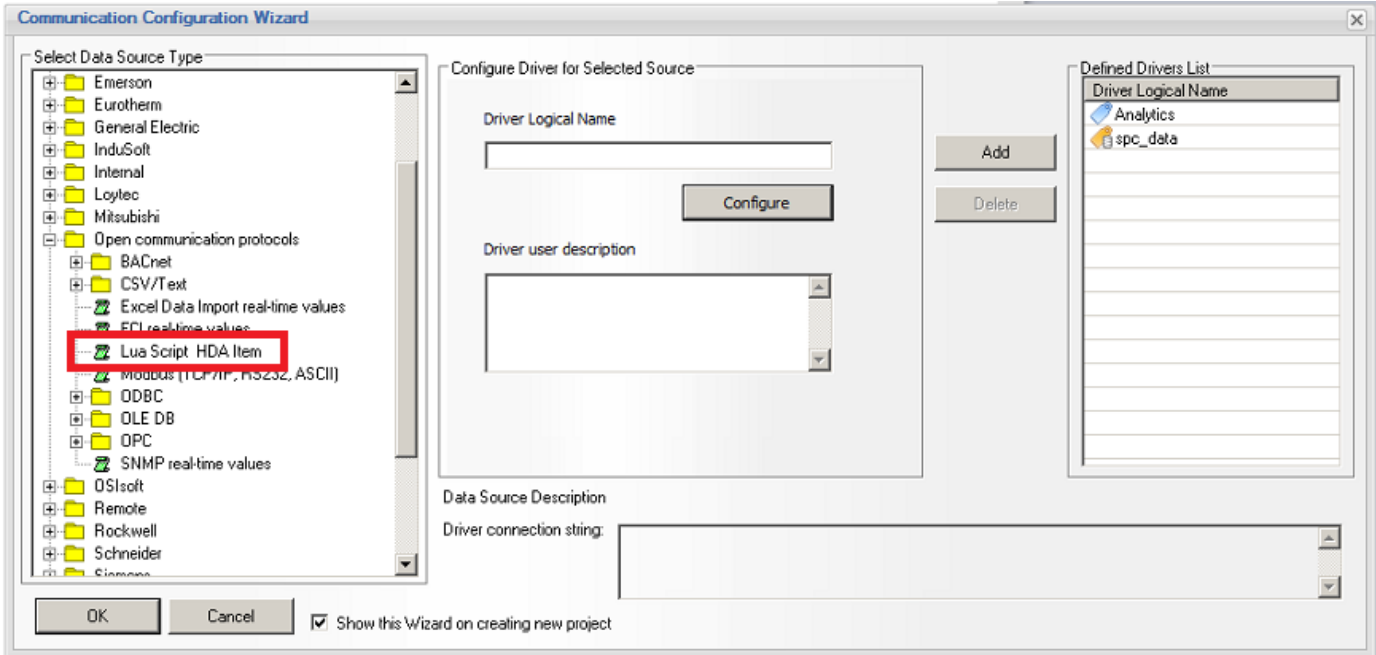

Enter a unique **Driver Logical Name** for the instance of the **LUA Script driver**, and then click the “**Configure**” button. When the following dialog box opens, enter the path and name to a valid LUA script that extracts/generate sample data:

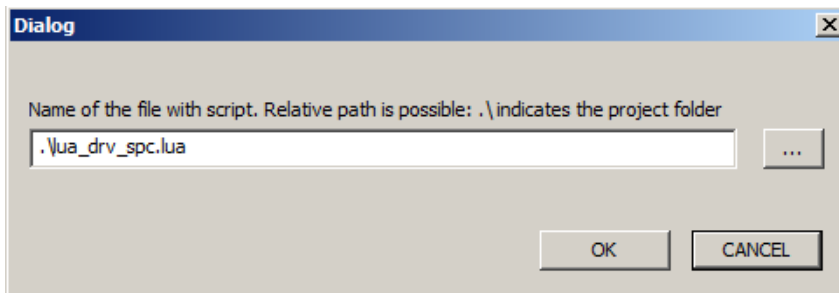

Note that you can include the explicit file path with the file name, or, if the LUA script is located in the current project directory, simply preface the file name with “\.”

The following is an example of a LUA script that extracts sets of non-timestamped data from a set of text files, adds timestamps to the data when called, making the data usable in Dream Report reports objects:



## Ocean Data Systems

```
-- Always existing object:
--OdsDrvEnv = {}
--OdsDrvEnv.PathProject = ''

rulesTestItems = {}
rulesTestItems["SPC/Test_01"] = { path="SPC/Test_01", desc="Test set for SPC #1", values = {},
filename = OdsDrvEnv.PathProject .. "\\SPC_DATA\\TEST_1.txt"}
rulesTestItems["SPC/Test_02"] = { path="SPC/Test_02", desc="Test set for SPC #2", values = {},
filename = OdsDrvEnv.PathProject .. "\\SPC_DATA\\TEST_2.txt"}
rulesTestItems["SPC/Test_03"] = { path="SPC/Test_03", desc="Test set for SPC #3", values = {},
filename = OdsDrvEnv.PathProject .. "\\SPC_DATA\\TEST_3.txt"}
rulesTestItems["SPC/Test_04"] = { path="SPC/Test_04", desc="Test set for SPC #4", values = {},
filename = OdsDrvEnv.PathProject .. "\\SPC_DATA\\TEST_4.txt"}
rulesTestItems["SPC/Test_05"] = { path="SPC/Test_05", desc="Test set for SPC #5", values = {},
filename = OdsDrvEnv.PathProject .. "\\SPC_DATA\\TEST_5.txt"}
rulesTestItems["SPC/Test_06"] = { path="SPC/Test_06", desc="Test set for SPC #6", values = {},
filename = OdsDrvEnv.PathProject .. "\\SPC_DATA\\TEST_6.txt"}
rulesTestItems["SPC/Test_07"] = { path="SPC/Test_07", desc="Test set for SPC #7", values = {},
filename = OdsDrvEnv.PathProject .. "\\SPC_DATA\\TEST_7.txt"}
rulesTestItems["SPC/Test_08"] = { path="SPC/Test_08", desc="Test set for SPC #8", values = {},
filename = OdsDrvEnv.PathProject .. "\\SPC_DATA\\TEST_8.txt"}
rulesTestItems["SPC/Test_09"] = { path="SPC/Test_09", desc="Test set for SPC #9", values = {},
filename = OdsDrvEnv.PathProject .. "\\SPC_DATA\\TEST_9.txt"}
rulesTestItems["SPC/Test_10"] = { path="SPC/Test_10", desc="Test set for SPC #10", values = {},
filename = OdsDrvEnv.PathProject .. "\\SPC_DATA\\TEST_10.txt"}
rulesTestItems["SPC/Test_11"] = { path="SPC/Test_11", desc="Test set for SPC #11", values = {},
filename = OdsDrvEnv.PathProject .. "\\SPC_DATA\\TEST_11.txt " }
rulesTestItems["SPC/Test_12"] = { path="SPC/Test_12", desc="Test set for SPC #12", values = {},
filename = OdsDrvEnv.PathProject .. "\\SPC_DATA\\TEST_12.txt " }
rulesTestItems["SPC/Test_13"] = { path="SPC/Test_13", desc="Test set for SPC #13", values = {},
filename = OdsDrvEnv.PathProject .. "\\SPC_DATA\\TEST_13.txt"}

function BrowseItems()
    local res={}
    local i=1
    for key,value in pairs(rulesTestItems) do
        res[i]=value
        i=i+1
    end
    return res
end

function ReadData(itemAddress, from, to)
    local tvqlist = {} -- new array
    local starttime = os.date("*t", from/1000);
    local I = 1
    local item = rulesTestItems[itemAddress]

    lines = {}
    for line in io.lines(item.filename) do
        item.values[#(item.values) + 1] = line
    end

    for key, value in pairs(item.values) do
        tvqlist[i] = {timestamp = os.time{ year = starttime.year, month = starttime.month,
day = starttime.day, hour = starttime.hour, min = starttime.min+i} , value = tonumber(value),
quality = 0}
        i = i + 1
    end
    return tvqlist
end

function ReadDataWithPrevPoint(itemAddress, from, to)
    return ReadData(itemAddress, from, to)
end
```



### Using LUA Script HDA Item Driver Tags in a Report

When configuring a report object such as [Single Data Object](#) or a [Table](#), [LUA Script HDA Item](#) driver tags are referenced as an “[External History Server](#)” and tags are selected in the same way as with any other [Dream Report Data Source](#):

**Single Data Object Definition**

Object Name: SampleSet1

Object Description: Test set for SPC #1

Select Data Item

Dream Report History  External History Server

Data Source: spc\_data

Item Name: SPC/Test\_01

**Select Data Item**

Select Data Source: spc\_data

Display tag browse list options:

All items  Favorite item list

Item Filter: Description Filter:

Path: \SPC

Item Name	Description
..	..
Test_01	Test set for SPC #1
Test_02	Test set for SPC #2
Test_03	Test set for SPC #3
Test_04	Test set for SPC #4



## Kit of Simulation drivers

**Simulation Driver** enables to design report templates without connection to the real data servers. Users can define different virtual data sources and variables according to their needs. This allows for testing of Dream Report projects without connecting to “real” data sources.

The **Simulation Driver** set includes **Simulation Data Driver** (Simulation Driver real-time/historical values) and **Simulation Alarm Driver** (Simulation Driver real-time/historical alarms).

To configure **Simulation Driver**, first, open the Communication Configuration Wizard dialog window:

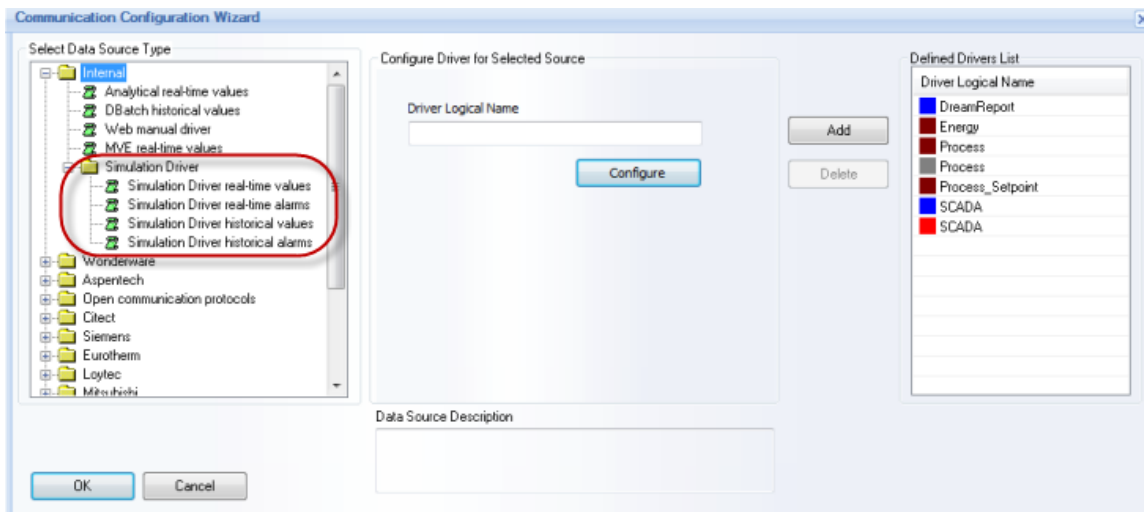

Select **Simulation Data Driver** (Simulation Driver real-time/historical values) or **Simulation Alarm Driver** (Simulation Driver real-time/historical alarms) from the **Simulation Driver** subfolder of the **Internal** folder in the **Select data source type** section.

**NOTE:** In Dream Report version 3.43 the Simulation driver had one driver instance for real-time data, historical data and alarms configuration.

Now, in this new version of Dream Report, the Simulation driver has four driver instances and should be configured separately as **Simulation Driver real-time values**, **Simulation Driver real-time alarms**, **Simulation Driver historical values** or **Simulation Driver historical alarms**.

### Simulation Data Driver Configuration

All configuration of the **Simulation Data Driver** is stored in the text file **dummy.cfg**, which is located in the System folder of Dream Report installation.

The configuration file of the **Simulation Data Driver** has the following format:

[DataSource\_A]

Dig1,int,rand,200,0,2

Tag\_50\_1,float,rand,500,0,35





Tag100\_1,int,rand,500,30,95

[DataSource\_B]

Dig1,int,rand,200,0,2

Tag\_50\_1,float,rand,500,0,35

Tag100\_1,int,rand,500,30,95

[SOURCE NAME] is a definition of a virtual data server. One configuration file can contain multiple source definitions. They will be just listed one below the other, like shown on example above.

List of items is added one below another right below the source name. Each source can have a list of its own items.

Item definition has the following format:

<Item name>,<format>,<method>,<change rate>,<minimum value>,<max value>

**Example:**

Dig1,int,rand,200,0,2

<format> can be **int, float, bool, string**

<method> can be **rand, const**

When clicking on **Configure** button, the configuration dialog, i.e. the dialog with virtual source selection will be prompted. This list will be compiled from a list of sources, mentioned in the driver configuration file.

(In the example, mentioned above, the list of sources will have two sources: **DataSource\_A** and **DataSource\_B**).

Click on **Add** button and add this driver to your project.

## Simulation Alarm Driver Configuration

The configuration file of the **Simulation Alarm Driver** has the name **dummyalarm.cfg**, and it has the following format:

[Alarms\_A]

"FireDetection\_Adminsitration ", 10, 11

"FireDetection\_Gymnasium ", 10, 16

"Intrusion\_East\_Gate ", 20, 15

"Pool\_water\_temp\_22°C ", 10, 19

"Outside\_temp\_17°C ", 60, 19



[Alarms\_B]

"Pipeline1\_Speed\_Low ", 2, 10

"Valve1\_Open ", 10, 11

"Valve2\_Open ", 11, 12

"Valve2\_Closed ", 11, 13

"Valve3\_Closed ", 12, 13

"Lack\_of\_pressure\_Oilwell1 ", 1, 10

"Lack\_of\_pressure\_Oilwell3 ", 1, 12

[SOURCE NAME] is a definition of a virtual alarm server. One configuration file can contain multiple source definitions. They will be just listed one below the other, like shown on example above.

List of alarm definitions is added one below another right below source name. Each source can have a list of its own items.

Alarm definition is recorded in a format:

"<alarm text>",<priority>, <generating period in sec.>

When clicking on **Configure** button, the configuration dialog, i.e. the dialog with virtual source selection will be prompted. This list will be compiled from a list of sources, mentioned in the driver configuration file.

(In the example, mentioned above, the list of sources will have two sources: **Alarms\_ A** and **Alarms\_ B**).

Click on **Add** button and add this driver to your project.

**NOTE:** If you need to configure the same driver more than once, then, after having configured it the first time, you'll just need to click in the "**Select Data Source Type**" field on any other driver and then go back to the driver that you need to configure.



**Ocean Data Systems**



## Communication driver development toolkit

**Dream Report** enables users to develop custom drivers for connectivity with any custom equipment for real-time data acquisition, real-time alarm data acquisition and direct history access.

Custom driver development considers development of 4 dynamic linked libraries (DLL).

Each DLL will contain implementation of one or more corresponding C++ classes.

For real-time data access driver 2 libraries have to be created:

**Item Browser** - to get list of server nodes and get list of items from the selected node. If data access driver has its own configuration dialog, it must be implemented in the data browser.

**Data Client** - library, which will connect to a data source and will get value updates or read values when needed.

For real-time alarm access, alarm client library has to be created.

For external history access you will have to implement item browser and history access client.

***In order to receive more detailed information on a toolkit, get instructions for use and other toolkit-related information, please, apply to your local Dream Report distributor. Special documentation on this issue is available.***



# Remote Connector

## Remote Connector Server

The Dream Report **Remote Connectivity Server** (RCS) facilitates the communication between Dream Report communication drivers running on remote PC's with **Remote Drivers** configured on the Dream Report runtime engine. Since several communication drivers do not natively allow for remote connections to real-time values or historical archives, the **Remote Connector**, when installed and configured on the remote node, will allow a Dream Report node to generate reports with data from those nodes. The **Remote Connector** also allows for reporting of data sources from remote locations, using web services to establish the connection.

### Remote Connector Server Configuration

The Dream Report Remote Connector Server must be installed (a separate **install** from the main Dream Report software) on each remote PC/server where Dream Report communication drivers are to be configured. The **RCS** does not require a separate license - the license is applied on the client side (Dream Report).

The **Remote Connector Configurator** (on the remote node from Dream Report) is launched from **Start > All Programs > ODS > Dream Report > Remote Connector Configurator**.

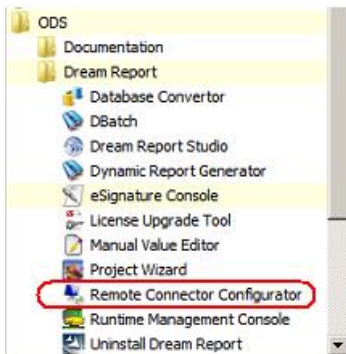

The **Dream Report Remote Connectivity Server** utility will open, and should be configured as follows:

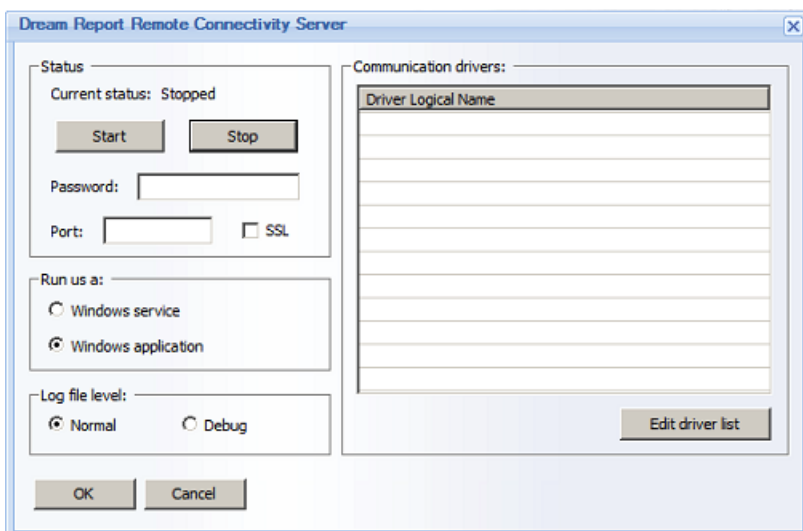



## Ocean Data Systems

1. **Start** and **Stop** Buttons: These buttons will Start and Stop the Remote Connector runtime engine. The "Current status" label will indicate the current status of the engine. The engine status will be retained in the event of a PC is restart or if a Windows session is restarted - the engine status will be the same as the "last known status."
2. **Password**: The user can set connectivity password, which will be used as a password for **Remote Drivers** to connect to this RCS engine. If a **Password** is defined, the Remote Connectivity Server will allow connection only if a matching password is supplied by the **Remote driver**. If the password is changed, then when closing the Configuration window on "OK", the engine will be reloaded. If exiting on Cancel, nothing will happen and old password will remain valid.
3. **Port** and **SSL**: All communications between Remote Drivers and Remote Servers will be done based on **Web Services** communication. The Default port will be 80. If the port is occupied, then 8080 can be used as alternative. Check **SSL** if Secure Sockets Layer protocol security is required. The matching setting will need to be configured on the **Remote Driver(s)**.
4. **Run as a** (Running Mode): The RCS can run as a Windows **Service** or as an **Application**. The default mode is **Application**. If the mode is changed, then when exiting the window on "OK", the engine will be reloaded in the new selected mode. If exiting on "Cancel", no changes will be made.
5. **Communication Drivers**: Click the "Edit drivers list" to open the standard Dream Report **Driver Configuration** window. The user can then configure one or more communication drivers to local data sources, as described in the **Communication Drivers** section:

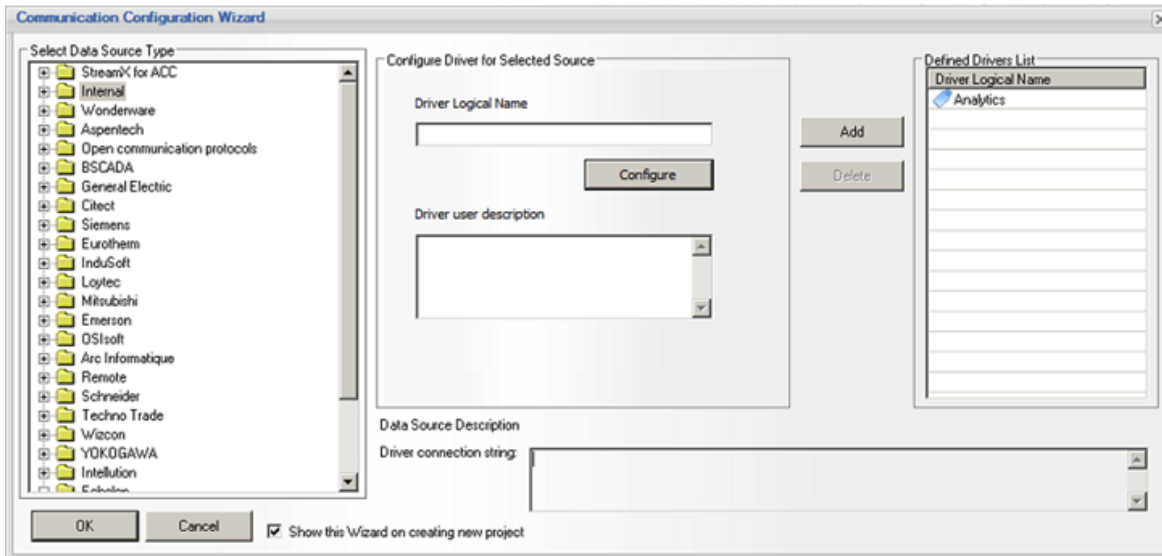

Once the driver(s) are configured and added, click "OK", and the configured drivers will appear in the Driver Logical Name list in the Dream Report **Remote Connectivity Server** window.

**NOTE:** the Remote Connectivity Server only supports Real-time values and HDA (Historical Data Access) History values.

6. **Log file level**: The Remote Connectivity Server will use an activity log file. Log file will be created in a standard installation folder. The format of the **Log File** will be a standard CSV file, named *rcs\_log.csv*. The log file can be configured to log in "Normal" mode (start/stop/change of running mode, change of a driver list, and standard log messages from the Dream Report drivers); or a "Debug" mode, which will log all activity with a much higher level of detail.

### Remote Connectivity Server Operation

When the Remote Connectivity Server runtime is started, RCS will load configured drivers and communicate with **remote connectivity drivers** (RCD). RCDs will open a connection session with RCS, and all incoming function calls, received from Dream Report Runtime driver will transmit to its server. Server will receive the command, send it to the



appropriate driver and will send the response back to the remote driver (RCD). All communication will be executed using SSL and Web Services. When transmitting large arrays of data for historical values, RCS will pack the data using a compression utility and transmit the archived buffer. At the Dream Report side, the **Remote Driver** will be able to detect that received dataset is archived and will unpack it before processing.

## Remote Driver Connector

The Dream Report **Remote Driver Connectors** allow for Dream Report communication drivers to run on remote PC's and establish remote web-enabled communication between communication drivers and Dream Report runtime engine.

The following **Remote Connector** driver types are supported:

- **Remote Driver real-time values**
- **Remote Driver historical values**

## Remote Driver Configuration

The **Remote Driver** configuration is performed on the **client side** (Dream Report Studio). To configure a **Remote Driver**, open the **Communication Configuration Wizard** dialog window, and expand the **Remote** folder:

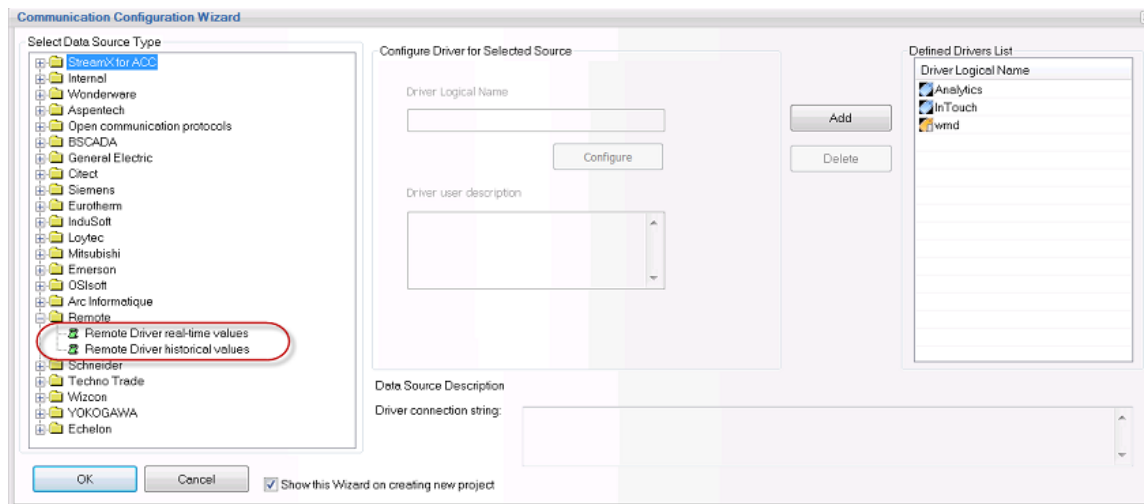

Select one of the 2 types of **Remote** drivers (**Remote Driver real-time values** or **Remote Driver historical values**). Enter a **Driver Logical Name**, and the click on **"Configure"** button to open the specific driver's configuration window.

## Remote Driver Real-time values

The following configuration window will open for **Remote Driver real-time values**:



**Connect to host** (running the remote Dream Report communication driver), by entering the **Host Address** (IP), **Port** number, check **SSL** option if required), and the **Password** required to authenticate with the remote host.

Click the **"Test Connection"** button, and if successful, the Remote driver configuration will automatically receive a list of all available drivers of that type (real-time) configured on the remote Host. In the **Communication settings** section: **Select available data source at host** from the list for the required data source. Finally, enter an **Update rate** (in msec) at which the **Remote Driver** will poll for real-time data on the Host.

### Remote Driver Historical values

The following configuration window will open for **Remote Driver Historical values**, and will allow for retrieval from historical data archives on a remote data source:

**Connect to host** (running the remote Dream Report communication driver), by entering the **Host Address** (IP), **Port** number, check **SSL** option if required), and the **Password** required to authenticate with the remote host.

Click the **"Test Connection"** button, and if successful, the Remote driver configuration will automatically receive a list of all available drivers of that type (historical) configured on the remote Host. In the **Communication settings** section: **Select available data source at host** from the list for the required data source. Finally, configure the driver to **Archive dataset if more than** "x" number of values. This setting allows the Remote connector to create a





"compression" packages of "x" number of data points (values) from the historical archive at the Host side, and send that compressed package of data to the Remote Driver on Dream Report, where it is uncompressed and reported on.

## Web Portal

### Dream Report Web Portal

#### General Overview

**Dream Report** has its own proprietary web portal, which enables users to browse a list of reports from the currently running project, to visualize any existing report from the entire project, to generate any report on user demand in real-time, to enter manual values (data) into the Dream Report database or use them for calculations or filtering for regular reporting.

**Dream Report web portal** uses **ASP.net** web technology and has communication with the runtime manager, using Microsoft .NET Framework version 3.5 or higher.

#### Manual Data Entry (WEB Reports)

**Dream Report web portal** also provides a set of Dream Report functions (**Manual Data Entry Functions**), which enable users to enter manual values in a standard Dream Report reporting template. Those manual values can be later used to enter manual data into the Dream Report database or use it for calculations or filtering for regular reporting.

For details on how to configure Web portal manual data entry functions, please go to the [Manual Data Entry](#) section of this manual.

#### Web Portal Activation

To activate the web portal, Dream Report has to be installed on a PC with a web server installed. Then, during installation, the Dream Report installer will install all necessary files to use the web functionality. Otherwise, if the web server is installed later, in order to be able to use the web functionality, Dream Report has to be uninstalled and re-installed again. The ASP engine will be installed by Dream Report installer automatically as well.

**NOTE:** To have access to a project in the Dream Report Web Portal, each time a new project is started, user will have to configure IIS (Internet Information Services) for that project manually, by clicking on the **Configure IIS** button. If the IIS configuration process has succeeded, user will get the message "**IIS configuration has been successfully completed**". Otherwise, he will have to check the reason for the IIS configuration failure.



## Ocean Data Systems

If Internet Information Services (IIS) is not installed in user's operating system, he will get the message box **"Can't configure IIS. Web portal is not enabled"**. **Then, IIS will have to be installed, and then, configured (for details, please, see Installation Tips).**

IIS can be configured directly either in the **Web Configuration** dialog box of the **Project Settings** section, or in the **Runtime Management Console** dialog window.

**NOTE:** For IIS versions 7, 7.5 and 8, if user clicks on "**Configure IIS**" button, the Application Pool "OdsDrAppPool" will be automatically created. Thus, for 64-Bit OS this will allow automatic configuration of Dream Report Web portal.

To load the web portal on the local computer, open Internet Explorer and type: <http://localhost/drweb> (or <http://<IP address>/drweb>).

This will automatically open the welcome page of the Dream Report web portal. **DRWeb** is the default alias name for the Dream Report web portal, which is automatically created in web server. If you want to change that alias, you can setup a custom alias name in the **Web Configuration** dialog box in the **Project Settings**.

If the current running Dream Report project is password protected, the user will be prompted to enter valid login information. Only users authorized to access the web site under **User Management** in the **Project Settings** will be allowed to access the portal. If **User Management** is not enabled in the Dream Report project, the web portal will not ask for user authorization. Only reports allowed for the current user will be displayed.

If several Dream Report stations are used, then on the welcome page, the user will be able to choose which station he wants to access.

### Web Portal in Dream Report Version Upgrade

In Dream Report versions prior to 4.64, in order to successfully upgrade or change the configuration of the Web Portal, when you click "**Configure IIS**" button, you will have to agree to save the backup of your Web Portal configuration in the **IIS configurator** window, which will pop up, user will have to click "**Yes**" (please see the picture below):

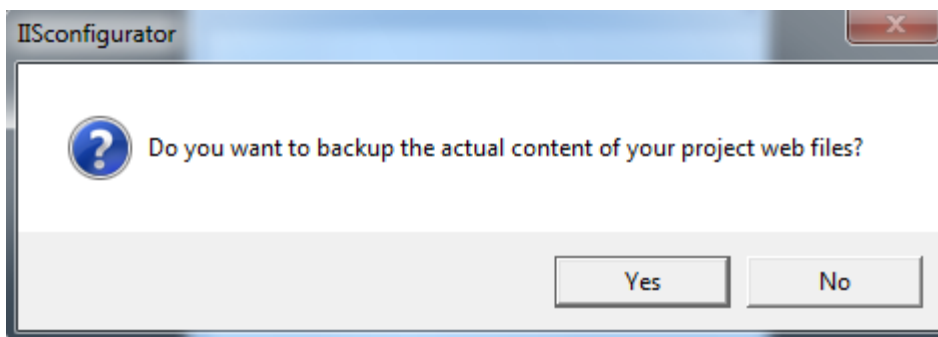

### Web Portal Report Generation

Web portal enables you to browse the list of reports of the currently running project, browse any generated report file for any report of the entire running project and to generate a new report.



In order to generate a new report, your project folders must have full rights permission for **Everyone**. Dream Report sets this property automatically for all newly created reports. However, this may need to be set manually in report projects, which were copied from another computer, from CD-ROM etc.

You can create reports either with the original time definition or with dynamic generation. These two ways to generate reports are available either from the main page for each report or from the detail page of each report.

1. From the main report page, you can either click on the standard generation ("**New Report**") button or the dynamic report generation ("**New Dynamic Report**") button.
2. From the detail page, you can also click on the standard generation ("**New Report**") button or the dynamic report generation ("**New Dynamic Report**") button.

**NOTE:** If report is generated in Web Portal and the name of the newly generated report, for some reason, has remained the same (e.g. **<Report\_name>\_<Day>\_<Month>**), then, if you want your report to be updated in Web browser, you should select the option to update webpage after every visit ("**Every time I visit the webpage**") in the **Internet Options Settings** (please see the picture below):

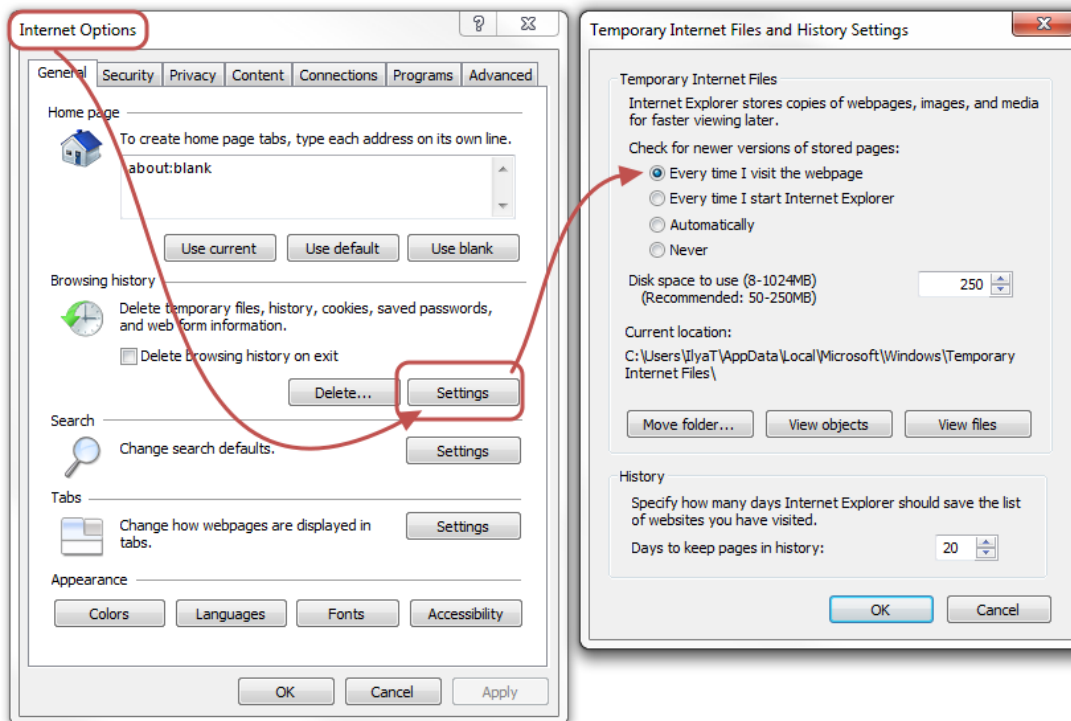

## Web Portal toolbar

There are some control buttons on the toolbar of the **Welcome (main) page** and the **Detail page**.

The **Welcome page** has the **Refresh** button to update the reports information (eg., the number of reports and the last generation time):



The **Detail Page** toolbar has the **Refresh** button (to update the reports information), and the **Back** button (to bring user back to the main page):



The **Logout** button (the cross) will be displayed only if user management in the project is activated:



**NOTE:** When using the web portal on Windows Vista or Windows 2008 Server, some minor manual configuration is required. Please, contact technical support for additional configuration instructions.

Before installing Dream Report with web portal on Windows Vista or Windows 7 - please, read this section: Manual IIS configuration on Windows Vista or Windows 7

## Web Portal Welcome Page

**Welcome Page** of the Dream Report Web Portal enables users to browse a list of reports from the currently running project, to visualize any existing report from the entire project, and also to generate any report on user demand in real-time.

When opening **Dream Report web portal**, the actual web portal with access to history of all report PDF/Excel files will be opened. User will see the tree with reports, PDF/Excel/Web report format icons and report generation buttons.

If no report in the project has **Web** option enabled, then the “**Web reports**” section will not be displayed, as no reports have been configured for the web format (for details on how to enable **Web** option, please see the **Report Output Format** section of this manual).

## Web reports format



## Ocean Data Systems

If the report has Web format defined, the "Report Formats" column will contain WEB icon. Web reports contain web pages with reports, which have Web option enabled. No history of these reports is displayed.

When user selects a report, the report view frame will display "*Please, wait, while retrieving report information...*" and, meanwhile, it will generate the report, calculate all objects, located on that report page, and then display it in the report view frame. Then, user can work with this report according to its design.

For details, please go to the [Manual Data Entry](#) section of this manual.

### PDF/Excel format

If the report has **Excel** report format defined, the "**Report Formats**" column will contain **PDF** and **Excel** icons.

If the report has only **PDF** format, only the **PDF** icon will be displayed.

**NOTE:** If you have Microsoft XP operating system installed on your PC, then, in order to define correct path to the place where generated PDF files will be stored, please go to the [Web Configuration](#) section of [Project Settings](#) and click *OK*.

If the report has only **Excel** format, only the **Excel** icon will be displayed.

**NOTE:** In order to have direct access to PDF and Excel files in Web Portal users can create shortcuts:  
<http://localhost/filereport.aspx?Repld=3&FormatType=0&login=admin&pass=admin>

WHERE:

- **Repld** is an ID of the report from the Web Portal Welcome Page starting from 0;
- **FormatType: FormatType=0** - for PDF format, and **FormatType=1** - for Excel format;
- **login** - user name
- **pass** - password as text

### Welcome Page Layout

[Dream Report Web Portal Welcome Page](#) has the following layout:



Dream Report Portal  
2/2/2012  
Powered By ODS Technology  
Language English

Welcome to Ocean Data Systems Reporting Portal

Report name	Report Formats	Description	Generated on	New Report
1 - Data Extraction	(2)		7/15/2011 10:04:07 AM	
2 - Data Tables	(3)		7/15/2011 10:03:48 AM	
3 - Alarm Tables	(1)		8/26/2010 11:57:58 AM	
4 - SQL Tables	(3)		7/15/2011 10:18:21 AM	
5 - Step Tables	(3)		7/15/2011 10:18:35 AM	
6 - Pie Graphs	(1)		8/26/2010 11:57:56 AM	
7 - Bar Graphs	(1)		8/26/2010 11:57:58 AM	
8 - Charts	(1)		8/26/2010 11:57:58 AM	
9 - Automatic Statistical Table	(3)		8/26/2010 11:57:58 AM	
Energy Efficiency Report	(1)		7/15/2011 10:01:17 AM	

Web Portal Welcome Page displays the following data:

- **Report name** - name of the report as defined in the [Report Settings](#) in the Designer Studio;
- **Report Formats** - report format types (PDF/Excel/Web) as defined in the [Report Settings](#) in the Designer Studio;
- **Description** - description of the report if it is defined in the [Report Settings](#) in the Designer Studio;
- **Generated on** - date and time of the last report generation;
- **New Report** - standard generation ("**New Report**") and dynamic report generation ("**New Dynamic Report**") buttons.

### Report Instances

If a report has virtual instances defined, it will be displayed as a tree. When a user expands this tree, the list of instances of that report will be displayed with the information for each instance (please see the pic. below):

Current Level: /

Search for Report

Report name	Report Formats	Description	Generated on	New Report
Energy_Production			2/1/2012 12:08:14 PM	
Energy Report			No Report yet	
Water Report	(1)		12/16/2011 12:00:00 PM	
Water Treatment			No Report yet	



Standard generation ("**New Report**") and dynamic report generation ("**New Dynamic Report**") buttons will be available for each report/report instance. By clicking on the button needed, the corresponding report/report instance will be generated.

If a user clicks on **New Dynamic Report** button, the following Dream Report Portal window will be opened:

The screenshot shows the Dream Report Portal interface. At the top left, it says "Dream Report Portal" and "3/1/2012". At the top right, it says "Powered By ODS Technology" and "Language: English". The main content area displays "Report Selected: Energy\_Production" and "INSTANCE: Energy Report". Below this, there is a form titled "Please select the type of generation" with a dropdown menu set to "Absolute". The form has two columns: "Start of period" and "End of period". Each column has a "Date (Day/Month/Year)" field with a "Select" button and a "Time (hh:mm:ss)" field with a time selector. The "Start of period" date is "21/02/2012" and the "End of period" date is "15/03/2012". Both time fields are set to "12 : 00 : 00". There is a "UTC" checkbox which is checked. At the bottom of the form is a "Generate" button. The footer of the window says "Copyright, All rights reserved".

User will be able to define one of the 5 options for dynamic report generation: **Original time period**, **Batch-based**, **Absolute**, **Relative** and **Fixed**.

For details on how to configure these options, please, see Dynamic Report Generator section.

## Web Portal Detail Page

**Detail Page** of the Dream Report web portal enables users to browse a list of the instances of the selected report from the currently running project, to visualize in details any existing report/its instances from the entire project, and also to generate any report/its instances on user demand in real-time.

**Detail Page** contains all the information a user may need about all the reports generated. It has the following layout:

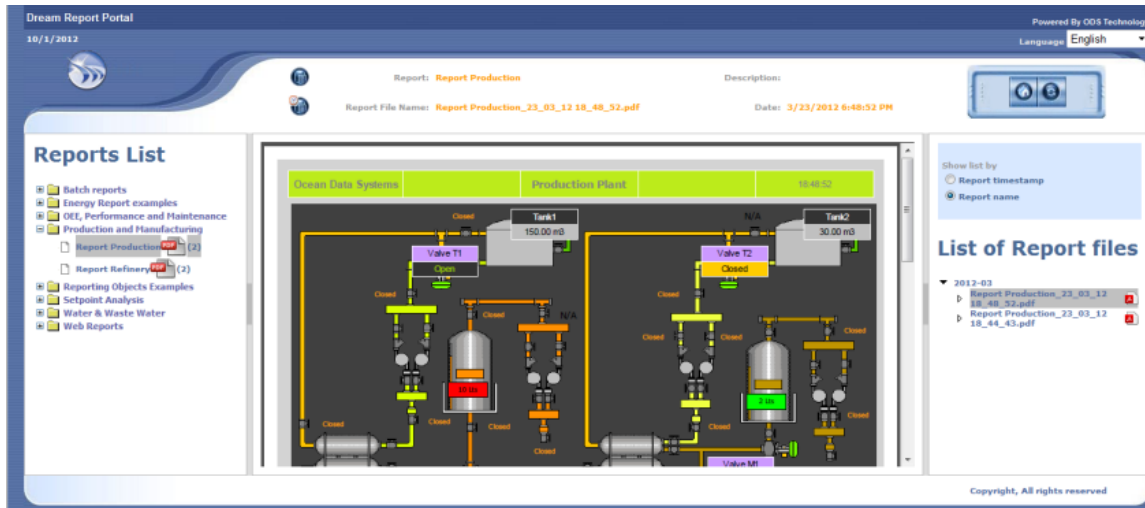

**Web Portal Detail Page** displays the following data:

- **Reports List** - the left part of the detail page presents all reports with their instances and report format types defined in the project. User can view any generated report without any need to go back to the Welcome Page;
- **Report Information** - the top central part of the detail page presents the general report information: the selected report/ report instance name, the generated report filename mask, the description of the report (if defined) and the timestamp of report generation;
- **New Static/Dynamic Report Generation** - in the top central part of the detail page the standard generation ("*New Report*") and dynamic report generation ("*New Dynamic Report*") buttons are available for each report/report instance. By clicking on the button needed, the corresponding report/report instance will be generated (For details on how to configure dynamic report generation, please, see [Dynamic Report Generator](#) section).
- **List of Report files** - the right part of the detail page presents the list of all generated report files arranged weekly/monthly/yearly in separate folders. The list of report files can be displayed either as a list with report timestamps ("**Show list by: Report timestamp**") or as a list with report names ("**Show list by: Report name**").

Click **Refresh** button to update the reports information.

Click **Back** button to go back to the [Web Portal Welcome Page](#).

### Search Object by UUID

If there is any problem with an object, which is used in WEB reports in Dream Report Web portal, then, in order to find this object, user should search for this object in the DR studio/report by this object's UUID (Universal Unique Identifier). This UUID is located in the "**dmlc.log**" log file, which is stored in the folder with the unique name, being generated by Dream Report at the moment of WEB Report generation

To search an object in the report by its UUID, first right-click on the report page and select "Search Object by UUID" from the popup menu:



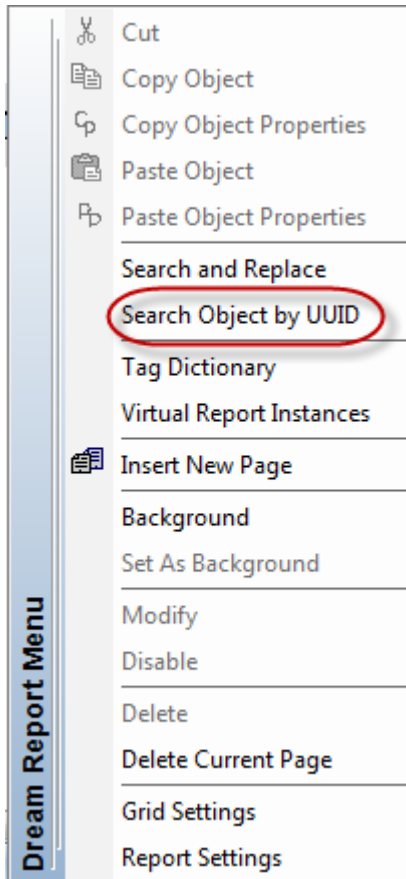

Then, in the "**Search Object by UUID Dialog**" window (see the picture below), please enter the UUID (Universal Unique Identifier) of the object which you need to find:

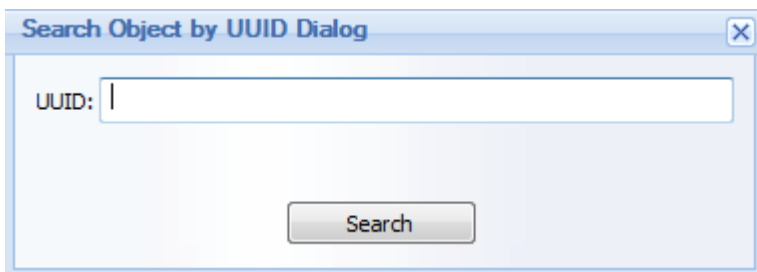



## Web Manual Driver

Dream Report includes **Web Manual** driver, which enables connectivity to any external databases, which support ODBC connectivity and have supported data structure.

To configure **Web Manual driver**, first, open the **Internal** folder of the **Communication Configuration Wizard** dialog window:

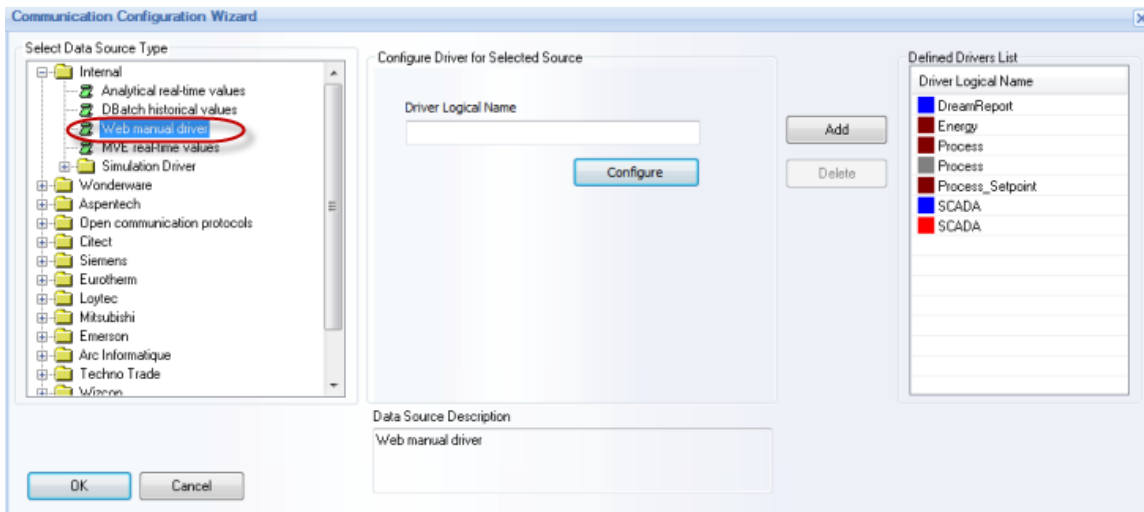

Click on **Configure** button and the following dialog window will be opened:

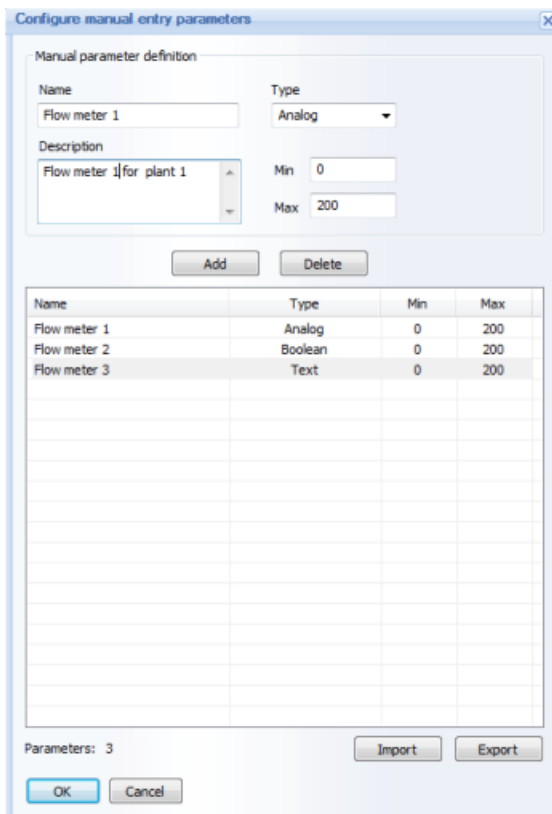



## Ocean Data Systems

Define tags for the selected data source. Every manual tag must have its **Name** and **Type**. Optional information can be also added in the **Description** box (any free text) or for the data validation criteria (**Min** and **Max** values).

The defined manual tag can be one of three types available: **Analog** (default selection), **Boolean** and **Text**.

**NOTE:** The data validation criteria input is available only for the **Analog** type tags. If other type is selected, validation criteria input controls will be hidden.

Values for both **Min** and **Max** for the validation criteria are expected as integer or float numbers. They will be saved and displayed as a double format number. If **Min** or **Max** value edit boxes remain empty, the corresponding **Min** or **Max** double value will be considered.

The amount of manual tags defined in the **Manual Entry Parameters** configuration window will be displayed in the **Parameters:** section below the manual tags list.

If you click "**Export**" button, the standard Windows "**Save As**" window will be opened, where you can select location and name for the list export file. A list export file format is **csv** with semi-column used as a separator. A list export file will have a header, as the first row, and data starting from the second row. It will have 5 columns: **Name**, **Type**, **Min**, **Max**, **Description**. **Name** and **Type** fields are obligatory and others are optional.

If you click "**Import**" button, the standard Windows "**Open file**" window will be opened, where you can select location and name for the list import file. "**Open file**" will be filtered by "**\*.csv**" extension.

The format of the import file list will be exactly the same as described in the "**Export**" section. Only 2 columns - **Name** and **Type** are obligatory. If a list file with only these 2 columns has been created, such an import file should be imported as well.

When a file will be imported, the message box will pop up, asking: "*Do you want to replace existing tags by the importing list?*" The corresponding operation will be done according to a user's choice.

**NOTE:** If you try to import tags, appending the list to the existing one, and the imported tag will have the same name as an already existing one, a message box will pop up saying that the duplicated tag name has been found, specifying the name of that tag and proposing a user to choose either to "use an existing tag definition", or "delete an existing one and use an imported tag definition. The corresponding action will be done according to the user's choice.

There is no limit in term of the number of tags, defined in the **Web manual driver** configuration dialog window.

**NOTE:** If you need to configure the same driver more than once, then, after having configured it the first time, you'll just need to click in the "**Select Data Source Type**" field on any other driver and then go back to the driver that you need to configure.



## Manual Data Entry

**Manual Data Entry Functions** enable users to enter manual values in the standard Dream Report reporting template. Those manual values are used to enter manual data into the Dream Report database and use them for calculations or filtering for regular reporting. This functionality is enabled **ONLY** in Dream Report Web Portal (for details about the Dream Report Web Portal, please see [Web portal](#) section).

**Manual Data Entry Functions** also enable to select and transfer a file (**CSV** or **Excel** file) from a web client PC to the location, defined in the Dream Report project, thus allowing to import data from Excel or CSV files (data importer automatically picks up such a file, reads values and their corresponding timestamps and logs them all into a database).

### System Requirements

**Data Entry Functions** are compliant with the following operating systems:

- Windows XP (SP3 and higher),
- Windows Vista (SP1 and higher),
- Windows 7 (32-bit and 64-bit),
- Windows Server 2008 (32-bit and 64-bit) and
- Windows Server 2008 R2

**Data Entry Functions** are compliant with the following database types:

- SQL Server 2000,
- SQL Server 2005,
- SQL Server 2005 Express
- SQL Server 2008
- SQL Server 2008 Express
- MS Access 2000, 2003, 2007
- MySQL 4.0, 5.0, 5.1
- Oracle 9.1, 10.0

The following **Microsoft .NET Framework** versions are required to be installed on DR server and web client PCs:

- .NET Framework 3.5
- .NET Framework 4.0

### Manual Data Entry Report Configuration

To configure Manual Data Entry Reports operation, user will have to:

1. Create a Dream Report project where Manual Data Entry report(s) will be set (please refer to the [Project Settings](#) section of this manual).



## Ocean Data Systems

2. Add and configure one or several instances of the Web Manual Driver and enter the list of manual parameters, which will be available in reports (please refer to the [Web Manual Driver](#) section).
3. Define Dream Report project users, which will have access to that project (please refer to the [User Management](#) section).
4. Design reports with Manual Data Entry and configure them correspondingly to the manual data parameters defined (please refer to the [Report Settings](#) and [Designer Studio](#) sections).
5. Define user access to every report, i.e. select which users will be able to access that report (please refer to the [User Authorization](#) section).

As soon as this configuration has been done, Dream Report web portal will automatically contain all designed reports. When user logs into the web portal, only the allowed list of reports will be displayed and user can open any of them.

### Web Elements

[Manual Data Entry Functions](#) enable users to add **web elements**, i.e. **dynamic interactive objects** which will be available ONLY in web report formats and will enable users to interact with different report data (enter values, select values from combo boxes, push a button with pre-defined operation, etc).

**Web elements** will be available only when "[Web](#)" option is enabled for the current report (for details, please see the [Report Output Format](#) section of this manual).

Configuration and functionality of **web elements** for WEB reports is described in details in the following sections: [Timestamp Picker](#), [Hyperlink](#), [Combo Box](#), [Action Button](#).



## IIS Configuration on Windows Vista

When using Dream Report on Windows Vista, certain manual configuration of the IIS (Internet Information Services), as described below, has to be done.

This configuration is required only once, when your project is ready and web portal has to be used.

The following configuration steps have to be done:

1. Open IIS (Internet Information Services) management window. It can be opened using windows menu *Start --> Control panel --> Administrative tools --> Internet Information Services*.
2. Open the folder with your web virtual directories (folder *Web Folder --> Default web site*).
3. Add a new virtual directory, which is pointing to your Dream Report <project folder>/Web directory. You can use any logical name for that virtual directory.
4. Add a sub-folder, named "files" to your new virtual directory. This sub-folder must point to your Dream Report <project folder>/Reports directory.

Since the virtual directory and its sub-folder are created, it will be used by Dream Report web portal afterwards and there is no need to re-do this configuration in the future for the same Dream Report project.

NOTE: To create virtual folders, your windows user has to be full administrator on that computer.



## Manual Configuration of IIS

Manual configuration of the Internet Information Services (IIS) and the list of required components for use with the Dream Report Web portal

### Introduction

Before installing Dream Report with the Web Portal option, IIS needs to be enabled/configured with specific options, as described below. Those actions are required prior to Dream Report installation, and don't have to be performed again when creating/running a new project.

### Steps to follow:

1. Log in to Windows as a System Administrator.
2. Ensure that your computer, where you are installing Dream Report, has an installation of **.Net Framework version 3.5 or newer** (here is the link to download the installation of .NET Framework 3.5 SP1: <http://www.microsoft.com/downloads/details.aspx?familyid=ab99342f-5d1a-413d-8319-81da479ab0d7&displaylang=en>)
3. Configure the Internet Information Services:

#### 3.1 Configuring IIS on Windows 7:

- Open the **Programs and Features** window from the *Control Panel* -> *Programs and Features* on your PC and click on *Turn Windows features on or off* item as shown below:

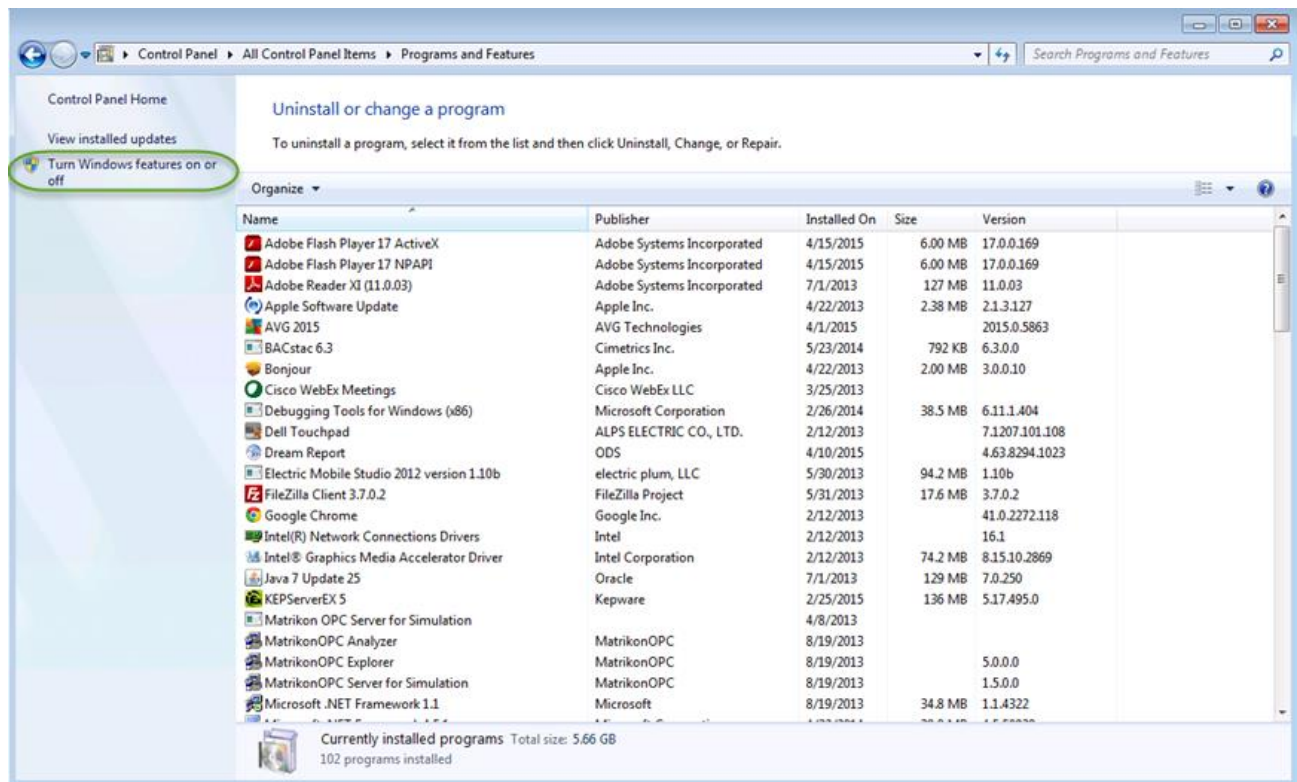



- Expand the *Internet Information Services* section in the list and make sure that all the following components are enabled (please see the checked items in the image below):

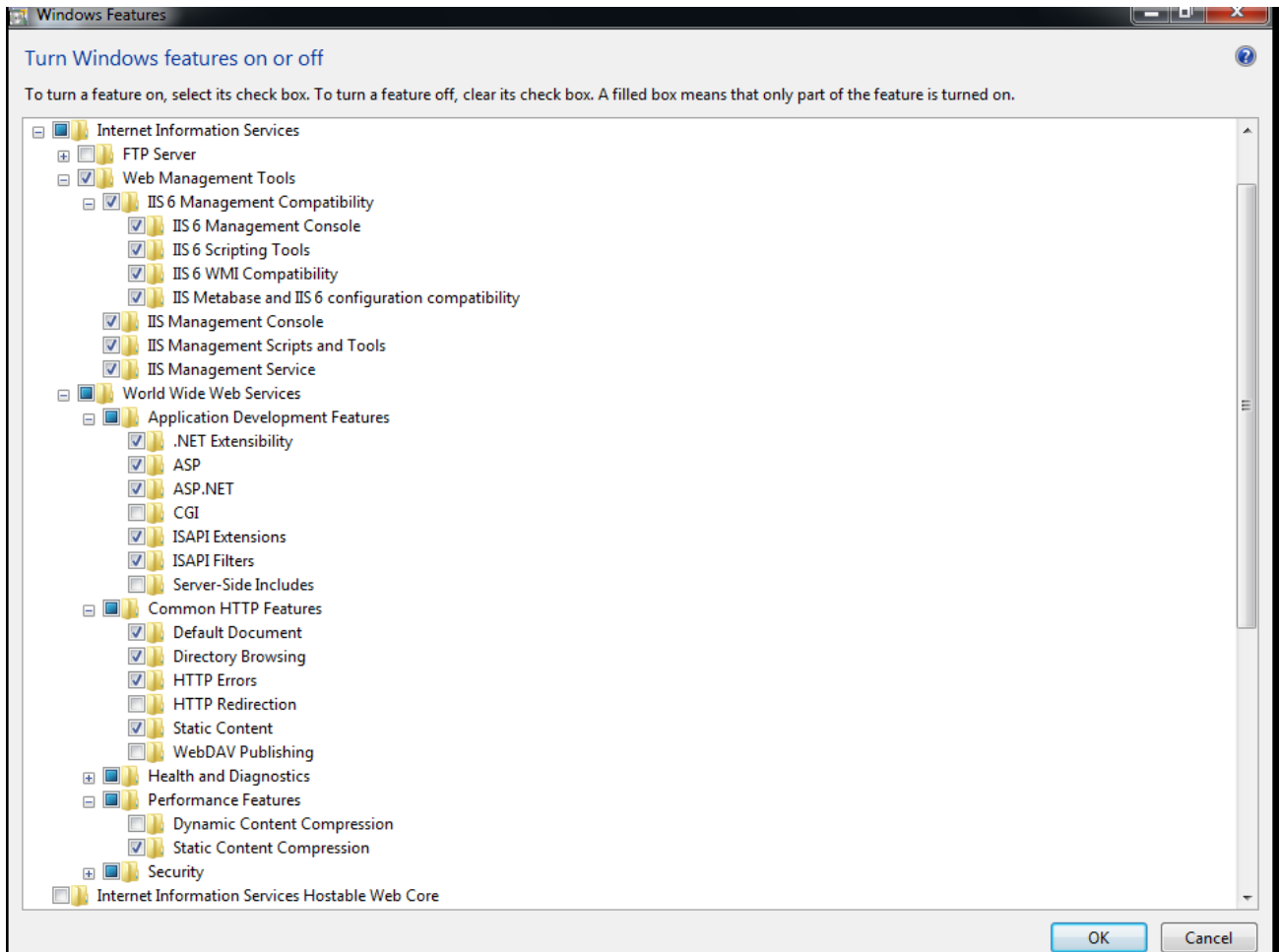





### 3.2 Configuring IIS on Windows 8:

- Point to the lower-right corner of the screen, move the mouse pointer up, the icon panel will be activated and then click *Settings*.
- Open **Control Panel** by pointing to the upper-right corner of the screen, moving the mouse pointer down, and then clicking *Search*, entering **Control Panel** in the search box, and then clicking **Control Panel**.
- Open the **Programs and Features** window from the *Control Panel -> Programs and Features* on your PC and click the *Turn Windows features on or off* option, as shown below:

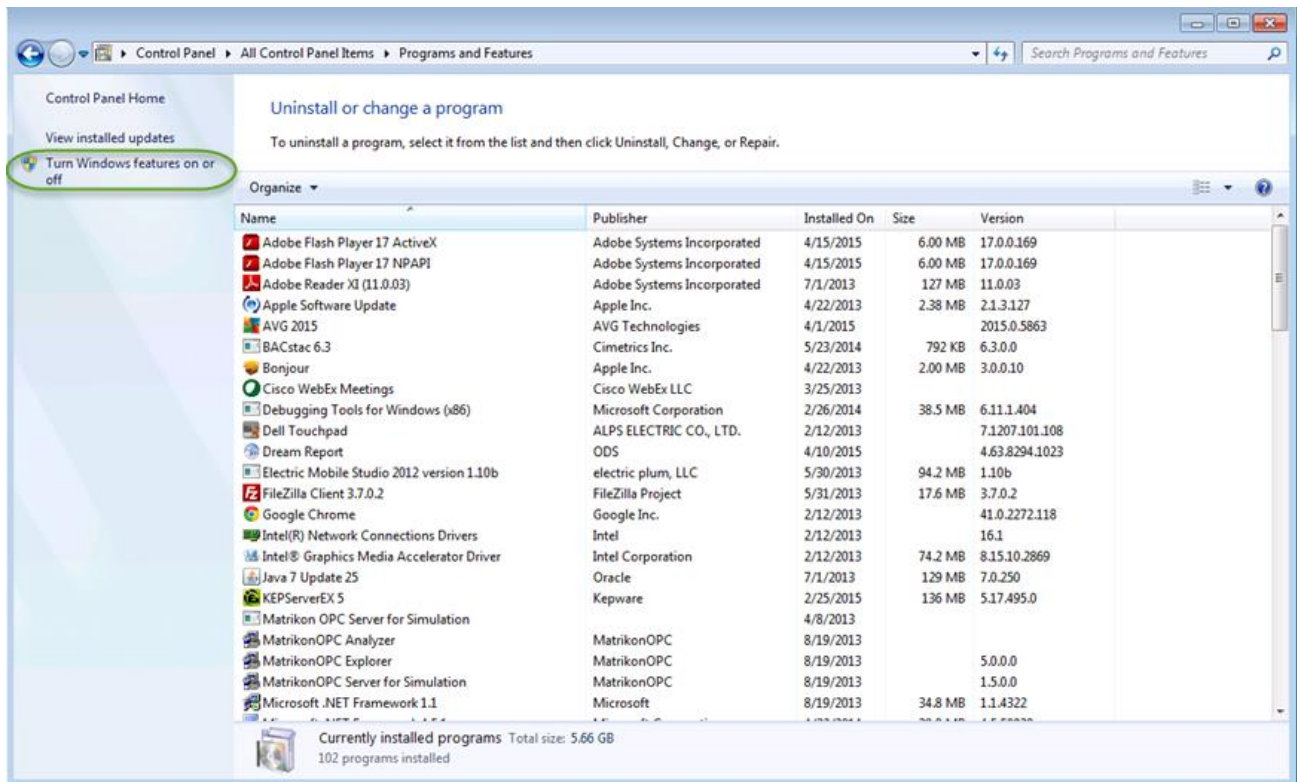



## Ocean Data Systems

- Please make sure that the following components are enabled (the checked items in the image below):

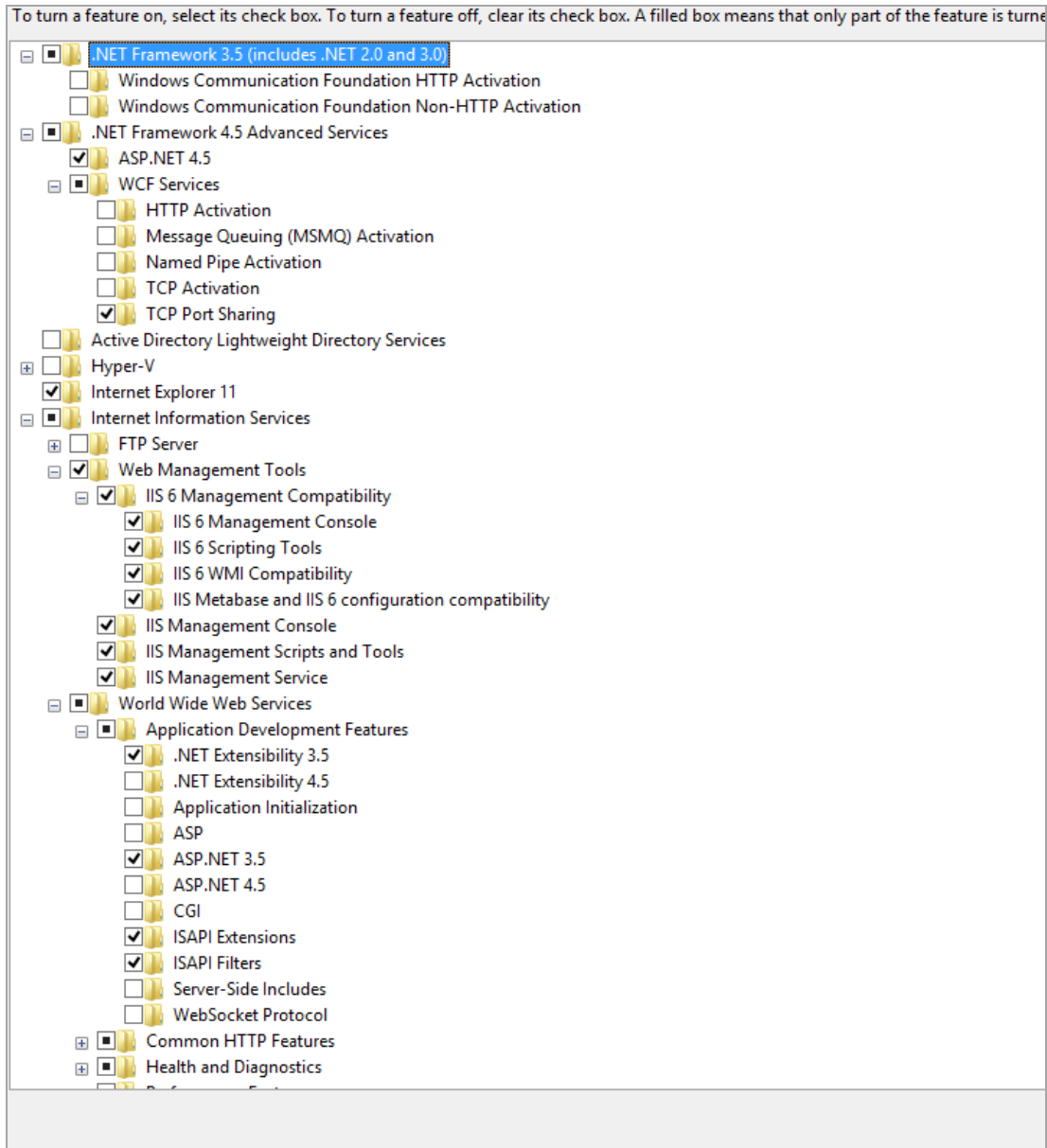



### 3.3 Configuring IIS on Windows Server 2008:

- Click *Start*, then right-click on *Computer*, and in context menu select *Manage*
- Please select the specified features and roles:

The screenshot displays the Server Manager console for a server named TRAINING01. The interface is organized into several sections:

- Server Summary:** Includes links for [Server Summary Help](#), [Change System Properties](#), and [Go to Windows Firewall](#).
- Roles Summary:** Shows 3 of 17 installed roles. A green circle highlights the installed roles: [Application Server](#), [File Services](#), and [Web Server \(IIS\)](#). To the right are links for [Go to Roles](#), [Add Roles](#), and [Remove Roles](#).
- Features Summary:** Shows 3 of 41 installed features. A green circle highlights the installed features: [Remote Server Administration Tools](#), [Role Administration Tools](#), [Web Server \(IIS\) Tools](#), [Windows Process Activation Service](#), [Process Model](#), [.NET Environment](#), [Configuration APIs](#), [.NET Framework 3.5.1 Features](#), and [.NET Framework 3.5.1](#). To the right are links for [Add Features](#) and [Remove Features](#).
- Resources and Support:** Includes a link for [Resources and Support Help](#).

At the bottom, a status bar indicates: [Last Refresh: Today at 2:40 PM](#) [Configure refresh](#)



- Then, please go to the **Roles** section of the **Server Manager**, select **Web Server (IIS)** role, and configure the **Role Services** as shown on the screenshot below:

The screenshot shows the Server Manager console for a server named TRAINING01. The 'Roles' section is selected in the left-hand tree view. The main pane displays the 'Web Server (IIS)' role, which is described as providing a reliable, manageable, and scalable Web application infrastructure. Below this, the 'Role Services' section shows that 33 services are installed. A table lists these services and their status.

Role Service	Status
Web Server	Installed
Common HTTP Features	Installed
Static Content	Installed
Default Document	Installed
Directory Browsing	Installed
HTTP Errors	Installed
HTTP Redirection	Installed
WebDAV Publishing	Not installed
Application Development	Installed
ASP.NET	Installed
.NET Extensibility	Installed
ASP	Installed
CGI	Installed
ISAPI Extensions	Installed
ISAPI Filters	Installed
Server Side Includes	Not installed
Health and Diagnostics	Installed
HTTP Logging	Installed
Logging Tools	Not installed
Request Monitor	Installed
Tracing	Not installed
Custom Logging	Not installed
ODBC Logging	Not installed
Security	Installed
Basic Authentication	Installed
Windows Authentication	Installed
Digest Authentication	Not installed
Client Certificate Mapping Authentication	Not installed
IIS Client Certificate Mapping Authentication	Not installed
URL Authorization	Not installed
Request Filtering	Installed
IP and Domain Restrictions	Not installed
Performance	Installed
Static Content Compression	Installed
Dynamic Content Compression	Installed
Management Tools	Installed
IIS Management Console	Installed
IIS Management Scripts and Tools	Installed
Management Service	Installed
IIS 6 Management Compatibility	Installed
IIS 6 Metabase Compatibility	Installed
IIS 6 WMI Compatibility	Installed
IIS 6 Scripting Tools	Installed
IIS 6 Management Console	Installed
FTP Server	Not installed
FTP Service	Not installed
FTP Extensibility	Not installed
IIS Hostable Web Core	Not installed



### 3.4 Configuring the IIS on Windows Server 2012:

- Click *Server Manager* from the *Start menu* and configure *Server Roles* as shown below (please note that there are 2 consecutive images for *Server Roles* configuration):

DESTINATION SERVER  
ods-srv2012-std-01

Select server roles

Before You Begin  
Installation Type  
Server Selection  
**Server Roles**  
Features  
Confirmation  
Results

Select one or more roles to install on the selected server.

**Roles**

- Web Server (IIS) (Installed)
  - Web Server (Installed)
    - Common HTTP Features (Installed)
      - Default Document (Installed)
      - Directory Browsing (Installed)
      - HTTP Errors (Installed)
      - Static Content (Installed)
      - HTTP Redirection
      - WebDAV Publishing
    - Health and Diagnostics (Installed)
      - HTTP Logging (Installed)
      - Custom Logging
      - Logging Tools
      - ODBC Logging
      - Request Monitor
      - Tracing
    - Performance (Installed)
      - Static Content Compression (Installed)
      - Dynamic Content Compression
    - Security (Installed)
      - Request Filtering (Installed)
      - Basic Authentication
      - Centralized SSL Certificate Support
      - Client Certificate Mapping Authentication
      - Digest Authentication
      - IIS Client Certificate Mapping Authentication
      - IP and Domain Restrictions
      - URL Authorization
      - Windows Authentication

**Description**

File and Storage Services includes services that are always installed, as well as functionality that you can install to help manage file servers and storage.

< Previous    Next >    Install    Cancel



Server Roles configuration, continued...

DESTINATION SERVER  
ods-srv2012-std-01

### Select server roles

Select one or more roles to install on the selected server.

**Roles**

- IIS Client Certificate Mapping Authentication
- IP and Domain Restrictions
- URL Authorization
- Windows Authentication
- Application Development
  - .NET Extensibility 3.5
  - .NET Extensibility 4.5
  - Application Initialization
  - ASP
  - ASP.NET 3.5
  - ASP.NET 4.5
  - CGI
  - ISAPI Extensions
  - ISAPI Filters
  - Server Side Includes
  - WebSocket Protocol
- FTP Server
- IIS Hostable Web Core
- Management Tools (Installed)
  - IIS Management Console (Installed)
  - IIS 6 Management Compatibility (Installed)
    - IIS 6 Metabase Compatibility (Installed)
    - IIS 6 Management Console (Installed)
    - IIS 6 Scripting Tools (Installed)
    - IIS 6 WMI Compatibility (Installed)
  - IIS Management Scripts and Tools (Installed)
  - Management Service
- Windows Deployment Services
- Windows Server Update Services

**Description**

File and Storage Services includes services that are always installed, as well as functionality that you can install to help manage file servers and storage.

< Previous    Next >    Install    Cancel



- After configuring *Server Roles*, please go to the *Features* section and configure it as shown below:

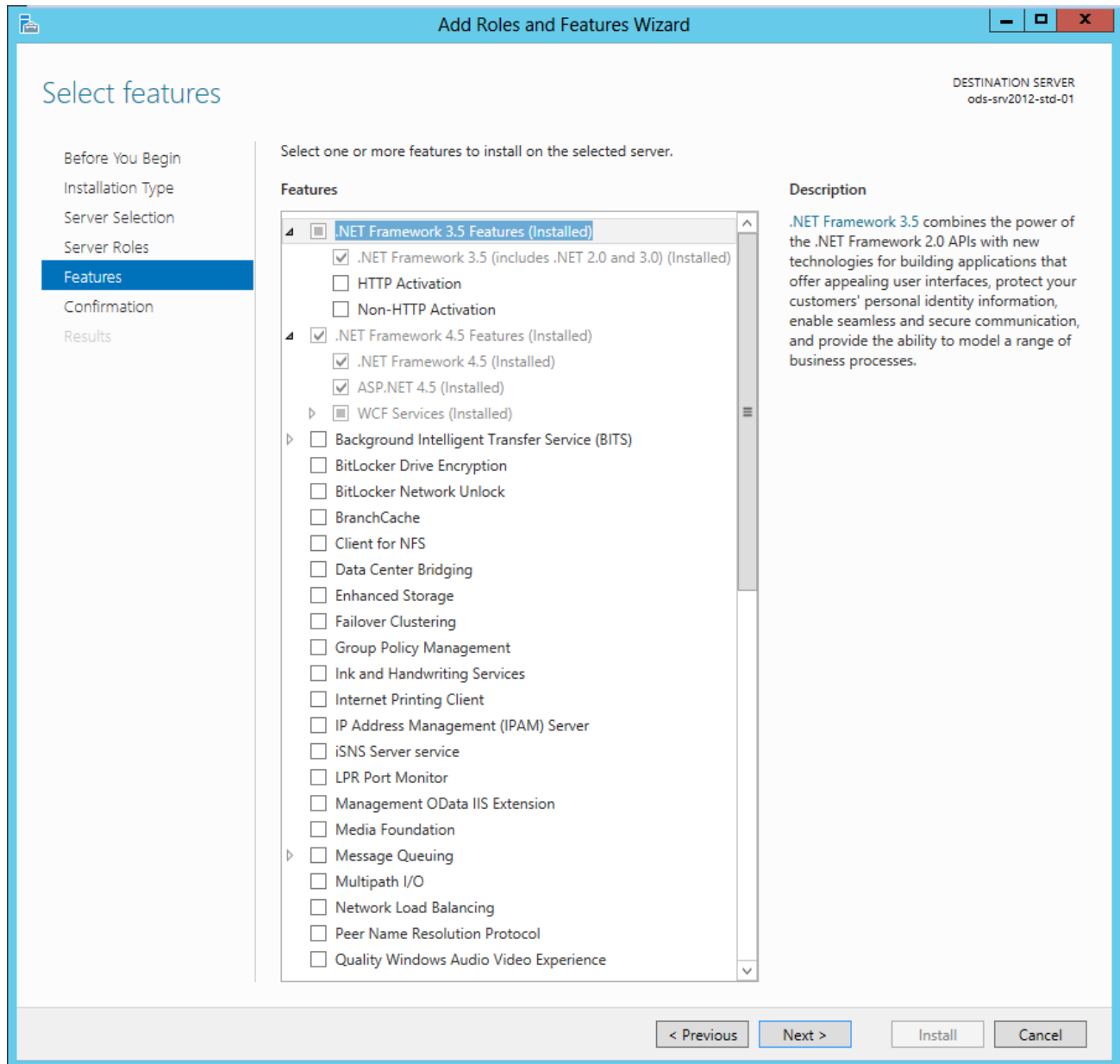

4. Complete installation of IIS and restart computer.

5. Install Dream Report

**Note:**

If IIS is *not* installed and configured correctly prior to installing Dream Report, Dream Report can still be installed, but you will receive a message stating that the DRWeb Portal will not be installed as part of the installation. IIS can be installed and configured at a later time, at which point, you can run the Dream Report software installation again, where you will have the opportunity to install the DRWeb Portal.



## IIS Configuration in 64-Bit Operating System

When using Dream Report with web portal on Windows Vista or on Windows 7, in 64-Bit Operating Systems, certain manual configuration of the IIS (Internet Information Services), as described below, **may** need to be done.

### 1. Open **IIS (Internet Information Services) Manager**.

- If you are using Windows Server 2008 or Windows Server 2008 R2, it can be opened using windows menu **Start --> Administrative tools --> Internet Information Services (IIS) Manager**;
- If you are using Windows Vista or Windows 7, it can be opened using windows menu **Start --> Control Panel --> Administrative tools --> Internet Information Services (IIS) Manager**.

### 2. Select "**DefaultAppPool**" in the "**Application Pools**" of the **Connections** section (please see the picture below):

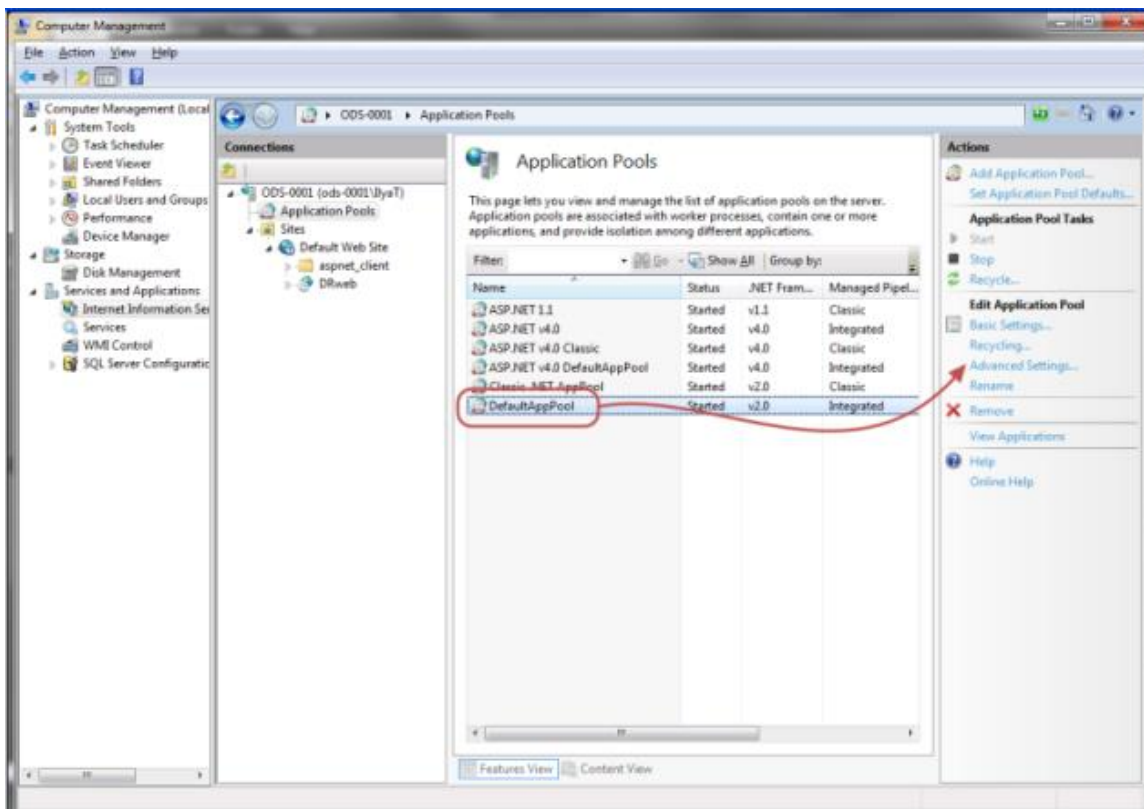

### 3. Click on the "**Advanced Settings**" option in the right-hand side **Actions** section and configure the "**DefaultAppPool**" application pool. Please ensure that **.NET Framework Version** is set as **v2.0**, and **Enable 32-Bit Applications** is set as **True** (please see the picture below):





## Ocean Data Systems

Advanced Settings

[+] (General)	
.NET Framework Version	v2.0
Enable 32-Bit Applications	True
Managed Pipeline Mode	Integrated
Name	DefaultAppPool
Queue Length	1000
Start Automatically	True
[+] CPU	
Limit	0
Limit Action	NoAction
Limit Interval (minutes)	5
Processor Affinity Enabled	False
Processor Affinity Mask	4294967295
[+] Process Model	
Identity	ApplicationPoolIdentity
Idle Time-out (minutes)	20
Load User Profile	True
Maximum Worker Processes	1
Ping Enabled	True

**Name**  
[name] The application pool name is the unique identifier for the application pool.

OK Cancel

**NOTE:** If another application pool default needs to be configured, please create a new application tool by clicking "[Add Application Tool](#)" in the **Actions** section and create another application pool with the same options selected, i.e. **.NET Framework Version** set as **v2.0** and **Enable 32-Bit Applications** set as **True**.



# Dynamic Interactive Objects

## Timestamp Picker

**Timestamp Picker** is a dynamic interactive object, which enables users to select timestamp for association with the entered values, and is available ONLY in WEB reports (please also see [Manual Data Entry](#) section).

To add this object, click on the command button *Timestamp Picker* on the *Web Elements* ribbon icon on the horizontal toolbar in the Dream Report Designer Studio menu (see pic. below):

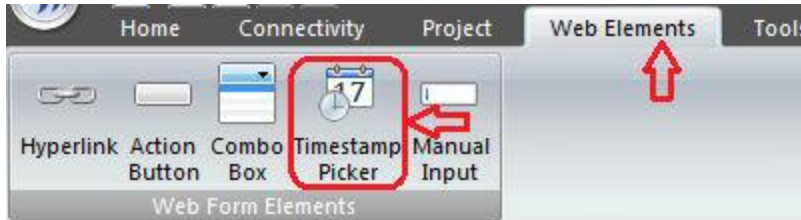

Draw a rectangle in the workspace where the output data will be displayed.

The following **Timestamp Picker Configuration** dialog box will be opened:

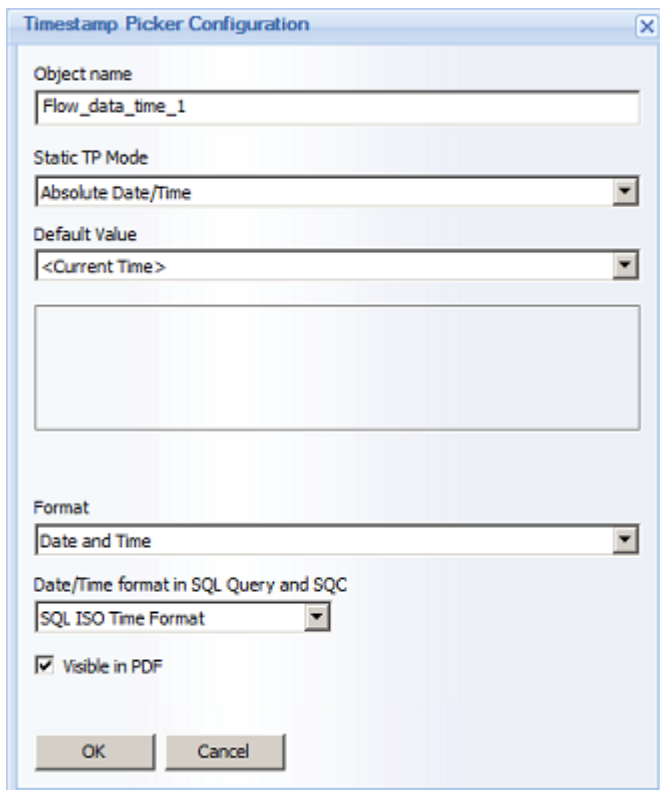

**Object Name** must be a unique logical name, which will be used for each Timestamp Picker object in order to be able to reference any of those specific date/time objects in the data entry objects.



## Ocean Data Systems

**Default Value** allows users to configure which timestamp value this object will display as a default. The **Default Value** combo box has the list of all Timestamp Picker objects and simple statistical objects (Single Data Objects, Compound and Expression Objects), already defined in that report, so that the user can select one object to control default values in others. Also the **Default value** combo box has an entry "**Current time**", so every Timestamp Picker object will always display current time by default. This entry will be displayed by default when a user will add a new object to the report.

**Format** enables users to select specific format of date and time for each Timestamp Picker. This combo box has 3 options available: "**Date and time**", "**Date**" and "**Time**".

The "**Visible in PDF**" option controls whether this Timestamp Picker object will be displayed in the generated PDF report or not. If this object is defined as invisible, then it will be initialized with its default value and then all data input objects, that will be based on that object, will get its default value.

The "**The Date/Time format in SQL Query and SQC**" option allows the user to set the date/time format that may be required by a SQL query or SQC condition. At report generation time, the user-selected date/time value in the Timestamp Picker will be converted to the format specified in this option. Options available are:

- "**SQL ISO Time Format**" (default)
- "**Seconds from 01/01/1970**"
- "**Custom Time Format**" (user specified format)

**Example** of the Timestamp Picker object in the runtime mode:



## Hyperlink

**Hyperlink** is a dynamic interactive object, which enables users to add a text and turn it into a hyperlink, and is available ONLY in WEB reports (please also see [Manual Data Entry](#) section)

To add this object, click on the command button *Hyperlink* on the *Web Elements* ribbon icon on the horizontal toolbar in the Dream Report Designer Studio menu (see pic. below):



The following **Hyperlink Configuration** dialog box will be opened:

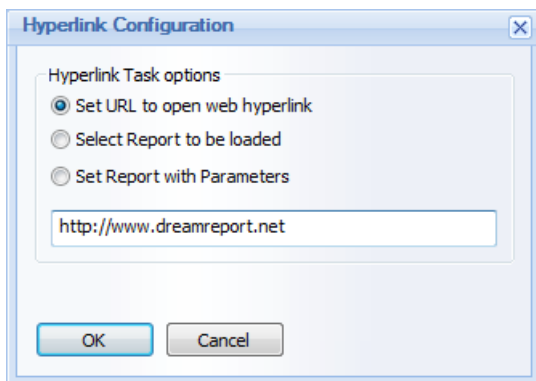

If “**Set URL to open web hyperlink**” option is selected, user **MUST ENTER A WEB PAGE ADDRESS (http://)**, and then, after clicking on that hyperlink, a new web page will be opened, navigated to a specified hyperlink (please see the pic. above).

If “**Select Report to be loaded**” option is selected, the dialog will display a combo box with the list of all reports, available for that user, and he/she will be able to select which report will be opened upon clicking on that hyperlink (please see the pic. below):

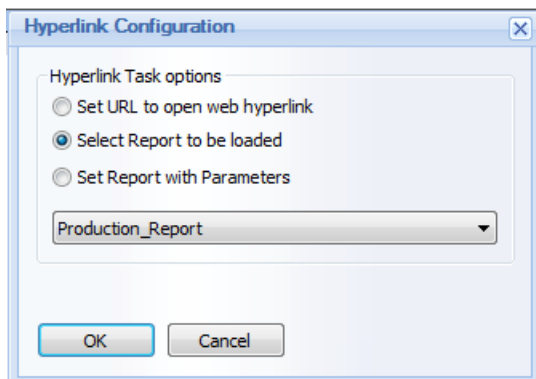



If “**Set Report with Parameters**” option is selected, user will have to click on the *Configure* button in order to enable internal hyperlink for the project report (please see the pic. below):

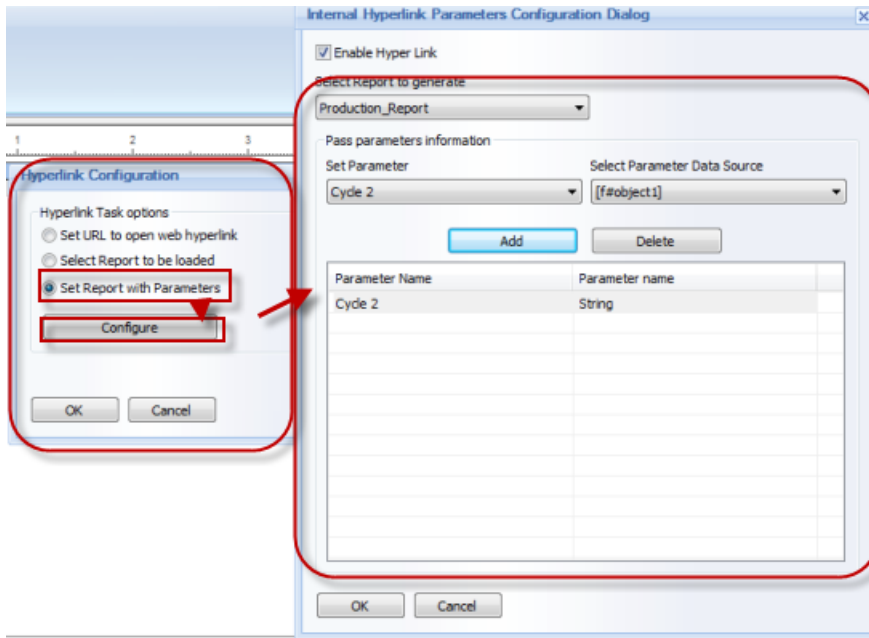

By default this option will be disabled.

In the "**Enable Hyperlink**" check box user can enable/disable object as internal hyperlink

Combo box “**Select Report to generate**” will be filled with the list of all project reports including current report.

Combo box “**Set Parameter**” will be filled with the list of all available defined internal project parameters (IPPs).

Combo box “**Select Parameter Data Source**” will be filled with the list of all relevant objects defined in that report (i.e. with the following object types: Single Data Objects, Compound Data Objects, Expression Data Objects, Combo boxes, Date/Time pickers).

When user will click on “*Add*” button, the selected parameter with the selected corresponding object will be added to the list.

**NOTES:**

- The list of parameters can't have the same parameter defined twice. However, it may have the same report object defined several times for multiple parameters.
- Report parameters using hyperlinks will work only for web report formats in Dream Report Web Portal. Only WEB report formats (Report Output File) will be generated using hyperlinks. PDF and Excel report formats will not be generated using hyperlinks.

For details on internal project parameters (IPP) configuration, please refer to the Project Parameters section of this manual.



### Text Object Hyperlink Definition

If a text object is defined as a hyperlink, its caption is not linked to the object's hyperlink configuration. So, if a user will change the text, it will have no influence on a hyperlink definition. To edit hyperlink, user will have to select that text object and click on the **Hyperlink** button or select **Hyperlink** from the right-click context menu (please see the pic. below):

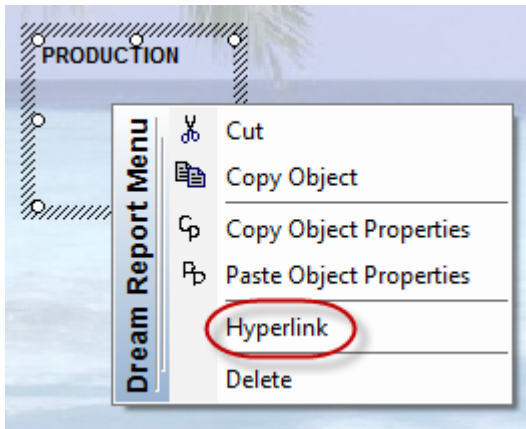

To remove hyperlink from the text object, select **Delete** from the right-click Dream Report context menu.

Dream Report Context (right-click) Menu for the text object has 6 entries: **Cut**, **Copy Object**, **Copy Object Properties**, **Paste Object Properties**, **Hyperlink**, **Delete**.



## Combo Box

**Combo Box** is a dynamic interactive object, which enables users to select values from a predefined list, and is available ONLY in WEB reports (please also see [Manual Data Entry](#) section)

The **Combo box** object will be visible only in web reports and will not be displayed in PDF/Excel reports.

To add this object, click on the command button *Combo Box* on the *Web Elements* ribbon icon on the horizontal toolbar in the Dream Report Designer Studio menu (see pic. below):

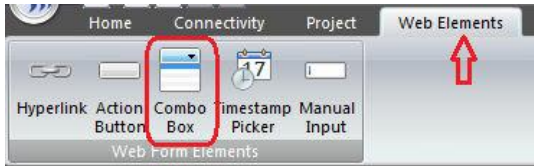

Draw a rectangle in the workspace where the output data will be displayed. The following **Combo Box Configuration** dialog box will be opened:

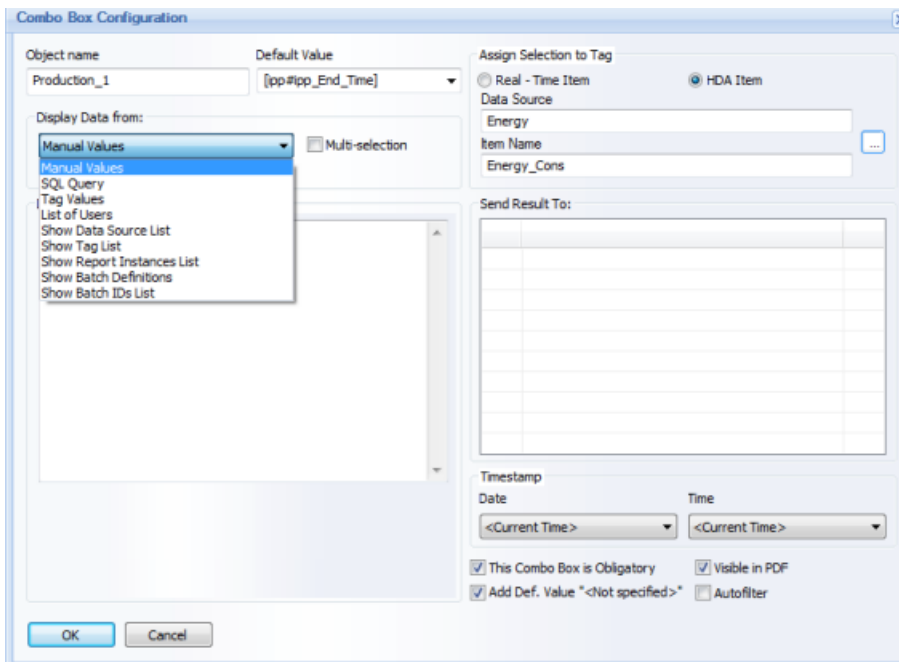

**Object Name** must be a unique logical name, which will be used in further work with that object within the project.

**Default Value** enables to set value which will be displayed as default in the Combo Box object in WEB reports in Dream Report Web Portal.

### Data Display Configuration

The **Display Data from:** combo box has 9 source types of data to display: **Manual values**, **SQL query**, **Tag values**, **List of users**, **Show Data Source List**, **Show Tag List**, **Show Report Instances List**, **Show Batch Definitions** and **Show Batch IDs List**.

- **Manual values** data display. In the **Data Configuration** section user has to specify manually a set of values (text or numeric), separated by comma or (“,”) or semi-column (“;”) (please see the pic. below):



## Ocean Data Systems

Combo Box Configuration

Object name: Production\_1      Default Value: [jpp#pp\_End\_Time]

Display Data from: Manual Values       Multi-selection

Data Configuration: Tank2, Tank3, Tank4

Assign Selection to Tag:  Real - Time Item       HDA Item

Data Source: Energy

Item Name: Energy\_Cons

Send Result To:

Timestamp: Date: <Current Time>      Time: <Current Time>

This Combo Box is Obligatory       Visible in PDF

Add Def. Value \*<Not specified>\*       Autofilter

OK      Cancel

**Combo Box Object** will display entered values in the same order as they have been entered in the **Combo Box Configuration** dialog box, without doing any sorting.

- **SQL Query** data display. In the **Data Configuration** section user has to **select the DSN** (see explanations below), and specify the **SQL Query**, which will be launched at the report start and the query result will be displayed in the combo box (please see the pic. below):

Combo Box Configuration

Object name: Production\_1      Default Value: [jpp#pp\_End\_Time]

Display Data from: SQL Query       Multi-selection

Data Configuration: Select DSN: Process

SQL Query: SELECT Tank1, Tank2, Tank3 FROM Table 1

Assign Selection to Tag:  Real - Time Item       HDA Item

Data Source: Energy

Item Name: Energy\_Cons

Send Result To:

Timestamp: Date: <Current Time>      Time: <Current Time>

This Combo Box is Obligatory       Visible in PDF

Add Def. Value \*<Not specified>\*       Autofilter

OK      Cancel

By default the **Select DSN** combo box will be empty. If any DSNs have already been configured in the Project DSN Manager, then user will be able to select one of the DSNs from that list. If no DSNs have been configured yet, or, if user needs to configure a specific DSN, he will have to click on the "..." (browse) button in the **Select DSN** combo box and the **Project DSNs Configuration** dialog window will be opened.

For details on how to configure DSN, please go to the **DSN Manager** section of this manual.





## Ocean Data Systems

- **Tag values** display. In the **Data Configuration** section user has to select the tag and then, when initializing the report, Dream Report will read all available values of a selected tag for the defined time period from the database and display those values in the combo box:

The screenshot shows the 'Combo Box Configuration' dialog box. It contains the following fields and options:

- Object name:** Production\_1
- Default Value:** [pp#pp\_End\_Time]
- Display Data from:** Tag Values (with a 'Multi-selection' checkbox)
- Data Configuration:** External History Server (selected)
- Data Source:** Process
- Item Name:** Batch\_Data:Tank1
- Define time period:** Absolute or relative period definition (selected). Start of report period: 10/1/2012 13:00:00. End of report period: 10/16/2012 13:00:00.
- Assign Selection to Tag:** HDA Item (selected)
- Data Source:** Energy
- Item Name:** Energy\_Cons
- Send Result To:** An empty table.
- Timestamp:** Date: <<Current Time>, Time: <<Current Time>
- Checkboxes:** This Combo Box is Obligatory (checked), Add Def. Value \*<Not specified\*> (checked), Visible in PDF (checked), Autofilter (unchecked).
- Buttons:** OK, Cancel.

User has to select a tag (**Data Source/Item name**) and time period (**Define time period**), and then the combo box will be filled with all values extracted for the specified tag for the specified time period.

If user wants to display all existing values, he can check the **All values** check box, and then the time period definition control will become disabled and all tag values will be extracted. If more than one same value exists in the database, only one will be displayed in the combo box (it will operate similar to the “**SELECT DISTINCT ...**” SQL query).

If a user wants to apply additional filtering to the data, he/she can click on the **Advanced SQL** button. The **Advanced SQL Condition** dialog window will be opened (for details, please see [Advanced SQL Condition](#) section of this manual).

- **List of users** display. When this option is selected, the combo box will be filled with the list of all available users.

If Windows user management system is used (Active directory or local windows users list), then Dream Report will retrieve the list of all users from Windows and fill the combo box with that list (for details, please see [User Management](#) section of this manual).



## Ocean Data Systems

- **Show Data Source List.** This option will have 2 radio-buttons: “**Dream Report History**” and “**External History Server**” (please see the pic. below):

Combo Box Configuration

Object name: Production\_1    Default Value: [[pp#pp\_End\_Time]]

Display Data from: Show Data Source List    Multi-selection:

Data Configuration:  
 Dream Report History  
 External History Server

Assign Selection to Tag:  
 Real - Time Item     HDA Item  
Data Source: Energy  
Item Name: Energy\_Cons

Send Result To:

Timestamp:  
Date: <Current Time>    Time: <Current Time>

This Combo Box is Obligatory     Visible in PDF  
 Add Def. Value \*<Not specified>\*     Autofilter

OK    Cancel

In a web report the web combo box will be filled with a list of data sources of the corresponding type.

- **Show Tag List.** If this display option is selected, its configuration will be the following:

Combo Box Configuration

Object name: Production\_1    Default Value: [[pp#pp\_End\_Time]]

Display Data from: Show Tag List    Multi-selection:

Data Configuration:  
 Select Data Source below  
 Select Data Source from another Combo box

Display Data from:  
 Dream Report History     External History Server  
Process

Assign Selection to Tag:  
 Real - Time Item     HDA Item  
Data Source: Energy  
Item Name: Energy\_Cons

Send Result To:

Timestamp:  
Date: <Current Time>    Time: <Current Time>

This Combo Box is Obligatory     Visible in PDF  
 Add Def. Value \*<Not specified>\*     Autofilter

OK    Cancel

The "Data Configuration" section will have 2 radio-buttons: "Select Data Source below" and "Select Data Source from another Combo box".



## Ocean Data Systems

If **Select Data Source below** option is selected, then the "**Display Data from**" combo box will contain the list of data sources by the selected type: **Dream Report History** or **External History Server** (please, see the pic. above).

If **Select Data Source from another Combo box** option is selected, then the "**Display data from**" combo box will contain the list of web combo box objects, defined in that report (please, see the pic. below):

The screenshot shows a configuration window with the following elements:

- A dropdown menu labeled "Display Data from:" with the selection "Show Tag List".
- A checked checkbox labeled "Multi-selection".
- A section titled "Data Configuration" containing two radio buttons:
  - Select Data Source below
  - Select Data Source from another Combo box
- A second dropdown menu labeled "Display Data from:" with the selection "Production2".

The "**Show Tag List**" combo box will be a drop down list where users will be able to select one or multiple tags in one selection. The "**Show Tag List**" combo box in a web report will have no default selection.

If a report is generated from Web and this report has the "**Show Tag List**" combo box with no selection, then all reports will be generated by default using tags, originally defined in all report objects. But if report is generated and the "**Show Tag List**" combo box has some tags selected, then, the report will be generated for the selected tags using the tag replacement mechanism (used in [Report Pre-processor](#)).

- **Show Report Instances List** display. If this option is selected, then, in real-time, it will be filled with the list of report instances defined for that report.
- **Show Batch Definitions** display. If this option is selected, the combo box in a web report will be filled with a list of batch definition names defined in the project. Report may have multiple combo boxes with this function defined.



## Ocean Data Systems

- **Show Batch IDs List** display. If this option is selected, its configuration will have the following design:

The "**Data Configuration**" section will have 2 radio-buttons: "**Select Batch Definition below**" and "**Select Batch Definition from another Combo box**". Both options define the source for retrieving and building the **Batch ID list**.

If "**Select Batch Definition below**" option is selected, then the combo box will be filled with the list of the actual (existing) batch definitions, defined in the project.

If "**Select Batch Definition from another Combo box**" option is selected, then the combo box below that radio-button will be filled with the list of all web combo box objects, defined in this report. User will be able to select a web combo box object, which will have the "**Batch Definition**" function (described above in the "**Show Batch Definitions**" section), and then the batch ID list for that given web combo box will be filled with batch IDs taken from the batch definition, which has been selected in a corresponding "**Show Batch Definitions**" web combo box.

The "**Show Batch IDs List**" combo box in the web report will have no default selection.

If report is generated from Web and report has the "**Show Batch IDs List**" combo box, then, if it has no selection, the report will be generated using the default time period, defined in its objects. If the "**Show Batch IDs List**" combo box has any selection, the report will be generated for the selected batch ID.

Check box "**Multi-selection**" will define if the combo box will be opened in a **multi-selection** mode (drop-down list with check-boxes). If this option will be disabled, then the combo box will be opened as a regular **single-selection** drop-down list combo box.

By default this check box is unchecked.

In the **Assign Selection to Tag** section user has to select either a real-time (**Real-time Item**) or history data (**HDA Item**) value parameter, which will get the selected value of the combo box when the report is completed.



## Ocean Data Systems

Combo box **"Send Result To:"** specifies an action for any selected entry of this combo box. This combo box will be filled with the list of other combo boxes, defined in this report, and user can select any of them. As soon as any selection has been done in this combo box in real-time, the selected "child" combo box data will be refreshed.

In the **Timestamp** section user can define timestamp (**Date** and **Time**) for the defined entered values.

If check box **"This combo box is obligatory"** is checked, then selecting a value from this combo box is required for successful report validation. If a user will not select any value, he will not be able to complete the report. If this check box is checked, then a red **"\*\*"** mark will be displayed to the left from the combo box and, as soon as a user selects any value from the combo box, the **"\*\*"** will change its color to green.

If check box **"Add Default Value "<Not specified>"** is checked, then the combo box will be filled with all values according to its data configuration and one more entry- **<Not specified>** - will be entered in addition.

The **"Visible in PDF"** option controls whether this Combo Box object will be displayed in the generated PDF report or not.

If check box **"Autofilter"** is checked, then values in the combo box will be filtered automatically.

### Display mode

User is able to display a list box on a web report either as a standard list box or as a selection list. This can be configured by "Display mode" control:

The screenshot shows the 'Combo Box Configuration' dialog box. The 'Display Mode' section is highlighted with a red box, showing 'Display as List Box' selected in the dropdown and the 'Multi-selection' checkbox checked. Other sections include 'Object name' (TP\_TagSelector), 'Data Configuration' (Select Data Source below, External History Server), 'Assign Selection to Tag' (HDA Item), 'Send Result To' (TP\_TagSelector), and 'Timestamp' (Date: <Current Time>, Time: <Not Used>). Checkboxes for 'This Combo Box is Obligatory', 'Add Def. Value '<Not specified>', 'Visible in PDF', and 'Autofilter' are also present.

If **"Display as List box"** option is selected, then a standard list box will be displayed.

If **"Display as selection box"** is selected, then each entry in a list box will be displayed as a selection button (radio-button, if **"Multi-selection"** check box is unchecked, or as check boxes, if **"Multi-selection"** check box is checked).



## Action Button

**Action Button** is a dynamic interactive object, which enables users to perform a pre-defined action, and is available ONLY in WEB reports (please also see [Manual Data Entry](#) section)

To add this object, click on the command button *Action Button* on the *Web Elements* ribbon icon on the horizontal toolbar in the Dream Report Designer Studio menu (see pic. below):

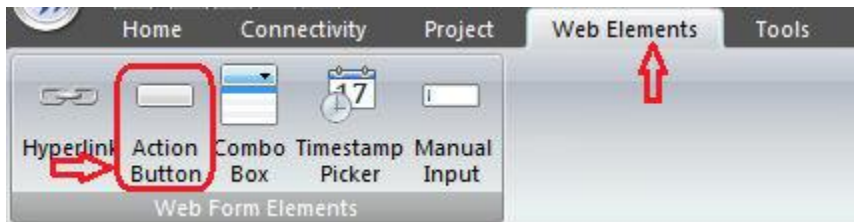

Add a button to the report and the following **Action Button Configuration** dialog box will be opened:

In this dialog window user has to define the name for the caption (**Button Caption**), select an action to be done when this button will be pushed (**Select Action**) and also configure **Action Parameters** (if needed).

Each defined action has its proper parameters for action. There are 10 actions available: **“Validate data”**, **“Submit Correction”**, **“Submit”**, **“Refresh report”**, **“Generate report”**, **“Login with different user”**, **“Logout”**, **“File transfer”**, **“Generate PDF”** and **“Reset web report data”**.

- If **“Validate data”** action is selected, there will be no special action parameters to configure. Access to the data validation action will be managed on the level of configuration of a user access to that report – only the supervisor login can access the validation of the report data.
- If **“Submit Correction”** action is selected, there will be no special action parameters to configure. User will only have to select the source (**Submit Source**) and the report fields will be checked for correct data in that source. If report validation has passed, the data will be recorded into the database (please see the pic. below):



Button Caption: Correct this Value

Select Action: Submit Correction

Action Parameters: Submit Source: cmb\_transfer\_id

- If **Submit** action is selected, there will be no special action parameters to configure. Report fields will be checked for correct data, and if report validation has passed, the data will be recorded into the database.
- If **Refresh report** action is selected, Dream Report will read all data entered manually (in edit boxes, combo boxes, tables etc.), calculate all statistical objects, located in the actual displayed report using that data, and refresh the data of all objects in the currently displayed web report. The *Refresh Report* dialog has 3 additional options (*Action Parameters*) for refreshing a report: **Report Instance**, **Make Dynamic Tag Replacement** and/or configure **Dynamic Parameters**, as shown below):

Button Caption: Refresh Report

Select Action: Refresh Report

Action Parameters:

Report instance:

- Default Instance
- Static Instance Name
- Instance from Object

Make Dynamic Tag Replacement

Get Tag List From: TP\_TagSelector

Dynamic Parameters

OK Cancel

If **Make Dynamic Tag Replacement** option is enabled, then the **Get Tag List From** combo box below will be filled with the list of all web combo box objects, which have the **Tags List** and **Report Instances** functions.

If in real-time (in a web report), the selected web combo box object has no selected value, the report will be generated without any dynamic replacement.

If, during report generation, the selected combo box has the value(s) selected, the report will be generated with original tags replaced by the web combo box selection: either by other tags (tag set), selected in a web combo box object, or by virtual report instance(s).

If user will click on **Dynamic Parameters** button, then the following window will be opened:

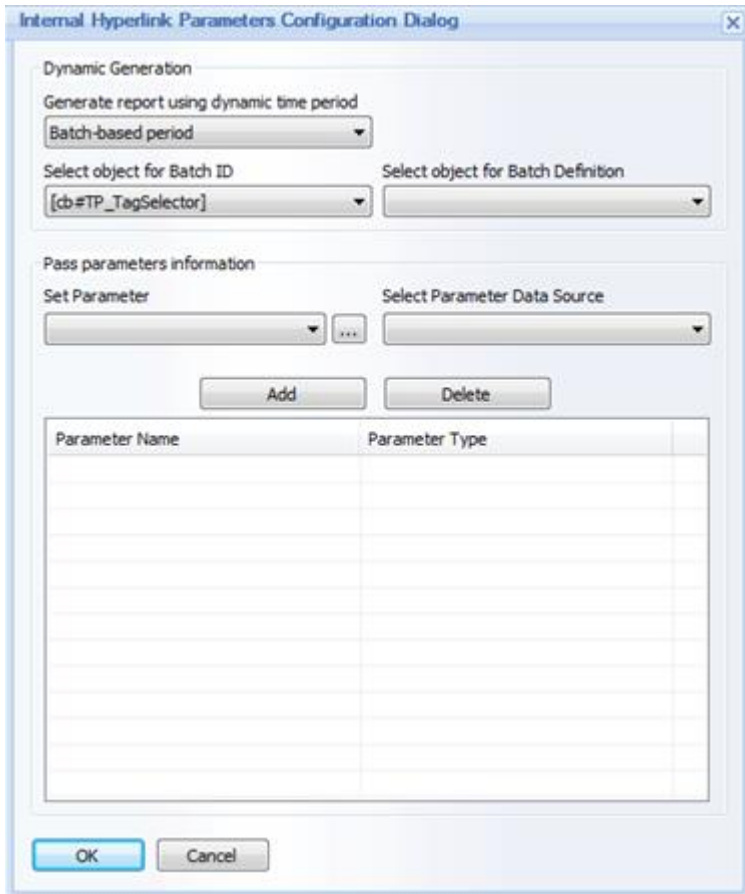

This window allows user to set dynamic time period parameters (either batch based or report start and time, coming from dynamic/calculation objects) as well as pass values to Internal Project Parameters for report generation.

The upper list box "Generate report using dynamic time period" has three available values:

- [Dynamic period is not used](#) - this option disable dynamic parameters for report generation.
  - [Batch-based period](#). This option enables users to specify object, which value will hold a batch ID. This list box will automatically contain the list of all *Single Data Object*, *Expression Object* and *List Box* object types, existing in that report. Content of any such an object can be used as a source for batch ID for report generation.
  - [Time-based period](#). This option enables to generate report using dynamic time period. If this option is selected, then user will be able to select the object for report start time and the object for report end time. *Single Data Object*, *Expression Object*, *Date/Time picker* and *List Box* object types are available for selection.
- 
- If **“Generate report”** action is selected, user will have to select a report and report instance (if defined), which will be generated (please, see the picture below):



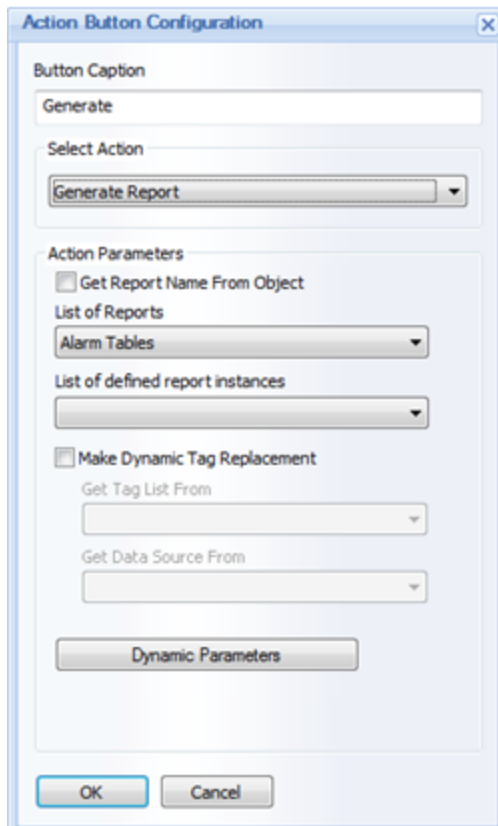

Dialog has the additional options for report generation: [Make Dynamic Tag Replacement](#).

By default this option is disabled.

If [Make Dynamic Tag Replacement](#) option is enabled, then the "[Get Tag List From](#)" combo box below will be filled with the list of all web combo box objects, which have the "[Tags List](#)" and "[Report Instances](#)" functions.

If in real-time (in a web report), the selected web combo box object has no selected value, the report will be generated in a hard copy (PDF/Excel) format without any dynamic replacement.

If, during report generation, the selected combo box has the value(s) selected, the report will be generated in a hard copy (PDF/Excel) format with original tags replaced by the web combo box selection: either by other tags (tag set) selected in a web combo box object, or by virtual report instance(s).

The report will be generated in PDF/Excel format for the selected batch definition.

Dynamic parameters button has the same functionality and enables the same operations, as described above in "Refresh" button function.

- If "[Generate PDF](#)" action is selected, then, when user will select this option, current report view will be saved as PDF in a PDF file in the reports folder. Report file name and location will be taken from the corresponding report settings.

**NOTE:** If you have Microsoft XP operating system installed on your PC, then, in order to define correct path to the place where generated PDF files will be stored, please go to the [Web Configuration](#) section of [Project Settings](#) and click [OK](#).



- If “**Login with different user**” action is selected, there will be no special action parameters to configure. The current user will be logged out. The general “Login” page (Web Portal Welcome page) will be opened, where user will have to enter login credentials.
- If “**Logout**” action is selected, there will be no special action parameters to configure. The current user will be logged out, and the Web Portal Welcome Page will be opened.
- If “**Reset web report data**” action is selected, Dream Report will read all data entered manually (in edit boxes, combo boxes, tables etc.), calculate all statistical objects (located in the actual displayed report using that data), and update/change the data of all objects accordingly in the currently displayed web report.
- If “**File Transfer**” action is selected, user will have to select a folder, where all client's selected files will be transferred to:

Select Action

File Transfer

Action Parameters

Select Folder to Transfer

C:\Data\DEF

When user will click on the “...” (browse) button, a standard Windows “**Browse for Folder**” window will be opened, where user can select any Windows folder, where files, selected on a web client side, will be transferred.

**NOTE:** When user will click on the “...” (browse) button on a web report, the “**Select file**” window will be opened, where user can select any single file (no filter by extension), and as soon as the file has been selected, it will be transferred to the server. A window with a progress bar and the “*Cancel*” button will be displayed until the operation is completed. **The maximum size of an uploaded file is 51200kB.**

- If “**SQL Query**” action is selected, then user can set SQL query and execute that SQL query when that button is clicked in a web portal. With that selected action, button will have the following configuration:



Select Action

Execute SQL Query

Action Parameters

Edit SQL Query

DSN: Process

SQL Query:

```
SELECT batchID, Username, Lot, Phase ID FRO
```

To edit SQL query user has to click on "Edit SQL query" button. Then selected DSN and selected SQL query will be displayed in the window above, just for information and for quick edit.

When user click on Edit SQL query, he will receive a standard "Edit SQL query" dialog window, which is described in details in its own section **Edit SQL Query**.



## Tree Object

The **Tree Object** is a dynamic interactive web object, which enables users to display the folder structure of a hierarchical tag source. The selected group, or sub-group, can then be used to filter an associated **Combo Box** which has been configured to display a tag/item list, or display the tags directly in the Tree Object. The **Tree Object** is available ONLY in Web reports. The **Tree Object** will be visible only in Web reports and will not be displayed in PDF/Excel reports.

**NOTE:** *In the Tree Object, only External History data sources are supported, in which the tags are organized or exposed in a “hierarchical” structure (as opposed to a simple or “flat” structure.) If you wish to show tags from any data source (Dream Report or External History) in the Tree Object, create a Data Model to organize the tags into a hierarchical folder structure.*

To add this object, click on the “**Tree Object**” command button on the **Web Elements** ribbon icon in the horizontal toolbar of **Dream Report Designer Studio**:

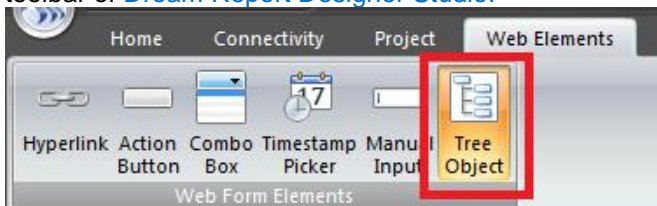

Draw a rectangle in the report workspace where the **Tree Object** will be displayed. The following **Tree Configuration** dialog box will be opened:

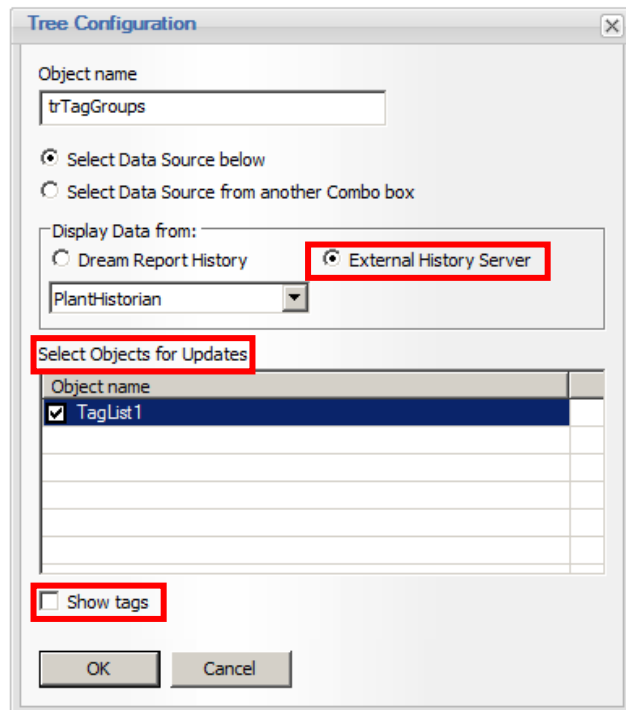

**Object Name** must be a unique logical name, which can be referenced by other objects within the project.



## Ocean Data Systems

The **Tree Object** can either access a specific data source, by selecting “**Select Data Source below**” option, or by selecting a data source dynamically at runtime, by selecting the “**Select Data Source from another Combo box**” option. Depending on which option is selected for the **Data Source**, select the appropriate **Data Source (External History Server)** or **Combo Box** from the “**Display Data from:**” section.

Finally, if you wish to dynamically update any associated objects (e.g., a list of tags in a **Combo Box** on the web report), make sure to **Select Objects for Updates**.

Click “OK” to close the **Tree Configuration** window. The Tree Object will display on the report (*trTagGroups*”), as shown in the left image below. The “**TagList1**” Combo Box object shown on the right of this image is associated with the “*trTagGroups*” Tree object.

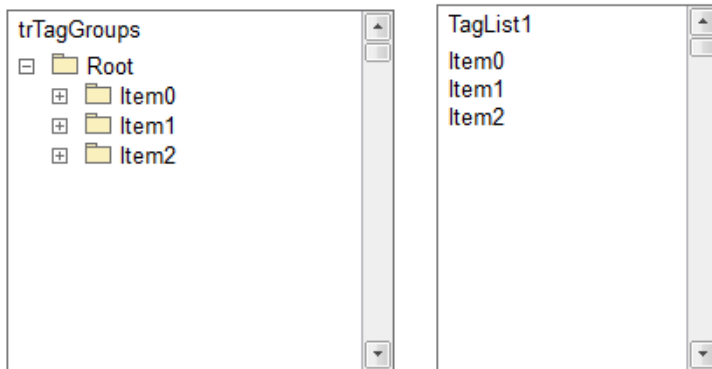

If you don't want a separate combo/list-box to display the tags contained in the selected folder in the **Tree Object**, check the **Show Tags** option in the Tree Object.

At runtime, on a Web report, the **Tree Object** will be populated according to the hierarchical structure of the data source. Double-clicking on a folder will either expand the folder to the next level, or display any tags/items contained in that group in any associated object(s), as shown:

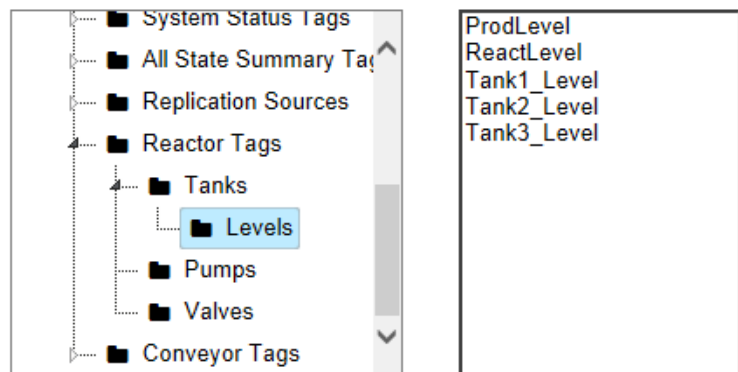

Or, if the **Show Tags** option is checked, folders and tagnames will be shown in the **Tree Object** on the web report:

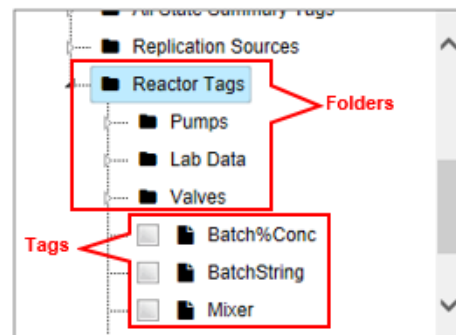



Ocean Data Systems

# Index



## Ocean Data Systems

### A

Absolute batch ID	168, 209, 245
Absolute date/Relative time	168, 209, 245
Absolute date/time	168, 209, 245
Absolute/Relative Period	168, 209, 245
Access to user definition	65
Account expires on	65
Activation	15
ActiveX	321
Add	80
Add Date/Time	78
Add Items	103, 173
Add Items to Group	103
Add New Page	114
Add New Text Object	121
Add Picture	119
Add Slice	213
Add template to existing report objects	277
Adding Image Picture	119
Address	360
Adobe Acrobat Reader	6
Adobe flash player	6
Advanced Mean Kinetic Temperature	129
Advanced PDF Security	84, 97
Advanced SQL Condition	164
Advanced Visualization	148
after report generation	95
Alarm Counter	129
Alarm Filter Manager	157
Alarm Group	110
Alarm Group Definition	110, 112
Alarm Table	202
Alias name for web server	55
All items	228
Analytical driver	365
Any database	341
apply a page template	274
Apply Correction Factor	172
Apply export to Excel settings	277
Apply report settings	277
Apply Report Template	277
as decimal separator	63
as digit grouping symbol	63
Automatic Statistical Table	180
Average	129
AXC_ODS_Generate	321

### B

Background	120
Background Colour	120
Background Picture	120
Bar Graph	219
Barcode	152
Batch Based	168, 209, 245
Batch Definition	149, 168, 209, 245
Batch duration	129
Batch end time	129
Batch ID	129
Batch start time	129
Batch-based period	267, 439
before report generation	95

### C

Calculated as Duration in	152
Calculated time period	168, 209, 245
Calling a stored procedure	194
Change report generation time	321
Chart	228
Chart name	228
Chart window option	228
Check IIS configuration on startup	55
checkup rate	61
Clear	184
Coarse	116
Column type	184
Column-Item database	341
Common Visualization Settings	63
Communication Driver Definition	100
Communication drivers development toolkit	401
Compound Data Object	143
Compound Object	143
Conditional calculations	144
Copy report files to report folder	73
Correction Factor	172
Counter	129
Counter of logged alarms	129
Counter of logged values	129
CPU priority	318
Create monthly subfolder	73
Create new history table for each day	52
Create new report	114
Create yearly subfolder	73
Current batch	168, 209, 245
Current User	159
Custom Archives Import	294
Custom Archives Import Tool	294



## Ocean Data Systems

Cut from beginning .....	59	Email.....	84
Cut from end .....	59	Email Configuration.....	89
Cyclic Report Generation.....	80	Email sender.....	89
<b>D</b>		Email subject.....	89
Daily.....	80	Enable Logging on Event.....	108
Daily or Weekly Report.....	80	Enable Record on Condition .....	108
Data Compression.....	52	Enterprise Information Integration .....	3
data retrieval mode.....	294	Evaluate.....	15
DATA SOURCE .....	100, 335	Excel.....	84
Database.....	3, 63, 112	Excel Data Import Driver .....	347
Database Configuration.....	52	Excel Format.....	86
Database Limitation.....	52	excel report layout wizard.....	84
Database Organization:.....	52	Excel Reports.....	86
Date Format .....	63	execute after report generation .....	95
Date/Time object .....	166	execute before report generation .....	95
Decimal Precision.....	152	execute on event.....	95
decimal separator.....	63	Execute Report at .....	80
Default database .....	52	Execute Report Each .....	80
Default language for web clients.....	55	Export Tables Headers .....	86
Default report in a web portal.....	69	Export Tables Titles .....	86
Define SQL Query.....	129	Export to static Excel file .....	86
Defined by data item.....	149	Expression Data Object.....	144
Delete.....	80	Expression Object.....	144
Delete current page.....	114	External History Server .....	129
Demo .....	4	<b>F</b>	
Demo license .....	15	Fastest entry item .....	228
digit grouping symbol.....	63	Fastest exit item.....	228
Display (.....	63	FIFO .....	59
Display options.....	55	File Name .....	159
Dream Report History.....	129	Find distributor .....	15
Driver Configuration.....	100, 335	Fine.....	116
Driver connection string.....	100	First value .....	129
driver development toolkit.....	401	Fit to data.....	228
DSN .....	52	Fit to time period .....	228
dummyalarm.cfg.....	396	Fixed.....	116
Duplicate group .....	103	Fixed Period.....	168, 209, 245
Duration .....	168, 209, 245	Fixed Period,.....	168, 209, 245
Duration in interval .....	129	Folder Selection.....	58
Duration in interval .....	129	Footer .....	274
Dynamic Parameters.....	267, 439	Free SQL Query.....	129
Dynamic Parameters button .....	267, 439	Free SQL Table .....	194
Dynamic period is not used .....	267, 439	Free Table .....	178
Dynamic Report Generator.....	321	Full File Name.....	159
Dynamic Text Object .....	159	<b>G</b>	
<b>E</b>		General.....	49
Edit List .....	202	Generate on event .....	82
Elements toolbar .....	129	Generate report after event with delay of.....	82





## Ocean Data Systems

<i>Generate Report on Event</i> .....	82	<i>Line Chart Appearance</i> .....	228
<i>Generation on Schedule</i> .....	80	<i>Local Database</i> .....	58
<i>GMT time</i> .....	52	<i>local time</i> .....	52
<i>Golden batch</i> .....	149, 168, 209, 245	<i>Log Alarms on Event</i> .....	113
<i>Grid</i> .....	116	<i>Log File</i> .....	59
<i>Grid origin</i> .....	116	<i>Log on Event</i> .....	108
<i>Grid spacing</i> .....	116	<i>Log out of range</i> .....	108
<i>Group</i> .....	103	<i>Log values in range</i> .....	108
<i>Group Definition</i> .....	103, 108, 112	<i>Logged value counter</i> .....	129
<i>Group Description</i> .....	103	<i>Logged Values</i> .....	173
<i>Group digits like</i> .....	63	<i>Logger</i> .....	100
<i>Group Name</i> .....	103	<i>Logger Studio Overview</i> .....	98
<i>Group Source</i> .....	103	<i>Logging Schedule</i> .....	105, 112
<b>H</b>		<i>Logout on user inactivity</i> .....	55
<i>Header</i> .....	274	<i>Logout on user inactivity after</i> .....	55
<i>Hotbackup</i> .....	61	<b>M</b>	
<i>Hot-Backup Configuration</i> .....	61	<i>Macro name</i> .....	95
<b>I</b>		<i>macros</i> .....	95
<i>Index Name</i> .....	78	<i>Mail Manager</i> .....	89
<i>Inhibit group logging</i> .....	108	<i>Mail server login information</i> .....	89
<i>Insert new page</i> .....	114	<i>Manual Configuration of the IIS</i> .....	417
<i>InSQL</i> .....	341	<i>Manual Data Entry</i> .....	213
<i>Installation</i> .....	6	<i>Manual Entry</i> .....	213
<i>Installation Tips</i> .....	6	<i>Maximum</i> .....	129
<i>Integral</i> .....	129	<i>MDAC</i> .....	6
<i>Internal database</i> .....	341	<i>MES license option</i> .....	15
<i>InTouch</i> .....	370	<i>Minimum</i> .....	129
<i>InTouch alarms</i> .....	341	<i>Minimum spacing</i> .....	116
<i>InTouch Native Drivers</i> .....	370	<i>Modbus</i> .....	360
<i>Item Field</i> .....	129	<i>Modbus Profiles</i> .....	360
<i>Item Group</i> .....	103	<i>Monthly</i> .....	80
<i>Item Table</i> .....	173	<i>Moving Average</i> .....	173
<i>Item Table Appearance</i> .....	173	<i>Multiple Field</i> .....	143
<i>Items Filter</i> .....	103	<b>N</b>	
<b>L</b>		<i>New Page</i> .....	114
<i>Landscape</i> .....	84	<i>New Report</i> .....	114
<i>Language</i> .....	63	<i>Normal</i> .....	116
<i>Language Selection</i> .....	63	<i>Normalized time sampling</i> .....	105
<i>Last batch</i> .....	168, 209, 245	<b>O</b>	
<i>Last value</i> .....	129	<i>ODBC Database</i> .....	52
<i>License</i> .....	15	<i>ODBC Driver</i> .....	341
<i>Life Sciences license option</i> .....	15	<i>OFF Counter</i> .....	129
<i>LIFO</i> .....	59	<i>On Change</i> .....	105
<i>limit by period</i> .....	52	<i>ON Counter</i> .....	129
<i>limit by size</i> .....	52	<i>On Update</i> .....	105
<i>Limit report files storage</i> .....	73	<i>ON/OFF Counter</i> .....	129



## Ocean Data Systems

Online Log File .....	59	Report Settings - Macros.....	95
Only for Current Page.....	120	Report Settings - Mail Manager.....	89
OPC .....	356	Report Settings - Printer Selection .....	91
OPC Core Component .....	6	Report Settings - Report File Format.....	84
OPC drivers set.....	356	Report Settings - Report Name Format .....	78
OPC Offline .....	331, 381	Report Settings - Report Time Definition .....	80
Open report file after generation .....	84	Report storage .....	73
Operations with strings .....	144	Report Templates .....	277
Option for Dynamic Generation .....	166	Report Time Definition .....	80
<b>P</b>		Result example .....	63
Page format.....	84	Result Representation.....	152
Page Number .....	162	Ruler Zero.....	116
Page Size.....	84	Rulers .....	116
page size and orientation.....	84	Runtime Engine .....	307
Page Templates .....	274	<b>S</b>	
Pareto graph .....	219	Save as report template .....	277
PcVue .....	387	save the current page as a template .....	274
PDF Security .....	97	Schedule.....	103, 112
Permanent license.....	15	schedule record .....	80
Pie Graph.....	213	Select Data Item .....	129
Pie Graph Name.....	213	Select Data Source .....	129
Portrait .....	84	Select database location .....	384
Printer .....	84	Select Dynamic Token .....	194
Priority Range.....	110	Select installed components.....	6
Project configuraiton file .....	58	Select language .....	65
Project Configuration Files.....	58	Select path for custom logo image .....	55
Project Name .....	159	Select path for custom skin images set .....	55
Project Settings .....	49, 58, 59	Select setpoint .....	228
Project Upgrade .....	11	Select Statistical Function .....	129
Protocol name .....	360	Select unit to add to result.....	228
<b>R</b>		Serial .....	360
Rate of Change .....	289	Set Background Colour .....	120
Rate of change after setpoint.....	289	Set Background Picture.....	120
Rate of change before setpoint.....	289	Set default web page as.....	55
Record Mode.....	105	Set this time period for all objects.....	277
Record Period .....	105, 112	Set Time .....	80
Record Time Schedule .....	105, 112	Setpoint .....	228
Redundancy .....	61	Setpoint Analysis .....	289
Refresh .....	55	Shell command .....	95
Relative date/Absolute time .....	168, 209, 245	Show absolute time on X axis .....	228
Relative date/time.....	168, 209, 245	Show relative time on Y axis .....	228
Replace existing report objects.....	277	Show report in the list.....	84
Report Name.....	159	Show Result As.....	152
Report Name Field .....	159	Show this wizard on creating new project.....	100
Report Output Format.....	84	Simulation Data Driver .....	396
Report Settings.....	3, 73	Simulation drivers .....	396
Report Settings - Generate Report on Event .....	82	Single Column.....	219



## Ocean Data Systems

Single Data Object .....	129	Timestamp of maximum .....	129
Slowest entry item .....	228	Timestamp of minimum .....	129
Slowest exit item .....	228	timestamp resolution .....	52
SMTP .....	89	tolerance .....	105
SMTP Server .....	89	Tolerance on abs. value .....	105
software protection .....	15	Tolerance on percentage (%) .....	105
SQL condition .....	164	Toolbars .....	121
SQL Macro .....	95	toolkit .....	401
SQL Query .....	129	Total pages .....	162
SQL Query Table .....	194	Transport layer .....	360
SQL Table .....	194	Trial License .....	15
SSL .....	89	<b>U</b>	
Standard deviation .....	129	UHH History files .....	384
Static Name .....	78	Uninstall .....	9
Static Objects .....	118	Units .....	152
Station Name .....	55	Upgrade .....	9
Step data .....	184	Use ( .....	63
Step end time .....	184	Use GMT time .....	52
Step start time .....	184	Use local time .....	52
Step Table .....	184	Use multi-session log file .....	59
Store files for period of .....	73	Use original time period .....	321
stored procedure .....	194	Use particular template file .....	86
Subdivisions .....	116	Use query directly .....	194
Subscribe .....	360	User Authorization .....	65
Sum .....	129	User Management .....	65
System availability .....	129	User name .....	89
System Integrator Pack .....	15	User rights .....	6
System Requirements .....	4	<b>V</b>	
<b>T</b>		Value based .....	228
TCP/IP .....	360	value range .....	173
Temporary license .....	15	Version Control .....	72
Test Connect .....	360	Visible .....	152
Test Connection .....	61	Visual C++ Runtime Redistributable .....	6
Text Direction .....	121	Visual Query Builder .....	194
Text Object .....	121	<b>W</b>	
Time based .....	228	Web Configuration .....	55
Time Definition .....	80	Web Portal .....	402
Time Format .....	63	Weekly .....	80
Time period .....	168, 209, 245	Weighted average .....	129
Time Period Definition .....	168, 209, 245	when there is no value .....	63
Time replacement .....	277	Wizcon communication driver .....	394
Time-based period .....	267, 439	Wizcon drivers .....	394
Timeouts .....	55	Wonderware OPC Driver .....	373
Timestamp Format .....	219	Write Result Back .....	152
Timestamp is in UTC format .....	149	WW Historian .....	377
Timestamp of first value .....	129	<b>X</b>	
Timestamp of last value .....	129		



**Ocean Data Systems**

X Axis settings.....228      Yearly ..... 80

**Y**