

Drive smarter business outcomes with advanced automation and control



PACSystems™ Industrial Automation & Control Overview
Leverage data from the control room to the machine edge for improved efficiency.



Are you keeping pace with the speed of industry change in today's world?

The increasing rate of industrial change is placing great stress on operations that are weighed down by obsolete legacy systems and technologies that can't adapt to present and future needs. Plants and operations are faced with the need for shutdowns and expensive revamping to keep pace with the demand for automation and data analysis, and yet don't have the talent or budget to make the required changes. It's time for a better, more realistic approach to IIoT and advanced automation control.

"48% of customers have a talent gap for gathering and consolidating disparate data."

– Frost & Sullivan



"30% of all applications will be processed at the industrial edge within five years."

– Frost & Sullivan



"Plant downtime costs on average about \$12,500 per hour. Of course, these costs will be much higher for some plants and lower for others."

– ARC Advisory Group



"The average cost of a single data breach in America is \$8.19 million."

– IBM



What if you could connect your people, machines and data throughout your operations securely to drive greater efficiency, reduce downtime and increase productivity?

Bring your operations into a new era of agility and efficiency.

Your operations need an agile, efficient approach to plant modernization. Emerson's PACSystems™ industrial automation and controls solutions adds a new dimension to the industrial control and automation landscape, allowing optimized production, better connectivity, and precise control capabilities in a wide range of process and discrete industrial environments. Most important, PACSystems enables flexible, adaptable upgrades and expansions as your needs change and priorities shift. No matter how fast your operation is growing or diversifying, PACSystems brings control intelligence with a real-world approach closer to the industrial edge.



PACSystems automation and controls optimizes industrial processes safely, securely and reliably to give you peace of mind while helping realize higher performance of operations in any environment.



Keep your applications running reliably and securely.

Patented heat-transfer features and built-in redundancy help ensure high availability control in even the toughest operating conditions while minimizing the potential for mechanical failure.

Protect your industrial assets with a security solution.

Mitigate threats and protect against intrusions with a complete defense-in-depth strategy. Advanced security features verify the integrity of vital system components and help prevent unauthorized controller access.

Operate more efficiently with open exchange.

Communicate seamlessly with plant floor devices and supervisory systems to drive performance and optimize productivity using standard communication protocols for maximum interoperability and ease of use.

Optimize your operations with machine level edge insights.

Monitor, manage and adjust production on-the-fly using powerful edge technology. Manage critical assets and enable fast, informed actions with insights close to the source.

From the control room to the plant floor, PACSystems redefines the industrial edge.

In automation controls applications across all industries, ranging from process to discrete, expansion and diversification are driving the need for flexible, scalable control solutions. PACSystems solutions allow end users and OEMs to bring their operations into the modern world at a realistic and affordable pace, scaling and upgrading to meet the needs of today's buying trends and production realities. With connectivity at its core, the PACSystems devices and architecture reaches beyond conventional standards to anticipate trends and re-imagine the intersection of control, software, interfaces and devices to meet your future industrial automation and control needs.

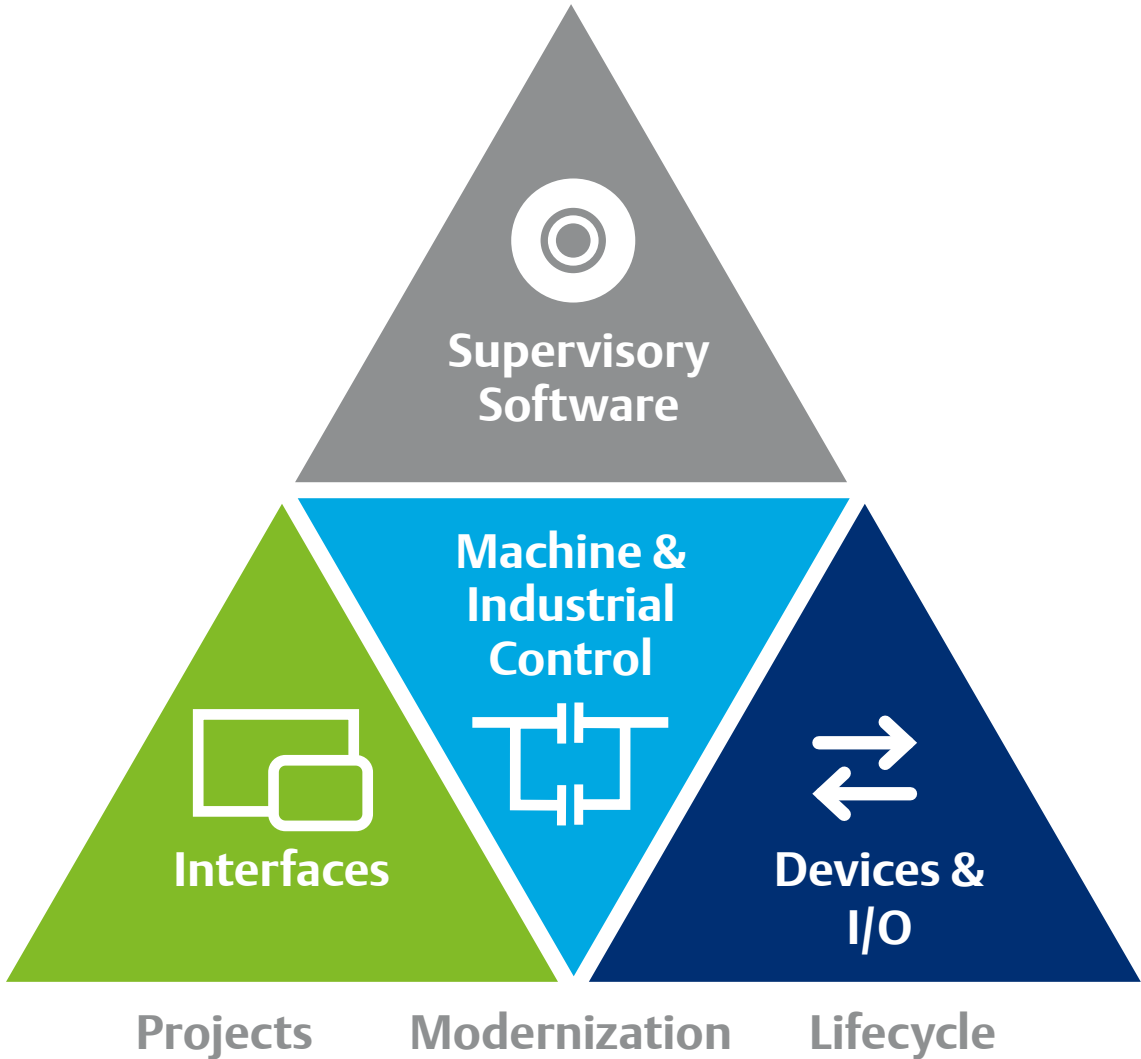

Supervisory software



Drive productivity and speed development with secure, collaborative and integrated control software. Program and configure PACSystems devices using native tools, open standards, and a fully integrated development environment. Apply version control and authenticate and secure communications using a common set of configuration tools.

Machine and industrial control



Tackle a diverse range of application requirements with the robust, reliable line of PACSystems industrial controllers. Delivering deterministic, high-speed control (from as low as 24 to over 32,000 I/O points), these best-in-class controllers are interoperable with most industry standards, redundant and secure by design, and operate without compromise in the most demanding conditions.

Interface

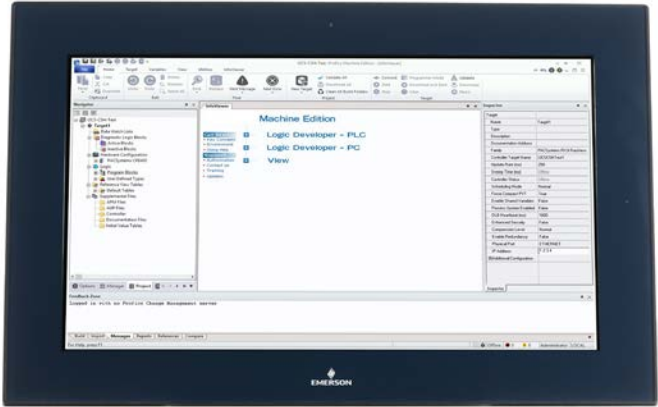

Give your operators fast, clear access to data with the PACSystems line of rugged industrial displays. The comprehensive portfolio of modular HMIs and touchscreen devices combines the ease of use of consumer-grade technology with the industrial-level durability needed for harsh environments. The modular design allows for easy scalability while built-in daisy chaining capability helps simplify connectivity and reduce costs.

Devices and I/O



Reap the benefits of best-in-class connectivity and continuous uptime with PACSystems PROFINET-based devices and I/O portfolio. Mix and match a variety of industrial I/O as well as other industrial devices to meet your unique application demands. The right I/O for the right job reduces component cost and installation time and optimizes ROI.

Flexibility and scalability allow you to reach and control areas of your operation easily and cost effectively.



SCADA

Supported protocols



Software solutions Machine Edition | PAC Security Center | PACEdge

Micro

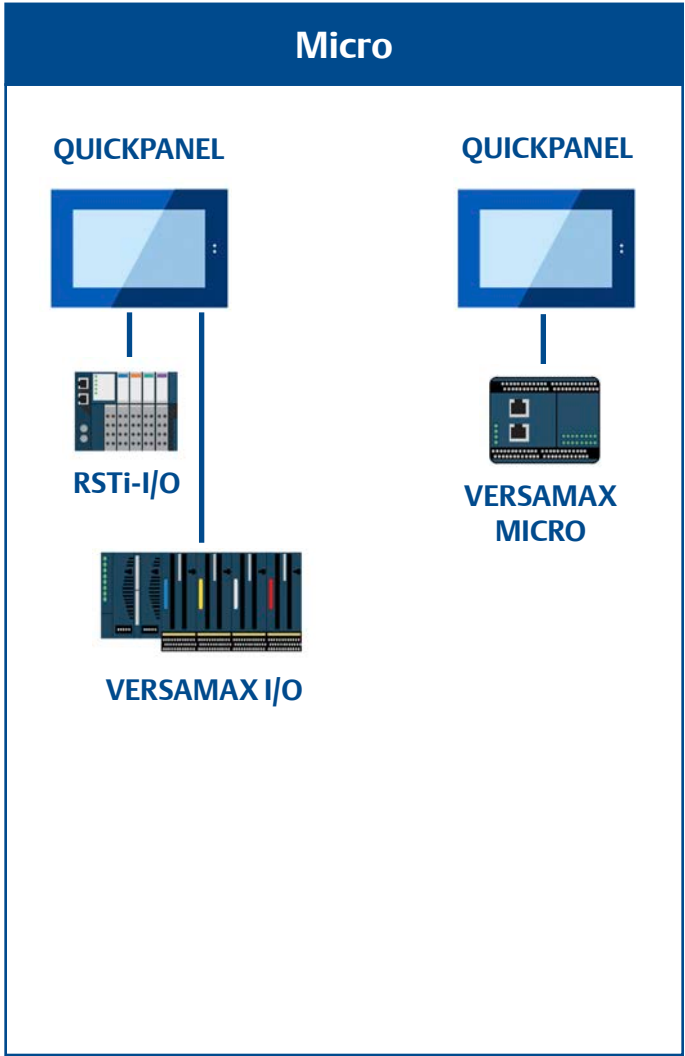

Compact

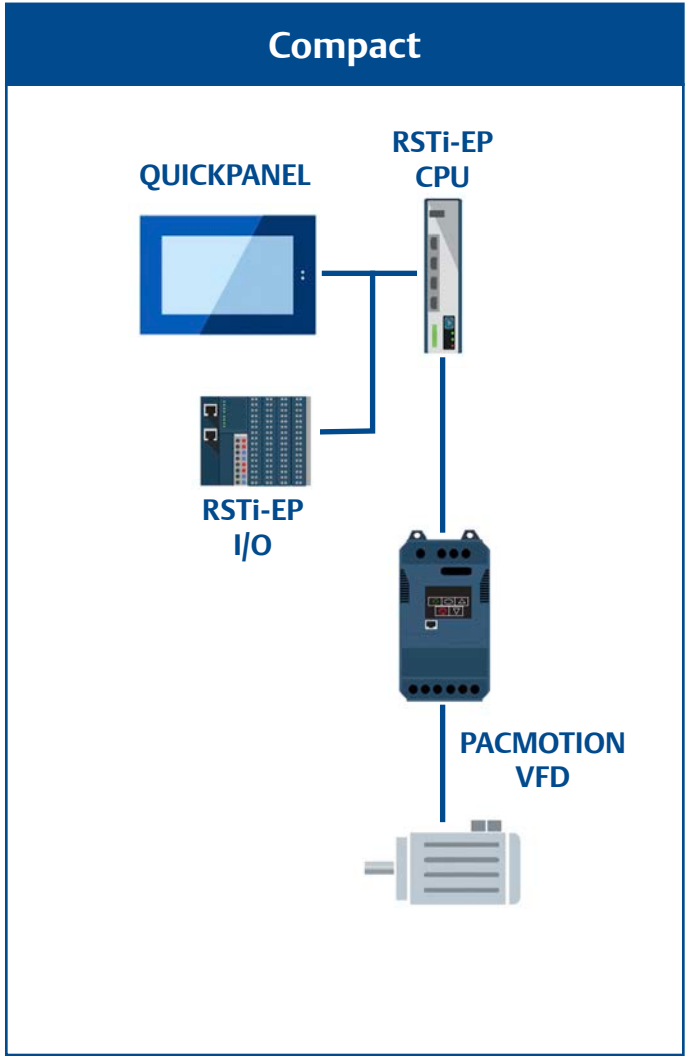

High performance

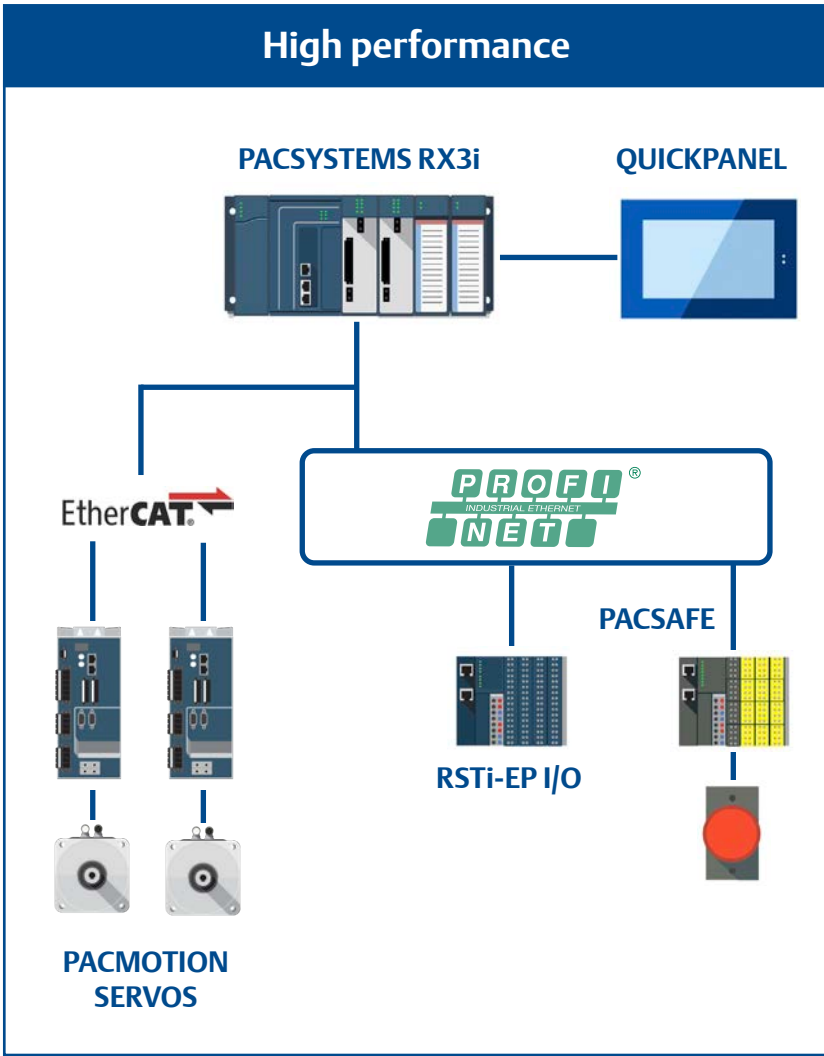

High availability

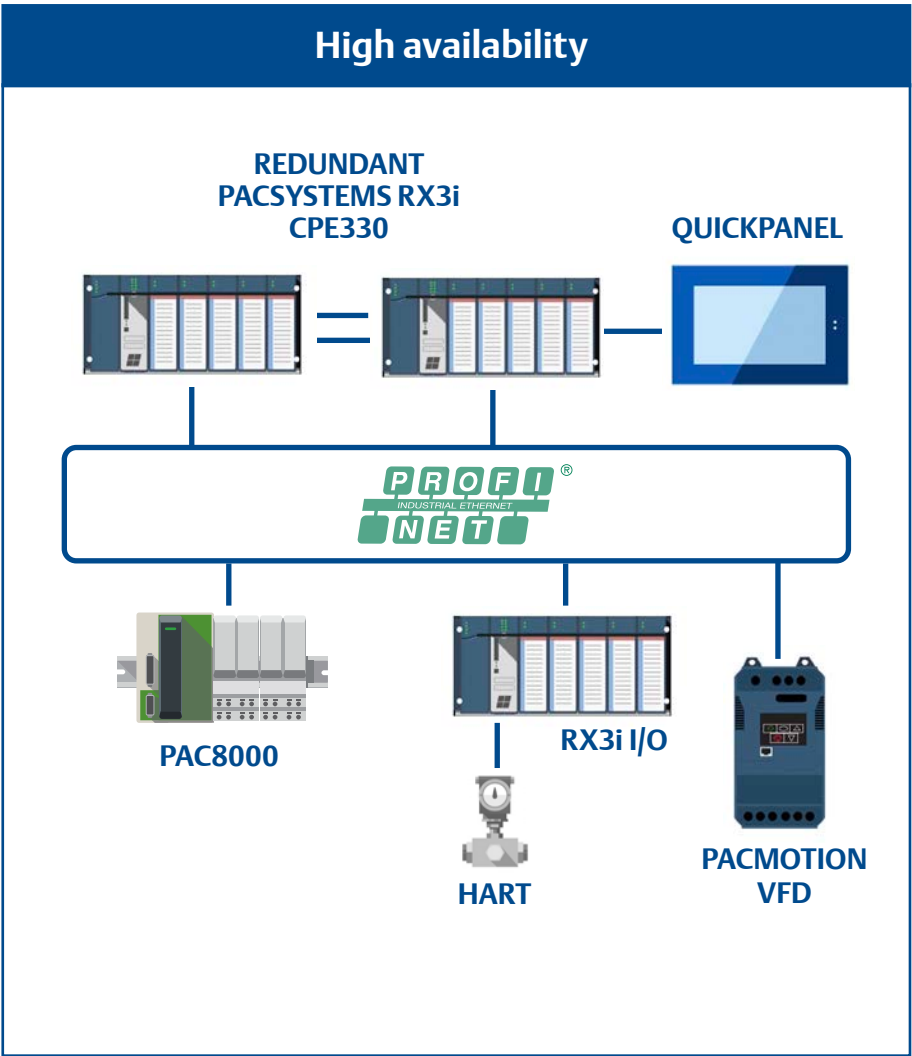

Today's operations demand a connected security strategy.

Today's industrial enterprises face increased security threats that can cause long-term damage. You need a dynamic, cohesive security strategy that is always evolving and is built into all layers, from the hardware and software to communications and the development process. PACSystems solutions are designed with extensive, multi-level security. It is secure by design so you can verify and validate the integrity of vital system components. It incorporates defense-in-depth to mitigate attacks and protect at every layer through robust end-to-end security. Secure communications helps prevent attackers from gaining unauthorized access to the controller.

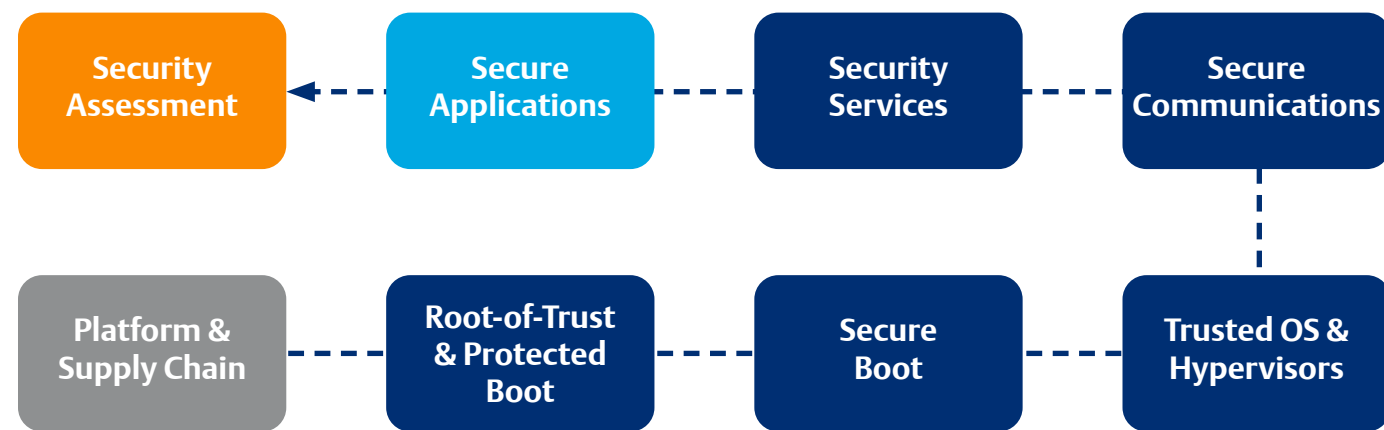

Hardware

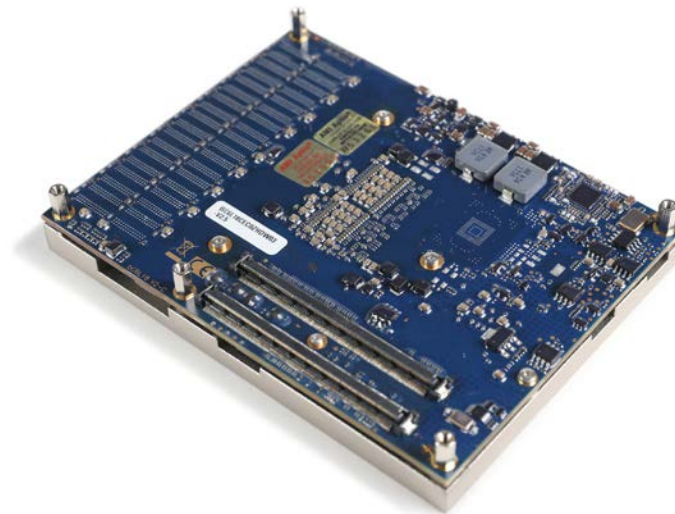

Emerson uses a secure-by-design philosophy in its PACSystems controllers, including Trusted Platform Module (TPM), Secure Boot and secure firmware updates.

Communications



PACSystems solutions are Achilles-certified and use OPC UA for secure communications.

Software

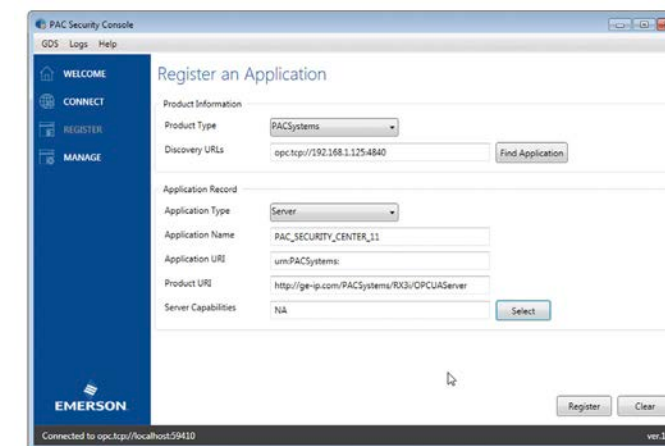

Secure access to the controller software is ensured with encrypted passwords, authorized access and access controls.

Secure development process

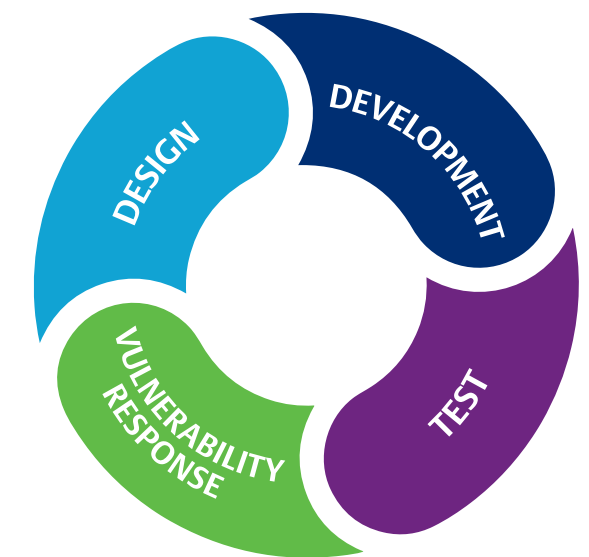

Emerson ensures a secure end-to-end development process throughout the product life cycle with security assessments and a product security incident response team.

What's your challenge?



The risks of intrusion and hacking are increasing and require advanced cybersecurity technologies.

What's your opportunity?



Built-in security at every layer helps secure systems from the start.



Reliable performance in the most demanding environments.

Today's diverse production environments can expose your control systems to the harshest conditions. Without rugged, durable controls that are up to the task, continuous exposure to high temperature, dirt, chemicals and vibration can result in component failure, downtime and high replacement costs.

Rugged design

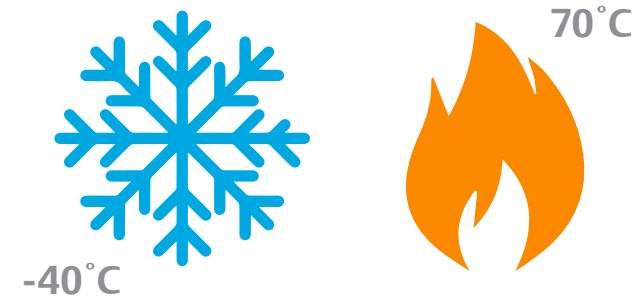

PACSystems solutions operate in the harshest environments without compromising performance. The widest operating temperature range available from -40° to 70°C and the humidity range from 5% to 95% non-condensing help assure availability everywhere.

Patented heat transfer

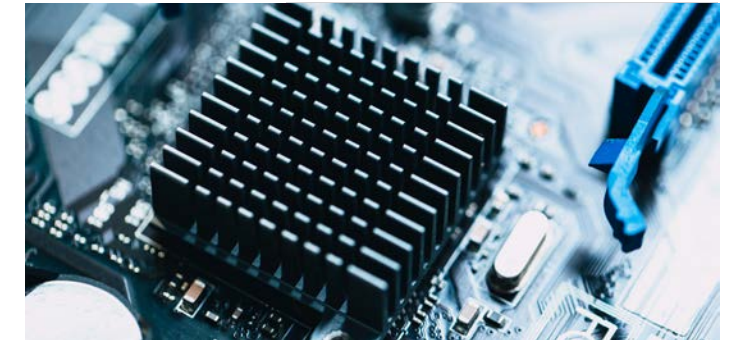

PACSystems portfolio handles extreme environments without requiring fans which can be prone to failure. Patented technology enables applications to run consistently at very high temperatures without impacting control performance.

Built-in redundancy



Redundant power inputs allow higher availability, reliability and productivity. Fast network recovery technology helps protect mission-critical applications from network interruptions or temporary malfunctions.

Vibration



Vibration-resistant components and connections help minimize failure points and ensure reliable operation in fast-moving, agitating or high-impact applications.

Conformal coating

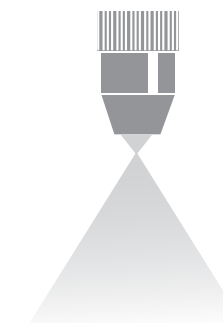

Non-conductive conformal coating provides electrical components with a protective barrier against contamination, moisture and corrosion caused by harsh or extreme conditions.

Certifications



PACSystems is certified to meet rigorous standards for reliable, robust performance, including UL Class 1 Division 2; ATEX Class 1 Hazardous Locations; and Security Achilles Level 2 certification.

Agile, adaptable PAC controllers allow you to expand and diversify to meet changing application demands.

Whether it's a small machine or a complete plant, PACSystems controllers let you choose the size of your controller and the optimal programming environment, while delivering speed, reliability and an unmatched level of security. With integrated control capabilities that can connect devices and machine-level data across all areas, PACSystems controllers help deliver high productivity and dependable performance in any environment.



Scalable automation

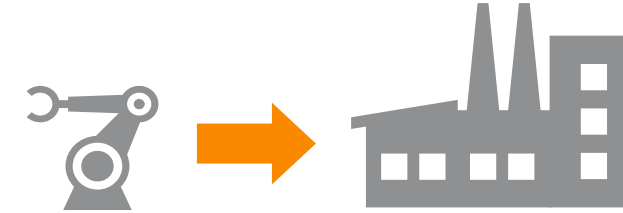

From small, compact applications to large redundant systems, PACSystems scales easily to grow to meet your requirements.

Deterministic high-speed control



Offering a base scan rate as low as 200 μ S, switchover as fast as 1 scan, high-speed coordinated multi-axis motion, and fully deterministic control, PACSystems meets the needs of today's applications.

Simplified programming



IEC 61131 languages with native support of C blocks enable modern programming and superior scalability, allowing you to download and reuse applications without additional configuration.

Flexible networking



PACSystems provides the widest range of communications options for maximum interoperability – DNP3, IEC 61850, IEC 104, HART pass-through, EGD, SRTP, Modbus-TCP/RTU, PROFINET, OPC UA.

Redundant by design



Built on a scalable, synchronized, redundancy control platform, high availability solutions provide uninterrupted control of your applications and processes.

Built-in security



PACSystems controllers are Achilles-certified and come with the latest security constructs, such as Secure Boot, TPM and secure firmware upgrades.

Industrial I/O: The right connectivity for the right application for optimal ROI.

Native PROFINET support gives the PACSystems I/O product line powerful mix and match capabilities, allowing you to select the right I/O size for the right job. Hot-swap capabilities improve availability while the compact footprint reduces component costs and enables more flexible installation closer to the application.

Distributed slice



RSTi-EP

On-machine distributed



VersaMax IP

Chassis-based



RX3i I/O

Intrinsically safe



PAC 8000



RSTi Slice I/O



RSTi-OM



VersaMax Modular



VersaSafe



VersaPoint

PROFINET technology



All PACSystems I/O product families support PROFINET natively, allowing any controller to communicate with any I/O family, and providing the best price and performance fit.

Remove complexity of field wiring



Consistent I/O cabling and streamlined commissioning speed maintenance and upgrades in the field.

Field device support

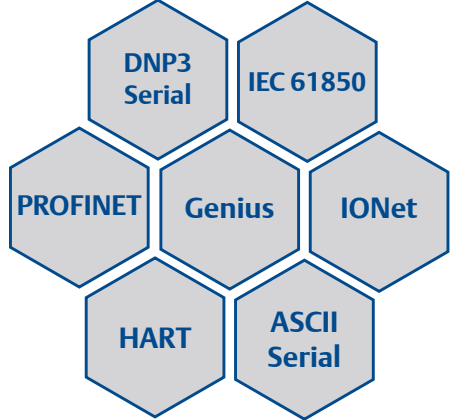

Multiple protocol support enables connection to a wide range of field devices.

Hot-swap capabilities



Hot swapping of I/O modules enables service activities to be performed while the system is still active.

Regulatory compliance



Our industrial automation and controls portfolio follows all local, national and international compliance standards.

Diagnostics

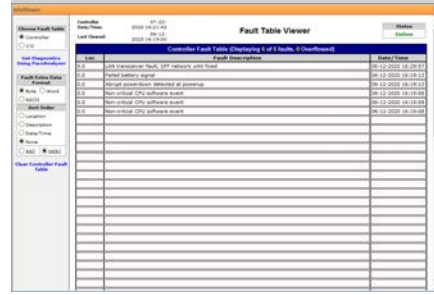

With PACSystems advanced diagnostics, failures in the system can be identified quickly, reducing any unplanned downtime.

Migration

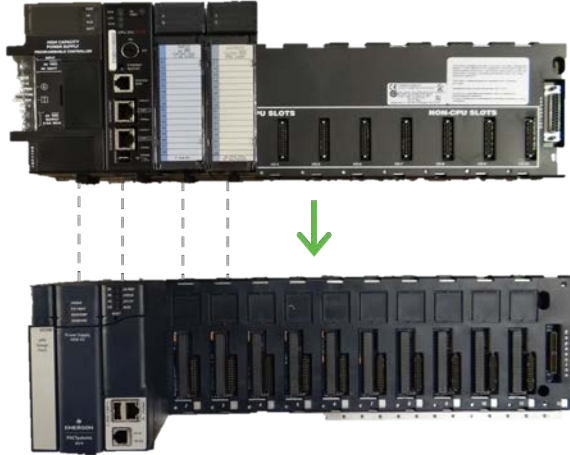

Emerson fuses high-density performance with modular, build-as-you-go flexibility to minimize space requirements without compromising on power. Same footprint and reuse of legacy I/O modules enables migration process to be completed in as little as 30 minutes.

PACMotion VFDs: Reduce energy costs, simplify configuration, gain flexibility and optimize operations.



Because motors require significant and costly electrical power, converting them to modern variable frequency drives (VFD) control is critical to your operations. But many installations require more than stand-alone VFDs. You want an integrated drive solution with your controls, to ensure the safety and integrity of your process and equipment. Durable, high-precision PACMotion VFDs help accelerate application performance in real time while reducing energy costs and increasing accuracy. Over-current protection and starting torque support help ensure reliable starting and accurate speed control for applications with variable loads.

Save energy and money

Reduce energy consumption



Controlling flow by varying motor speed reduces energy consumption and costs.

Adjust speed



In machine applications a VFD can provide the speed control, without the cost and maintenance requirements for a DC motor.

Lifecycle costs



Running at less than full speed reduces wear and tear on equipment, reducing maintenance costs.

Save space with compact drives



PACMotion VFDs are compact and take up less space in a control cabinet.



Easy access mounting slots make for quick installation.



IP55 and IP66 housings maximize design flexibility by allowing VFD installations closer to the machine.

Ease of configuration

Built-in keypad

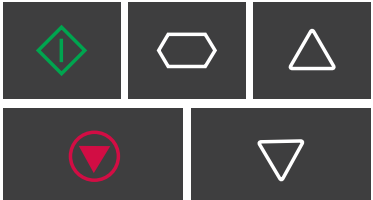

Allow operators to validate parameters, providing instant feedback during troubleshooting.

PAC Machine Edition

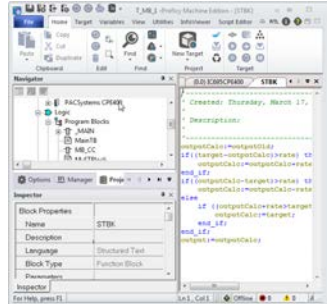

Product configuration embedded within PAC Machine Edition.

Bluetooth

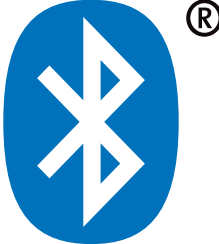

Bluetooth communication for operation using software and fast manual replication of parameter data.

PACMotion Servos: An integrated system for motion control.

PACMotion servo solutions provide users and OEMs with an integrated development, control, motion visualization and safety solution, all designed for efficiency, simplicity and rapid ROI. PACMotion combines an integrated motion and machine logic solution with the performance, flexibility and scalability required for advanced machine automation. Configured to provide the easiest integration and development, greatest precision and yield, and reduced maintenance, the PACMotion controller, servo drives and servo motors are designed to work together in applications from a few to up to 40 axes without performance degradation.



Higher throughput

High-performance motion controller



The unique design of the PACMotion controller backplane allows higher speeds than traditional networks. EtherCAT communications is updated every 250 μS, the position loop updated every 500 μS, and the path planner loop updated every 1 ms.

The power of motion control on the PLC backplane



The high-speed communications backplane delivers tight PACMotion integration of control and motion. Event and motion-timed interrupts execute logic independent of the standard PLC scan and from any onboard or remote motion I/O.

Higher yield

Higher accuracy



PACMotion provides 64-bit floating point precision for motion programming and control. Motion actions can be scheduled between path planner updates with microsecond accuracy.

Higher precision

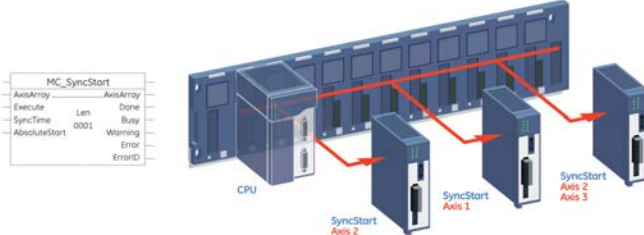

PACMotion allows a synchronized start of motion on up to 8 axes while patented technology provides faster settling to final motion positions and prevents material slippage at any point in the motion execution.

Reduced capital and operating costs

On-the-fly electronic reconfiguration



The highly flexible reconfiguration capability of PACMotion allows users and OEMs to change master axes, camming or gearing profiles on the fly. Rapid line changeovers enable shorter production runs and increased machine utilization.

Powerful diagnostics

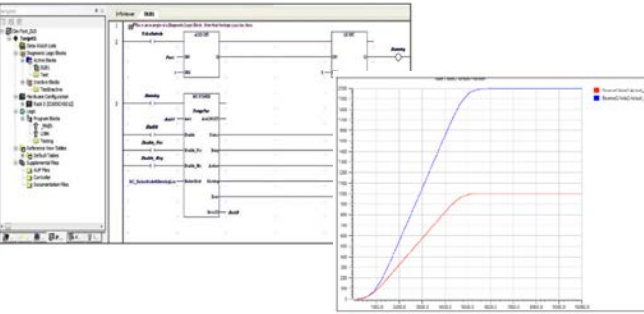

Debug motion applications directly from the PLC using integrated diagnostic logic blocks, saving time and retraining costs. Quickly validate machine operation by charting velocity, position and more with the integrated PME data logger.

Flexible servo programming

Open programming standards and a single programming tool help speed application deployment and reduce costs. Simplify synchronization of motion and machine logic to help ensure consistent performance regardless of axes count.

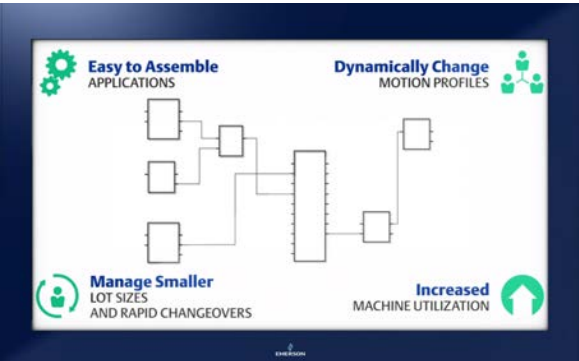

Machine Safety: Integrated SIL 3/PLe/Category 4 solutions for small to complex machinery.

Unlock the full potential of your control systems without ever compromising on operator safety. Our full range of scalable, flexible and reliable integrated safety solutions are intuitive and fast and are designed for single machine or complete plant safety. Connect machine-level data across all areas with integrated control capabilities for less downtime and reduced total cost of ownership.



Intuitive drag and drop programming

Hardware configuration editor

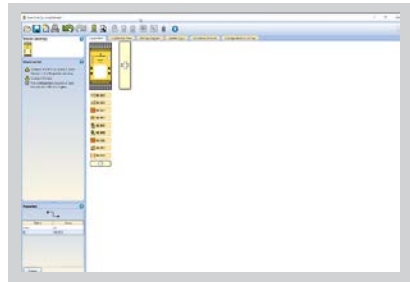

Simple graphic, drag-and-drop user interface eases the learning curve and speeds up commissioning.

Logic editor

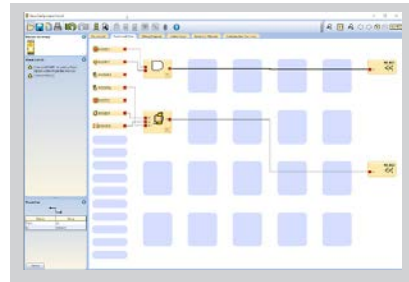

The software's simulation mode allows the user to test and see new configurations and modifications before implementation.

Standard PLC communications editor

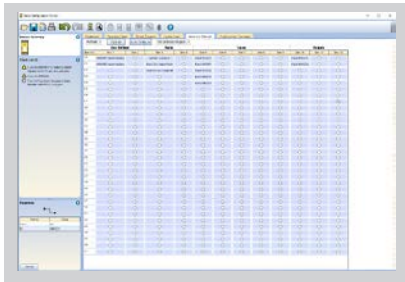

Automatically generates ladder logic as well as wiring diagrams to shrink time and minimize the risk of error. In addition, users can auto-configure communication protocols.

High performance for critical applications

Fast



With system safe state reaction times as fast as 15 ms, you'll no longer have to choose between performance and flexibility.

Achievable safety level

Safety Integrity Level
SIL 3
SIL 2
SIL 1

The Emerson machine safety solutions has been certified by TUV Rheinland as capable of being deployed for SIL 3, PLe or Category 4 machine safety applications in a variety of environments for operator safety.

Integrated, scalable solutions

Integrated solution

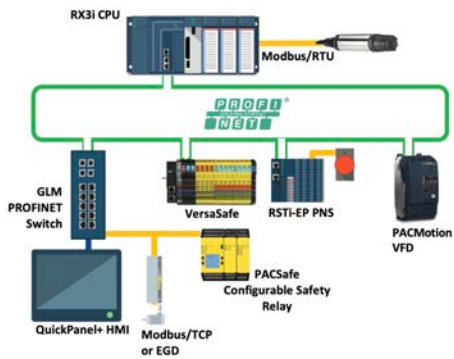

Safety is configured and managed right within PAC Machine Edition. Easy integration and monitoring from PACSystems and VersaMax controllers over standard industrial ethernet.

Scalable solution

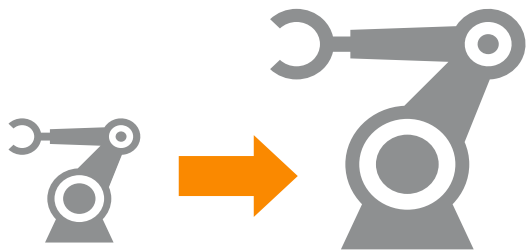

From single relays to distributed machine safety systems with up to 4,096 safety I/O points, Emerson can cover all your machine safety needs.

Industrial HMIs and Displays: Enhance visualization for increased efficiency.

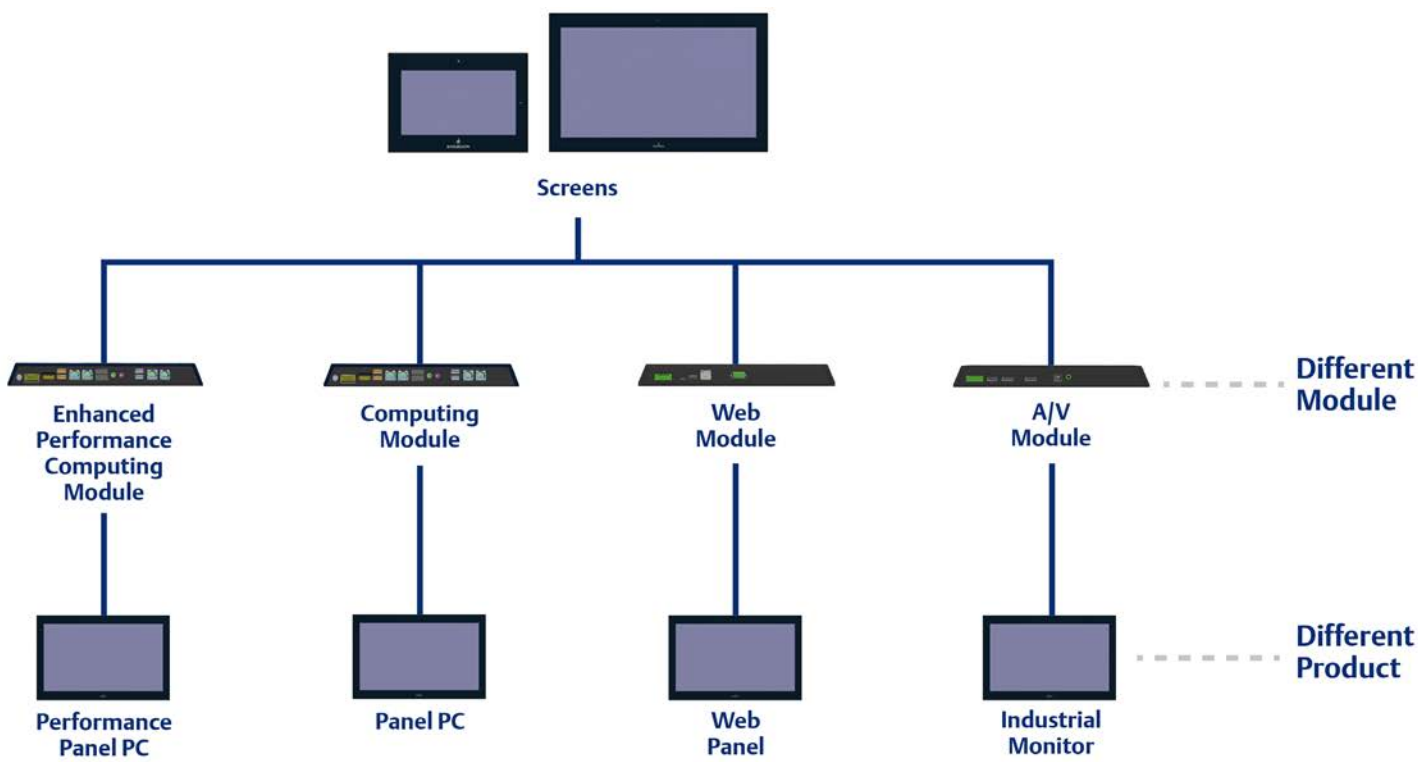

Modular to meet your needs today and for the future.

The concept of a modular family of industrial displays is a real-world solution to the display problems that plague you. Where do you need plain,

hardcore visualization and where do you need extra intelligence? Next-generation display solutions offer the exact performance and size required.



QuickPanel+ HMI automation panel

When customization and direct machine operation are required for specific applications, the QuickPanel+ operator interface is a multifunctional device that delivers actionable data and insight – smarter, faster and easier than ever before. It is also designed to work with Emerson PLCs and I/O, as well as numerous third-party providers, so you can operate faster and leaner and with increasing connectedness.

Intelligence



RXi Panel PC – With a complete operating system and open functionality.



RXi Web Panel – Provides cost effective, easy access to web-hosted HMI applications.

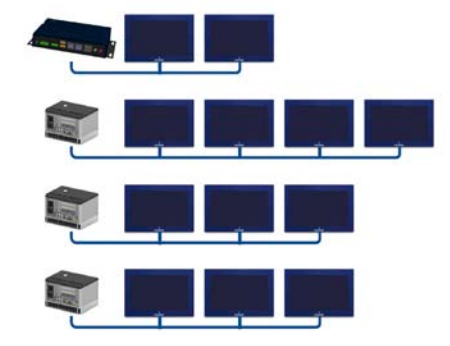

RXi Industrial Monitor – Take advantage of MST daisy chaining to simplify your system architecture.

Interchangeable sizes for maximum flexibility



Displays range from 7-inch to 24-inch screens in a widescreen format, with 7-inch to 15-inch models available with outdoor sunlight readable (SLR) screens.

Sunlight readable



Fully modular sunlight readable displays are available in 7-, 10-, 12- and 15-inch sizes with optically bonded screens that eliminate refraction. This design improves visual clarity by 20%, while clearly visible indicators show status at a glance.

Rugged



Rugged RXi displays resist scratching, chemicals and dirt, and operate in extreme temperatures and environments from -20° to 65° C and at altitudes up to 10,000 feet. Ten-point projective capacitive touch screens allow for operation with gloves.

PAC Machine Edition: The foundation for rapid development.

PAC Machine Edition provides users with a fully integrated development system so building HMI panels and controls logic is done in one easy-to-use environment. The entire automation portfolio is programmed, configured and maintained by a single toolchain, and preconfigured objects allow you to build applications rapidly.



PACSystems single software solution enhances productivity and speeds development.

Closing the loop between information and automation is one of the biggest obstacles to the fast, easy move into Industry 4.0. PACSoftware suite is designed to make closing that loop easy and straightforward. A single set of tools covers all controllers, with built-in safeguards assuring everyone is using the same data. Open standards allow seamless integration, while pre-defined re-usable modules get projects up and running fast with built-in security. PACSystems software dramatically reduces programming and configuration time and costs, so your team can be solving business problems from day one.

PAC Productivity Suite

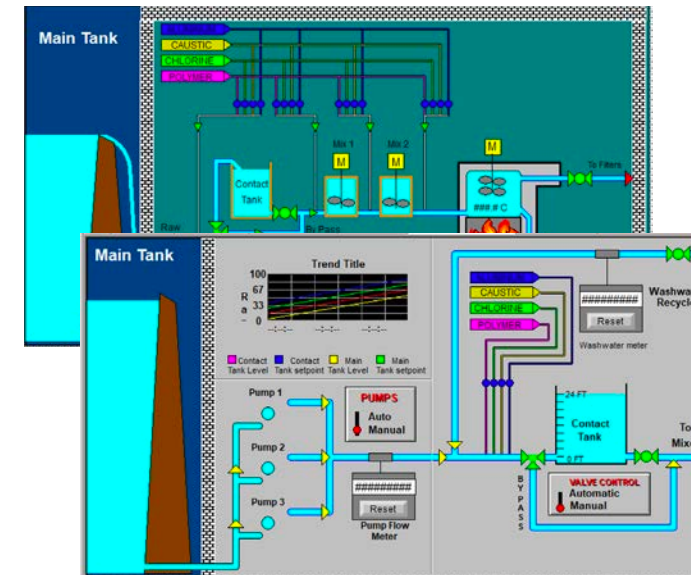

PACSystems Productivity Suite decreases development time by up to 40% by having a single point of configuration and a common database shared by the PAC programmer and SCADA application.

PAC Change Management

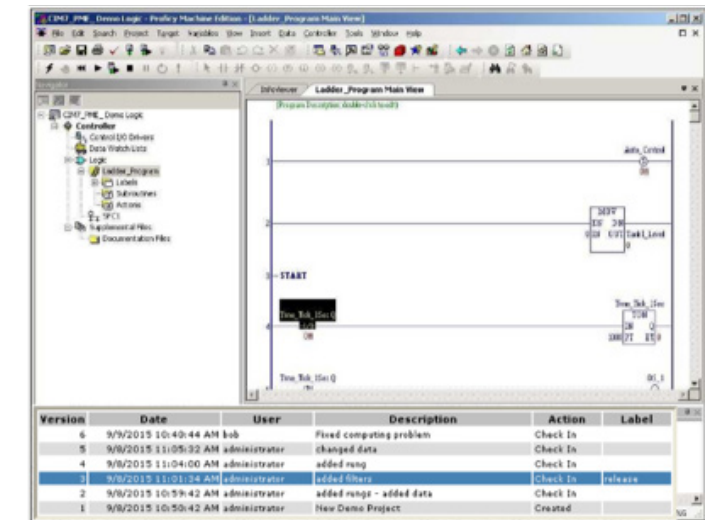

PAC Change Management keeps historical revisions with audit trails, multilevel permission control and electronic signatures, enforcing version control while keeping developers moving forward quickly.

PAC Security Center

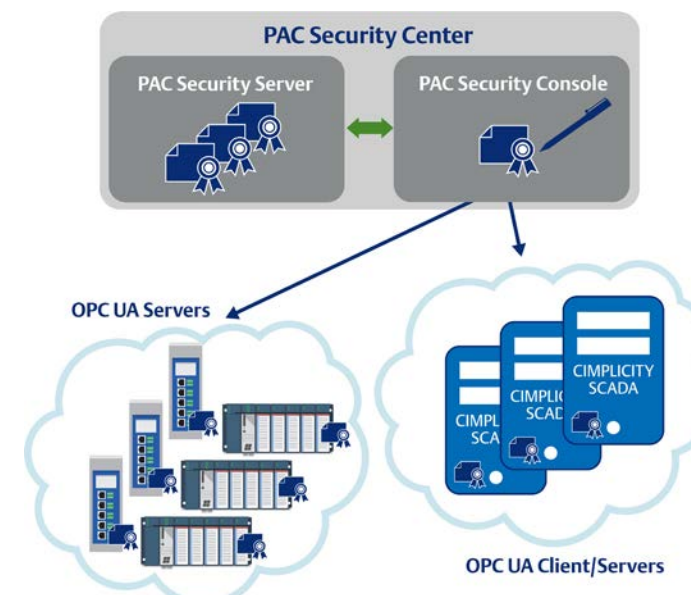

Easily deploy and manage OPC UA security for improved efficiency and reduced downtime. PAC Security Console and Security Server provide easy registration and management of OPC UA security certificates.

PAC HART Multiplexers

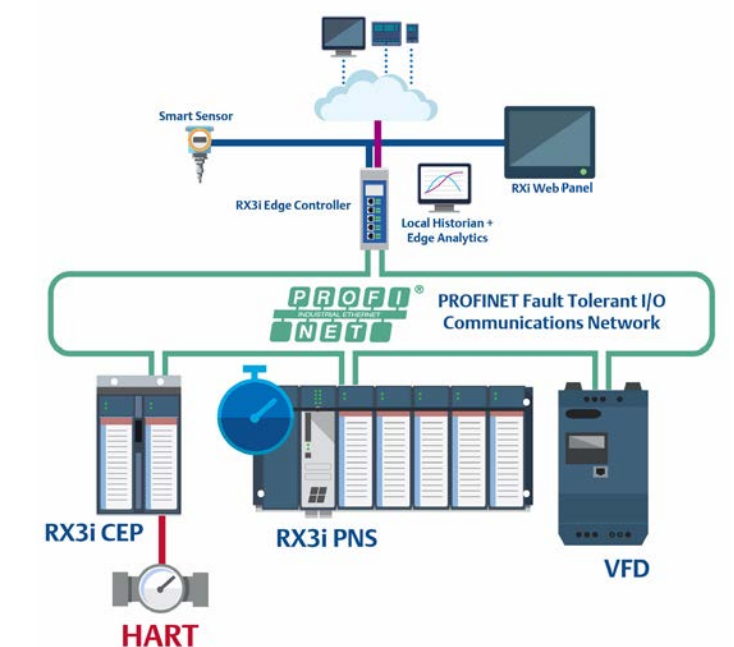



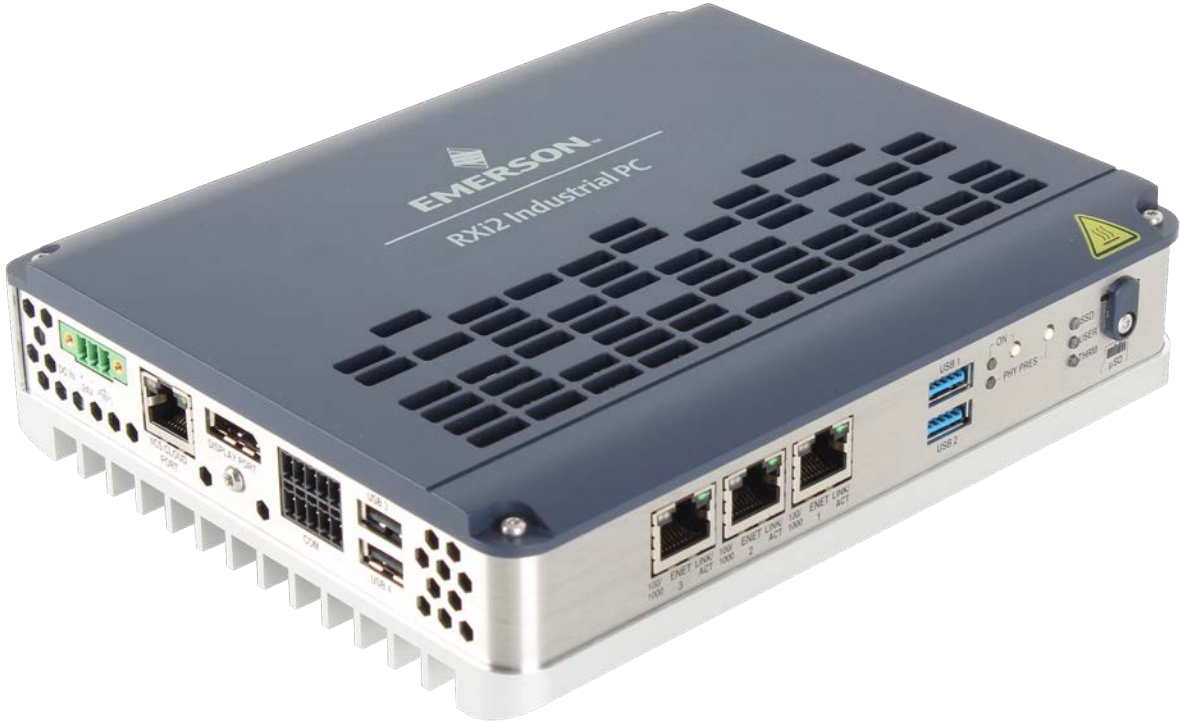

Communicate with HART devices attached to analog channels on PACSystems HART analog modules and through the Emerson Asset Management System.

Industrial PCs: Built for industry, high-performance computing right at the machine.

Collecting, processing and controlling data across the industrial internet requires high-performance processing power combined with industrial-strength capabilities. PACSystems RXi2 IPCs feature dual or quad-core processor technology and shock-resistant components for reliable, high-powered processing in demanding industrial environments. The result: fast data transfer, easy scalability and optimum ROI.



				
RXi2 – LP	RXi2 – BP	RXi2 – EP	RXi2 – XP	RXi2 – UP
Basic	Advanced		Premium	
Rugged computing at an attractive price.	High-performance analytics and graphics in an optimized package.		Premium performance, features and expansion for demanding applications with maximum flexibility.	

Built for industry

Extended temperature range



Perform in your toughest environments with industry-leading temperature options.

Ruggedized design



Rely on industrial PCs that perform when and where you need them, even in high shock and vibration environments.

Long lifecycles



Rely on the continuity and availability of our IPCs engineered for the long run.

Designed for reliability

Patented thermal design

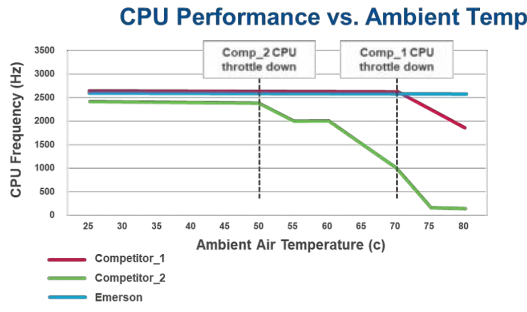

Operate your industrial PC at 100% CPU performance, even in the harshest temperatures, without the fear of throttling.

Emerson's proprietary thermal technology extends the life of your industrial PC by lowering the operating temperature of its components.

Fanless design and SSD storage



Reduce maintenance cost by eliminating moving parts prone to failure.

Purposed for deployability

PACEdge

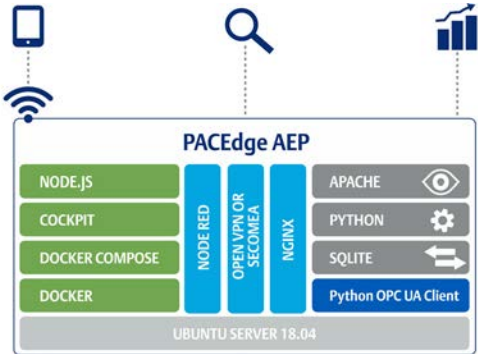

RXi2-BP and RXi2-LP models are available with Emerson's PACEdge software, pre-loaded and pre-tested to speed implementation time and get you to the edge faster.

Movicon.NEXT HMI/SCADA and IIoT software

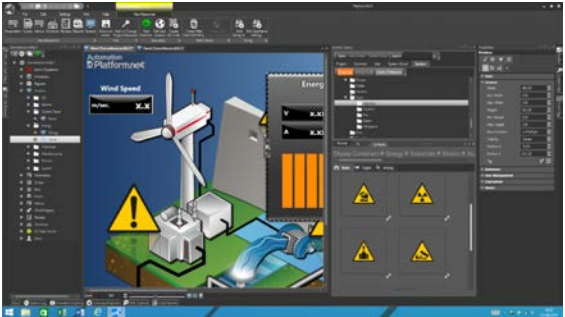

Get better insights and modern visualization with advanced plant analytics, HMI and SCADA software.

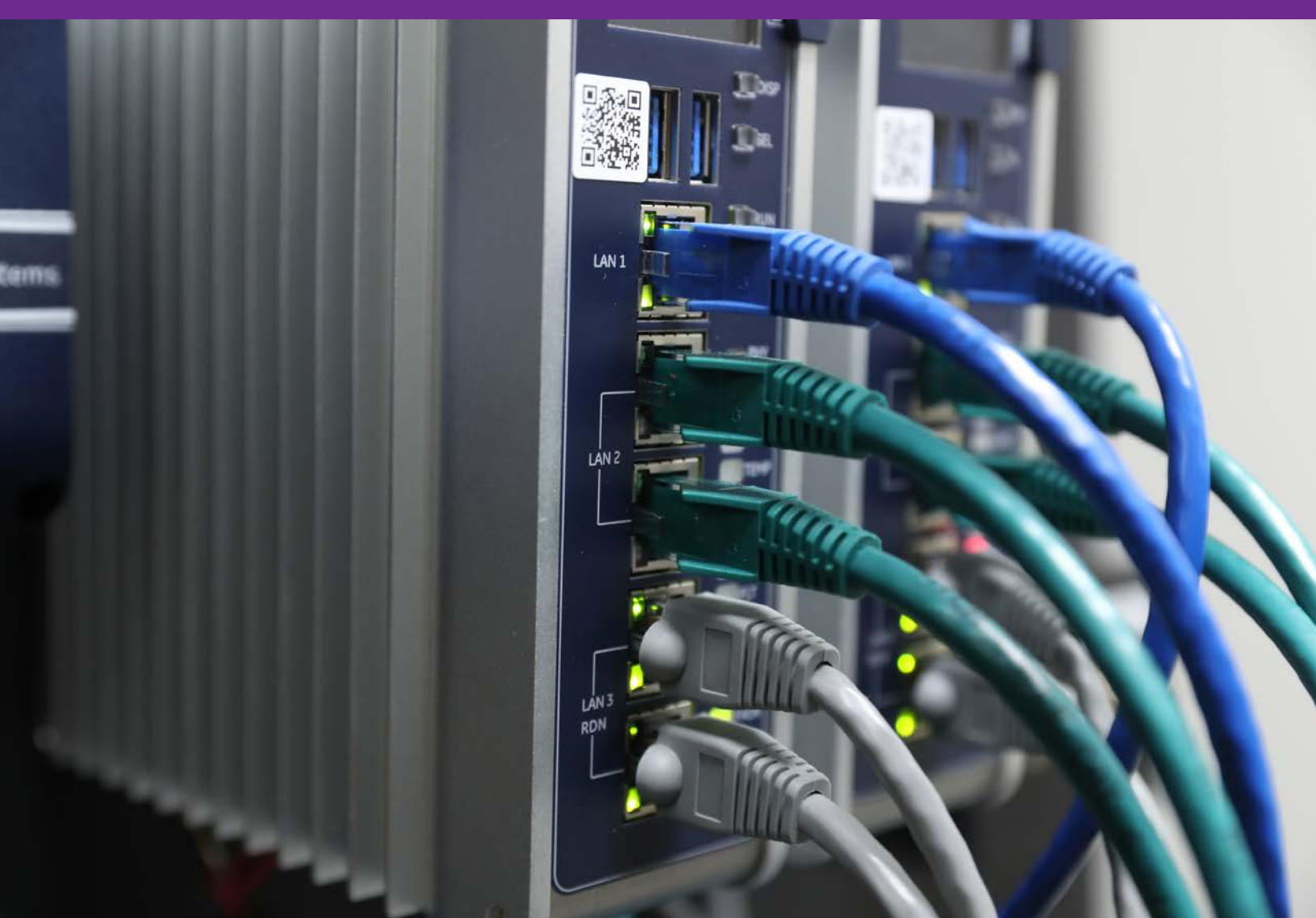

PACEdge: Respond quickly to changing conditions with machine-level insights.

While users and OEMs agree that the potential benefits of IIoT are immense, many don't have an affordable way to mine insights and solutions from the edge – where the critical machine data resides. PACEdge, with the unique PACSystems RX3i CPL410 controller, makes reaching and controlling the edge of your operations a straightforward, easily implemented process. PACEdge lets you begin where you are and scale as far as your operations and data demand. Choose your edge device and approach. With PACEdge, you command Industry 4.0 today.

Edge gateway

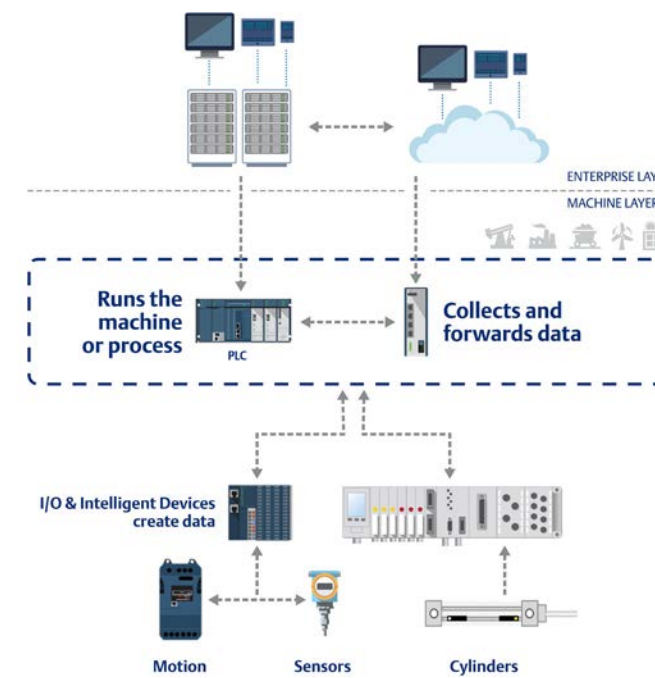

Edge gateways collect data locally and then forward it for processing on premise or in the cloud, while separating the PLC/PAC for deterministic control.

Edge computing device

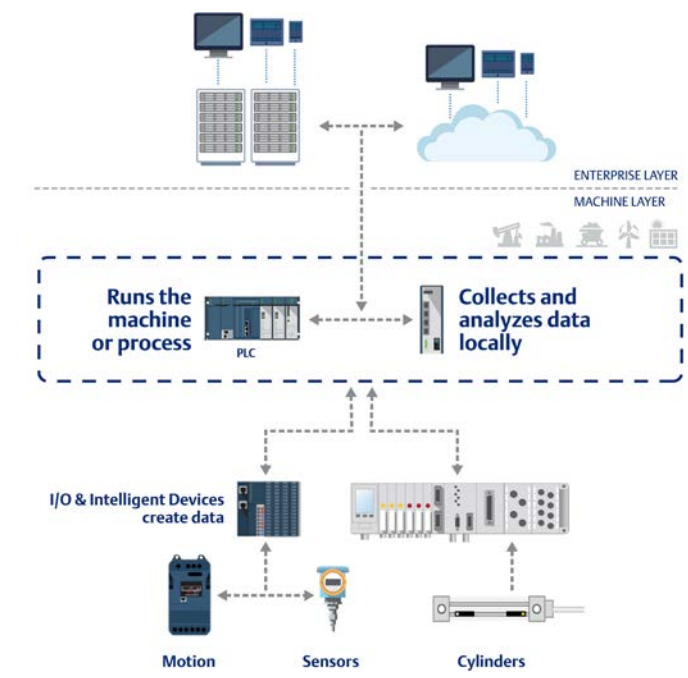

Edge computing devices both collect and analyze data locally, while separating the PLC/PAC for deterministic control.

Edge controller

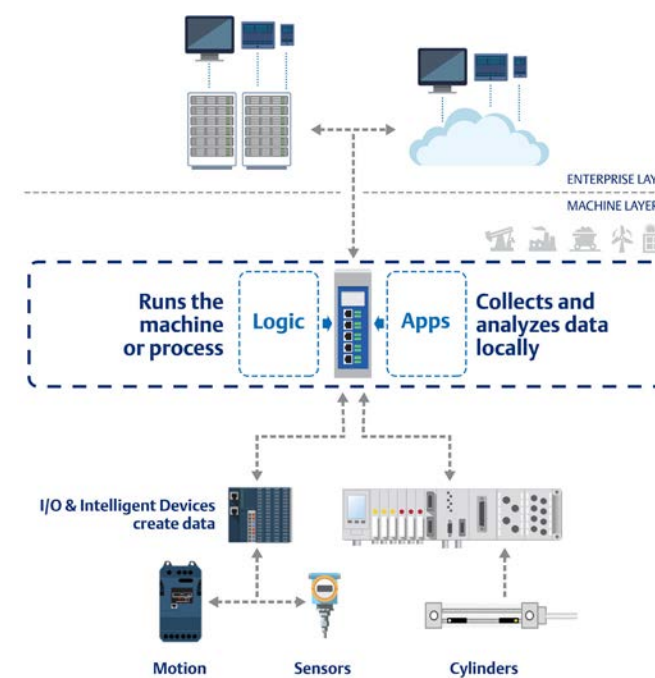

Edge controllers provide both fully deterministic control and data analysis at the machine edge all in a single box.

PACEdge software

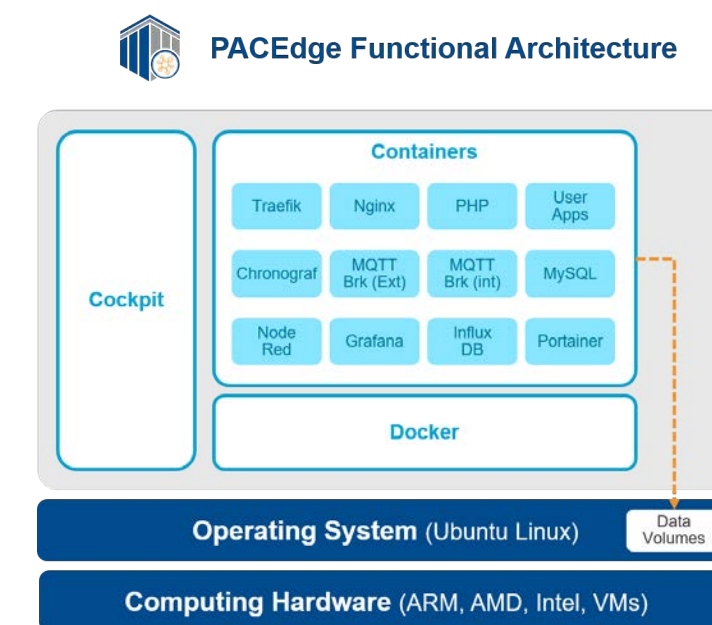

PACEdge software stack optimizes edge-to-cloud controls.

PACSystems RX3i CPL410 edge controller: A new generation of industrial edge control.

The PACSystems RX3i CPL410 controller provides the industry with true edge control technology, combining deterministic and non-deterministic real-time control in a single platform.



- Connect to your preferred cloud service or develop and run data processing Linux-based applications next to the control system to optimize processes and improve outcomes.
- Differentiate your machines with edge-level analytics and access to real-time information enabled by high-speed, deterministic control.
- By bringing edge-enabled data analytics together with real-time control, the PACSystems RX3i CPL410 helps drive new insights while providing built-in flexibility, operational efficiency, and higher asset performance.

Hypervisor technology combines logic and applications in one controller

The PACSystems RX3i CPL410 controller allows you to incorporate an “outer loop” and an “advise layer” on top of the typical “see-think-do” control loop. If the “outer loop” is disrupted, the real-time deterministic control remains unaffected.

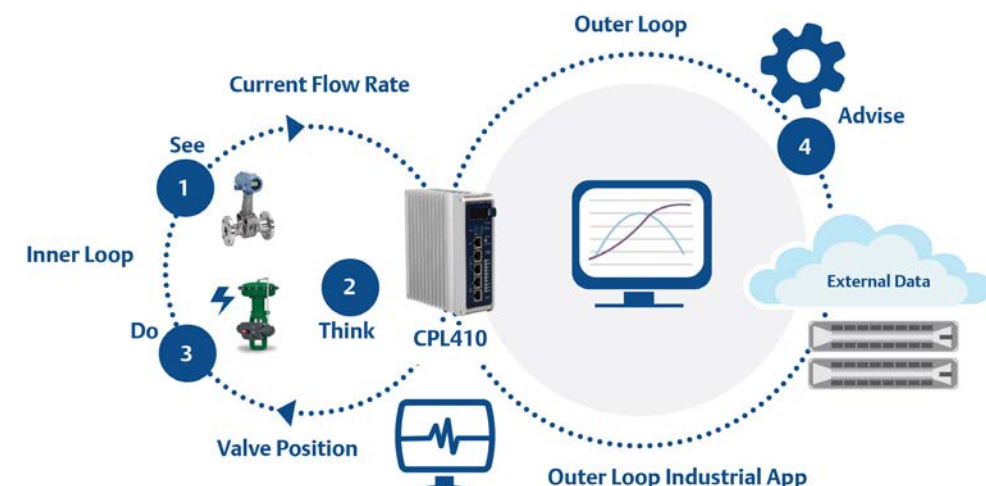

Enter the world of IIoT one manageable step at a time.



Big data can be a big problem when you try to tackle it all at once. Months or years of planning and expense may go into projects that end in frustration. But there’s a better approach. Start with little data – known problems with defined parameters. Focusing the field of view to a specific asset reduces complexity and simplifies the search for a solution. In most industries, this means starting at the machine or production-line level.

One of the main technologies for creating value from little data is edge computing. Data produced by field devices is analyzed by a field-located controller to generate insight. This information can be supplied to the right personnel close to the source for fast, informed action. With one problem solved, you can move on to the next. Edge computing, as realized in true edge control technology, makes IIoT a reality – today. It’s easy to integrate, without having to start over. It lets you enter the world of IIoT one manageable and affordable step at a time.

Opportunity Using Industrial Edge Controls



Optimize business outcomes with advanced control solutions.



PACSYSTEMS™

PACSystems is a unique line of control systems that increase productivity, flexibility and security, and enable users and OEMs to harness the power of IIoT.

**Emerson Automation Solutions
Intelligent Platforms, LLC**
2500 Austin Dr
Charlottesville, VA 22911
USA

**Emerson Automation Solutions
ICC Intelligent Platforms
GmbH**
Memminger Straße 14
Augsburg, DE 86159

**Emerson Automation Solutions
Intelligent Platforms
(Shanghai) Co., Ltd**
No.1277, Xin Jin Qiao Road,
Pudong,
Shanghai, China, 201206

Emerson Automation Solutions
Rua Irmã Gabriela, 51 –
Cidade Monções
São Paulo – SP, 04571-130

**Emerson Automation Solutions
Intelligent Platforms Asia
Pacific Pte. Ltd.**
1 Pandan Crescent,
Singapore, 128461

**Emerson Automation Solutions
Intelligent Platforms Pvt. Ltd.,**
Building No.8, Ground Floor
Velankani Tech Park, No.43
Electronics City Phase I, Hosur Road
Bangalore-560100



[Emerson.com/PACSystems](https://emerson.com/PACSystems)



linkedin.com/company/Emerson-Automation-Solutions



[Twitter.com/EMR_PACSystems](https://twitter.com/EMR_PACSystems)



YouTube.com/PACSystems

The Emerson logo is a trademark and service mark of Emerson Electric Co. All other marks are the property of their respective owners.
© 2021 Emerson Electric Co. All rights reserved.
00803-0100-0200



CONSIDER IT SOLVED™