

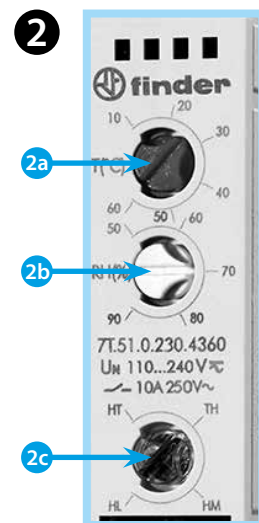

7T.51

	7T.51.0.230.4360 U _N 110...240 V AC (50/60 Hz)/DC U _{min} 88 V AC/DC U _{max} 264 V AC/DC P 1.8 VA (50 Hz)/0.44 W
	1 NO (SPST-NO) 10 A 250 V AC AC1 2500 VA AC15 (230 V AC) 250 VA DC1: 30/110/220 V (1/0.3/0.15) A (M) AC3 (230 V AC) 370 W
	-25...+60°C
IP20	

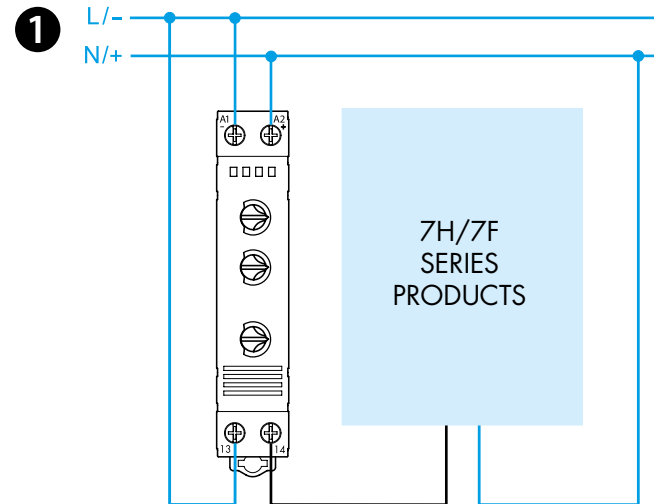
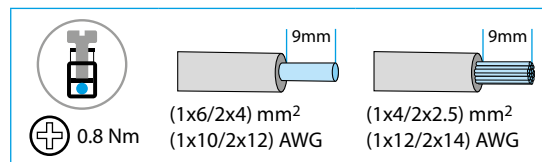
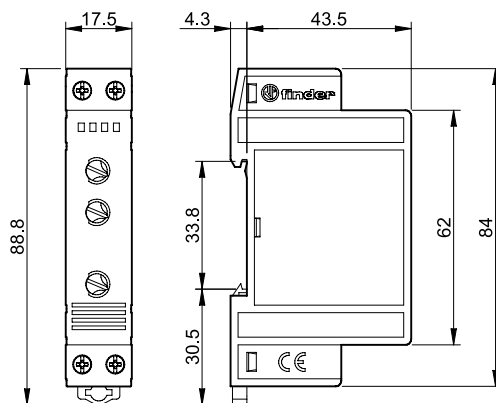

- Operating Control
- Incorporated Control
- Type 1.B action
- Pollution degree 2
- Rated impulse voltage 2.500 V

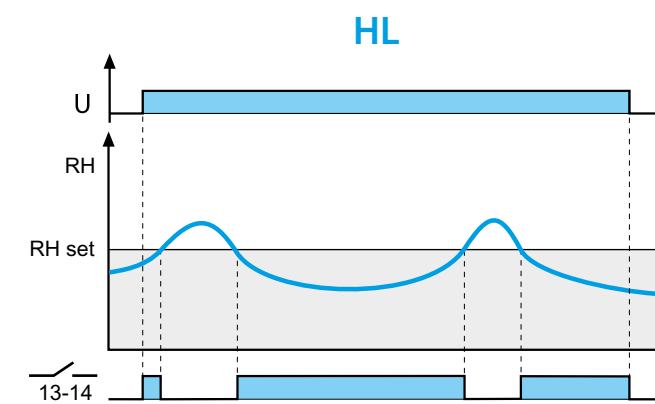
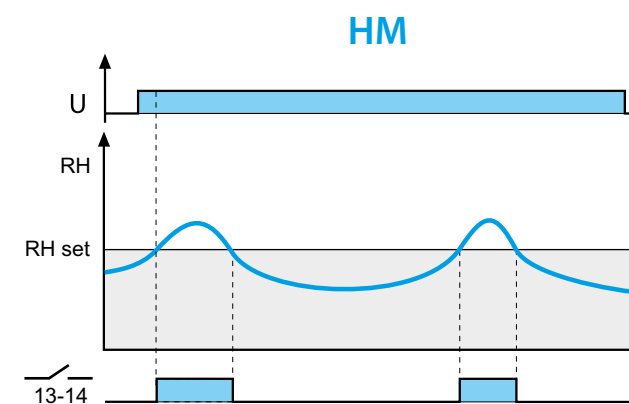
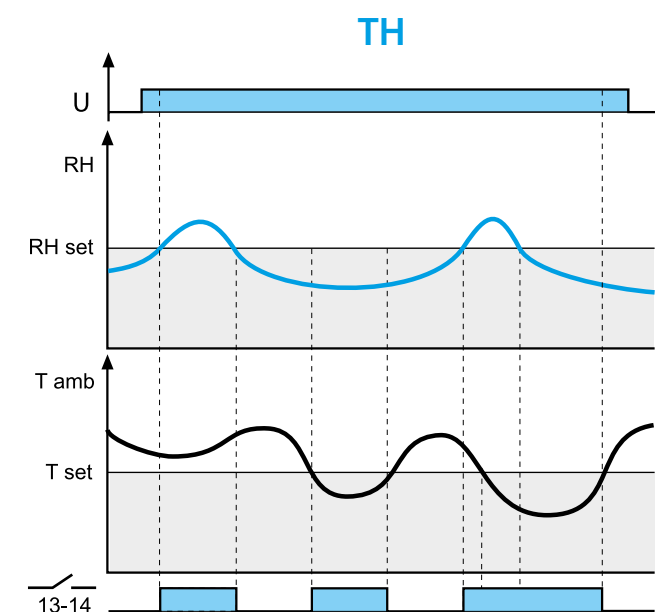
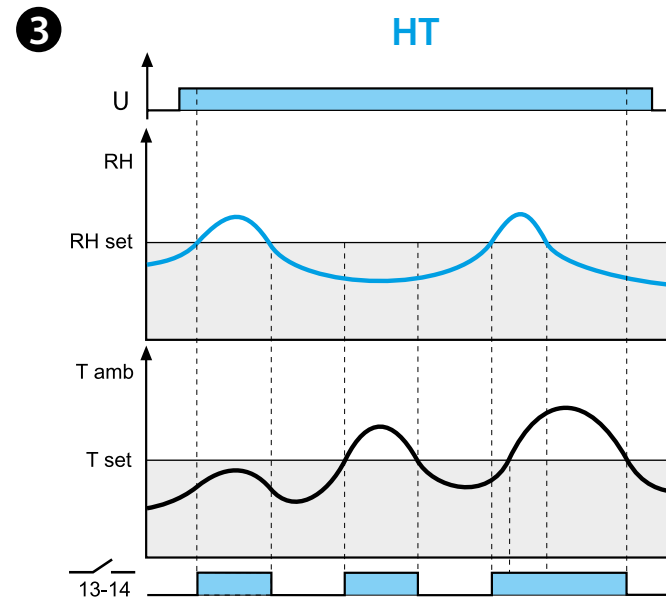

ENGLISH

7T.51.0.230.4360 THERMO HYGROSTAT

1 WIRING DIAGRAM

2 FRONT VIEW

- 2a** Temperature T(°C)
- Adjustable temperature control range + 10...+ 60°C
- Intervention hysteresis (temperature 4±2) K

- 2b** Humidity RH(%)
- Adjustable humidity control range 50...90%
- Intervention hysteresis (humidity 4±2) %
- Operation with humidity up to 90%

2c Functions: HT - TH - HM - HL

NOTE

2c LED: ON when the contact 13-14 is closed

3 FUNCTIONS

HT RH > RHset or Tamb > Tset

The contact (13-14) closes if the ambient humidity (RH) is greater than the set humidity (RHset) or if the ambient temperature (Tamb) is greater than the set temperature (Tset)

TH RH > RHset or Tamb < Tset

The contact (13-14) closes if the ambient humidity (RH) is higher than the set humidity (RHset) or if the ambient temperature (Tamb) is less than the set value (Tset)

HM RH > RHset

The contact (13-14) closes if the ambient humidity (RH) is higher than the set humidity (RHset)

HL RH < RHset

The contact (13-14) closes if the room humidity (RH) is less than the set humidity (RHset)