







19.21

	19.21.0.012.0000 U _N 12 V AC (50/60 Hz) / DC U _{min} - U _{max} (9.6 - 13.2)V AC/DC P 0.6 VA / 0.4 W	
	19.21.0.024.0000 U _N 24 V AC (50/60 Hz) / DC U _{min} - U _{max} (19.2 - 26.4)V AC/DC P 0.6 VA / 0.4 W	
	1CO (SPDT) 10 A 250 V AC	
	AC1	2500 VA
	AC15 (230 V AC)	500 VA
	(M) (230 V AC)	0.44 kW
	DC1 (24/110/220)V	(10/0.3/0.12)A
	(-20...+50)°C	
IP20		

	B1 - B2	1 NO (SPST - NO)
		300 mA
		24 V AC/DC

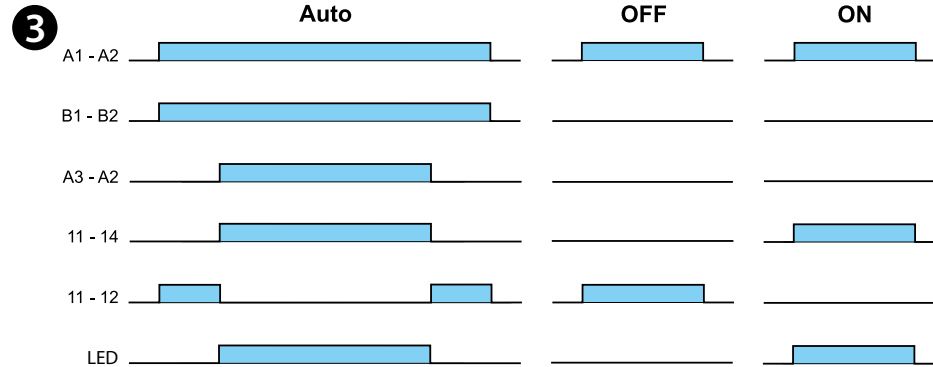
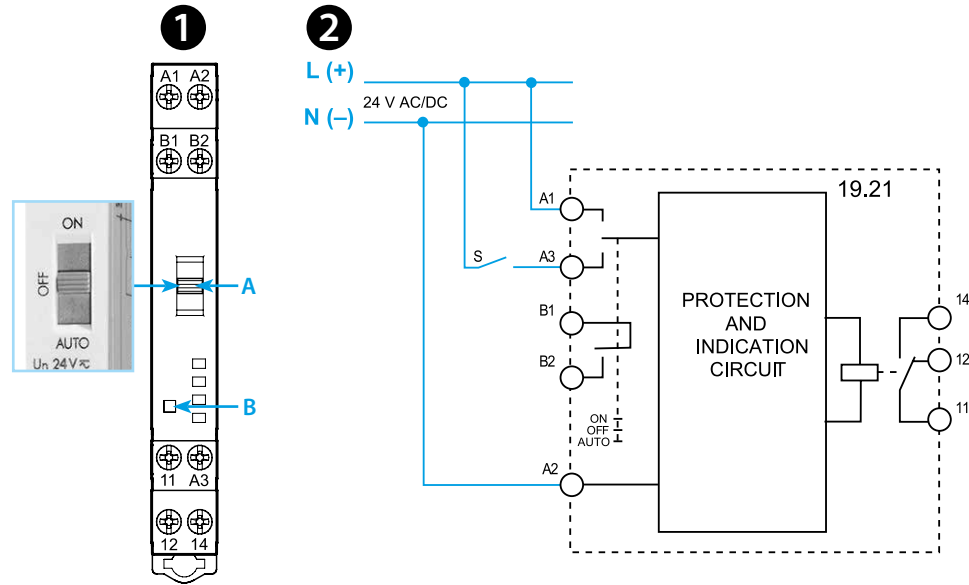
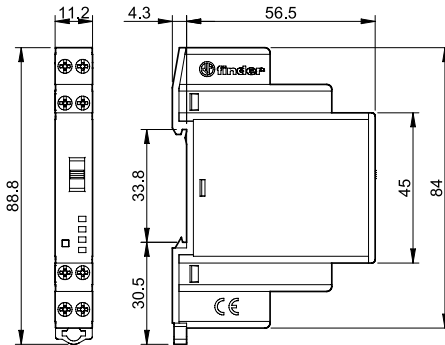

19.21.0.024.0000

- Maximum Surrounding Air Temperature 50°C
- Use 60/75°C copper (CU) conductors and wire size range No. 14-24 AWG, stranded or solid
- Torque 0.5 Nm
- A1-A2-A3 and B1-B2 shall be supplied by a Class 2 circuit

UL US LISTED
IND. CONT. EQ. E81856

ENGLISH

19.21 AUTO/OFF/ON OUTPUT MODULE

- FRONT VIEW**
 - A** Function selector switch:
 - AUTO works as a monostable relay (following A3 input)
 - OFF relay permanently OFF
 - ON relay permanently ON
 - B** LED: relay ON
- CONNECTION DIAGRAM**

NOTE
The max switching voltage between B1 and B2 terminal is 24 V AC/DC (300 mA)
- FUNCTIONAL DIAGRAM**
 - B1 - B2 feed back information to the controller for Auto-operation
 - A3 - A2 from the controller requested operation