







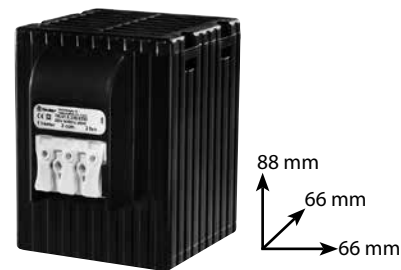

7H.51

	7H.51.8.120.0xxx U _N 120 V AC (50/60 Hz) U _{min} 98 V AC U _{max} 132 V AC	7H.51.8.230.0xxx U _N 230 V AC (50/60 Hz) U _{min} 184 V AC U _{max} 253 V AC
	I _{nom} 2 A - P _{max} 250 W (7H.51.8.120.0250) * I _{nom} 3 A - P _{max} 400 W (7H.51.8.120.0400) *	I _{nom} 1 A - P _{max} 250 W (7H.51.8.230.0250) * I _{nom} 1.7 A - P _{max} 400 W (7H.51.8.230.0400) *
	(-40...+50)°C	
IP20		

7H.51.8.xxx.0250 7H.51.8.xxx.0400



	7H.51.0.230.xxxxx U _N 110...230 V AC (50/60 Hz) / DC U _{min} 88 V AC/DC U _{max} 253 V AC/DC
	I _{nom} 0.13 A - P _{max} 25 W (7H.51.0.230.0025) * I _{nom} 0.2 A - P _{max} 50 W (7H.51.0.230.0050) * I _{nom} 0.45 A - P _{max} 100 W (7H.51.0.230.0100) * I _{nom} 0.7 A - P _{max} 150 W (7H.51.0.230.0150) *
	(-45...+50)°C
IP20	

7H.51.0.230.0025 7H.51.0.230.0050



7H.51.0.230.0100 7H.51.0.230.0150



1 1a

FUZE	
7H.51.8.120.0250	10 A
7H.51.8.230.0250	6.3 A
7H.51.8.120.0400	10 A
7H.51.8.230.0400	6.3 A

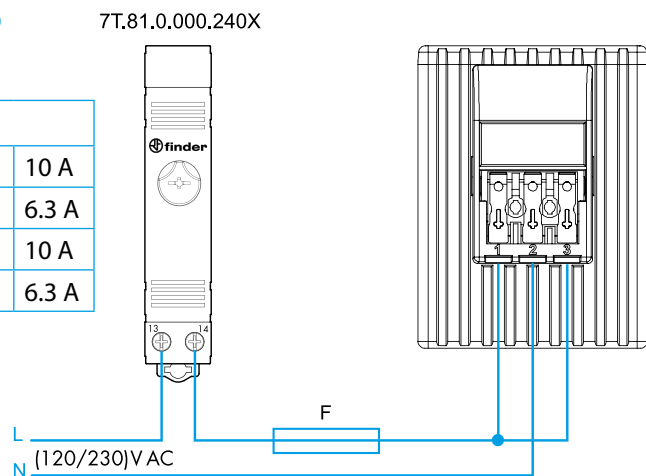

1 1a

FUZE	
7H.51...0025	4 A
7H.51...0050	4 A
7H.51...0100	8 A
7H.51...0150	10 A

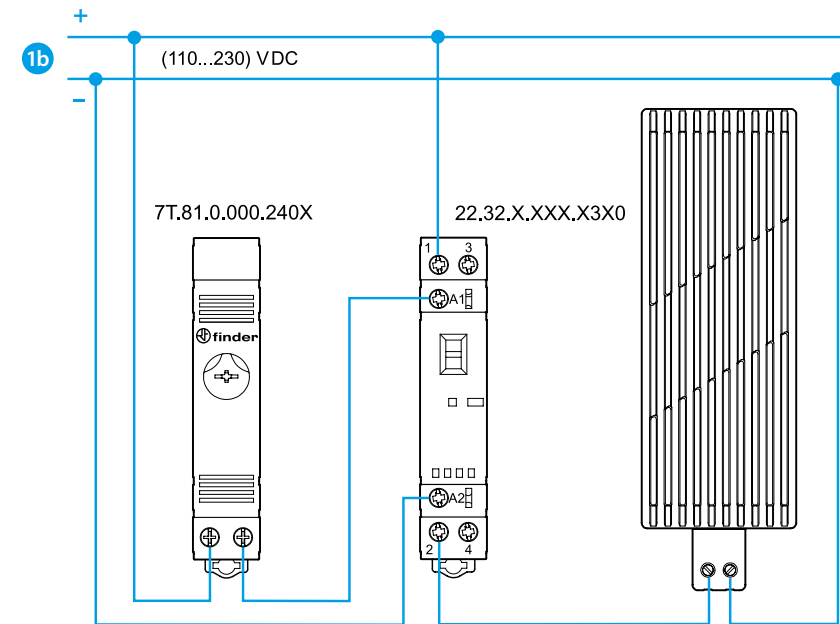
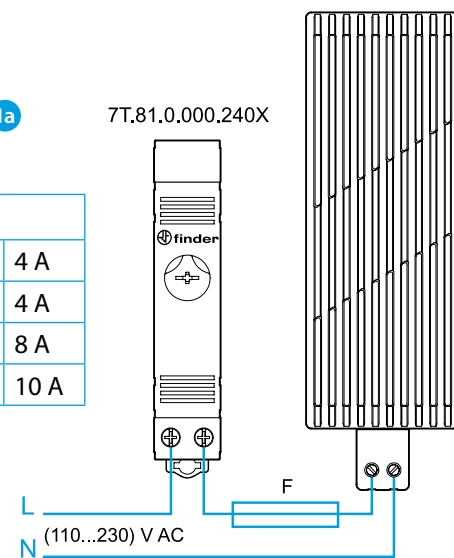

ENGLISH

7H.51 PANEL HEATERS

Panel heaters avoid the formation of condensation within closed electrical cabinets by maintaining a minimum internal temperature.

1 WIRING DIAGRAMS

7H.51 heaters incorporate a self-regulating PTC heating element. For maintaining the internal cabinet temperature use in conjunction with a thermostat (eg. Type 7T.81.0.000.240x)

1a Wiring diagram for AC supply

1b Wiring diagram for DC supply (only 7H-0025 / 7H-0050 / 7H-100 / 7H-150)

SAFETY NOTES

For reason of safety and performance, heaters must be mounted in the following way:

- 1) Maintain a distance of 100 mm from any components above or below the heater, and 60 mm from components to either side
- 2) Install the heater vertically (cables below) and in the bottom part of the cabinet
- 3) Mount on 35 mm rail
- 4) Do not mount the heater above easily inflammable materials
- 5) Do not operate in a corrosive environment

INSTALLATION AND CONNECTION

Heater connection must be done by trained electricians according national electrical safety codes.

Before any operation, disconnect cabinet. Connect to main terminal box (L/+) (N/-) with an approved minimum section 2x1mm² cable. Consider that the 7H.51 value 6 times higher than rated current.

WARNING

- Do not cover the heater
 - The 7H.51 heater remains very hot for 15-20 minutes after disconnection
 - Do not touch during working or maintenance
- Warning:** risk of burns

TECHNICAL NOTES

- Aluminium profile with plastic cover
- Vertical positioning
- Mounting clip for 35 mm rail (EN 60715)
- *P_{max}: at 20°C ambient temperature
- Fan assisted heaters - air flow rate 30 m³/h (7H-0250/0400)
- Screw terminals (7H-0025 / 7H-0050 / 7H-100 / 7H-150)
- Fast wiring terminals (7H-0250/0400)
- Recommended delayed fuse