





86.00

86.00.0.240.0000	
	U _N (12...240)V AC (50/60 Hz) / DC U _{min} 10.2 V AC/DC U _{max} 265 V AC/DC P 1.2 W
	(-20...+50)°C
IP20	

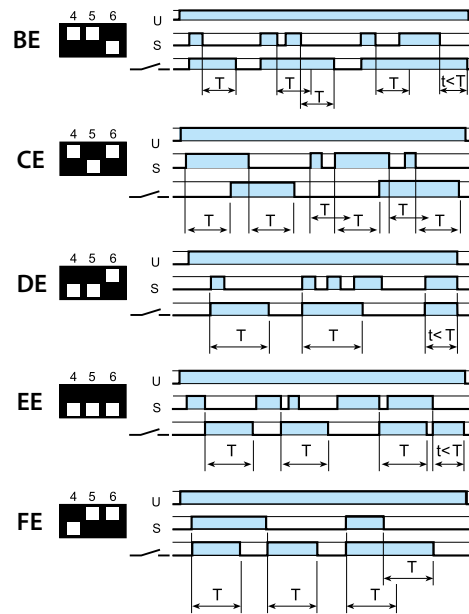
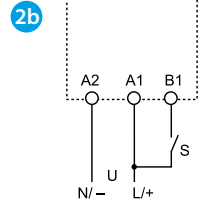
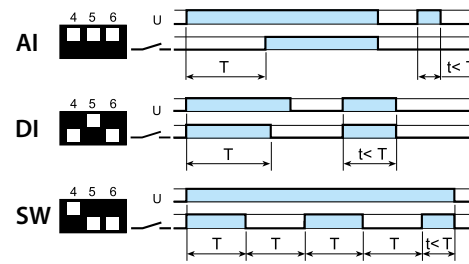
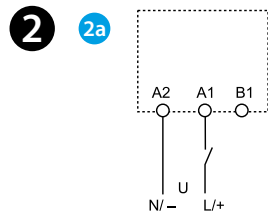
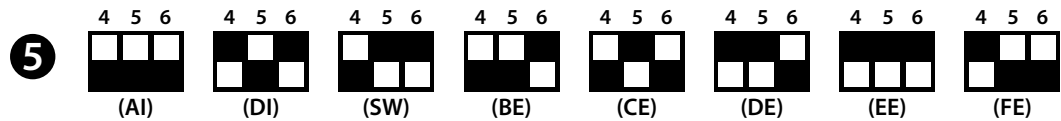
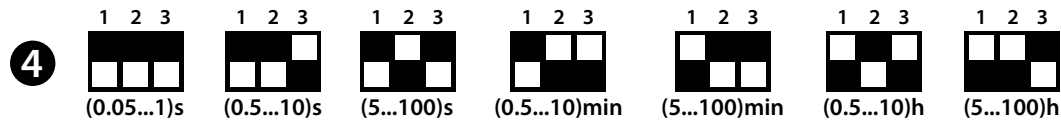
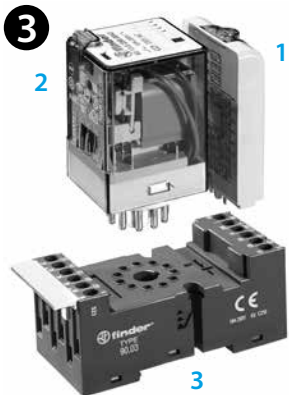
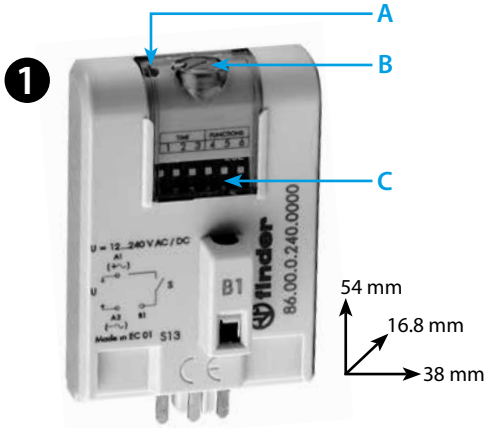

ENGLISH

86.00
MULTI-FUNCTION AND MULTI-VOLTAGE TIMER MODULE

1 FRONT VIEW

- A LED
- B Time delay adjustment trimmer
- C Dip Switch: time scales and functions

2 WIRING DIAGRAM AND FUNCTIONS

2a Wiring diagram without control signal

- AI On-delay
- DI Interval
- SW Symmetrical flasher (starting pulse on)

2b Wiring diagram with control signal

- BE Off-delay with control signal
- CE On- and off-delay with control signal
- DE Interval with control signal on
- EE Interval with control signal off
- FE Interval with control signal on and off

3 INSTALLATION (example)

- 1 Timer module
- 2 Relay
- 3 Socket

	1	2	3
	86.00	56.34	96.04
	86.00	60.12	90.02
	86.00	60.13	90.03
	86.00	62.32	92.03
	86.00	62.33	92.03

4 DIP "TIME"

5 DIP "FUNCTIONS"