



User Manual for ZX OCS

HE-ZX452
HE-ZX752
HE-ZX1152



PREFACE

This manual explains how to use the ZX OCS.

Copyright© 2014 Horner APG, LLC, 59 South State Avenue, Indianapolis, Indiana 46201. All rights reserved. No part of this publication may be reproduced, transmitted, transcribed, stored in a retrieval system, or translated into any language or computer language, in any form by any means, electronic, mechanical, magnetic, optical, chemical, manual or otherwise, without the prior agreement and written permission of Horner APG, Inc.

All software described in this document or media is also copyrighted material subject to the terms and conditions of the Horner Software License Agreement.

Information in this document is subject to change without notice and does not represent a commitment on the part of Horner APG.

Ethernet™ is a trademark of Xerox Corporation.

MicroSD™ and CompactFlash are registered trademarks of SanDisk Corporation.

For user manual updates, contact Technical Support:**North America:**

Tel: 1-877-655-5666

Fax: (+) (317) 639-4279

Web: <http://www.hornerautomation.com>

Email: techspt@hornerautomation.com

Europe:

Tel: (+) 353-21-4321-266

Fax: (+) 353-21-4321-826

Web: <http://www.horner-apg.com>

Email: tech.support@horner-apg.com

LIMITED WARRANTY AND LIMITATION OF LIABILITY

Horner APG, LLC, ("HE-APG") warrants to the original purchaser that the ZX OCS module manufactured by HE-APG is free from defects in material and workmanship under normal use and service. The obligation of HE-APG under this warranty shall be limited to the repair or exchange of any part or parts which may prove defective under normal use and service within two (2) years from the date of manufacture or eighteen (18) months from the date of installation by the original purchaser whichever occurs first, such defect to be disclosed to the satisfaction of HE-APG after examination by HE-APG of the allegedly defective part or parts. THIS WARRANTY IS EXPRESSLY IN LIEU OF ALL OTHER WARRANTIES EXPRESSED OR IMPLIED INCLUDING THE WARRANTIES OF MERCHANTABILITY AND FITNESS FOR USE AND OF ALL OTHER OBLIGATIONS OR LIABILITIES AND HE-APG NEITHER ASSUMES, NOR AUTHORIZES ANY OTHER PERSON TO ASSUME FOR HE-APG, ANY OTHER LIABILITY IN CONNECTION WITH THE SALE OF THIS ZX OCS module. THIS WARRANTY SHALL NOT APPLY TO THIS ZX OCS module OR ANY PART THEREOF WHICH HAS BEEN SUBJECT TO ACCIDENT, NEGLIGENCE, ALTERATION, ABUSE, OR MISUSE. HE-APG MAKES NO WARRANTY WHATSOEVER IN RESPECT TO ACCESSORIES OR PARTS NOT SUPPLIED BY HE-APG. THE TERM "ORIGINAL PURCHASER", AS USED IN THIS WARRANTY, SHALL BE DEEMED TO MEAN THAT PERSON FOR WHOM THE ZX OCS module IS ORIGINALLY INSTALLED. THIS WARRANTY SHALL APPLY ONLY WITHIN THE BOUNDARIES OF THE CONTINENTAL UNITED STATES.

In no event, whether as a result of breach of contract, warranty, tort (including negligence) or otherwise, shall HE-APG or its suppliers be liable of any special, consequential, incidental or penal damages including, but not limited to, loss of profit or revenues, loss of use of the products or any associated equipment, damage to associated equipment, cost of capital, cost of substitute products, facilities, services or replacement power, down time costs, or claims of original purchaser's customers for such damages.

To obtain warranty service, return the product to your distributor with a description of the problem, proof of purchase, postpaid, insured and in a suitable package.

ABOUT PROGRAMMING EXAMPLES

Any example programs and program segments in this manual or provided on accompanying diskettes are included solely for illustrative purposes. Due to the many variables and requirements associated with any particular installation, Horner APG cannot assume responsibility or liability for actual use based on the examples and diagrams. It is the sole responsibility of the system designer utilizing the ZX OCS module to appropriately design the end system, to appropriately integrate the ZX OCS module and to make safety provisions for the end equipment as is usual and customary in industrial applications as defined in any codes or standards which apply.

Note: The programming examples shown in this manual are for illustrative purposes only. Proper machine operation is the sole responsibility of the system integrator.

INTENTIONALLY LEFT BLANK

TABLE OF CONTENTS

PREFACE **2**
 For user manual updates, contact Technical Support: 2
 LIMITED WARRANTY AND LIMITATION OF LIABILITY 3
 ABOUT PROGRAMMING EXAMPLES 3

TABLE OF CONTENTS **5**

INTENTIONALLY LEFT BLANK **9**

CHAPTER 1: SAFETY / COMPLIANCE **10**
 1.1 Safety Warnings and Guidelines 10
 1.2 Grounding 10
 1.3 Compliance 11

CHAPTER 2: INTRODUCTION **12**
 2.1 Visual Overview of ZX Models 12
 2.1.1 Where to Find Information about the ZX OCS 13
 2.1.2 Four main types of information are covered in this manual 13
 2.1.3 Manual Index 13
 2.1.4 Table of Figures 13
 2.2 Connectivity to the ZX OCS 13
 ZX OCS 13
 2.3 Features of ZX OCS 14
 2.4 Required and Suggested Accessories 14
 2.5 Useful Documents and References 14

CHAPTER 3: MECHANICAL INSTALLATION **16**
 3.1 Overview 16
 3.2 Mounting Requirements 16
 3.2.1 *Mounting Procedures (Installed in a Panel Door)* 16
 3.3.1 ZX OCS Mounting Clip Slot Locations 17
 3.3.2 ZX OCS Panel Mounting Orientation 18
 3.4 Panel Cut-Out 18
 3.5 ZX Dimensions 20
 3.6.1 Clearance / Adequate Space 23
 3.6.2 Grounding 23
 3.6.3 Temperature / Ventilation 23
 3.6.4 Orientation 23
 3.6.5 Noise 23
 3.6.6 Shock and Vibration 23
 3.6.7 Panel Layout Design and Clearance Checklist 24

CHAPTER 4: ELECTRICAL INSTALLATION **26**
 4.1 Grounding Definition 26
 4.2 Ground Specifications 26
 4.3 How to Test for Good Ground 26
 4.4 Primary Power Port 27

CHAPTER 5: SERIAL COMMUNICATIONS **28**
 5.1 Overview 28
 5.2 Port Descriptions 28
 5.3 Serial Port Pin Assignments 28
 5.5 RS485 Biasing 28
 5.6 Cscape Programming via Serial Port 29
 5.7 Ladder-Controlled Serial Communication 29
 5.8 Downloadable Serial Communication Protocols 29

CHAPTER 6: CAN COMMUNICATIONS **30**

6.1	Overview	30
6.2	Port Description	30
6.3	Cscape Programming via CAN.....	31
6.4	Ladder-Controlled CAN Communication	31
6.5	Using CAN for I/O Expansion (Network I/O)	31
CHAPTER 7: ETHERNET COMMUNICATION.....		32
7.1	Ethernet Module Protocols and Features	32
7.2	Ethernet System Requirements.....	32
7.3	Ethernet Module Specifications	32
7.4	Ethernet Configuration.....	32
CHAPTER 8: REMOVABLE MEDIA		ERROR! BOOKMARK NOT DEFINED.
8.1	Overview	Error! Bookmark not defined.
8.2	Removable Media File System	Error! Bookmark not defined.
8.3	Using the Removable Media Manager	Error! Bookmark not defined.
8.4	Using Removable Media to Log Data.....	Error! Bookmark not defined.
8.5	Using Removable Media to View and Capture Screens	Error! Bookmark not defined.
CHAPTER 9: REMOTE I/O CONFIGURATION.....		41
9.1	Configuration of ETX200 SmartRail Base and I/O Modules	41
9.2	Configuring Other I/O using CsCAN.....	43
CHAPTER 10: SYSTEM SETTINGS AND ADJUSTMENTS.....		47
10.1	System Menu – Overview	47
10.2	System Menu – Navigation and Editing	47
10.4	Touch screen calibration.....	57
CHAPTER 11: USER INTERFACE.....		58
11.1	Overview	58
11.2	Displaying and entering Data	58
11.3	Alpha-numeric keypad	59
11.5	Ladder Based Screen Navigation	61
11.6	Beeper Acknowledgement	61
11.7	Touch (Slip) Sensitivity	61
11.8	Alarms	62
11.10	Screen Saver	64
11.11	Screen Brightness.....	64
CHAPTER 12: REGISTERS.....		65
12.1	Register Definitions	65
12.2	Useful %S and %SR registers	65
12.4	Resource Limits	68
CHAPTER 13: CSCAPE CONFIGURATION.....		70
13.1	Overview	70
13.2	Cscape Status Bar	70
13.3	Establishing Communications.....	71
13.3.1	Communicating via MJ1 Serial Port	71
13.3.2	Communicating Ethernet Port.....	71
13.4	Configuration.....	72
CHAPTER 14: FAIL SAFE SYSTEM.....		73
14.1	Overview.....	73
14.2	Settings.....	73
14.3	Backup / Restore Data	73
14.4	AutoLoad	77
14.5	AutoRun.....	79
CHAPTER 15: CLONE UNIT.....		80

15.1	Overview	80
15.2	Clone	80
15.3	Load Clone	82
CHAPTER 16: MAINTENANCE		84
16.1	Firmware Updates	84
CHAPTER 17: TROUBLESHOOTING / TECHNICAL SUPPORT		86
17.1	Connecting to the ZX OCS	86
17.1.3	Connecting Troubleshooting Checklist (ETN port programming)	87
17.2	Local Controller and Local I/O	87
17.2.1	Local I/O Troubleshooting Checklist.....	87
17.3	CsCAN Network	88
17.3.1	CsCAN Network Troubleshooting Checklist.....	88
17.4	Removable Media - Basic Troubleshooting	88
17.5	Technical Support Contacts	88
	Main Index	89

Visual map of major tasks and the key chapters

FIRST STEP of ANY TASK: DATASHEET			
<p>Each ZX OCS unit is sent with a datasheet in the box. The datasheet (MAN0960-04-EN) is the first document to refer to for model-specific information related to ZX OCS models such as pin-outs, jumper settings, and other key installation information. To obtain updates to datasheets, manuals and user documentation, visit a Horner website (US: http://www.heapg.com and Europe: http://www.horner-apg.com.)</p>			
QUICK START	INSTALLATION	PROGRAMMING	TROUBLESHOOTING
Safety / Compliance page 11	Safety / Compliance page 11	Safety / Compliance page 11	Safety / Compliance page 11
Introduction page 13	Introduction page 13	Introduction page 13	Introduction page 13
	Mechanical Installation page 16	Serial Communications page 28	Maintenance page 83
	Electrical Installation page 26	CAN Communications page 30	Troubleshooting page 85
		Ethernet page 32	
		Removable Media page 36	
		Remote I/O Config Page 40	
		System Settings page 46	
		User Interface page 57	
		Registers page 64	
		Cscape Configuration page 69	
		Fail- Safe System page 72	
	Clone Unit page 79		

INTENTIONALLY LEFT BLANK

CHAPTER 1: SAFETY / COMPLIANCE

1.1 Safety Warnings and Guidelines

When found on the product, the following symbols specify:



Warning: Consult user documentation.



Warning: Electrical Shock Hazard.

WARNING – EXPLOSION HAZARD – Do not disconnect equipment unless power has been switched off or the area is known to be non-hazardous

WARNING: To avoid the risk of electric shock or burns, always connect the safety (or earth) ground before making any other connections.

WARNING: To reduce the risk of fire, electrical shock, or physical injury it is strongly recommended to fuse the voltage measurement inputs. Be sure to locate fuses as close to the source as possible.

WARNING: Replace fuse with the same type and rating to provide protection against risk of fire and shock hazards.

WARNING: In the event of repeated failure, do not replace the fuse again as a repeated failure indicates a defective condition that will not clear by replacing the fuse.

WARNING – EXPLOSION HAZARD – Substitution of components may impair suitability for Class I, Division 2

WARNING - The USB parts are for operational maintenance only. Do not leave permanently connected unless area is known to be non-hazardous

WARNING – EXPLOSION HAZARD - BATTERIES MUST ONLY BE CHANGED IN AN AREA KNOWN TO BE NON-HAZARDOUS

WARNING - Battery May Explode If Mistreated. Do Not Recharge, Disassemble or Dispose Of In Fire

WARNING: Only qualified electrical personnel familiar with the construction and operation of this equipment and the hazards involved should install, adjust, operate, or service this equipment. Read and understand this manual and other applicable manuals in their entirety before proceeding. Failure to observe this precaution could result in severe bodily injury or loss of life.

- a. All applicable codes and standards need to be followed in the installation of this product.
- b. For I/O wiring (discrete), use the following wire type or equivalent: Belden 9918, 18 AWG or larger.

Adhere to the following safety precautions whenever any type of connection is made to the module.

- a. Connect the green safety (earth) ground first before making any other connections.
- b. When connecting to electric circuits or pulse-initiating equipment, open their related breakers. Do not make connections to live power lines.
- c. Make connections to the module first; then connect to the circuit to be monitored.
- d. Route power wires in a safe manner in accordance with good practice and local codes.
- e. Wear proper personal protective equipment including safety glasses and insulated gloves when making connections to power circuits.
- f. Ensure hands, shoes, and floors are dry before making any connection to a power line.
- g. Make sure the unit is turned OFF before making connection to terminals. Make sure all circuits are de-energized before making connections.
- h. Before each use, inspect all cables for breaks or cracks in the insulation. Replace immediately if defective.

1.2 Grounding

Grounding is covered in various chapters within this manual.

1.3 Compliance

To check for compliance and updates, visit the Horner website (US: <http://www.heapg.com> or Europe: <http://www.horner-apg.com>.)

CHAPTER 2: INTRODUCTION

2.1 Visual Overview of ZX Models

Figure 2.1 – Overview of the ZX (ZX1152/752 - Top, ZX452 - Bottom)

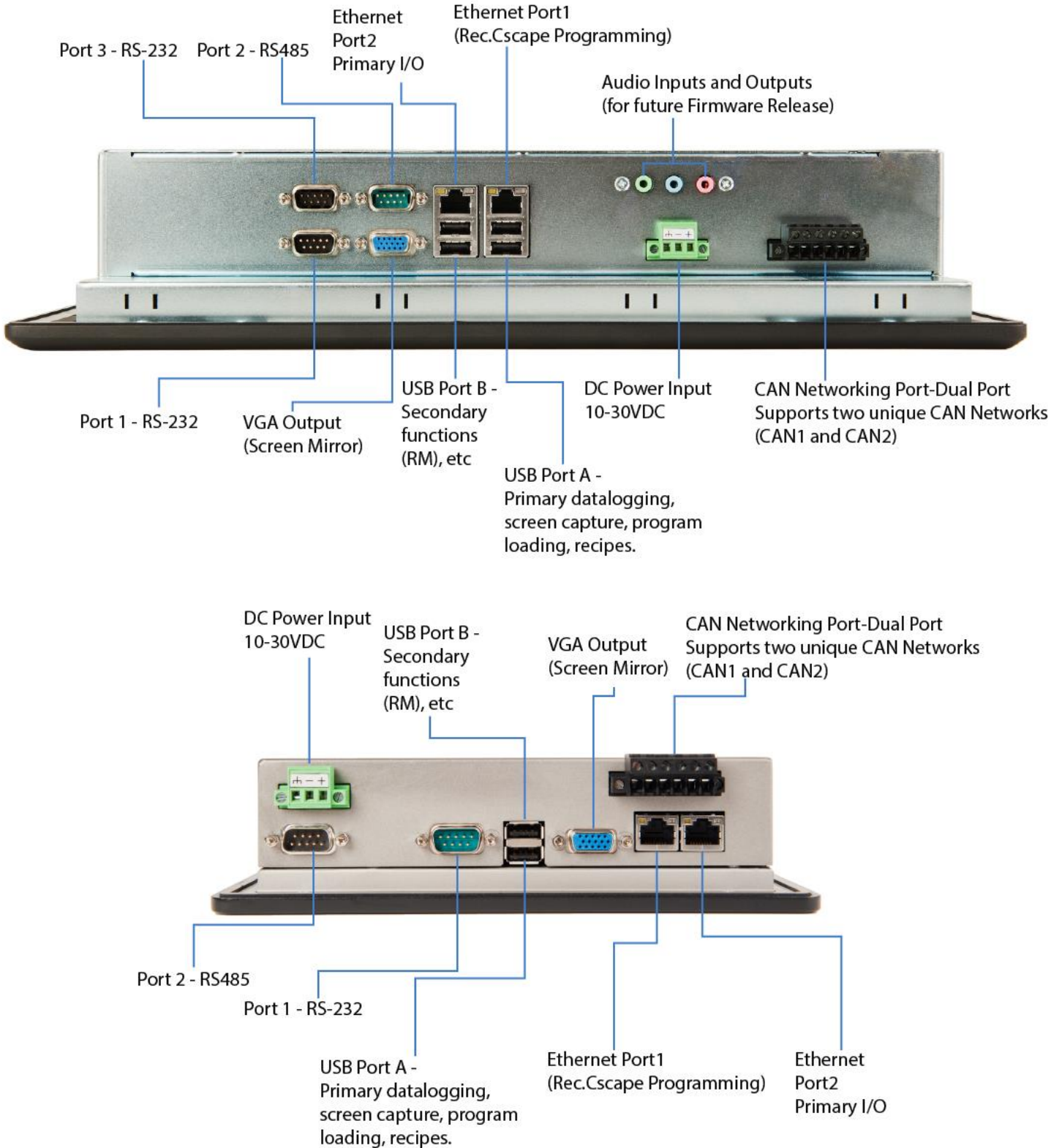

2.1.1 Where to Find Information about the ZX OCS

- a) **Datasheet** - The **datasheet is the first document to refer to for key information** related to specific ZX OCS models.
 - a. The datasheets for all ZX OCS models are available on the Horner websites.
 - b. Datasheets contain pin-outs and other model specific information.
- b) **User Manual** -This manual provides general information that is common to ZX OCS models and can be downloaded from our web. Visit the Horner website (US: <http://www.heapg.com> or Europe: <http://www.horner-apg.com>) to obtain further user documentation and updates.

2.1.2 Four main types of information are covered in this manual

- a) Safety and Installation guidelines / instructions (Mechanical and Electrical)
- b) Descriptions of hardware features
 - a. (Ports, Removable Media, Communication Options, etc.)
- c) Configuration and Use of the ZX OCS
- d) Maintenance and Support

2.1.3 Manual Index

Major topics of interest may be found in the [Index](#) towards the end of this manual.

2.1.4 Table of Figures

Location of important drawing, illustrations (etc.) may be found in the [Table of Figures](#).

2.2 Connectivity to the ZX OCS

The ZX OCS has excellent capabilities for connecting to a variety of devices. The diagram below shows some examples of devices that can be used with the ZX OCS.

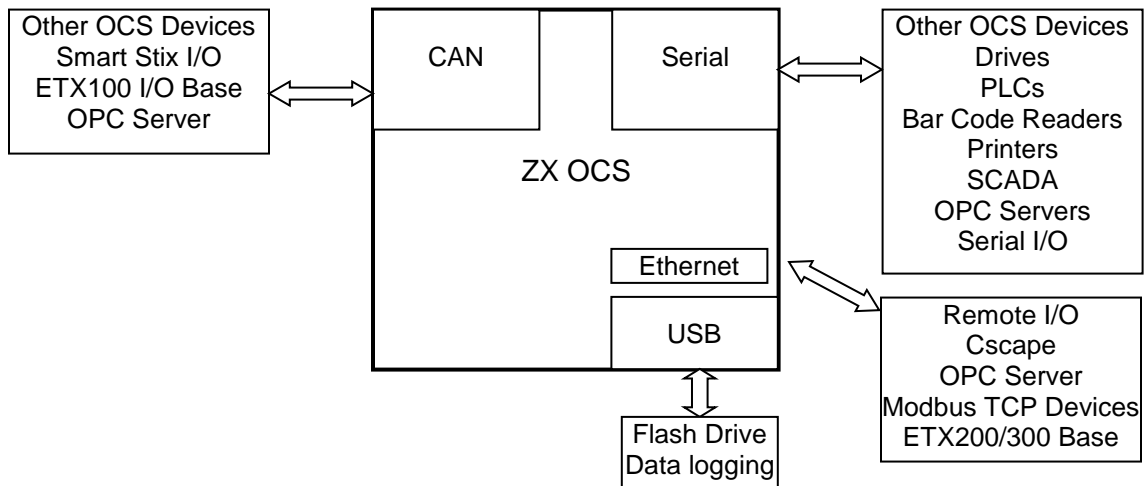

Figure 2.2 – Visual Overview of Types of Devices that can be connected to ZX OCS

2.3 Features of ZX OCS

The ZX OCS models are industrial control devices. They combine control, user interface, and networking into a single, integrated package. Unique features of the ZX OCS include:

- Bright, 65,536 color graphical touch sensing LCD display in all models of ZX.
- Display of complex graphical objects including trends, gauges, meters and animations.
- Very high performance graphic processing
- Advanced control capabilities including floating point, multiple auto-tuning PID loops and string handling capabilities.
- Removable media (USB drive) for 32GB of storage of programs, data logging or screen captures.
- CsCAN networking port for communication with remote I/O, other controllers, or PCs.
- Configurable serial protocols for communication to drives, PLCs, or other serial peripherals.
- Cscape programming software that allows all aspects of the ZX OCS to be programmed and configured from one integrated application.
- On board Ethernet port (10/100Mbps) for Cscape programming and application defined communication, with Auto MDI/MDI-X.

2.4 Touch Screen Interface and Function Keys

The ZX unit uses digital, on screen soft keys for function keys, streamlining the appearance of the unit. The function key menu can be configured to toggle on and off screen or to automatically go off screen after a specific delay.

To access the function keys, press the top right corner of the touch screen display. The menu button can be found here as well. More details on configuring the function key tray will be covered in later chapters.

2.4 Required and Suggested Accessories

The following list contains a *sampling* of required and suggested ZX OCS accessories. Visit the Horner websites to view updates on new products and accessories.

NOTE: The ZX OCS is not shipped with a programming cable in the box.

Table 2.1 – ZX OCS Accessories	
Part Number	Description
HE-X24-AL	72W Power supply 100-240 VAC or 140-340 VDC Switching supply that outputs 3 A (HE-X24-AS/AL) at 24VDC.
HE-CSP	Cscape Software Package on a reusable USB flash drive with symbol library.
SmartRail I/O	The Smartrail Series I/O is recommended for the ZX

2.5 Useful Documents and References

The following information serves as a *general* listing of Horner controller products and other references of interest with their corresponding manual numbers. Visit the Horner websites to obtain user documentation and updates.

Table 2.2 – OCS Reference Document numbers	
NOTE: This list is <u>not</u> intended for users to determine which products are appropriate for their application; controller products differ in the features that they support. If assistance is required, refer to Technical Support.	
Manual Description	Manual Number
User Manual for XLe/XLt OCS models	MAN0878
User Manual for XL6/XL6e/XL10 OCS models	MAN0883
User Manual for XL4 OCS models	MAN0964
User Manual for QX Series models	MAN0798

User Manual for NX Series models	MAN0781
User Manual for XL7 OCS models	MAN0974
User Manual for XL4 OCS models	MAN0964
Other Useful References	Manual Number
Supplement for SmartStack Ethernet Modules	SUP0740
CAN Networks	MAN0799
Spark Quenchers for Arc and Noise Suppression (output protection)	MAN0962
Wiring Accessories and Spare Parts Manual	MAN0347
SmartRail CNX100 Datasheet	MAN0924
SmartRail ETX200 Datasheet	MAN0930

CHAPTER 3: MECHANICAL INSTALLATION

Note: The datasheet is the first document to refer to for model-specific information related to ZX OCS models such as pin-outs, jumper settings, and other key installation information. Visit the Horner websites to obtain datasheets, user documentation, and updates.

3.1 Overview

The mechanical installation greatly affects the operation, safety and appearance of the system. Information is provided to mechanically install the unit such as cut-out sizes, mounting procedures and other recommendations for the proper mechanical installation of the unit.

3.2 Mounting Requirements

3.2.1 Mounting Procedures (Installed in a Panel Door)

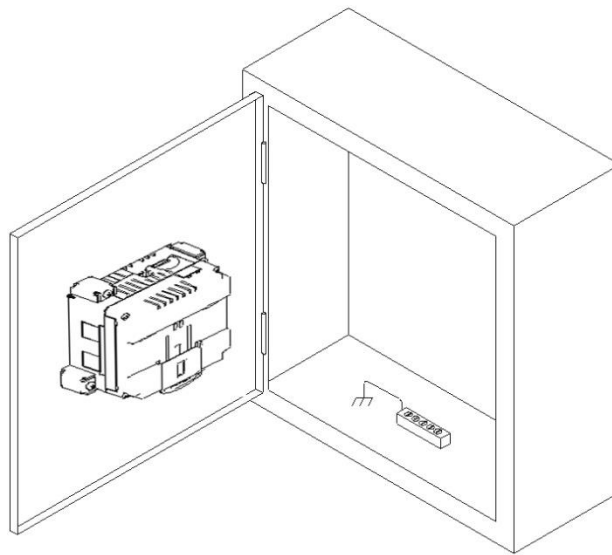

Figure 3.1 – General Panel Mounting of an OCS

Once the panel design has been completed using the criteria and suggestions in the following sections, use the following steps to panel mount the ZX OCS.

1. Remove all connectors from the ZX OCS unit.
2. Make sure the gasket is installed on the ZX OCS and is free from dust and debris. Check that the corners of the gasket are secure.
3. Pass the unit through the panel.
4. Insert each of the four (4) mounting clips on the ZX452 or a minimum of (8) mounting clips on the ZX752 and (10) ZX1152 into the slots in the ZX OCS case. Lightly tighten each screw so the clip is held in place.
5. Tighten the screws on the clips such that the gasket is compressed against the panel in a criss-cross pattern (start with top-left corner then move to bottom-right corner, etc.). Recommended torque is 7-10 lb/in (0.8-1.13 Nm.)

3.3 Mounting Orientation

3.3.1 ZX OCS Mounting Clip Slot Locations

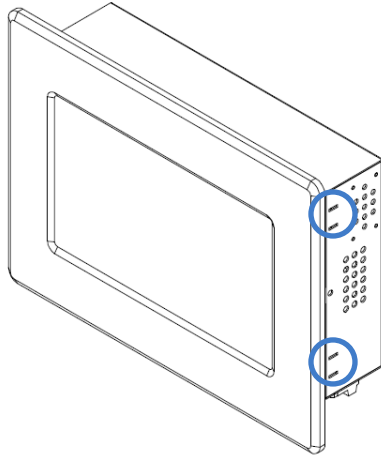

Clips fit in to parallel slots on the unit. The clips tighten the unit against the inside of the panel.

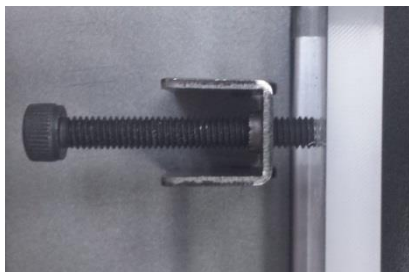

Tighten the screws on the clips such that the gasket is compressed against the panel. Recommended torque is 7-10 lb/in (0.8-1.13 Nm.)

The screw should be level and the mount should be perpendicular to controller. If the screw is angled or not flush with panel when tightened to spec, ensure proper orientation.

VESA Mount Option

The ZX1152 and ZX752 also support standard VESA 75x75 or 100x100 mounting for wall or arm mounting. The ZX452 supports the VESA 75x75 mounting pattern. 4mm screws should be used and are typically supplied with the mount.

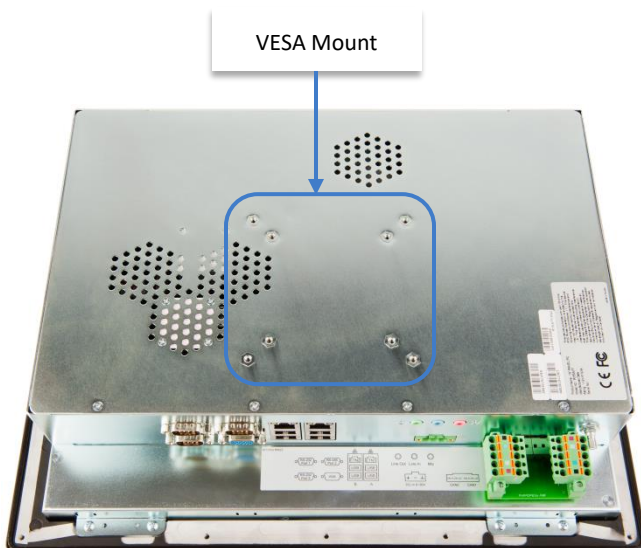

ZX1152 shown

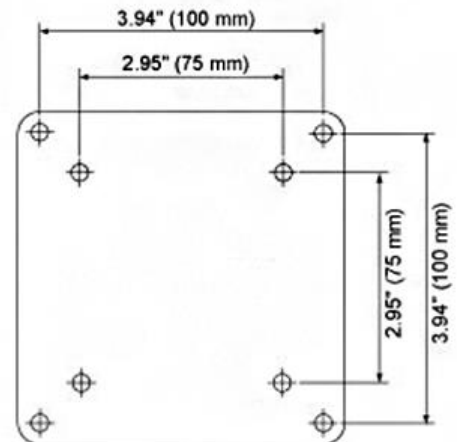

3.3.2 ZX OCS Panel Mounting Orientation

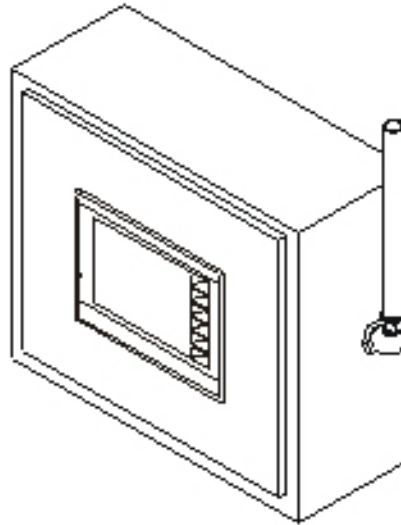
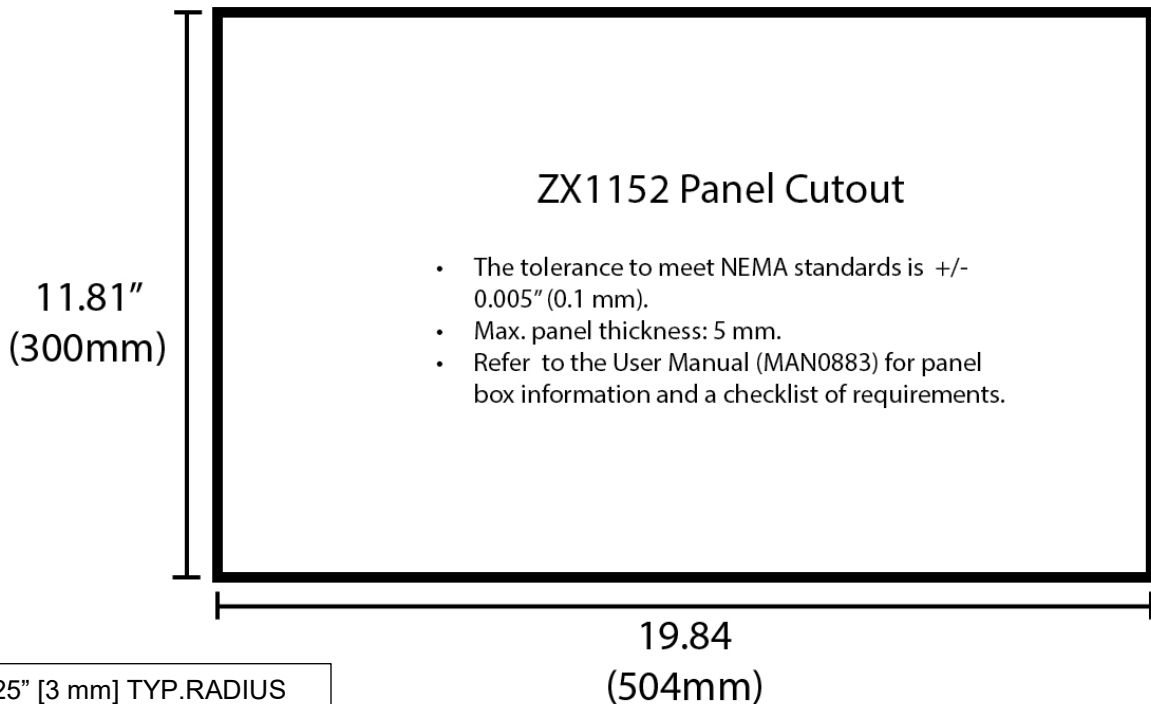

Figure 3.3 – General Orientation of OCS

NOTE: There are no orientation restrictions on the ZX OCS. However, the above orientation provides for optimum readability of the screen and ease of use of the keypad.

3.4 Panel Cut-Out



.125" [3 mm] TYP. RADIUS
CORNERS WHEN
REQUIRING DUST OR
WATERTIGHT SEAL
PER NEMA 4, 4X OR 12

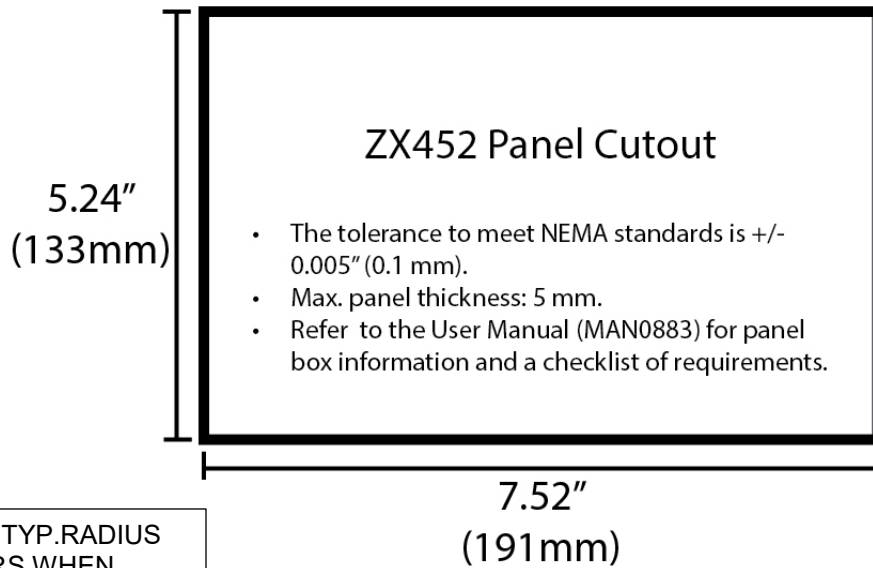
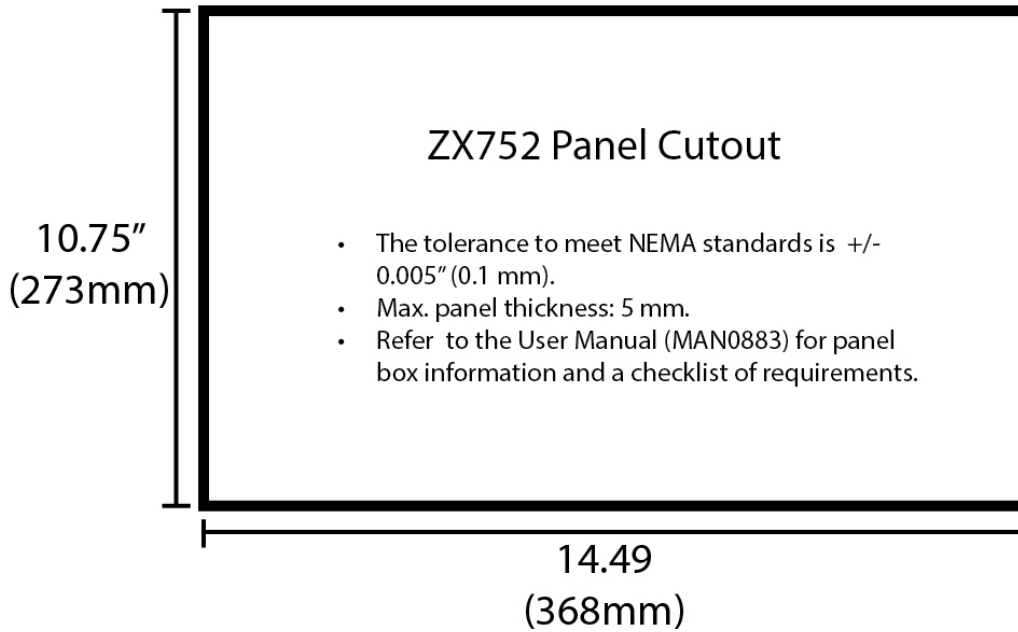

.125" [3 mm] TYP. RADIUS
CORNERS WHEN
REQUIRING DUST OR
WATERTIGHT SEAL
PER NEMA 4, 4X OR 12

Figure 3.4 – Panel Cutout Tolerances

3.5 ZX Dimensions

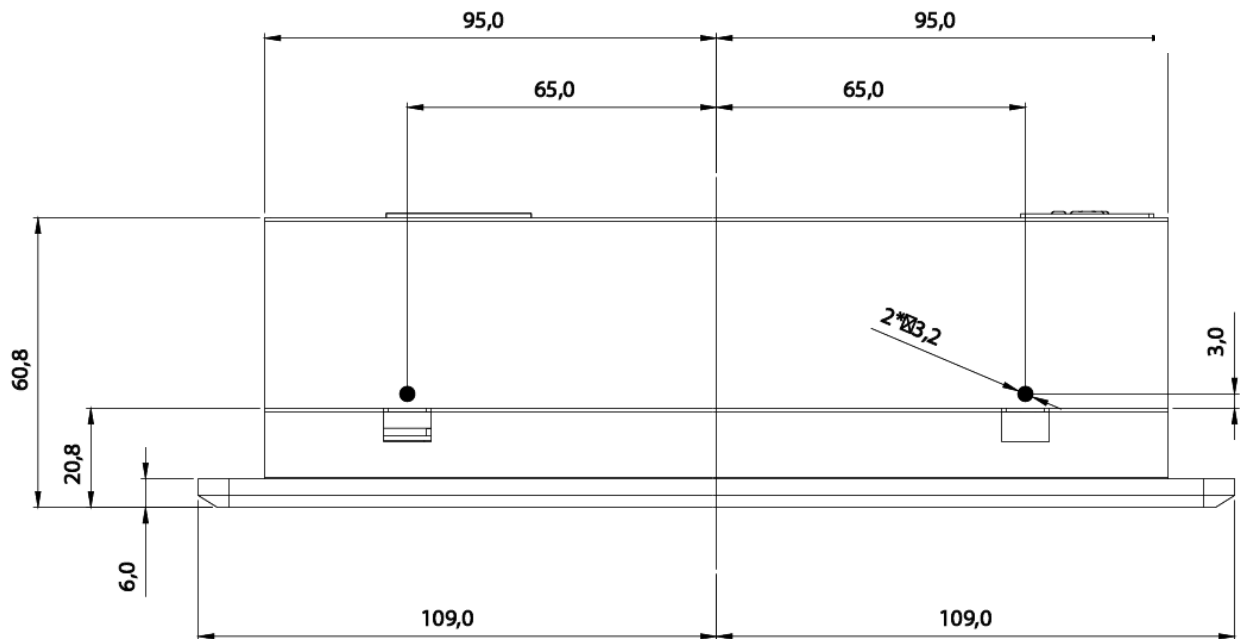
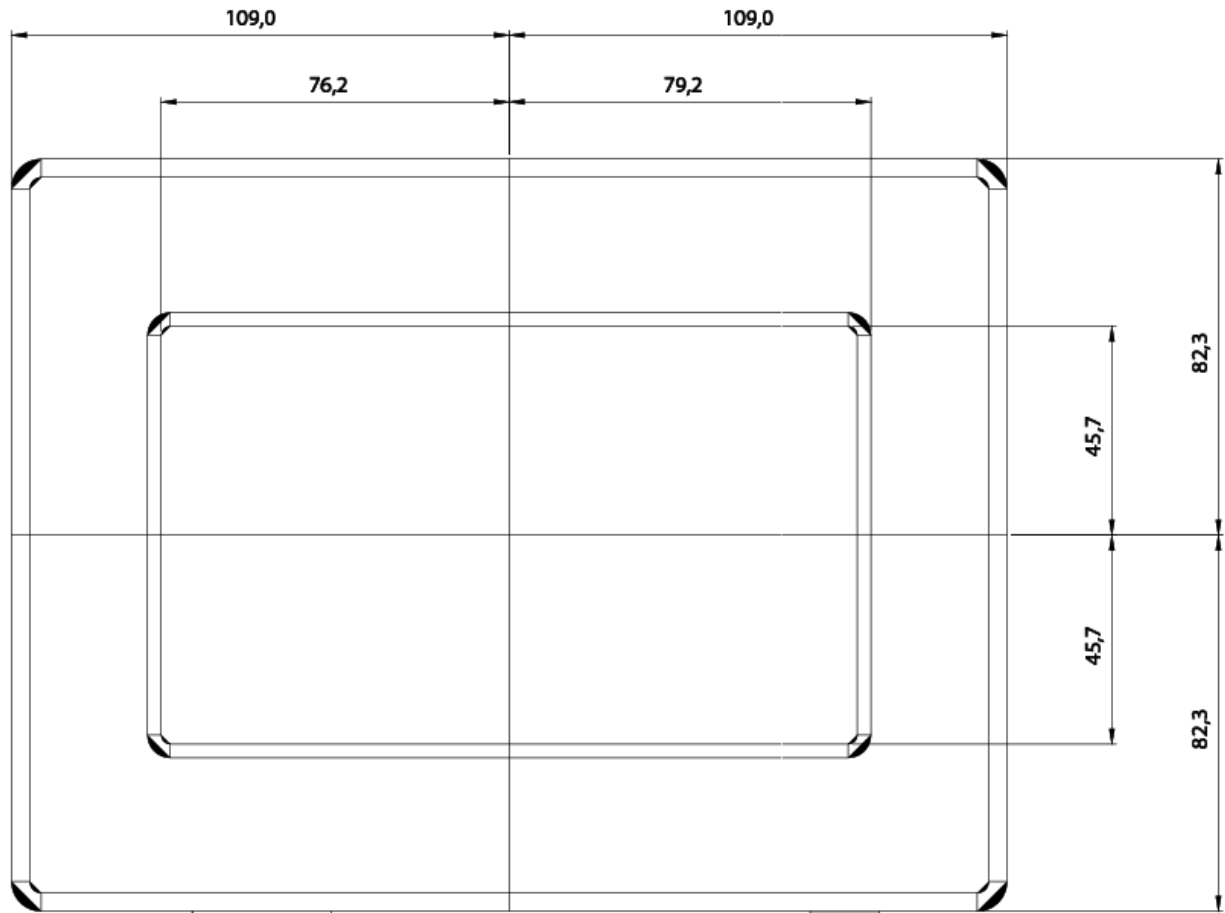

Figure 3.5 – ZX452 OCS Dimensions (mm)

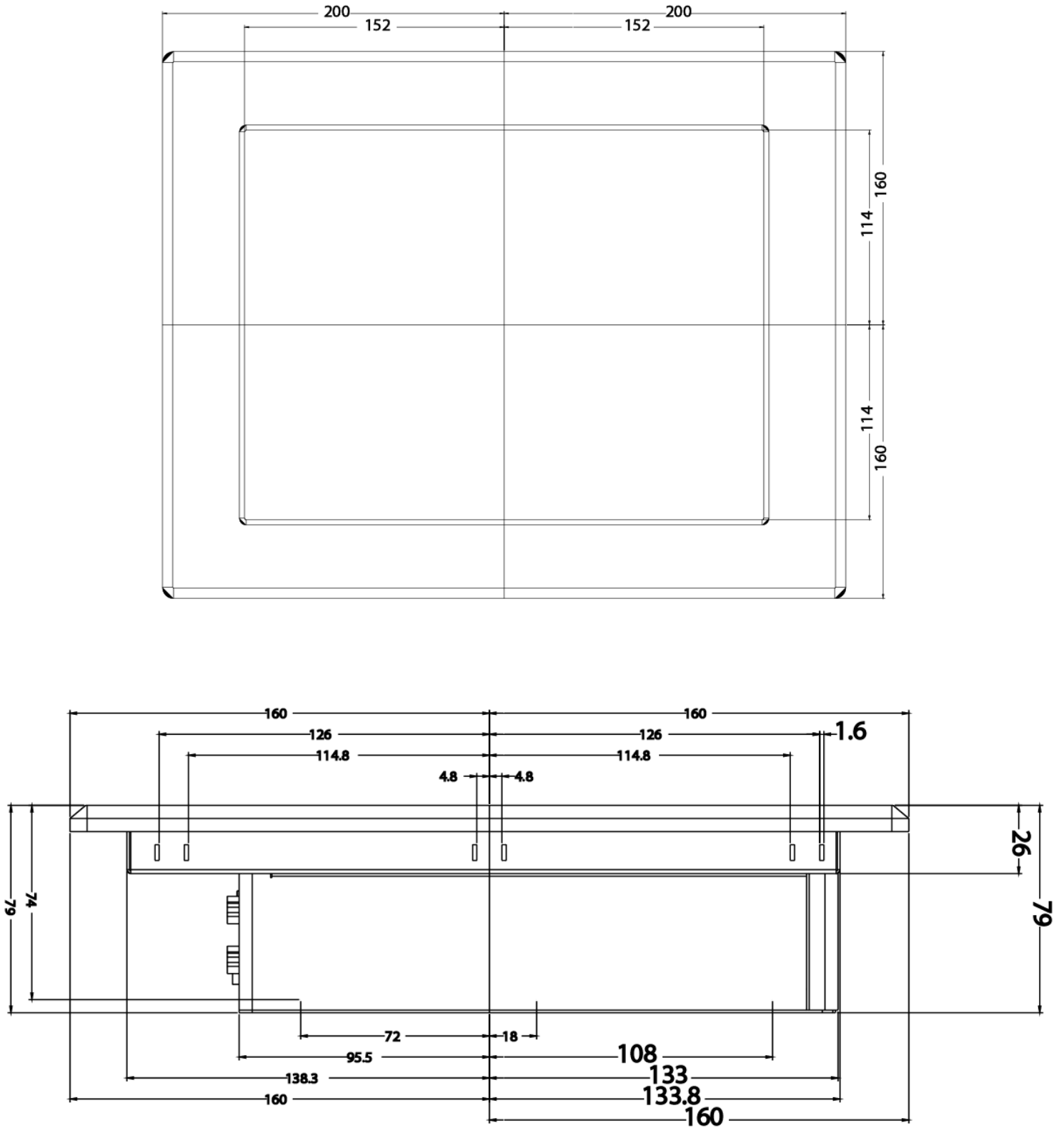

Figure 3.6 – ZX752 OCS Dimensions (mm)

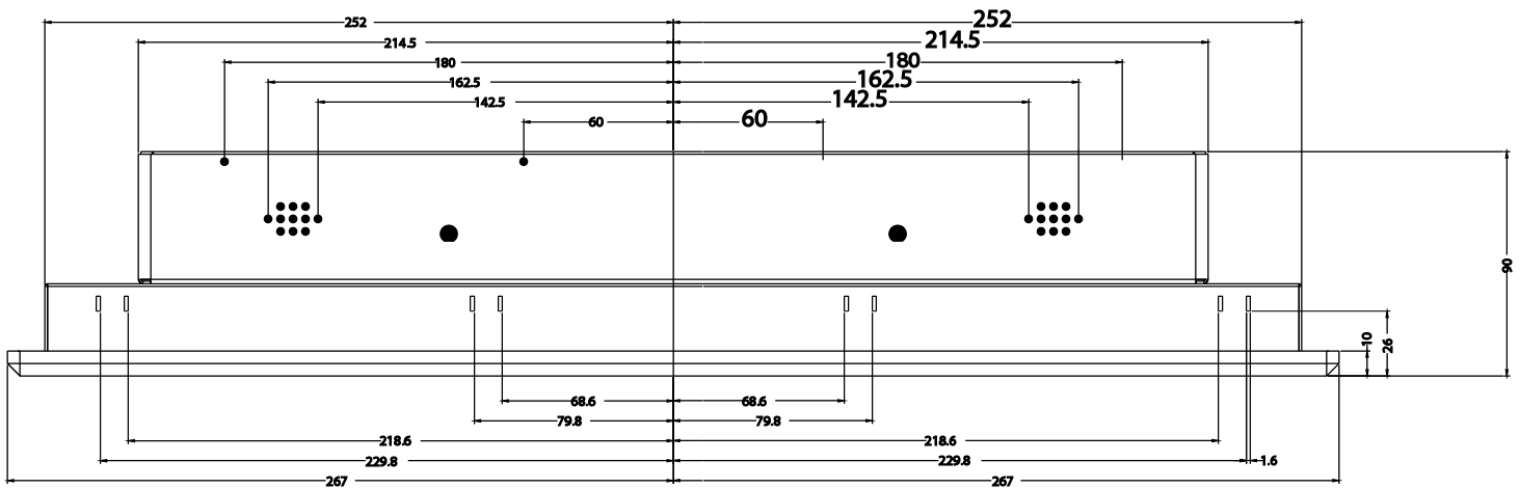
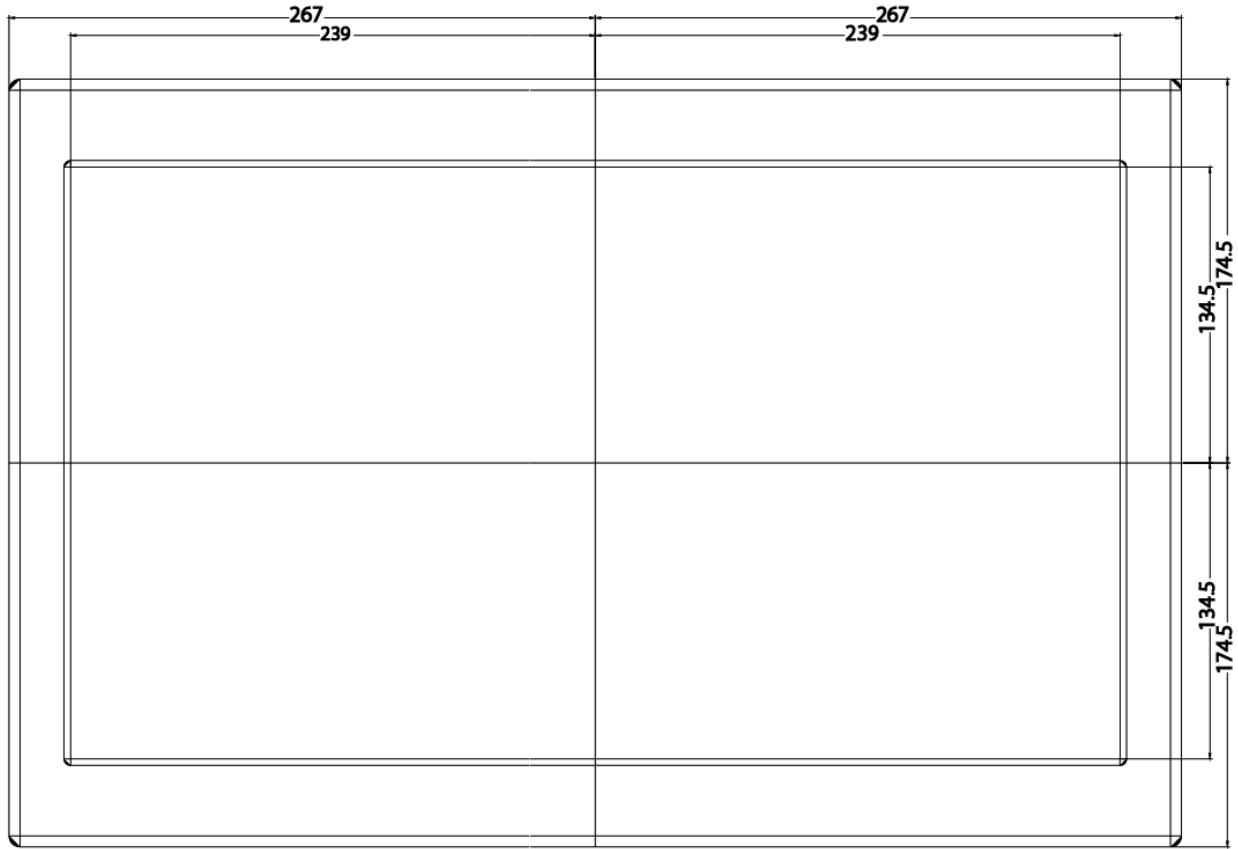

Figure 3.7 – ZX1152 OCS Dimensions (mm)

3.6 Factors Affecting Panel Layout Design and Clearances

Warning: It is important to follow the requirements of the panel manufacturer and to follow all applicable electrical codes and standards.

The designer of a panel layout needs to assess the requirements of a particular system and to consider the following design factors.

3.6.1 Clearance / Adequate Space

Install devices to allow sufficient clearance to open and close the panel door.

Table 3.1 – Minimum Clearance Requirements for Panel Box and Door	
Minimum Distance between base of device and sides of cabinet	2 inches (50.80mm)
Minimum Distance between base of device and wiring ducts	1.5 inches (38.10mm)
<u>If more than one device installed in panel box (or on door):</u> Minimum Distance between bases of each device	4 inches between bases of each device (101.60mm)
<u>When door is closed:</u> Minimum distance between device and closed door <i>(Be sure to allow enough depth for the OCS.)</i>	2 inches (50.80mm)

3.6.2 Grounding

Warning: Be sure to meet the ground requirements of the panel manufacturer and also meet applicable electrical codes and standards.

Panel box: The panel box must be properly connected to earth ground to provide a good common ground reference.

Panel door: Tie a low impedance ground strap between the panel box and the panel door to ensure that they have the same ground reference.

3.6.3 Temperature / Ventilation

Ensure that the panel layout design allows for adequate ventilation and maintains the specified ambient temperature range. Consider the impact on the design of the panel layout if operating at the extreme ends of the ambient temperature range. For example, if it is determined that a cooling device is required, allow adequate space and clearances for the device in the panel box or on the panel door.

3.6.4 Orientation

When panel-mounted, there are no orientation restrictions on the ZX OCS.

3.6.5 Noise

Consider the impact on the panel layout design and clearance requirements if noise suppression devices are needed. Be sure to maintain an adequate distance between the ZX OCS and noisy devices such as relays, motor starters, etc.

For details on output protection, especially when using contactors, solenoids... see MAN0962-01-EN.

3.6.6 Shock and Vibration

The ZX OCS has been designed to operate in typical industrial environments that may inflict some shock and vibration on the unit. For applications that may inflict excessive shock and vibration please use proper dampening techniques or relocate the ZX OCS to a location that minimizes shock and/or vibration.

3.6.7 Panel Layout Design and Clearance Checklist

The following list provides highlights of panel layout design factors:

- Meets the electrical code and applicable standards for proper grounding, etc.?
- Meets the panel manufacturer's requirements for grounding, etc.?
- Is the panel box properly connected to earth ground? Is the panel door properly grounded? Has the appropriate procedure been followed to properly ground the devices in the panel box and on the panel door?
- Are minimum clearance requirements met? Can the panel door be easily opened and closed? Is there adequate space between device bases as well as the sides of the panel and wiring ducts?
- Is the panel box deep enough to accommodate the ZX OCS?
- Is there adequate ventilation? Is the ambient temperature range maintained? Are cooling or heating devices required?
- Are noise suppression devices or isolation transformers required? Is there adequate distance between the base of the ZX OCS and noisy devices such as relays or motor starters? Ensure that power and signal wires are not routed in the same conduit.
- Are there other requirements that impact the particular system, which need to be considered?

NOTES

CHAPTER 4: ELECTRICAL INSTALLATION

Note: The datasheet is the first document to refer to for model-specific information related to ZX OCS models such as pin-outs and other key installation information. Visit the Horner websites to obtain datasheets, user documentation, and updates.

4.1 Grounding Definition

Ground: The term **ground** is defined as a conductive connection between a circuit or piece of equipment and the earth. Grounds are fundamentally used to protect an application from harmful interference causing either physical damage such as by lightning or voltage transients or from circuit disruption often caused by radio frequency interference (RFI). Grounding is also for the safety of the user.

4.2 Ground Specifications

Ideally, a ground resistance measurement from equipment to earth ground is 0 ohms. In reality it typically is higher. The U.S. National Electrical Code (NEC) states the resistance to ground shall not exceed twenty-five (25) ohms. Horner APG recommends *less than* fifteen (15) ohms resistance from our equipment to ground. Resistance *greater than* twenty-five (25) ohms can cause undesirable or harmful interference to the device.

4.3 How to Test for Good Ground

In order to test ground resistance, a Ground Resistance Tester must be used. A typical Ground Resistance Meter Kit contains a meter, two or three wire leads, and two ground rods. Instructions are supplied for either a two-point or three-point ground test.

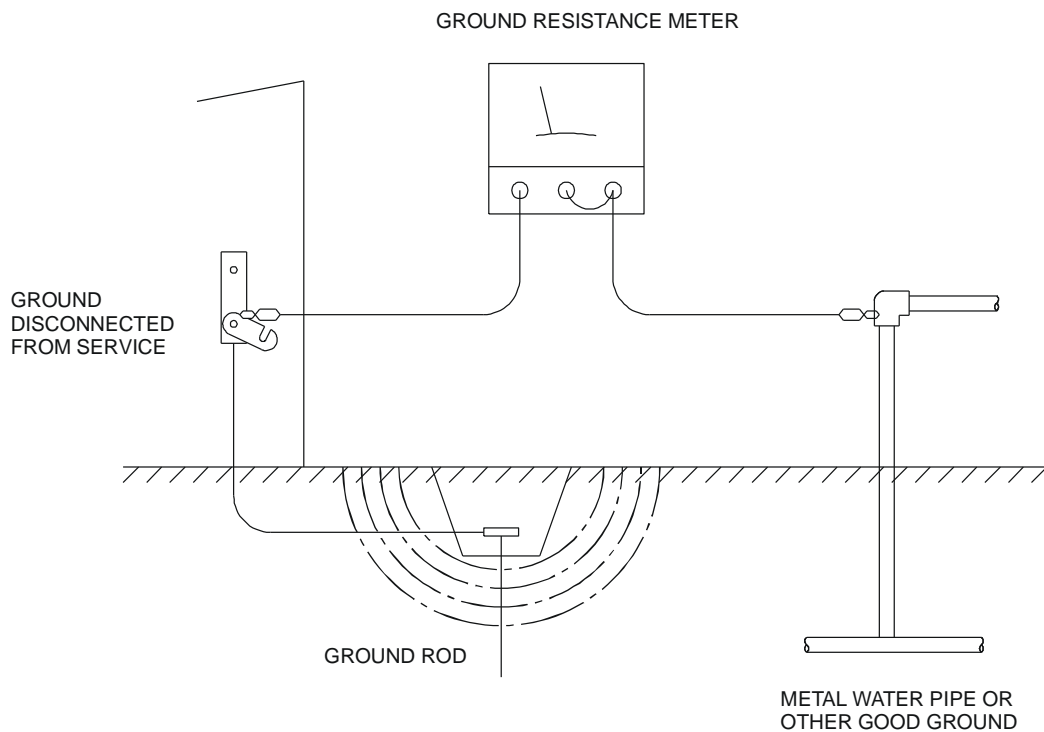

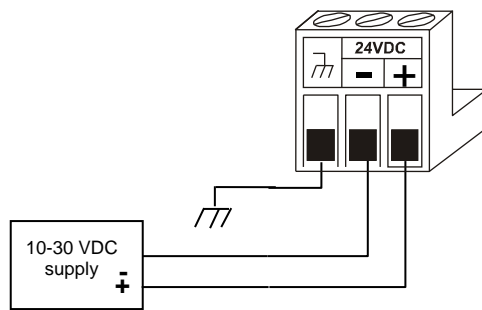

Figure 4.1 – Two-Point Ground Connection Test

4.4 Primary Power Port

Table 4.1 – Primary Power Port Pins		
PIN	Signal	Description
1		Frame Ground
2	0V	Input power supply ground
3	+24V	Input power supply positive voltage



Power Connector

Power Up:

- Connect to Earth Ground.
- Apply 10 – 30 VDC.
- Screen lights up.
- Torque rating 4.5 - 7 Lb-In
(0.50 – 0.78 N-m)

Figure 4.2 – Power Connector (Primary Power Port)

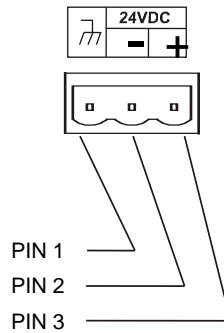

Figure 4.3 – Primary Power Port as Viewed Looking at the ZX OCS

CHAPTER 5: SERIAL COMMUNICATIONS

5.1 Overview

All ZX OCS models provide independent serial ports. The ZX452 model uses one RS232 and one RS485 port, and ZX752 and ZX1152 models come with an additional RS232 port. The MJ1 serial port is RS232 while the MJ2 port is RS485. By default, MJ1 can be connected to the COM port of a PC running Cscape, for OCS programming. In addition, both MJ1 and MJ2 can be used for application-specific communication, using a variety of standard data exchange protocols.

The second 8-pin modular RJ45 connector, which is labeled **MJ3**, provides a multiplexed serial port, which can be configured for either RS232 or RS485. MJ3 can be optionally set for OCS programming via the System Menu for connection to the COM port of a PC running Cscape.

5.2 Port Descriptions

The MJ1 serial port contains an RS232 interface with RTS/CTS handshaking. The MJ2 serial port contains a half-duplex RS485 interface with no handshaking. The MJ3 serial port can be configured as either RS232 or RS485. The MJ2 and MJ3 RS485 interfaces provide switchable termination and bias resistors internally, which can be enabled/disabled with DIP switches.

5.3 Serial Port Pin Assignments

Serial Port 1&3 Pin Assignments RS-232			
Pin	Signal	Signal Description	Direction
1	CD	Carrier Detect	IN
2	RX	Receive	IN
3	TX	Transmit	OUT
4	DTR	Data Terminal Ready	OUT
5	GND	Ground	-
6	DSR	Data Set Ready	IN
7	RTS	Request to Send	OUT
8	CTS	Clear to Send	IN
9	RI	Ring Indicate	IN

Serial Port 2 Pin Assignments RS-485			
Pin	Signal	Signal Description	Direction
1	TX/RX -	Receive/Transmit -	In/Out
2	TX/RX +	Receive/Transmit +	In/Out
3	NC	Do Not Connect	-
4	NC	Do Not Connect	-
5	GND	Ground	-
6	DSR	Data Set Ready	IN
7	RTS	Request to Send	OUT
8	CTS	Clear to Send	IN
9	RI	Ring Indicate	IN

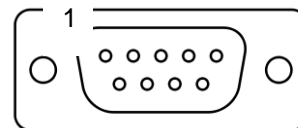

5.5 RS485 Biasing

RS485 biasing passively asserts a line-idle state when no device is actively transmitting, which is useful for multi-drop RS485 networking.

The **Set Serial Ports** item in the System Menu can be used to enable RS485 biasing. Also, an application graphics screen that writes to %SR164 can do the same thing. Setting %SR164.1 enables MJ2 biasing and setting %SR164.2 enables MJ3 biasing.

If biasing is used, it should be enabled in only one of the devices attached to the RS485 network.

5.6 Cscape Programming via Serial Port

The ZX Supports CsCAN Programming Protocol. If a PC COM port is connected to the ZX OCS RS232 serial port 1, Cscape can access the ZX OCS for programming and monitoring. If connecting via Serial Port for programming, it is important to use a **Null Modem** connection. Programming can also be done via the CAN port or Ethernet port, as covered in the following chapters.

5.7 Ladder-Controlled Serial Communication

Using Serial Communication function blocks serial ports support Generic Modbus Master and Modbus Slave Protocols. In addition, external modems can be connected and accessed using Init, Dial and Answer Modem function blocks.

5.8 Downloadable Serial Communication Protocols

Serial ports on the ZX also support downloadable protocols, such as Allen Bradley DF1, CsCAN Master, GE Fanuc SNP and Modbus Master.

NOTE: Refer to the Download section of the Horner websites for the list of latest supported protocols.

CHAPTER 6: CAN COMMUNICATIONS

Note: For additional CAN information, refer to the CAN Networks manual (MAN0799) on the Horner websites.

6.1 Overview

All ZX OCS models provide Dual CAN ports, which are implemented through a single six-pin connector for flexibility and compact controls. This grants the option for either single or dual connectors to be used. The port has **CAN1** and **CAN2** connections labeled separately.



Figure 6.1 – CAN1 & CAN2 Connector Locations ZX452 (Left) and ZX752/1152 (Right)

Like the serial ports, the CAN1 port can be used for ZX OCS programming by connecting it to the CAN port of a PC running Cscope. The CAN1 port allows the ZX OCS to exchange global data with other OCS/RCS controllers. Both CAN1 and CAN2 support accessing of remote network I/O devices (SmartStix, SmartBlock and SmartRail Modules.)

The CAN2 port supports CsCAN, CANopen, J1939 and DeviceNet Master (layer 3 as a selectable option – one only) such that the ZX can run dual protocols (CsCAN and an alternate) simultaneously.

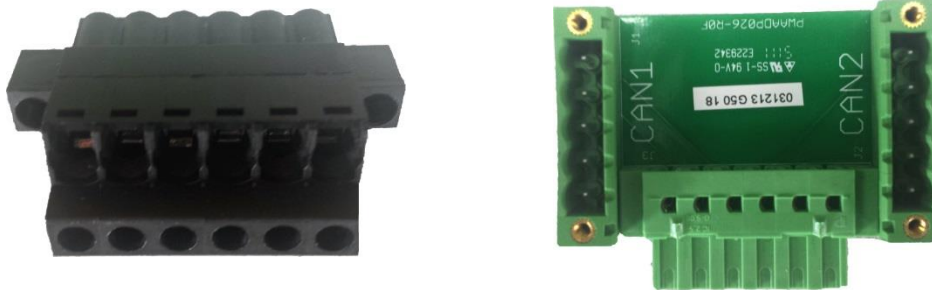

Single CAN Connector [left] (can be manually wired for Dual CAN networks) and Dual CAN adapter [right]

6.2 Port Description

The ZX OCS CAN ports implement the ISO 11898-2 physical layer and the CAN 2.0A data link layer standards. Also, since the CAN ports are powered by an internal isolated power supply, external CAN power is not required.

The single six-pin port on the unit can be easily split and set up for dual ports by adding the dual port adapter that comes with the ZX unit. The Dual Port Adapter splits the connection so that both utilize the standard CAN wiring.

The multiple CAN protocol configurations allows for flexibility in control and communications using a wide variety of I/O and auxiliary devices in a network. See below for CAN port details.

6.3 CAN Port Wiring

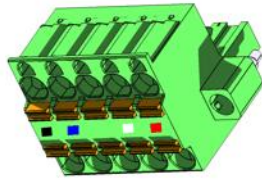

CAN Connector
 Use the CAN Connector when using CsCAN or other CAN network.
 Torque rating 4.5 – 7 Lb-In
 (0.50 – 0.78 N-m)

CAN1 & CAN2 Port Pins			
Pin	Signal	Signal Description	Direction
1	V-	Power -	–
2	CN_L	CAN Data Low - Blue	In/Out
3	SHLD	Shield	–
4	CN_H	CAN Data High - White	In/Out
5	V+	Power +	–

Figure 6.2 – CAN1 / CAN2 Port Pins (Single above when used with adapter, Dual Below)

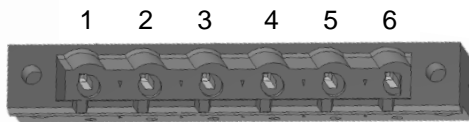

Single port, dual CAN Connector
 Use the CAN Connector when using CsCAN or other CAN network.
 Torque rating 4.5 – 7 Lb-In
 (0.50 – 0.78 N-m)

CAN 1 Pin Assignments			
Pin	Signal	Signal Description	Direction
1	#1 V-	CAN #1 Ground - Black	–
2	#1 CN_L	CAN #1 Data Low - Blue	In/Out
3	#1 CN_H	CAN #1 Data High - White	In/Out
CAN 2 Pin Assignments			
Pin	Signal	Signal Description	Direction
4	#2 V-	CAN #2 Ground - Black	–
5	#2 CN_L	CAN #2 Data Low - Blue	In/Out
6	#2 CN_H	CAN #2 Data High - White	In/Out

6.4 Cscape Programming via CAN

The CAN1 port supports CsCAN Programming Protocol. If a PC has a CAN interface installed (via PCI card or USB), and the PC CAN port is connected to the ZX OCS CAN1 port, Cscape can access the ZX OCS for programming and monitoring.

In addition, the ZX OCS supports single-point-programming of all ZX OCS and other OCS/RCS devices that are connected to the CAN1 port network. If the PC COM port is connected to the ZX OCS MJ1 serial port, the ZX OCS can act as a pass-through gateway allowing Cscape to access all ZX OCS and OCS/RCS devices that are attached to the CAN1 port network.

6.5 Ladder-Controlled CAN Communication

Using Put and Get Network Words function blocks, the CAN 1 port can exchange digital and analog global data with other ZX OCS or OCS/RCS devices (nodes) attached to the CAN1 port network.

In addition, Put and Get Network Heartbeat function blocks allow nodes on the CAN 1 port network to regularly announce their presence and to detect the presence (or absence) of other nodes on the network.

6.6 Using CAN for I/O Expansion (Network I/O)

Connecting Network I/O devices (SmartStix, SmartBlock or SmartRail) to the ZX OCS CAN1 or CAN2 port, allows the ZX OCS I/O to be economically expanded and distributed. A variety of modules are available for this purpose.

CHAPTER 7: ETHERNET COMMUNICATION

7.1 Ethernet Module Protocols and Features

The following table describes the Ethernet Module Protocols and features supported by ZX.

Protocol / Feature	Protocol / Feature Description
ICMP Ping	Internet Control Message Protocol
EGD (Peer)	Ethernet Global Data
SRTP Server	Service Request Transfer Protocol
CsCAN TCP Server	Horner APG CsCAN over Ethernet
Modbus TCP Slave	Modbus over Ethernet
Ethernet / IP Server	ODVA CIP over Ethernet
FTP Server	File Transfer Protocol
HTTP Server	HyperText Transfer Protocol (Web Server)

Table 7.1 – Ethernet Module Protocols & Features

7.2 Ethernet System Requirements

Full Ethernet functionality requires:

- PC running Cscape Programming Software Version 9.3 SP6 or later (for configuration).
- ZX
- FTP & HTTP protocols.

7.3 Ethernet Module Specifications

Speeds	10 BaseT Ethernet (10-Mbps) 100 BaseTx High-Speed Ethernet (100-Mbps)
Modes	Half or Full Duplex
Auto-Negotiation	Both 10/100-Mbps and Half/Full Duplex
Connector Type	Shielded RJ-45
Cable Type (Recommended)	CAT5 (or better) UTP
Port	Auto MDI/MDI-X (Auto Crossover)

Table 7.2 – Ethernet Module Specifications

7.4 Ethernet Configuration

Note: The following configuration is required for all applications regardless of the protocols used. Additional configuration procedures must be performed for each protocol used.

To configure the Ethernet communications, use Cscape Programming Software to perform the following steps:

1. On the main Cscape screen, select the **Controller → Hardware Configuration** (Figure 7.1)
2. Ensure the correct controller **Series, Device, and Model #**.
3. Click **Config** to the right of **LAN 1 or LAN2** (whichever is preferred for Programming) to open the Ethernet Configuration screen (Figure 7.2).

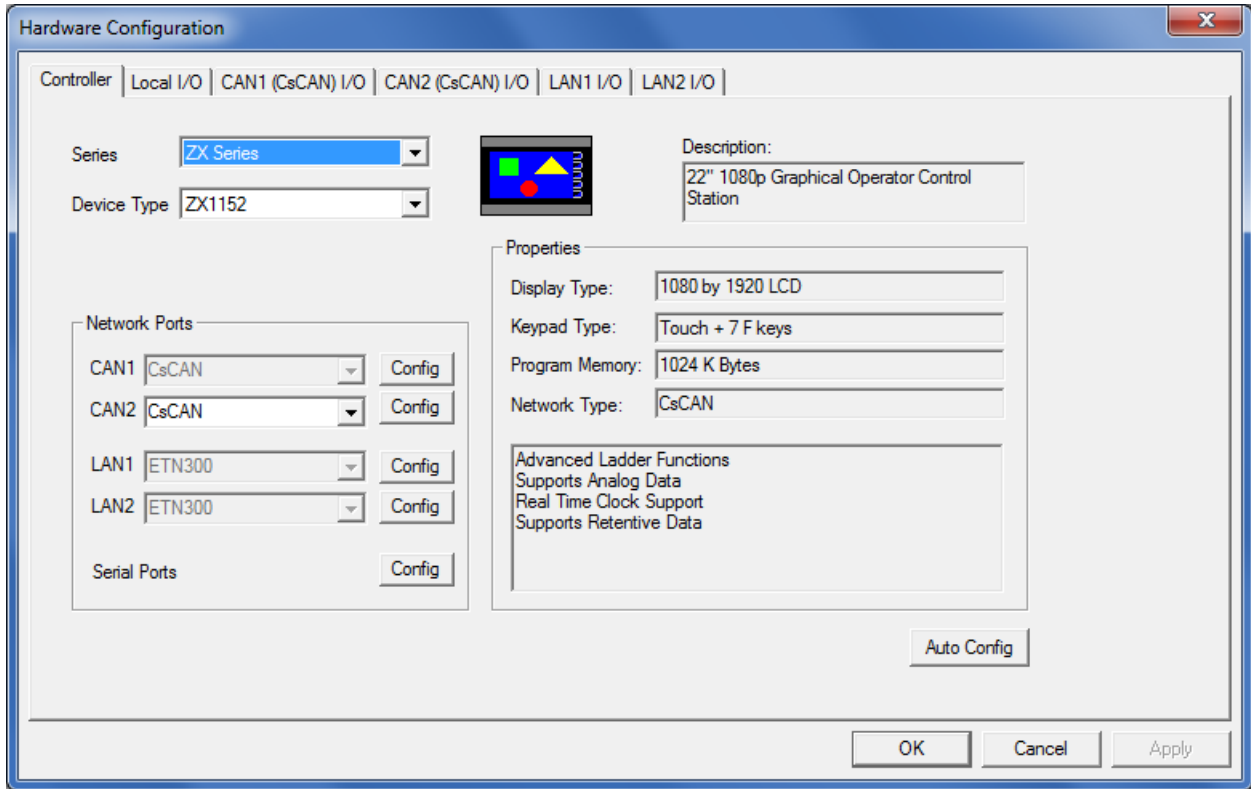
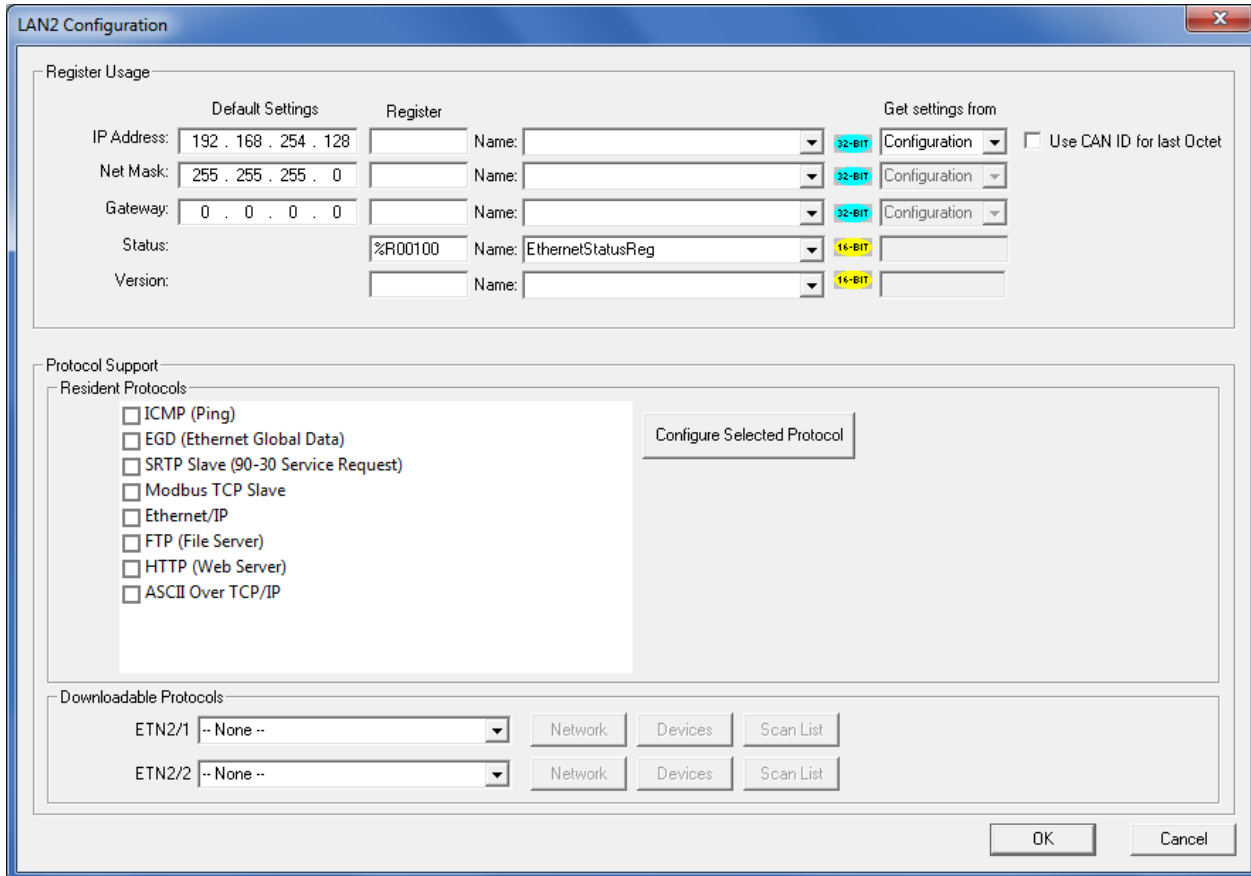

Figure 7.1 – Hardware Configuration Dialog (above)

Figure 7.2 Ethernet Configuration (below)



- Configure the Ethernet Module parameters as follows:

IP Address	Enter the static IP Address for the Ethernet Module being configured. Note: IP Addresses are entered as four numbers, each ranging from 0 to 255. These four numbers are called octets and they are always separated by decimal points. Must be unused on network
Net Mask	Enter the Net Mask (sometimes called Subnet Mask) being used by all nodes on the local network. Typical local networks use Class C IP Addresses, in which case the low octet (rightmost number) is used to uniquely identify each node on the local network. In this case, the default Net Mask value of 255.255.255.0 should be used.
Gateway	Enter the IP Address of a Gateway Server on the local network that allows for communication outside of the local network. To prevent the Ethernet Module from communicating outside the local network, set the Default Gateway IP Address to 0.0.0.0 (the default setting).
Status Register (See Table 7.1)	Enter an OCS Register reference (such as %R100) to indicate which 16-bit OCS register will have the Ethernet Status word written to it. Table 7.1 shows how this register value is formatted and explains the meaning of each bit in the Status Word. Must be entered prior to programming
Version Register	Enter an OCS Register reference (such as %R101) to indicate which 16-bit OCS register will have the Ethernet Firmware Version written to it. The value stored in the Version Register is: (Ethernet Firmware Version * 100). For example, for Ethernet Firmware Version 4.30, the Version register will contain 430.

- Configure the Ethernet setting in the System menu, entering appropriate I/P address for the controller:

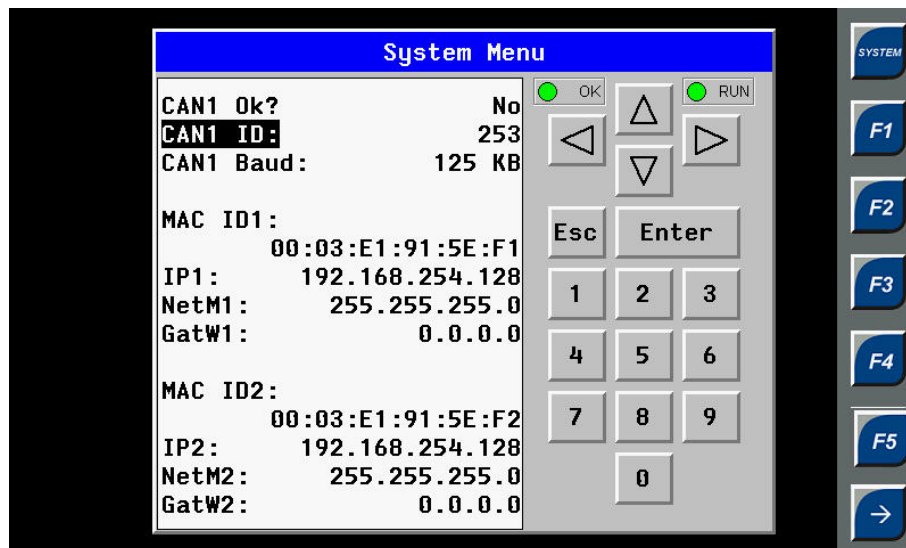

Table 7.3 - Ethernet Status Word Register Format															
High Byte								Low Byte							
Bit 16	Bit 15	Bit 14	Bit 13	Bit 12	Bit 11	Bit 10	Bit 9	Bit 8	Bit 7	Bit 6	Bit 5	Bit 4	Bit 3	Bit 2	Bit 1
0	0	Dup	Spd	0	Rx	Tx	Link	TCP Connections							
Status Bit(s)		Status Indication						Status Values							
								Minimum	Maximum						
0		Reserved						Always 0							
Dup		Link Duplex (Auto-Negotiated)						0 = Half Duplex	1 = Full Duplex						
Spd		Link Speed (Auto-Negotiated)						0 = 10 MHz	1 = 100 MHz						
Rx		Receive State						0 = Inactive	1 = Active						
Tx		Transmit State						0 = Inactive	1 = Active						
Link		Link State						0 = Down	1 = Up						
TCP Connections		Total Number of Active TCP Connections (CsCAN, SRTP, Modbus, EIP, FTP, HTTP)						0	40						

CHAPTER 8: REMOVABLE MEDIA

8.1 Overview

All ZX OCS models provide dual USB drives for increased storage and functionality. Flash storage drives can be used to save and load applications, to update firmware, to capture graphics screens and to log data for later retrieval.

Note: The USB ports on the ZX units are not designed for Programming with Cscape.

The drives, **Drive A** and **Drive B** serve different primary functions for the controller.

Drive A is the primary port for data logging, program or application saving and loading (cloning), firmware updating, and screen shot saving.

Drive B is mainly used for alternate Removable Media Function Blocks in ladder logic.

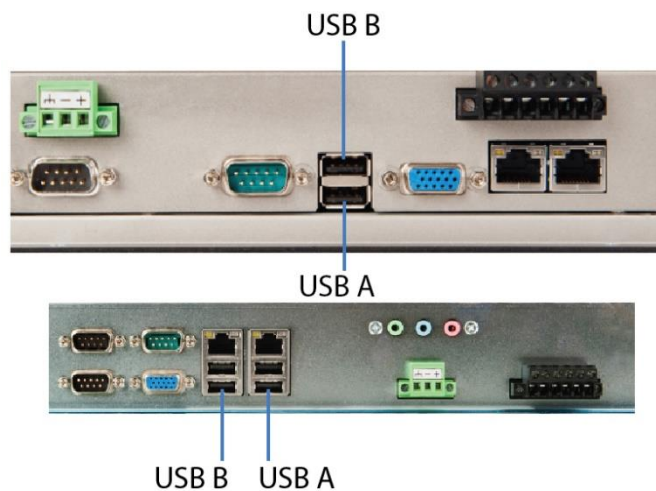

Figure 8.1 –USB Ports: ZX452 (top) and ZX752/1152 (bottom)

8.2 Removable Media File System

the ZX OCS does not support long filenames, but instead implements the 8.3 filename format. This means that all file and directory names must consist of up to 8 characters, followed by an optional dot, and an optional extension with up to 3 characters.

Directories and sub-directories can be nested up to 16 levels deep as long as each pathname string does not exceed 147 characters.

8.3 Using the Removable Media Manager

The Removable Media Manager is an interactive ZX OCS screen that performs the following functions:

- a. Display number of total and free K bytes
- b. Browse file and directory lists
- c. Delete files and directories
- d. Format a Removable Media
- e. Load and save application programs
- f. View screen capture bitmaps

The Removable Media Manager can be accessed via the System Menu or by using Cscape to place a Removable Media Manager object on an application graphics screen.

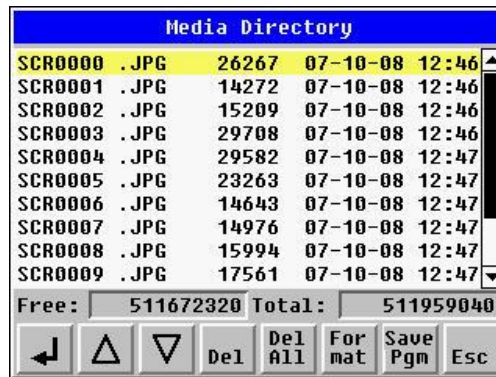



Figure 8.2 – Removable Media Submenu

8.4 Using Removable Media to Log Data

Using Read and Write Removable Media function blocks, an application ladder program can read and write ZX OCS register data in the form of comma-delimited files, with a .CSV extension. These files are compatible with standard database and spreadsheet PC programs. In addition, an application ladder program can use Rename and Delete Removable Media function blocks to rename and delete files.

8.5 Using Removable Media to Load and Save Applications

To load an application from Flash Drive to the ZX OCS, use the Removable Media Manager (open the Removable Media Manager in the System Menu) to find and highlight the desired .PGM file, and then press the Enter key. 

To save an application from the ZX to Flash storage, open the Removable Media Manager in the System Menu and press the Save Pgm  function key. The application will be saved in a file called **DEFAULT.PGM** in the microSD root directory.

NOTE: Saving an application to Flash can only be done from the Removable Media System Menu and is not available on a Removable Media Manager object that was placed on an application graphics screen by Cscape. Cscape can also save an application directly to a flash drive, which is plugged into the PC's compatible USB port by selecting the Export to Removable Media item on the Cscape File menu.

8.6 Using Removable Media to View and Capture Screens

The OCS File System uses bitmap files with the .BMP extension to store OCS graphic screen captures.

To view a captured OCS screen:

1. Open the Removable Media Manager
2. Find and highlight the desired .BMP file, and then press Enter. 

To capture an OCS screen:

1. Turn On the assigned **Screen Capture Control Register** in Cscape Graphic Editor
 - a. Open **Edit / View Screens**
 - b. Select **Config→Screen Capture** from the top dropdown menu.
 - c. Assign Control Register (optional) for a button press or a system key, and define file name as below (here, the screenshot will be processed on F5 key press):

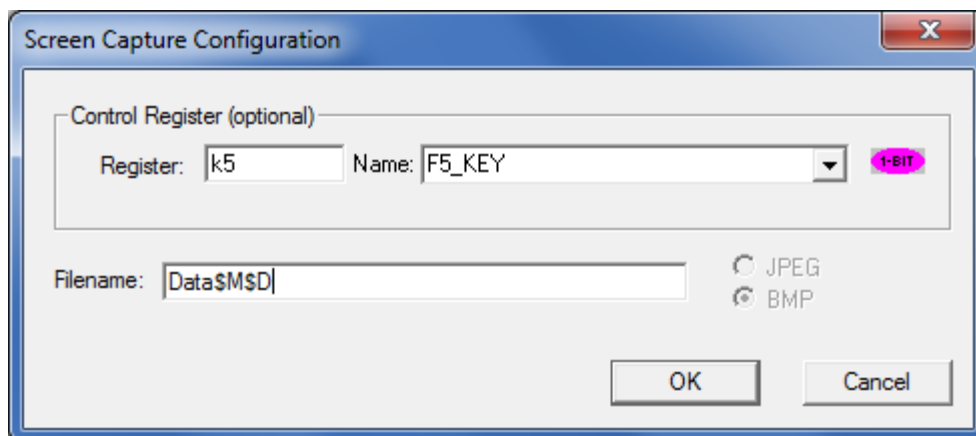

Note: The file will be stored on the SD Card with the appropriate file name. Use Table 8.1 below for more details on the filename system.

8.7 Removable Media (RM) Function Blocks in Cscape

Note: For detailed information regarding RM function blocks and parameters, refer to the help file in Cscape Software. Refer 'USB Flash Media support for RM Functions' for USB flash drive access details.

The following RM functional blocks are available in Cscape Software. These function blocks will reference - USB A Flash Drive when filename is prefixed with 'B:'.

Action	Description
Read RM csv	
Write RM csv	
Rename RM csv	This function allows renaming a file on the RM card. The data in the file is not changed.
Delete RM csv	This function allows deleting a file on the RM card.
Copy RM csv	This function allows copying a file on the RM card. The data in the file is not changed

8.8 Filenames used with the Removable Media (RM) Function Blocks

The RM function blocks support the flash with a DOS/Windows standard FAT-16 file system. All names must be limited to the “8.3” format where the filename contains eight characters a period then a three-character extension.

The entire filename including any path must be less than or equal to 147 characters.

When creating filenames and directories it is sometimes desirable to include parts of the current date or time. There are six special symbols that can be entered into a filename that are replaced by the OCS with current time and date information.

Table 8.1 – Filename Special Symbols		
Symbol	Description	Example
\$Y	Substitutes the current 2 digit year	2004 = 04
\$M	Substitutes the current month with a 2 digit code	March = 03
\$D	Substitutes the current day	22 nd = 22
\$h	Substitutes the current hour in 24 hour format	4 pm = 16
\$m	Substitutes the current minute	45 = 45
\$s	Substitutes the current second	34 = 34

NOTE: All the symbols start with the dollar sign (\$) character. Date symbols are in upper case, time symbols are in lower case. The following are examples of the substituted time/date filenames:

Current date and time: March 1, 2004 3:45:34 PM

Filename: Data\$M\$D. **csv** = Data0301.csv

Filename: Year\$Y\Month\$M\aa\$D_\$h. **csv** = Year04\Month03\aa01_15.csv

Filename: Month_\$M\Day_\$D\\$h_\$m_\$s. **csv** = Month_03\Day_01\15_45_34.csv

8.9 System Registers used with RM

%SR175	Status – This shows the current status of the RM interface.
%SR176	Free Space – This 32-bit register shows the free space on the RM card in bytes.
%SR178	Card Capacity – This 32-bit register shows the total card capacity in bytes.

Possible status values are shown in the table:

Table 8.1 – RM Status Values	
0	RM interface OK
1	Card present but unknown format
2	No card in slot
3	Card present, but not supported
4	Card swapped before operation was complete
5	Unknown error

CHAPTER 9: REMOTE I/O CONFIGURATION

The ZX family controllers are easy to set up with remote I/O to suit any application needs. For the most compact, economical, and flexible control, the SmartRail line of I/O devices are recommended.

SmartRail I/O systems consists of a base with a specific type of communications, ethernet (ModBus TCP or Ethernet I/P) or CsCAN, that have configurable, customizable modular I/O modules attached.

With this system, any I/O needs can be met, and easily expanded in the future by adding additional modules to a base or additional bases to a network.

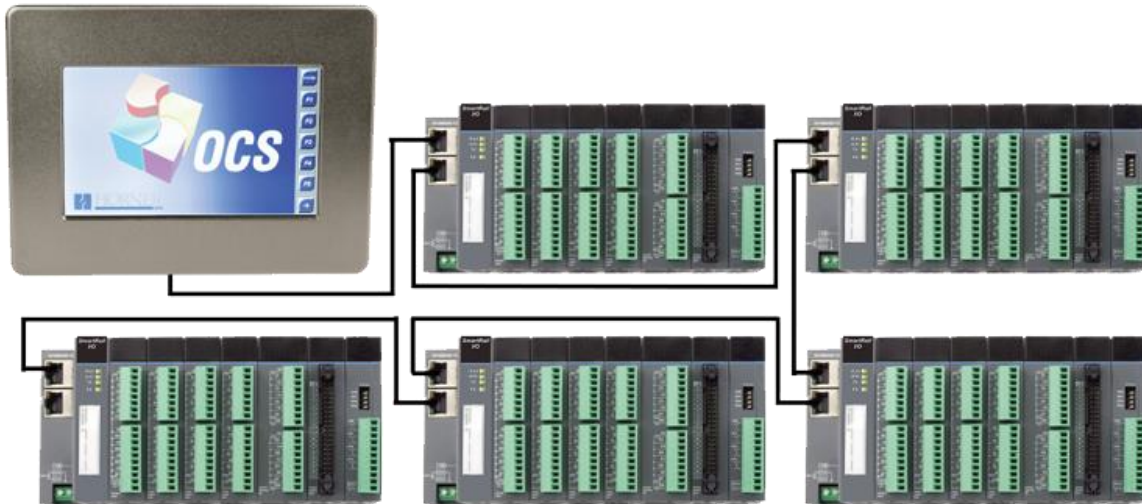

The following section covers a quick setup to show the flexibility and control the SmartRail I/O system offers, using Ethernet communications (CsCAN configuration is similar, only different base configuration is required):

9.1 Configuration of ETX200 Ethernet SmartRail Base and I/O Modules

1. Open the Hardware Configuration screen and click the **LAN2 I/O** tab. First, add the base to the LAN2 configuration. Then, configure the I/O modules attached.
2. Click **Add Base** to bring up the **Configure SmartRail**
3. Configure the following options:

Field	Description
Base Name	Nickname for the Module Base
Base IP	IP address for the Base. Must be static and unique to the network.
Assign IP using Boot-P to MAC ID	Click to enable, then enter MAC ID address that can be found on the base unit itself . This allows for the base to receive a configuration message upon power cycle automatically.
Status Register	Keeps track of status of the Base Unit. See below for bit information and mapping.
Digital Inputs Start	The first register the digital inputs will be mapped to. Example: %I0001.
Digital Outputs Start	The first register the digital outputs will be mapped to. Example &Q0001.
Analog Inputs Start	The first register the analog inputs associated with that base will be mapped to: Example %AI0001.
Analog Outputs Start	The first register the analog outputs associated with that base will be mapped to. Example %AQ0001.

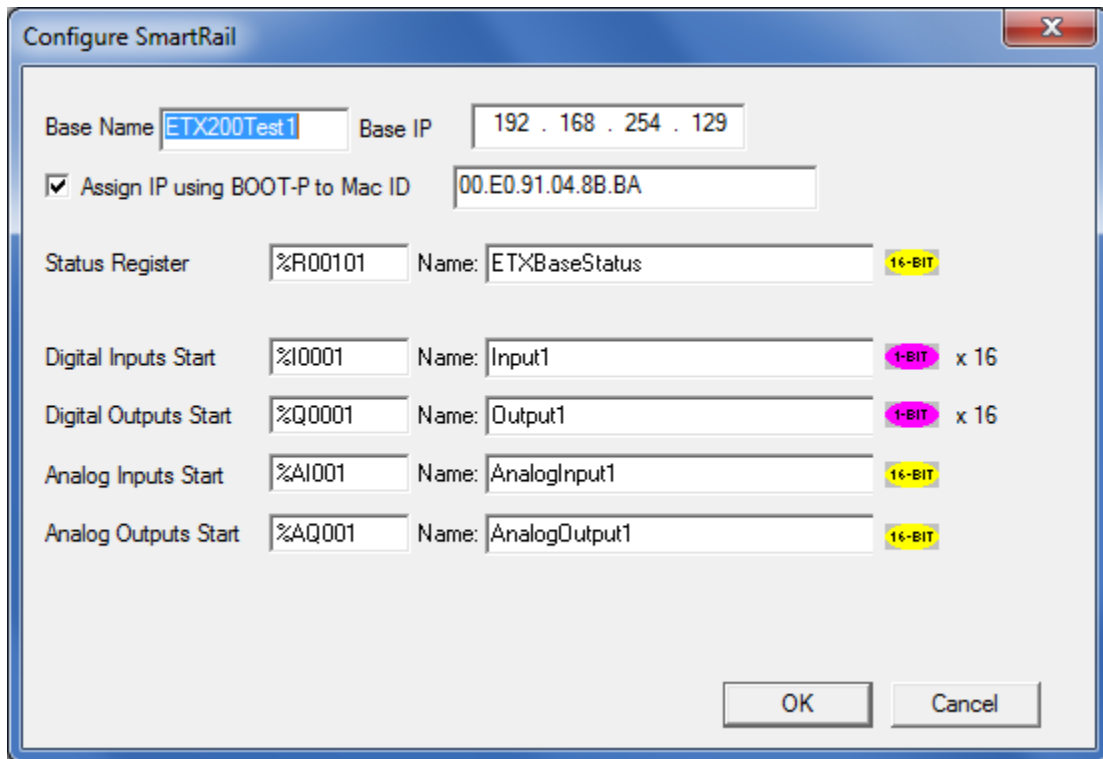

Note: When configuring Initial I/O start registers, take into consideration other I/O modules in the system and the registers they use. If the SmartRail I/O is the first added to the network, as in above example, then make “1” the starting register. The modules added to the base will automatically assign registers for the inputs and outputs.

4. Click **OK**
5. Now, Add the appropriate modules to the bases. Click **Add Module**.
6. Select the appropriate module to add from the menu lists, in order from first to last, beginning with the first module added to the base.

Note: Total of up to 8 with less than 1500 mA of draw per base (calculated in hardware configuration automatically) allowed. Analog modules and relay modules use more power, so keep this in mind when configuring a bases. Depending on the Modules added to the base, the Registers will accumulate automatically, as highlighted below:

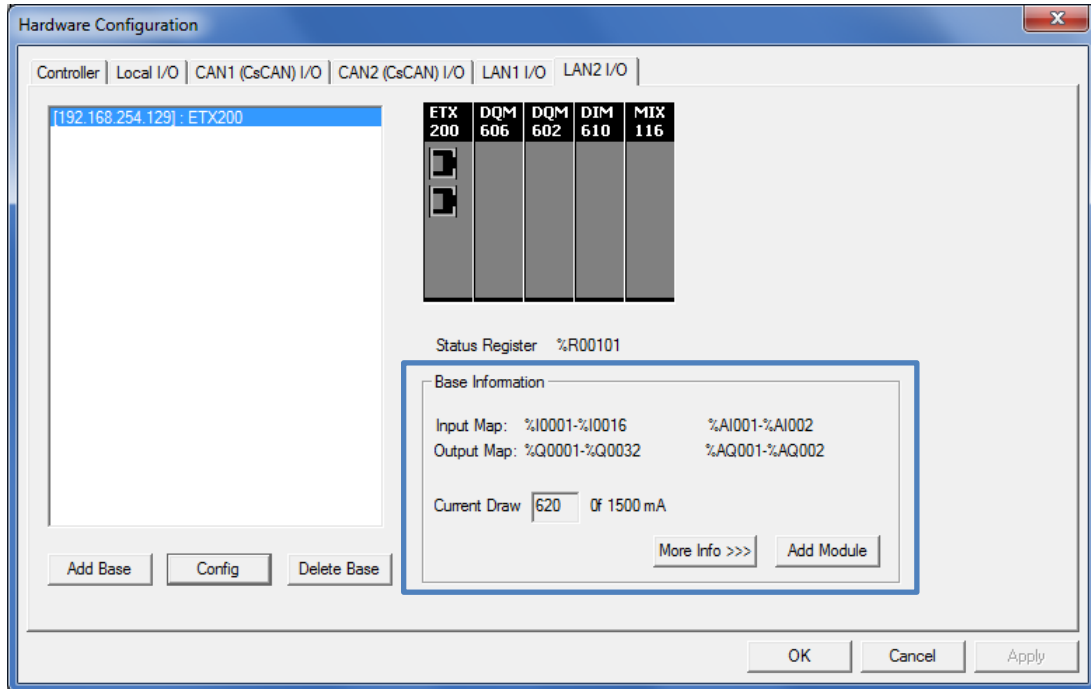

7. Several bases can be added with similar steps, just ensure a unique I/P address is used for each base. Whenever another base is added, the configuration will automatically update the initial I/O registers depending on the base previously added. Example: if base 1 ended at %I0016 and %Q016, base 2 would start automatically at %I0017 and %I0017.
8. Ensure the ZX OCS has proper I/P address entered on the **Set Networks** tab in the **System Menu**

9.2 Configuring Other I/O using CsCAN

CsCAN I/O can also be configured to the two CAN port options that become available when using the single six port to two five port adapter as seen below:



To configure the CsCAN network:

- 1) Go to **Hardware**→**CAN1 I/O** (or CAN2, depending on which port used)
- 2) Click **Add**
- 3) Select CAN I/O module from the available menus. Example: **Smartblock HE579DIQ880**:

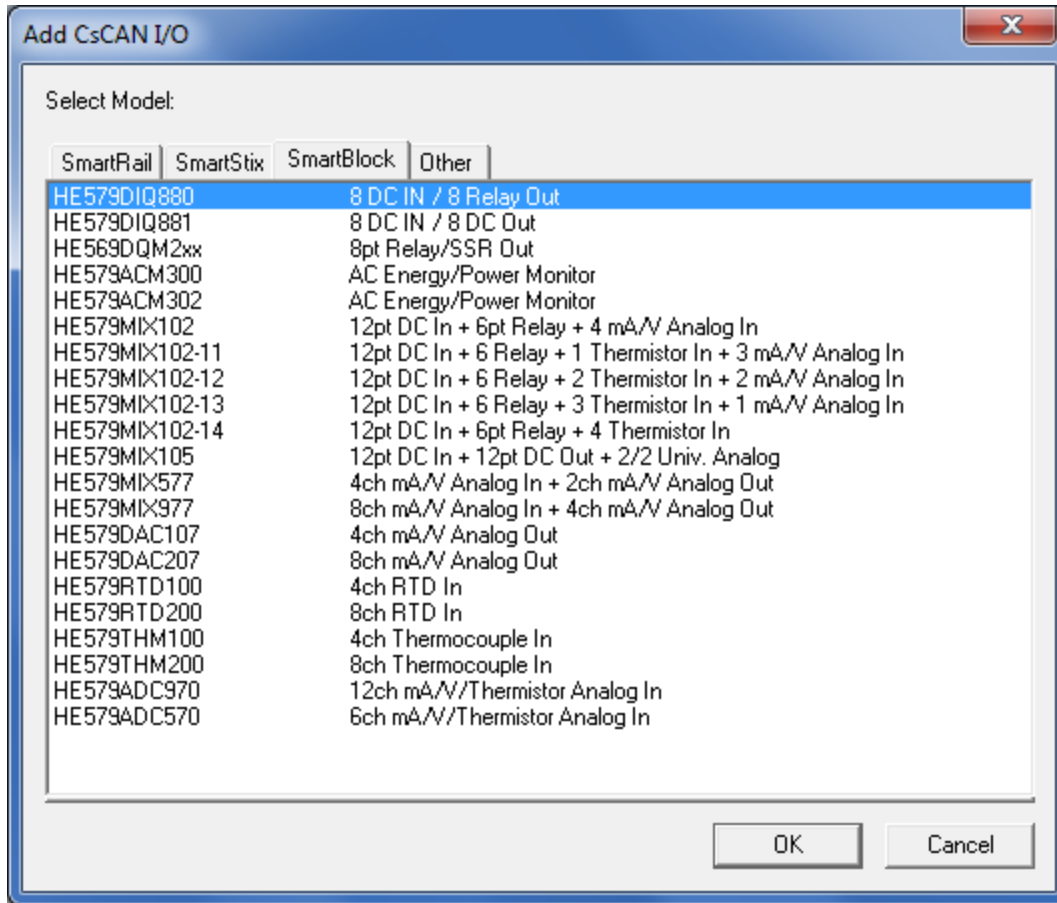

- 4) Press **OK**
- 5) Configure the following options in the **Configure Digital Network I/O** window:

Field	Description
Network ID	Identification position of the I/O module on the network for programming purposes.
Digital inputs active mode	Select whether to utilize positive (default) or negative logic.
Start digital In	Starting register for the Digital Inputs on the Module
Start digital out	Starting register for the Digital Outputs on the Module
Status register	Status register for the module (see below)
Update method	Update on change of state: Updates when the value of the input changes Update periodically: Updates at a set interval (100 mSec- 25.5 Sec)
Comm Timeout	Maximum time the module will wait to indicate or act on communication before timing out. (Set between 400 mSec to 25.5 Sec)

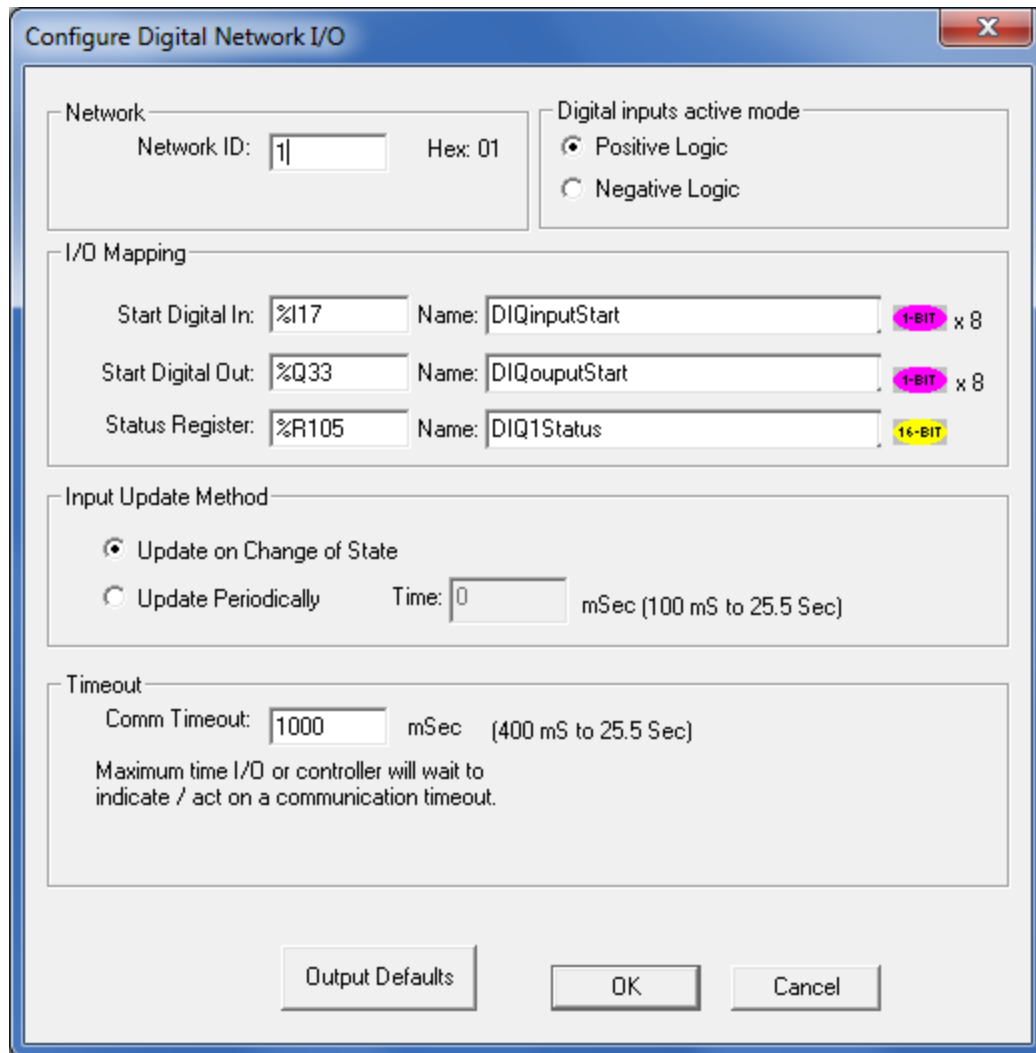

Configure Digital Network I/O

Network
 Network ID: Hex: 01

Digital inputs active mode
 Positive Logic
 Negative Logic

I/O Mapping

Start Digital In: <input type="text" value="%I17"/>	Name: <input type="text" value="DIQinputStart"/>	1-BIT x 8
Start Digital Out: <input type="text" value="%Q33"/>	Name: <input type="text" value="DIQouputStart"/>	1-BIT x 8
Status Register: <input type="text" value="%R105"/>	Name: <input type="text" value="DIQ1Status"/>	16-BIT

Input Update Method
 Update on Change of State
 Update Periodically Time: mSec (100 mS to 25.5 Sec)

Timeout
 Comm Timeout: mSec (400 mS to 25.5 Sec)
 Maximum time I/O or controller will wait to indicate / act on a communication timeout.

Output Defaults OK Cancel

Note: The “Start” in and out registers for each module will be populated based on the previous I/O module entered. After the initial I/O module is configured, subsequent modules will have Start registers auto-populated based on the registers already in use.

If other registers %I and %Q registers are desired or required, they can be manually configured otherwise. The values will all be dependent on the initial I/O device being configured.

6) Select output Defaults to modify the default state of outputs.

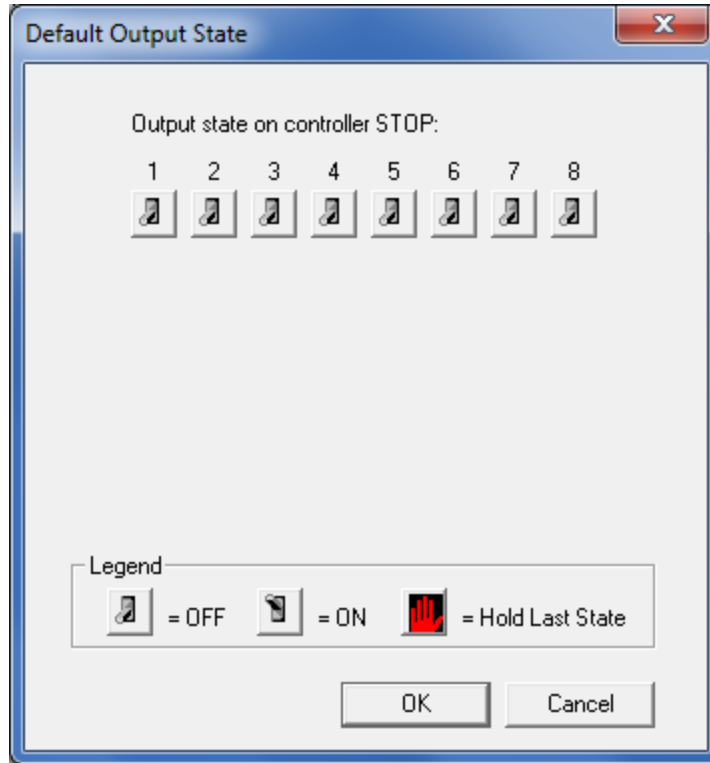

Other I/O configuration methods exist; the previous chapter only gives examples of some of the communication and I/O options that can be used with the ZX. Other protocols or communications options are available, but are out of the scope of this section.

CHAPTER 10: SYSTEM SETTINGS AND ADJUSTMENTS

10.1 System Menu – Overview



The ZX has a built-in System Menu, which lets the user view System Settings and makes adjustments. To start the System Menu, press the SYSTEM key (or set %SR3 to 1), which will display the Main Menu. Then use the ↓ and ↑ (Up Arrow or Down Arrow) keys to select a **Main Menu** item and press **Enter** (Return Arrow) to display the item's Sub-Menu.

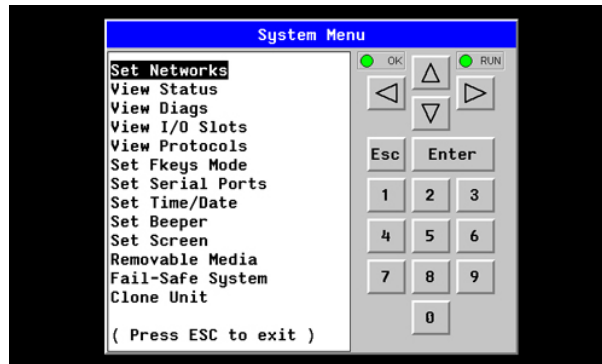



Figure 10.1 – System Menu (ZX) Screenshot

10.2 System Menu – Navigation and Editing

As mentioned above, the System Menu is started by pressing the System key on softkey menu bar (press top-right corner of screen to display) on the ZX. Next press **ESC** to exit the System Menu, or use ↓ and ↑ to select an item and press **Enter**  to display the item's Sub-Menu.

A Sub-Menu generally shows a list of System Settings and their values. After opening a Sub-Menu, if any of its System Settings are editable, the first System Setting that can be edited is highlighted. If desired, the ↓ and ↑ keys can be used to select a different System Setting to be edited.

At this point, either press **ESC** to exit the Sub-Menu (returning to the Main Menu) or press **Enter** to edit the highlighted System Setting. If **Enter** is pressed, the System Setting's value will be highlighted, indicating that it is ready to be modified.

When modifying a System Setting's value, use either the arrow keys (← → ↓ ↑)  or the numeric keys, or the appropriate touch screen icons to select a new value.

The arrow keys are used to edit System Settings that have just a few possible values. Each time the arrow key is pressed, a new possible value is displayed. When the desired value appears, press the **Enter** key to save it; otherwise press the **ESC** key to cancel the edit.

The numeric keys are normally used to enter numeric System Settings.



In addition, to edit a single numeric digit, use the ← or → key to select the digit and then either press a numeric key or use ↓ or ↑ to modify the digit. In any case, after entering the new desired value, press the **Enter** key to save it; otherwise press the **ESC** key to cancel the edit.

10.3 System Menu – Details

The following sections describe each of the Sub-Menus in detail.

Set Networks

This sub menu allows setting for the CAN and Ethernet network to be viewed or changed.

CAN Ok?	Yes= CAN1 connected to a CAN network and functioning properly No= Not ready to communicate on CAN network	
CAN ID	1 to 253 = This node's CsCAN Network ID; must be unique on network	
CAN Baud	125 KB = 125 KBaud CAN network 250 KB = 250 KBaud CAN network	500 KB = 500 KBaud CAN network 1 MB = 1 MBaud CAN network
MAC ID	Displays the Ethernet MAC ID of the unit	
IP	Displays the Ethernet IP address of the unit	
NetM	Displays the Ethernet net mask of the unit	
GatWy	Displays the Ethernet gateway of the unit	

NOTE: The IP address, Net Mask and Gateway can be changed from the system menu. This is designed for commissioning or temporary field changes. The actual parameters are defined in Cscape under the Ethernet configuration and are reverted to whenever the unit goes from idle to run mode.

View Status

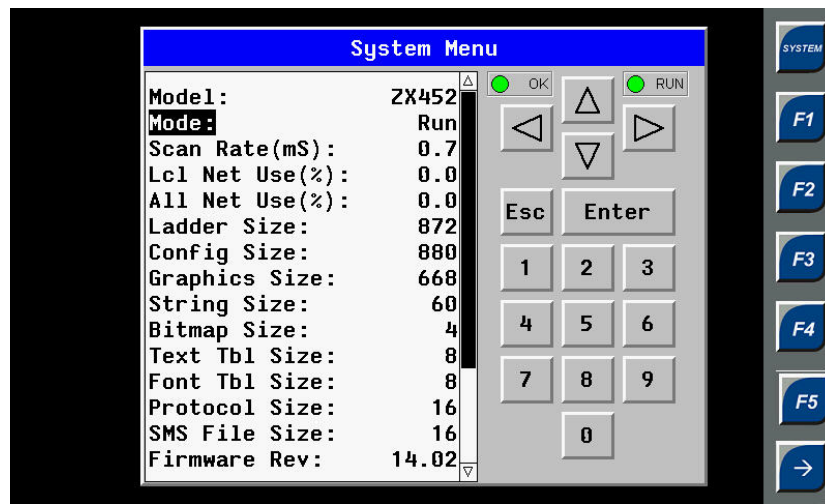

The View Status Sub-Menu displays up to 19 System Settings. Only the **OCS Mode** System Setting is editable.

Model	XW1yz = Model number of this ZX OCS unit 1yz = indicates the installed I/O module 00 = no I/O module
OCS Mode	Idle = ZX OCS is in Idle mode DoIO = ZX OCS is in Do I/O mode Run = ZX OCS is in Run mode
Scan Rate(mS)	0.0 = ZX OCS is not in Run mode 0.1 to 999.9 = Average number of mS for each ladder scan
OCS Net Use %	0.0 to 100.0 = CAN network bandwidth % used by this ZX OCS node
All Net Use %	0.0 to 100.0 = CAN network bandwidth % used by all nodes
Ladder Size	x = Number of bytes in application ladder program
Config Size	x = Number of bytes in application I/O configuration
Graphics Size	x = Number of bytes in application graphic screens
String Size	x = Number of bytes in application string table

Bitmap Size	x = Number of bytes in application bitmaps
Text Tbl Size	x = Number of bytes in application text tables
Font Tbl Size	x = Number of bytes in application font tables
Protocol Size	x = Number of bytes in application downloaded protocols
SMS File Size	x = Number of bytes in application SMS protocol configuration
Firmware Rev	xx.yy = Current firmware version
OS Ver	a.b.cd.yz = Current Operating System version
FPGA Rev	x.y = Current FPGA version (High Speed IO Sub System)
InitRD Rev	x.yz = Bootloader version
Self-Test	Ok = All power-on self-tests passed Fault = One or more power-on self-tests failed

View Diags

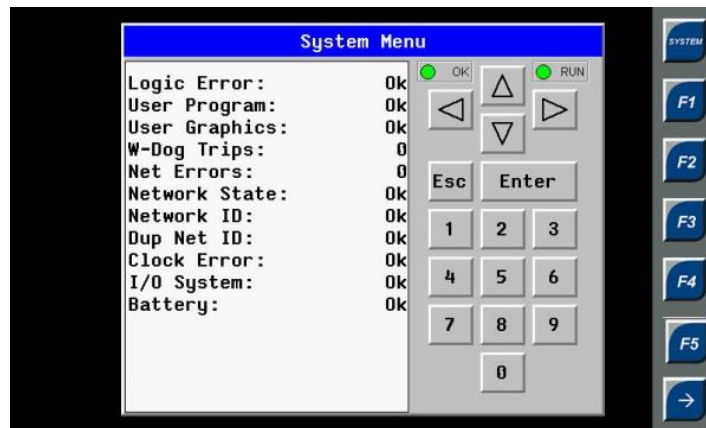

The View Diags Sub-Menu displays up to 11 System Diagnostics, none of which are editable.

The first two System Diagnostics are critical. If either of these indicate a Fault condition, the ZX OCS will not enter or remain in Run mode, and the problem must be investigated and corrected.

Logic Error:	Ok = All executed ladder instructions are legal for loaded firmware Fault = A ladder instruction <u>not</u> supported by firmware was found
User Program:	Ok = Ladder program and I/O configuration loaded successfully Fault = Ladder program or I/O configuration not loaded or load failed

The last nine System Diagnostics are informational. If any of these indicate a warning condition, the ZX OCS can still enter and remain in Run mode, but the problem should be investigated and corrected.

User Graphics	Ok = Application graphics objects loaded successfully Fault = Application graphics objects not loaded or load failed
W-Dog Trips	0 = Watchdog timer has not tripped since the last power-up x = Number of times watchdog timer has tripped
Net Errors	0 = No CAN network bus-off errors have occurred x = Number of CAN network bus-off errors that have occurred
Network State	Ok = At least one other node was found on the CAN network Warning = No other nodes were found on the CAN network
Network ID	Ok = This node's CAN Network ID is in the range 1 to 253 Warning = This node's CAN Network ID was out of range at power-up
Dup Net ID	Ok = This node's Network ID is unique on the CAN network Warning = This node's Network ID is duplicated in another node

Clock Error	Ok = Time and date have been set Warning = Time and date need to be set
I/O System	Ok = I/O configuration matches the installed I/O and COM modules Warning = I/O configuration needs updating to match installed modules
Battery	Ok = Backup battery operating properly Warning = Backup battery needs to be replaced

View Protocols



The View Protocols Sub-Menu displays two System Settings, neither of which may be edited.

As mentioned in 0, both the MJ1/MJ2 (Port 1) and MJ3 (Port 2) serial ports support downloadable protocols. To assign a downloadable protocol to an ZX OCS serial port, select the **Protocol Config** item in Cscape’s Program menu and then set up a protocol for Port 1 or Port 2 (or both).

In the View Protocols Sub-Menu, the currently downloaded protocol, if any, and its version number are displayed for each of MJ1, MJ2 COM board and MJ3.

Set Fkeys Mode



The Set Fkeys Sub-Menu displays two System Settings, both of which may be edited.

Fkeys	Momentary = %K1-5 bits go On & Off as F1-F5 are pressed & released Toggle = %K1-5 bits toggle each time F1-F4 are pressed
SYS_Fn enable	Yes = Reset and all clear system functions enabled No = Reset and all clear system functions disabled

Set Serial Ports

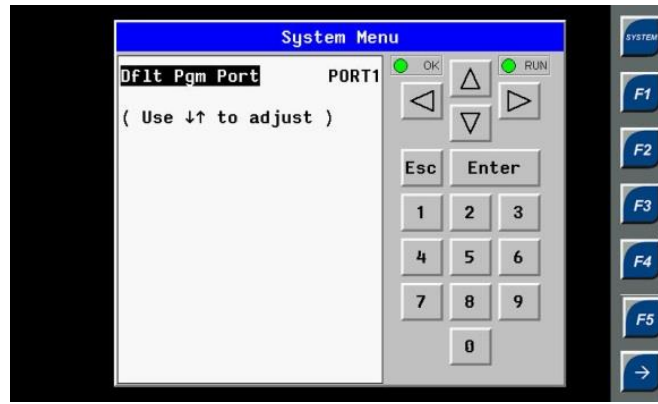

The Set Serial Ports Sub-Menu displays three System Settings, all of which may be edited, and one optional item. For the **Dflt Pgm Port** System setting, only MJ1-232 can be selected, unless a Modem (XMC) COM module is installed.

Dflt Pgm Port	MJ1-232 = MJ1 RS232 port is the default programming port Modem = Modem COM module is the default programming port
MJ2 RS485 Bias	No = MJ2 RS485 bias resistors are <u>not</u> switched in Yes = MJ2 RS485 bias resistors are switched in
MJ3 RS485 Bias	No = MJ3 R5485 bias resistors are <u>not</u> switched in Yes = MJ3 R5485 bias resistors are switched in

Set Time/Date

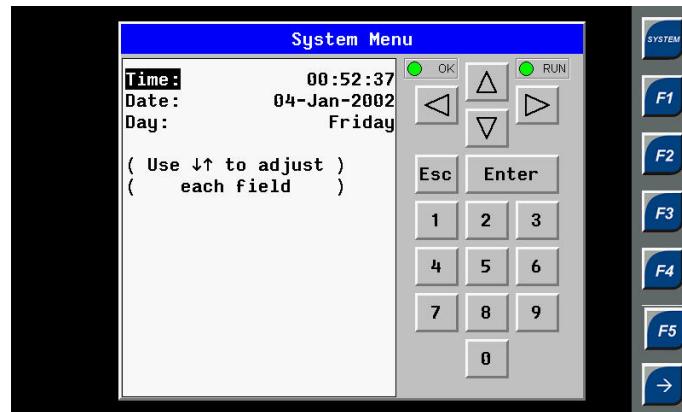

The Set Time/Date Sub-Menu displays three System Settings. **Time** and **Date** may be edited, and **Day** is automatically calculated from the **Date** setting. Note that **Time** and **Date** are split into three fields each, all of which may be edited. Use ← or → to select a field and then use ↓ or ↑ to edit the field.

Time	16:09:49 = Current time (hours:minutes:seconds in 24-hour format)
Date	10-Jun-2013 = Current date (day-month-year)
Day	Monday = Current day of week calculated from the Date setting

Set Beeper



The Set Beeper Sub-Menu displays one System Setting, which may be edited.

Beeper enable	Yes (<i>default</i>) = Enables beeper No = Disables beeper (<i>does NOT affect ladder access</i>)
----------------------	--

Set Screen

The Set Screen Sub-Menu displays four System Settings, all of which may be edited.

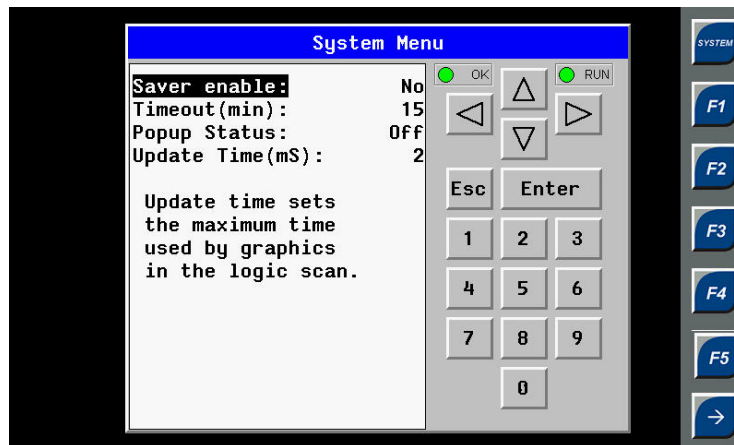

Saver enable	Yes = Enable screen saver No (<i>default</i>) = Disable screen saver
Timeout (min)	5 - 1200 = Amount of time in minutes to expire with NO touch activity before activating screen saver (black screen)
Popup Status	Off (<i>default</i>) = Disable popup status Warning = Display popup status only if controller status changes to NOT Ok or NOT Run mode. On = Display popup status on any controller status change.
Update Time (mS)	2 - 50 = Maximum amount of time to allow for graphics update per scan

Removable Media

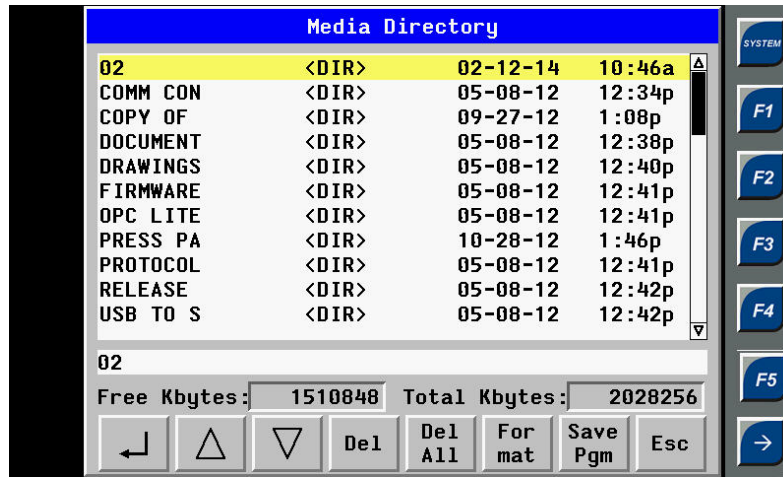

The Removable Media Sub-Menu displays the Removable Media Manager. Having selected Removable Media from the Main Menu, one of four Sub-Menu screens will appear:



= No MicroSD card has been installed in the Memory slot



= MicroSD card is installed, but it is still initializing

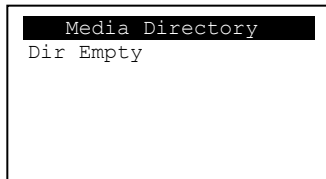

= MicroSD card is installed and initialized, but contains no files

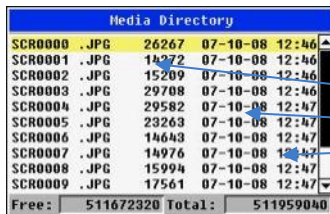

= MicroSD card is installed and initialized, and it contains files

Shows size of highlighted file or shows <DIR> if directory is highlighted
Shows the date file or directory was created or last modified
Shows the time file or directory was created or last modified

If a directory name is highlighted, pressing **Enter** will switch to that directory showing its files and sub-directories. In a sub-directory, highlighting “..” (dot dot) and pressing **Enter** will move up one directory.

Fail – Safe System

The Fail-Safe System is a set of features that allow an application to continue running in the event of certain types of "soft" failures. These "soft" failures include:

- Battery power loss
- Battery-Backed Register RAM or Application Flash corruption due to, for example, an excessive EMI event.

Selecting “Fail-Safe System” menu will open the following menu screen:



Selecting Backup/Restore Data displays the following screen in:

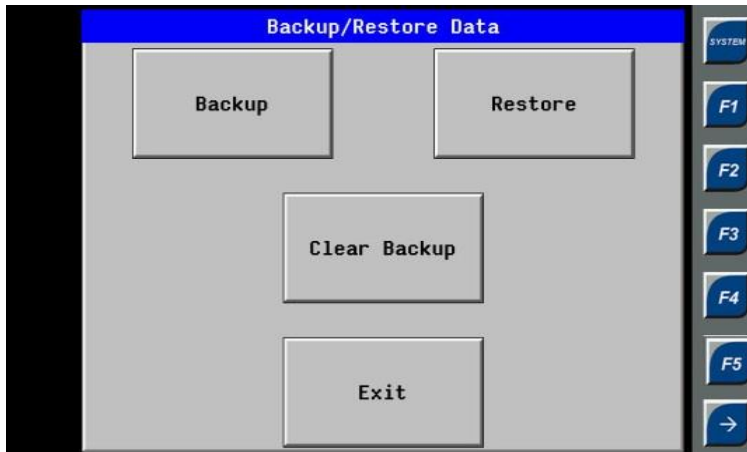

Backup	= Copies Battery Backed RAM contents on to the onboard FLASH memory of the OCS.
Restore	= Copies the backed up data from onboard FLASH to the battery backed RAM.
Clear Backup	= The backup data will be erased from the onboard FLASH.
Exit	= Goes back to previous menu

“Enable AutoRun” displays the following options which can be selected:



Enable AutoRun	No = OCS will be in IDLE mode after AutoLoad or Automatic Restore. Yes = OCS will automatically be placed into RUN mode after AutoLoad or Automatic Restore.
-----------------------	---

“Enable AutoLoad” displays the following options which can be selected:

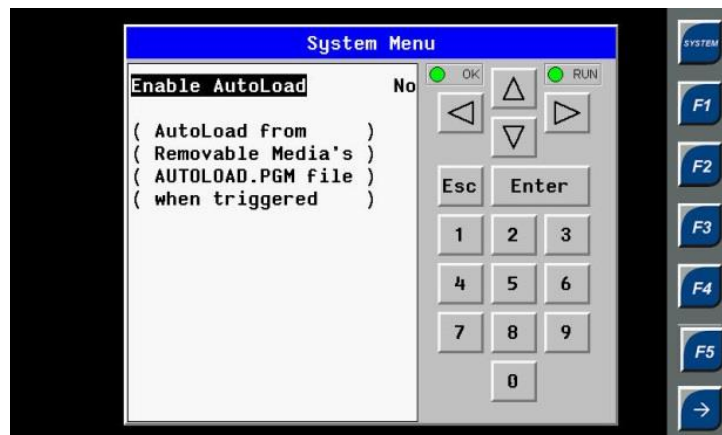

Enable AutoLoad	No = Does not load AUTOLOAD.PGM automatically when application program is absent or corrupted. Yes = Loads AUTOLOAD.PGM file automatically from RM when application program is absent or corrupted.
------------------------	--

Clone Unit

‘Clone Unit’ feature allows the user to “clone” the OCS of the exact same model. This feature “clones” application program and unit settings stored in Battery backed RAM of an OCS into the RM (refer Removable Media [Chapter 9](#) for details on using RM). It can then be used to clone a different OCS (exact same model).

This feature can be used when:

- Replacing an OCS by another unit of the same model.
- Duplicating or “clone” units without a PC.

Clone

Selecting “Clone Unit” menu will open the following menu screen:

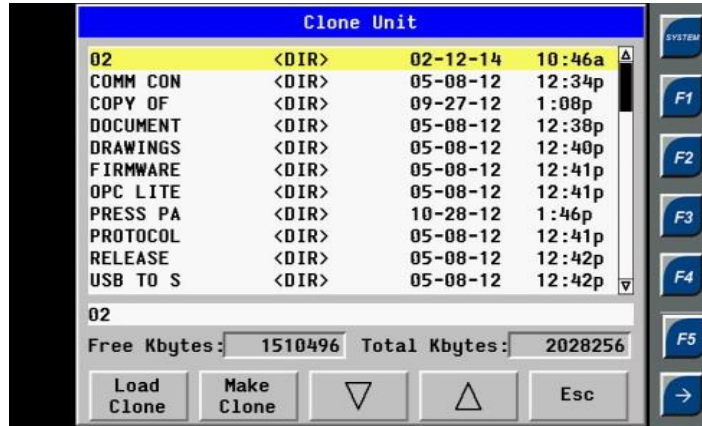

Note: Free/Total – displays number of free and total bytes in Removable Media.

Selecting Make Clone brings up the confirmation screen. Upon confirmation, the OCS will create two new files in the root directory of the Removable Media Drive as shown below:

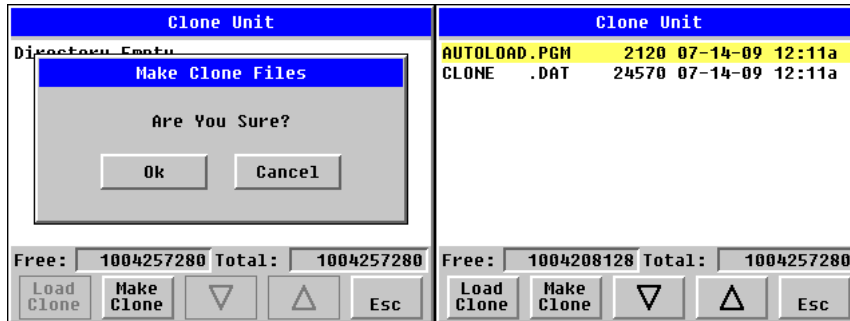

AUTOLOAD.PGM	Application file
CLONE.DAT	File having all unit settings and register values from Battery Backed RAM

Load Clone

Selecting “Clone Unit” menu will open the following menu screen. Select “Load Clone”.

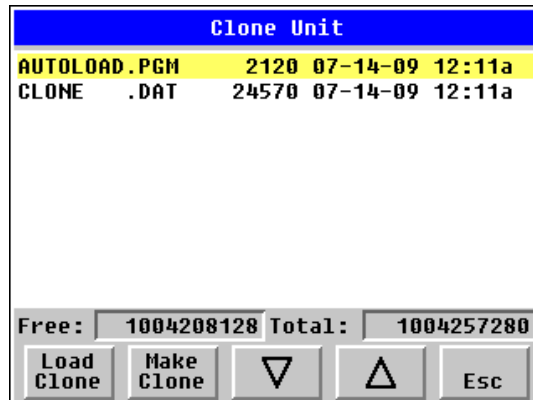

NOTE: For security enabled files, Load clone asks for password validation before loading the application.

10.4 Touch screen calibration

The touch screen is calibrated at the factory and rarely needs modification. However, if actual touch locations do not appear to correspond with responding objects on the display, field adjustment is available. To access the field adjustable touch screen calibration dialog, press and hold both the SYS and F1 key for longer than 2 seconds and a dialog similar to figure 9.2 should appear. Thereafter, use a plastic tip stylus and follow the dialog instructions.

Note that special system keys may be locked out from user access. If the SYS-F1 combination does NOT respond, verify that the system menu's Set Fkeys sub-menu's parameter SYS_Fn is enabled.

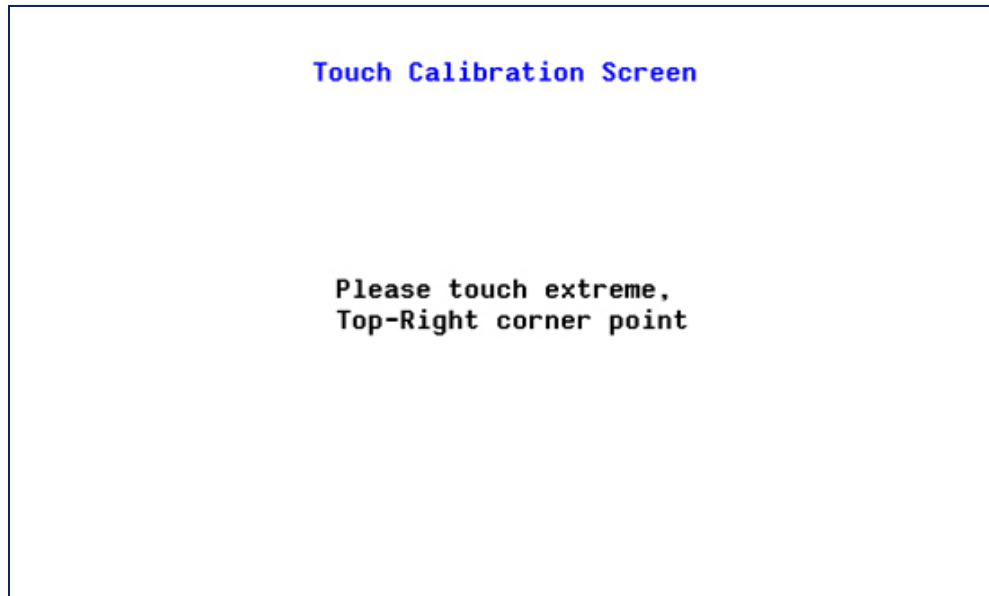

CHAPTER 11: USER INTERFACE

11.1 Overview

This chapter presents the user interface (or operator view) of the ZX and some of the model specific characteristics of the ZX as compared to the rest of the OCS line. This chapter does NOT cover building screens or using the Cscape graphics editor. For instructions on creating screens and using the graphics editor, refer to the graphics editor help file.

The following aspects are discussed:

- Displaying and entering data
- Alpha-numeric data entry
- Navigating around screens
- Beeper acknowledgement
- Touch (slip) sensitivity
- Alarm log dialog
- RM dialog
- Screen Saver
- Dimmer

11.2 Displaying and entering Data

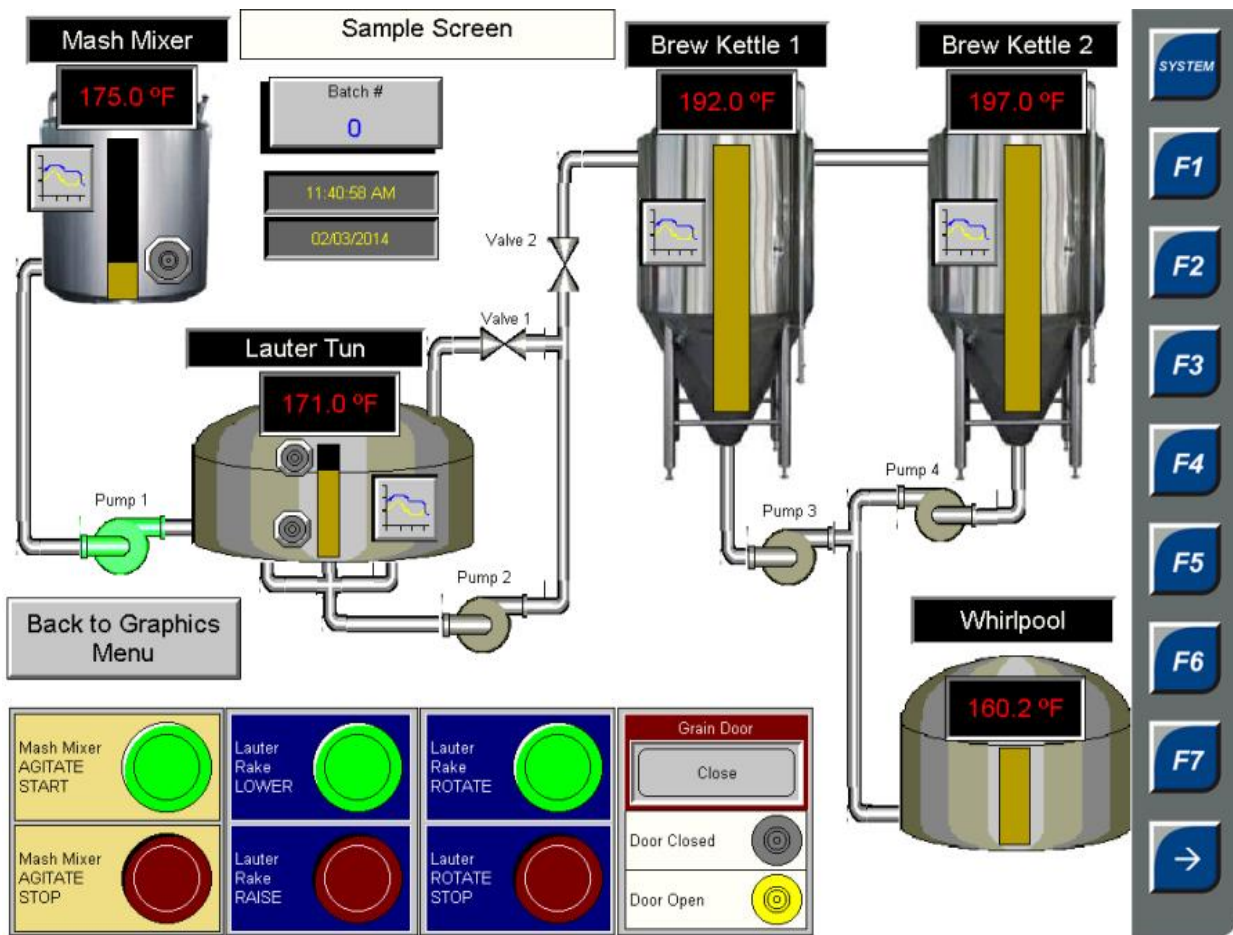

Figure 11.1 – Example Screen

Multiple objects are provided for displaying data such as virtual panel lights, push buttons, numeric value displays, bar graphs, meters, graphs and animated bitmaps. On the ZX, these graphical objects (through ladder manipulation of attribute bits) can change color, flash or change visibility to attract operator attention.

On objects that accept user input, the input is provided by touching the object or alternately changing an OCS register (i.e. Function key registers). Objects that allow input generally have a raised 3D appearance. An exception is the binary type objects, such as buttons, which are shown in a depressed 3D appearance when in the ON state. Objects that normally accept touch input may be disabled through program control (through ladder manipulation of an attribute bit). If an object is disabled, the object's representation changes to a 2D appearance.

On objects that represent non-discrete information, more action may be required beyond that of simply touching the object. For example, the slider object requires the operator to touch and *slide* the control in the direction desired. Alternately, alpha-numeric entry objects invoke a pop-up alpha-numeric keypad for additional user input. The alpha-numeric keypad is discussed below.

Note that if the numeric entry object displays >>>>>>, the value is too big to display in the field or is above the maximum for an editable field. Likewise, if the numeric entry object displays <<<<<< in a numeric field, the value is too small to display or is below the minimum for an editable field.

11.3 Alpha-numeric keypad

To allow entry of a specific number or text, several of the input objects invoke a pop-up alpha-numeric keypad when the object is touched. An example of the alpha-numeric keypad invoked from a numeric input object is shown in Figure 13.2. Once invoked, the operator may touch the appropriate keys to enter a specific value. When entering a value, the alpha-numeric keypad is in one of two modes [new-value or edit-value].

New-value mode

Generally, when the alpha-numeric keypad is first invoked, it is placed in new-value mode. Initially, the alpha-numeric keypad displays the current value with all the digits being highlighted. Once the first digit is entered, the current value is erased from the display and the new digit is placed in the first location. Thereafter, no digits are highlighted and new digits are added to the rightmost position while the other digits are shifted left.

Edit-value mode

Edit-value mode may be entered from the initial new-value mode by pressing either the left or right arrow key before any digit key is pressed. The result will be a single character highlighted. The user may then either touch a key to change the digit at the selected position or the up and down arrows may be used to add or subtract (respectively) from the selected digit. The user may then use the left or right arrow keys to select a new position.

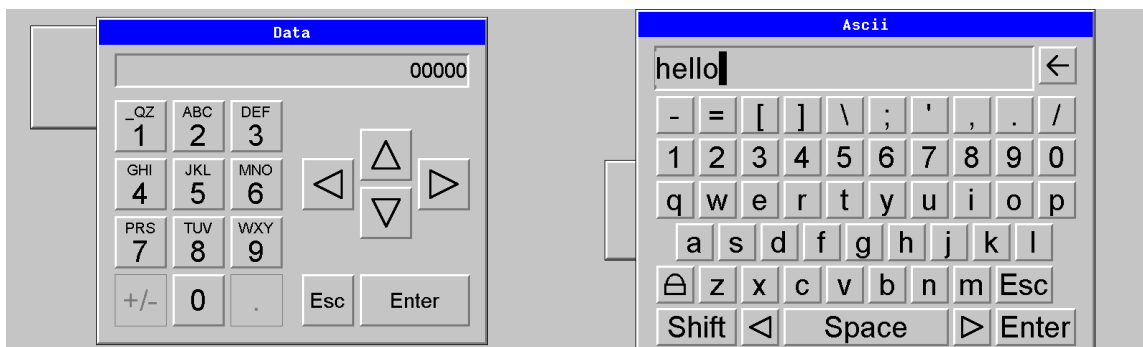

Figure 11.2 – Alpha-numeric Keypad and ASCII Keypad

Once the desired value is entered, pressing the *Enter* key moves that value into the object (and the corresponding OCS register) and the alpha-numeric keypad disappears. Alternately, pressing the *ESC* key any time before the *Enter* key cancels the operation, leaves the objects current value unchanged, and the alpha-numeric keypad disappears.

NOTE: Each numeric entry object has a configured minimum and maximum value. If the operator enters a value outside of the configured range, the new value is ignored when *Enter* is pressed and the current object value is NOT changed.

Since the alpha-numeric keypad services several different graphical objects, certain keys on the alpha-numeric keypad may be disabled (grayed) when the keypad is invoked for certain objects. The following describes the alpha-numeric keypad variation based on object.

Numeric Object	When editing a numeric value, the [+/-] or the [.] key are disabled (grayed) if the object is NOT configured for floating-point value or a signed value.
Password Object	When editing a password value, the arrow keys, [+/-], and the [.] keys are disabled. Additionally, overwrite mode is disabled. When entering digits, the pop-up keypad hides the value by displaying "*" alternately for each digit.
ASCII Object	When editing an ASCII value, an ASCII keypad is displayed as shown figure 13.2. The ASCII keypad has 3 modes, numeric, symbols and alpha. In Alpha mode the Caps Lock button may be pressed to access capital letters. When you first enter this editor typing a character will overwrite the entire old string and start a new entry. You may press the back space arrow to delete the previous character. Pressing Enter will save the entry, pressing ESC will cancel the edit and return the string to the previous value.
Text Table Object	When editing a Text Table Object, all the keys except the Up and Down arrow keys are grayed and disabled. The next text selection is made by pressing either the Up or Down arrow.
Time/Date Object	When editing a Time/Date Table Object, all the keys except the Up, Down, Left and Right arrow keys are grayed and disabled. The specific field (i.e. hour or minutes) is selected using the Left and Right arrows. The value in the selected field is changed by pressing either the Up or Down arrow.

11.4 Screen Navigation

To allow the operator to change screens, a **screen jump object** is generally used. This object may be visually **represented as a 3-D button** (responding to touch) or remain invisible and logically tied to an OCS register. An optional system ICON may be configured for display along with the legend, which aids in identifying the object as one that causes a screen change (shown below in figure 13.3)

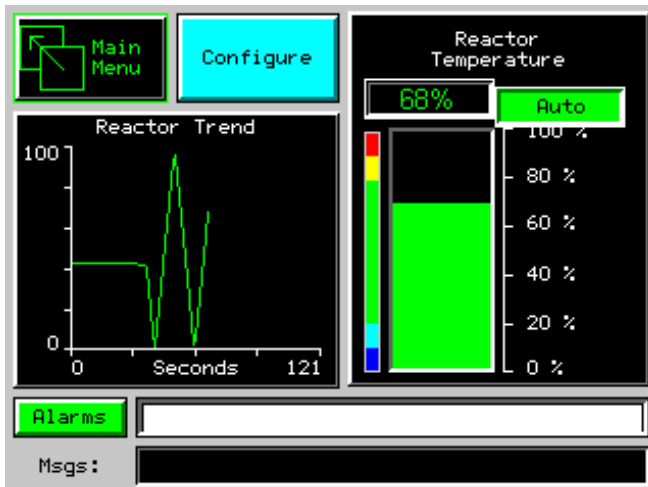

Screen jumps can also be triggered on other keys or based on control logic for more advanced applications. To allow the operator to change screens, a **screen jump object** is generally used. This object may be visually **represented as a button** (responding to touch) or remain invisible and logically tied to an OCS register. An optional system ICON may be configured for display along with the legend, which aids in identifying the object as one that causes a screen change.

11.5 Ladder Based Screen Navigation

Ladder logic can use several techniques to control screen navigation. Coils can be tied to %D registers to make them screen coils. These coils have two modes, switch and alarm. If the ladder program energizes an alarm display coil, the screen associated with this coil is displayed and overrides the normal user screens. This is designed to show alarm conditions or to display other ladder-detected events. When the text coil is de-energized, the previous screen that was being viewed before the alarm is returned.

The switch display coil switches to the associated screen when it is energized. Once it is de-energized the screen remains until it is switched by the user or ladder

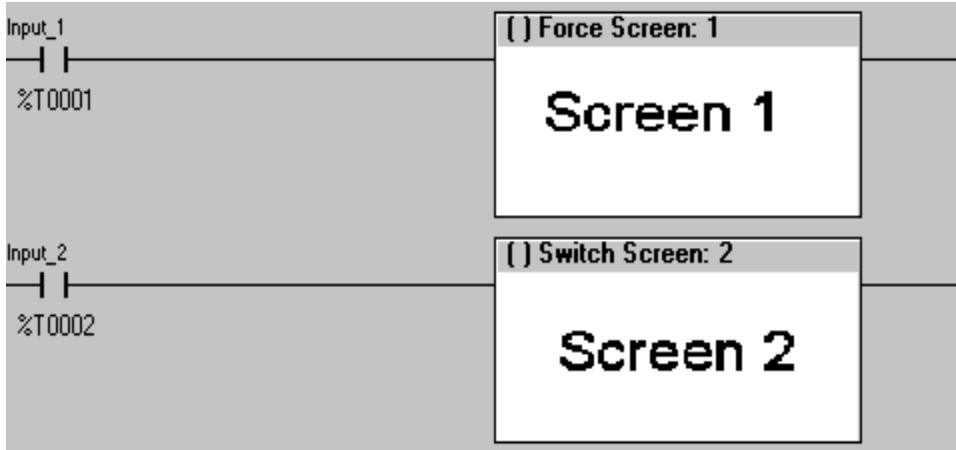

Figure 11.4 – Force and Switch Coils in Ladder Programming

There is also a system register that can be used to for control based screen navigation. %SR1 can be read to determine the current screen or written to change the current screen.

Refer to the on-line help in Cscope for more information on control-based screen navigation.

11.6 Beeper Acknowledgement

The ZX contains an internal beeper that provides an audible acknowledgment when an operator touches a graphic object that accepts touch input. When the graphic object is enabled, a short 5ms tone is emitted. When the graphic object is disabled, a longer 100ms tone is emitted to enounce that graphical object is not currently accepting the touch input.

If beep acknowledgement is not desired, the beeper function can be disabled from the system menu.

11.7 Touch (Slip) Sensitivity

Touch *slip* sensitivity is preset to meet most applications; however, adjustment is available to reduce the sensitivity for touch release. That is, once a graphical object (button) is touched and held by a finger, the default touch *slip* sensitivity allows for a slight *slip* of the finger on the graphical object before the ZX assumes touch has been released (equates to approximately a quarter inch of movement with a stylus).

In some applications (such as jog buttons) where the operator is pushing a button for a period of time, the amount of *slip* while holding a button pressed may exceed the default sensitivity. To increase the amount of tolerable *slip* and prevent false releases of the button, the ZX allows adjustment of the allowable *slide* up to 5x the default value.

To enable the touch (slip) sensitivity, first an OCS data register must be allocated through the Graphics editor Configuration menu for Display Settings. Once a Touch Sensitivity register is assigned, that

register may be modified [range = 1(Low) to 5 (High)] to the desired slide amount. If a value outside the valid range is entered in the touch sensitivity register, it is ignored and the last valid value is used.

11.8 Alarms

Alarm presentation to the operator is highly configurable and beyond the scope of this document to describe fully. For more information refer to the graphics editor help file. This section presents a typical configuration thereby providing an introductory description on what the operator should expect.

The alarm object is generally used to enunciate alarms to the operator. While the display characteristics of this object is configurable, it is generally displayed as a button that changes colors to indicate the highest state of the alarm(s) in the alarm group it is monitoring. The following indicates the priority of the alarm states and the default colors associated with these states.

Highest	(Red)	Unacknowledged Alarms Exist
—	(Yellow)	Acknowledged Alarms Exist
Lowest	(Green)	No Alarms Exist

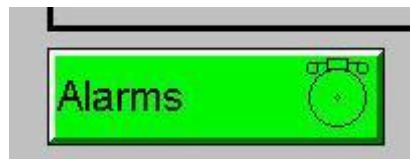

Figure 13.5 – Alarm Object

To view, acknowledge and/or clear alarms, the operator must access the alarm viewer. This is accomplished by touching an (enabled) alarm object. When accessed, the alarm viewer is displayed as pop-up alarm viewer dialog similar to that shown in Figure 13.6.

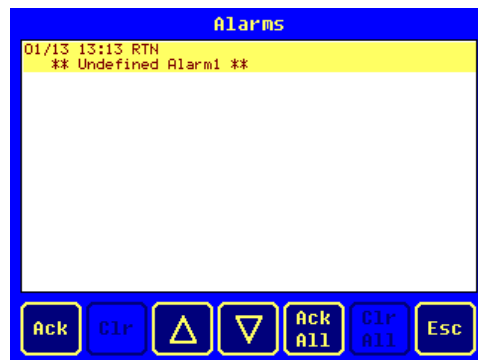

Figure 13.6 – Alarm Viewer

The currently selected entry is indicated by a yellow highlight which can be moved up or down by touching the arrow buttons or by directly touching an entry. If more entries exist than can fit on the page, a scroll bar is displayed on the right side that also indicates the current relative position.

The current state of the displayed alarm is indicated by its color and optionally by an abbreviated indicator after the date/time stamp (ALM, ACK, RTN). The operator can acknowledge an alarm by selecting it from the list and touching the ACK button. The operator can also clear an alarm if that function is enabled in the alarm object. If not enabled, the Clear buttons are grayed and do not respond to touch. Once view operations are complete, simply touch the Esc button to remove the pop-up alarm viewer.

Note that OCS registers %SR181 and %SR182 are available for ladder use, which indicate presence of unacknowledged or acknowledged alarm (respectively). The screen designer may implement these registers to switch screens or activate the beeper to attract the operator’s attention.

11.9 Removable Media

The removable media object is generally used to inform the operator on the current state of the removable media device and allow access to its file structure. The removable media object is displayed as a button that changes colors to indicate the current state of the removable media device. The following indicates the device states and the default colors associated with these states.

Highest	(Red)	Device Error
—	(Yellow)	Device Full (threshold adjustable)
Lowest	(Green)	Device OK

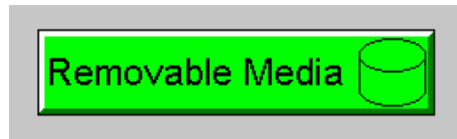

Figure 13.7 – Removable Media Object

To view and perform file operations, the operator must access the removable viewer. This is accomplished by either touching an (enabled) removable media object or through the system menu. When accessed, the removable media viewer is displayed as pop-up removable media dialog similar to that shown in Figure 13.8.

Note that the removable media object can be configured to open the removable media viewer at a certain directory complete with restrictions on transversing back up the file path. This may be used to restrict operator access to non-critical files.

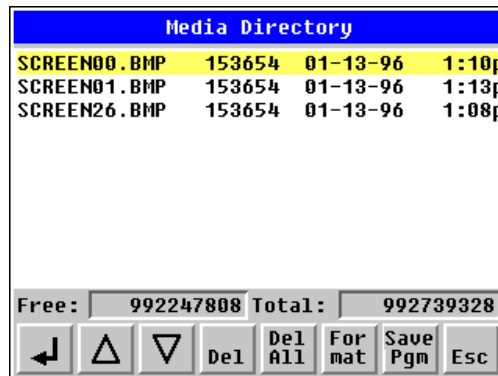

Figure 13.8 – Removable media viewer

The currently selected entry is indicated by a yellow highlight which can be moved up or down by touching the arrow buttons or by directly touching an entry. If more entries exist than can fit on the page, a scroll bar is displayed on the right side that also indicates the current relative position.

File operations are accomplished by pressing the appropriate button at the bottom of the removable media viewer. The configuration of the removable media object that invokes the removable media viewer defines what buttons are enabled and available to the user. A button is grayed and does not respond to touch if configured as disabled.

The ↵ (Enter) button (if enabled) performs certain operations based on the selected file's type:

..	change display to parent directory
<DIR>	change display to child directory
bmp, jpeg	display bitmap (if compatible format)
pgm	load application (if compatible model and version)

Alternately, the (enter) button can be configured to simply load the ASCII representation of the file path (including the file name) to a group of OCS registers. That pathname can then be used by ladder for opening and manipulating that file.

Once view operations are complete, simply touch the *Esc* button to remove the pop-up removable media viewer.

If the removable media is used in an application, the removable media device requires changing by the operator, and the application is attempting to write to the removable media when it is removed, the screen designer should create objects that allow the operator to temporarily halt access to the removable media. This prevents corruption to the file system if the removable media is removed during a file write sequence. The graphic objects should set OCS register %SR174.1 (when requesting the card be removed) and provide an indicator based on OCS register %SR174.2 (which indicates that it is safe to remove the removable media).

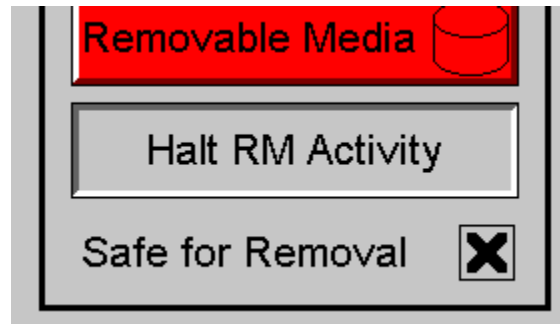

Figure 13.9 – Example application segment for safe removal of removable media

11.10 Screen Saver

The ZX screen backlight life is typically 5 years when in continuous use. If the application does not require interaction with the ZX for long periods of time, the backlight life can be extended by using the screen saver function. When enabled through the system menu, the backlight is shut off (screen goes black) after a specified time of no touch activity on the screen. When the screen saver shuts off the backlight, any operator touch on the screen or function keys reactivates the backlight.

Note that when the screen saver is active (backlight shut off), any initial touch activity on the screen (or function key) to reactivate the backlight is otherwise ignored by the ZX. Any additional touch activity is also ignored by the ZX for approximately one second thereafter.

It is possible for the application to temporarily disable the screen saver by generating a positive transition to %SR57.16 (coil only) at a rate faster than the screen saver timeout value. This may be desired while waiting for alarm acknowledgement.

11.11 Screen Brightness

The ZX provides a feature that allows screen dimming for night operation. To enable this feature, the application must access and control system register %SR57 (Display Backlight Brightness). Screen brightness is continuously variable by driving %SR57 through the range of 100 (full bright) to 0 (full off). It is left to the screen designer on how to present a Screen Brightness control to the user, if required.

NOTE: the backlight life may be shorted when screen is dimmed or screen brightness is varied on a repetitive basis.

CHAPTER 12: REGISTERS

12.1 Register Definitions

When programming the ZX OCS, data is stored in memory that is segmented into different types. This memory in the controller is referred to as registers. Different groups of registers are defined as either bits or words (16 bits). Multiple registers can usually be used to handle larger storage requirements. For example 16 single bit registers can be used to store a Word or two 16 bit registers can be used to store a 32-bit value.

Table 14.1 - Types of Registers found in the ZX OCS	
%AI Analog Input	16-bit input registers used to gather analog input data such as voltages, temperatures, and speed settings coming from an attached device
%AQ Analog Output	16-bit output registers used to send analog information such a voltages, levels or speed settings to an attached device
%D Display Bit	These are digital flags used to control the displaying of screens on a unit which has the ability to display a screen. If the bit is SET, the screen is displayed
%I Digital Input	Single-bit input registers. Typically, an external switch is connected to the registers
%K Key Bit	Single-bit flags used to give the programmer direct access to any front panel keys appearing on a unit
%M Retentive Bit	Retentive single-bit registers
%Q Digital Output	Single-bit output registers. Typically, these bits are connected to an actuator, indicator light or other physical outputs
%R General Purpose Register	Retentive 16-bit registers
%S System Bit	Single-bit bit coils predefined for system use
%SR System Register	16-bit registers predefined for system use
%T Temporary Bit	Non-retentive single-bit registers

12.2 Useful %S and %SR registers

Table 14.2 – Common %S Register Definitions	
Register	Description
%S1	Indicate First Scan
%S2	Network is OK
%S3	10mS timebase
%S4	100mS timebase
%S5	1 second timebase
%S6	I/O is OK
%S7	Always ON
%S8	Always OFF
%S9	Pause 'n Load soon
%S10	Pause 'n load done
%S11	I/O being forced
%S12	Forcing is enabled
%S13	Network I/O is OK
%S16	Ethernet COM module is OK

Table 14.3 – %SR Registers				
Register	Name	Description	Min Val	Max Val
%SR1	USER_SCR	Current User Screen Number	1	1023
%SR2	ALRM_SCR	Current Alarm Screen Number (0=none)	0	1023
%SR3	SYS_SCR	Current System Screen Number (0=none)	0	14
%SR4	SELF_TEST	Bit-Mapped Self-Test Result	0	65535

Table 14.3 – %SR Registers				
Register	Name	Description	Min Val	Max Val
%SR5	CS_MODE	Control Station Mode (0=Idle, 1=Do I/O, 2=Run)	0	2
%SR6	SCAN_RATE	Average Scan Rate (/ 10)	-	1000
%SR7	MIN_RATE	Minimum Scan Rate (/ 10)	-	1000
%SR8	MAX_RATE	Maximum Scan Rate (/ 10)	-	1000
%SR9-10	EDIT_BUF	Data Field Edit Buffer	0	2 ³² -1
%SR11-12	LADDER_SIZE	Ladder Code Size	2	256K
%SR 13-16	Reserved	-	-	-
%SR17-18	IO_SIZE	I/O Configuration Table Size	16	127K
%SR19-20	NET_SIZE	Network Configuration Table Size	34	1K
%SR21-22	SD_SIZE	Security Data Table Size	-	-
%SR23	LADDER_CRC	Ladder Code CRC	0	65535
%SR 24-25	Reserved	-	-	-
%SR26	IO_CRC	I/O Configuration Table CRC	0	65535
%SR27	NET_CRC	Network Configuration Table CRC	0	65535
%SR28	SD_CRC	Security Data Table CRC	0	65535
%SR29	NET_ID	This Station's Primary Network ID (CsCAN)	1	253
%SR30	NET_BAUD	Network Baud Rate (CsCAN) (0=125KB; 1=250KB; 2=500KB; 3=1MB)	0	3
%SR31	NET_MODE	Network Mode (0=network not required; 1=network required; 2=network optimized; 3=network required and optimized)	0	3
%SR32	LCD_CONT	LCD Display Contrast setting	0	255
%SR33	FKEY_MODE	Function Key Mode (0=Momentary; 1=Toggle)	0	1
%SR34	SERIAL_PROTOCOL	RS232 Serial Protocol Mode (0=Firmware Update (RISM); 1=CsCAN; 2=Generic (Ladder- Controlled); 3=Modbus RTU; 4=Modbus ASCII)	0	4
%SR35-36	SERIAL_NUM	This Station's 32-bit Serial Number	0	2 ³² -1
%SR37	MODEL_NUM	This Station's Binary Model Number	0	65535
%SR38	ENG_REV	Firmware Rev Number (/ 100)	0000	9999
%SR39	CPLD_REV	BIOS Rev Number (/ 100)	000	255
%SR40	FPGA_REV	FPGA Image Rev Number (/ 10)	000	255
%SR41	LCD_COLS	Vertical Pixel Count		
%SR42	LCD_ROWS	Horizontal Pixel Count		
%SR43	KEY_TYPE	Keypad Type		
%SR44	RTC_SEC	Real-Time-Clock Second	0	59
%SR45	RTC_MIN	Real-Time-Clock Minute	0	59
%SR46	RTC_HOUR	Real-Time-Clock Hour	0	23
%SR47	RTC_DATE	Real-Time-Clock Date	1	31
%SR48	RTC_MON	Real-Time-Clock Month	1	12
%SR49	RTC_YEAR	Real-Time-Clock Year	1996	2095
%SR50	RTC_DAY	Real-Time-Clock Day (1=Sunday)	1	7
%SR51	NET_CNT	Network Error Count	0	65535
%SR52	WDOG_CNT	Watchdog-Tripped Error Count	0	65535
%SR53-54	BAD_LADDER	Bad Ladder Code Error Index	0	65534
%SR55	F_SELF_TEST	Filtered Bit-Mapped Self-Test Result	0	65535

Table 14.3 – %SR Registers				
Register	Name	Description	Min Val	Max Val
%SR56	LAST_KEY	Key Code of Last Key Press or Release	0	255
%SR57	BAK_LITE	LCD Backlight Dimmer Register 0 = 0% On; 25=25% On; 100-255 = 100% On	0	255
%SR58	USER_LEDS	User LED Control / Status	0	65535
%SR59-60	Reserved	-	-	-
%SR61	NUM_IDS	This Station's Number of Network IDs	1	253
%SR62	NUM_IDS	This Station's Number of Network IDs	1	253
%SR63	SS_BASE	SmartStack I/O Base Selector	0	7
%SR64	SS_STATUS	SmartStack I/O Base Status	0	2
%SR65-76	SS_INFO_1	SmartStack I/O Module #1 Information Structure	-	-
%SR77-88	SS_INFO_2	SmartStack I/O Module #2 Information Structure	-	-
%SR89-100	SS_INFO_3	SmartStack I/O Module #3 Information Structure	-	-
%SR101-112	SS_INFO_4	SmartStack I/O Module #4 Information Structure	-	-
%SR113-114	GOBJ_SIZE	Graphics Object Table Size	8	256K
%SR115-116	GSTR_SIZE	Graphics String Table Size	8	128K
%SR117-118	GBMP_SIZE	Graphics Bitmap Table Size	4	256K
%SR119-120	GTXT_SIZE	Graphics Text Table Size	8	128K
%SR121-122	GFNT_SIZE	Graphics Font Table Size	8	256K
%SR123-124	PROT_SIZE	Protocol Table Size	16	64K
%SR125	GOBJ_CRC	Graphics Object Table CRC	0	65535
%SR126	GSTR_CRC	Graphics String Table CRC	0	65535
%SR127	GBMP_CRC	Graphics Bitmap Table CRC	0	65535
%SR128	GTXT_CRC	Graphics Text Table CRC	0	65535
%SR129	GFNT_CRC	Graphics Font Table CRC	0	65535
%SR130	PROT_CRC	Protocol Table CRC	0	65535
%SR131-163	Reserved	-	-	-
%SR164.3		Read bit indicating Auto Restore of Register Data has been performed (Fail Safe)		
%SR164.4		Read bit indicating Backup of Register Data has been performed (Fail Safe)		
%SR164.5		Enable AUTORUN (Fail Safe)		
%SR164.6		Enable AUTOLOAD (Fail Safe)		
%SR164.7		Backup trigger bit		
%SR164.8		Clear Backup trigger bit		
%SR164.9		MAKE_CLONE trigger bit		
%SR164.10		LOAD_CLONE trigger bit		
%SR164.11		Status indicating Make Clone Fail (This bit goes high when Make / Create clone fails)		
%SR164.12		Status indicating Load Clone Fail (This bit goes high when Load clone fails)		

Table 14.3 – %SR Registers				
Register	Name	Description	Min Val	Max Val
%SR165-174	Reserved			
%SR175	Removable Media	Current Removable Media interface status	0	6
%SR176-177	Removable Media	Indicates free space on the Removable Media card in K bytes.	0	2 ³¹
%SR178-179	Removable Media	Indicates the total card capacity in K bytes.	0	2 ³¹
%SR180	Reserved	-	-	-
%SR181	ALM_UNACK	Unacknowledged Alarm (high bit indicates what group #)		
%SR182	ALM_ACT	Active Alarm (high bit indicates what group #)		
%SR183	SYS_BEEP	System Beep Enable (0=disabled; 1=enabled)		
%SR184	USER_BEEP	Software configurable (0=OFF; 1=ON)		
%SR185	SCR_SAVER	Screen Saver Enabled (0=disabled; 1=enabled)		
%SR186	SCR_SA_TM	Screen Saver Time in minutes (delay)		
%SR187	NET_USE	Average Net Usage of all units on the CAN network		
%SR188	NET_MIN	Minimum Net Usage of all units on the CAN network		
%SR189	NET_MAX	Maximum Net Usage of all units on the CAN network		
%SR190	NT_TX_AVG	Average Net Usage of this unit		
%SR191	NT_TX_MIN	Minimum Net Usage of this unit		
%SR192	NT_TX_MAX	Maximum Net Usage of this unit		

For additional information on system bits and registers, refer to the on-line help found in Cscope.

12.3 Resource Limits

Table 14.5– Resource Limits		Resource	Value
%S	16	Ethernet	CsCAN, Ping, EGD, SRTP, Modbus TCP Master (Downloadable protocol) & Slave, Ethernet IP, FTP, or HTTP @ 10 MBd or 100 MBd
%SR	448	CsCAN	125 kBd, 250 kBd, 500 kBd, or 1 MBd
%T	16000	Serial Ports	1 RS232, 1 RS485 Ports
%M	16000	IDs Per CsCAN Network	64 w/o repeat (253 w/ 3 repeaters)
%R	49999	Keypad	5 keys (4 fn keys and a System Key)
%K	Model dependent. 5 or 7	Display	800 x 480 7" TFT, 65K colors
%D	1023	Screen Memory	64 MB
%I	2048	User Screens	1023
%Q	2048	Data Fields Per User Screen	1023
%AI	512	Ladder Code	1024 kB
%AQ	512		

NOTES

CHAPTER 13: CSCAPE CONFIGURATION

13.1 Overview

ZX OCS hardware is programmed with a Windows based PC application called Cscape. This application can be used to program, configure, monitor and debug all aspects of the ZX OCS unit. Please see the on-line help provided with Cscape for additional details.

13.2 Cscape Status Bar

When the ZX OCS is connected to a PC using Cscape software a Status Bar appears at the bottom of the screen. The Cscape Status Bar can be used to determine if communications have been established between the ZX OCS and the Cscape program. Components of the Cscape Status Bar are explained below.

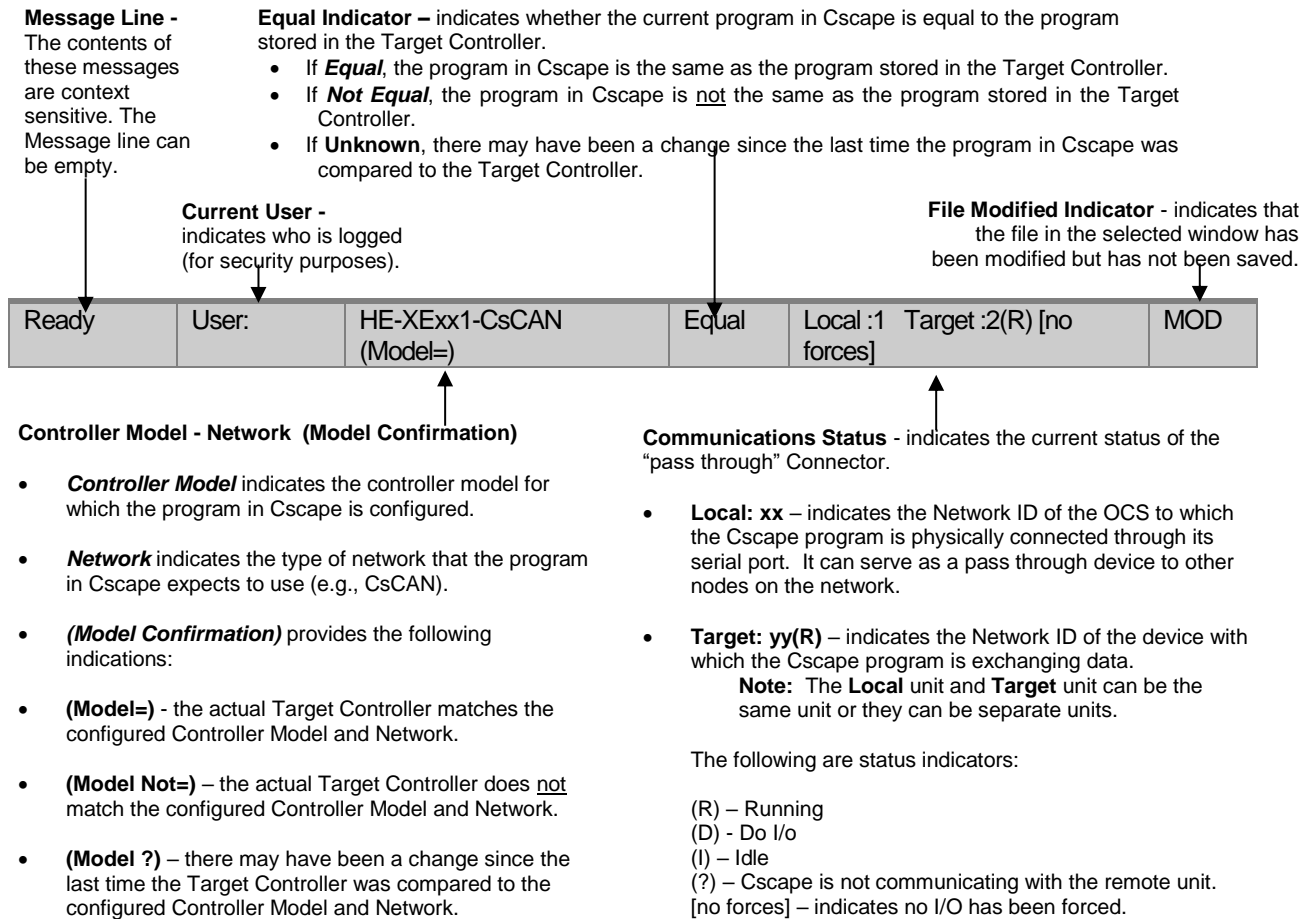

Figure 15.1 - Cscape Status Bar

13.3 Establishing Communications

The preferred method of communicating between Cscape and an ZX OCS is via CAN or Ethernet port. The ZX OCS can communicate with Cscape using USB to serial adapters, serial port communications via MJ1 Port, Ethernet, or CAN (CsCAN).

For ZX use Cscape Ver 9.30 SP6 or newer.

13.3.1 Communicating via MJ1 Serial Port

Start by configuring Cscape to use the correct communications port. This can be done using the Tools | Options | Communication Port dialog in Cscape.

Next, connect the PC's serial port to the port labeled MJ1 on the ZX.

If communications are successful, the target indicator should show the mode of the controller Target: yy(R) as shown in the status section above.

If the controller is not communicating, it may be required to set the target ID of the controller in Cscape or on the unit. The Target ID allows directing communications to a particular unit when multiple units are connected via a CsCAN network. Units without CsCAN network ports respond to any network ID and do not require the ID to be configured.

To check or change the ID on the ZX, press the System Button to enter the system menu. The first item in the menu is Set Network ID.

Pressing Enter allows the ID of the unit to be viewed or modified.

To change the Target ID of Cscape use the **Controller→Set Target Network ID** dialog.

13.3.2 Communicating Ethernet Port

The following is an overview of the information found in Chapter 7.

From Cscape go to **Controller→I/O Configure** and do auto configuration for the connected controller, Click on **Config** of Ethernet & go to Module Setup.

The IP address, Net Mask, and Gateway of the controller may be temporarily set from the system menu under the Set Networks menu item. Once running or power cycled the configuration will come from the Cscape configuration stored in the unit. (Must set Status Register).

In Module configuration dialog go to IP Address field enter unused IP Address and configure unused registers in Register field & then click OK. Screen shot for the same as follows:

Download the configuration in to Controller. Connect LAN cable to the Controller in default LAN Port.

From Cscape go to Tools -> Editor Options -> Communication Port -> configure. Select Ethernet and enter IP address which is configured in the file. Select mode as XL Series mode from drop down list.

The controller should get connected to Cscape. If communications are successful, the target indicator should show the mode of the controller Target: yy(R) as shown in the status section above.

13.4 Configuration

An overview of configuration:

1. Start the configuration by selecting the **Controller | I/O Configure** menu item.
2. If the ZX OCS is connected to the PC press the **Auto Config System** button to automatically detect the Base model, I/O and any communication options.
3. If the ZX OCS is not connected press the **Config** button to the right of the top of the unit. This allows the base CPU to be selected.
4. Select either **ZX OCS Cscan** from the type drop down box.
5. Once the type of ZX OCS is selected, the model # drop down box will provide the ZX OCS model numbers from which to choose from.
6. Once the ZX OCS CPU is selected, press **OK** to exit the dialog and configure the I/O that is present in the first slot

CHAPTER 14: FAIL SAFE SYSTEM

14.1 Overview

The Fail-Safe System is a set of features that allow an application to continue running in the event of certain types of "soft" failures. These "soft" failures include:

- Battery power loss
- Battery-Backed Register RAM or Application Flash corruption due to, for example, an excessive EMI event.

The Fail-Safe System has the following capabilities:

- Manually backup the current Battery-Backed RAM Register Settings into Flash memory.
- Manually restore Register Settings from the values previously backed up in Flash to Battery-Backed RAM.
- Detect corrupted Register Settings at power-up and then automatically restore them from Flash.
- Detect corrupted or empty application in Flash memory at power-up and then automatically load the AUTOLOAD.PGM application file from Removable Media (Compact Flash or MicroSD).
- If an automatic Register Restore or Application Load occurs, the OCS can automatically be placed in RUN mode

The fail-safe system can be accessed by going to the system menu of the controller. A new menu "Fail-Safe System" has been added at the end of the main system menu for this. Selecting "Fail-Safe System" menu will open the following menu screen:



Figure 16.1 – Fail – Safe System Menu

14.2 Settings

To use the fail – safe feature, the user needs to do the following:

1. Backup the current Battery-Backed RAM Register contents in On-Board Flash memory using System Menu options.
2. From Cscope, create AUTOLOAD.PGM for the application program using 'Export to Removable Media'.
3. Place the Removable Media with AUTOLOAD.PGM in the device.
4. Set the 'Enable AutoLoad' option in the device to YES.
5. Set the 'Enable AutoRun' option to YES if the controller needs to be placed in RUN mode automatically after automatic restore of data or AutoLoad operation.

14.3 Backup / Restore Data

Selecting this option brings up a screen having four operations:

- Backup OCS Data.
- Restore OCS Data.
- Clear Backup Data.
- Exit



Figure 16.2 – Backup / Restore Data

Backup OCS Data:

When initiated, this will allow the user to manually copy Battery-Backed RAM contents on to the onboard FLASH memory of the OCS. This will have the effect of backing up all the registers and controller settings (Network ID, etc.) that would otherwise be lost due to a battery failure. %SR164.4 is set to 1 when backup operation is performed.



Figure 16.3 – Backup Registers

Restore OCS Data:

When initiated, this will allow the user to manually copy the backed up data from the onboard FLASH to the Battery-Backed RAM.

A restore operation will be automatically initiated if a backup has been previously created and on power-up the Battery-Backed RAM registers fail their check.

The following process will be followed for restoring data:

- The controller will be placed in IDLE mode.
- Data will be copied from onboard FLASH to OCS Battery-Backed RAM
- The controller will reset.
- The controller will be put in RUN mode if the AutoRun setting is 'Yes' else it will remain in IDLE mode.



Figure 16.4 – Restore OCS Data

%SR164.3 is set to 1 only when an automatic restore operation is performed - not on a manual one. This bit is reset to 0 when a new backup is created.

Restoring of data can be manually performed by selecting RESTORE option from the Backup / Restore Data menu. This will cause the controller to reset.

Clear Backup Data:

When initiated, the backup data will be erased from the onboard Flash and no backup will exist. %SR164.4 and %SR164.3 is reset to 0 when backed up data is erased.



Figure 16.5 – Clear Backup Data

Exit: Goes back to the previous screen.

The OCS follows the following sequence in execution of Automatic Restore:

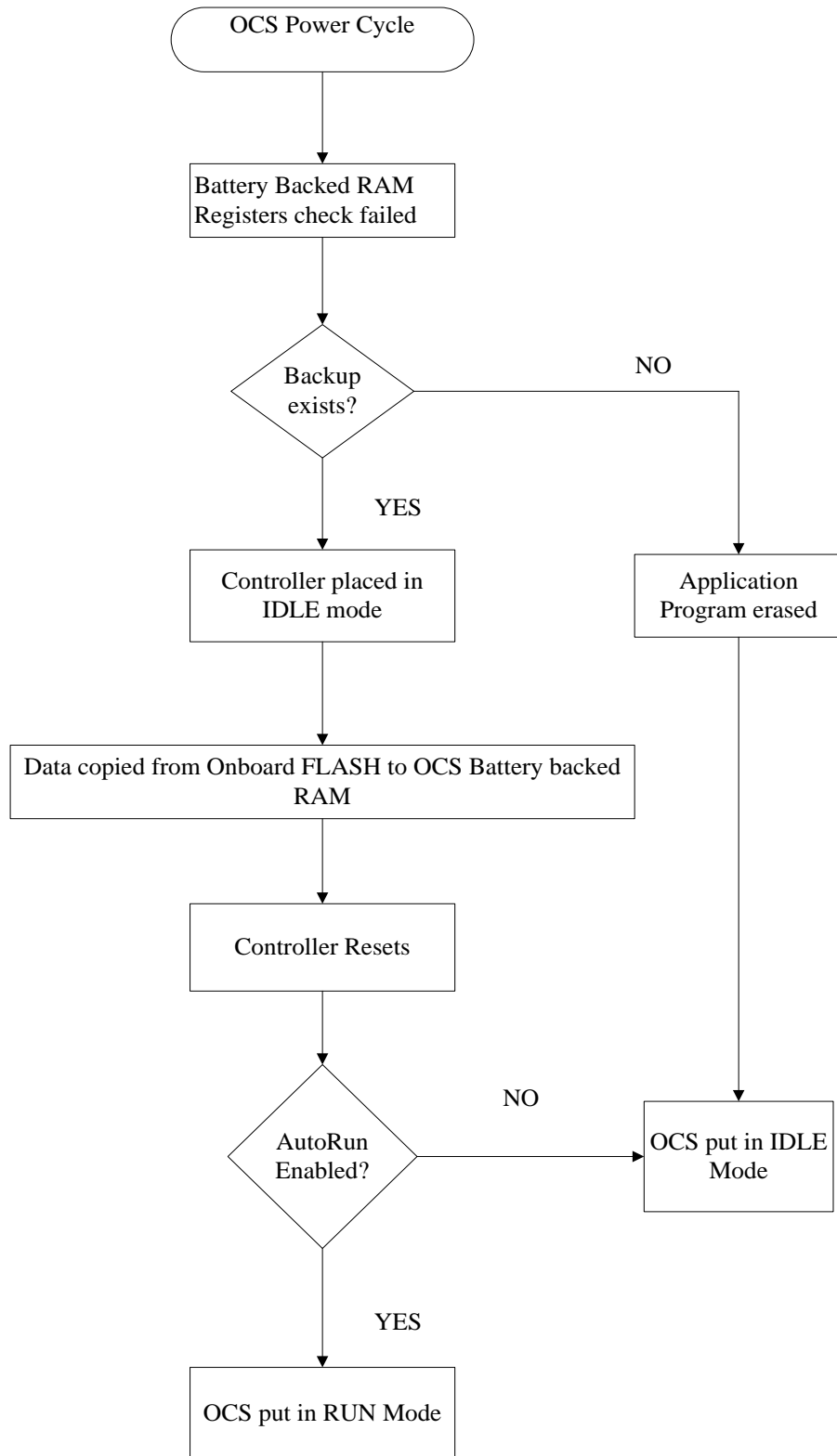

Figure 16.6 – Flow Chart for Automatic Restore

14.4 AutoLoad

This system menu option allows the user to specify whether the OCS automatically loads the application AUTOLOAD.PGM located in Removable Media.

When the AutoLoad setting is enabled (set to YES), it can either be manually initiated or automatically initiated at power-up.

The automatic initiation will happen only in the following two cases:

- When there is no application program in the OCS and a valid AUTOLOAD.PGM is available in the removable media of the device.
- When the program residing in onboard memory is corrupted and a valid AUTOLOAD.PGM is available in the removable media of the device.

AutoLoad can be manually initiated when the SYS-F3 key is pressed (OCS can be in any of the following mode – Idle / Run / DOIO). This also requires a valid AUTOLOAD.PGM to be present in the removable media of the device.

When the AutoLoad setting is not enabled (set to NO), OCS will be in IDLE mode and the application is not loaded.

If the AUTOLOAD.PGM is security enabled, the user will be prompted to enter the password before loading the application. The application will be loaded from the Removable media only after getting the correct password.

%SR164.6 can be set to enable AutoLoad feature.

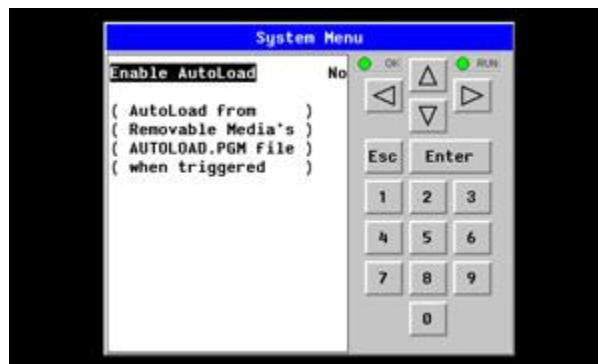

Figure 16.7 – AutoLoad Menu

The OCS follows the following sequence in execution of AutoLoad:

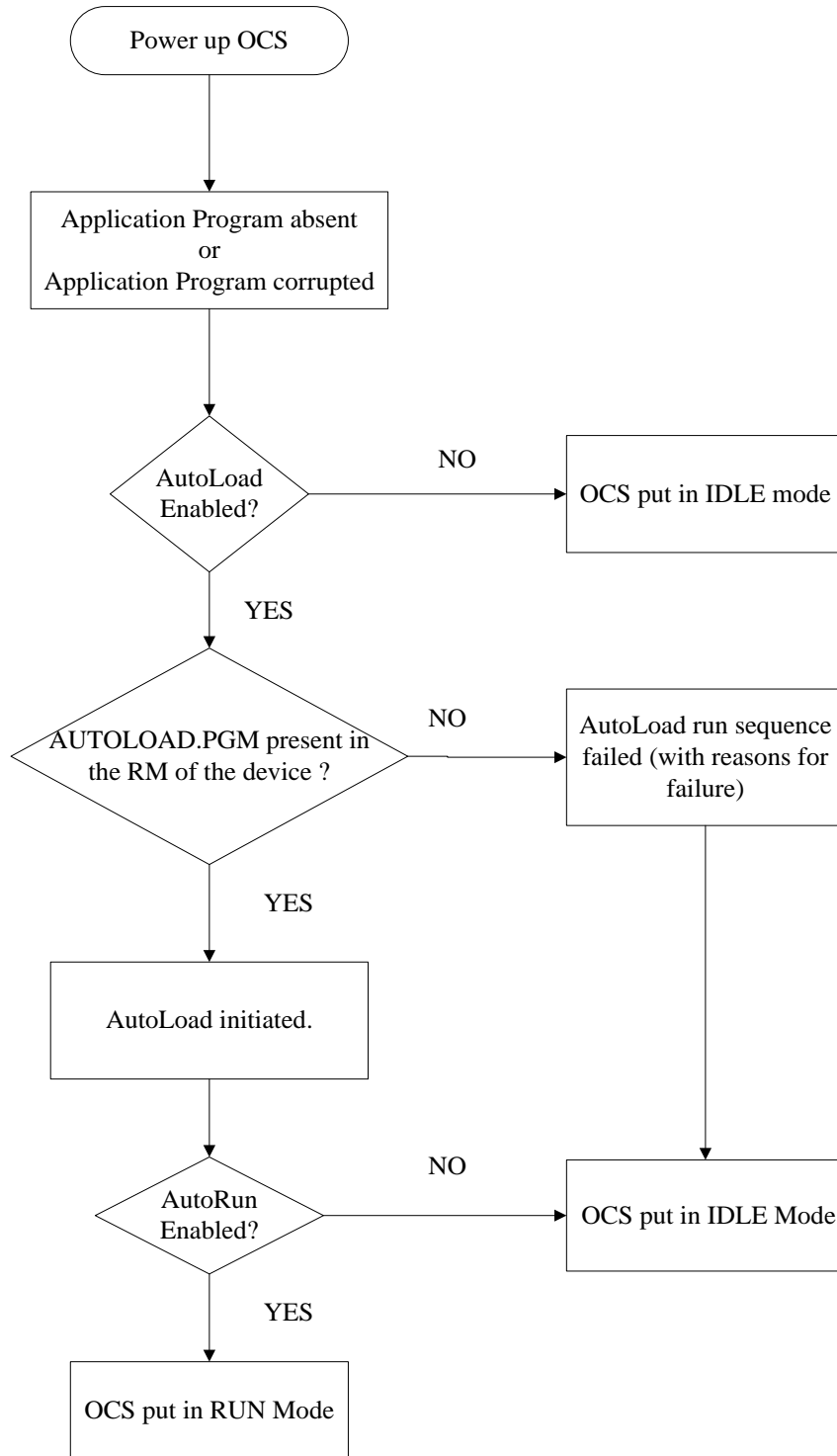

Figure 16.8 – Flow Chart for AutoLoad

14.5 AutoRun

This system menu option, when enabled (YES), allows the user to automatically place the OCS into RUN mode after the AutoLoad operation or automatic Restore Data operation.

When the AutoRun setting is disabled (NO), the OCS remains in the IDLE mode after a Restore Data or AutoLoad operation.

%SR164.5 can be set by putting the system into RUN mode automatically, once an AutoLoad has been performed or an Automatic Restore has occurred.

If for any reason the AutoLoad-Run (Loading the AUTOLOAD.PGM automatically and OCS put in RUN mode) sequence does not succeed, a pop-up message box saying "AUTO-LOAD-RUN SEQUENCE FAILED" will be displayed. It will also show the reason for its failure. On acknowledging this message box the AutoLoad-Run sequence will be terminated, controller will return to the first user-screen and will be placed in IDLE mode.

*Figure 16.9 – AutoRun Menu*

CHAPTER 15: CLONE UNIT

15.1 Overview

'Clone Unit' feature allows the user to "clone" the OCS of the exact same model. This feature "clones" application program and unit settings stored in Battery backed RAM of an OCS into the RM (refer Removable Media Chapter for details in using RM). It can then be used to clone a different OCS (exact same model). The ZX uses Flash drive A to both clone and copy to additional units.

This feature can be used for:

- Replacing an OCS by another unit of the same model.
- Duplicating or "clone" units without a PC.

15.2 Clone

User needs to perform the following to Clone:

1. The 'Clone Unit' can be accessed by going to the 'System Menu' of the OCS. A new menu "Clone Unit" has been added at the end of the main system menu as shown below:

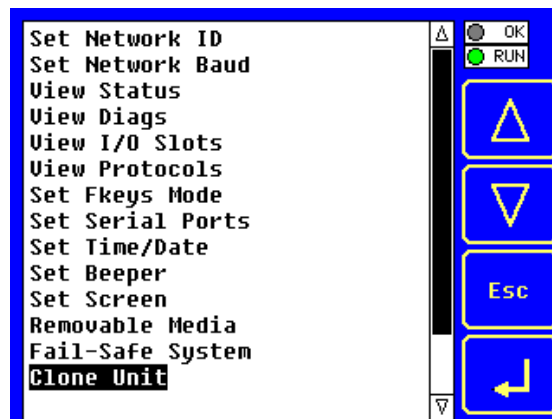

Figure 17.1 – System Menu

2. Selecting "Clone Unit" menu will open the following menu screen:

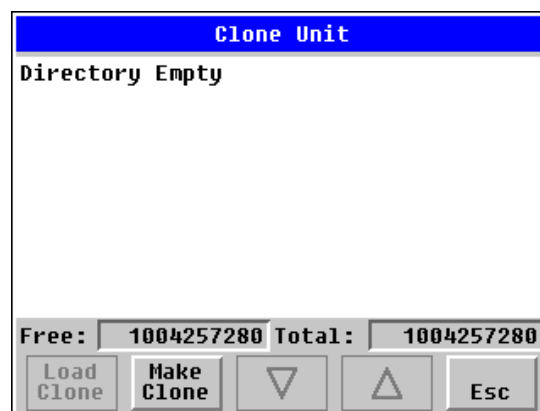

Figure 17.2 – Clone Unit Menu before Cloning

Free/Total – displays number of free and total bytes in Removable Media.

3. Make/Create Clone option enables user to duplicate / Clone application file, all unit settings and all register values from Battery Backed RAM.

Selecting Make Clone brings up the screen below for the user:

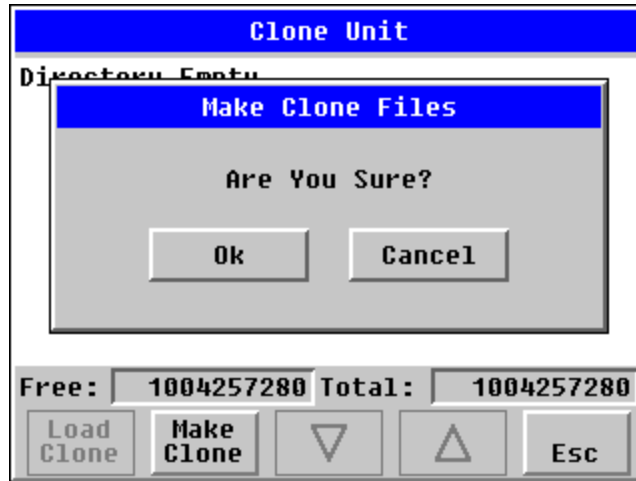

Figure 17.3 – Clone Unit Confirm Screen

After confirmation, the OCS will create two new files in the root directory of the Removable Media Drive as shown below:

AUTOLOAD.PGM
CLONE.DAT

Application file
File having all unit settings and register values from Battery Backed RAM

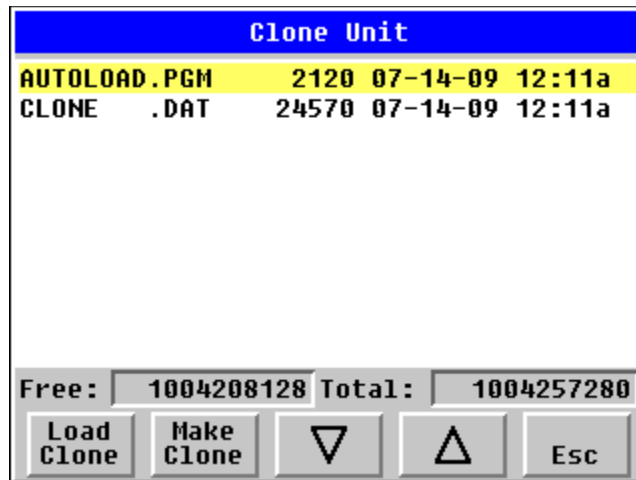

Figure 17.4 – Clone Unit Files

NOTE: Make/Create clone operation automatically includes the security in \AUTOLOAD.PGM file for security enabled files.

4. Once the cloning is successful, OCS gives a message as below:

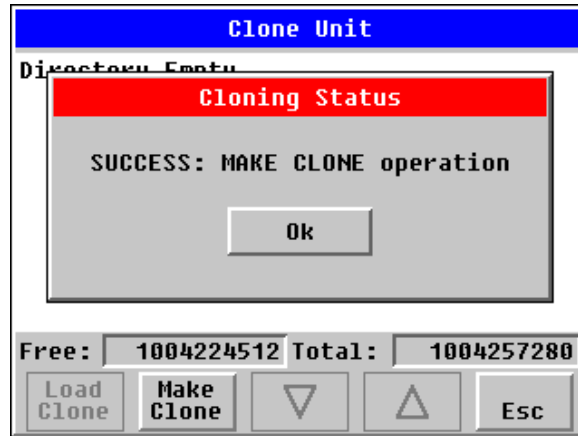

Figure 17.5 – Cloning Status

Make/Create clone can also be triggered by setting %SR164.9 bit to “1” from Ladder program or graphics. Once the operation is completed, this bit is made zero by the firmware. When Make clone operation is triggered by this SR bit, it does not ask the user for confirmation for making clone. The success / failure of the operation is also not notified on screen to the user.

In case of failure of “Make Clone” operation, %SR164.11 bit is set to “1” by the firmware and never reset.

NOTE: Backup of registers in flash memory is not performed by Clone Feature. If user desires, Backup should be done as explained in Chapter 16 (Fail Safe System).

15.3 Load Clone

This option loads the application, all unit settings and register values from Removable media to the Battery backed RAM (Regardless of AutoLoad settings) and then resets the OCS for the settings to take effect.

User needs to perform the following to Load Clone:

1. Select “Clone Unit” from main system menu of OCS as shown below:

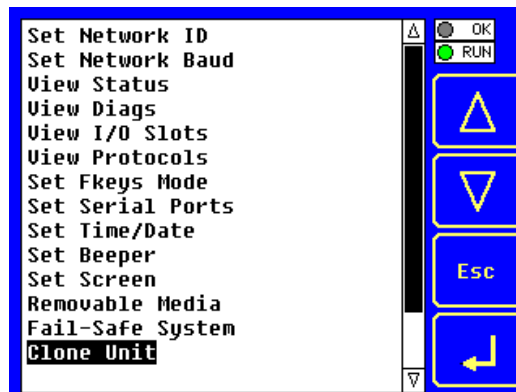

Figure 17.6 – System Menu

2. Selecting “Clone Unit” menu will open the following menu screen. Select “Load Clone”.

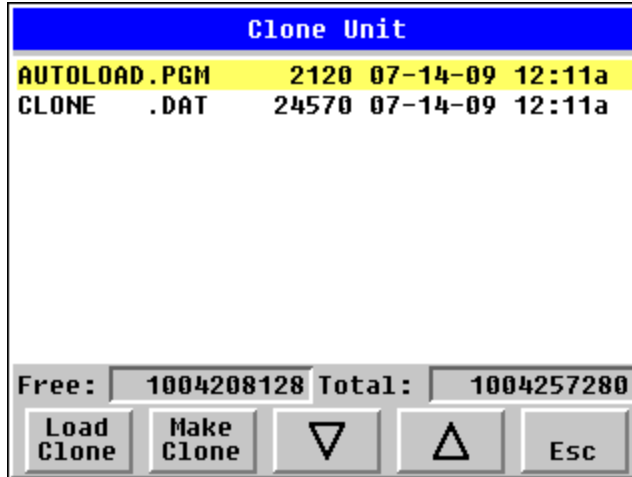

Figure 17.7 – Clone Unit Menu after Cloning

3. User needs to confirm Load Clone as shown below:

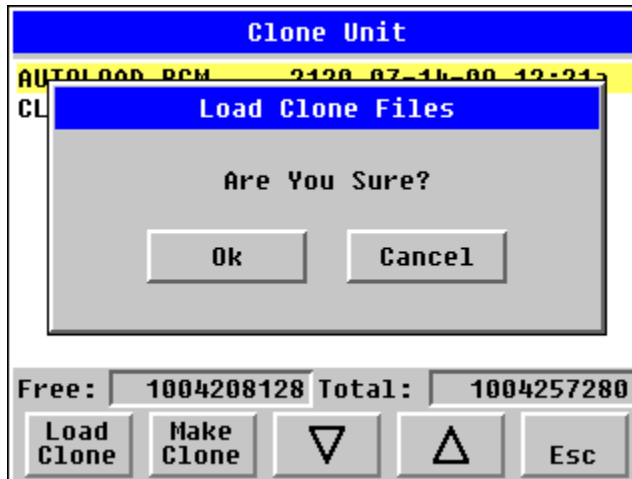

Figure 17.8 – Load Clone Confirm Screen

4. After confirmation, all unit settings and register values will be loaded from Removable media to the Battery backed RAM (Regardless of AutoLoad settings) and then OCS resets for the settings to take effect.

NOTE: For security enabled files, Load clone asks for password validation before loading the application.

Load clone can also be triggered by setting %SR164.10 bit to "1" from Ladder program or graphics. Once the operation is completed, this bit is made zero by the firmware. When Load clone operation is triggered by this SR bit, it does not ask the user for confirmation for loading clone. The success / failure of the operation is also not notified on screen to the user.

In case of failure of "Load Clone" operation, %SR164.12 bit is set to "1" by the firmware and never reset.

CHAPTER 16: MAINTENANCE

16.1 Screen Cleaning

The screen and overlay on the ZX OCS should be cleaned with a damp, soft cloth and dried appropriately. The unit should be powered down for screen cleaning.

It is not recommended to use harsh chemicals or abrasives on the screen and overlay, as they may cause damage to the unit.

16.2 Firmware Updates

Overview:

The ZX controller firmware is updated by a bootloader, using USB Flash drive (**not through the Cescape Firmware Update Wizard**). To update or change firmware:

- 1) Save Firmware files to USB.
- 2) Update the firmware through the controller's Firmware Update function

Configuration:

- 1) Visit www.heapg.com and click **LOG IN** (an account is required to access firmware updates, create one if necessary). Go to **Support→Controller Firmware** and download the most recent firmware set with the correct communication protocol.

-OR-

Visit <http://www.horner-apg.com/en/download/ocs.aspx> and click the **Firmware tab**. In and download the desired firmware (an account is required to access firmware updates, create one if necessary).

Note: The following process will clear the application program. Make sure to back up before updating firmware.

- 2) Update firmware in a ZX by completing the following steps:
 - a. Unzip all files (from step 1's downloaded .zip file) onto a USB Flash drive.
 - b. On the USB Flash drive, rename one of the following files to **syslinux.cfg**:

syslinux.cfg_zx452 [to upgrade a 7" ZX452]
syslinux.cfg_zx752 [to upgrade a 15" ZX752]
syslinux.cfg_zx1152 [to upgrade a 22" ZX1152]
 - c. Plug the USB Flash drive into a powered-up ZX.
 - d. Touch the upper-right-hand screen corner to slide out the control panel.
 - e. Press and hold the **SYS** key until the **System Recovery** screen appears. **Press System Upgrade**.
 - f. Press the **Install Bootloader** button and then press **Yes**.
 - g. When **Operation Completed** appears, press **OK**.
 - h. Power-cycle the ZX and wait for it to boot up.
 - i. Touch the upper-right-hand screen corner to slide out the control panel.
 - j. Press **SYSTEM**, select **View Status** and press the **Enter** button.
 - k. Scroll down to see the versions numbers, which should be:

Firmware Rev: 14.02
BIOS Rev: (Depends on Model)
CAN Rev: 0.05
InitRD Rev: 1.01
OS Ver: 3.1.4-01

Note: Different firmware versions will reflect different values.

- I. If any of the version numbers are incorrect, verify the correct files were copied to the USB Flash drive and repeat steps c through k.

CHAPTER 17: TROUBLESHOOTING / TECHNICAL SUPPORT

Chapter 17 provides commonly requested **troubleshooting information and checklists** for the following topics.

- Connecting to the ZX OCS controller
- Local controller and local I/O
- CsCAN Network
- Removable media

In the event that this information is not enough, please contact Technical Support at the locations indicated at the end of this chapter.

17.1 Connecting to the ZX OCS

Cscape connects to the local controller automatically when the serial connection is made. The status bar below shows an example of a successful connection. This status bar is located in the bottom right hand corner of the Cscape window.

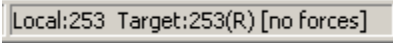

In general the **Target** number should match the **Local** number. The exception to this is when the controller is being used as a "pass through" unit where other controllers on a CsCAN network could be accessed through the local controller.

Determine connection status by examining feedback next to **Local & Target** in the status bar of Cscape.

Local: ###	If a number shows next to Local then communication is established to the local controller.
Local: No Port	Cscape is unable to access the COM port of the PC. This could mean that Cscape is configured for a COM port that is not present or that another program has control of the COM port. Only one Cscape window can access a port at a time. Subsequent instances of Cscape opened will indicate No Port.
Local: No Com	Cscape has accessed a PC COM port, but is not communicating with the controller. This typically occurs when the controller is not physically connected.
Local: ???	Unknown communication error. Close Cscape, power cycle the controller and reopen Cscape with a blank project. Check Local.
Target: #(I,R,D)	If I (idle), R (run), or D (do I/O) shows next to Target number then communication is established to the target controller.
Target: #(?)	Communication is not established to the target controller. Check node ID of controller and set Target to match. Make sure local connection is established.

Table 19.1 – Cscape Target & Local Numbers

17.1.1 **Connecting Troubleshooting Checklist (serial port – MJ1 Programming)**

1. Programming and debugging must use MJ1 or USB Mini B Port.
2. Controller must be powered up.
3. Ensure that the correct COM port is selected in Cscape. Tools/Editor Options/Communications Port.
4. Ensure that a straight through (non-null modem) serial cable is being used between PC and controller port MJ1.
5. Check that a Loaded Protocol or ladder is not actively using MJ1. Taking the controller out of run mode from the System Menu on the controller will make MJ1 available to Cscape.
6. Make sure the COM port of the PC is functioning. An RS232 serial loopback and Microsoft HyperTerminal can determine positively if the COM port is working. Or connect to an alternate device to determine if the port is working.
7. Successful communications with USB-to-serial adapters vary. If in doubt, Horner APG offers a USB to serial adapter. Part number HE500USB600.
8. ZX OCS units without Ethernet must use MJ1 or the Mini B USB Port for programming and debugging. If Ethernet is installed it can be selected as the programming port. The selection is made in the controller's System Menu. If there are difficulties connecting, make sure that the default programming port is set correctly with the connection method being attempted.

17.1.3 **Connecting Troubleshooting Checklist (ETN port programming)**

1. Programming and debugging must use MJ1 or Ethernet Port.
2. Controller must be powered up.
3. Ensure that correct IP address is given in the Ethernet field and correct Mode is selected, in Cscape: Tools/Editor Options/Communications Port
4. Ensure that the Ethernet Cable is connected between the controller and the Ethernet Hub.
5. Make sure the Ethernet cable is functioning properly.

17.2 **Local Controller and Local I/O**

The system menu provides the following status indications that are useful for troubleshooting and system maintenance.

- Self-test results, diagnostics.
- RUN and OK status
- Network status and usage
- Average logic scan rate
- Application memory usage
- Loaded firmware versions
- Loaded protocols
- Removable media access

To view the system menu, press the System key.



17.2.1 **Local I/O Troubleshooting Checklist**

1. Verify the controller is in RUN mode.
2. Check diagnostics to insure controller passed self-tests.
View diags in System Menu or in Cscape, click; Controller/Diagnostics
3. Check data sheets to insure proper wiring.
4. Insure that hardware jumpers and software configuration for I/O match.
5. Check data sheets for voltage and current limits.
6. Take ladder out of the picture. From Cscape set controller to "Do I/O" mode. In this mode inputs can be monitored and outputs set from a data watch window in Cscape without interference from the ladder program. Some I/O problems are only a result of a mistake in the ladder program.

WARNING: Setting outputs ON in Do I/O mode can result in injury or cause machinery to engage in an unsafe manner depending on the application and the environment.

17.3 CsCAN Network

For complete information on setting up a CsCAN network, refer to CAN Networks manual (MAN0799) by visiting the Horner websites for the address to obtain documentation and updates.

Network status, node ID, errors, and baud rate in the controller system menu are all in reference to the CsCAN network. These indications can provide performance feedback on the CsCAN network and can also be used to aid in troubleshooting.

17.3.1 CsCAN Network Troubleshooting Checklist

1. Use the proper Belden wire type or equivalent for the network as specified in MAN0799.
2. The ZX OCS does not provide 24VDC to the network. An external voltage source must be used for other devices such as SmartStix I/O.
3. Check voltage at both ends of the network to insure that voltage meets specifications of attached devices.
4. Proper termination is required. Use 121-ohm (or 120-ohm) resistors at each end of the network. The resistors should be placed across the CAN_HI and CAN_LO terminals.
5. Measure the resistance between CAN_HI and CAN_LO. If the network is properly wired and terminated there should be around 60 ohms.
6. Check for duplicate node ID's.
7. Keep proper wires together. One twisted pair is for V+ and V- and the other twisted pair is used for CAN_HI and CAN_LO.
8. Make sure the baud rate is the same for all controllers on the network.
9. Assure shields are connected at one end of each segment -- they are not continuous through the network.
10. Do not exceed the maximum length determined by the baud rate and cable type.
11. Total drop length for each drop should not exceed 6m (20 feet). A drop may include more than one node. The drop length adds to the overall network length.
12. Network should be wired in "straight line" fashion, not in a "star" pattern.
13. In applications requiring multiple power supplies, make sure the V- of all supplies is connected together and to earth ground at one place only.
14. In some electrically noisy environments it may be necessary to add repeaters to the network. Repeaters can be used to add additional nodes and/or distance to the network and protect the signal against noisy environments. The Horner APG repeater is part # HE200CGM100.

17.4 Removable Media - Basic Troubleshooting

Description	Action
ZX OCS does not read media card.	The media card should be formatted with the ZX OCS.
ZX OCS will not download project file.	Make sure the project file is saved as a .pgm file and not a .csp file. In addition, to file must be .pgm, the file's I/O configuration must match the ZX configuration for it to download.

Table 19.2 – Removable Media Troubleshooting

17.5 Technical Support Contacts

For manual updates and assistance, contact Technical Support at the following locations:

North America:

Tel: 1-877-665-5666

Fax: (317) 639-4279

www.heapg.com

Email: techspt@hornerautomation.com

Europe:

Tel: (+) 353-21-4321-266

Fax: (+353)-21-4321826

www.horner-apg.com

Email: tech.support@hornerapg.com

Main Index

- Accessories, 14**
- AutoLoad, 77**
- AutoRun, 79**
- Backup / Restore, 73**
- Battery backed RAM, 55, 80**
- CAN Comm**
 - Cscape Programming, 31**
 - I/O Expansion (Network I/O), 31**
 - Ladder-Controlled, 31**
 - Overview, 30**
 - Ports, 30**
- CAN Communications, 30**
- CE, 11**
- Clone Unit, 55, 80**
- CLONE.DAT, 56, 81**
- COM, 28, 29, 31, 48, 49, 51, 65, 86, 87**
- COM port, 86, 87**
- Communicating via MJ1 Serial Port, 71**
- Communication options, 32**
- Communications Port, 87**
- Compliance**
 - CE, 11**
- Cscape Program**
 - Via Serial Port, 29**
- Cscape, 14, 28, 29, 30, 31, 37, 49, 50, 61, 68, 70, 71, 86, 87**
 - Configuration Procedures, 72**
 - Establishing Communications, 71**
 - Overview, 70**
 - Status Bar, 70**
- CSCAPE CONFIGURATION, 70**
- datasheet, 8**
- Default Gateway, 34**
- Devices to Connect to XL6, 13**
- Dimensions, 20**
- ELECTRICAL INSTALLATION, 26**
- Ethernet, 65, 71, 87**
- Ethernet Communication, 32**
- Ethernet Module**
 - Default Gateway, 34**
 - IP Address, 34**
 - Net Mask, 34**
 - Status Register, 34**
- Ethernet Module Configuration, 32**
- Ethernet Module Protocols and Features, 32**
- Ethernet Module Specifications, 32**
- Ethernet System Requirements, 32**
- Fail Safe System Overview, 73**
- Fail Safe System Settings, 73**
- Features, 14**
- Firmware Updates, 84**
- Ground Specification, 26**
- Grounding**
 - Locations of Information, 10**
- Grounding Definition, 26**
- IP Address, 34**
- LIMITED WARRANTY, 3**
- Load Clone, 56, 82**
- Maintenance, 80, 84**
- Make Clone, 80**
- Manual Index, 13**
- Mechanical installation, 16**
- Micro SD System, 36**
- Minimum Clearance Requirements for Panel Box and Door, 23**
- Mounting Orientation, 17**
- Mounting Requirements, 16**
 - Panel Door Mounting, 16*
- Net Mask, 34**
- OCS Reference Document Numbers, 14**
- Orientation of ZX OCS, 18**
- Panel Box**
 - Clearances, 23**
 - Grounding, 23**
 - Noise, 23**
 - Orientation, 23**
 - Temperature, 23**
- Panel Box Shock and Vibration, 23**
- Panel Cut-out, 18**
- Panel Cutout Tolerances, 19**
- Panel Design Checklist, 24**
- Panel Layout / Clearances, 23**
- Panel Mounting of an ZX Series OCS, 16**
- Power Connector (Primary Power Port), 27**
- Primary Power Port, 27**
- Primary Power Port As Viewed Looking at the ZX OCS, 27**
- Primary Power Port Pins, 27**
- PROGRAMMING EXAMPLES, 3**
- References / Useful documents, 14**
- registers, 65**
- Registers**
 - %S / %SR, 65**
 - Definitions, 65**
 - Resource Limits, 68**
- Removable Media**

- Load / Save Applications, 37
- Log Data, 37
- Overview, 36
- Save Applications XL6, 37
- View / Capture, 38
- REMOVABLE MEDIA, 36**
- Removable Media Manager, 37
- Removable Media Manager Submenu, 37
- Removable Media ZX, 53
- Removable Memory Card Slot Photograph, 36
- RS-485 Biasing, 28
- safety / compliance, 10
- Safety Warnings, Guidelines, 10
- Serial Comm
 - Cscape Programming, 29
 - Downloadable Protocols, 29
 - Ladder-Controlled, 29
 - Overview, 28
 - Ports, 28
- SERIAL COMMUNICATIONS, 28**
- Set Network ID, 47, 71
- Sub-Menus, 46
- System Menu
 - Details, 47, 57
 - Navigate / Edit, 46
- System Menu (XL6) Screenshot, 46
- SYSTEM SETTINGS AND ADJUSTMENTS, 46**
- Sytem Menu
 - Overview, 46
- Table of Contents, 5
- target ID, 71
- Target ID, 71
- target indicator, 71
- Technical Support, 2, 14, 86, 88
 - Contacts, 88
- Testing for Good Ground, 26
- Troubleshooting
 - Common problems, 86
 - Connecting Checklist, 87
 - CsCAN Checklist, 88
 - CsCAN Network, 88
 - Removable Media, 88
- troubleshooting / technical support, 86
- Troubleshooting Checklist (serial port – MJ1)
 - Programming, 87
- Troubleshooting Checklist (Ethernet port Programming) 87
- Two-Point Ground Connection Test, 26
- Types of Devices that can be connected to ZX, 13
- USB, 31, 71, 87
- User Interface
 - Ladder Based Navigation, 61
 - Screen Navigation, 60
- Using Removable Media to View and Capture Screens, 38
- Visual Overview of ZX and Topics, 12
- Where to Find Information, 13
- ZX Dimensions, 20
- ZX Manual PREFACE, 2
- ZX OCS Accessories, 14
- ZX OCS Dimensions, 20
- ZX OCS Mounting Clip, 17
- ZX OCS Mounting Orientation, 18

Index of Figures & Tables

Figure 2.1 – Visual Overview of the ZX OCS..... 13

Figure 2.2 – Visual Overview of Types of Devices that can be connected to ZX OCS 13

Figure 2.2 – Visual Overview of Types of Devices that can be connected to ZX OCS..... 13

Figure 3.1 – General Panel Mounting of an OCS..... 16

Figure 3.3 – General Orientation of OCS..... 18

Figure 4.1 – Two-Point Ground Connection Test..... 26

Figure 4.2 – Power Connector (Primary Power Port)..... 27

Figure 4.3 – Primary Power Port as Viewed Looking at the ZX OCS..... 27

Figure 6.1 – CAN1 & CAN2 Connector Locations ZX452 (Left) and ZX752/1152 (Right)..... 30

Figure 6.2 – CAN1 / CAN2 Port Pins (Single above when used with adapter, Dual Below)..... 31

Figure 7.1 – Hardware Configuration Dialog (above) Figure 7.2 Ethernet Configuration (below)..... 33

Figure 8.1 – Removable MicroSD Memory Card Slot ZX452 (top) and ZX752/1152 (bottom)..... 36

Figure 11.1 – Example Screen..... 58

Figure 11.2 – Alpha-numeric Keypad and ASCII Keypad 59

Figure 13.3 – Typical Screen Jump Object 60

Figure 11.4 – Force and Switch Coils in Ladder Programming 61

Figure 13.5 – Alarm Object 62

Figure 13.6 – Alarm Viewer..... 62

Figure 13.7 – Removable Media Object..... 63

Figure 13.8 – Removable media viewer..... 63

Figure 13.9 – Example application segment for safe removal of removable media 64

Figure 16.1 – Fail – Safe System Menu 73

Figure 16.2 – Backup / Restore Data 74

Figure 16.3 – Backup Registers 74

Figure 16.4 – Restore OCS Data 75

Figure 16.5 – Clear Backup Data 75

Figure 16.6 – Flow Chart for Automatic Restore 76

Figure 16.7 – AutoLoad Menu..... 77

Figure 16.8 – Flow Chart for AutoLoad 79

Figure 16.9 – AutoRun Menu 79

Figure 17.1 – System Menu 80

Figure 17.2 – Clone Unit Menu before Cloning 80

Figure 17.3 – Clone Unit Confirm Screen 81

Figure 17.4 – Clone Unit Files..... 81

Figure 17.5 – Cloning Status..... 82

Figure 17.6 – System Menu..... 82

Figure 17.7 – Clone Unit Menu after Cloning..... 83

Figure 17.8 – Load Clone Confirm Screen..... 83

Configuration: 84

Table 2.1 – ZX OCS Accessories..... 15

Table 2.2 – OCS Reference Document Numbers 15

Table 3.1 – Minimum Clearance Requirements for Panel & Door 19

Table 4.1 – Primary Power Port PINs..... 23

Table 7.1 – Ethernet Module Protocols & Features 28

Table 7.2 – Ethernet Module Specifications 28

Table 7.3 – Ethernet Status Word Register Format 33

Table 8.1 – XL Series COM Options 33

Table 9.1 – Filename Special Values 33

Table 9.2 – RM Status Values 37

Table 10.1 – I/O & Model Overview..... 40

Table 11.1 – Glossary of High Speed I/O Terms 44

Table 11.2 – HSC Functions Register Map 48

Table 11.3 – PWM Functions Register Map..... 51

Table 14.1 – Type of Registers found in the ZX OCS 74

Table 14.2 – Common %S Register Definitions 74

Table 14.3 – %SR Registers 74

Table 14.4 – Register Map for ZX I/O..... 77

Table 14.5 – Resource Limits..... 77
Table 19.1 – Cscape Target & Local Numbers 102
Table 19.2 – Removable Media Troubleshooting..... 105