

# RCC2414 DATASHEET

**2 Digital Inputs, 4 Digital Outputs  
1 Analog Input, 4 Analog Outputs**

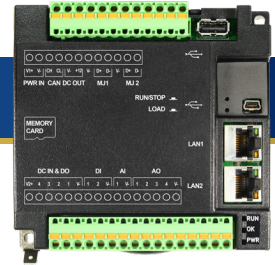

## 1 TECHNICAL SPECIFICATIONS

### 1.1 General

Required Pwr. (steady state)	120mA at 24VDC
Required Pwr. (inrush)	25A for 1 ms at 24VDC switched
Primary Pwr. Range	20-28VDC
Real-Time Clock	Yes
Clock Accuracy	+/- 8 seconds/month at 25°C
Relative Humidity	5-95% non-condensing
Operating Temp.	-10°C to +60°C
Storage Temp.	-10°C to +70°C
Altitude	Up to 2000m
Battery	Li-Ion Polymer Battery Charging Range 0-50°C
Weight	10 oz / 283.5 g
Mounting	35mm DIN Rail or Panel Surface
Housing Type	Plastic (UL 50 rated, flame retardant, UV resistant)
Certifications (CE)	USA: <a href="https://hornerautomation.com/certifications">https://hornerautomation.com/certifications</a> Europe: <a href="https://www.hornerautomation.eu/support/certifications-2">https://www.hornerautomation.eu/support/certifications-2</a>

### 1.2 Control & Logic

Control Lang. Support	Advanced Ladder Logic or Full IEC 61131-3 Languages
Logic Size & Scan Rate	128kb, 0.013ms/kB
Online Programming Changes	Supported in Advanced Ladder
PID Support	Up to 6
Digital Inputs (%I)	2048
Digital Outputs (%Q)	2048
Analog Inputs (%AI)	512
Analog Outputs (%AQ)	512
Gen. Purpose 16-bit Registers (%R)	4096 Retentive
Gen. Purpose 1-bit Registers (%T)	2048 Non-Retentive
Gen. Purpose 1-bit Registers (%M)	2048 Retentive

### 1.3 Connectivity

Serial	2x2-wire RS485
CAN	1 x 125kbps - 1Mbps
Ethernet	2 x 10Mbps/100 Mbps
microSD	1 x SD, SDHC, SDXC in FAT32 format
USB	1 x Mini Program 1 x USB Flash Drive
Communication Support	WebMI
	Web Portal
	Outgoing Email w/ Attachments
	TCP/IP and Modbus TCP/IP
	FTP
	Data Logging

### 1.4 Digital DC Inputs

Inputs per Module	2
Commons per Module	1
Addressing	%I1 - %I2
Input Voltage Range	10-30VDC
Absolute Max. Voltage	35VDC Max.
Input Impedance	10kΩ
Min. "On" Input	8VDC
Max. "Off" Input	3VDC
OFF to ON Response	100μs min*
ON to OFF Response	100μs min*
Galvanic Isolation	None
Logic Polarity	Positive
I/O Indication	None
High Speed Counter (HSC)	None
Connector Type	5.08mm Pluggable Cage Clamp

### 1.5 Digital DC Outputs

Outputs per Module	4
Commons per Module	1
Addressing	%Q1 - %Q4
Output Type	Sourcing/10kΩ Pull-Down
Absolute Max. Voltage	30VDC Max.
Output Protection	Short Circuit & Overvoltage
Max. Output Current/Point	0.5A
Max. Total Current	2A Total Current
Max. Output Supply	30VDC
Min. Output Supply	10VDC
Max. Voltage Drop at Rated Current	0.25VDC
Max Inrush Current	650mA/Channel
Min. Load	None
I/O Indication	None
Galvanic Isolation	None
OFF to ON Response	100ms min*
ON to OFF Response	15ms min*
PWM Out	None

### 1.6 Analog Inputs

Number of Channels	1
Input Ranges	0 - 10 VDC
Addressing	%AI1
%AI Full Scale Value	32,000
Max Input Voltage	-0.5 to +12VDC
Galvanic Isolation	None
Input Impedance (clamped @ -0.5 to 10.23 VDC)	mA: 15 Ω +/- 1.5V V: 1.1MΩ
Nominal Resolution	12 bits
Conversion Rate	One update/ladder scan
Max Error at 25°C (excludes 0°C)	1.5% of full scale 0-10V - 1.5% of full scale
Filters	270Hz hash (noise), 1-128 scan digital running average

### RCC Series User Manual [MAN1078]

The User Manual includes extensive information on Installation, Communications, etc.

\* all values updated 1x per scan

## technical specifications continued...

### 1.7 Analog Outputs

Number of Channels	4
Output Ranges	0 - 10VDC
Addressing	%AQ1 - %AQ4
%AQ Full Scale Value	32,000
Galvanic Isolation	None
Nominal Resolution	12 Bits
Maximum Current Load	500Ω
Conversion Rate	One update/ladder scan
Response Time	One update/ladder scan
Max Error at 25° C (excludes 0°C)	0.5% of full scale

## 2 CONTROLLER OVERVIEW

### 2.1 - Port Connectors

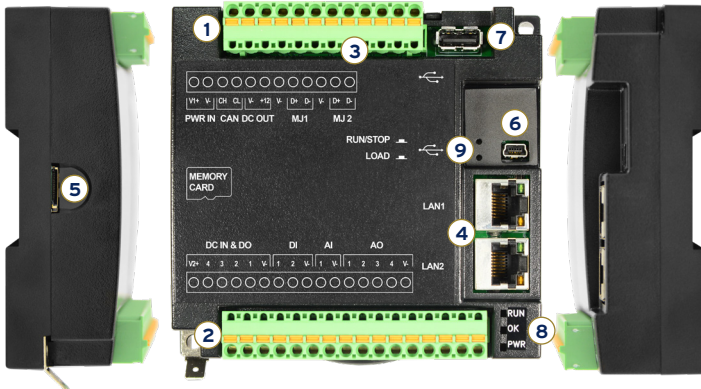

- |                            |                         |                     |
|----------------------------|-------------------------|---------------------|
| 1. Power & Comms Connector | 4. Ethernet Ports       | 7. USB Flash Memory |
| 2. I/O Connector           | 5. microSD Slot         | 8. Status LEDs      |
| 3. Serial Ports            | 6. Mini USB Programming | 9. Buttons          |

### 2.2 - Power Wiring

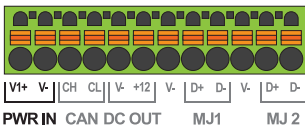

To power up the RCC2414, supply 20-28VDC to the V+ and V- connections on the Power and Comms Connector. Additionally, a 12 V source is provided at the +12 terminal that is capable of 1 A maximum current.

#### Wiring Specifications

- **For I/O Wiring (discrete)**, use the following wire type or equivalent: Belden 9918, 18AWG (0.8mm<sup>2</sup>) or larger.
- **For CAN wiring**, use the following wire type or equivalent: Belden 3084, 24 AWG (0.2mm<sup>2</sup>) or larger.
- **Torque Rating:** 4.5-7 in-lbs (0.50 - 7.8N-m)
- **Power Up:** Connect to Earth Ground. Apply 10-30VDC

## wiring: I/O continued...

### 2.3 - Digital Input Wiring

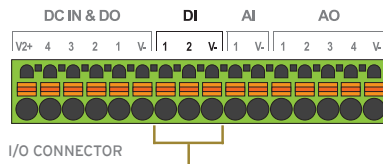

Digital inputs may be wired in A Positive Logic fashion as shown. The state of the inputs are reflected in registers %I1 and %I2.

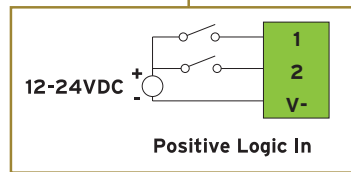

### 2.4 - Digital Output Wiring

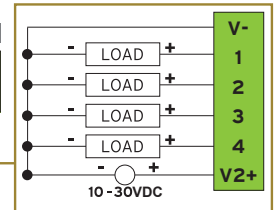
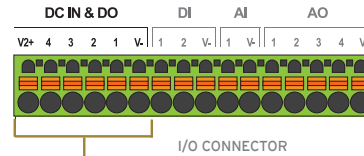

Digital outputs are Positive Logic. If an output is turned on, the voltage supplied at the V+ terminal is applied to that output. The state of the output may be controlled using the registers %Q1, %Q2, %Q3, and %Q4.

### 2.5 - Analog Input Wiring

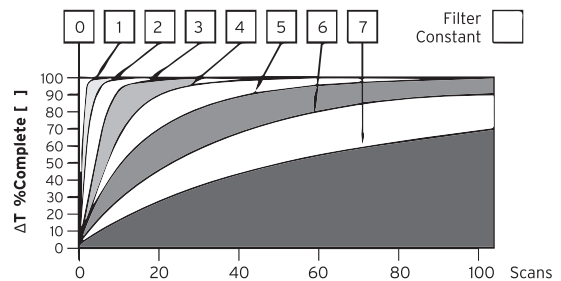
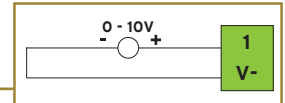
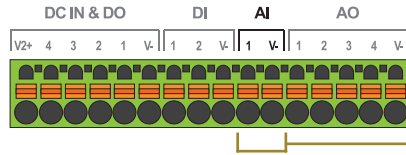

Raw input values for channels 1-4 are found in the registers as Integer-type data with a range from 0 - 32000.

Analog inputs may be filtered digitally with the Filter Constant found in the Cscape Hardware Configuration for Analog Inputs. Valid filter values are 0 - 7 and act according to the following chart.

#### Data Values

INPUT MODE:	DATA FORMAT, 12-bit INT:
0-20mA, 4-20mA	0-32000
0-10V	0-32000

## wiring: I/O continued...

### 2.6 - Analog Output Wiring

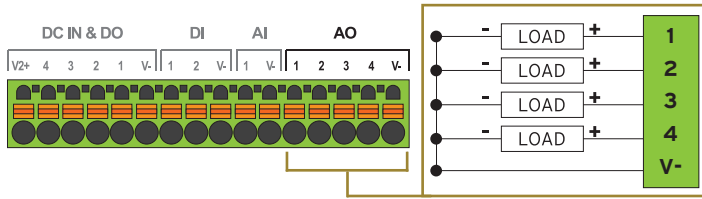

Each Analog Output has a range of 0-10VDC. The Analog Output registers %AQ1 - %AQ4 may be used to control the output by placing a value between 0 - 32000 into the register. This may be directly from a PID loop output or a conversion from a desired output from the touchscreen, for example.

## 3 COMMUNICATIONS

### 3.1 - CAN Communications

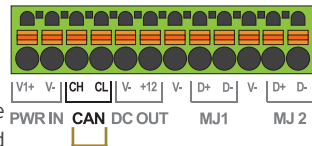

The CAN port is provided via three connections on the CAN, Power, and Analog connector: CAN\_LOW (CL), CAN\_HIGH (CH), and V- (C). It may be used to communicate with other OCS products using Horner's CsCAN protocol. Additionally, remote expansion I/O such as SmartRail, SmartBlock, and SmartStix may be implemented using the CsCAN protocol. If CsCAN expansion I/O is to be used, a 24VDC power source will be required on the CsCAN bus in order to power the expansion I/O modules.

### 3.2 - Serial Communications

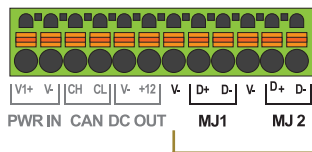

Two serial ports are provided via cage clamp terminals. Both are 2-wire RS-485 only. The most common use is for Modbus communications, either as a Modbus Master or Modbus Slave.

### 3.3 - Ethernet Communications

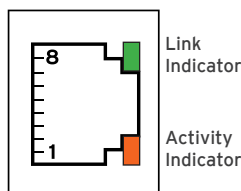

Two 10/100 Ethernet ports with automatic MDI-X (crossover detection) are provided via the 8-position modular jacks labeled "LAN1" and "LAN2". Several features are available for use over Ethernet, such as WebMI, Modbus TCP/IP, Ethernet/IP, SMTP (E-mail) and remote I/O. Ethernet configuration is done via the Cscape Hardware Configuration. For more information on Ethernet, available features and protocols, refer to the Ethernet Supplement document (SUP0740).

### 3.4 microSD Slot

A microSD card may be used for data and alarm logging, historic trending, program loading, firmware updates, and many other features. Supported types of microSD cards are SD, SDHC, and SDXC as long as the format of the card file system is FAT32.

## communications continued...



### 3.5 Status LEDs

Three LEDs provide general status of the RCC:

LED - Normal Functionality			
LED TYPE	WHEN OFF	WHEN ON	WHEN FLASHING (1 Hz)
PWR	No power applied	10-30VDC applied	N/A
OK	Self-test fail	Self-test pass	I/O forcing enabled
RUN	Stop mode	Run mode	Do I/O Mode

### LED - DIAGNOSTIC FUNCTIONALITY

When the OK and RUN are flashing alternately, a download is in progress. When the flashing stops, the download is complete and the unit reboots (allow 30 seconds). When flashing together, the download has failed, and the number of flashes indicates the error. There will be a two second gap and the pattern will be repeated. The number of flashes and the associated error are as follows:

- **2 Flashes** - The MAC ID is empty.
- **3 Flashes** - The internal MAC file is corrupt.
- **4 Flashes** - The MAC ID TXT file is invalid.
- **5 Flashes** - The MAC ID file is not found or the microSD card is empty or missing system files.

### 3.6 - Buttons

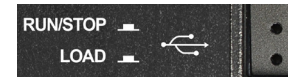

Two recessed buttons provide control of several RCC modes. A paperclip may be used as the buttons are far enough recessed that a pen or pencil is not able to activate them.

#### LOAD SWITCH

- Pressing the LOAD switch during power-up boots from the microSD card. This starts a Firmware Load if the microSD is bootable and valid firmware files are found on it.
- After boot-up, pressing the LOAD switch for three (3) seconds will load an Application file stored on the microSD. The application file name must be DEFAULT.PGM. When loading an application file from microSD, there should not be firmware files present on the microSD card.

#### RUN/STOP SWITCH

- After boot-up, pressing the RUN/STOP switch for 3 seconds toggles the RCC between RUN and STOP modes.

#### ERASE PROGRAM FUNCTION

- After boot-up, pressing both Load and RUN/Stop switches for 3 seconds performs an "Erase All" function, which deletes all application programs.

## 4 BUILT-IN I/O

Digital and Analog I/O Functions	
Registers	Description
%I1 to %I8	Digital Inputs
%I9 to %I15	Reserved
%I16	%Q Fault Status
%Q1 to %Q4	Digital Outputs
%AI1 to %AI8	Analog Inputs
%AQ1 to %AQ4	Analog Outputs

## 5 DIMENSIONS & INSTALLATION

### 5.1 Dimensions

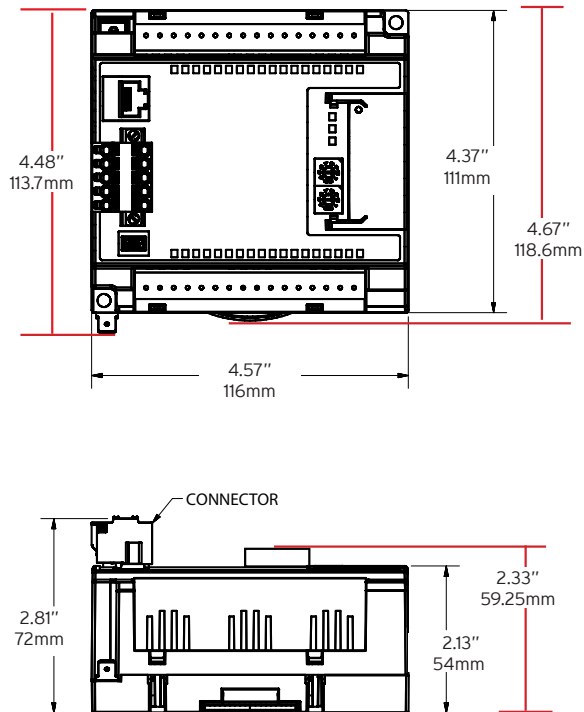

### 5.2 Installation Instructions

These RCC modules are suitable for use in the Class I, Division 2, Groups A, B, C and D Hazardous Locations only.

**WARNING - EXPLOSION HAZARD - DO NOT DISCONNECT EQUIPMENT UNLESS POWER HAS BEEN SWITCHED OFF OR THE AREA IS KNOWN TO BE NON-HAZARDOUS.**

**ATTENTION - RISQUE D'EXPLOSION - NE DÉBRANCHEZ PAS L'ÉQUIPEMENT SAUF SI L'ALIMENTATION A ÉTÉ COUPÉE OU SI LA ZONE N'EST PAS DANGEREUSE.**

Devices shall be installed into an enclosure suitable for the environment that is only accessible with the use of a tool.

1. The RCC modules conveniently mount on a DIN rail.
2. Be sure the DIN rail is in a horizontal position before installing the unit.
3. The orientation shown to the right is necessary to prevent the unit from slipping off the DIN rail.
4. Align the unit on the DIN rail then push the DIN rail clip until it clicks into place. Check to ensure that the unit is secure on the DIN rail.
5. Do NOT mount the unit on its side as this may cause the unit from slipping off the DIN rail.

**NOTE:** The spade connector for grounding and the DIN rail clip add to the overall measurements. The CAN/PWR and LAN connectors also add to the measurements.

**NOTE:** Screw holes and a spade connector are available for a mounting option.

## 6 GLOBAL PART NUMBER

The global part number is HE-RCC2414.

## 7 BATTERY MAINTENANCE

The RCC2414 has an advanced battery system that uses a rechargeable lithium battery. The battery powers the real time clock when power is removed, and it is needed for register data retention. Please reference the RCC Series User Manual [MAN1078] which provides instructions on how to replace the battery.

**NOTE:** For detailed rechargeable battery information, refer to the Battery Manual [MAN1142].

## 8 SAFETY

### 8.1 - WARNINGS

1. To avoid the risk of electric shock or burns, always connect the safety (or earth) ground before making any other connections.
2. To reduce the risk of fire, electrical shock, or physical injury, it is strongly recommended to fuse the voltage measurement inputs. Be sure to locate fuses as close to the source as possible.
3. Replace fuse with the same type and rating to provide protection against risk of fire and shock hazards.
4. In the event of repeated failure, do NOT replace the fuse again as repeated failure indicates a defective condition that will NOT clear by replacing the fuse.
5. Only qualified electrical personnel familiar with the construction and operation of this equipment and the hazards involved should install, adjust, operate, or service this equipment. Read and understand this manual and other applicable manuals in their entirety before proceeding. Failure to observe this precaution could result in severe bodily injury or loss of life.

### 8.2 - FCC COMPLIANCE

This device complies with part 15 of the FCC Rules. Operation is subject to the following two conditions:

1. This device may not cause harmful interference
2. This device must accept any interference received, including interference that may cause undesired operation

### 8.3 - PRECAUTIONS

All applicable codes and standards need to be followed in the installation of this product. Adhere to the following safety precautions whenever any type of connection is made to the module:

1. Connect the safety (earth) ground on the power connector first before making any other connections.
2. When connecting to the electric circuits or pulse-initiating equipment, open their related breakers.
3. Do NOT make connection to live power lines.
4. Make connections to the module first; then connect to the circuit to be monitored.
5. Route power wires in a safe manner in accordance with good practice and local codes.
6. Wear proper personal protective equipment including safety glasses and insulated gloves when making connections to power circuits.
7. Ensure hands, shoes, and floor are dry before making any connection to a power line.
8. Make sure the unit is turned OFF before making connection to terminals.
9. Make sure all circuits are de-energized before making connections.
10. Before each use, inspect all cables for breaks or cracks in the insulation. Replace immediately if defective.
11. Use copper conductors in Field Wiring only, 60/75°C.
12. Use caution when connecting controllers to PCs via serial or USB. PCs, especially laptops, may use "floating power supplies: that are ungrounded. This could cause a damaging voltage potential between the laptop and controller. Ensure the controller and laptop are grounded for maximum protection. Consider using a USB isolator due to voltage potential differences as a preventative measure.

## 9 TECHNICAL SUPPORT

For assistance and manual updates, contact Technical Support at the following locations:

### North America

+1 (317) 916-4274  
 (877) 665-5666  
[www.hornerautomation.com](http://www.hornerautomation.com)  
[techsppt@heapg.com](mailto:techsppt@heapg.com)

### Europe

+353 (21) 4321-266  
[www.hornerautomation.eu](http://www.hornerautomation.eu)  
[technical.support@horner-apg.com](mailto:technical.support@horner-apg.com)