



Supplement for
HE800WCM802 and HE800WCM900
HE-WCM802 and HE-WCM900**
(Denotes Plastic Models)*

SmartStack

Wireless Communication

OEM RF Modem

PREFACE

This manual explains how to use the SmartStack Wireless Communication OEM RF Modem (HE800WCM802/WCM900).

Copyright (C) 2005 Horner APG, LLC., 640 North Sherman Drive Indianapolis, Indiana 46201. All rights reserved. No part of this publication may be reproduced, transmitted, transcribed, stored in a retrieval system, or translated into any language or computer language, in any form by any means, electronic, mechanical, magnetic, optical, chemical, manual or otherwise, without the prior agreement and written permission of Horner APG, Inc. Copyrights of part of this manual belong to MaxStream, Inc.

All software described in this document or media is also copyrighted material subject to the terms and conditions of the Horner Software License Agreement.

Information in this document is subject to change without notice and does not represent a commitment on the part of Horner APG.

SmartStack, SmartStix and CsCAN are trademarks of Horner APG.
XStream is a registered trademark of MaxStream, Inc.

For user manual updates and assistance, contact Technical Support:

North America:

(317) 916-4274

www.heapg.com

Europe:

(+) 353-21-4321-266

www.horner-apg.com

LIMITED WARRANTY AND LIMITATION OF LIABILITY

Horner APG,LLC. ("HE-APG") warrants to the original purchaser that the WCM802 / WCM900 module manufactured by HE-APG is free from defects in material and workmanship under normal use and service. The obligation of HE-APG under this warranty shall be limited to the repair or exchange of any part or parts which may prove defective under normal use and service within two (2) years from the date of manufacture or eighteen (18) months from the date of installation by the original purchaser whichever occurs first, such defect to be disclosed to the satisfaction of HE-APG after examination by HE-APG of the allegedly defective part or parts. THIS WARRANTY IS EXPRESSLY IN LIEU OF ALL OTHER WARRANTIES EXPRESSED OR IMPLIED INCLUDING THE WARRANTIES OF MERCHANTABILITY AND FITNESS FOR USE AND OF ALL OTHER OBLIGATIONS OR LIABILITIES AND HE-APG NEITHER ASSUMES, NOR AUTHORIZES ANY OTHER PERSON TO ASSUME FOR HE-APG, ANY OTHER LIABILITY IN CONNECTION WITH THE SALE OF THIS WCM802 / WCM900 module. THIS WARRANTY SHALL NOT APPLY TO THIS WCM802 / WCM900 module OR ANY PART THEREOF WHICH HAS BEEN SUBJECT TO ACCIDENT, NEGLIGENCE, ALTERATION, ABUSE, OR MISUSE. HE-APG MAKES NO WARRANTY WHATSOEVER IN RESPECT TO ACCESSORIES OR PARTS NOT SUPPLIED BY HE-APG. THE TERM "ORIGINAL PURCHASER", AS USED IN THIS WARRANTY, SHALL BE DEEMED TO MEAN THAT PERSON FOR WHOM THE WCM802 / WCM900 module IS ORIGINALLY INSTALLED. THIS WARRANTY SHALL APPLY ONLY WITHIN THE BOUNDARIES OF THE CONTINENTAL UNITED STATES.

In no event, whether as a result of breach of contract, warranty, tort (including negligence) or otherwise, shall HE-APG or its suppliers be liable of any special, consequential, incidental or penal damages including, but not limited to, loss of profit or revenues, loss of use of the products or any associated equipment, damage to associated equipment, cost of capital, cost of substitute products, facilities, services or replacement power, down time costs, or claims of original purchaser's customers for such damages.

To obtain warranty service, return the product to your distributor with a description of the problem, proof of purchase, post paid, insured and in a suitable package.

ABOUT PROGRAMMING EXAMPLES

Any example programs and program segments in this manual or provided on accompanying diskettes are included solely for illustrative purposes. Due to the many variables and requirements associated with any particular installation, Horner APG cannot assume responsibility or liability for actual use based on the examples and diagrams. It is the sole responsibility of the system designer utilizing the WCM802 / WCM900 module to appropriately design the end system, to appropriately integrate the WCM802 / WCM900 module and to make safety provisions for the end equipment as is usual and customary in industrial applications as defined in any codes or standards which apply.

Note: The programming examples shown in this manual are for illustrative purposes only. Proper machine operation is the sole responsibility of the system integrator.

Contents

1. SmartStack Wireless Communication OEM RF Modems	7
Features	7
Worldwide Acceptance	7
Specifications	8
Pin Signals	9
Electrical Characteristics	10
Timing Specifications	10
Mechanical Drawings	11
2. RF Operation	12
Serial Communications	12
UART-Interfaced Data Flow	12
Flow Control	13
Modes of Operation	14
Idle Mode	14
Transmit Mode	14
Receive Mode	16
Sleep Mode	16
Command Mode	17
3. Advanced Programming	19
Programming the Module	19
AT Command Example	19
Binary Command Example	19
Command Descriptions (Short)	20
Command Descriptions (Long)	21
Appendix A: Agency Certifications	34
FCC Certification	34
OEM Labeling Requirements	35
Antenna Usage	35
FCC-Approved Antennas	36
European Compliance (2.4 GHz only)	37
OEM Labeling Requirements	37
Restrictions	37
Europe (2.4 GHz) Approved Antenna List	38
IC (Industry Canada) Certification	38
Appendix B: Additional Information	39
Technical Support	39

NOTES

1. SmartStack Wireless Communication OEM RF Modems



The Horner SmartStack Wireless Communication OEM RF Modems (HE800WCM802 / HE800WCM900 / HE-WCM802* and HE-WCM900*) are drop-in wireless solutions that transfer a standard asynchronous serial data stream over-the-air between devices. The Wireless Communication Modems (WCM802 / WCM900) stand out in the RFd2d (radio frequency device-to-device) segment of the wireless market with their unique combination of high-performance, ease-of-use and low price.

* HE- denotes plastic case version of the SmartStack module instead of the metal case version, which is indicated by an HE800 prefix in the part number.

Note: The WCM802 and the WCM900 modules are not compatible with each other and can not be used to communicate with one another.

Features

Long Range

HE800WCM900 / HE-WCM900 (900 MHz) Range:

- Indoor/Urban: **up to 1500'** (450 m)
- Outdoor line-of-sight: **up to 7 miles** (11 km) w/ 2.1 dBm dipole antenna
- Outdoor line-of-sight: **up to 20 miles** (32 km) w/ high gain antenna

HE800WCM802 / HE-WCM802 (2.4 GHz) Range:

- Indoor/Urban: **up to 600'** (180 m)
- Outdoor line-of-sight: **up to 3 miles** (5 km) w/ 2.1 dBm dipole antenna
- Outdoor line-of-sight: **up to 10 miles** (16 km) w/ high gain antenna
- Receiver Sensitivity: **-110 dBm** (900 MHz), **-105 dBm** (2.4 GHz)

Advanced Networking & Security

- True peer-to-peer (no "master" required), point-to-point, point-to-multipoint, multidrop
- Retries and Acknowledgements
- 7 hopping channels, each with over 65,000 available network addresses
- FHSS (Frequency Hopping Spread Spectrum)

Worldwide Acceptance

FCC Certified (USA) - Go to Appendix A for FCC Requirements. Systems that contain WCM802 /WCM900 Modules can inherit FCC Certification

ISM (Industrial, Scientific & Medical) frequency band

Manufactured under **ISO 9001:2000 registered standards**

WCM900 (900 MHz) OEM RF Modules are approved for use in **US, Canada, Australia, Israel** (and more).

WCM802 (2.4 GHz) Modules add **Europe** (EU) and other approvals.

Easy-to-Use

5 VDC (\pm 0.25 V) power supply

Continuous RF data stream
up to 19.2 kbps

No configuration required

Advanced configurations available
through standard AT Commands

Portable
(small form factor easily designed into a
wide range of data radio systems)

Software-selectable serial interfacing
rates

MODBUS, CTS, RTS, DTR, DCD (& more)
I/O Support

Support for multiple data formats
(parity, start and stop bits, etc.)

XII™ Interference Immunity

Power-saving Sleep Modes



Specifications

Table 1.1. WCM802/WCM900 OEM RF Module Specifications

Specification	WCM900 (900 MHz) OEM RF Module		WCM802 (2.4 GHz) OEM RF Module	
Performance				
Indoor/Urban Range	up to 1500' (450 m)		up to 600' (180 m)	
Outdoor line-of-sight Range	Up to 7 miles (11 km) w/ dipole antenna Up to 20 miles (32 km) w/ high-gain antenna		Up to 3 miles (5 km) w/ dipole antenna Up to 10 miles (16 km) w/ high-gain antenna	
Interface Data Rate	Software selectable 1200 - 57600 bps			
Throughput Data Rate	9,600 bps	19,200 bps	9,600 bps	19,200 bps
RF Data Rate	10,000 bps	20,000 bps	10,000 bps	20,000 bps
Transmit Power Output	100 mW (20 dBm)	100 mW (20 dBm)	50 mW (17 dBm)	50 mW (17 dBm)
Receiver Sensitivity	-110 dBm	-107 dBm	-105 dBm	-102 dBm
General				
Frequency Range	902-928 MHz		2.4000-2.4835 GHz	
Spread Spectrum	Frequency Hopping, Wide band FM modulator			
Network Topology	Peer-to-Peer, Point-to-Multipoint, Point-to-Point, Multidrop			
Channel Capacity	7 hop sequences share 25 frequencies			
Serial Data Interface	CMOS UART			
Power Requirements				
Supply Voltage	5 VDC (\pm 0.25 V) regulated			
Transmit Current	150 mA			
Receive Current	50 mA			
Power Down Current	< 26 μ A			
Physical Properties				
Module Board Size	1.600" x 2.825" x 0.350" (4.06 cm x 6.86 cm x 0.89 cm)			
Weight	0.8 oz (24 g)			
Connector	11-pin & 4-pin, 0.1" spaced male Berg-type headers			
Operating Temperature	0 to 70° C (commercial), -40 to 85° C (industrial)			
Antenna				
Integrated Wire (optional)	¼ wave monopole, 3" (7.62 cm) length, 1.9 dBi Gain			
Connector (optional)	Reverse-polarity SMA or MMCX			
Impedance	50 ohms unbalanced			
Certifications				
FCC Part 15.247	OUR9XSTREAM		OUR-24XSTREAM	
Industry Canada (IC)	4214A-9XSTREAM		4214A 12008	
Europe	N/A		ETSI, CE	

Pin Signals

Figure 1.1. WCM802 / WCM900 OEM RF Module Pin Numbers (bottom view, pins protruding)



Table 1.2. J1 Pin Signal Descriptions

(Low-asserted signals distinguished with a horizontal line over signal name.)

Module Pin	Signal Name	I/O	When Active	Function
1	DO2 / <u>CTS</u> / RS-485 Enable	O*	low	<u>CTS</u> (clear-to-send) flow control – When pin is driven low, UART host is permitted to send serial data to the module. Refer to the Serial Communications [p9] and CS Command [p19] sections for more information.
				RS-485 Enable – To configure this pin to enable RS-485 (2-wire or 4-wire) communications, refer to the Serial Communications [p9] and CS Command [p19] sections.
2	DI3 / SLEEP	I*	high	By default, DI3 pin is not used. To configure this pin to support Sleep Modes, refer to the Sleep Mode [p13], SM Command [p27] and PW Command [p24] sections.
3	DO (data out)	O*	n/a	Serial data exiting the module (to the UART host). Refer to the Serial Communications [p9] section for more information.
4	DI (data in)	I	n/a	Serial data entering the module (from UART host). Refer to the Serial Communications [p9] section for more information.
5	DI2 / <u>RTS</u> / CMD	I**	low	<u>RTS</u> (request-to-send) flow control – By default, this pin is not used. To configure this pin to regulate the flow of serial data exiting the module, refer to the Serial Communications [p9] and RT Command [p26] sections.
				CMD –Refer to Binary Commands [p15] and RT Command [p26] sections to enable binary command programming.
6	<u>RESET</u>	I*	low	Re-boot module.
7	DO3 / RX LED	O	high	Pin is driven high during RF data reception; otherwise, the pin is driven low. Refer to the CD Command [p19] to enable.
			low	<u>TX</u> - Pin pulses low during RF transmission.
8	<u>PWR</u>	O	high	PWR – Indicates power is on and module is not in Sleep Mode.
			low	
9	<u>CONFIG</u>	I***	low	Pin can be used as a backup method for entering Command Mode during power-up. Primary method is with "+++". Refer to the Command Mode [p14] section for more information.
10	VCC	I	-	5 VDC regulated (± 0.25)
11	GND	-	-	Ground

* Module has 10K Ω internal pull-up resistor

** Module has 10K Ω internal pull-down resistor

*** Module has 100K Ω internal pull-up resistor

Note: When integrating the WCM802 / WCM900 Module with a Host PC Board, all lines that are not used should be left disconnected (floating).

Table 1.3. J2 Pin Signal Descriptions

Module Pin	Signal Name
1	reserved
2	GND
3	GND
4	GND

J2 Pins are used primarily for mechanical stability and may be left disconnected.

Electrical Characteristics

Figure 1.2. System Block Diagram
Basic wireless link between hosts

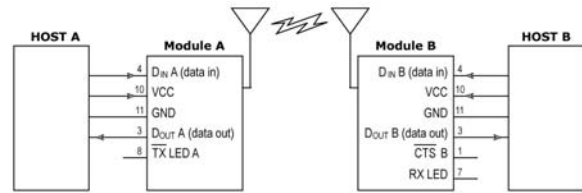

The data flow sequence is initiated when the first byte of data is received in the DI Buffer of the transmitting module (WCM802 / WCM900 Module A). As long as WCM802 / WCM900 Module A is not already receiving RF data, data in the DI Buffer is packetized, then transmitted over-the-air to WCM802 / WCM900 Module B.

Note: The WCM802 and the WCM900 modules are not compatible with each other and can not be used to communicate with one another.

Timing Specifications

Figure 1.3. Timing Specifications (“A” and “B” refer to Figure 1.2.)

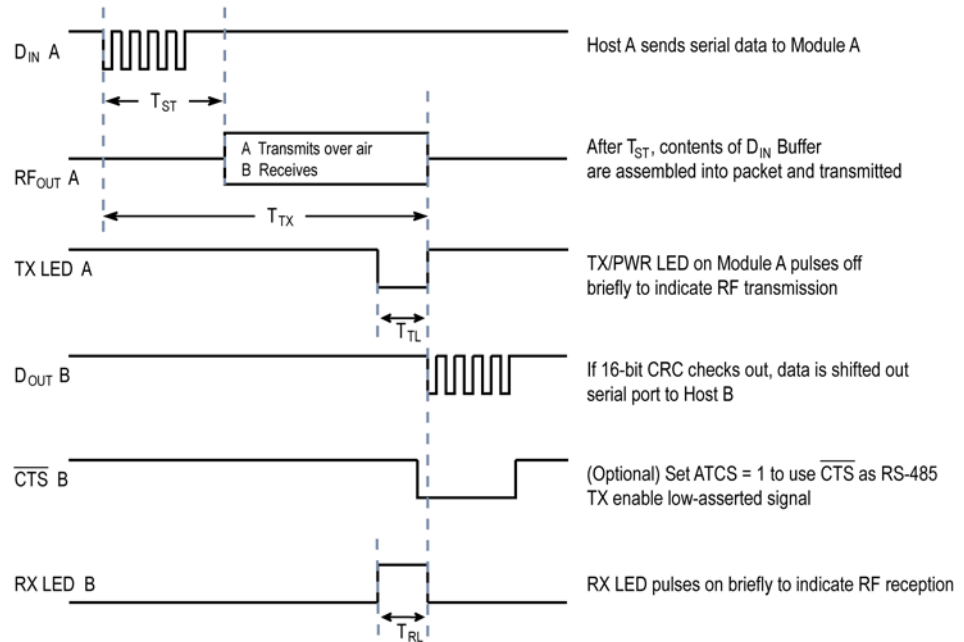

Table 1.4. AC Characteristics (SY parameter = 0, symbols correspond to Figure 1.2 and Figure 1.3.)

Symbol	Description	19200 baud rate (32 byte packet)	19200 timing (B=number of bytes)	9600 baud rate (32 byte packet)	9600 timing (B=number of bytes)
T_{TX}	Latency from the time data is transmitted until received	54.0 ms	For $0 < B < 64$, $T = 41.6 + (0.4 * B)$ ms For $B > 63$, $T = 66.8$ ms	72.0 ms	For $0 < B < 40$, $T = 46.27 + (0.73 * B)$ ms For $B \geq 39$ bytes, $T = 74.80$ ms
T_{TL}	Time that \overline{TX} /PWR pin is driven low	8.4 ms	For $0 < B < 14$, $T = 3.24 + (0.4 * B)$ ms For $B > 13$, $T = 8.48$ ms	16.8 ms	For $0 < B < 14$, $T = 6.50 + (0.8 * B)$ ms For $B > 13$, $T = 16.80$ ms
T_{RL}	Time that RX LED pin is driven high	13.6 ms	For $0 < B < 65$, $T = 0.79 + (0.408 * B)$ For $B > 64$, $T = 26.9$ ms	25.6 ms	For $0 < B < 37$, $T = 1.63 + (0.794 * B)$ For $B > 36$, $T = 30.2$ ms
T_{ST}	Channel Initialization Time	35.0 ms	35.0 ms	35.0 ms	35.0 ms

Table 1.5. DC Characteristics (V_{CC} = 4.75 – 5.25 VDC)

Symbol	Parameter	Condition	Min	Typical	Max	Units
V _{IL}	Input Low Voltage	All input signals	-0.5		0.3 * V _{CC}	V
V _{IH}	Input High Voltage	All except RESET pin	0.6 * V _{CC}		V _{CC} + 0.5	V
V _{IH2}	Input High Voltage	RESET pin *	0.9 * V _{CC}		V _{CC} + 0.5	V
V _{OL}	Output Low Voltage	I _{OL} = 20 mA, V _{CC} = 5V			0.7 0.5	V
V _{OH}	Output High Voltage	I _{OH} = -20 mA, V _{CC} = 5V	4.0 2.0			V
I _{IL}	Input Leakage Current I/O Pin	V _{CC} = 5.5V, pin low (absolute value)			3	μA
I _{IH}	Input Leakage Current I/O Pin	V _{CC} = 5.5V, pin high (absolute value)			3	μA
I _{IL2}		CTS , RESET , DO		(V _{CC} - V _I) / 10 **		mA
I _{IL3}		CONFIG		(V _{CC} - V _I) / 47 **		mA
I _{IH2}		RTS		(V _{CC} - V _I) / 10 **		mA

* Reset pulse must last at least 250 nanoseconds

** V_I = the input voltage on the pin

Mechanical Drawings

Figure 1.4. WCM802 / WCM900 Module Mechanical Drawings (shown with RPSMA antenna connector)

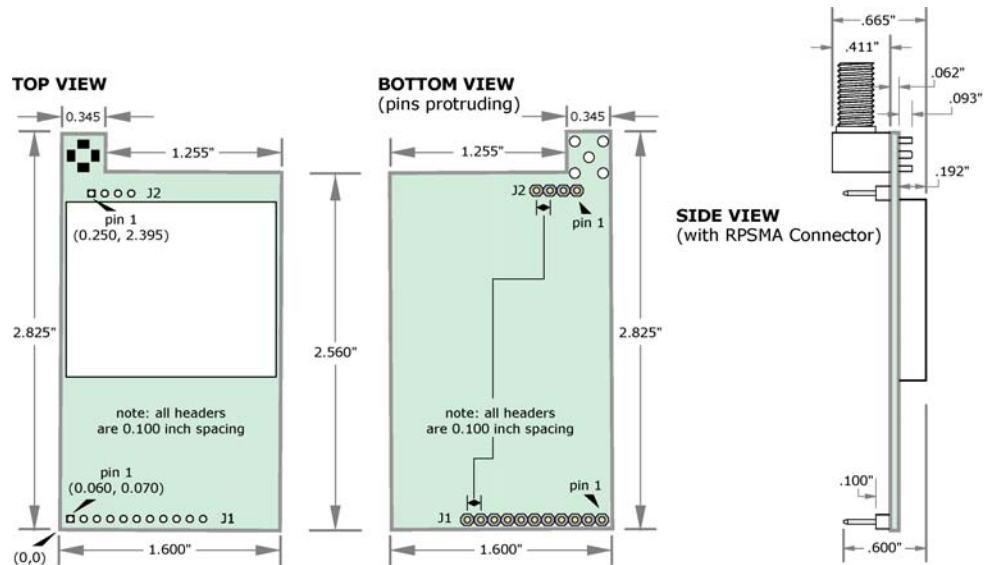

2. RF Operation

Serial Communications

The WCM802 / WCM900 OEM RF Module interfaces to a host device through a CMOS-level asynchronous serial port. Through its serial port, the module can communicate with any UART voltage compatible device or through a level translator to any RS-232/485/422 device.

UART-Interfaced Data Flow

Devices that have a UART interface can connect directly through the pins of the WCM802 / WCM900 Module as is shown in the figure below.

Figure 2.1. System Data Flow Diagram in a UART-interfaced environment

(Low-asserted signals distinguished with horizontal line over signal name.)

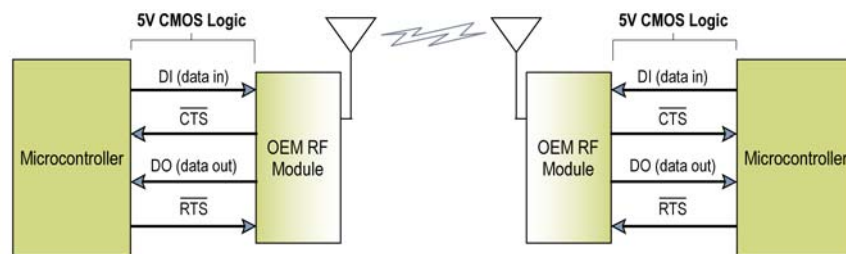

Serial Data

Data enters the prName Module through the DI pin (pin 4) as an asynchronous serial signal. The signal should idle high when no data is being transmitted.

The UART performs tasks, such as timing and parity checking, that are needed for data communications. Serial communication consists of two UARTs configured with compatible parameters (baud rate, parity, start bits, stop bits, data bits) to have successful communication. Each data packet consists of a start bit (low), 8 data bits (least significant bit first) and a stop bit (high). The following figure illustrates the serial bit pattern of data passing through the module.

Figure 2.2. UART data packet 0x1F (decimal number "31") as transmitted through the WCM802 / WCM900 Module

Example Data Format is 8-N-1 (bits – parity - # of stop bits)

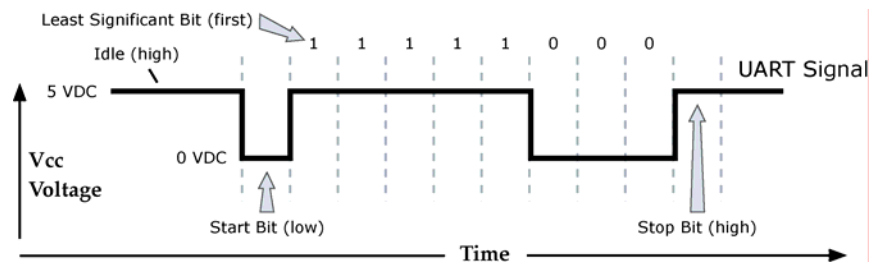

Flow Control

Figure 2.3. Internal Data Flow Diagram (The five most commonly-used pin signals shown.)

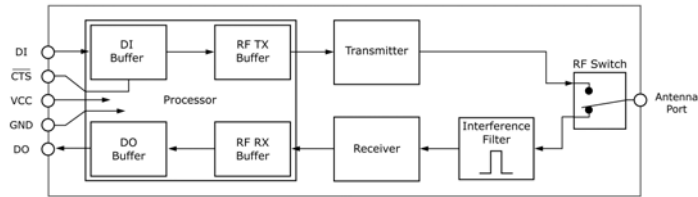

DI (Data In) Buffer and Flow Control

When serial data enters the WCM802 / WCM900 Module through the DI Pin, then the data is stored in the DI Buffer until it can be transmitted.

When the RO parameter threshold is satisfied (refer to Transmit Mode section [p11] and command descriptions [17] for more information), the module attempts to initialize an RF connection. If the module is already receiving RF data, the serial data is stored in the module's DI Buffer. If the DI buffer becomes full, hardware or software flow control must be implemented in order to prevent overflow (loss of data between the host and WCM802 / WCM900 OEM RF Module).

How to eliminate the need for flow control:

1. Send messages that are smaller than the DI buffer size. The size of the DI buffer varies according to the packet size and parity setting used.
2. Interface at a lower baud rate (BD parameter) than the fixed RF data rate.

Two cases in which the DI Buffer may become full and possibly overflow:

1. If the serial interface data rate is set higher than the RF data rate of the module, the module will receive data from the host faster than it can transmit the data over-the-air.
2. If the module is receiving a continuous stream of RF data or if the module is monitoring data on a network, any serial data that arrives on the DI pin (Pin 4) is placed in the DI Buffer. The data in the DI buffer will be transmitted over-the-air when the module no longer detects RF data in the network.

Hardware Flow Control ($\overline{\text{CTS}}$). When the DI buffer is 17 bytes away from being full; by default, the module de-asserts (high) $\overline{\text{CTS}}$ to signal to the host device to stop sending data [refer to FT (Flow Control Threshold) and CS (DO2 Configuration) Commands]. $\overline{\text{CTS}}$ is re-asserted after the DI Buffer has 34 bytes of memory available.

Software Flow Control (XON). XON/XOFF software flow control can be enabled using the FL (Software Flow Control) Command. This option only works with ASCII data.

DO (Data Out) Buffer and Flow Control

When RF data is received, the data enters the DO buffer and is then sent out the serial port to a host device. Once the DO Buffer reaches capacity, any additional incoming RF data is lost.

Two cases in which the DO Buffer may become full and possibly overflow:

1. If the RF data rate is set higher than the interface data rate of the module, the module will receive data from the transmitting module faster than it can send the data to the host.
2. If the host does not allow the module to transmit data out from the DO buffer because of being held off by hardware or software flow control.

Hardware Flow Control ($\overline{\text{RTS}}$). If $\overline{\text{RTS}}$ is enabled for flow control (RT Parameter = 2), data will not be sent out the DO Buffer as long as $\overline{\text{RTS}}$ (pin 5) is de-asserted.

Software Flow Control (XOFF). XON/XOFF software flow control can be enabled using the FL (Software Flow Control) Command. This option only works with ASCII data.

Modes of Operation

WCM802 / WCM900 OEM RF Modules operate in five modes.

Figure 2.4. WCM802 / WCM900 Modes of Operation:

The module can only be in one mode at a time.

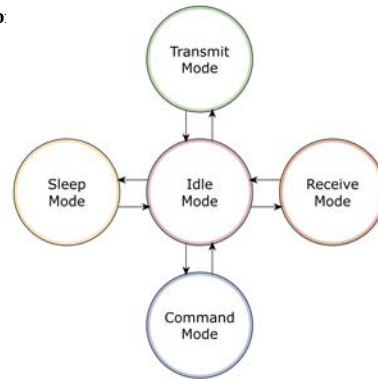

Idle Mode

When not receiving or transmitting data, the module is in Idle Mode. The module uses the same amount of power in Idle Mode as it does in Receive Mode.

The module shifts into the other modes of operation under the following conditions:

- Serial data is received in the DI Buffer (Transmit Mode)
- Valid RF data is received through the antenna (Receive Mode)
- Command Mode Sequence is issued (Command Mode)
- Sleep Mode condition is met (Sleep Mode)

After responding to any of the preceding conditions, the module automatically transitions back into Idle Mode.

Transmit Mode

When the first byte of serial data is received from the UART in the DI buffer, the module attempts to shift to Transmit Mode and initiate an RF connection with other modules.

Figure 2.5. Transmission of Data →

Once in Transmit Mode, the module initializes a communications channel. Channel initialization is the process of sending an RF initializer that synchronizes receiving modules with the transmitting module. When streaming multiple RF packets, the RF Initializer is only sent in front of the first packet. During channel initialization, incoming serial data accumulates in the DI buffer.

After the channel is initialized, data in the DI buffer is grouped into packets (up to 64 bytes in each packet) and is transmitted. The module continues to transmit data packets until the DI buffer is empty. Once transmission is finished, the module returns to Idle Mode. This progression is shown in Figure 2.5.

As the transmitting module nears the end of the transmission, it inspects the DI buffer to see if more data exists to be transmitted. This could be the case if more bytes arrived from the host after the transmission began. If more data is pending, the transmitting module assembles a subsequent packet for transmission.

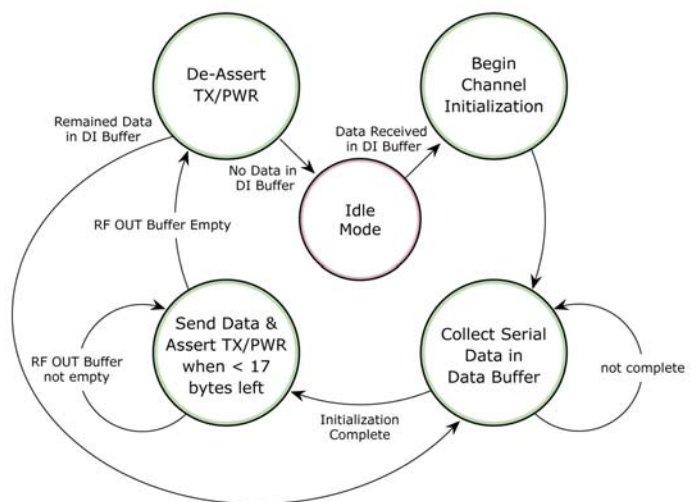

RF Packet

Figure 2.6. RF Packet Components

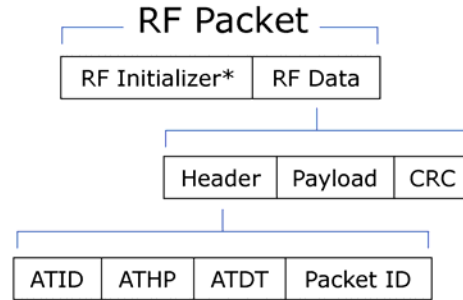

* When streaming multiple RF packets, the RF Initializer is only sent in front of the first packet.

RF Initializer

An RF initializer is sent each time a new connection sequence begins. The RF initializer contains channel information that notifies receiving modules of information such as the hopping pattern used by the transmitting module. The first transmission always sends an RF initializer.

An RF initializer can be of various lengths depending on the amount of time determined to be required to prepare a receiving module. For example, a wake-up initializer is a type of RF initializer used to wake remote modules from Sleep Mode (Refer to the FH, LH, HT and SM Commands for more information). The length of the wake-up initializer should be longer than the length of time remote modules are in cyclic sleep.

Header

The header contains network addressing information that filters incoming RF data. The receiving module checks for matching a VID, Hopping Channel and Destination Address. Data that does not pass through all three network filter layers is discarded.

Figure 2.7. Network Layers Contained in the Header

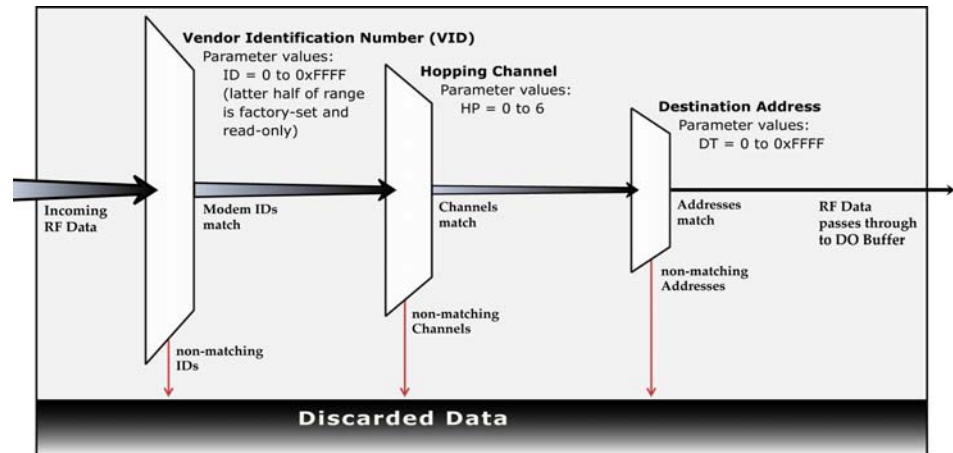

CRC (Cyclic Redundancy Check)

To verify data integrity and provide built-in error checking, a 16-bit CRC (Cyclic Redundancy Check) is computed for the transmitted data and attached to the end of each RF packet. On the receiving end, the receiving module computes the CRC on all incoming RF data. Received data that has an invalid CRC is discarded [See Receive Mode section, next page].

Receive Mode

If a module detects RF data while operating in Idle Mode, the module transitions into Receive Mode to start receiving RF packets.

Figure 2.8. Reception of RF Data →

After a packet is received, the module checks the CRC (cyclic redundancy check) to ensure that the data was transmitted without error. If the CRC data bits on the incoming packet are invalid, the packet is discarded. If the CRC is valid, the packet proceeds to the DO Buffer.

The module returns to Idle Mode after valid RF data is no longer detected or after an error is detected in the received RF data. If serial data is stored in the DI buffer while the module is in Receive Mode, the serial data will be transmitted after the module is finished receiving data and returns to Idle Mode.

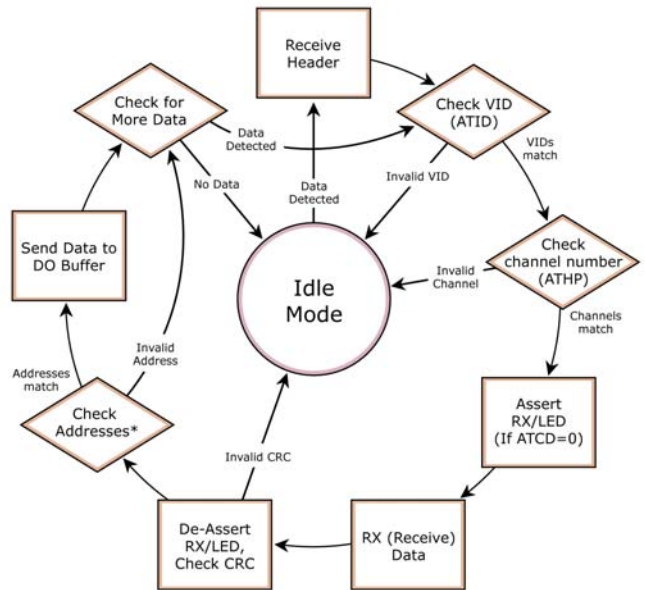

Sleep Mode

Sleep Modes enable the WCM802 / WCM900 Module to operate at minimal power consumption when not in use. Three Sleep Mode options are available:

- **Pin Sleep** (Host Controlled)
- **Serial Port Sleep** (Wake on Serial Port activity)
- **Cyclic Sleep** (Wake on RF activity)

For the module to transition into Sleep Mode, the module must have a non-zero SM (Sleep Mode) Parameter and one of the following must occur:

1. The module is idle (no data transmission or reception) for a user-defined period of time [See ST (Time before Sleep) Command].
2. SLEEP (pin 2) is asserted (only for Pin Sleep option).

In Sleep Mode, the module will not transmit or receive data until the module first transitions to Idle Mode. All Sleep Modes are enabled and disabled using SM Command. Transitions into and out of Sleep Modes are triggered by various events as shown in the table below.

Table 2.1. Summary of Sleep Mode Configurations

Sleep Mode Setting	Transition into Sleep Mode	Transition out of Sleep Mode	Related Commands	Typical Power Consumption
Pin Sleep (SM = 1)	Microcontroller can shut down and wake modules by asserting (high) SLEEP (pin 2). Note: The module will complete a transmission or reception even if Pin Sleep is activated.	De-assert (low) SLEEP (pin 2).	SM	26 µA
Serial Port Sleep (SM = 2)	Automatic transition to Sleep Mode occurs after a user-defined period of inactivity (no transmitting or receiving of data). The period of activity is defined using the ST (Time before Sleep) Command.	When serial byte is received on the DI pin (pin 4).	SM, ST	1 mA
Cyclic Sleep (SM = 3-8)	Automatic transition to Sleep Mode occurs in cycles as defined by the SM (Sleep Mode) Command. Note: The cyclic sleep time interval must be shorter than the "Wake-up Initializer Timer" (set by LH Command).	After the cyclic sleep time interval elapses. Note: Module can be forced into Idle Mode if PW (Pin Wake-up) Command is issued.	SM, ST, HT, LH, PW	76 µA when sleeping

For more information about Sleep Modes, refer to the individual commands listed in "Related Commands" column of the table. SM Command is the best starting point for implementing Sleep Mode configurations.

Command Mode

To modify or read module parameters, the module must first enter into Command Mode, the state in which incoming characters are interpreted as commands. Two command types are available for programming the module:

- AT Commands
- Binary Commands

For modified parameter values to persist in the module registry, changes must be saved to non-volatile memory using WR (Write) Command. Otherwise, parameters are restored to previously saved values after the module is powered off and then on again.

AT Commands

To Enter AT Command Mode:

1. Send the 3-character command sequence “+++” and observe guard times before and after the command characters. [See “Default AT Command Mode Sequence” below.] The “Terminal” tab (or other serial communications software) of the RADIOSET Software can be used to enter the sequence.
[OR]
2. Assert (low) the **CONFIG** pin and either turn the power going to the module off and back on.

Default AT Command Mode Sequence (for transition to Command Mode):

- No characters sent for one second [see BT (Guard Time Before) Command]
- Input three plus characters (“+++”) within one second [see CC (Command Sequence Character) Command.]
- No characters sent for one second [see AT (Guard Time After) Command.]

To Send AT Commands:

Send AT commands and parameters using the syntax shown below:

Figure 2.9. Syntax for sending AT Commands

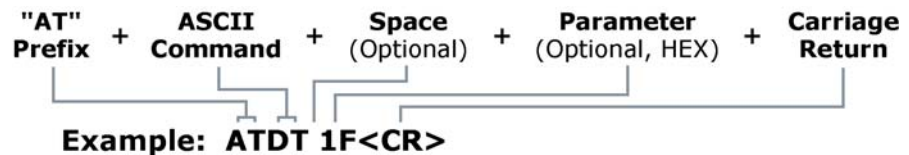

NOTE: To read a parameter value stored in a register, leave the parameter field blank.

The preceding example would change the module Destination Address to “1F”. To store the new value to non-volatile (long term) memory, subsequently send the Write (ATWR) Command.

System Response. When a command is sent to the module, the module will parse and execute the command. Upon successful execution of a command, the module returns an “OK” message. If execution of a command results in an error, the module returns an “ERROR” message.

To Exit AT Command Mode:

1. Send ATCN (Exit Command Mode) Command.
[OR]
2. If no valid AT Commands are received within the time specified by CT (Command Mode Timeout) Command, the Module automatically returns to Idle Mode.

For an example that illustrates programming the module using AT Commands, refer to the “Advanced Programming” chapter.

Binary Commands

Sending and receiving register values using binary commands is the fastest way to change the operating parameters of the module. Binary commands are used most often to sample the signal strength (RS command) and/or error counts or change module address and channels for polling systems when a quick response is necessary. Since the sending and receiving register values takes place through the same serial data path as 'live' data (received RF payload), interference between the two can be a concern.

Common questions about using binary command mode:

- What are the implications of asserting CMD in any of the various states while live data is being sent or received?
- Specifically, is there a minimum time delay after serial data is sent before which we can assert CMD and send a command?
- Is a delay required after CMD is de-asserted before we can send normal data?
- How can we know if data being received is the response from a command or live data?

Answers: The CMD line can be asserted to send a command to the radio anytime during transmission or reception of data. Note that the status of the CMD signal is only checked at the end of the stop bit as the byte is shifted into the serial port. If the command is sent in the middle of a stream of payload data to be transmitted, the command will essentially be executed in the order it is received. If the radio is continuously receiving data, the radio will wait for a break in the received data before executing the command. The \overline{CTS} signal will frame the response coming from the binary command request (see graphic below).

CMD (pin 5) must be asserted in order to send binary commands to an WCM802 / WCM900 Module. CMD can be asserted to recognize commands anytime during transmission or reception of data. A minimum time delay of 100 μ s (after the stop bit of the command byte has been sent) must be observed before pin 5 can be de-asserted. The command executes after all parameters associated with the command have been sent. If all parameters are not received within 0.5 seconds, the module aborts the command and returns to Idle Mode. Note: When parameters are sent, they are always two bytes long with the least significant byte sent first.

Commands can be queried for their current value by sending the command logically ORed with the value 0x80 (hexadecimal) with CMD asserted. When the binary value is sent (with no parameters), the current value of the command parameter is sent back through the DO pin.

Figure 2.10. Binary Command Write then Read

- Signal #4 is CMD (pin 5)
- Signal #1 is the DIN (pin 4) signal to the radio
- Signal #2 is the DOUT (pin 3) signal from the radio
- Signal #3 is \overline{CTS} (pin 1)

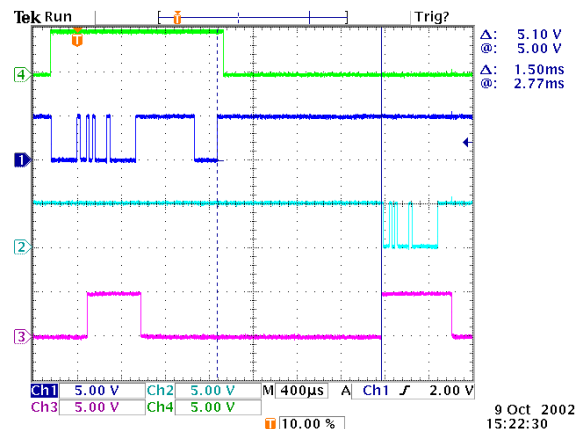

A value was written to a register and then read out to verify it. While not in the middle of other received data, note that the \overline{CTS} signal outlines the data response out of the module.

IMPORTANT: For the WCM802 / WCM900 Module to recognize a binary command, RT (DI2 Configuration) Command must be issued. If binary programming is not enabled (RT \neq 1), the module will not recognize that the CMD pin (Pin 5) is asserted and therefore will not recognize the data as binary commands.

3. Advanced Programming

Programming the Module

For information about entering and exiting AT and Binary Command Modes, refer to the Command Mode section [p14].

AT Command Example

To Send AT Commands (Using the Terminal tab of the RadioSet Software)

Example: Both of the following examples change the module's destination address to 0x1A0D and save the new address to non-volatile memory. <CR> stands for "Carriage Return".

Method 1 (One line per command)

Send AT Command

```
+++
ATDT <Enter>
ATDT1A0D <Enter>
ATWR <Enter>
ATCN <Enter>
```

System Response

```
OK <CR> (Enter into Command Mode)
0 <CR> (Read current destination address)
OK <CR> (Change destination address)
OK <CR> (Write to non-volatile memory)
OK <CR> (Exit Command Mode)
```

Method 2 (Multiple commands on one line)

Send AT Command

```
+++
ATDT <Enter>
ATDT1A0D,WR,CN <Enter>
```

System Response

```
OK <CR> (Enter into Command Mode)
0 <CR> (Read current destination address)
OK <CR> (Execute commands)
```

Horner provides RADIOSET Software for programming the module using AT Commands.

To install, double-click the "RADIOSET.exe" file, then follow the prompts of the installation screens.

Note: In order to use a host PC and the RADIOSET Software Terminal tab to send data to the module, the PC com port settings must match the following module parameter values: baud, parity & stop bits.

Use the "PC Settings" tab to configure PC com port settings to match module parameter values. [Refer to BD (Baud Rate) and NB (Parity) Commands for module parameter values.]

Binary Command Example

To Send Binary Commands:

Example: Use binary commands to change the WCM802 / WCM900 Module's destination address to 0x1A0D and save the new address to non-volatile memory.

1. RT Command must be set to "1" in AT Command Mode to enable binary programming.
2. Assert CMD (Pin 5 is driven high). (Enter Binary Command Mode)
3. Send Bytes: 00 (Send DT (Destination Address) Command)
0D (Least significant byte of parameter bytes)
1A (Most significant byte of parameter bytes)
08 (Send WR (Write) Command)
4. De-assert CMD (Pin 5 is driven low) (Exit Binary Command Mode)

Note: $\overline{\text{CTS}}$ (pin 1) is de-asserted high when commands are being executed. Hardware flow control must be disabled as $\overline{\text{CTS}}$ will hold off parameter bytes.

Command Descriptions (Short)

Table 3.1. WCM802 / WCM900 Commands

(The WCM802 / WCM900 Module expects numerical values in hexadecimal. "d" denotes decimal equivalent.)

AT Command	Binary Command	AT Command Name	Range	Command Category	# Bytes Returned	Factory Default
AT	0x05 (5d)	Guard Time After	0x02 – 0xFFFF [x 100 msec]	Command Mode Options	2	0x0A (10d)
BD	0x15 (21d)	Baud Rate	0 – 6	Serial Interfacing	1	RF data rate
BT	0x04 (4d)	Guard Time Before	0 – 0xFFFF [x 100 msec]	Command Mode Options	2	0x0A (10d)
CC	0x13 (19d)	Command Sequence Character	0x20 – 0x7F	Command Mode Options	1	0x2B ("+")
CD v 4.2B*	0x28 (40d)	DO3 Configuration	0 - 3	Serial Interfacing	1	0
CN	0x09 (9d)	Exit AT Command Mode	-	Command Mode Options	-	-
CS v 4.27D*	0x1F (31d)	DO2 Configuration	0 – 4	Serial Interfacing	1	0
CT	0x06 (6d)	Command Mode Timeout	0x02 – 0xFFFF [x 100 msec]	Command Mode Options	2	0xC8 (200d)
DT	0x00 (0d)	Destination Address	0 – 0xFFFF	Networking	2	0
E0	0x0A (10d)	Echo Off	-	Command Mode Options	-	-
E1	0x0B (11d)	Echo On	-	Command Mode Options	-	-
ER	0x0F (15d)	Receive Error Count	0 – 0xFFFF	Diagnostics	2	0
FH	0x0D (13d)	Force Wake-up Initializer	-	Sleep (Low Power)	-	-
FL	0x07 (7d)	Software Flow Control	0 – 1	Serial Interfacing	1	0
FT v 4.27B*	0x24 (36d)	Flow Control Threshold	0 – 0xFF [bytes]	Serial Interfacing	2	varies
GD	0x10 (16d)	Receive Good Count	0 – 0xFFFF	Diagnostics	2	0
HP	0x11 (17d)	Hopping Channel	0 – 6	Networking	1	0
HT	0x03 (3d)	Time before Wake-up Initializer	0 – 0xFFFF [x 100 msec]	Sleep (Low Power)	2	0xFFFF
ID v 4.2B*	0x27 (39d)	Module VID	User settable: 0x10 - 0x7FFF Read-only: 0x8000 – 0xFFFF	Networking	2	-
LH	0x0C (12d)	Wake-up Initializer Timer	0 – 0xFF [x 100 msec]	Sleep (Low Power)	1	1
MK	0x12 (18d)	Address Mask	0 – 0xFFFF	Networking	2	0xFFFF
NB v 4.27B*	0x23 (35d)	Parity	0 – 4	Serial Interfacing	1	0
PC v 4.22*	0x1E (30d)	Power-up Mode	0 – 1	Command Mode Options	1	0
PW v 4.22*	0x1D (29d)	Pin Wake-up	0 – 1	Sleep (Low Power)	1	0
RE	0x0E (14d)	Restore Defaults	-	(Special)	-	-
RN v 4.22*	0x19 (25d)	Delay Slots	0 – 0xFF [slots]	Networking	1	0
RO v 4.2AA*	0x21 (33d)	Packetization Timeout	0 – 0xFFFF [x 200 µsec]	Serial Interfacing	2	0
RP v 4.2AA*	0x22 (34d)	RSSI PWM Timer	0 - 0x7F [x 100 msec]	Diagnostics	1	0
RR v 4.22*	0x18 (24d)	Retries	0 – 0xFF	Networking	1	0
RS v 4.22*	0x1C (28d)	RSSI	0x06 – 0x36 [Read-only]	Diagnostics	1	-
RT	0x16 (22d)	DI2 Configuration	0 - 2	Serial Interfacing	1	0
SV v 4.2B*	0x36 (54d)	Stop Bits	0 - 1	Serial Interfacing	1	0
SH v 4.27C*	0x25 (37d)	Serial Number High	0 – 0xFFFF [Read-only]	Diagnostics	2	-
SL v 4.27C*	0x26 (38d)	Serial Number Low	0 – 0xFFFF [Read-only]	Diagnostics	2	-
SM	0x01 (1d)	Sleep Mode	0 – 8	Sleep (Low Power)	1	0
ST	0x02 (2d)	Time before Sleep	0x10 – 0xFFFF [x 100 msec]	Sleep (Low Power)	2	0x64 (100d)
SY	0x17 (23d)	Time before Initialization	0 – 0xFF [x 100 msec]	Networking	1	0 (disabled)
TR v 4.22*	0x1B (27d)	Transmit Error Count	0 – 0xFFFF	Diagnostics	2	0
TT v 4.22*	0x1A (26d)	Streaming Limit	0 – 0xFFFF [0 = disabled]	Networking	2	0xFFFF
VR	0x14 (20d)	Firmware Version	0 x 0xFFFF [Read-only]	Diagnostics	2	-
WR	0x08 (8d)	Write	-	(Special)	-	-

* Firmware version in which command and parameter options were first supported.

Command Descriptions (Long)

Commands in this section are listed alphabetically. Command categories are designated between the "< >" symbols that follow each command title. WCM802 / WCM900 Modules expect numerical values in hexadecimal and those values are designated by a "0x" prefix.

AT (Guard Time After) Command

<Command Mode Options> AT Command is used to set the time-of-silence that follows the command sequence character (CC Command). By default, AT Command Mode will activate after one second of silence.

The AT Command Mode Sequence used to enter AT Command Mode is as follows:

- No characters sent for 1 second [BT (Guard Time Before) Command]
- Send three plus characters "+++" [CC (Command Sequence Character) Command]
- No characters sent for 1 second [AT (Guard Time After) Command]

All of the values in this sequence can be adjusted. AT Command is used to adjust the period of silence that follows the command sequence character.

AT Command: ATAT

Binary Command: 0x05 (5 decimal)

Parameter Range: 0x02 – 0xFFFF
[x 100 milliseconds]

Number of bytes returned: 2

Default Parameter Value: 0x0A (10 decimal)

Related Commands: BT (Guard Time Before), CC (Command Sequence Character)

BD (Baud Rate) Command

<Serial Interfacing> BD Command allows the user to adjust the UART I/O serial data rate and thus modify the rate at which serial data is sent to the module. The new baud rate does not take effect until the CN (Exit AT Command Mode) Command is issued. The RF data rate is not affected by the BD Command.

Note: If the serial data rate is set to exceed the fixed RF data rate of the WCM802 / WCM900 module, $\overline{\text{CTS}}$ flow control may need to be implemented as described in the Pin Signals and Flow Control sections of this manual.

AT Command: ATBD

Binary Command: 0x15 (21 decimal)

Parameter Range: 0 – 6

Parameter Value	BAUD (bps) Configuration
0	1200
1	2400
2	4800
3	9600
4	19200
5	38400
6	57600

Number of bytes returned: 1

Default Parameter Value: Equal to module's fixed RF data rate.

BT (Guard Time Before) Command

<Command Mode Options> BT Command is used to set the DI pin silence time that must precede the command sequence character (CC Command) of the AT Command Mode Sequence.

The default sequence used to enter AT Command Mode is as follows:

- No characters sent for 1 second [BT (Guard Time Before) Command]
- Send three plus characters "+++" [CC (Command Sequence Character) Command]
- No characters sent for 1 second [AT (Guard Time After) Command]

All of the values in this sequence can be adjusted.

AT Command: ATBT

Binary Command: 0x04 (4 decimal)

Parameter Range: 0 – 0xFFFF
[x 100 milliseconds]

Default Parameter Value: 0x0A (10 decimal)

Number of bytes returned: 2

Related Commands: AT (Guard Time After), CC (Command Sequence Character)

CC (Command Sequence Character) Command

<Command Mode Options> CC Command is used to set the ASCII character to be used between Guard Times of the AT Command Mode Sequence (BT+ CC + AT). The AT Command Mode Sequence activates AT Command Mode (from Idle Mode). The default sequence used to enter AT Command Mode is as follows:

- No characters sent for 1 second [BT (Guard Time Before) Command]
- Send three plus characters “+++” [CC (Command Sequence Character) Command]
- No characters sent for 1 second [AT (Guard Time After) Command]

All of the values in this sequence can be adjusted. CC Command is used to change the command sequence character.

AT Command: ATCC
Binary Command: 0x13 (19 decimal)
Parameter Range: 0x20 – 0x7F
Default Parameter Value: 0x2B (ASCII “+” sign)
Number of bytes returned: 1
Related Commands: AT (Guard Time After), BT (Guard Time Before)

CD (DO3 Configuration) Command

<Command Mode Options> CD Command is used to redefine the behavior of the DO3/RX LED line.

AT Command: ATCD										
Binary Command: 0x28 (40 decimal)										
Parameter Range: 0 – 3										
<table border="1"> <thead> <tr> <th>Parameter Value</th> <th>Configuration</th> </tr> </thead> <tbody> <tr> <td>0</td> <td>RX LED</td> </tr> <tr> <td>1</td> <td>Default high</td> </tr> <tr> <td>2</td> <td>Default low</td> </tr> <tr> <td>3</td> <td>Assert only when packet addressed to module sent</td> </tr> </tbody> </table>	Parameter Value	Configuration	0	RX LED	1	Default high	2	Default low	3	Assert only when packet addressed to module sent
Parameter Value	Configuration									
0	RX LED									
1	Default high									
2	Default low									
3	Assert only when packet addressed to module sent									
Default Parameter Value: 0										
Number of bytes returned: 1										
Minimum Firmware Version Required: 4.2B										

CN (Exit AT Command Mode) Command

<Command Mode Options> CN Command is used to explicitly exit AT Command Mode.

AT Command: ATCN
Binary Command: 0x09 (9 decimal)

CS (DO2 Configuration) Command

<Serial Interfacing> CS Command is used to select the behavior of the DO2 pin signal. This output can provide RS-232 flow control, control the TX enable signal (for RS-485 or RS-422 operations), or set the default level for the I/O line passing function.

By default, DO2 provides RS-232 $\overline{\text{CTS}}$ (Clear-to-Send) flow control.

AT Command: ATCS												
Binary Command: 0x1F (31 decimal)												
Parameter Range: 0 – 4												
<table border="1"> <thead> <tr> <th>Parameter Value</th> <th>Configuration</th> </tr> </thead> <tbody> <tr> <td>0</td> <td>RS-232 $\overline{\text{CTS}}$ flow control</td> </tr> <tr> <td>1</td> <td>RS-485 TX enable low</td> </tr> <tr> <td>2</td> <td>high</td> </tr> <tr> <td>3</td> <td>RS-485 TX enable high</td> </tr> <tr> <td>4</td> <td>low</td> </tr> </tbody> </table>	Parameter Value	Configuration	0	RS-232 $\overline{\text{CTS}}$ flow control	1	RS-485 TX enable low	2	high	3	RS-485 TX enable high	4	low
Parameter Value	Configuration											
0	RS-232 $\overline{\text{CTS}}$ flow control											
1	RS-485 TX enable low											
2	high											
3	RS-485 TX enable high											
4	low											
Default Parameter Value: 0												
Number of bytes returned: 1												
Related Commands: RT (DI2 Configuration), TO (DO2 Timeout)												
Minimum Firmware Version Required: 4.27D												

CT (Command Mode Timeout) Command

<Command Mode Options> CT Command sets the amount of time before AT Command Mode terminates automatically. After a CT time of inactivity, the module exits AT Command Mode and returns to Idle Mode. AT Command Mode can also be exited manually using CN (Exit AT Command Mode) Command.

AT Command: ATCT

Binary Command: 0x06 (6 decimal)

Parameter Range: 0x02 – 0xFFFF
[x 100 milliseconds]

Default Parameter Value: 0xC8 (200 decimal, 20 seconds)

Number of bytes returned: 2

DT (Destination Address) Command

<Networking> DT Command is used to set the networking address of an WCM802 / WCM900 Module. WCM802 / WCM900 Modules uses three network layers –Vendor Identification Number (ATID), Channels (ATHP), and Destination Addresses (ATDT). DT Command assigns an address to a module that enables it to communicate only with other modules having the same addresses. All modules that share the same Destination Address can communicate freely with each other. Modules in the same network with a different Destination Address (than that of the transmitter) will listen to all transmissions to stay synchronized, but will not send any of the data out their serial ports.

AT Command: ATDT

Binary Command: 0x00

Parameter Range: 0 – 0xFFFF

Default Parameter Value: 0

Number of bytes returned: 2

Related Commands: HP (Hopping Channel), ID (Module VID), MK (Address Mask)

E0 (Echo Off) Command

<Command Mode Options> E0 Command turns off character echo in AT Command Mode. By default, echo is off.

AT Command: ATE0

Binary Command: 0x0A (10 decimal)

E1 (Echo On) Command

<Command Mode Options> E1 Command turns on the echo in AT Command Mode. Each typed character will be echoed back to the terminal when ATE1 is active. E0 is the default.

AT Command: ATE1

Binary Command: 0x0B (11 decimal)

ER (Receive Error Count) Command

<Diagnostics> Set/Read the receive-error. The error-count records the number of packets partially received then aborted on a reception error. This value returns to 0 after a reset and is not non-volatile (Value does not persist in the module's memory after a power-up sequence). Once the "Receive Error Count" reaches its maximum value (up to 0xFFFF), it remains at its maximum count value until the maximum count value is explicitly changed or the module is reset.

AT Command: ATER

Binary Command: 0x0F (15 decimal)

Parameter Range: 0 – 0xFFFF

Default Parameter Value: 0

Number of bytes returned: 2

Related Commands: GD (Receive Good Count)

FH (Force Wake-up Initializer) Command

<Sleep (Low Power)> FH Command is used to force a Wake-up Initializer to be sent on the next transmit. WR (Write) Command does not need to be issued with FH Command.

AT Command: ATFH

Binary Command: 0x0D (13 decimal)

Use only with cyclic sleep modes active on remote modules.

FL (Software Flow Control) Command

<Serial Interfacing> FL Command is used to configure software flow control. Hardware flow control is implemented with the WCM802 / WCM900 Module as the DO2 pin ($\overline{\text{CTS}}$), which regulates when serial data can be transferred to the module. FL Command can be used to allow software flow control to also be enabled. XON character used is 0x11 (17 decimal). XOFF character used is 0x13 (19 decimal).

AT Command: ATFL

Binary Command: 0x07 (7 decimal)

Parameter Range: 0 - 1

Parameter Value	Configuration
0	Disable software flow control
1	Enable software flow control

Default Parameter Value: 0

Number of bytes returned: 1

FT (Flow Control Threshold) Command

<Serial Interfacing> Set/Read the flow control threshold. When FT bytes have accumulated in the DI buffer, $\overline{\text{CTS}}$ is de-asserted or the XOFF software flow control character is transmitted.

AT Command: ATFT

Binary Command: 0x24 (36 decimal)

Parameter Range: 0 - (Receiving module DO buffer size minus 0x11 bytes)

Default Parameter Value: Receiving module DO Buffer size minus 0x11

Number of bytes returned: 2

Minimum Firmware Version Required: 4.27B

GD (Receive Good Count) Command

<Diagnostics> Set/Read the count of good received RF packets. Parameter value is reset to 0 after every reset and is not non-volatile (Value does not persist in the module's memory after a power-up sequence). Once the "Receive Good Count" reaches its maximum value (up to 0xFFFF), it remains at its maximum count value until the maximum count value is manually changed or the module is reset.

AT Command: ATGD

Binary Command: 0x10 (16 decimal)

Parameter Range: 0 - 0xFFFF

Default Parameter Value: 0

Number of bytes returned: 2

Related Commands: ER (Receive Error Count)

HP (Hopping Channel) Command

<Networking> HP Command is used to set the module's hopping channel number. A channel is one of three layers of addressing available to the WCM802 / WCM900 module. In order for modules to communicate with each other, the modules must have the same channel number since each network uses a different hopping sequence. Different channels can be used to prevent modules in one network from listening to transmissions of another.

AT Command: ATHP

Binary Command: 0x11 (17 decimal)

Parameter Range: 0 - 6

Default Parameter Value: 0

Number of bytes returned: 1

Related Commands: DT (Destination Address), ID (Module VID), MK (Address Mask)

HT (Time before Wake-up Initializer) Command

<Sleep (Low Power)> If any modules within range are running in a “Cyclic Sleep” setting, a wake-up initializer must be used by the transmitting module for sleeping modules to remain awake [refer to the LH (“Wake-up Initializer Timer”) Command]. When a receiving module in Cyclic Sleep wakes, it must detect the wake-up initializer in order to remain awake and receive data. The value of HT Parameter tells the transmitter, “After a period of inactivity (no transmitting or receiving) lasting HT amount of time, send a long wake-up initializer”. HT Parameter should be set to match the inactivity timeout [specified by ST (Time before Sleep) Command] used by the receiver(s).

From the receiving module perspective, after HT time elapses and the inactivity timeout [ST Command] is met, the receiver goes into cyclic sleep. In cyclic sleep, the receiver wakes once per sleep interval to check for a wake-up initializer. When a wake-up initializer is detected, the module will stay awake to receive data. The wake-up initializer must be longer than the cyclic sleep interval to ensure that sleeping modules detect incoming data. When HT time elapses, the transmitter then knows that it needs to send a long Wake-up Initializer for all receivers to be able to remain awake and receive the next transmission. Matching HT to the time specified by ST on the receiving module guarantees that all receivers will detect the next transmission.

 AT Command: ATHT

 Binary Command: 0x03 (3 decimal)

 Parameter Range: 0 – 0xFFFF
 [x 100 milliseconds]

 Default Parameter Value: 0xFFFF (means that long wake-up initializer will not be sent)

 Number of bytes returned: 2

 Related Commands: LH (Wake-up Initializer Timer), SM (Sleep Mode), ST (Time before Sleep)

ID (Module VID) Command

<Networking> Read the module’s VID. VID is a Horner-specific acronym that stands for “Vendor Identification Number”. This number is factory-set and allows modules with matching VIDs to communicate. Modules with non-matching VIDs will not receive unintended data transmission.

 AT Command: ATID

 Binary Command: 0x27 (39 decimal)

 Parameter Range (user-settable):
 0x10 – 0x7FFFF
 (Factory-set and read-only): 0x8000 – 0xFFFF

 Number of bytes returned: 2

 Minimum Firmware Version Required: 4.2B
 (Previous versions did not support user-settable VIDs)

LH (Wake-up Initializer Timer) Command

<Sleep (Low Power)> LH Command adjusts the duration of time for which the RF initializer is sent. When receiving modules are put into Cyclic Sleep Mode, they power-down after a period of inactivity [specified by ST (Time before Sleep) Command] and will periodically awaken and listen for transmitted data. In order for the receiving modules to remain awake, they must detect ~35ms of the wake-up initializer.

LH Command must be used whenever a receiver is operating in Cyclic Sleep Mode. This lengthens the Wake-up Initializer to a specific amount of time (in tenths of a second). The Wake-up Initializer Time must be longer than the cyclic sleep time that is determined by SM (Sleep Mode) Command. If the wake-up initializer time were less than the Cyclic Sleep interval, the connection would be at risk of missing the wake-up initializer transmission.

Refer to Figures 4.3 & 4.4 of the SM Command description to view diagrams of correct and incorrect configurations. The images help visualize the importance that the value of LH be greater than the value of SM.

 AT Command: ATLH

 Binary Command: 0x0C (12 decimal)

 Parameter Range: 0 – 0xFF
 [x 100 milliseconds]

 Default Parameter Value: 1

 Number of bytes returned: 1

 Related Commands: HT (Time before Wake-up Initializer), SM (Sleep Mode), ST (Time before Sleep)

MK (Address Mask) Command

<Networking> MK Command is used to set/read the Address Mask.

All data packets contain the Destination Address of the transmitting module. When an RF data packet is received, the transmitter's Destination Address is logically "ANDed" (bitwise) with the Address Mask of the receiver. The resulting value must match the Destination Address or the Address Mask of the receiver for the packet to be received and sent out the module's DO serial port. If the "ANDed" value does not match either the Destination Address or the Address Mask of the receiver, the packet is discarded. (All "0" values are treated as "irrelevant" values and are ignored.)

AT Command: ATMK

Binary Command: 0x12 (18 decimal)

Parameter Range: 0 – 0xFFFF

Default Parameter Value: 0xFFFF
(Destination address (DT parameter) of the transmitting module must exactly match the destination address of the receiving module.)

Number of bytes returned: 2

Related Commands: DT (Destination Address), HP (Hopping Channel), ID (Module VID), MY (Source Address)

NB (Parity) Command

<Serial Interfacing> Select/Read parity settings for UART communications.

AT Command: ATNB

Binary Command: 0x23 (35 decimal)

Parameter Range: 0 – 4

Parameter Value	Configuration
0	8-bit (no parity or 7-bit (any parity))
1	8-bit even
2	8-bit odd
3	8-bit mark
4	8-bit space

Default Parameter Value: 0

Number of bytes returned: 1

Minimum Firmware Version Required: 4.27B

PC (Power-up to AT Mode) Command

<Command Mode Options> PC Command allows the module to power-up directly into AT Command Mode from reset or power-on. If PC Command is enabled with SM Parameter set to 1, DI3 (pin 2) can be used to enter the module into AT Command Mode. When the DI3 pin is de-asserted (low), the module will wake-up in AT Command Mode. This behavior allows module DTR emulation.

AT Command: ATPC

Binary Command: 0x1E (30 decimal)

Parameter Range: 0 – 1

Parameter Value	Configuration
0	Power-up to Idle Mode
1	Power-up to AT Command Mode

Default Parameter Value: 0

Number of bytes returned: 1

Minimum Firmware Version Required: 4.22

PW (Pin Wake-up) Command

<Sleep (Low Power)> Under normal operation, a module in Cyclic Sleep Mode cycles from an active state to a low-power state at regular intervals until data is ready to be received. If the PW Parameter is set to 1, SLEEP (pin 2) can be used to wake the module from Cyclic Sleep. If the SLEEP pin is de-asserted (low), the module will be fully operational and will not go into Cyclic Sleep. Once SLEEP is asserted, the module will remain active for the period of time specified by ST (Time before Sleep) Command, and will return to Cyclic Sleep Mode (if no data is ready to be transmitted). PW Command is only valid if Cyclic Sleep has been enabled.

AT Command: ATPW

Binary Command: 0x1D (29 decimal)

Parameter Range: 0 - 1

Parameter Value	Configuration
0	Disabled
1	Enabled

Default Parameter Value: 0

Number of bytes returned: 1

Related Commands: SM (Sleep Mode), ST (Time before Sleep)

Minimum Firmware Version Required: 4.22

RE (Restore Defaults) Command

<Diagnostics> RE Command restores all configurable parameters to factory default settings. However, RE Command will not write the default values to non-volatile (persistent) memory. Unless the WR (Write) Command is issued after the RE command, the default settings will not be saved in the event of module reset or power-down.

AT Command: ATRE

Binary Command: 0x0E (14 decimal)

RN (Delay Slots) Command

<Networking> RN Command is only applicable if retries have been enabled [RR (Retries) Command], or if forced delays will be inserted into a transmission [see TT (Streaming Limit) Command]. RN Command is used to adjust the time delay that the transmitter inserts before attempting to resend a packet. If the transmitter fails to receive an acknowledgement after sending a packet, it will insert a random number of delay slots (ranging from 0 to (RN minus 1)) before attempting to resend the packet. Each delay slot lasts for a period of 38ms.

AT Command: ATRN

Binary Command: 0x19 (25 decimal)

Parameter Range: 0 - 0xFF [slots]

Default Parameter Value: 0 (no delay slots inserted)

Number of bytes returned: 1

Related Commands: RR (Retries), TT (Streaming Limit)

Minimum Firmware Version Required: 4.22

If two modules attempted to transmit at the same time, the random time delay after packet failure would allow one of the two modules to transmit the packet successfully, while the other would wait until the channel opens up to begin transmission.

RO (Packetization Timeout) Command

<Serial Interfacing> RO Command is used to specify/read the time of silence (no bytes received) after which transmission begins. After a serial byte is received and if no other byte is received before the RO timeout, the transmission will start.

AT Command: ATRO

Binary Command: 0x21 (33 decimal)

Parameter Range: 0 - 0xFFFF [x 200 μs]

Default Parameter Value: 0

Number of bytes returned: 2

Minimum Firmware Version Required: 4.2AA

RP (RSSI PWM Timer) Command

<Diagnostics> RP Command is used to enable a PWM (“Pulse Width Modulation”) output on the Config pin which is calibrated to show the level the received RF signal is above the sensitivity level of the module. The PWM pulses vary from zero to 95 percent. Zero percent means the received RF signal is at or below the published sensitivity level of the module. The following table shows levels above sensitivity and PWM values.

The total period of the PWM output is 8.32 ms. There are 40 steps in the PWM output and therefore the minimum step size is 0.208 ms.

dBm above Sensitivity	PWM percentage (high period / total period)
10	47.5
20	62.5
30	77.5

A non-zero value defines the time that the PWM output will be active with the RSSI value of the last received RF packet. After the set time when no RF packets are received, the PWM output will be set low (0 percent PWM) until another RF packet is received. The PWM output will also be set low at power-up. A parameter value of 0xFF permanently enables the PWM output and it will always reflect the value of the last received RF packet.

PWM output shares the Config input pin. When the module is powered, the Config pin will be an input. During the power-up sequence, the Config pin will be read to determine whether the module is going into AT Command Mode. After this, if RP parameter is a non-zero value, the Config pin will be configured as an output and set low until the first RF packet is received. With a non-zero RP parameter, the Config pin will be an input for RP ms after power up.

- AT Command: ATRP

- Binary Command: 0x22 (34 decimal)

- Parameter Range: 0 – 0x7F
[x 100 milliseconds]

- Default Parameter Value: 0 (disabled)

- Number of bytes returned: 1

- Minimum Firmware Version Required: 4.2AA

RR (Retries) Command

Networking> RR Command specifies the number of retries that can be sent for a given RF packet. Once RR Command is enabled (set to a non-zero value), RF packet acknowledgements and retries are enabled. After transmitting a packet, the transmitter will wait to receive an acknowledgement from a receiver. If the acknowledgement is not received in the period of time specified by the RN (Delay Slots) Command, the transmitter will transmit the original packet again. The packet will be transmitted repeatedly until an acknowledgement is received or until the packet has been sent RR times.

Note: For retries to work correctly, all modules in the system must have retries enabled.

- AT Command: ATRR

- Binary Command: 0x18 (24 decimal)

- Parameter Range: 0 – 0xFF

- Default Parameter Value: 0 (disabled)

- Number of bytes returned: 1

- Minimum Firmware Version Required: 4.22

RS (RSSI) Command

<Diagnostics> RS Command returns the signal level of the last packet received. This reading is useful for determining range characteristics of the WCM802 / WCM900 Modules under various conditions of noise and distance.

Once the command is issued, the module will return a value between 0x6 and 0x36 where 0x36 represents a very strong signal level and 0x4 indicates a low signal level.

- AT Command: ATRS

- Binary Command: 0x1C (28 decimal)

- Parameter Range: 0x06 – 0x36 [Read-only]

- Number of bytes returned: 1

- Minimum Firmware Version Required: 4.22

RT (DI2 Configuration) Command

<Serial Interfacing> RT command is used to dictate the behavior of the DI2/ $\overline{\text{RTS}}$ /CMD line. RT Command must be issued to enable $\overline{\text{RTS}}$ flow control or binary programming.

AT Command: ATRT

Binary Command: 0x16 (22 decimal)

Parameter Range: 0 - 2

Parameter Value	Configuration
0	disabled
1	Enable Binary Programming
2	Enable $\overline{\text{RTS}}$ Flow Control

Default Parameter Value: 0

Number of bytes returned: 1

SB (Stop Bits) Command

SB Command is used to set/read the number of stop bits in the data packets.

AT Command: ATSB

Binary Command: 0x36 (54 decimal)

Parameter Range: 0 - 1

Parameter Value	Configuration
0	1 stop bits
1	2 stop bits

Default Parameter Value: 0

Number of bytes returned: 1

Minimum Firmware Version Required: 4.2B

SH (Serial Number High) Command

<Diagnostics> Set/Read the serial number high word of the module.

AT Command: ATSH

Binary Command: 0x25 (37 decimal)

Parameter Range: 0 - 0xFFFF [Read-only]

Number of bytes returned: 2

Related Commands: SL (Serial Number Low)

Minimum Firmware Version Required: 4.27C

SL (Serial Number Low) Command

<Diagnostics> Set/Read the serial number low word of the module.

AT Command: ATSL

Binary Command: 0x26 (38 decimal)

Parameter Range: 0 - 0xFFFF [Read-only]

Number of bytes returned: 2

Related Commands: SH (Serial Number High)

Minimum Firmware Version Required: 4.27C

SM (Sleep Mode) Command

<Sleep Mode (Low Power)> SM Command is used to adjust Sleep Mode settings. By default, Sleep Mode is disabled and the module remains continually active. SM Command allows the module to run in a lower-power state and be configured in one of eight settings.

Cyclic Sleep settings wake the module after the amount of time designated by SM Command. If the module detects a wake-up initializer during the time it is awake, it will synchronize with the transmitter and start receiving data after the wake-up initializer runs its duration. Otherwise, it returns to Sleep Mode and continue to cycle in and out of inactivity until the Wake-up Initializer is detected. If a Cyclic Sleep setting is chosen, the ST, LH and HT parameters must also be set as described in the "Sleep Mode" section of this manual.

Pin Sleep (SM = 1)

Pin Sleep requires the least amount of power. In order to achieve this state, SLEEP pin must be asserted (high). The module remains in Pin Sleep until the SLEEP pin is de-asserted.

After enabling Pin Sleep, the SLEEP pin controls whether the WCM802 / WCM900 Module is active or in Sleep Mode. When SLEEP is de-asserted (low), the module is fully operational. When SLEEP is asserted (high), the module transitions to Sleep Mode and remains in its lowest power-consuming state until the SLEEP pin is de-asserted. SLEEP is only active if the module is setup to operate in this mode; otherwise the pin is ignored.

Once in Pin Sleep Mode, \overline{CTS} is de-asserted (high), indicating that data should not be sent to the module. The PWR pin is also de-asserted (low) when the module is in Pin Sleep Mode.

Serial Port Sleep (SM = 2)

Serial Port Sleep is a Sleep Mode in which the WCM802 / WCM900 Module runs in a low power state until serial data is detected on the DI pin.

When Serial Port Sleep is enabled, the module goes into Sleep Mode after a user-defined period of inactivity (no transmitting or receiving of data). This period of time is determined by ST (Time before Sleep) Command. Once a character is received through the DI pin, the module returns to Idle Mode and is fully operational.

Cyclic Sleep (SM = 3-8)

Cyclic Sleep is the Sleep Mode in which the WCM802 / WCM900 Module enters into a low-power state and awakens periodically to determine if any transmissions are being sent.

When Cyclic Sleep settings are enabled, the WCM802 / WCM900 Module goes into Sleep Mode after a user-defined period of inactivity (no transmission or reception on the RF channel). The user-defined period is determined by ST (Time before Sleep) Command.

While the module is in Cyclic Sleep Mode, \overline{CTS} is de-asserted (high) to indicate that data should not be sent to the module during this time. When the module awakens to listen for data, \overline{CTS} is asserted and any data received on the DI Pin is transmitted. The PWR pin is also de-asserted (low) when the module is in Cyclic Sleep Mode.

AT Command: ATSM

Binary Command: 0x01

Parameter Range: 0 - 8

Parameter Value	Configuration
0	Disabled
1	Pin Sleep
2	Serial Port Sleep
3	Cyclic 0.5 second sleep (Module wakes every 0.5 seconds)
4	Cyclic 1.0 second sleep
5	Cyclic 2.0 second sleep
6	Cyclic 4.0 second sleep
7	Cyclic 8.0 second sleep
8	Cyclic 16.0 second sleep

Default Parameter Value: 0

Number of bytes returned: 1

Related Commands:

For Pin Sleep - PC (Power-up Mode), PW (Pin Wake-up)

For Serial Port Sleep - ST (Time before Sleep)

For Cyclic Sleep - ST (Time before Sleep), LH (Wake-up Initializer Timer), HT (Time Before Wake-up Initializer), PW (Pin Wake-up)

SM Command (continued)

The module remains in Sleep Mode for a user-defined period of time ranging from 0.5 seconds to 16 seconds (SM Parameters 3 through 8). After this interval of time, the module returns to Idle Mode and listens for a valid data packet for 100 ms. If the module does not detect valid data (on any frequency), the module returns to Sleep Mode. If valid data is detected, the module transitions into Receive Mode and receives incoming RF packets. The module then returns to Sleep Mode after a Period of inactivity that is determined by ST "Time before Sleep" Command.

The module can also be configured to wake from cyclic sleep when SLEEP (pin 2) is de-asserted (low). To configure a module to operate in this manner, PW (Pin Wake-up) Command must be issued. Once SLEEP is de-asserted, the module is forced into Idle Mode and can begin transmitting or receiving data. It remains active until no data is detected for the period of time specified by the ST Command, at which point it resumes its low-power cyclic state.

Note: The cyclic interval time defined by SM (Sleep Mode) Command must be shorter than the interval time defined by LH (Wake-up Initializer Timer).

For example: If SM=4 (Cyclic 1.0 second sleep), the LH Parameter should equal 0x0B ("1.1" seconds). With these parameters set, there is no risk of the receiving module being asleep for the duration of wake-up initializer transmission. "Cyclic Scanning" explains in further detail the relationship between "Cyclic Sleep" and "Wake-up Initializer Timer"

Cyclic Scanning. Each RF transmission consists of an RF Initializer and payload. The wake-up initializer contains initialization information and all receiving modules must wake during the wake-up initializer portion of data transmission in order to be synchronized with the transmitting module and receive the data.

Figure 4.1 Correct Configuration (LH > SM)

Length of the wake-up initializer exceeds the time interval of Cyclic Sleep. The receiver is guaranteed to detect the wake-up initializer and receive the accompanying payload data.

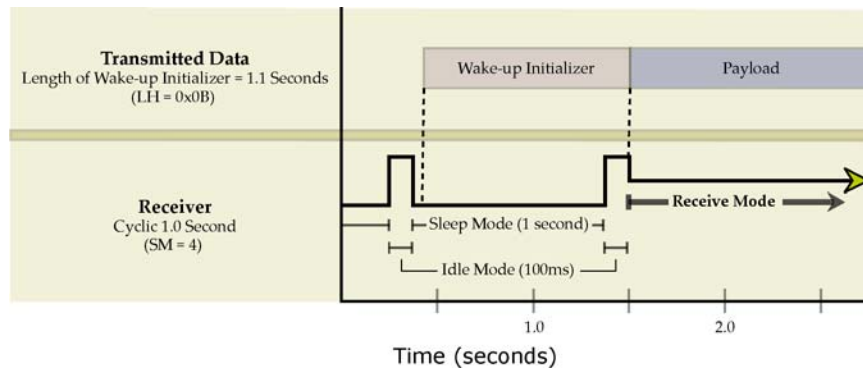
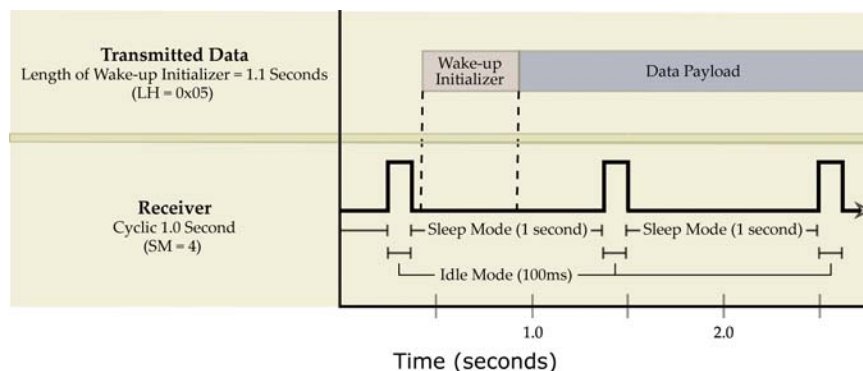

Figure 4.2 Incorrect Configuration (LH < SM)

Length of wake-up initializer is shorter than the time interval of Cyclic Sleep. This configuration is vulnerable to the receiver waking and missing the wake-up initializer (and therefore also the accompanying payload data).



ST (Time before Sleep) Command

<Sleep Mode (Low Power)> ST Command sets the period of time (in tenths of seconds) in which the module remains inactive before entering into Sleep Mode. For example, if the ST Parameter is set to 0x64 (100 decimal), the module will enter into Sleep mode after 10 seconds of inactivity (no transmitting or receiving). This command can only be used if Cyclic Sleep or Serial Port Sleep Mode settings have been selected using SM (Sleep Mode) Command.

AT Command: ATST
 Binary Command: 0x02
 Parameter Range: 0x10 - 0xFFFF
 [x 100 milliseconds]
 Default Parameter Value: 0x64 (100 decimal)
 Number of bytes returned: 2
 Related Commands: SM (Sleep Mode), LH (Wake-up Initializer Timer), HT (Time before Wake-up Initializer)

SY (Time before Initialization) Command

<Networking> SY Command keeps a communication channel open as long as module transmits or receives before the active connection expires. It can be used to reduce latency in a query/response sequence and should be set 100 ms longer than the delay between transmissions.

This command allows multiple WCM802 / WCM900 Modules to share a hopping channel for a given amount of time after receiving data. By default, all packets include an RF initializer that contains channel information used to synchronize any listening receivers to the transmitter's hopping pattern. Once a new module comes within range, it is able to instantly synchronize to the transmitter and start receiving data. If no new modules are introduced into the system, the synchronization information becomes redundant once modules have become synchronized.

SY Command allows the modules to remove this information from the RF Initializer after the initial synchronization. For example, changing the SY Parameter to 0x14 (20 decimal) allows all modules to remain in sync for 2 seconds after the last data packet was received. Synchronization information is not re-sent unless transmission stops for more than 2 seconds. This command allows significant savings in packet transmission time.

AT Command: ATSY
 Binary Command: 0x17 (23 decimal)
 Parameter Range: 0 - 0xFF
 [x 100 milliseconds]
 Default Parameter Value: 0 (Disabled - channel initialization information is sent with each RF packet.)
 Number of bytes returned: 1

Warning: Not recommended for use in an interference-prone environment. Interference can break up the session and the communications channel will not be available again until SY time expires.

With SY set to zero, the channel session is opened and closed with each transmission - resulting in a more robust link with more latency.

TR (Transmit Error Count) Command

<Diagnostics> TR Command records the number of retransmit failures. This number is incremented each time a packet is not acknowledged within the number of retransmits specified by the RR (Retries) Command. It therefore counts the number of packets that were not successfully received and have been dropped. The TR Parameter is not non-volatile and will therefore be reset to zero each time the module is reset.

AT Command: ATTR
 Binary Command: 0x1B (27 decimal)
 Parameter Range: 0 - 0xFFFF
 Default Parameter Value: 0
 Number of bytes returned: 2
 Related Commands: RR (Retries)
 Minimum Firmware Version Required: 4.22

TT (Streaming Limit) Command

<Networking> TT Command defines a limit on the number of bytes that can be sent out before a random delay is issued. TT Command is used to simulate full-duplex behavior.

If a module is sending a continuous stream of RF data, a delay is inserted which stops its transmission and allows other modules time to transmit (once it sends number of bytes specified by TT Command). Inserted random delay lasts between 1 & 'RN + 1' delay slots, where each delay slot lasts 38 ms.

AT Command: ATTT

Binary Command: 0x1A (26 decimal)

Parameter Range: 0 - 0xFFFF (0 = disabled)

Default Parameter Value: 0xFFFF (65535 decimal)

Number of bytes returned: 2

Related Commands: RN (Delay Slots)

Minimum Firmware Version Required: 4.22

VR (Firmware Version) Command

<Diagnostics> Read the Firmware Version of the WCM802 / WCM900 Module.

AT Command: ATVR

Binary Command: 0x14 (20 decimal)

Parameter Range: 0 - 0xFFFF [Read-only]

Number of bytes returned: 2

WR (Write) Command

<(Special)> WR Command writes configurable parameters to the module's non-volatile memory (Parameter values remain in the module's memory until overwritten by future use of WR Command).

If changes are made without writing them to non-volatile memory, the module reverts back to previously saved parameters the next time the module is powered-on.

AT Command: ATWR

Binary Command: 0x08

Appendix A: Agency Certifications

FCC Certification

The WCM802 / WCM900 OEM RF Module complies with Part 15 of the FCC rules and regulations. Compliance with the labeling requirements, FCC notices and antenna usage guidelines is required.

To fulfill the FCC Certification requirements, the OEM must comply with the following FCC regulations:

1. The system integrator must ensure that the text on the external label provided with this device is placed on the outside of the final product [Figure A.1 for 900 MHz operations or Figure A.2 for 2.4 GHz operations].
2. The WCM802 / WCM900 OEM RF Module may be used only with Approved Antennas that have been tested with this module. [Table A.1 or Table A.2]

FCC Notices:

IMPORTANT: The WCM900 (900 MHz) and WCM802 (2.4 GHz) OEM Modules have been certified by the FCC for use with other products without any further certification (as per FCC section 2.1091). Changes or modifications not expressly approved by Horner could void the user's authority to operate the equipment.

IMPORTANT: OEMs must test their final product to comply with unintentional radiators (FCC section 15.107 and 15.109) before declaring compliance of their final product to Part 15 of the FCC Rules.

IMPORTANT: The WCM802 / WCM900 OEM RF Modules have been certified for remote and base radio applications. If the WCM802 / WCM900 will be used for portable applications, the device must undergo SAR testing.

This equipment has been tested and found to comply with the limits for a Class B digital device, pursuant to Part 15 of the FCC Rules. These limits are designed to provide reasonable protection against harmful interference in a residential installation. This equipment generates, uses and can radiate radio frequency energy and, if not installed and used in accordance with the instructions, may cause harmful interference to radio communications. However, there is no guarantee that interference will not occur in a particular installation. If this equipment does cause harmful interference to radio or television reception, which can be determined by turning the equipment off and on, the user is encouraged to try to correct the interference by one or more of the following measures:

- Re-orient or relocate the receiving antenna.
- Increase the separation between the equipment and receiver.
- Connect the equipment into an outlet on a circuit different from that to which the receiver is connected.
- Consult the dealer or an experienced radio/TV technician for help.

OEM Labeling Requirements

Label Warning



WARNING The Original Equipment Manufacturer (OEM) must ensure that FCC labeling requirements are met. This includes a clearly visible label on the outside of the final product enclosure that displays the contents shown in the figure below.

Figure A.1. Required FCC Label for OEM products containing WCM900 (900 MHz) OEM RF Module

Contains FCC ID: OUR9XSTREAM

The enclosed device complies with Part 15 of the FCC Rules. Operation is subject to the following two conditions: (1) this device may not cause harmful interference and (2) this device must accept any interference received, including interference that may cause undesired operation.

Figure A.2. Required FCC Label for OEM products containing WCM802 (2.4 GHz) OEM RF Module

Contains FCC ID: OUR-24XSTREAM

The enclosed device complies with Part 15 of the FCC Rules. Operation is subject to the following two conditions: (1) this device may not cause harmful interference and (2) this device must accept any interference received, including interference that may cause undesired operation.

Antenna Usage

Antenna Warning



WARNING: This device has been tested with Reverse Polarity SMA connectors with the antennas listed in Tables A.1 & A.2 of Appendix A. When integrated in OEM products, fixed antennas require installation preventing end-users from replacing them with non-approved antennas. Antennas not listed in the tables must be tested to comply with FCC Section 15.203 (unique antenna connectors) and Section 15.247 (emissions).

RF Exposure



WARNING: This equipment is approved only for mobile and base station transmitting devices, separation distances of (i) 20 centimeters or more for antennas with gains < 6 dBi or (ii) 2 meters or more for antennas with gains ≥ 6 dBi should be maintained between the antenna of this device and nearby persons during operation. To ensure compliance, operation at distances closer than this is not recommended.

The preceding statement must be included as a CAUTION statement in manuals for OEM products to alert users on FCC RF Exposure compliance.

Horner Modules are pre-FCC approved for use in fixed base station and mobile applications. As long as the antenna is mounted at least 20 cm (8 in) from nearby persons, the application is considered a mobile application. If the antenna will be mounted closer than 20 cm to nearby persons, then the application is considered "portable" and requires an additional test performed on the final product. This test is called the Specific Absorption Rate (SAR) testing and measures the emissions from the module and how they affect the person.

Over 100 additional antennas have been tested and are approved for use with Horner 900 MHz Modules (including "Mag Mount", "Dome", "Multi-path" and "Panel" antennas). Because of the large number of approved antennas, Horner requests that you send specific information about an antenna you would like to use with the module and Horner will evaluate whether the antenna is covered under our FCC filing.

FCC-Approved Antennas

Table A.1. Antennas approved for use with WCM900 (900 MHz) OEM RF Modules.

Part Number	Type	Gain	Application	Min. Separation Distance
*	Yagi	6.2 dBi	Fixed/Mobile **	20 cm
*	Yagi	7.2 dBi	Fixed/Mobile **	20 cm
A09-Y8	Yagi	8.2 dBi	Fixed/Mobile **	20 cm
*	Yagi	9.2 dBi	Fixed/Mobile **	20 cm
*	Yagi	10.2 dBi	Fixed/Mobile **	20 cm
A09-Y11 (FCC pending)	Yagi	11.2 dBi	Fixed/Mobile **	20 cm
A09-F2	Omni Direct.	2.2 dBi	Fixed **	20 cm
A09-F5	Omni Direct.	5.2 dBi	Fixed **	20 cm
A09-F8	Omni Direct.	8.2 dBi	Fixed **	20 cm
*	Omni Direct.	9.2 dBi	Fixed **	20 cm
*	Omni Direct.	7.2 dBi	Fixed **	20 cm
A09-M7	Omni Direct.	7.2 dBi	Fixed **	20 cm
A09-H	1/2 wave antenna	2.1 dBi	Fixed/Mobile **	20 cm
A09-HBMM-P5I	1/2 wave antenna	2.1 dBi	Fixed/Mobile **	1 cm
A09-QBMM-P5I	1/4 wave antenna	1.9 dBi	Fixed/Mobile **	1 cm
*	1/4 wave integrated wire antenna	1.9 dBi	Fixed/Mobile **	1 cm

Table A.2. Antennas approved for use with WCM802 (2.4 GHz) OEM RF Modules.

Part Number	Type	Gain	Application	Min. Separation Distance
*	Yagi	6 dBi	Fixed **	2 m
*	Yagi	8.8 dBi	Fixed **	2 m
*	Yagi	9 dBi	Fixed **	2 m
*	Yagi	10 dBi	Fixed **	2 m
*	Yagi	11 dBi	Fixed **	2 m
*	Yagi	12 dBi	Fixed **	2 m
*	Yagi	12.5 dBi	Fixed **	2 m
*	Yagi	13.5 dBi	Fixed **	2 m
*	Yagi	15 dBi	Fixed **	2 m
*	Omni Direct	2.1 dBi	Fixed/Mobile **	20 cm
*	Omni Direct	3 dBi	Fixed/Mobile **	20 cm
*	Omni Direct	5 dBi	Fixed/Mobile **	20 cm
*	Omni Direct	7.2 dBi	Fixed **	2 m
*	Omni Direct	8 dBi	Fixed **	2 m
*	Omni Direct	9.5 dBi	Fixed **	2 m
*	Omni Direct	10 dBi	Fixed **	2 m
*	Omni Direct	12 dBi	Fixed **	2 m
*	Omni Direct	15 dBi	Fixed **	2 m
A24-P8	Panel	8.5 dBi	Fixed **	2 m
A24-P13	Panel	13 dBi	Fixed **	2 m
*	Panel	14 dBi	Fixed **	2 m
*	Panel	15 dBi	Fixed **	2 m
*	Panel	16 dBi	Fixed **	2 m
A24-P19	Panel	19 dBi	Fixed **	2 m
A24-HABMM-P6I	Dipole	2.1 dBi	Fixed/Mobile **	20 cm
A24-HBMM-P6I	Dipole	2.1 dBi	Fixed/Mobile **	20 cm
A24-HABSM	Dipole	2.1 dBi	Fixed/Mobile **	20 cm
A24-QABMM-P6I	Monopole	1.9 dBi	Fixed/Mobile **	20 cm
A24-Q1	Monopole	1.9 dBi	Fixed/Mobile **	20 cm
*	Monopole	1.9 dBi	Fixed/Mobile **	20cm

* FCC-approved antennas not inventoried by Horner – Contact Horner TECHNICAL SUPPORT (See Appedix B for phone information.)

** Can be approved for portable applications if integrator gains approval through SAR testing

European Compliance (2.4 GHz only)

The WCM802 has been certified for use in several European countries.

If the WCM802 Modules are incorporated into a product, the manufacturer must ensure compliance of the final product to the European harmonized EMC and low-voltage/safety standards. A Declaration of Conformity must be issued for each of these standards and kept on file as described in Annex II of the R&TTE Directive. Furthermore, the manufacturer must maintain a copy of the WCM802 user manual documentation and ensure the final product does not exceed the specified power ratings, antenna specifications, and/or installation requirements as specified in the user manual. If any of these specifications are exceeded in the final product, a submission must be made to a notified body for compliance testing to all required standards.

OEM Labeling Requirements

The 'CE' marking must be affixed to a visible location on the OEM product.

Figure A.3. CE Labeling Requirements

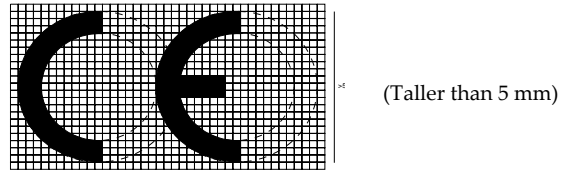

The CE mark shall consist of the initials "CE" taking the following form:

- If the CE marking is reduced or enlarged, the proportions given in the above graduated drawing must be respected.
- The CE marking must have a height of at least 5mm except where this is not possible on account of the nature of the apparatus.
- The CE marking must be affixed visibly, legibly, and indelibly.

Furthermore, since the usage of the 2400 – 2483.5 MHz band is not harmonized throughout Europe, the Restriction sign must be placed to the right of the 'CE' marking as shown below. See the R&TTE Directive, Article 12 and Annex VII for more information

Figure A.4. CE Label Required on OEM Equipment



Restrictions

France – France imposes restrictions on the 2.4 GHz band. Go to www.art-telecom.fr or contact Horner for more information.

Norway – Norway prohibits operation near Ny-Alesund in Svalbard. More information can be found at the Norway Posts and Telecommunications site (www.npt.no).

WCM802 Declarations of Conformity

Horner has issued Declarations of Conformity for the WCM802 Modules concerning emissions, EMC and safety. Files are located in the 'documentation' folder of the Horner CD.

Important Note

Horner does not list the entire set of standards that must be met for each country. Horner customers assume full responsibility for learning and meeting the required guidelines for each country in their distribution market. For more information relating to European compliance of an OEM product incorporating the WCM802 Module, contact Horner (see Appendix B), or refer to the following web sites:

CEPT ERC 70-03E – Technical Requirements, European restrictions and general requirements: Available at www.ero.dk/

R&TTE Directive – Equipment requirements, placement on market: Available at www.ero.dk/

Notifications and Required Information

Since the 2.4 GHz band is not harmonized throughout Europe, a notification must be sent to each country prior to shipping product according to Article 6.4 of the R&TTE Directive. A list of national contacts for most European countries may be found at www.ero.dk/.

The following technical data (relating to the WCM802) is often required in filling out a notification form.

- Frequency Band: 2400.0 – 2483.5 MHz
- Modulation: Frequency Shift Keying
- Channel Spacing: 400 kHz
- ITU Classification: 400KF1D
- Output Power: 100 mW EIRP
- Notified Body Number: 0891

Contact Horner if additional information is required.

Europe (2.4 GHz) Approved Antenna List

Table A.3. Antennas approved for use with WCM802 (2.4 GHz) RF Modules in Europe

Part Number	Type	Gain	Application	Min. Separation Distance
A24-HABMM-P6I	Dipole	2.1 dBi	Fixed/Mobile *	20cm
A24-HBMM-P6I	Dipole	2.1 dBi	Fixed/Mobile *	20cm
A24-HABSM	Dipole	2.1 dBi	Fixed/Mobile *	20cm
A24-QABMM-P6I	Monopole	1.9 dBi	Fixed/Mobile *	20cm
A24-QBMM-P6I	Monopole	1.9 dBi	Fixed/Mobile *	20cm
A24-Q1	Monopole	1.9 dBi	Fixed/Mobile *	20cm

* Can be approved for portable applications if integrator gains approval through SAR testing

IC (Industry Canada) Certification

Labeling requirements for Industry Canada are similar to those of the FCC. A clearly visible label on the outside of the final product enclosure must display the following text:

Contains Model 9XStream Radio (900 MHz), IC: 4214A-9XSTREAM
Contains Model 24XStream Radio (2.4 GHz), IC: 4214A 12008

Integrator is responsible for its product to comply with IC ICES-003 & FCC Part 15, Sub. B - Unintentional Radiators. ICES-003 is the same as FCC Part 15 Sub. B and Industry Canada accepts FCC test report or CISPR 22 test report for compliance with ICES-003.

Appendix B: Additional Information

Technical Support

For user manual updates and assistance, contact Technical Support:

North America:

(317) 916-4274

www.heapg.com

Europe:

(+) 353-21-4321-266

www.horner-apg.com

NOTES