



User Manual for

**HE-XE100, HE-XE102, HE-XE103, HE-XE104, HE-XE105
HE-XT100, HE-XT102, HE-XT103, HE-XT104, HE-XT105
HEXE220C100/HEXE220C000, HEXT240C100/HEXT240C000
HEXE220C112 / HEXE220C01, HEXT240C112 / HEXT240C012
HEXE220C114 / HEXE220C014, HEXT240C114 / HEXT240C014
HEXE220C113 / HEXE220C013, HEXT240C113 / HEXT240C013
HEXE220C115 / HEXE220C015, HEXT240C115 / HEXT240C015**

XLe/XLt OCS

PREFACE

This manual explains how to use the XLe/XLt OCS Modules.

Copyright (C) 2008 Horner APG, LLC., 59 South State Avenue, Indianapolis, Indiana 46201. All rights reserved. No part of this publication may be reproduced, transmitted, transcribed, stored in a retrieval system, or translated into any language or computer language, in any form by any means, electronic, mechanical, magnetic, optical, chemical, manual or otherwise, without the prior agreement and written permission of Horner APG, Inc.

All software described in this document or media is also copyrighted material subject to the terms and conditions of the Horner Software License Agreement.

Information in this document is subject to change without notice and does not represent a commitment on the part of Horner APG.

Cscape, SmartStack, SmartStix and CsCAN are trademarks of Horner APG.

Ethernet is a trademark of Xerox Corporation.

Micro SD and CompactFlash are registered trademarks of SanDisk Corporation.

For user manual updates, contact Technical Support:

North America:

Tel: (+) (317) 916-4274

Fax: (+) (317) 639-4279

Web: www.heapg.com

Email: techspt@heapg.com

Europe:

Tel: (+) 353-21-4321-266

Fax: (+) 353-21-4321-826

Web: www.horner-apg.com

Email: tech.support@hornerapg.com

LIMITED WARRANTY AND LIMITATION OF LIABILITY

Horner APG, LLC. ("HE-APG") warrants to the original purchaser that the XLe/XLt OCS module manufactured by HE-APG is free from defects in material and workmanship under normal use and service. The obligation of HE-APG under this warranty shall be limited to the repair or exchange of any part or parts which may prove defective under normal use and service within two (2) years from the date of manufacture or eighteen (18) months from the date of installation by the original purchaser whichever occurs first, such defect to be disclosed to the satisfaction of HE-APG after examination by HE-APG of the allegedly defective part or parts. THIS WARRANTY IS EXPRESSLY IN LIEU OF ALL OTHER WARRANTIES EXPRESSED OR IMPLIED INCLUDING THE WARRANTIES OF MERCHANTABILITY AND FITNESS FOR USE AND OF ALL OTHER OBLIGATIONS OR LIABILITIES AND HE-APG NEITHER ASSUMES, NOR AUTHORIZES ANY OTHER PERSON TO ASSUME FOR HE-APG, ANY OTHER LIABILITY IN CONNECTION WITH THE SALE OF THIS XLe/XLt OCS module. THIS WARRANTY SHALL NOT APPLY TO THIS XLe/XLt OCS module OR ANY PART THEREOF WHICH HAS BEEN SUBJECT TO ACCIDENT, NEGLIGENCE, ALTERATION, ABUSE, OR MISUSE. HE-APG MAKES NO WARRANTY WHATSOEVER IN RESPECT TO ACCESSORIES OR PARTS NOT SUPPLIED BY HE-APG. THE TERM "ORIGINAL PURCHASER", AS USED IN THIS WARRANTY, SHALL BE DEEMED TO MEAN THAT PERSON FOR WHOM THE XLe/XLt OCS module IS ORIGINALLY INSTALLED. THIS WARRANTY SHALL APPLY ONLY WITHIN THE BOUNDARIES OF THE CONTINENTAL UNITED STATES.

In no event, whether as a result of breach of contract, warranty, tort (including negligence) or otherwise, shall HE-APG or its suppliers be liable of any special, consequential, incidental or penal damages including, but not limited to, loss of profit or revenues, loss of use of the products or any associated equipment, damage to associated equipment, cost of capital, cost of substitute products, facilities, services or replacement power, down time costs, or claims of original purchaser's customers for such damages.

To obtain warranty service, return the product to your distributor with a description of the problem, proof of purchase, post paid, insured and in a suitable package.

ABOUT PROGRAMMING EXAMPLES

Any example programs and program segments in this manual or provided on accompanying diskettes are included solely for illustrative purposes. Due to the many variables and requirements associated with any particular installation, Horner APG cannot assume responsibility or liability for actual use based on the examples and diagrams. It is the sole responsibility of the system designer utilizing the XLe/XLt OCS module to appropriately design the end system, to appropriately integrate the XLe/XLt OCS module and to make safety provisions for the end equipment as is usual and customary in industrial applications as defined in any codes or standards which apply.

Note: The programming examples shown in this manual are for illustrative purposes only. Proper machine operation is the sole responsibility of the system integrator.

Table of Contents

VISUAL MAP OF MAJOR TASKS AND THE KEY CHAPTERS TO ASSIST YOU	7
CHAPTER 1 : SAFETY / COMPLIANCE	9
1.1 Safety Warnings and Guidelines.....	9
1.2 Grounding	10
1.3 CE Compliance	10
CHAPTER 2 : INTRODUCTION	11
2.1 Visual Overview of XLe/XLt and Topics Covered in this Manual.....	11
2.1.1 Where to Find Information about the XLe/XLt.....	11
2.2 Connectivity to the XLe/XLt.....	12
2.3 Features of XLe/XLt	12
2.4 Required and Suggested Accessories.....	13
2.5 Useful Documents and References	14
CHAPTER 3 : MECHANICAL INSTALLATION.....	15
3.1 Overview	15
3.2 Mounting Requirements.....	15
3.2.1 Mounting Procedures (Installed in a Panel Door)	15
3.2.2 Mounting Procedures (Installed on DIN Rail).....	16
3.3 Mounting Orientation.....	16
3.4 Panel Cut-Out	17
3.5 Dimensions	17
3.6 Factors Affecting Panel Layout Design and Clearances	18
3.6.1 Clearance / Adequate Space	18
3.6.2 Grounding.....	18
3.6.3 Temperature / Ventilation	18
3.6.4 Orientation	19
3.6.5 Noise	19
3.6.6 Shock and Vibration	19
3.6.7 Panel Layout Design and Clearance Checklist.....	19
CHAPTER 4 : ELECTRICAL INSTALLATION	21
4.1 Grounding Definition	21
4.2 Ground Specifications.....	21
4.3 How to Test for Good Ground.....	21
4.4 Primary Power Port.....	22
CHAPTER 5 : SERIAL COMMUNICATIONS	23
5.1 Overview	23
5.2 Port Descriptions.....	23
5.3 Wiring	23
5.4 RS-485 Termination.....	24
5.5 RS-485 Biasing	24
5.6 Cscape Programming via Serial Port.....	24
5.7 Ladder-Controlled Serial Communication	24
5.8 Downloadable Serial Communication Protocols.....	24
CHAPTER 6 : CAN COMMUNICATIONS.....	25
6.1 Overview	25
6.2 Port Description.....	25
6.3 Wiring	25
6.4 Cscape Programming via CAN	26
6.5 Ladder-Controlled CAN Communication	26
6.6 Using CAN for I/O Expansion (Network I/O).....	26

CHAPTER 7 : COMMUNICATION OPTIONS	27
7.1 Overview	27
7.1.1 MJ1 shares	27
7.2 Ethernet COM Module (XEC) Option.....	27
7.3 Modem COM Module (XMC) Option.....	28
CHAPTER 8 : REMOVABLE MEDIA	29
8.1 Overview	29
8.2 Micro SD Cards.....	29
8.3 Micro SD File System	29
8.4 Using the Removable Media Manager.....	30
8.5 Using Removable Media to Log Data	30
8.6 Using Removable Media to Load and Save Applications.....	30
8.7 Using Removable Media to View and Capture Screens.....	31
CHAPTER 9 : GENERAL I/O	33
9.1 Overview	33
9.2 Removing the XLe/XLt Back Cover	33
9.3 Model and I/O Overview	34
9.4 Solid-State Digital Outputs.....	35
9.5 Relay Outputs	35
9.6 Digital Inputs	37
9.7 Analog Inputs	37
9.8 Universal Analog Inputs	38
9.9 Analog Outputs	38
CHAPTER 10 : HIGH SPEED I/O (HSC / PWM)	39
10.1 Overview	39
10.2 High Speed Counter (HSC) Functions.....	39
10.2.1 Frequency.....	39
10.2.2 Totalize	39
10.2.3 Pulse.....	40
10.2.4 Quadrature	41
10.3 HSC Functions Register Map	45
10.4 Pulse Width Modulation (PWM) Functions	45
10.4.1 Normal.....	45
10.4.2 PWM.....	45
10.4.3 HSC (High Speed Counter).....	47
10.4.4 Stepper Function	47
10.5 PWM functions register map.....	48
10.6 PWM Examples.....	48
10.7 STP Examples	49
CHAPTER 11 : SYSTEM SETTINGS AND ADJUSTMENTS	51
11.1 System Menu - Overview	51
11.2 System Menu – Navigation and Editing	52
11.3 System Menu – Details	53
CHAPTER 12 : USER INTERFACE	63
12.1 Screen Navigation.....	63
12.2 Ladder Based Screen Navigation	64
12.3 Using Editable Screen Objects	64
CHAPTER 13 : REGISTERS	67
13.1 Register Definitions	67
13.2 Useful %S and %SR registers	68
13.3 Register Map for XLe/XLt I/O.....	69
13.4 Resource Limits	70
CHAPTER 14 : CSCAPE CONFIGURATION	71
14.1 Overview	71

14.2	Cscape Status Bar	71
14.3	Establishing Communications	72
14.4	Models supported.....	72
14.5	Configuration.....	72
14.6	Digital Input / HSC Configuration	73
14.7	Digital Output / PWM Configuration	75
14.8	Analog Input Configuration	76
14.9	Analog Output Configuration.....	77
CHAPTER 15 : FAIL – SAFE SYSTEM		79
15.1	Overview	79
15.2	Settings	79
15.3	Backup / Restore Data.....	80
15.4	AutoLoad.....	84
15.5	AutoRun	86
CHAPTER 16 : CLONE UNIT		87
16.1	Overview	87
16.2	Clone.....	87
16.3	Load Clone.....	89
CHAPTER 17 : MAINTENANCE.....		91
17.1	Firmware Updates.....	91
17.2	Backup Battery.....	91
17.2.1	Indications the battery needs replacing.....	91
17.2.2	Battery Replacement.....	92
CHAPTER 18 : TROUBLESHOOTING / TECHNICAL SUPPORT		93
18.1	Connecting to the XLe/XLt.....	93
18.1.1	Connecting Troubleshooting Checklist.....	94
18.2	Local Controller and Local I/O	94
18.2.1	Local I/O Troubleshooting Checklist.....	94
18.3	CsCAN Network.....	95
18.3.1	CsCAN Network Troubleshooting Checklist.....	95
18.4	Removable Media	96
18.4.1	Basic Troubleshooting.....	96
18.5	Technical Support Contacts.....	96
INDEX		97
TABLE OF FIGURES		99

VISUAL MAP OF MAJOR TASKS AND THE KEY CHAPTERS TO ASSIST YOU

The following map is provided to show you the major types of tasks needed to be performed and the key chapters in this manual you need to refer to for information and help.

Directions: Major tasks are listed at the top of the map with the key chapters listed beneath that you need to consult in order to perform the tasks.

FIRST STEP of ANY TASK: DATASHEET			
Each XLe/XLt unit is sent with a datasheet in the box. The datasheet is the first document you need to refer to for model-specific information related to XLe/XLt models such as pin-outs, jumper settings, and other key installation information. The web version of this manual has all of the XLe/XLt datasheets attached to it. Visit our website (see page 96) to obtain updates to datasheets and user documentation.			
QUICK START	INSTALLATION	PROGRAMMING	TROUBLESHOOTING
Safety / Compliance Page 8	Safety / Compliance Page 8	Safety / Compliance Page 8	Safety / Compliance Page 8
Introduction Page 10	Introduction Page 10	Introduction Page 10	Introduction Page 10
	Mechanical Installation Page 14	System Settings Page 50	Maintenance Page 88
	Electrical Installation Page 20	Cscape Configuration Page 71	Troubleshooting Page 91
	Serial Comm Page 22	User Interface Page 79	
	CAN Comm Page 24	Removable Media Page 28	
	Communication Options Page 26	General I/O Page 32	
	General I/O Page 32	High Speed I/O Page 38	
		Registers page 66	
		Fail – Safe System Page 79	
		Clone Unit Page 87	

CHAPTER 1: SAFETY / COMPLIANCE

1.1 Safety Warnings and Guidelines

When found on the product, the following symbols specify:



Warning: Consult user documentation.



Warning: Electrical Shock Hazard.

WARNING – EXPLOSION HAZARD – Substitution of components may impair suitability for Class I, Division 2

WARNING – EXPLOSION HAZARD – Do not disconnect equipment unless power has been switched off or the area is known to be non-hazardous.

WARNING: To avoid the risk of electric shock or burns, always connect the safety (or earth) ground before making any other connections.

WARNING: To reduce the risk of fire, electrical shock, or physical injury it is strongly recommended to fuse the voltage measurement inputs. Be sure to locate fuses as close to the source as possible.

WARNING: Replace fuse with the same type and rating to provide protection against risk of fire and shock hazards.

WARNING: In the event of repeated failure, do not replace the fuse again as a repeated failure indicates a defective condition that will not clear by replacing the fuse.

WARNING: Only qualified electrical personnel familiar with the construction and operation of this equipment and the hazards involved should install, adjust, operate, or service this equipment. Read and understand this manual and other applicable manuals in their entirety before proceeding. Failure to observe this precaution could result in severe bodily injury or loss of life.

- All applicable codes and standards need to be followed in the installation of this product.
- For I/O wiring (discrete), use the following wire type or equivalent: Belden 9918, 18 AWG or larger.

Adhere to the following safety precautions whenever any type of connection is made to the module.

- Connect the green safety (earth) ground first before making any other connections.
- When connecting to electric circuits or pulse-initiating equipment, open their related breakers. Do not make connections to live power lines.
- Make connections to the module first; then connect to the circuit to be monitored.
- Route power wires in a safe manner in accordance with good practice and local codes.
- Wear proper personal protective equipment including safety glasses and insulated gloves when making connections to power circuits.
- Ensure hands, shoes, and floors are dry before making any connection to a power line.
- Make sure the unit is turned OFF before making connection to terminals. Make sure all circuits are de-energized before making connections.
- Before each use, inspect all cables for breaks or cracks in the insulation. Replace immediately if defective.

1.2 Grounding

Grounding is covered in various chapters within this manual.

- For grounding specifications and testing for a good ground, refer to page **21**.
- For panel grounding, refer to **18**.

1.3 CE Compliance

To check for compliance and updates, visit our website at:

<http://www.heapg.com/Pages/TechSupport/ProductCert.html>

CHAPTER 2: INTRODUCTION

2.1 Visual Overview of XLe/XLt and Topics Covered in this Manual

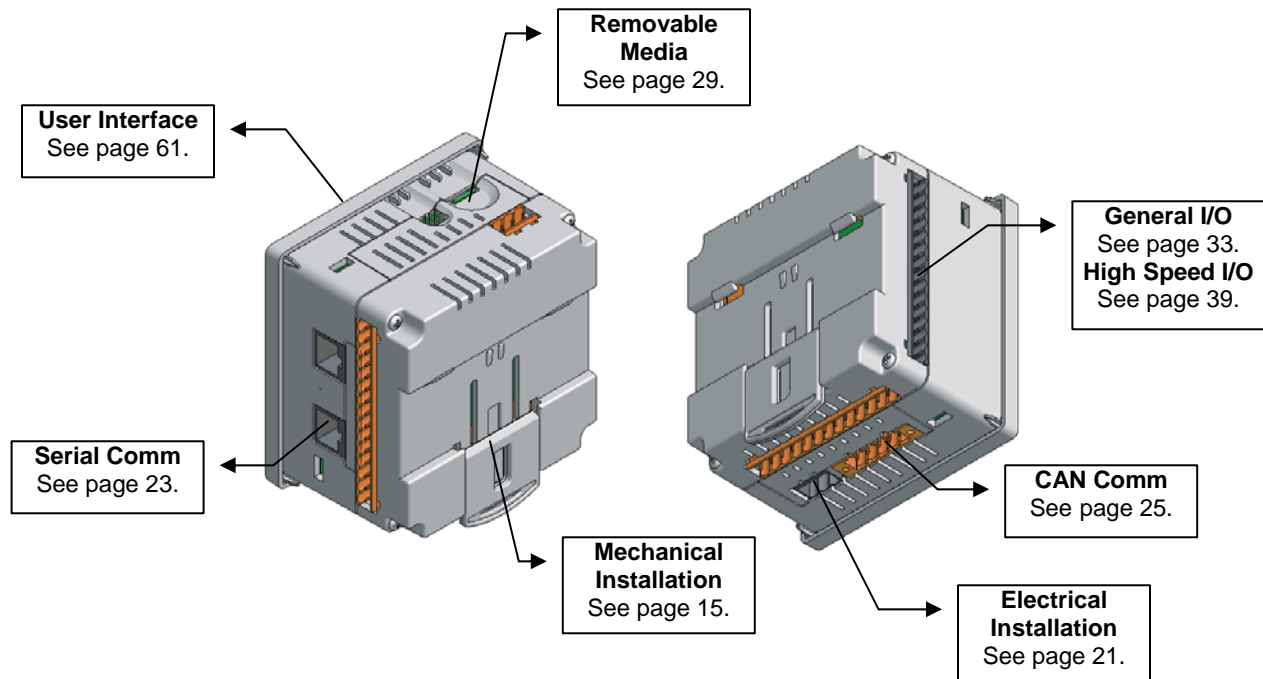

Figure 2-1 – Visual Overview of XLe/XLt and Topics of Interest Covered in the User Manual

2.1.1 Where to Find Information about the XLe/XLt

a. Datasheets - The **datasheets are the first documents you need to refer to for key information** related to specific XLe/XLt models. (A datasheet is provided in the box with your unit.)

The datasheets for all XLe/XLt models are attached to the back of this manual on our website, and they are also available individually on the web.

Datasheets contain pin-outs, jumper settings and other model specific information.

b. User Manual -This manual provides general information that is common to XLe/XLt models and can be downloaded from our web. Visit our website (see page **96**) to obtain user documentation and updates.

Four main types of information are covered in the manual.

- Safety and Installation guidelines / instructions (Mechanical and Electrical)
- Descriptions of hardware features (Serial ports, Removable Media, Communication Options, etc.)
- Configuration and Use of the XLe/XLt
- Maintenance and Support

2.2 Connectivity to the XLe/XLt

The XLe/XLt has tremendous capabilities for connecting to a variety of devices. The diagram below shows some examples of devices that can be used with the XLe/XLt.

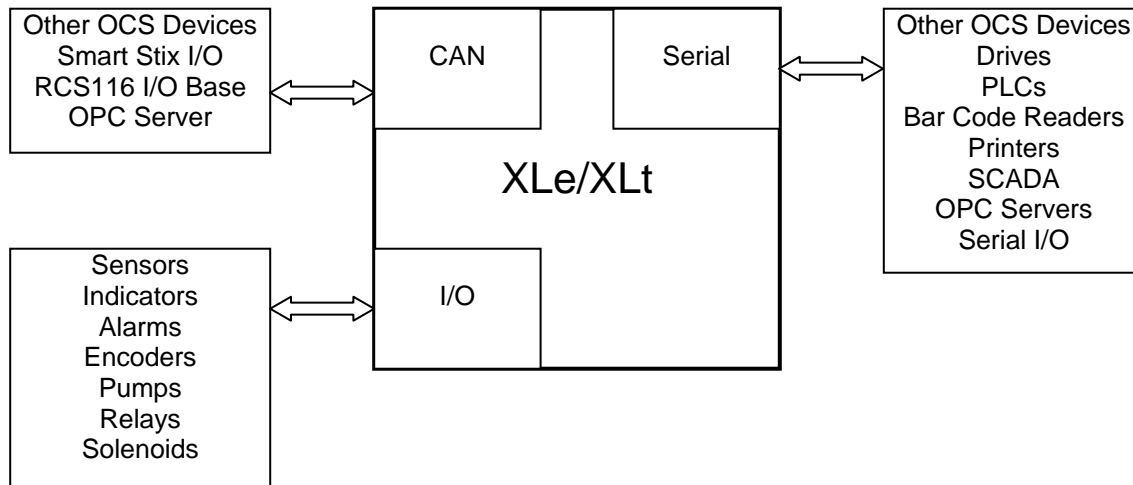

Figure 2-2 – Visual Overview of Types of Devices that can be connected to XLe/XLt

2.3 Features of XLe/XLt

The XLe/XLt is an all-in-one industrial control device. It combines control, user interface, I/O and networking into a single, integrated package. Unique features of the XLe/XLt include:

- Bright, graphical LCD display (in XLe) (with touch sensing in XLt)
- Display of complex graphical objects including trends, gauges, meters and animations
- Advanced control capabilities including floating point, multiple auto-tuning PID loops and string handling capabilities
- Removable media for up to two gigabyte of storage of programs, data logging or screen captures
- CsCAN networking port (optional) for communication with remote I/O, other controllers or PCs
- Configurable serial protocols for communication to drives, PLCs, or other serial peripherals
- Full featured, built-in I/O including high resolution analog, thermocouple, RTD, high speed counters, PWM outputs and relays (depending upon the XLe/XLt model used)
- Cscape programming software that allows all aspects of the XLe/XLt to be programmed and configured from one integrated application
- Optional communication add-on modules that allow additional capabilities such as Ethernet or modems
- Fail – Safe System which allows an application to continue running in the event of “Soft” failures like (Battery power loss or Battery Backed register RAM / Application Flash corruption)
- Clone Unit allows to “clone” the OCS of the exact same model. This feature “clones” application program and unit settings stored in Battery backed RAM of an OCS. It can then be used to clone a different OCS (exact same model)

2.4 Required and Suggested Accessories

The following list contains a sampling of required and suggested XLe/XLt accessories. Visit our website (see page 96) to view updates on new products and accessories.

Note: The XLe/XLt is not shipped with a programming cable in the box. To obtain a programming cable, order HE500CBL300.

Table 2.1 – XLe/XLt Accessories	
Part Number	Description
HE-XEC	10/100 Ethernet option kit - field installable. Kit includes all parts necessary for internal installation within the XLe/XLt case, including a deeper plastic back cover adapted for Ethernet operation.
HE-XMC	14.4 k Telephone modem option kit - field installable. Kit includes all parts necessary for internal installation within the XLe/XLt case, including a deeper plastic back cover adapted for modem operation.
HE-MC1	Removable Media card - compatible with XLe/XLt. Card capacity is 256 MB or larger.
HE-MR1	Media Card Reader for HE-MC1. Portable device allows HE-MC1 to be plugged into the USB port of personal computers as a portable hard drive.
HE-X24-AS	Power supply 100-240VAC or 140-340VDC Switching supply that outputs 1.5 A / 3 A (HE-X24-AS/AL) at 24 VDC. Mounts on Standard DIN rail. Designed for X Family products.
HE-X24-AL	Power supply 100-240 VAC or 140-340 VDC Switching supply that outputs 1.5 A / 3 A (HE-X24-AS/AL) at 24VDC. Mounts on Standard DIN rail. Designed for X Family products.
HE500OSW232	Cscape Software Package. Includes Cscape CD, 9-pin OCS Programming Cable, RJ-45 Programming Cable, Documentation
HE500CBL300	OCS Programming Cable, 9-pin female (PC) to RJ-45 (OCS) - 6 feet.
HE500USB600	USB programming kit. Includes USB to RS-232 adapter, and 6-foot RS-232 cable with D-sub connections. Requires HE500CBL300 to program the XLe/XLt.

2.5 Useful Documents and References

The following information serves as a *general* listing of Horner controller products and other references of interest with their corresponding manual numbers. Visit our website (see page **96**) to obtain user documentation and updates.

Note: This list is <u>not</u> intended for users to determine which products are appropriate for their application; controller products differ in the features that they support. If assistance is required, refer to Technical Support (page 96).	
Controllers	Manual Number
XLe Series (e.g., HE-XExxx)	MAN0878
XLt Series (e.g., HE-XTxxx)	MAN0878
QX Series (e.g., HE-QXxxx)	MAN0798
NX Series (e.g., HE-NXxxx)	MAN0781
LX Series (e.g., LX-xxx; also covers RCS116)	MAN0755
Color Touch OCS (e.g., OCSxxx)	MAN0465
OCS (Operator Control Station) (e.g., OCS1xx / 2xx; Graphic OCS250)	MAN0227
Remote Control Station (e.g., RCS2x0)	
MiniOCS (e.g., HE500OCSxxx, HE500RCSxxx)	MAN0305
Other Useful References	Manual Number
CAN Networks	MAN0799
Cscape Programming and Reference	MAN0313
Wiring Accessories and Spare Parts Manual	MAN0347

CHAPTER 3: MECHANICAL INSTALLATION

Note: Each XLe/XLt unit is sent with a datasheet in the box. **The datasheet is the first document you need to refer to for model-specific information related to XLe/XLt models such as pin-outs, jumper settings, and other key installation information.** The web version of this manual has all of the XLe/XLt datasheets attached to it. Visit our website (see page 96) to obtain datasheets, user documentation, and updates.

3.1 Overview

The mechanical installation greatly affects the operation, safety and appearance of the system. Information is provided to mechanically install the unit such as cut-out sizes, mounting procedures and other recommendations for the proper mechanical installation of the unit.

3.2 Mounting Requirements

XLe/XLt products can be mounted through a panel or on DIN rail.

3.2.1 Mounting Procedures (Installed in a Panel Door)

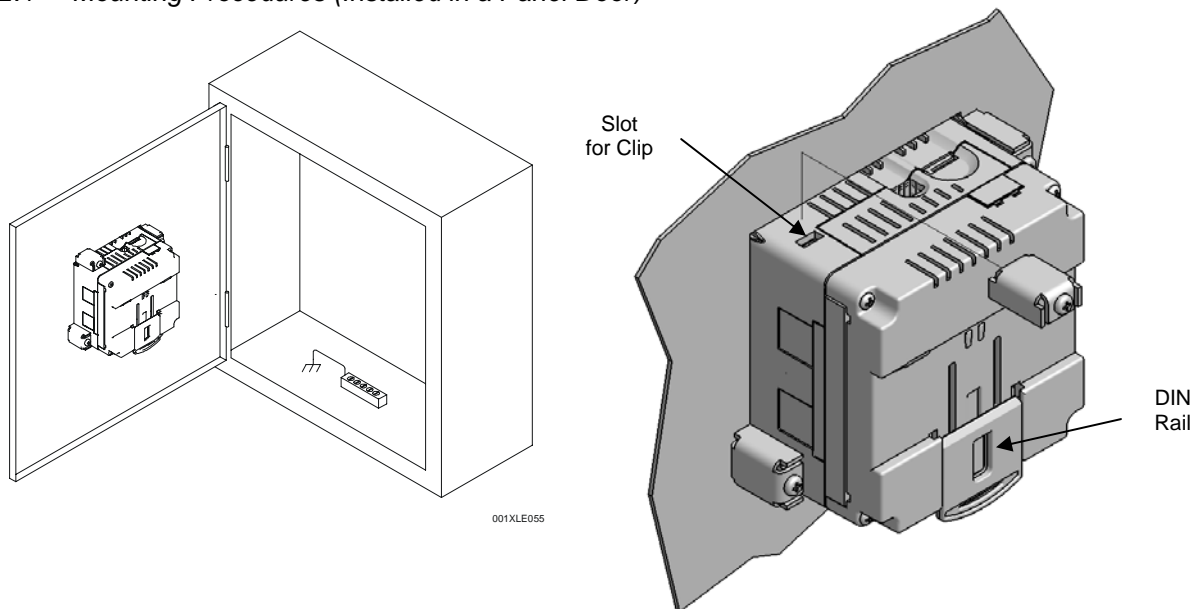

Figure 3-1 – Panel Mounting of the XLe/XLt and Close-up View of Back

Once the panel design has been completed using the criteria and suggestions in the following sections, use the following steps to panel mount the XLe/XLt.

1. Remove all connectors from the XLe/XLt unit.
2. Press the DIN rail clip up to make passing the unit through the cutout easier.
3. Make sure the gasket is installed on the XLe/XLt and is free from dust and debris. Check that the corners of the gasket are secure.
4. Pass the unit through the panel.
5. Insert the each of the four (4) mounting clips into the slots in the XLe/XLt case. One clip should be installed on each corner. Lightly tighten each screw so the clip is held in place.
6. Tighten the screws on the clips such that the gasket is compressed against the panel.

3.2.2 Mounting Procedures (Installed on DIN Rail)

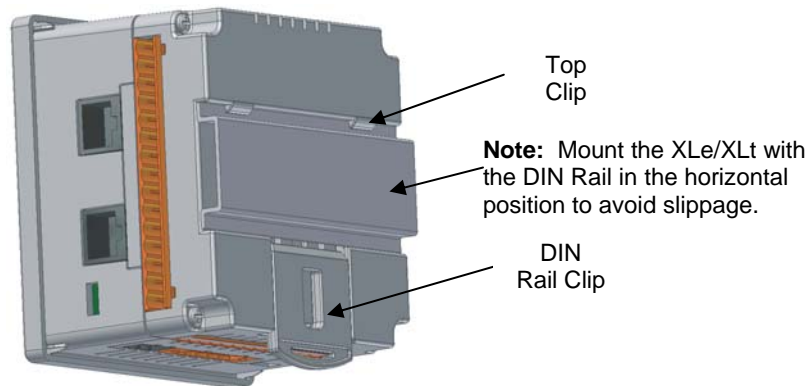

Figure 3-2 – DIN Rail Mounting of the XLe/XLt

The XLe/XLt is designed to clip onto standard 35 millimeter DIN rail. If your installation requires liquid or dust protection, make sure the XLe/XLt is placed in an appropriate sealed panel when mounting on DIN rail. Use the following steps to mount the XLe/XLt on DIN rail.

1. Move the DIN rail clip to the lower position.
2. Clip the “Top Clips” on the top of the DIN rail.
3. Press the unit into place and press the DIN rail clip up. A small flat-head screw driver can be used in the slot of the DIN rail clip if clearance is an issue.

Note: The DIN rail connection does not provide an earth ground. Refer to CHAPTER 4 for proper grounding information.

3.3 Mounting Orientation

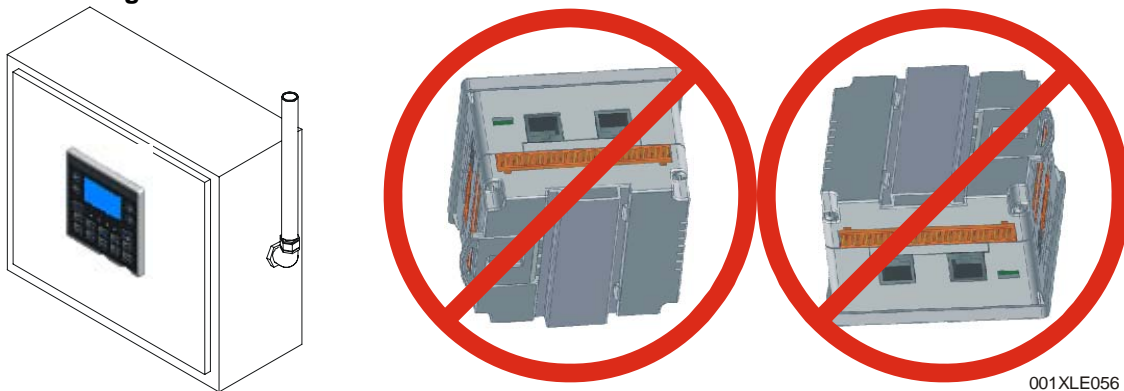

NOTE: For panel or DIN rail mounting:
The orientation shown above provides for optimum readability of the screen and ease of use of the keypad.

CAUTION: For DIN Rail mounting:
To prevent the unit from slipping off the DIN Rail, do not install the unit on its sides as shown. Be sure the DIN Rail is in the horizontal position. .

Figure 3-3 – Orientation of XLe/XLt OCS

3.4 Panel Cut-Out

For installations requiring NEMA4X liquid and dust protection the panel cutout should be cut with a tolerance of $\pm 0.005"$ (0.1 mm). The XLe/XLt is designed to fit $\frac{1}{4}$ DIN panel openings. There are a number of punches and enclosures designed to accommodate opening of this size.

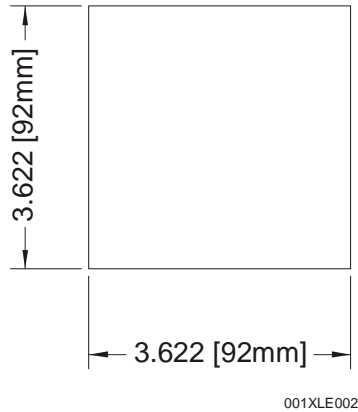

001XLE002

Figure 3-4 – XLe/XLt Panel Cut-out

3.5 Dimensions

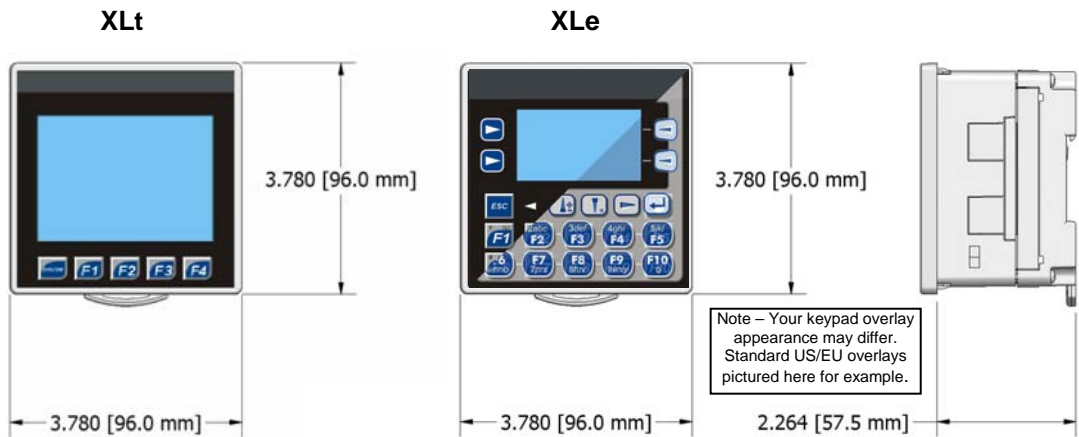

Figure 3-5 – XLe/XLt Dimensions

Note: When the communication add-on modules are installed such as Ethernet or Modem the depth of the product increases from 2.264 (57.5 mm) to 2.68 (68 mm).

3.6 Factors Affecting Panel Layout Design and Clearances

Warning: It is important to follow the requirements of the panel manufacturer and to follow all applicable electrical codes and standards.

The designer of a panel layout needs to assess the requirements of a particular system and to consider the following design factors. *A convenient checklist is provided on page 19.*

3.6.1 Clearance / Adequate Space

Install devices to allow sufficient clearance to open and close the panel door.

Table 3.1 – Minimum Clearance Requirements for Panel Box and Door	
Minimum Distance between base of device and sides of cabinet	2 inches (50.80mm)
Minimum Distance between base of device and wiring ducts	1.5 inches (38.10mm)
<u>If more than one device installed in panel box (or on door):</u> Minimum Distance between bases of each device	4 inches between bases of each device (101.60mm)
<u>When door is closed:</u> Minimum distance between device and closed door (Be sure to allow enough depth for XLe/XLt.)	2 inches (50.80mm)

3.6.2 Grounding

Warning: Be sure to meet the ground requirements of the panel manufacturer and also meet applicable electrical codes and standards.

Panel box: The panel box needs to be properly connected to earth ground to provide a good common ground reference.

Panel door: Tie a low impedance ground strap between the panel box and the panel door to ensure that they have the same ground reference.

3.6.3 Temperature / Ventilation

Ensure that the panel layout design allows for adequate ventilation and maintains the specified ambient temperature range. Consider the impact on the design of the panel layout if operating at the extreme ends of the ambient temperature range. For example, if it is determined that a cooling device is required, allow adequate space and clearances for the device in the panel box or on the panel door.

3.6.4 *Orientation*

When panel-mounted, there are no orientation restrictions on the XLe/XLt. However, the orientation shown in Figure 3-3 provides for optimum readability of the screen and ease of use of the keypad. When DIN Rail mounted, observe the orientation shown in Figure 3-2.

3.6.5 *Noise*

Consider the impact on the panel layout design and clearance requirements if noise suppression devices are needed. Be sure to maintain an adequate distance between the XLe/XLt and noisy devices such as relays, motor starters, etc.

3.6.6 *Shock and Vibration*

The XLe/XLt has been designed to operate in typical industrial environments that may inflict some shock and vibration on the unit. For applications that may inflict excessive shock and vibration please use proper dampening techniques or relocate the XLe/XLt to a location that minimizes shock and/or vibration.

3.6.7 *Panel Layout Design and Clearance Checklist*

The following list provides highlights of panel layout design factors.

- Meets the electrical code and applicable standards for proper grounding, etc.?
- Meets the panel manufacturer's requirements for grounding, etc.?
- Is the panel box properly connected to earth ground? Is the panel door properly grounded? Has the appropriate procedure been followed to properly ground the devices in the panel box and on the panel door?
- Are minimum clearance requirements met? (See **Table 3.1**.) Can the panel door be easily opened and closed? Is there adequate space between device bases as well as the sides of the panel and wiring ducts?
- Is the panel box deep enough to accommodate the XLe/XLt?
- Is there adequate ventilation? Is the ambient temperature range maintained? Are cooling or heating devices required?
- Are noise suppression devices or isolation transformers required? Is there adequate distance between the base of the XLe/XLt and noisy devices such as relays or motor starters? Ensure that power and signal wires are not routed in the same conduit.
- Are there other requirements that impact the particular system, which need to be considered?

NOTES

CHAPTER 4: ELECTRICAL INSTALLATION

Note: Each XLe/XLt unit is sent with a datasheet in the box. **The datasheet is the first document you need to refer to for model-specific information related to XLe/XLt models such as pin-outs, jumper settings, and other key installation information.** The web version of this manual has all of the XLe/XLt datasheets attached to it. Visit our website (see page 96) to obtain datasheets, user documentation, and updates.

4.1 Grounding Definition

Ground: The term **Ground** is defined as a conductive connection between a circuit or piece of equipment and the earth. Grounds are fundamentally used to protect an application from harmful interference causing either physical damage such as by lightning or voltage transients or from circuit disruption often caused by radio frequency interference (RFI).

4.2 Ground Specifications

Ideally, a ground resistance measurement from equipment to earth ground is 0 ohms. In reality it typically is higher. The U.S. National Electrical Code (NEC) states the resistance to ground shall not exceed 25 ohms. Horner APG recommends less than 15 ohms resistance from our equipment to ground. Resistance greater than 25 ohms can cause undesirable or harmful interference to the device.

4.3 How to Test for Good Ground

In order to test ground resistance, a Ground Resistance Tester must be used. A typical Ground Resistance Meter Kit contains a meter, two or three wire leads, and two ground rods. Instructions are supplied for either a two-point or three-point ground test. **Figure 4-1** shows a two-point ground connection test.

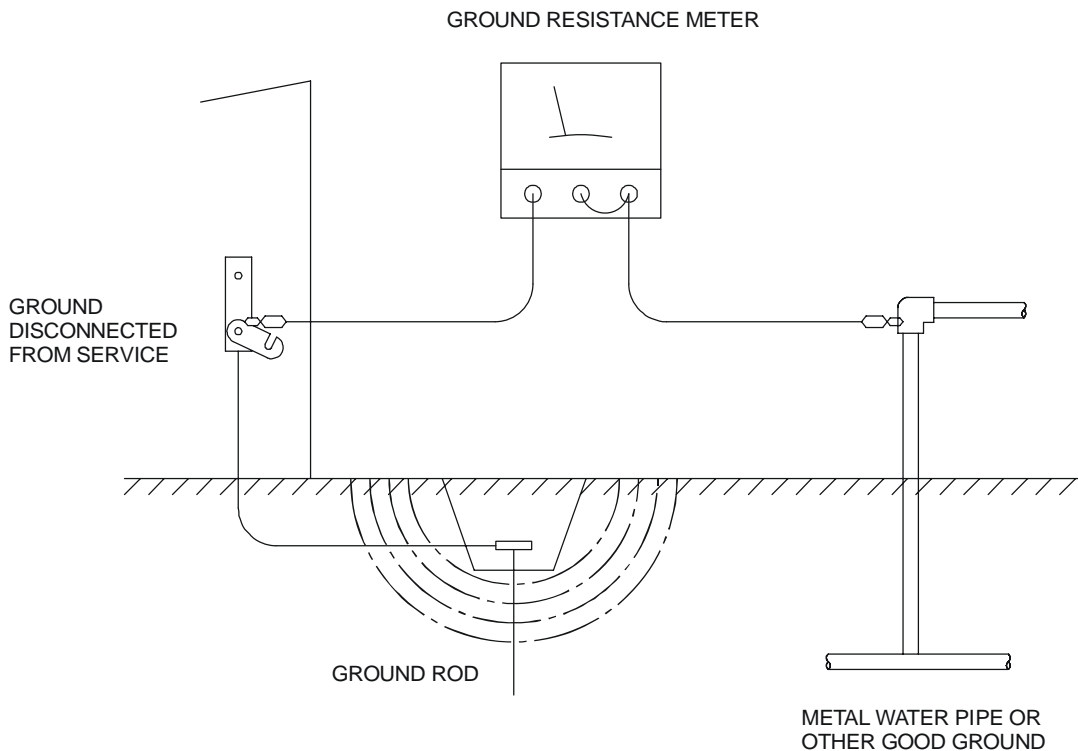



Figure 4-1 – Two-Point Ground Connection Test

4.4 Primary Power Port

Table 4.1 – Primary Power Port Pins		
Pin	Signal	Description
1		Frame Ground
2	0V	Input power supply ground
3	+24V	Input power supply positive voltage

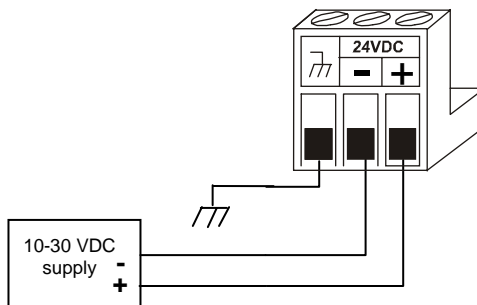

Figure 4-2 – Power Connector (Primary Power Port)

Power Connector

Power Up:
 Connect to Earth Ground.
 Apply 10 – 30 VDC.
 Screen lights up.
 Torque rating 4.5 - 7 Lb-In
 (0.50 – 0.78 N-m)

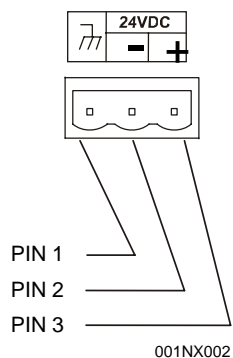

Figure 4-3 – As Viewed Looking at the XLe/XLt

CHAPTER 5: SERIAL COMMUNICATIONS

5.1 Overview

All XLe/XLt models provide two serial ports, which are implemented with 8-pin modular RJ45 connectors, and are labeled **MJ1** and **MJ2**. The MJ1 serial port is normally used for XLe/XLt programming by connecting it to the COM port of a PC running Cscope. In addition, both MJ1 and MJ2 can be used for application-specific communication, using a variety of standard data exchange protocols.

5.2 Port Descriptions

The MJ1 serial port contains both a half-duplex RS-485 interface and an RS-232 interface with RTS/CTS handshaking. **Note: MJ1 shares its serial port with the optional COM module, so when an optional Ethernet or Modem COM module is installed and active, the MJ1 connector is inactive.**

The MJ2 serial port contains both a full-duplex RS-485 interface and an RS-232 interface with no handshaking. Both the MJ1 and MJ2 RS-485 interfaces provide switchable termination and bias resistors internally.

5.3 Wiring

Figure 5-1 along with Table 5.1 and Table 5.2 show how the MJ1 and MJ2 serial port pins are assigned.

Note: MJ1 and MJ2 look the same but have different pin assignments and functions.

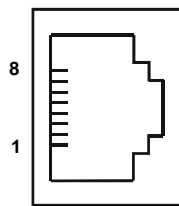
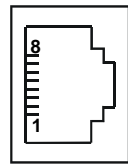

Figure 5-1 – MJ Serial Port Connector



Pin	MJ1 Pins		MJ2 Pins	
	Signal	Direction	Signal	Direction
8	TXD	OUT	TXD	OUT
7	RXD	IN	RXD	IN
6	0 V	Ground	0 V	Ground
5*	+5 60mA	OUT	+5 60mA	OUT
4	RTS	OUT	TX-	OUT
3	CTS	IN	TX+	OUT
2	RX-/TX-	IN/OUT	RX-	IN
1	RX+/TX+	IN/OUT	RX+	IN

Pin	Signal	Signal Description	Direction
1	RX/TX+	RS-485 Receive/Transmit Positive	In/Out
2	RX/TX-	RS-485 Receive/Transmit Negative	In/Out
3	CTS ¹	RS-232 Clear to Send	Out
4	RTS ¹	RS-232 Request to Send	In
5	+5*	+5 Vdc 60mA max	Out
6	0V	Ground	-
7	TD ¹	RS-232 Transmit Data	In
8	RD ¹	RS-232 Receive Data	Out

- * +5 on XLe Rev E and later
- * +5 on all revisions XLT

Pin	Signal	Signal Description	Direction
1	RX+	RS-485 Receive Positive	In
2	RX-	RS-485 Receive Negative	In
3	TX+	RS-485 Transmit Positive	Out
4	TX-	RS-485 Transmit Negative	Out
5	+5*	+5 Vdc 60mA max	Out
6	0V	Ground	-
7	TD ¹	RS-232 Transmit Data	In
8	RD ¹	RS-232 Receive Data	Out

¹Signals are labeled for connection to a DTE device

MJ2 Pinouts in Full and Half Duplex Modes

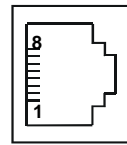

Pin	MJ2 Pins	
	Signal	Direction
8	TXD	OUT
7	RXD	IN
6	0 V	Ground
5*	+5 60mA	OUT
4	TX-	OUT
3	TX+	OUT
2	TX-/RX-	IN/OUT
1	TX+/RX+	IN/OUT

* +5Vdc 60mA Max

MJ2 Half Duplex Mode

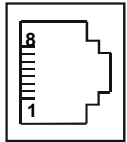

Pin	MJ2 Pins	
	Signal	Direction
8	TXD	OUT
7	RXD	IN
6	0 V	Ground
5*	+5 60mA	OUT
4	TX-	OUT
3	TX+	OUT
2	RX-	IN
1	RX+	IN

* +5Vdc 60mA Max

MJ2 Full Duplex Mode

5.4 RS-485 Termination

Proper RS-485 termination minimizes reflections and improves reliability.

Both serial ports allow an internal 121-Ohm RS-485 termination resistor to be placed across pins 1 and 2. This can be done by installing a jumper. Please refer to the XLe/XLt data sheet for jumper locations.

In any case, only the two devices physically located at the endpoints of the RS-485 network should be terminated.

5.5 RS-485 Biasing

RS-485 biasing passively asserts a line-idle state when no device is actively transmitting, which is useful for multi-drop RS-485 networking.

Both serial ports allow internal 390-Ohm RS-485 bias resistors to be switched in, pulling pin 1 up to 3.3V and pulling pin 2 down to ground. The Set Serial Ports item in the System Menu (see page 51) can be used to enable RS-485 biasing. Also, an application graphics screen that writes to %SR164 can do the same thing. Setting %SR164.1 enables MJ1 biasing and setting %SR164.2 enables MJ2 biasing.

If biasing is used, it should be enabled in only one of the devices attached to the RS-485 network.

5.6 Cscape Programming via Serial Port

The XLe/XLt MJ1 serial port supports CsCAN Programming Protocol, but MJ2 does not. If a PC COM port is connected to the XLe/XLt MJ1 serial port, Cscape can access the XLe/XLt for programming and monitoring.

5.7 Ladder-Controlled Serial Communication

Using Serial Communication function blocks, both MJ1 and MJ2 support Generic, Modbus Master and Modbus Slave Protocols. In addition, external modems can be connected and accessed using Init, Dial and Answer Modem function blocks.

5.8 Downloadable Serial Communication Protocols

Both MJ1 and MJ2 also support downloadable protocols, such as Allen Bradley DF1, CsCAN Master, GE Fanuc SNP and Modbus Master.

CHAPTER 6: CAN COMMUNICATIONS

Note: For additional CAN information, refer to the CAN Networks manual (MAN0799) on our website. (See page 96 for our website address.)

6.1 Overview

Some XLe/XLt models (XE1xx) provide a CAN networking port, which is implemented with a 5-pin connector, labeled **NET1**.

Like the MJ1 serial port, the NET1 port can be used for XLe/XLt programming by connecting it to the CAN port of a PC running Cscope. The NET1 port also allows the XLe/XLt to exchange global data with other OCS/RCS controllers and to access remote Network I/O devices (SmartStix Modules).

6.2 Port Description

The XLe/XLt NET1 port implements the ISO 11898-2 physical layer and the CAN 2.0A data link layer standards. Also, since the NET1 port is powered by an internal isolated power supply, external CAN power is not required.

6.3 Wiring

Figure 6-1 and Table 6.1 show how the NET1 port pins are assigned.

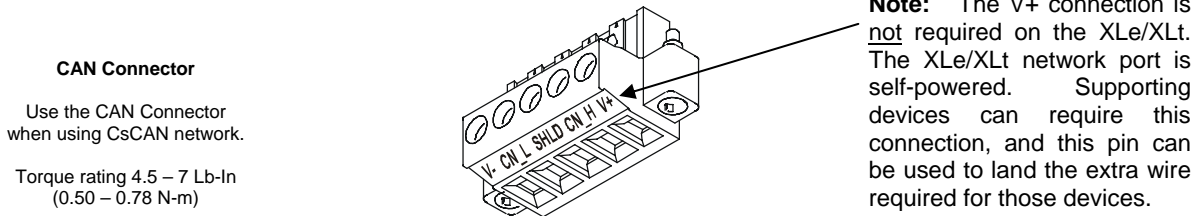

Figure 6-1 – NET1 Port Connector

Table 6.1 – NET1 Port Pin Assignments			
Pin	Signal	Signal Description	Direction
1	V-	CAN Ground	–
2	CN_L	CAN Data Low	In/Out
3	SHLD	Shield Ground	–
4	CN_H	CAN Data High	In/Out
5	NC	No Connect	–

6.4 Cscape Programming via CAN

The NET1 port supports CsCAN Programming Protocol. If a PC has a CAN interface installed (via PCI card or USB), and the PC CAN port is connected to the XLe/XLt NET1 port, Cscape can access the XLe/XLt for programming and monitoring.

In addition, the XLe/XLt supports single-point-programming of all XLe/XLt and other OCS/RCS devices that are connected to a CAN network. If the PC COM port is connected to the XLe/XLt MJ1 serial port (see CHAPTER 5), the XLe/XLt can act as a pass-through gateway allowing Cscape to access all XLe/XLt and OCS/RCS devices that are attached to the CAN network.

6.5 Ladder-Controlled CAN Communication

Using Put and Get Network Words function blocks, the NET1 port can exchange digital and analog global data with other XLe/XLt or OCS/RCS devices (nodes) attached to the CAN network.

In addition, Put and Get Network Heartbeat function blocks allow nodes on the CAN network to regularly announce their presence and to detect the presence (or absence) of other nodes on the network.

6.6 Using CAN for I/O Expansion (Network I/O)

Connecting Network I/O devices (SmartStix Modules) to the XLe/XLt NET1 port, allows the XLe/XLt I/O to be economically expanded and distributed. A variety of SmartStix Modules is available for this purpose.

CHAPTER 7: COMMUNICATION OPTIONS

7.1 Overview

To supplement the built-in MJ1 and MJ2 serial ports (see CHAPTER 5), additional communication options are available. This is accomplished by installing a COM module internal to the XLe/XLt controller. Currently, there are two COM modules available for this purpose: Ethernet (XEC) and Modem (XMC).

7.1.1 MJ1 shares its serial port with the optional COM module, so when an Ethernet or Modem COM module is installed and active, the MJ1 connector is inactive.

Internal to the XLe/XLt, there is a CPU board, and up to two installed modules. Models XE000/XT000 and XE100/XT100 have no installed I/O or COM modules. All other models have an I/O module in Slot 1 and can have a user-installed COM module in Slot 2.

This chapter briefly describes both the Ethernet and Modem COM module options. For detailed information regarding these modules, please refer to the individual documents provided with the modules.

7.2 Ethernet COM Module (XEC) Option

An Ethernet COM module can be installed to allow Cscape programming of an XLe/XLt over a Local Area Network or over the Internet. In addition, the Horner OPC Server can be installed on a PC to allow other standard PC applications (such as database and spreadsheets programs) access to XLe/XLt register data.

The Ethernet COM module supports both 10 BaseT (10 MHz) and 100 BaseTx (100 MHz) as well as both half and full duplex communication. Both the connection speed and the duplex are auto-negotiated.

Although the physical connection between the Ethernet COM Module and the Local Area Network is done using a standard Ethernet cable (CAT5 or better with RJ45 modular plug), a **Serial Port Tunnel** protocol is employed that makes the Ethernet COM Module appear as a serial port to Cscape or OPC Server software running on the PC.

On the XLe/XLt end of the Serial Port Tunnel, the Ethernet COM module should be properly configured using the XLe/XLt System Menu (see CHAPTER 11). This configuration consists of making Ethernet the Default Programming Port and setting its target IP Address, Net Mask and optionally the Gateway IP Address. The Gateway IP Address is required if the XLe/XLt will be accessed from outside the Local Area Network (e.g. the Internet).

On the PC end of the Serial Port Tunnel, the PC should be connected to the Local Area Network (or to the Internet) and a **Com Port Redirector** driver must be installed on the PC and properly configured. The Com Port Redirector allows multiple "virtual" PC serial ports to be created and each one can be assigned to a different target device IP Address, thus allowing access to Ethernet COM modules in multiple XLe/XLt controllers.

After installing and configuring both the Ethernet COM module and the Com Port Redirector, Cscape or OPC Server software should be set up to communicate to one of the "virtual" serial ports, at which point they should function as if a "real" PC serial port was connected to the XLe/XLt MJ1 serial port.

7.3 Modem COM Module (XMC) Option

A Modem COM module can be installed to allow Cscape programming of an XLe/XLt over a dial-up network. In addition, the application ladder program can take control of the modem for application-specific modem communication.

The Modem COM module supports the standard AT command set and can connect to the dial-up network at speeds up to 14.4 KBaud. Connection speed is auto-negotiated. The Modem COM module connects to the dial-up network (phone line) via a cable with a standard RJ11 modular plug.

To enable Cscape programming via a dial-up network, the Modem COM module should first be configured as the Default Programming Port, using the XLe/XLt System Menu (see CHAPTER 11). Doing this puts the Modem COM module in auto-answer mode, so Cscape can call the XLe/XLt via a remote modem.

To program the ladder application to communicate via the Modem COM module, standard Cscape Serial and Modem function blocks can be used.

CHAPTER 8: REMOVABLE MEDIA

8.1 Overview

All XLe/XLt models provide a Removable Media slot, labeled **Memory**, which supports standard Micro SD Flash memory cards. Micro SD cards can be used to save and load applications, to capture graphics screens and to log data for later retrieval.

8.2 Micro SD Cards

When the Micro SD card format was introduced, it was originally called TransFlash. Cards labeled either Micro SD or TransFlash, with up to 2.0 GB of Flash memory, are compatible with the XLe/XLt Memory slot.

The XLe/XLt Memory slot is equipped with a “push-in, push-out” connector and a Micro SD card can be safely inserted into the Memory slot whether the XLe/XLt power is On or Off.

To install a Micro SD card: Align its 8-pin gold edge connector down, facing the front of the XLe/XLt unit as shown in **Figure 8-1**; then carefully push it all the way into the Memory slot. Ensure that it clicks into place.

To remove the Micro SD card: Push down on the top of the card gently to release the spring. The card pops up for removal.

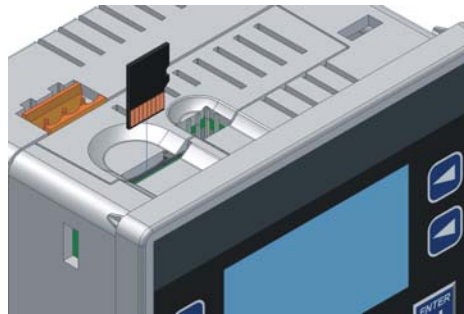

Figure 8-1 – Installing Removable Memory Card

8.3 Micro SD File System

The XLe/XLt Micro SD Memory slot uses the PC-compatible FAT16 File System. This means that a PC, with a Micro SD-compatible card reader, can read files that have been written by the XLe/XLt and can write files that can be read by the XLe/XLt.

However, the XLe/XLt does not support long filenames, but instead implements the 8.3 filename format. This means that all file and directory names must consist of up to 8 characters, followed by an optional dot, and an optional extension with up to 3 characters.

Directories and sub-directories can be nested up to 16 levels deep as long as each pathname string does not exceed 147 characters.

8.4 Using the Removable Media Manager

The Removable Media Manager is an interactive XLe/XLt screen that performs the following functions:

- Display number of total and free bytes
- Browse file and directory lists
- Delete files and directories
- Format a Micro SD card
- Load and save application programs
- View screen capture bitmaps

The Removable Media Manager can be accessed via the System Menu (see CHAPTER 11) or by using Cscape to place a Removable Media Manager object on an application graphics screen.

8.5 Using Removable Media to Log Data

Using Read and Write Removable Media function blocks, an application ladder program can read and write XLe/XLt register data in the form of comma-delimited files, with a .CSV extension. These files are compatible with standard database and spreadsheet PC programs. In addition, an application ladder program can use Rename and Delete Removable Media function blocks to rename and delete files.

8.6 Using Removable Media to Load and Save Applications

A special file type, with a .PGM extension, is used to store XLe/XLt application programs on Micro SD.

To load an application from Micro SD to the XLe/XLt, use the Removable Media Manager to find and highlight the desired .PGM file, and then press **Enter**.

To save an application from the **XLe** to Micro SD, open the Removable Media Manager in the System Menu and press the F4 function key. The application will be saved in a file called **DEFAULT.PGM** in the Micro SD root directory.

To save an application from the **XLt** to Micro SD, open the Removable Media Manager in System Menu and press the **Save Pgm**  soft key displayed at the bottom of the XLt's touch screen. The application will be saved in a file called **DEFAULT.PGM** in the Micro SD root directory.

Note: Saving an application to Micro SD can only be done from the System Menu and is not available on a Removable Media Manager object that was placed on an application graphics screen by Cscape.

Cscape can also save an application directly to a Micro SD card, which is plugged into the PC's Micro SD compatible card reader by selecting the Export to Removable Media item on the **File** menu.

8.7 Using Removable Media to View and Capture Screens

The XLe/XLt File System uses bitmap files with the .BMP (.bmp) extension to store XLe/XLt graphic screen captures.

To view a captured XLe/XLt screen, use the Removable Media Manager to find and highlight the desired .BMP file, and then press **Enter**.

To capture an XLe/XLt screen, turning On the assigned **Screen Capture Control Register** will capture the current XLe/XLt graphics screen and write it to the Micro SD card using the assigned **Screen Capture Filename**.

Before capturing an XLe/XLt screen, Cscape must first be used to assign a **Screen Capture Control Register** and **Filename** in the application. To do this, first open the Graphics Editor by selecting the **View / Edit Screens** item on the Cscape **Screens** menu. Next select the **Screen Capture** item of the Graphics Editor Config menu and then enter a **Control Register** and **Filename**.

NOTES

CHAPTER 9: GENERAL I/O

Note: Each XLe/XLt unit is sent with a datasheet in the box. The datasheet is the first document you need to refer to for model-specific information related to XLe/XLt models such as pin-outs, jumper settings, and other key installation information. The web version of this manual has all of the XLe/XLt datasheets attached to it. Visit our website (see page 96) to obtain datasheets, user documentation, and updates.

9.1 Overview

The XLe/XLt is a compact unit that contains high density, very versatile I/O. Using the I/O properly requires wiring to the proper terminals, configuring jumpers inside the XLe/XLt unit and configuring Cscape properly. This section will offer some tips and suggestions to configure the I/O properly. For the register mapping of the I/O, refer to CHAPTER 13.

9.2 Removing the XLe/XLt Back Cover

Warning: Power, including I/O power *must be removed* from the unit prior to removing the back cover. Failure to do so could result in electrocution and/or damage to equipment.

Some I/O configurations require jumper settings to be changed inside the XLe/XLt unit. Examples of these settings are setting positive or negative logic on digital inputs or setting current or voltage on analog inputs.

Each XLe/XLt I/O jumper is set to a factory default. Refer to the data sheet for your XLe/XLt model to find the default setting to determine if a jumper change is necessary for your application.

To remove the back cover of the XLe/XLt, remove the four (4) Phillips screws from the back of the unit. It may help to place the XLe/XLt unit face down on a clean work surface. Once the four screws are removed the back cover can be lifted straight off.

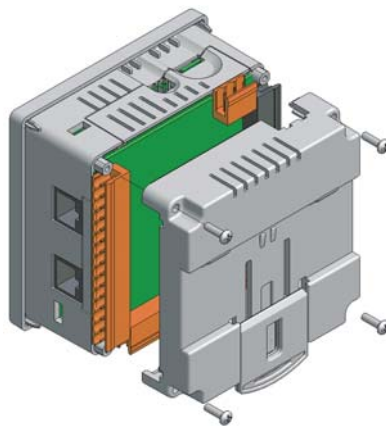

Figure 9-1 – Removing the Back Cover

Once the back is removed the jumper selection can be changed. The jumper settings are documented on each data sheet using a diagram such as Figure 9.2 below and a description of the jumper settings.

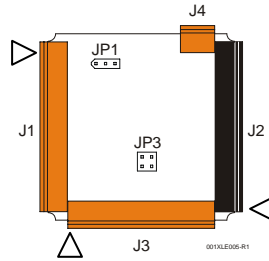

Figure 9-2 – Example Jumper Diagram

To re-install the back cover, place the cover back on the unit. The DIN clip should be on the same side as the power connector.

Place the screw back into the hole and turn the screw slowly counter clockwise until it clicks into the threads. This prevents the screw from being cross-threaded. Now turn the screw clock-wise until the cover is firmly secured. Repeat this process for all four (4) screws.

9.3 Model and I/O Overview

Table 9.1 – I/O and Model Overview						
Model (XLe or XLt)	Solid State Digital Outputs	Relay Outputs	Digital Inputs	Analog Inputs	Universal Analog Inputs	Analog Outputs
HEXxxx0						
HEXxxx2		✓	✓	✓		
HEXxxx3	✓		✓	✓		
HEXxxx4	✓		✓	✓		
HEXxxx5	✓		✓		✓	✓

Table 9.1 shows the different types of I/O included with the various XLe/XLt models. Specific specifications, jumper settings and wiring diagrams can be found on the data sheets attached at the end of the manual. Descriptions and applications of the different type of I/O can be found below.

9.4 Solid-State Digital Outputs

Solid-state digital outputs are generally used to activate lamps, low voltage solenoids, relays and other low voltage and low current devices.

Note: The digital outputs used on the XLe/XLt are “sourcing” outputs. This means the output applies a positive voltage to the output pin when turned ON. When turned off, the output applies approximately zero volts with respect to the I/O ground.

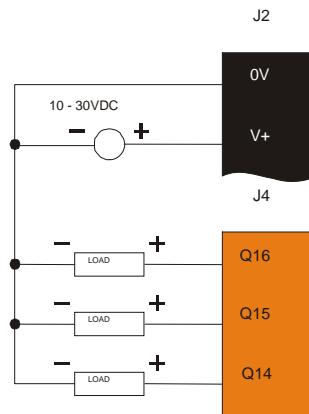

Figure 9-3 – Typical Output Wiring

The digital outputs used in the XLe/XLt have electronic short circuit protection and current limiting. While these electronic protections work in most applications, some application may require external fusing on these outputs.

The digital outputs in the XLe/XLt are typically controlled via %Q bits in the register mapping. Some of the outputs are designed for high-speed applications and can be used for PWM or frequency output applications. Please see the data sheet and the chapter on High Speed I/O for additional information.

When the controller is stopped the operation of each output is configurable. The outputs can hold the state they were in before the controller stopped or they can go to a predetermined state. By default digital outputs turn off. For more information on stop state see configuration (Chapter 14) for Cscope settings.

The digital outputs feature an output fault bit. %I32 will turn on if any of the outputs experience a short circuit, over-current or the output driver overheats.

9.5 Relay Outputs

Relay outputs are designed to switch loads that typically have high voltage or current requirements or require isolation that relays provide.

Note: The design of the XLe/XLt does not require external coil power for the relays to function. The relays will activate anytime the XLe/XLt is powered.

There are several factors that should be considered when using relays.

Relay Life – Relays are mechanical devices that have a long but limited life. Typically switching more current limits the life of relays. Please check the data sheets at the end of this manual for expected relay life.

Current / Temperature De-Rating – Products containing relays often have total current limits based on the ambient temperature of the application. Please see the product data sheet for current / temperature de-rating information for relays.

Fusing – External fusing is generally required to protect the relays, devices and wiring from shorts or overloads.

Warning: To protect the module and associated wiring from load faults, use external **(5 A)** fuse(s) as shown. Fuses of lower current or fusing for the entire system need to be in place to assure the maximum current rating of the unit is not exceeded.

Warning: Connecting high voltage to any I/O pin can cause high voltage to appear at other I/O pins.

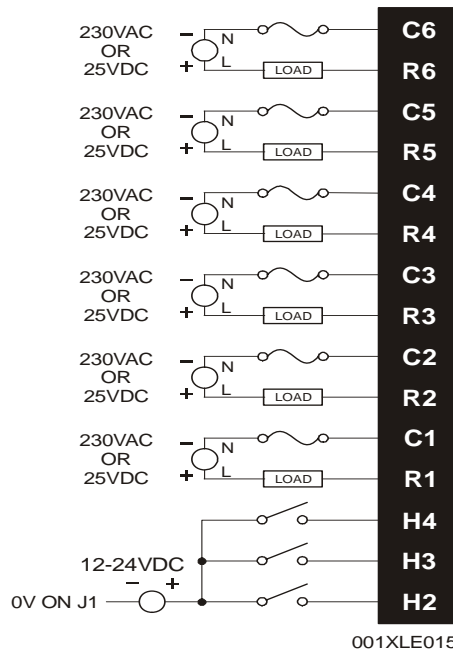

Figure 9.4 - Relay Fusing

Protection for Inductive Loads – Inductive loads can cause reverse currents when they shut off that can shorten the life of relay contacts. Some protective measures need to be determined by an engineer. Below you will find recommendations that will work for many applications. If you have additional questions on protection from inductive load, consult an application engineer or HEAPG Technical Support.

DC Loads – General purpose diode (IN4004) in reverse bias across the load.

AC Load – MOV (Harris V140xxx for 120V, V275xx for 220V)

Output State on Controller Stop

When the controller is stopped the operation of each output is configurable. The outputs can hold the state they were in before the controller stopped or they can go to a predetermined state. By default relay outputs turn off. For more information on stop state see configuration (Chapter 14) for Cscape settings.

9.6 Digital Inputs

Note: See CHAPTER 10 for high speed I/O information and refer to the datasheet for XLe/XLt model you are using for details on jumper settings.

Note: The digital inputs on the XLe/XLt are designed for low voltage DC inputs. The inputs are designed to support both positive and negative input modes. The mode is set by a jumper setting and a configuration parameter in Cscape. All the inputs on the unit must be configured to the same mode.

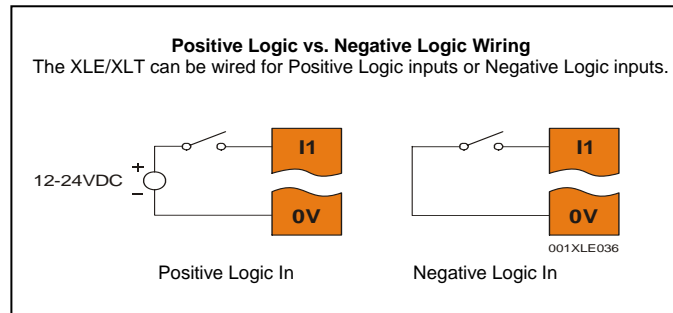

Figure 9.5 – Positive and Negative Inputs

In positive logic mode a positive voltage applied to the input will turn the input. The internal design of this mode is basically a resistor from the input to I/O ground. This mode is sometimes called sourcing.

In negative logic mode, connecting the input to the I/O ground or zero volts will turn the input on. The internal design of this mode is basically a resistor from the input to the positive I/O voltage (usually 12 or 24 volts). This mode is sometime called sinking.

Some of the digital inputs may support high speed input functional such as counting or frequency measurement.

9.7 Analog Inputs

Note: See the data sheet for the XLe/XLt model you are using for jumper settings and CHAPTER 14 for details on how to use Cscape to configure the digital filtering.

The analog inputs on the XLe/XLt allow voltage or current measurement from a variety of devices. The voltage or current mode is set though jumpers on the unit and settings in Cscape. Each channel can be separately configured for voltage or current mode.

The analog inputs have a digital filter that can be used to filter electrical noise that may be unavoidable in some installations. The downside to digital filtering is the inputs will respond more slowly to sudden changes in the actual input.

9.8 Universal Analog Inputs

Note: See the data sheet for the XLe/XLt model you are using for jumper settings and CHAPTER 14 for details on how to use Cscape to configure the digital filtering.

The universal analog inputs provide a high resolution, very flexible interface for a variety of analog inputs. These inputs include voltage, current, thermocouple, RTD and millivolt. Each channel can be configured separately using jumpers and configuration settings in Cscape.

Like the standard analog inputs, these inputs have a digital filter that can be used to filter electrical noise that may be unavoidable in some installations. The downside to digital filtering is the inputs will respond more slowly to sudden changes in the actual input.

9.9 Analog Outputs

Note: See CHAPTER 10 for high speed I/O information and refer to the datasheet for XLe/XLt model you are using for details on jumper settings.

The analog outputs on XLe/XLt devices provide high resolution voltage or current outputs. The voltage or current selection is controlled with jumpers and configuration settings in Cscape. Note that each channel can be separately configured for voltage or current mode.

When the controller is stopped the operation of each output is configurable. The outputs can hold the state they were in before the controller stopped or they can go to a predetermined value. By default analog outputs are set to a value of zero. For more information on Stop State, see CHAPTER 14 for the configuration chapter for Cscape settings.

CHAPTER 10: HIGH SPEED I/O (HSC / PWM)

10.1 Overview

In addition to the compliment of simple analog and digital I/O, several of the XLe/XLt I/O modules support High Speed Counting (HSC) I/O functions and may also support Pulse Width Modulation (PWM) Output functions. The HSC functions include: frequency, totalizing, pulse width and quadrature measurement. The PWM functions include: traditional PWM (with variable rate and duty) and a stepper (limited functionality) with variable acceleration and deceleration rates. To determine function availability, refer to the associated model's Specification/Installation sheet (Digital DC Input/Output sections).

This chapter describes the operation of these high level I/O functions. For configuration details of these functions, see Cscape Configuration (page 71).

10.2 High Speed Counter (HSC) Functions

On units that support the HSC, four dedicated inputs are available than can be configured for one of four modes of operation. Those modes are Frequency, Count (totalize), Pulse width or period (pulse) and Quadrature measurement. For some modes, more than one HSC input may be consumed. The measurement value is provided to ladder in a %AI register (see mapping below).

Note that while the high-speed input circuitry has a resolution of 1 μ s, measured edge transitions must not occur faster than 100 μ s for accurate measurements. Keep in mind that pulse width measurements utilize both the rising and falling edges of the waveform, thus the pulse width must exist longer than 100 μ s.

Note that the *edge* polarity selection in the mode parameter for the totalize and pulse width functions (Digital/HSC Input Configuration) assume Positive Logic regardless of the associated I/O board's jumper setting for the *Digital DC inputs polarity*. If Negative logic is configured when using these functions, the opposite edge polarity must be selected in the mode parameter.

10.2.1 Frequency

In frequency mode, the frequency of the input signal is written to the accumulator in terms of Hertz (cycles/second). When using frequency mode, four update selections are provided which specify the width of the sample window. Note that selecting a shorter sample window provides a quicker measurement (faster response) but lowers the frequency accuracy (resolution) and increases the minimum frequency measurement limit.

10.2.2 Totalize

In totalize mode, the accumulator is simply incremented each time the input transitions in a specific direction. Totalize mode is configurable to specify the edge (rising or falling) on which the accumulator is incremented.

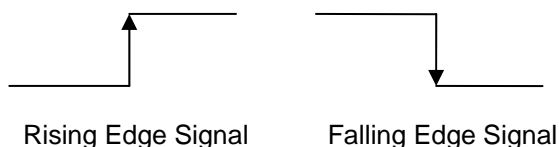

Three different options are available to reset the current count. They are:

- **Configured reset value**
When configuring the Totalize function, a value may be specified under the *Counts per Rev* column. When the totalizer accumulator reaches this value - 1, the accumulator will reset to zero on the next count. Specifying zero for this value allows the totalizer to count through the full 32-bit range before resetting.
- **Ladder control**
Setting registers %Q17-20 reset HSC1-4 (respectively) with no additional configuration. When these registers are asserted, the associated totalizer accumulator is reset and held at zero (level sensitive). See also Section 10.6.
- **Direct digital input control (HSC1 and HSC2 only)**
HSC3 (%I11) and HSC4 (%I12) may be configured as hardware digital reset signals for HSC1 and HSC2 (respectively). To enable these inputs as reset signals, specify the type as *Totalize Reset* (note that the corresponding Totalize HSC must be previously configured before this option is available). The direct digital reset controls are edge sensitive with the edge polarity configurable.

Maximum direct digital reset latency is 100 μ s.

The totalize function also supports an option which compares the current accumulator value with a supplied Preset Value (PV), which is provided through a %AQ, and drives a physical digital output based on the that comparison.

- This option (available for HSC1 and HSC2 only) drives Q1 or Q2 output point (respectively) once the associated totalizer accumulator reaches (or exceeds) the PV value. To enable this function, the corresponding PWM function output (Q1 or Q2) must be configured for *HSCx Output*.

Note that Q1 and Q2 are PWM function outputs that may be configured independently as one of the following: standard digital output, PWM, HSCx or stepper output.

Preset values may be modified during run-time. A preset value of zero disables (resets) the totalizer compare function output causing the output to remain low.

10.2.3 Pulse

In pulse mode, the high-speed input can measure the width or period of a pulse stream in one of four modes and provides a continuous indication of the last sampled value.

Width High 1 μ s Counts – In this sub-mode the accumulator value will contain the number of 1 μ s counts the pulse is high.

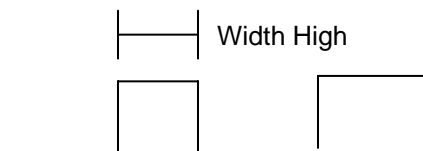

Width Low 1 μ s Counts - In this sub-mode the accumulator value will contain the number of 1 μ s counts the pulse is low.

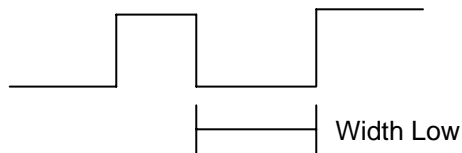

Period Rising Edges 1 μ s Counts – In this sub-mode the period of the input signal is reported in one (1) μ s units. The period measurement will start on the rising edge of the input.

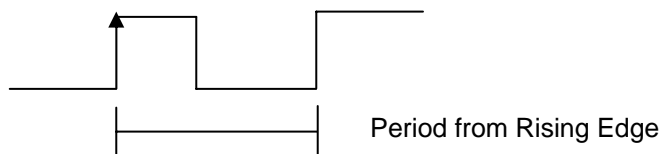

Period Falling Edges 1 μ s Counts – In this sub-mode the period of the input signal is reported in one (1) μ s units. The period measurement will start on the falling edge of the input.

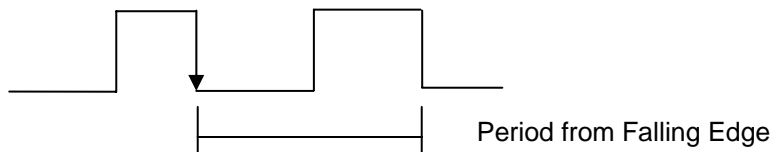

10.2.4 Quadrature

Two HSC inputs are consumed for each of the two possible Quadrature counters. For example, selecting quadrature mode for HSC 1 will use HSC inputs 1 and 2, which correspond to A and B quadrature signals. Therefore, HSC 1 and 3 may be configured for quadrature input. Alternately, HSC 3 may be configured to reset HSC1 (quadrature) count on a marker input

Quadrature mode works much like the totalizer except the accumulator will automatically increment or decrement based on the rotation phase of the two inputs. See the following example for more details. Quadrature inputs are typically used for reporting the value of an encoder.

Two modes are available for quadrature that select whether the accumulator counts up or down when the phase of input 1 leads input 2. Check your encoder's documentation to determine the output form it uses or try both modes to determine if the encoder counts up when expected.

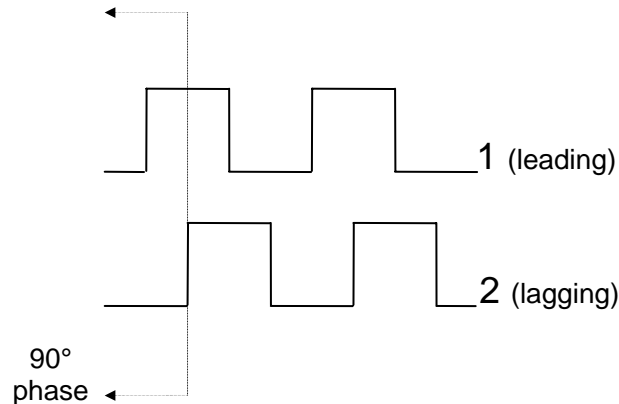

Using the above waveforms and a HSC input configuration of “Quadrature” - “1 leads 2, count up,” the accumulator will count up when 1 is rising and 2 is low, 1 is high and 2 is rising, 1 is falling and 2 is high, and when 1 is low and 2 is falling. This results in 4 counts per revolution. So in order to determine the number of cycles, the accumulator would have to be divided by 4.

Three different options are available to reset (or set) the current count. They are:

- Configured *Counts per Rev* value
When configuring the quadrature function, a value may be specified under the *Counts per Rev* column. When rotation produces an increasing count, the quadrature accumulator resets to zero on reaching the *Counts per Rev* count. Alternately, when rotation produces a decreasing count, the quadrature accumulator is set to *Counts per Rev - 1* on the count following zero. Specifying zero for this value allows the totalizer to count through the full 32-bit range before resetting.

For example if your encoder outputs 1024 counts per revolution, the value of 1024 can be entered into the configuration for *Counts per rev*. This will result in a counter that produces counts in the range of 0 to 1023.

- Ladder control
Setting registers %Q17 or Q19 resets quadrature (HSC) 1 or quadrature (HSC) 3 (respectively) with no additional configuration. Setting registers %Q18 or Q20 sets quadrature (HSC) 1 or quadrature (HSC) 3 (respectively) to *Counts per Rev - 1*.
- Direct digital input control (HSC3) [Marker]
When HSC input 1 and 2 are used for quadrature inputs, an additional choice of marker input becomes available for HSC input 3. The marker input is typically part of an encoder or motion system that signals when a cycle of motion is complete. When the marker input is triggered, the accumulator is reset to zero or to *Counts per rev - 1* based on rotation direction.

Marker reset operation is enabled when HSC3 is configured for *Marker* type. Once selected, one of several modes is available for marker operation. These modes can be sub-divided into two groups of marker operation.

Asynchronous modes ignore the quadrature inputs and reset the quadrature accumulator to zero on the configured edge (rising, falling or both). These are the most common settings used. When configuring, asynchronous mode selections are prefixed with the word *Async*.

Synchronous modes synchronize the reset (or set) to the selected quadrature input and the selected marker polarity. Figure 10.1 below indicates which mode to select based on the markers timing diagram. Consult the documentation provided with your encoder to determine the marker pulse timing.

Note that the Marker input is sampled within 50 micro seconds of the associated quadrature edge. It is left to the user to determine if this meets the time constraints of the measured drive.

Note that if the Marker input pulse consecutively spans more than one of the specified edges, quadrature-decoding operation is unpredictable.

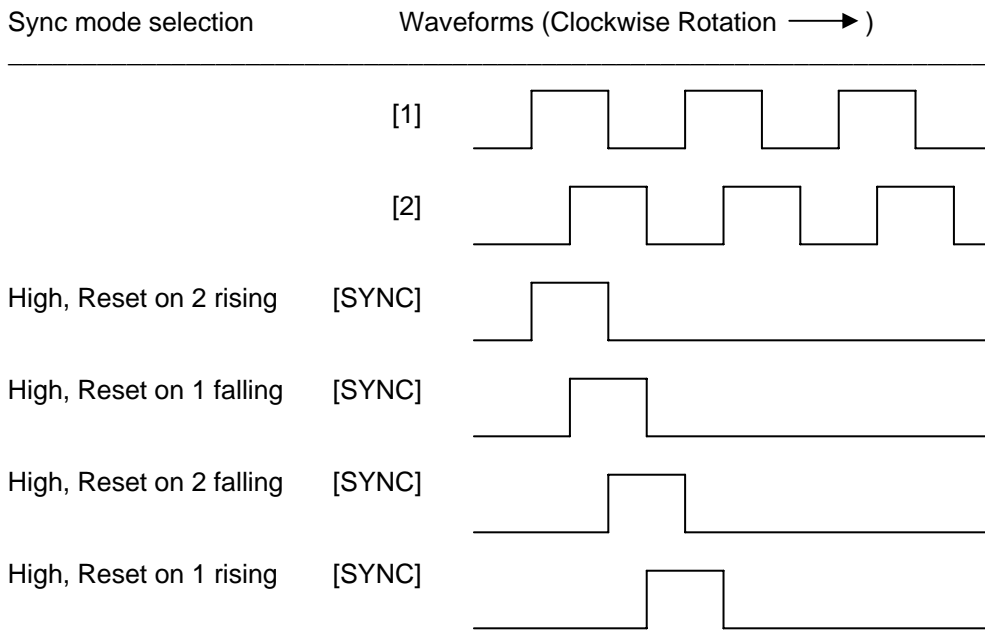

*While not displayed in this figure, modes for low level (inverse logic) are also supported for each state.

Figure 10.1 – Sync pulse mode illustration

The accumulator is reset to zero on the specified edge if rotation is clockwise (as shown in figure 10.1 above). However, if rotation is reversed, the accumulator is alternately set to *Counts per rev* – 1 on that same physical edge. When direction is reversed, that same physical edge is seen (by the internal decoder) as having the opposite edge polarity as shown below.

Mode	Direction	A (HSC1)	B (HSC2)	Marker (HSC3)	Reset Value
Async, Reset on rising edge				Rising	0
Async, Reset on falling edge				Falling	0
Async, Reset on both edge				Both	0
High, Reset on 1 rising	Clockwise	Rising		High	0
“	Counter	Falling		High	CPR - 1
Low, Reset on 1 rising	Clockwise	Rising		Low	0
“	Counter	Falling		Low	CPR - 1
High, Reset on 1 falling	Clockwise	Rising		High	CPR - 1
“	Counter	Falling		High	0
Low, Reset on 1 falling	Clockwise	Rising		Low	CPR - 1
“	Counter	Falling		Low	0
High, Reset on 2 rising	Clockwise		Rising	High	0
“	Counter		Falling	High	CPR - 1
Low, Reset on 2 rising	Clockwise		Rising	Low	0
“	Counter		Falling	Low	CPR - 1
High, Reset on 2 falling	Clockwise		Rising	High	CPR - 1
“	Counter		Falling	High	0
Low, Reset on 2 falling	Clockwise		Rising	Low	CPR - 1
“	Counter		Falling	Low	0

10.3 HSC Functions Register Map

Register	Frequency	Totalize	Pulse	Quad
%AI5-6	HSC1 (function) Accumulator			Quad 1 Acc
%AI7-8	HSC2 (function) Accumulator			
%AI9-10	HSC3 (function) Accumulator			Quad 2 Acc
%AI11-12	HSC4 (function) Accumulator			
%AQ1-2		HSC1 Preset		
%AQ3-4		HSC2 Preset		
%Q17		Clear HSC1		Clear Quad 1
%Q18		Clear HSC2		Set Quad 1
%Q19		Clear HSC3		Clear Quad 2
%Q20		Clear HSC4		Set Quad 2

10.4 Pulse Width Modulation (PWM) Functions

On units that support the PWM, two dedicated outputs are available that can be configured for one of four modes of operation. Those modes are Normal, PWM, HSC (count = PV) and Stepper.

10.4.1 Normal

When either Q1 or Q2 is configured for Normal operation, the digital output registers %Q1 and %Q2 drives that respective output.

10.4.2 PWM

When either Q1 or Q2 is configured for PWM, the PWM function drives that respective output. Both PWM channels may be individually enabled; however, when both PWM outputs are enabled, both share the same output frequency (with the low going pulses synchronized). Otherwise, each PWM's pulse width can be independently adjusted.

The PWMs require three parameters (%AQs) to be set for operation. These parameters may be set at run-time.

- Prescale Count
The prescale (%AQ5-6) count sets the resolution of the internal counter used for generating the PWM output. The (prescale count + 1) is a divisor applied to a 16MHz clock that drives the internal PWM counter. For the highest resolution PWM output, this value should be set as low as possible (0 provides a 1/16 micro second resolution). Both the Period and Duty cycle (pulse width) are based on *counts* of the internal PWM counter.

The frequency of the PWM output is calculated using the following formula:

$$\text{Frequency} = \frac{16,000,000}{(\text{PrescaleCount} + 1) \times \text{PeriodCount}}$$

- Period Count

This value (%AQ7-8) sets the period of the output signal by specifying the number of internal PWM counter *counts* before the cycle is reset (larger count results in a smaller frequency). The duration of each *count* is determined by the prescaler value. This parameter affects the Period of both PWM outputs.

See the previous formula to see how the prescale and period counts create an output frequency. For example, setting the PWM for 1 μ s resolution (prescale=15), and a period count of 20,000 would result in a 50 Hz output.

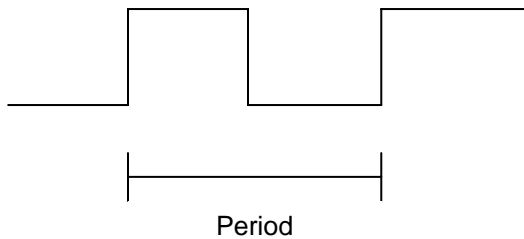

- Duty Cycle Count

This value (PWM1: %AQ1-2, PWM2: %AQ3-4) sets the width of the output signal by specifying the number of internal PWM counter *counts* that the output is maintained high. The duration of each *count* is determined by the prescaler value. Each PWM channel has its own duty cycle count parameter.

Setting the period count to 1000 and the duty cycle count to 500 results in a duty cycle of 50 percent. Changing just the duty cycle count to a value of 250 results in a duty cycle of 25 percent.

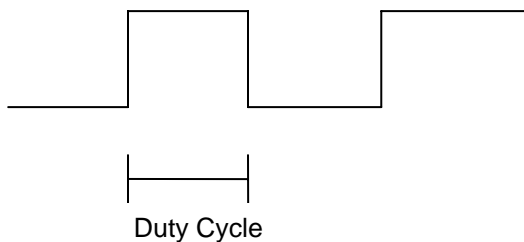

At controller power-up or during a download, the PWM output is maintained at zero until both the Period (count) and the Duty cycle (count) are loaded with non-zero values. When the controller is placed in stop mode, the state of the PWM outputs is dependent on the *PWM State on Controller Stop* configuration. This configuration allows for either hold-last-state or specific prescale, period and duty cycle counts. Specifying zero for either the period or duty causes the PWM output to remain low during stop mode.

Note that the nominal output driver turn-on-time delay (to reach 50% output) is 25 microseconds. Therefore, this limitation should be considered when determining both the minimum pulse width and the duty cycle accuracy of the application.

10.4.3 HSC (High Speed Counter)

When either Q1 or Q2 is configured for HSC operation, HSC1 or HSC2 totalize functions are extended to allow respective direct output control based on a comparison of the current count and a preset value (PV). See totalize in the HSC section above for more information.

10.4.4 Stepper Function

When Q1 is configured for Stepper, the stepper function is enabled at the Q1 output. Only one stepper function and output is available.

Note that when Q1 is configured for stepper operation, Q2 operation is limited to direct digital output.

The Stepper requires five parameters (%AQs) to be set for operation. These parameters may be set at run-time but are 'latched' when the stepper is commanded to start.

Start Frequency (cycles per second)

This value (%AQ1) sets the frequency for the first cycle during the acceleration phase and the frequency of the last cycle during the deceleration phase. When an acceleration or deceleration count is specified, the Start Frequency must be greater than 0 and must not exceed the run frequency or an error is generated.

Run Frequency (cycles per second)

This value (%AQ2) sets the frequency for the last cycle during the acceleration phase, the consistent frequency during the run phase, and the frequency of the first cycle during the deceleration mode. The Run Frequency must be greater than 0 and must not exceed 5000 cycles/sec. or an error is generated.

Acceleration Count

This value (%AQ3-4) sets the number of cycles to occur within the acceleration phase. The frequency of the cycles within this mode will vary linearly between the specified Start and Run frequency. The Accel count must not equal 1 or an error is generated. Setting this value to zero disables this phase.

Run Count

This value (%AQ5-6) sets the number of cycles to occur within the run phase. The frequency of the cycles within this mode is constant at the specified Run frequency. The Run count may be any value. Setting this value to zero disables this phase.

Deceleration Count

This value (%AQ7-8) sets the number of cycles to occur within the deceleration phase. The frequency of the cycles within this phase will vary linearly between the specified Run and Stop frequency. The Decel count must not equal 1 or an error is generated. Setting this value to zero disables this phase.

The stepper provides two Boolean registers to provide stepper status

Ready/Done

A high indication on this register (%I30) indicates the stepper sequence can be started (i.e. not currently busy).

Error

A high indication on this register (%I31) indicates that one of the analog parameters specified above is invalid or the stepper action was aborted before the operation was complete. This register is cleared on the next start command if the error was corrected.

The stepper requires one discrete register (%Q1) to control the stepper action. Setting this register starts the stepper cycle. This register must remain set to complete the entire cycle. Clearing this register before the cycle is complete aborts the step sequence and sets the error bit.

Note that setting the PLC mode to Stop while the stepper is in operation causes the stepper output to immediately drop to zero and the current stepper count to be lost.

Note that stepper output level may cause damage or be incompatible with some motor driver inputs. Consult drive documentation to determine if output level and type is compatible.

10.5 PWM functions register map

Register	PWM	HSC	Stepper
%AQ1	PWM1 Duty Cycle (32-bit)	HSC1 Preset Value	Start Frequency
%AQ2			Run Frequency
%AQ3	PWM2 Duty Cycle (32-bit)	HSC2 Preset Value	Accel Count
%AQ4			(32-bit)
%AQ5	PWM Prescale (32-bit)		Run Count
%AQ6			(32-bit)
%AQ7	PWM Period (32-bit)		Decel Count
%AQ8			(32-bit)
%Q1			Run
%I30			Ready/Done
%I31			Error

10.6 PWM Examples

All of the PWM examples use the following formula.

$$\text{Frequency} = \frac{16,000,000}{(\text{Prescale}+1) \times \text{PeriodCount}}$$

Example 1

To get a 50% Duty Cycle @ 10 kHz waveform on PWM1:

Set %AQ1-2 = 50 (duty cycle count)

Set %AQ5-6 = 15 (prescale count)

Set %AQ7-8 = 100 (period count)

Example 2

To get a 50% Duty Cycle on PW1 and 90 % Duty Cycle on PWM2 @ 1 kHz waveform:

Set %AQ1-2 = 500 (duty cycle count)
 Set %AQ3-4 = 900 (duty cycle count)
 Set %AQ5-6 = 15 (prescale count)
 Set %AQ7-8 = 1000 (period count)

Example 3

To turn PWM 1 output ON all the time

Set %AQ1-2 = Same value as AQ7-8 (duty cycle count)
 Set %AQ5-6 = Any value (prescale count)
 Set %AQ7-8 = Non-Zero value (period count)

Example 4

To turn PWM 1 output OFF all the time

Set %AQ1-2 = 0 (duty cycle count)
 Set %AQ5-6 = Any value (prescale count)
 Set %AQ7-8 = Any value <or> 0 (period count)

10.7 STP Examples**Example 1**

10,000,000 steps control sequence

The following example starts at 2.5 kHz and ramps up to 5 kHz during the first 1,000,000 steps. Then, it runs at 5 kHz for the next 8,000,000 steps. Finally during the last 1,000,000 steps it slows to a stop.

Set %AQ1 = 2500 (Hz) {Start Frequency}
 Set %AQ2 = 5000 (Hz) {Run Frequency}
 Set %AQ3-4 = 1000000 (Steps) {Accel Count}
 Set %AQ5-6 = 8000000 (Steps) {Run Count}
 Set %AQ7-8 = 1000000 (Steps) {Decel Count}

Example 2

5,000,000 steps control sequence

The following example starts at 0.5 kHz and ramps up to 1 kHz during the first 2,000,000 steps. Then, it runs at 1 kHz for the next 2,000,000 steps. Finally during the last 1,000,000 steps it slows to a stop.

Set %AQ1 = 500 (Hz) {Start Frequency}
 Set %AQ2 = 1000 (Hz) {Run Frequency}
 Set %AQ3-4 = 2000000 (Steps) {Accel Count}
 Set %AQ5-6 = 2000000 (Steps) {Run Count}
 Set %AQ7-8 = 1000000 (Steps) {Decel Count}

Example 3

6,000,000 steps control sequence

The following example starts at 50 Hz and ramps up to 250 Hz during the first 150,000 steps. Then, it runs at 250 Hz for the next 5,500,000 steps. Finally during the last 350,000 steps it slows to a stop.

Set %AQ1 = 50 (Hz) {Start Frequency}

Set %AQ2 = 250 (Hz) {Run Frequency}
Set %AQ3-4 = 150000 (Steps) {Accel Count}
Set %AQ5-6 = 5500000 (Steps) {Run Count}
Set %AQ7-8 = 350000 (Steps) {Decel Count}

Note: The highest usable frequency is 65 KHz for the PWM output.

CHAPTER 11: SYSTEM SETTINGS AND ADJUSTMENTS

11.1 System Menu - Overview

The XLe/XLt controller has a built-in System Menu, which lets the user view System Settings and make adjustments. To start the System Menu, press the ↓ and ↑ keys at the same time (or set %SR3 to 1), which will display the Main Menu, as shown in **Figure 11-1** and in **Figure 11-12**. Then use the ↓ and ↑ keys to select a **Main Menu** item and press **Enter** to display the item's Sub-Menu.

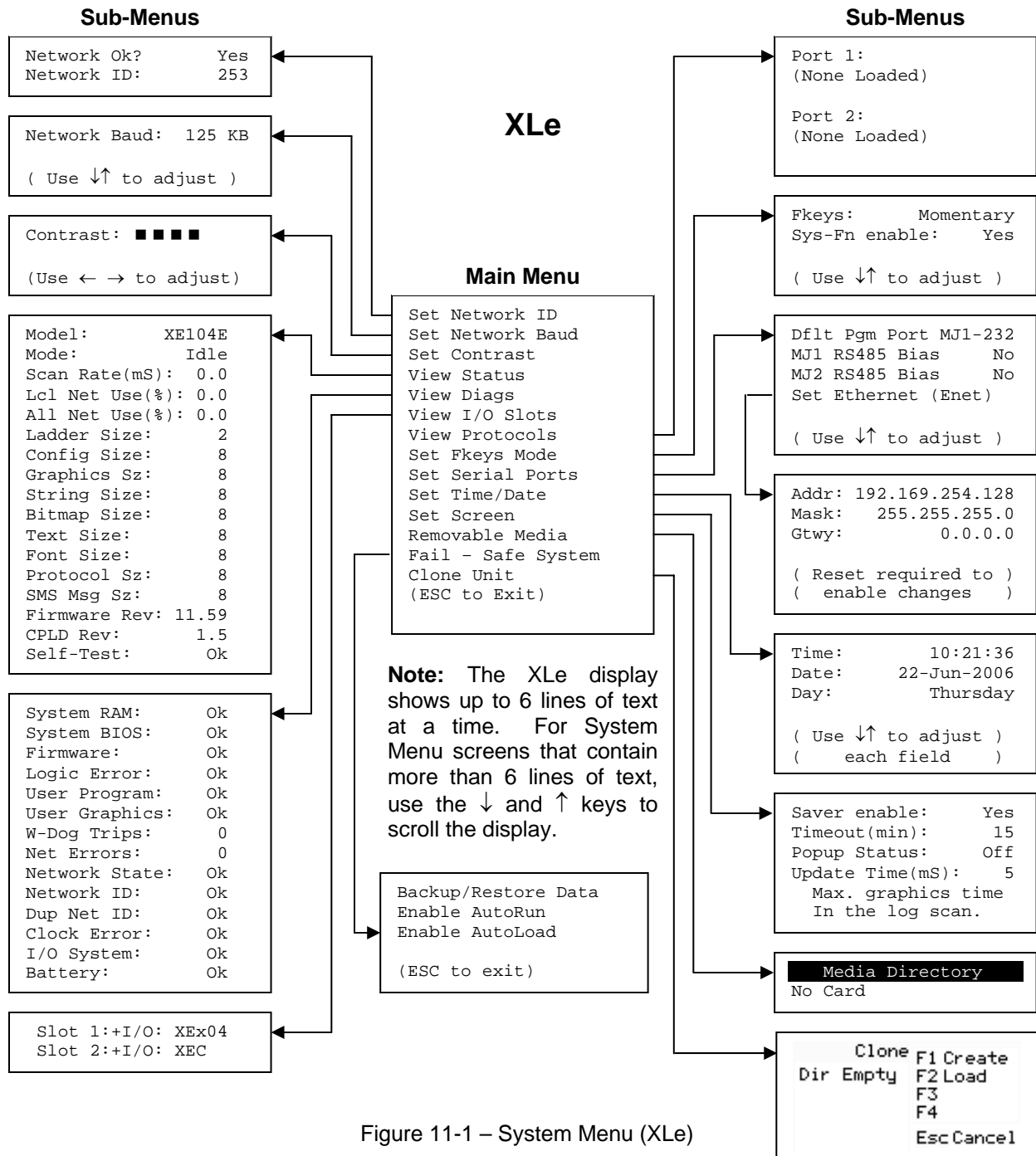

Figure 11-1 – System Menu (XLe)

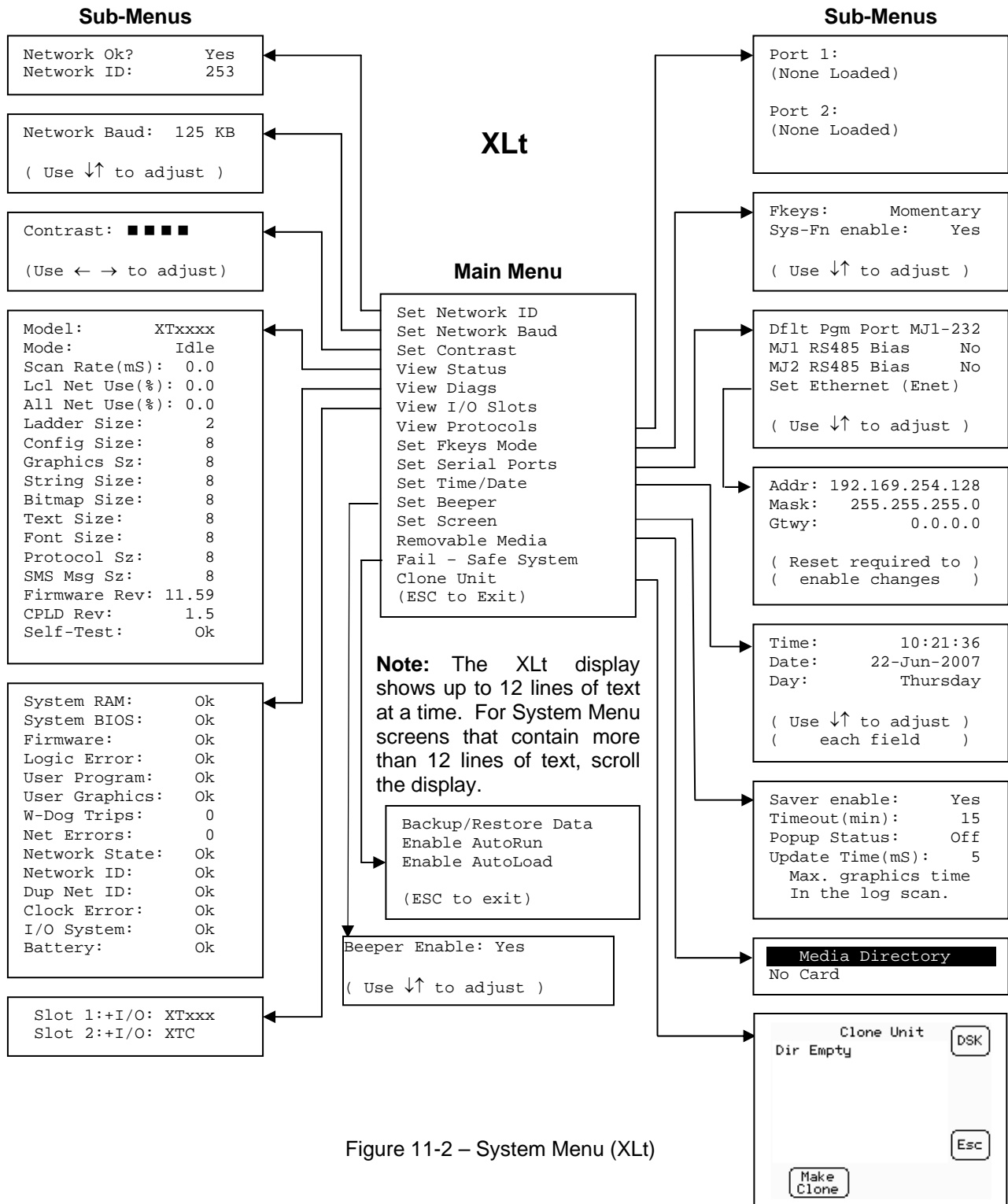

Figure 11-2 – System Menu (XLt)

11.2 System Menu – Navigation and Editing

As mentioned above, the System Menu is started by pressing the ↓ and ↑ keys at the same time for the XLe, or the System key on the XLt. Then, either press ESC to exit the System Menu, or use the ↓ and ↑ keys to select an item and press **Enter** to display the item’s Sub-Menu.

A Sub-Menu generally shows a list of System Settings and their values. After opening a Sub-Menu, if any of its System Settings are editable, the first System Setting that can be edited is highlighted. If desired, the ↓ and ↑ keys can be used to select a different System Setting to be edited.

At this point, either press **ESC** to exit the Sub-Menu (returning to the Main Menu) or press **Enter** to edit the highlighted System Setting. If **Enter** is pressed, the System Setting's value will be highlighted, indicating that it is ready to be modified.

When modifying a System Setting's value, use either the arrow keys (← → ↓ ↑) or the numeric keys, or the appropriate touch screen icons to select a new value.

The arrow keys are used to edit System Settings that have just a few possible values. Each time the arrow key is pressed, a new possible value is displayed. When the desired value appears, press the **Enter** key to save it; otherwise press the **ESC** key to cancel the edit.

The numeric keys are normally used to enter numeric System Settings. In addition, to edit a single numeric digit, use the ← or → key to select the digit and then either press a numeric key or use ↓ or ↑ to modify the digit. In any case, after entering the new desired value, press the **Enter** key to save it; otherwise press the **ESC** key to cancel the edit.

11.3 System Menu – Details

The following sections describe each of the Sub-Menus in detail.

Set Network ID

The Network ID Sub-Menu only appears for XLe/XLt models that have CAN ports (XE1xx). This Sub-Menu displays two System Settings of which only **Network ID** is editable.

Network Ok?	Yes	= NET1 connected to a CAN network and functioning properly
	No	= Not ready to communicate on CAN network
Network ID:	1 to 253	= This node's CsCAN Network ID; must be unique on network

Set Network Baud

The Network Baud Sub-Menu only appears for XLe/XLt models that have CAN ports (XE1xx). This Sub-Menu displays just one System Setting and it is editable.

Network Baud?	125 KB	= 125 KBaud CAN network
	250 KB	= 250 KBaud CAN network
	500 KB	= 500 KBaud CAN network
	1 MB	= 1 MBaud CAN network

Set Contrast

The Set Contrast Sub-Menu displays just one System Setting and it is editable.

Contrast:	■ ■ ■ ■ ■	= Current display contrast setting
------------------	-----------	------------------------------------

View Status

The View Status Sub-Menu displays up to 17 System Settings. The **Lcl Net Use %** and **All Net Use %** System Settings only appear for XLe/XLt models that have CAN ports (XE1xx). Only the **Mode** System Setting is editable.

Model:	XExyyz	= 5 or 6 character Model number of this XLe/XLt unit x is 1 for models that have a CAN port; 0 = no CAN port yy indicates the installed I/O module; 00 = no I/O module z indicates the installed COM module; N = no COM module
Mode:	Idle Dolo Run	= XLe/XLt is in Idle mode = XLe/XLt is in Do I/O mode = XLe/XLt is in Run mode
Scan Rate(mS):	0.0 0.1 to 999.9	= XLe/XLt is not in Run mode = Average number of mS for each ladder scan
Lcl Net Use %:	0.0 to 100.0	= CAN network bandwidth % used by this XLe/XLt node
All Net Use %:	0.0 to 100.0	= CAN network bandwidth % used by all nodes
Ladder Size:	x	= Number of bytes in application ladder program
Config Size:	x	= Number of bytes in application I/O configuration
Graphics Sz:	x	= Number of bytes in application graphic screens
String Size:	x	= Number of bytes in application string table
Bitmap Size:	x	= Number of bytes in application bitmaps
Text Size:	x	= Number of bytes in application text tables
Font Size:	x	= Number of bytes in application font tables
Protocol Sz:	x	= Number of bytes in application downloaded protocols
SMS Msg Sz:	x	= Number of bytes in application SMS protocol configuration
Firmware Rev:	xx.yy	= Current firmware version
CPLD Rev:	x.y	= Current CPLD (Complex Programmable Logic Device) version
Self-Test:	Ok Fault	= All power-on self-tests passed = One or more power-on self-tests failed

View Diags

The View Diags Sub-Menu displays up to 14 System Diagnostics, all of which are not editable. The **Net Errors**, **Network State**, **Network ID** and **Dup Net ID** System Diagnostics only appear for XLe/XLt models that have CAN ports (XE1xx).

The first five System Diagnostics are critical. If any of them indicate a Fault condition, the XLe/XLt will not enter or remain in Run mode, and the problem must be investigated and corrected.

System Ram:	Ok	= System RAM power-up self-test passed
	Fault	= System RAM power-up self-test failed
System BIOS:	Ok	= System BIOS power-up self-test passed
	Fault	= System BIOS power-up self-test failed
Firmware:	Ok	= Firmware power-up self-test passed
	Fault	= Firmware power-up self-test failed
Logic Error:	Ok	= All executed ladder instructions are legal for loaded firmware
	Fault	= A ladder instruction <u>not</u> supported by firmware was found
User Program:	Ok	= Ladder program and I/O configuration loaded successfully
	Fault	= Ladder program or I/O configuration not loaded or load failed

The last nine System Diagnostics are informational. If any of them indicate a Warning condition, the XLe/XLt can still enter and remain in Run mode, but the problem should be investigated and corrected.

User Graphics:	Ok	= Application graphics objects loaded successfully
	Fault	= Application graphics objects not loaded or load failed
W-Dog Trips:	0	= Watchdog timer has not tripped since the last power-up
	x	= Number of times watchdog timer has tripped
Net Errors:	0	= No CAN network bus-off errors have occurred
	x	= Number of CAN network bus-off errors that have occurred
Network State:	Ok	= At least one other node was found on the CAN network
	Warning	= No other nodes were found on the CAN network
Network ID:	Ok	= This node's CAN Network ID is in the range 1 to 253
	Warning	= This node's CAN Network ID was out of range at power-up
Dup Net ID:	Ok	= This node's Network ID is unique on the CAN network
	Warning	= This node's Network ID is duplicated in another node
Clock Error:	Ok	= Time and date have been set
	Warning	= Time and date need to be set
I/O System:	Ok	= I/O configuration matches the installed I/O and COM modules
	Warning	= I/O configuration needs updating to match installed modules
Battery:	Ok	= Backup battery operating properly
	Warning	= Backup battery needs to be replaced

View I/O Slots

The View I/O Slots Sub-Menu displays two System Settings, both of which are not editable.

Internal to the XLe/XLt, there is a CPU board, and up to two installed modules. Models XE000 and XE100 have no installed I/O or COM modules. All other models have an I/O module in Slot 1 and can have a user-installed COM module in Slot 2.

Depending on which I/O module is installed and which I/O module has been configured by Cscape, one of the following six System Settings should appear for Slot 1:

Slot 1: I/O: Empty	= No I/O module installed or configured
Slot 1:*Unsupported	= Unsupported I/O module installed
Slot 1:-I/O Missing	= No I/O module installed but an I/O module is configured
Slot 1:+I/O: XExyy	= yy I/O module installed but no I/O module configured
Slot 1:?I/O: XExyy	= yy I/O module installed but another I/O module configured
Slot 1: I/O: XExyy	= yy I/O module installed and configured properly

Depending on the COM module that is installed and the COM module that has been configured by Cscape, one of the following six System Settings appears for Slot 2:

Slot 2: I/O: Empty	= No COM module installed or configured
Slot 2:*Unsupported	= Unsupported COM module installed
Slot 2:-I/O Missing	= No COM module installed but a COM module is configured
Slot 2:+I/O: XzC	= z COM module installed but no COM module configured
Slot 2:?I/O: XzC	= z COM module installed but another COM module configured
Slot 2: I/O: XzC	= z COM module installed and configured properly

View Protocols

The View Protocols Sub-Menu displays two System Settings, both of which are not editable.

As mentioned in CHAPTER 5, both the MJ1 (Port 1) and MJ2 (Port 2) serial ports support downloadable protocols. To assign a downloadable protocol to an XLe/XLt serial port, select the **Protocol Config** item in Cscape's Program menu and then setup a protocol for Port 1 or Port 2 (or both).

In the View Protocols Sub-Menu, the currently downloaded protocol, if any, and its version number are displayed for both Port 1 and Port 2.

Port 1:	
Protocol name	= (None Loaded) or name of the protocol assigned to MJ1
Protocol version	= Blank or version of the protocol assigned to MJ1

Port 2:	
Protocol name	= (None Loaded) or name of the protocol assigned to MJ2
Protocol version	= Blank or version of the protocol assigned to MJ2

Set Fkeys

The Set Fkeys Sub-Menu displays two System Settings, both of which are editable.

Fkeys:	Momentary	= %K1-10 bits go On & Off as F1-F10 are pressed & released
	Toggle	= %K1-10 bits toggle each time F1-F10 are pressed
SYS_Fn enable:	Yes	= Reset and all clear system functions enabled
	No	= Reset and all clear system functions disabled

Set Serial Ports

The Set Serial Ports Sub-Menu displays three System Settings, all of which are editable, and one optional item. For the **Dflt Pgm Port** System Setting, only MJ1-232 can be selected, unless either an Ethernet (XEC) or a Modem (XMC) COM module is installed. Also, the **Set Ethernet (Enet)** item only appears if an Ethernet COM module is installed.

Dflt Pgm Port:	MJ1-232	= MJ1 RS232 port is the default programming port
	Enet	= Ethernet COM module is the default programming port
	Modem	= Modem COM module is the default programming port
MJ1 RS485 Bias:	No	= MJ1 RS485 bias resistors are <u>not</u> switched in
	Yes	= MJ1 RS485 bias resistors are switched in
MJ2 RS485 Bias:	No	= MJ2 RS485 bias resistors are <u>not</u> switched in
	Yes	= MJ2 RS485 bias resistors are switched in
Set Ethernet (Enet)		= Select and press Enter to setup the Ethernet COM module

Set Ethernet (Enet)

The Set Ethernet (Enet) Sub-Menu displays three System Settings, all of which are editable. The values shown below are the default values. Note that if **Gtwy** is set to 0.0.0.0, Ethernet communication will be confined to the local network.

Addr:	192.168.254.128	= IP Address for installed Ethernet COM module
Mask:	255.255.255.0	= Net Mask for installed Ethernet COM module
Gtwy:	0.0.0.0	= Gateway device IP Address for installed Ethernet COM module

Set Time/Date

The Set Time/Date Sub-Menu displays three System Settings. **Time** and **Date** are editable, and **Day** is automatically calculated from the **Date** setting. Note that **Time** and **Date** are split into three editable fields each. Use ← or → to select a field and then use ↓ or ↑ to edit the field.

Time:	10:21:36	= Current time (hours:minutes:seconds in 24-hour format)
Date:	22-Jun-2006	= Current date (day-month-year)
Day:	Thursday	= Current day of week calculated from the Date setting

Note: After changing the Ethernet Addr, Mask, or Gtwy, the XLe/XLt must be power-cycled (or reset) before the changes take effect.

XLt Specific:Set Beeper (XLt only)

The Set Beeper Sub-Menu displays one System Setting, which is editable

Beeper enable: Yes (*default*)= Enables beeper **No** = Disables beeper (does NOT affect ladder access)

Removable Media

XLe Specific:

The Removable Media Sub-Menu displays the Removable Media Manager (see CHAPTER 8). After selecting Removable Media from the Main Menu, one of four Sub-Menu screens will appear:

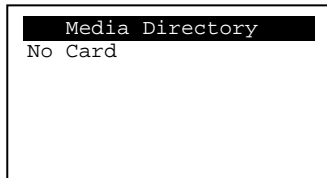

= No Micro SD card has been installed in the Memory slot



= Micro SD card is installed, but it is still initializing

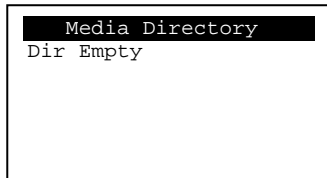

= Micro SD card is installed and initialized, but contains no files

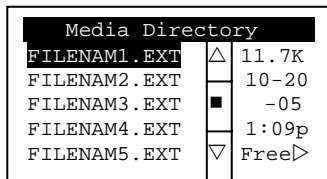

= Micro SD card is installed and initialized, and it contains files

- Shows size of highlighted file or shows <DIR> if directory is highlighted
- Shows the date file or directory was created or last modified
- Shows the time file or directory was created or last modified

Scrollbar only appears if displayed directory contains more than five files and/or directories.

Shows up to five files or directory names at a time

If the Removable Media Manager displays files or directories, as in the last example above, there are several options available:

If → is pressed, the number of total and free bytes is displayed. Then, pressing ← returns to the normal file and directory display.

If a soft key (on either side of the display) is pressed, a pop-up window appears on the right side of the display, showing the function key options as follows:

- F1 Delete** = Delete the highlighted file or directory
- F2 DelAll** = Delete all files and directories
- F3 Format** = Format the Micro SD card
- F4 SavPgm** = Save XLe/XLt application to DEFAULT.PGM
- Esc Cancel** = Cancel current operation (back up one screen)

Pressing the soft key again or pressing ESC returns to the normal file and directory display.

If a directory name is highlighted, pressing **Enter** will switch to that directory showing its files and sub-directories. In a sub-directory, highlighting **..** (dot dot) and pressing **Enter** will move up one directory

Removable Media

XLt Specific:

The Removable Media Sub-Menu displays the Removable Media Manager (see CHAPTER 8). After selecting Removable Media from the Main Menu, one of four Sub-Menu screens will appear:

<pre>Media Directory No Card</pre>	= No Micro SD card has been installed in the Memory slot
<pre>Media Directory Initializing</pre>	= Micro SD card is installed, but it is still initializing
<pre>Media Directory Dir Empty</pre>	= Micro SD card is installed and initialized, but contains no files
<pre>Media Directory DLOG1 <DIR> DSK DLOG2 12-18 COPY(2->1.BMF -06 COPY(3->1.BMF 1:43 COPY(4->1.BMF COPYOF->1.BMF DEFAULT .PGM OCSGFX .ZIF</pre> <div style="display: flex; justify-content: space-between; margin-top: 5px;"> <div style="font-size: small;"> <p>Del Del All For mat Save Pgm</p> </div> <div style="font-size: small;"> <p>DSK</p> <p>▲</p> <p>▼</p> <p>Esc</p> <p>←</p> </div> </div>	<p>= Micro SD card is installed and initialized, and it contains files</p> <p>Shows size of highlighted file or shows <DIR> if directory is highlighted</p> <p>Shows date the file or directory was created or last modified</p> <p>Shows time the file or directory was created or last modified</p> <p>Scrollbar only appears if displayed directory contains more than five files and/or directories.</p> <p>Shows up to five file or directory names at a time</p>

If the Removable Media Manager displays files or directories there are several options available:

<pre>Media Directory COPY(3->1.BMF 121.0K DSK COPY(4->1.BMF 06-15 COPYOF->1.BMF -06 DEFAULT .PGM 2:09p OCSGFX .ZIF SCREEN .BMF XE100N .PGM XE104-EC.PGM</pre> <div style="display: flex; justify-content: space-between; margin-top: 5px;"> <div style="font-size: small;"> <p>Del Del All For mat Save Pgm</p> </div> <div style="font-size: small;"> <p>DSK</p> <p>▲</p> <p>▼</p> <p>Esc</p> </div> </div>	<p>Delete = Delete the highlighted file or directory</p> <p>DelAll = Delete all files and directories</p> <p>Format = Format the Micro SD card</p> <p>SavPgm = Save XLt application to DEFAULT.PGM</p> <p>← = Enter Key</p> <p>DSK = Shows number of total and free bytes in removable memory</p> <p>▲ = Up Arrow</p> <p>▼ = Down Arrow</p> <p>Esc = Cancel current operation (back up one screen)</p>
---	--

Pressing **Esc** returns to the normal file and directory display.

If a directory name is highlighted, pressing **Enter** will switch to that directory showing its files and sub-directories. In a sub-directory, highlighting **..** (dot dot) and pressing **Enter** will move up one directory

Fail – Safe System

The Fail-Safe System is a set of features that allow an application to continue running in the event of certain types of "soft" failures. These "soft" failures include:

- Battery power loss
- Battery-Backed Register RAM or Application Flash corruption due to, for example, an excessive EMI event.

Selecting “Fail-Safe System” menu will open the following menu screen:

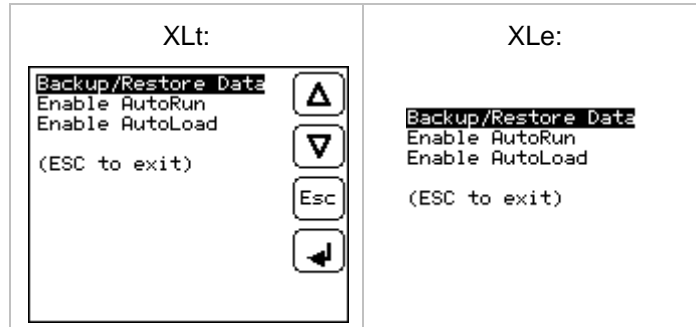

Selecting Backup/Restore Data displays the following screen in:

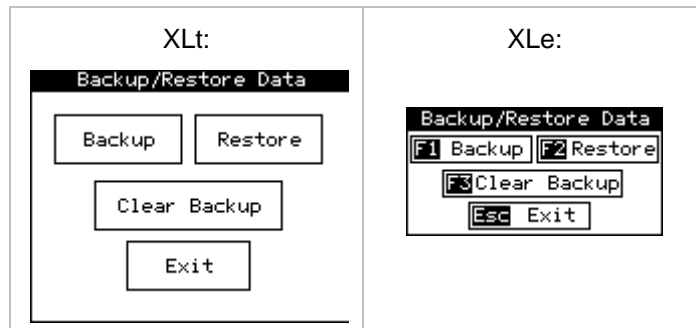

- Backup = Copies Battery Backed RAM contents on to the onboard FLASH memory of the OCS.
- Restore = Copies the backed up data from onboard FLASH to the battery backed RAM.
- Clear Backup = The backup data will be erased from the onboard FLASH.
- Exit = Goes back to previous menu.

“Enable AutoRun” displays the following options which can be selected:

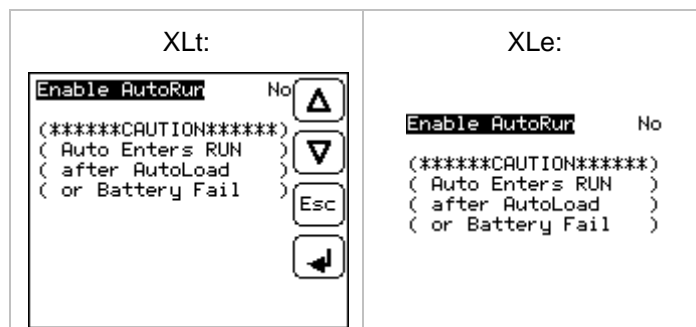

Enable AutoRun No = OCS will be in IDLE mode after AutoLoad or Automatic Restore.
 Yes = OCS will be automatically placed into RUN mode after AutoLoad or Automatic Restore.

“Enable AutoLoad” displays the following options which can be selected:

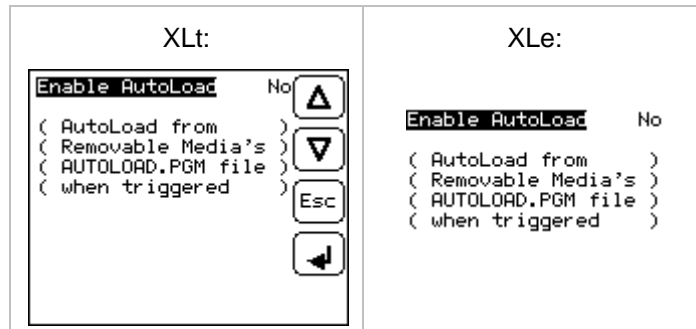

Enable AutoLoad No = Does not load AUTOLOAD.PGM automatically when application program is absent or corrupted.
 Yes = Loads AUTOLOAD.PGM file automatically from RM when application program is absent or corrupted.

Clone Unit

‘Clone Unit’ feature allows the user to “clone” the OCS of the exact same model. This feature “clones” application program and unit settings stored in Battery backed RAM of an OCS into the RM (refer Removable Media [Chapter 8](#) for details on using RM). It can then be used to clone a different OCS (exact same model).

This feature can be used for:

- Replacing an OCS by another unit of the same model.
- Duplicating or “clone” units without a PC.

Clone

Selecting “Clone Unit” menu will open the following menu screen:

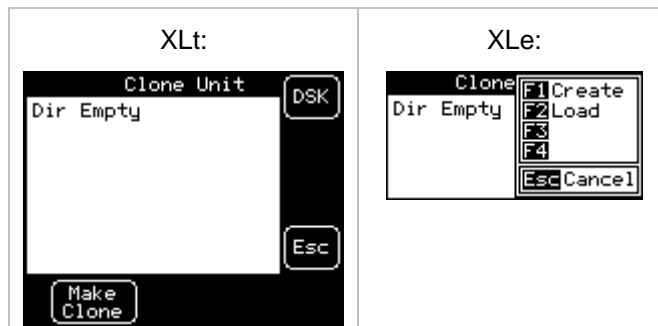

Note:

- a. In the above Figure, F3 and F4 (XLe menu) are inactive in Clone Unit.
- b. **DSK** – when selected shows number of total and free bytes in Removable Media.

Selecting Make Clone brings up the screen below for the user:

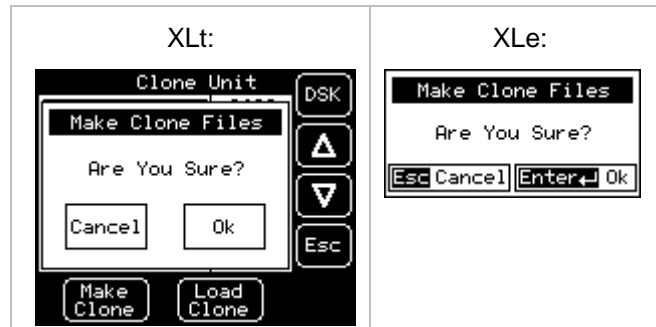

After confirmation, the OCS will create two new files in the root directory of the Removable Media Drive as shown below:

AUTOLOAD.PGM
CLONE.DAT

Application file
File having all unit settings and register values from Battery Backed RAM

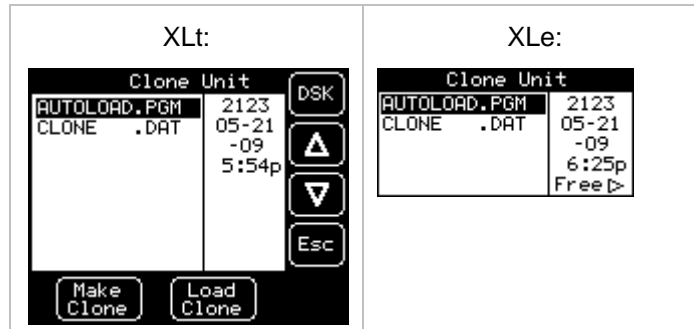

Load Clone

Selecting "Clone Unit" menu will open the following menu screen. Select "Load Clone".

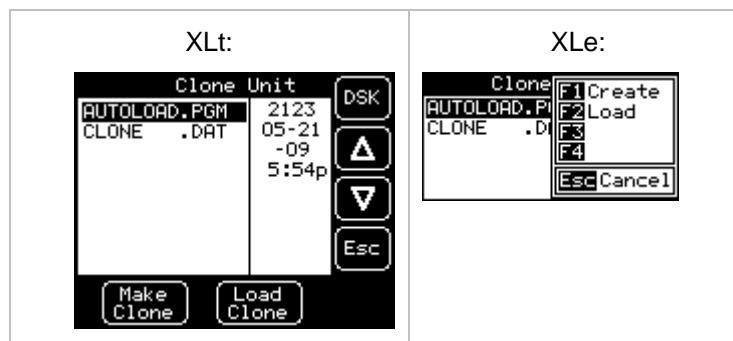

NOTE: For security enabled files, Load clone asks for password validation before loading the application.

CHAPTER 12: USER INTERFACE

12.1 Screen Navigation

The screen navigation on the XLe/XLt is quite flexible. Basic methods will be described here. Control programming can be used to create complex screen navigation techniques.

One form of screen navigation is the **Jump Screen** graphics object. This object is typically tied to a soft key (One of the four keys to the sides of the display for the XLe and at the bottom of the screen for the XLt). Pressing the soft key will switch to the screen that is programmed.

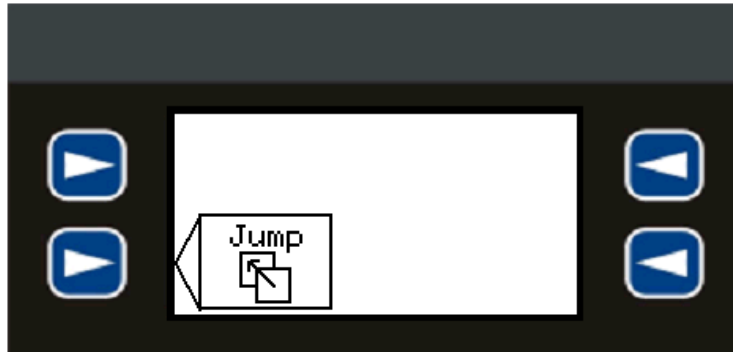

Figure 12-1 – Typical Screen Jump Object (XLe)

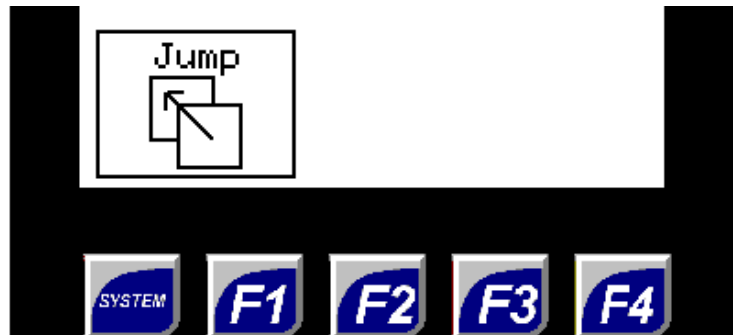

Figure 12-2 – Typical Screen Jump Object (XLt)

Screen jumps can also be triggered on other keys or based on control logic for more advanced applications. To allow the operator to change screens, a **screen jump object** is generally used. This object may be visually **represented as a button** (responding to touch) or remain invisible and logically tied to an OCS register. An optional system ICON may be configured for display along with the legend, which aids in identifying the object as one that causes a screen change.

12.2 Ladder Based Screen Navigation

Ladder logic can use several techniques to control screen navigation. Coils can be tied to %D registers to make them screen coils. These coils have two modes, switch and alarm. If the ladder program energizes an alarm display coil, the screen associated with this coil is displayed and overrides the normal user screens. This is designed to show alarm conditions or to display other ladder-detected events. When the text coil is de-energized, the previous screen that was being viewed before the alarm is returned.

The switch display coil switches to the associated screen when it is energized. Once it is de-energized the screen remains until it is switched by the user or ladder.

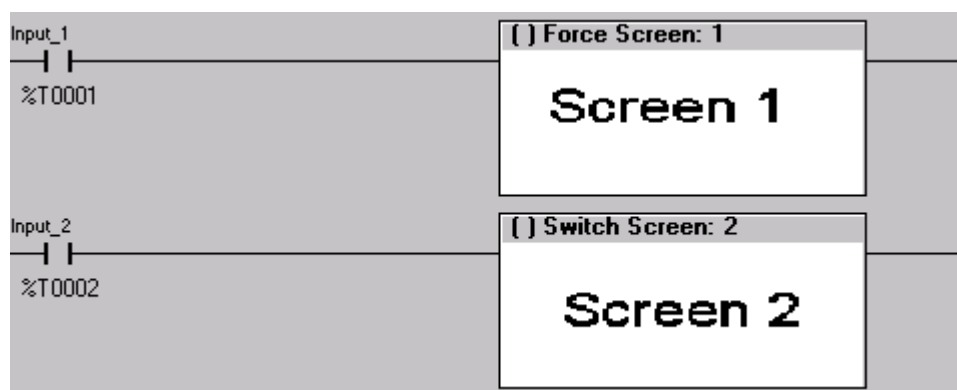

Figure 12-3 – Force and Switch Coils in Ladder Programming

There is also a system register that can be used to for control based screen navigation. %SR1 can be read to determine the current screen or written to change the current screen.

Refer to the on-line help in Cscope for more information on control-based screen navigation.

12.3 Using Editable Screen Objects

When a screen contains editable objects, one of the objects will be selected by default. Selected objects will be outlined with a dotted line. The arrow keys can be used to navigate the editable objects and allow selection of an object to edit. When the object to be edited is selected press the **Enter** button. This enters the objects editing mode.

The most common editable object is the numeric object.

XLe Specific:

When in edit mode, a cursor appears on one digit of the editable field. Use the direction keys \leftarrow and \rightarrow to move the cursor to the desired position. Use the \uparrow and \downarrow keys to increment or decrement the digit or enter the number/data with the alphanumeric keys.

XLt Specific:

The most common editable object is the numeric object. To edit, touch the object and pop-up keypad will appear to allow editing the value.

The value chosen by the operator can not exceed the minimum or maximum set by the user program. If the user tries to exceed the maximum point or enter a value below the minimum point, the value does not change.

Note: If the XLe/XLt displays >>>>> in a numeric field, the value is too big to display in the field or is above the maximum for an editable field. If the XLe/XLt displays <<<<< in a numeric field, the value is too small to display or is below the minimum for an editable field.

For addition information on a specific object please see the on-line help in Cscape.

XLt Specific:**Beeper Acknowledgement**

The XLt contains an internal beeper that provides an audible acknowledgment when an operator touches a graphic object that accepts touch input. When the graphical object is enabled, a short 5mSec tone is emitted. When the graphical object is disabled, a longer 100mSec tone is emitted to enounce that graphical object is not currently accepting the touch input.

If beep acknowledgement is not desired, the beeper function can be disabled from the system menu.

NOTES

CHAPTER 13: REGISTERS

13.1 Register Definitions

When programming the XLe/XLt, data is stored in memory that is segmented into different types. This memory in the controller is referred to as registers. Different groups of registers are defined as either bits or words (16 bits). Multiple registers can usually be used to handle larger storage requirements. For example 16 single bit registers can be used to store a Word or two 16 bit registers can be used to store a 32-bit value.

Below is a list of the type of registers found in the XLe/XLt.

%AI Analog Input

16-bit input registers used to gather analog input data such as voltages, temperatures, and speed settings coming from an attached device.

%AQ Analog Output

16-bit output registers used to send analog information such a voltages, levels or speed settings to an attached device.

%AIG Global Analog Input

Specially defined 16-bit input registers that come from the network.

%AQG Global Analog Output

Specially defined 16-bit output registers that go to the network.

%D Display Bit

These are digital flags used to control the displaying of screens on a unit which has the ability to display a screen. If the bit is SET, the screen is displayed.

%I Digital Input

Single-bit input registers. Typically, an external switch is connected to the registers.

%IG Global Digital Input

Specially defined single-bit inputs that come from the network.

%K Key Bit

Single-bit flags used to give the programmer direct access to any front panel keys appearing on a unit.

%M Retentive Bit

Retentive single-bit registers.

%Q Digital Output

Single-bit output registers. Typically, these bits are connected to an actuator, indicator light or other physical outputs.

%QG Global Digital Output

Specially defined single-bit outputs that go to the network.

%R General Purpose Register

Retentive 16-bit registers.

%S System Bit

Single-bit bit coils predefined for system use.

%SR System Register

16-bit registers predefined for system use.

%T Temporary Bit

Non-retentive single-bit registers.

13.2 Useful %S and %SR registers

Table 13.1 – Common %S Register Definitions	
Register	Description
%S1	Indicate First Scan
%S2	Network is OK
%S3	10mS timebase
%S4	100mS timebase
%S5	1 second timebase
%S6	I/O is OK
%S7	Always ON
%S8	Always OFF
%S9	Pause 'n Load soon
%S10	Pause 'n load done
%S11	I/O being forced
%S12	Forcing is enabled
%S13	Network I/O is OK
%S16	Ethernet COM module is OK

Table 13.2 – Common %SR Register Definitions	
Register	Description
%SR1	This register displays/controls the current user scrollable screen. Setting this register to 0 displays no user screens
%SR2	This register displays/controls the current alarm screen.
%SR6	This register displays the average scan rate of the controller in tenths of milliseconds. (123 = 12.3 mSec)
%SR44	<i>This register displays the seconds from the real time clock</i>
%SR45	This register displays the minutes from the real time clock.
%SR46	This register displays the hours from the real time clock.
%SR47	This register displays the day of the month from the real time clock.
%SR48	This register displays the month from the real time clock. 1 = January ... 12 = December.
%SR49	This register displays the four digit year from the real time clock.
%SR50	This register displays the day of the week from the real time clock. 1 = Sunday, 2 = Monday ... 7 = Saturday
%SR56	This register displays the current key being pressed on the controller keypad.
%SR57	This register displays/controls the LCD backlight. 0 = OFF, non-zero = ON
%SR164.3	Enable Automatic Restore Operation (Fail Safe)
%SR164.4	Enable Backup (Fail Safe System)
%SR164.5	Enable AUTORUN (Fail Safe)
%SR164.6	Enable AUTOLOAD (Fail Safe)
%SR164.7	Clear Backup trigger bit
%SR164.8	Create Backup trigger bit

Table 13.2 – Common %SR Register Definitions	
%SR164.9	MAKE_CLONE trigger bit
%SR164.10	LOAD_CLONE trigger bit
%SR164.11	Make Clone Fail (This bit goes high when Make / Create Clone fails)
%SR164.12	Load Clone Fail (This bit goes high when Load Clone fails)
%SR175	Status of the removable media
%SR176 to %SR177	This register shows the amount of free space on the inserted removable media in bytes. This is a 32-bit value.
%SR178 to %SR179	This register shows the total size of the inserted removable media in bytes. This is a 32-bit value.
%SR181	This register is a bit-mapped indicator of the advanced alarm manager. Each bit shows if a group has an unacknowledged alarm. For example, if bit one is ON there is an unacknowledged alarm in group one.
%SR182	This register is a bit-mapped indicator of the advanced alarm manager. Each bit shows if a group has an active alarm. For example, if bit one is ON there is an active alarm in group one.
%SR183 (only for XLt)	SYS_BEEP System Beep Enable (0=disabled; 1=enabled)
%SR184 (only for XLt)	USER_BEEP Software configurable (0=OFF; 1=ON)

For additional information on system bits and registers, refer to the on-line help found in Cscope.

13.3 Register Map for XLe/XLt I/O

Table 13.3 – I/O Register Map					
Registers	Description				
	XLx with no I/O	XLx with 102 I/O	XLx with 103 I/O	XLx with 104 I/O	XLx with 105 I/O
%I1-%I12	Unused	Digital Inputs	Digital Inputs	Digital Inputs	Digital Inputs
%I13-%I16	Unused	Reserved	Reserved	Digital Inputs	Reserved
%I17-%I24	Unused	Unused	Reserved	Digital Inputs	Reserved
%I25-%I31	Unused	Unused	Reserved	Reserved	Reserved
%I32	Unused	Unused	Output Fault	Output Fault	Output Fault
%Q1-%Q6	Unused	Digital Outputs	Digital Outputs	Digital Outputs	Digital Outputs
%Q7-%Q12	Unused	Reserved	Digital Outputs	Digital Outputs	Digital Outputs
%Q13-%Q16	Unused	Reserved	Reserved	Digital Outputs	Reserved
%Q17	Unused	Totalizer: Clear HSC1, Quadrature: Clear Quad1			
%Q18	Unused	Totalizer: Clear HSC2, Quadrature: Set Quad1			
%Q19	Unused	Totalizer: Clear HSC3, Quadrature: Clear Quad2			
%Q20	Unused	Totalizer: Clear HSC4, Quadrature: Set Quad2			
%Q21-%Q24	Unused	Reserved			
%AI1-%AI2	Unused	Analog Inputs	Analog Inputs	Analog Inputs	Analog Inputs
%AI3-%AI4	Unused	Analog Inputs	Reserved	Reserved	Reserved
%AI5-%AI6	Unused	HSC1 Accumulator			
%AI7-%AI8	Unused	HSC2 Accumulator			
%AI9-%AI10	Unused	HSC3 Accumulator			
%AI11-%AI12	Unused	HSC4 Accumulator			
%AQ1-%AQ2	Unused	PWM1 Duty Cycle			
%AQ3-%AQ4	Unused	PWM2 Duty Cycle			
%AQ5-%AQ6	Unused	PWM Prescale			
%AQ7-%AQ8	Unused	PWM Period			
%AQ9-%AQ10	Unused	Unused	Unused	Unused	Analog Outputs
Unused = These registers can be used as general purpose registers					

13.4 Resource Limits

Table 13.3- Resource Limits	
Resource	Value
%S	13
%SR	192
%T	2048
%M	2048
%R	9999
%K	10
%D	1023
%I	2048
%Q	2048
%AI	512
%AQ	512
%IG	64
%QG	64
%AIG	32
%AQG	32
Network Ports	CsCAN (Optional depending on model.)
Controllers Per Network	253
Keypad	20 keys (10 fn keys and 4 soft keys)
Display	128x64 LCD Backlit, monochrome for XLe 160x128 LCD Backlit, monochrome for XLt
Screen Memory	1 M
User Screens	1023
Data Fields Per User Screen	50
Ladder Code	256 k

CHAPTER 14: CSCAPE CONFIGURATION

14.1 Overview

XLe/XLt hardware is programmed with a Windows based PC application called Cscape. This application can be used to program, configure, monitor and debug all aspects of the XLe/XLt unit. Please see the on-line help provided with Cscape for additional details.

14.2 Cscape Status Bar

When the XLe/XLt is connected to a PC using Cscape software a Status Bar appears at the bottom of the screen. The Cscape Status Bar can be used to determine if communications have been established between the XLe/XLt and the Cscape program. Components of the Cscape Status Bar are explained below.

Message Line -

The contents of these messages are context sensitive. The Message line can be empty.

Equal Indicator – indicates whether the current program in Cscape is equal to the program stored in the Target Controller.

- If **Equal**, the program in Cscape is the same as the program stored in the Target Controller.
- If **Not Equal**, the program in Cscape is not the same as the program stored in the Target Controller.
- If **Unknown**, there may have been a change since the last time the program in Cscape was compared to the Target Controller.

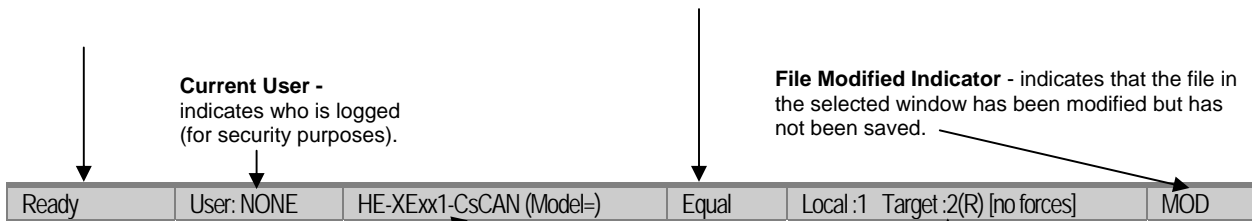

Controller Model - Network (Model Confirmation)

- **Controller Model** indicates the controller model for which the program in Cscape is configured.
- **Network** indicates the type of network that the program in Cscape expects to use (e.g., CsCAN).
- **(Model Confirmation)** provides the following indications:
- **(Model=)** - the actual Target Controller matches the configured Controller Model and Network.
- **(Model Not=)** – the actual Target Controller does not match the configured Controller Model and Network.
- **(Model ?)** – there may have been a change since the last time the Target Controller was compared to the configured Controller Model and Network.

Communications Status - indicates the current status of the "pass through" Connector.

- **Local: xx** – indicates the Network ID of the XLe/XLt to which the Cscape program is physically connected through its serial port. It can serve as a pass through device to other nodes on the network.
- **Target: yy(R)** – indicates the Network ID of the device with which the Cscape program is exchanging data.
Note: The **Local** unit and **Target** unit can be the same unit or they can be separate units.

The following are status indicators:

- (R) – Running
- (D) - Do I/O
- (I) – Idle
- (?) – Cscape is not communicating with the remote unit.
- [no forces] – indicates no I/O has been forced.

14.3 Establishing Communications

The main method for communicating between Cscape and an XLe/XLt is RS-232 serial. The XLe/XLt can communicate with Cscape using USB to serial adapters, Ethernet, CAN (CsCAN) or modems. For communications other than RS-232 serial please refer to the manual that ships with the adapter hardware being used for programming.

Start by configuring Cscape to use the correct communications port. This can be done using the **Tools | Options | Communication Port** dialog in Cscape.

Next connect the PC serial port to the port labeled MJ1 on the XLe/XLt.

If communications are successful, the target indicator should show the mode of the controller **Target: yy(R)** as shown in the status section above.

If the controller is not communicating you may need to set the target ID of the controller in Cscape or on the unit. The **Target ID** allows directing communications to a particular unit when multiple units are connected via a CsCAN network. Units without CsCAN network ports respond to any network ID and do not require the ID to be configured.

To check or change the ID on the XLe/XLt, press the UP and DOWN keys on the XLe/XLt simultaneously to enter the system menu. The first item in the menu is **Set Network ID**. Pressing **Enter** allows you to view or modify the ID of the unit.

To change the Target ID of Cscape use the **Controller | Set Target Network ID** dialog.

14.4 Models supported

At the time of printing Cscape 8.50 supports all models and options offered in the XLe/XLt line. For the latest version of Cscape or compatibility information, contact Technical Support (page 96).

14.5 Configuration

An overview of configuration:

- (1) Start the configuration by selecting the **Controller | I/O Configure** menu item.
- (2) If the XLe/XLt is connected to the PC press the **Auto Config System** button to automatically detect the Base model, I/O and any communication options.
- (3) If the XLe/XLt is not connected press the **Config** button to the right of the top of the unit. This allows the base CPU to be selected.
- (4) Select either **XLe/XLt Cscan** or **XLe/XLt No Net** from the type drop down box.
- (5) Once the type of XLe/XLt is selected, the model # drop down box will provide the XLe/XLt model numbers from which to choose from.
- (6) Once the XLe/XLt CPU is selected, press **OK** to exit the dialog and configure the I/O that is present in the first slot.
- (7) The I/O configure dialog (Specifically the **Module Setup** tab) provides 4 buttons to configure all of the I/O. Go through each area of I/O and configure it.
- (8) Once done configuring the I/O OK out of configuration dialogs.

Configuring the XLe/XLt I/O has four main portions that are covered in this chapter. For additional information on I/O, refer the chapters covering General I/O (page 33) or High Speed I/O (page 39) in this manual.

The four areas of I/O configuration are:

- Digital in / HSC
- Digital out / PWM
- Analog in
- Analog out

14.6 Digital Input / HSC Configuration

The following figure illustrates the **Digital Input / HSC Configuration** dialog.

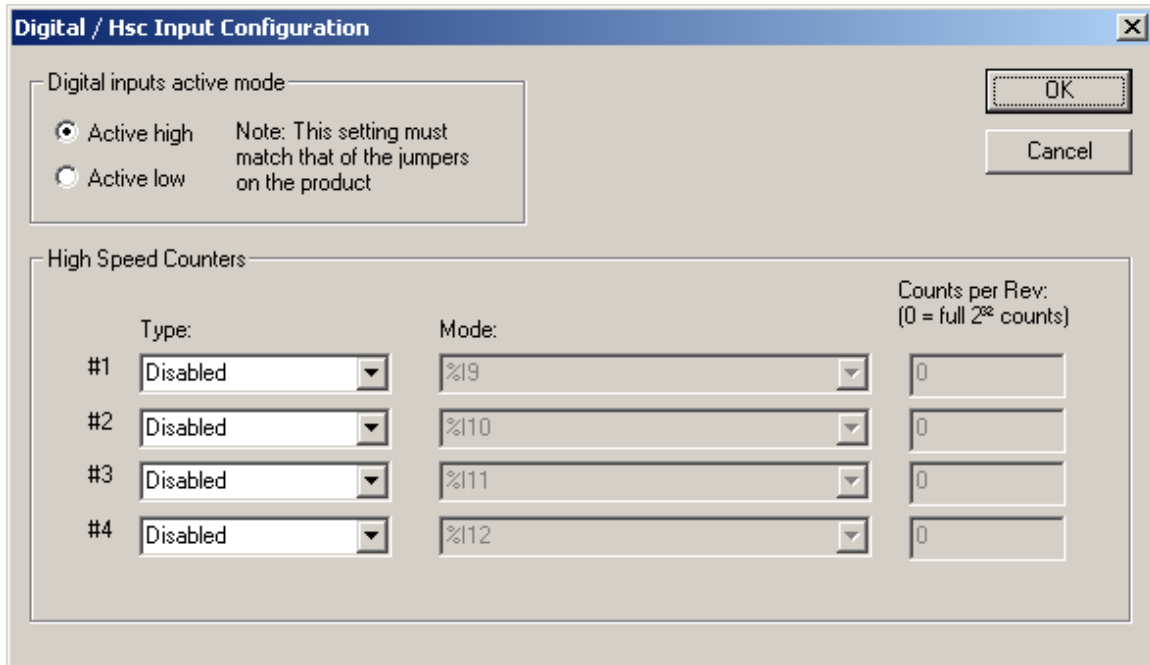

Figure 14-1 – Digital Input / HSC Configuration Dialog

The Active mode group box allows the user to select if inputs are active high (Positive logic) or active low (Negative logic). It is important that this setting match what the jumper settings are on the hardware.

The High Speed Counters group box contains all of the windows that are used for configuring the 4 available high speed counters on the XLe/XLt. In configuring a counter, the user needs to set the type, mode, and counts per rev.

The type drop down includes the following options:

- Disabled
- Frequency
- Totalize
- Pulse
- Quadrature
- Marker (Only available in counter #3 if counter #1 is set to quadrature.)

The mode drop-down items are set according to the type selection. The **Counts Per Rev.** window is enabled/disabled according to the type selection as well. The following table shows what is available with each type selection.

Table 14.1- Count Per Rev		
Type	Mode	Counts Per Rev.
Disabled	Grayed out. Displays %lx to indicate to the user that the input devoted to the high speed counter is just dumb I/O, and its location RELATIVE to the I/O map	Grayed out
Frequency	Enabled. Contains the following: 1 sec. 100 msec. 10 msec. Scan resolution	Grayed out
Totalize	Enabled. Contains the following: Rising edge Falling edge	Enabled. Value can be 0 → 0xffffffff (Hex)
Pulse	Enabled. Contains the following: Width high, 1µsec. Counts Width low, 1µsec. Counts Period rising edges, 1µsec. Counts Period falling edges, 1µsec. Counts	Grayed out
Quadrature	Enabled. Contains the following: 1 leads 2, count up 1 leads 2, count down	Enabled. Value can be 0 → 0xffffffff (Hex)
Marker	Enabled. Only available in counter #3 and only when counter #1 is set to quadrature. Contains the following: Async, reset on rising edge Async, reset on falling edge Async, reset on both edges High, reset on 1 rising Low, reset on 1 rising High, reset on 1 falling Low, reset on 1 falling High, reset on 2 rising Low, reset on 2 rising High, reset on 2 falling Low, reset on 2 falling	Grayed out

14.7 Digital Output / PWM Configuration

The following figure illustrates the **Digital Output / PWM Configuration** dialog.

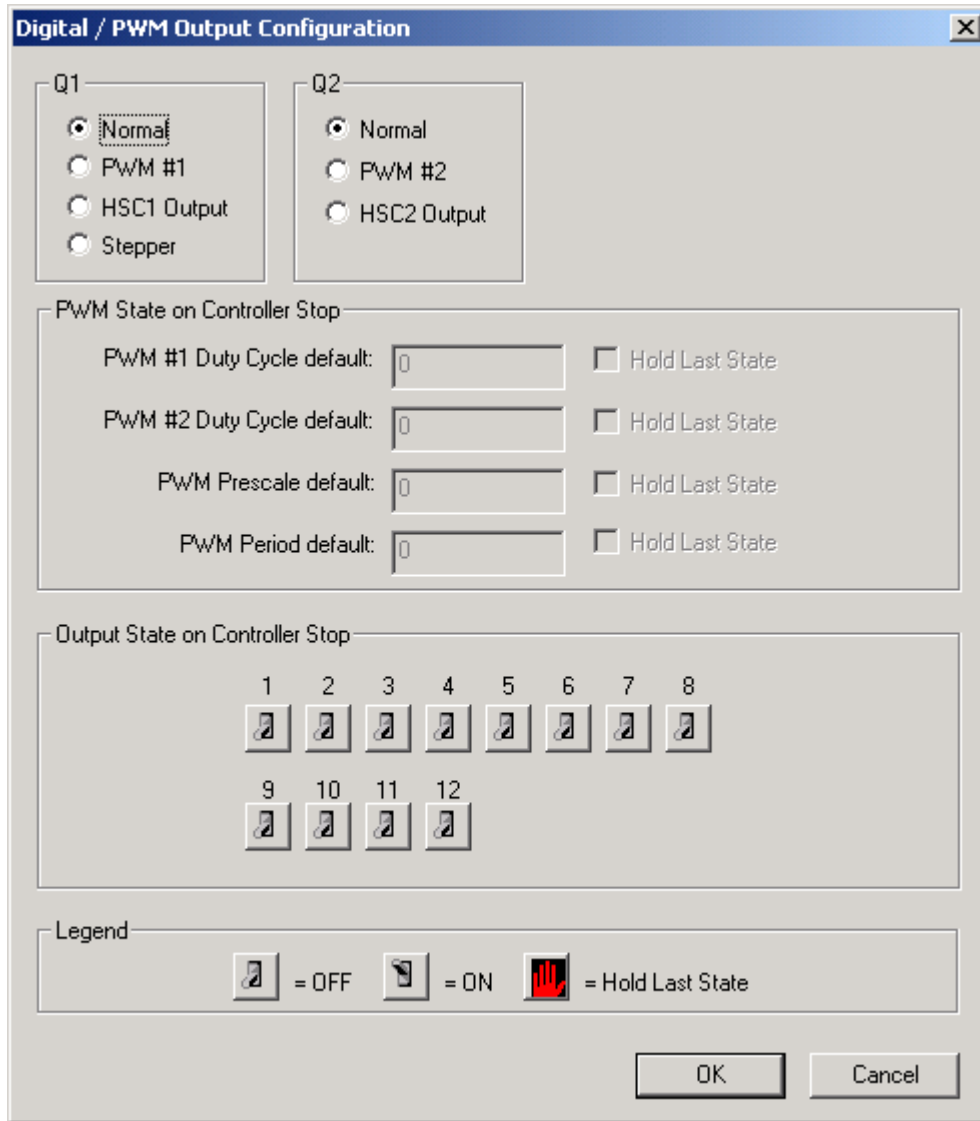

Figure 14-2 – Digital Output / PWM Configuration Dialog

The **Q1** and **Q2** group boxes allow the user to specify the operation of the multi-function outputs.

The **PWM State On Controller Stop** group box contains items that allow the user to specify how the PWM outputs behave when the controller is stopped. These items can either hold their value or default to some value when the controller is stopped.

Note that the PWM outputs are set to the OFF state at power-up and during program download and remain in that state until the unit is placed in RUN

The **Output State On Controller Stop** group box contains items to allow the user to specify how the remaining digital outputs behave when the controller is stopped. These items can either hold their value or default to some value when the controller is stopped.

14.8 Analog Input Configuration

The following figure illustrates the **Analog Input Configuration** dialog.

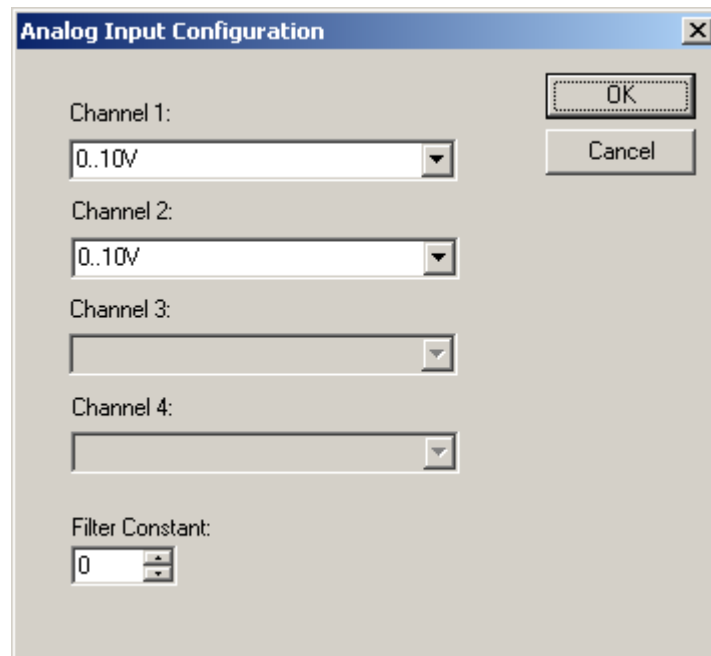

Figure 14-3 – Analog Input Configuration Dialog

The **Channel x** drop down windows allow the user to specify the mode for each analog input to operate. The **Channel x** drop down windows are enabled/disabled according to which model is being configured. All of the models have the following modes available:

- 0..10V
- 0..20mA
- 4..20mA

On model 005, channels 3 and 4 also have the following modes available:

- 100mV
- PT100 DIN RTD, 1/20°C
- Type J Thermocouple, 1/20°C
- Type K Thermocouple, 1/20°C
- Type N Thermocouple, 1/20°C
- Type T Thermocouple, 1/20°C
- Type E Thermocouple, 1/20°C
- Type R Thermocouple, 1/20°C
- Type S Thermocouple, 1/20°C
- Type B Thermocouple, 1/20°C

The **Filter Constant** provides filtering to all channels.

14.9 Analog Output Configuration

The following figure illustrates the **Analog Output** Configuration dialog.

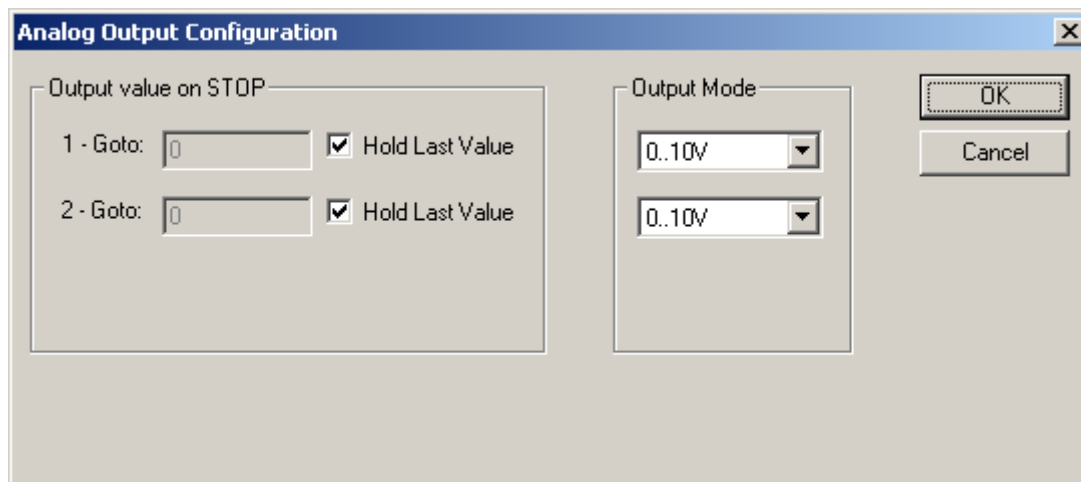

Figure 14-4 – Analog Output Configuration Dialog

The **Output value on Stop** group box contains items that allow the user to specify how the analog output channels behave when the controller is stopped. The outputs can either hold their value or default to a value when the controller is stopped.

The **Output Mode** group box allows the user to select the operating modes for each of the analog outputs. The modes include the following:

- 0..10V
- 0..20mA
- 4..20mA

NOTES

CHAPTER 15: FAIL – SAFE SYSTEM

15.1 Overview

The Fail-Safe System is a set of features that allow an application to continue running in the event of certain types of "soft" failures. These "soft" failures include:

- Battery power loss
- Battery-Backed Register RAM or Application Flash corruption due to, for example, an excessive EMI event.

The Fail-Safe System has the following capabilities:

- Manually backup the current Battery-Backed RAM Register Settings into Flash memory.
- Manually restore Register Settings from the values previously backed up in Flash to Battery-Backed RAM.
- Detect corrupted Register Settings at power-up and then automatically restore them from Flash.
- Detect corrupted or empty application in Flash memory at power-up and then automatically load the AUTOLOAD.PGM application file from Removable Media (Compact Flash or MicroSD).
- If an automatic Register Restore or Application Load occurs, the OCS can automatically be placed in RUN mode

The fail-safe system can be accessed by going to the system menu of the controller. A new menu "Fail-Safe System" has been added at the end of the main system menu for this. Selecting "Fail-Safe System" menu will open the following menu screen:

XLt:

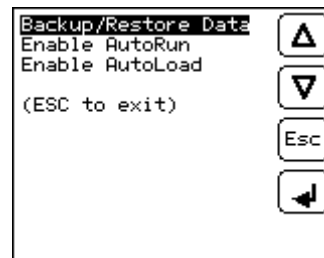

XLe:

```
Backup/Restore Data
Enable AutoRun
Enable AutoLoad
(ESC to exit)
```

Figure 15-1– Fail Safe System Menu

15.2 Settings

To use the fail – safe feature, the user needs to do the following:

1. Backup the current Battery-Backed RAM Register contents in On-Board Flash memory using System Menu options.
2. From Cscope, create AUTOLOAD.PGM for the application program using 'Export to Removable Media'.
3. Place the Removable Media with AUTOLOAD.PGM in the device.

4. Set the 'Enable AutoLoad' option in the device to YES.
5. Set the 'Enable AutoRun' option to YES if the controller needs to be placed in RUN mode automatically after automatic restore of data or AutoLoad operation.

15.3 Backup / Restore Data

Selecting this option brings up a screen having four operations:

- Backup OCS Data.
- Restore OCS Data.
- Clear Backup Data.
- Exit

XLe:



XLt:



Figure 15-2 – Backup / Restore Data

Backup OCS Data:

When initiated, this will allow the user to manually copy Battery-Backed RAM contents on to the onboard FLASH memory of the OCS. This will have the effect of backing up all the registers and controller settings (Network ID, etc.) that would otherwise be lost due to a battery failure. %SR164.4 is set to 1 when backup operation is performed.

XLe:



XLt:



Figure 15-3 – Backup Registers

Restore OCS Data:

When initiated, this will allow the user to manually copy the backed up data from the onboard FLASH to the Battery-Backed RAM.

A restore operation will be automatically initiated if a backup has been previously created and on power-up the Battery-Backed RAM registers fail their check.

The following process will be followed for restoring data:

- The controller will be placed in IDLE mode.
- Data will be copied from onboard FLASH to OCS Battery-Backed RAM
- The controller will reset.
- The controller will be put in RUN mode if the AutoRun setting is 'Yes' else it will remain in IDLE mode.

XLe:

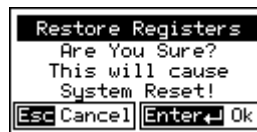

XLt:



Figure 15-4 – Restore OCS Data

%SR164.3 is set to 1 only when an automatic restore operation is performed - not on a manual one. This bit is reset to 0 when a new backup is created.

Restoring of data can be manually performed by selecting RESTORE option from the Backup / Restore Data menu. This will cause the controller to reset.

Clear Backup Data:

When initiated, the backup data will be erased from the onboard Flash and no backup will exist. %SR164.4 and %SR164.3 is reset to 0 when backed up data is erased.

XLe:

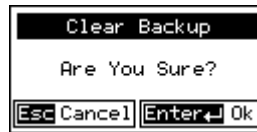

XLt:



Figure 15-5 – Clear Backup Data

Exit: Goes back to the previous screen.

The OCS follows the following sequence in execution of Automatic Restore:

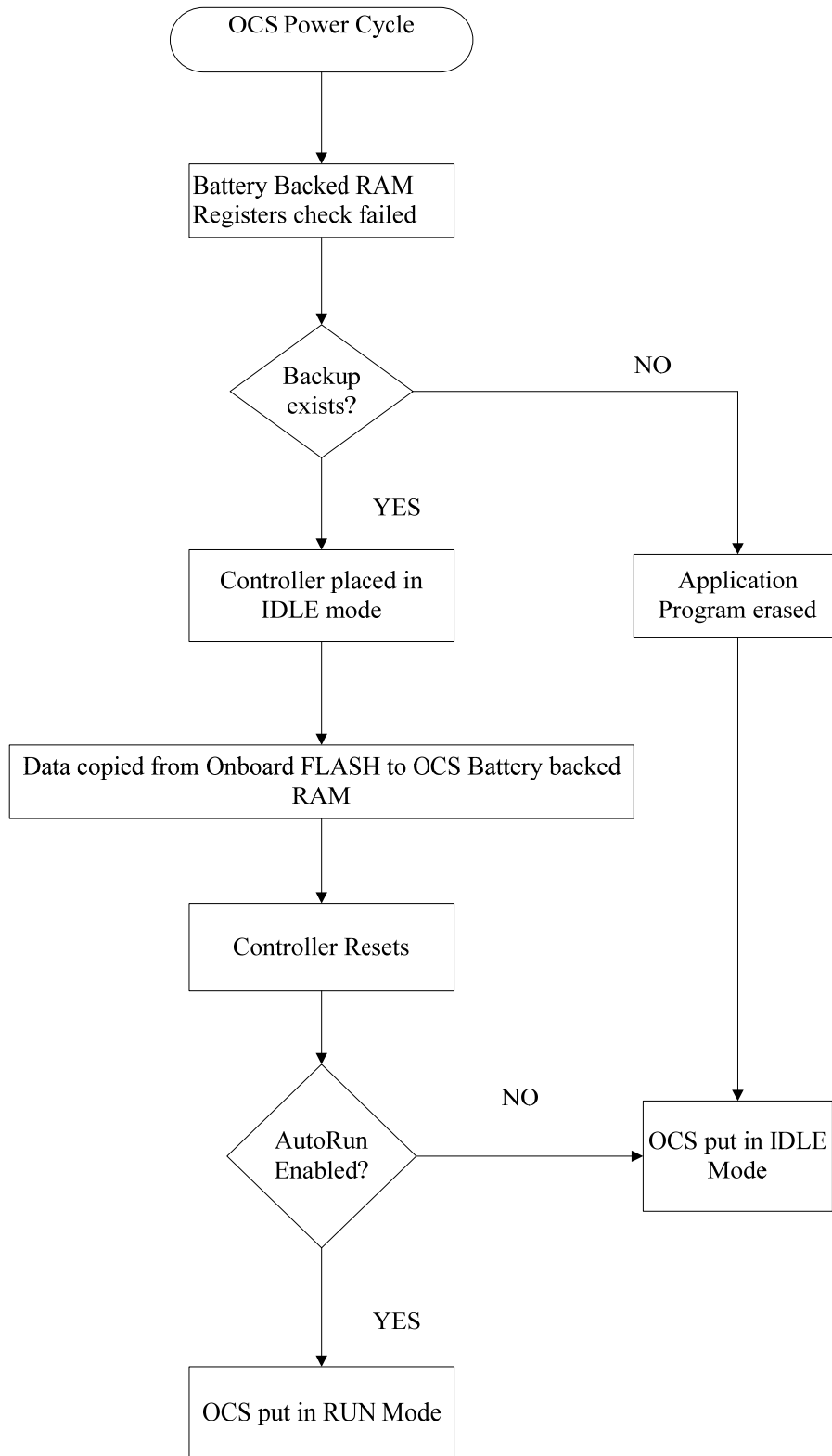

Figure 15-6 – Flow Chart for Automatic Restore

15.4 AutoLoad

This system menu option allows the user to specify whether the OCS automatically loads the application AUTOLOAD.PGM located in Removable Media.

When the AutoLoad setting is enabled (set to YES), it can either be manually initiated or automatically initiated at power-up.

The automatic initiation will happen only in the following two cases:

- When there is no application program in the OCS and a valid AUTOLOAD.PGM is available in the removable media of the device.
- When the program residing in onboard memory is corrupted and a valid AUTOLOAD.PGM is available in the removable media of the device.

AutoLoad can be manually initiated when the SYS-F3 key is pressed (OCS can be in any of the following mode – Idle / Run / DOIO). This also requires a valid AUTOLOAD.PGM to be present in the removable media of the device.

When the AutoLoad setting is not enabled (set to NO), OCS will be in IDLE mode and the application is not loaded.

If the AUTOLOAD.PGM is security enabled, the user will be prompted to enter the password before loading the application. The application will be loaded from the Removable media only after getting the correct password.

%SR164.6 can be set to enable AutoLoad feature.

XLe:

```

Enable AutoLoad      No
( AutoLoad from      )
( Removable Media's  )
( AUTOLOAD.PGM file )
( when triggered    )

```

XLt:

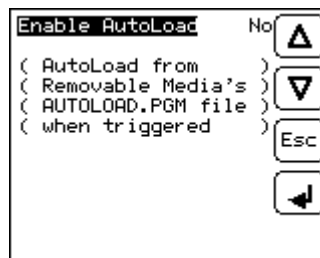

Figure 15-7 – AutoLoad Menu

The OCS follows the following sequence in execution of AutoLoad:

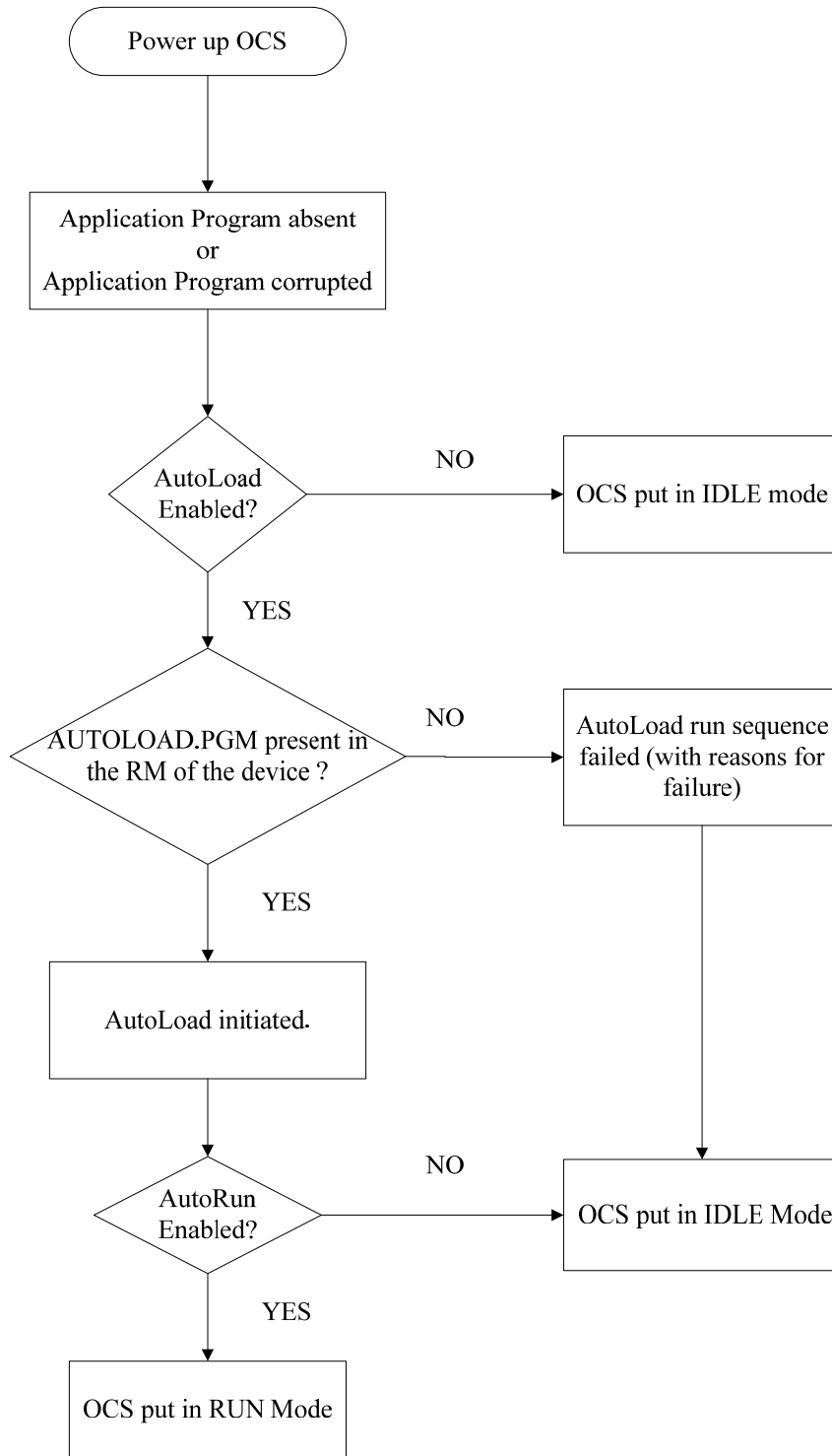

Figure 15-8 – Flow Chart for AutoLoad

15.5 AutoRun

This system menu option, when enabled (YES), allows the user to automatically place the OCS into RUN mode after the AutoLoad operation or automatic Restore Data operation.

When the AutoRun setting is disabled (NO), the OCS remains in the IDLE mode after a Restore Data or AutoLoad operation.

%SR164.5 can be set by putting the system into RUN mode automatically, once an AutoLoad has been performed or an Automatic Restore has occurred.

If for any reason the AutoLoad-Run (Loading the AUTOLOAD.PGM automatically and OCS put in RUN mode) sequence does not succeed, a pop-up message box saying "AUTO-LOAD-RUN SEQUENCE FAILED" will be displayed. It will also show the reason for its failure. On acknowledging this message box the AutoLoad-Run sequence will be terminated, controller will return to the first user-screen and will be placed in IDLE mode.

XLe:

```

Enable AutoRun      No
(*****CAUTION*****)
( Auto Enters RUN  )
( after AutoLoad  )
( or Battery Fail  )
    
```

XLt:

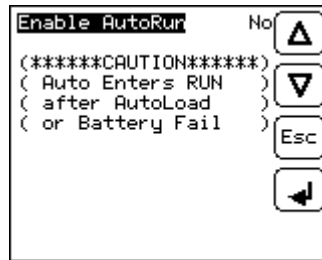

Figure 15-9 – AutoRun Menu

CHAPTER 16: CLONE UNIT

16.1 Overview

'Clone Unit' feature allows the user to "clone" the OCS of the exact same model. This feature "clones" application program and unit settings stored in Battery backed RAM of an OCS into the RM (refer Removable Media [Chapter 8](#) for details on using RM). It can then be used to clone a different OCS (exact same model).

This feature can be used for:

- Replacing an OCS by another unit of the same model.
- Duplicating or "clone" units without a PC.

16.2 Clone

User needs to perform the following to Clone:

1. The 'Clone Unit' can be accessed by going to the 'System Menu' of the OCS. A new menu "Clone Unit" has been added at the end of the main system menu as shown below:

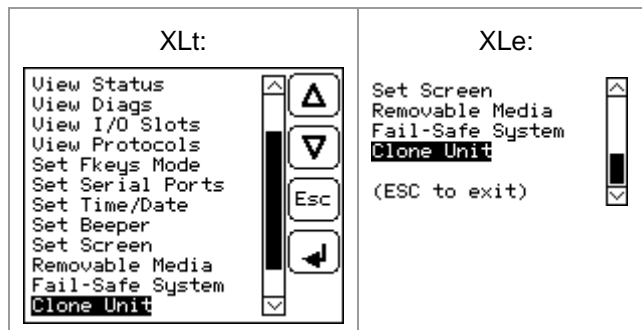

Figure 16-1 – System Menu

2. Selecting "Clone Unit" menu will open the following menu screen:

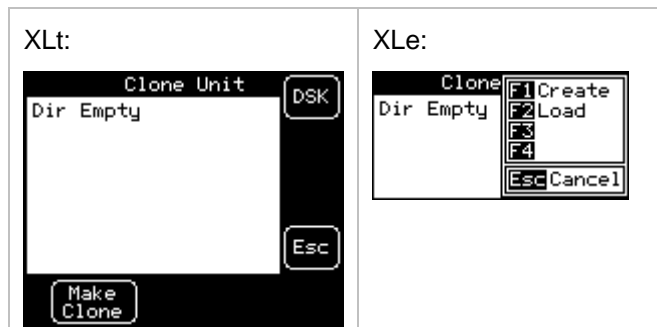

Figure 16-2 – Clone Unit Menu before Cloning

Note:

- a. In the above Figure16-2, F3 and F4 are inactive in Clone Unit.
- b. **DSK** – when selected shows number of total and free bytes in Removable Media.

- 3. Make/Create Clone option enables user to duplicate / Clone application file, all unit settings and all register values from Battery Backed RAM.

Selecting Make Clone brings up the screen below for the user:

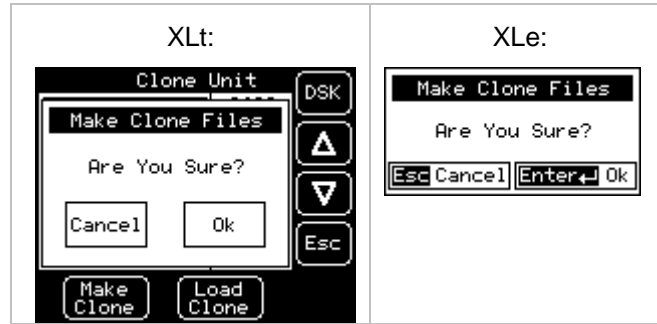

Figure 16-3 – Clone Unit Confirm Screen

After confirmation, the OCS will create two new files in the root directory of the Removable Media Drive as shown below:

AUTOLOAD.PGM
CLONE.DAT

Application file
File having all unit settings and register values from Battery Backed RAM

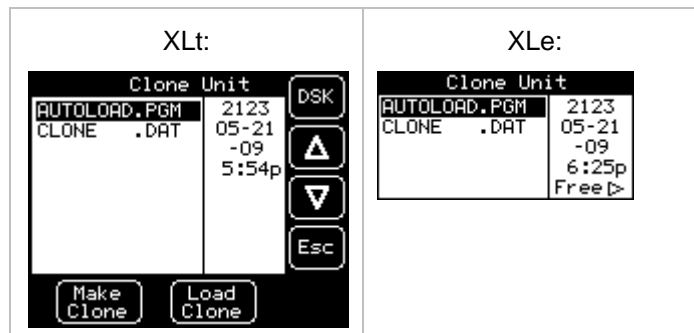

Figure 16-4 – Clone Unit Files

NOTE: Make/Create clone operation automatically includes the security in \AUTOLOAD.PGM file for security enabled files.

- 4. Once the cloning is successful, OCS gives a message as below:

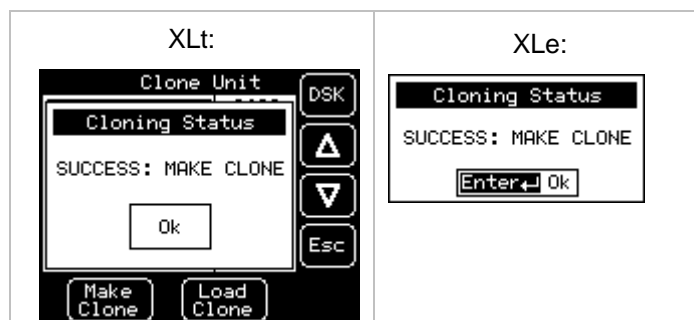

Figure 16-5 – Cloning Status

Make/Create clone can also be triggered by setting %SR164.9 bit to “1” from Ladder program or graphics. Once the operation is completed, this bit is made zero by the firmware. When Make clone operation is triggered by this SR bit, it does not ask the user for confirmation for making clone. The success / failure of the operation is also not notified on screen to the user.

In case of failure of “Make Clone” operation, %SR164.11 bit is set to “1” by the firmware and never reset.

NOTE: Backup of registers in flash memory is not performed by Clone Feature. If user desires, Backup should be done as explained in [Chapter 15](#) (Fail Safe System).

16.3 Load Clone

This option loads the application, all unit settings and register values from Removable media to the Battery backed RAM (Regardless of AutoLoad settings) and then resets the OCS for the settings to take effect.

User needs to perform the following to Load Clone:

1. Select “Clone Unit” from main system menu of OCS as shown below:

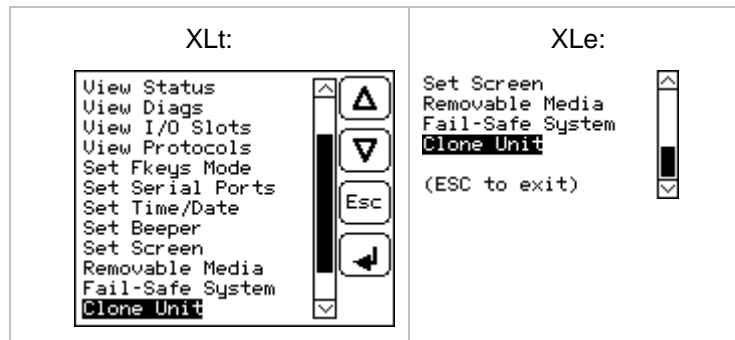

Figure 16-6 – System Menu

2. Selecting “Clone Unit” menu will open the following menu screen. Select “Load Clone”.

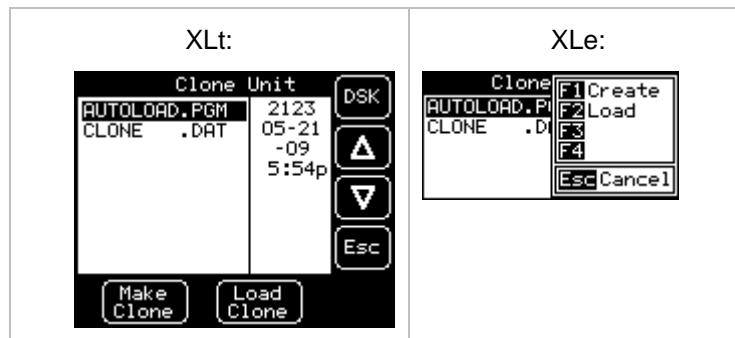

Figure 16-7 – Clone Unit Menu after Cloning

3. User needs to confirm Load Clone as shown below:

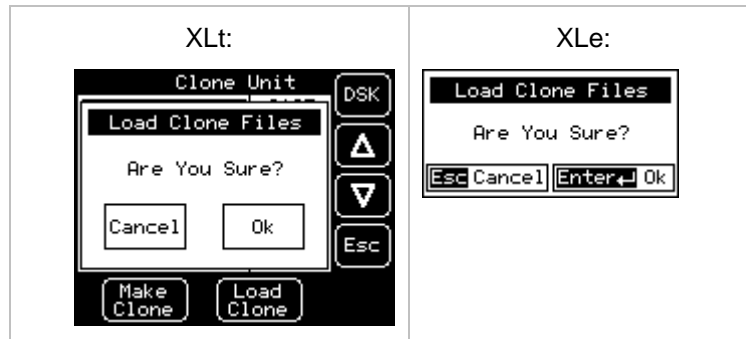

Figure 16-8 – Load Clone Confirm Screen

4. After confirmation, all unit settings and register values will be loaded from Removable media to the Battery backed RAM (Regardless of AutoLoad settings) and then OCS resets for the settings to take effect.

NOTE: For security enabled files, Load clone asks for password validation before loading the application.

Load clone can also be triggered by setting %SR164.10 bit to “1” from Ladder program or graphics. Once the operation is completed, this bit is made zero by the firmware. When Load clone operation is triggered by this SR bit, it does not ask the user for confirmation for loading clone. The success / failure of the operation is also not notified on screen to the user.

In case of failure of “Load Clone” operation, %SR164.12 bit is set to “1” by the firmware and never reset.

CHAPTER 17: MAINTENANCE

17.1 Firmware Updates

The XLe/XLt products contain field updatable firmware to allow new features to be added to the product at a later time. Firmware updates should only be performed when a new feature or correction is required.

Warning: Firmware updates are only performed when the equipment being controlled by the XLe/XLt is in a safe, non-operational state. Communication or hardware failures during the firmware update process can cause the controller to behave erratically resulting in injury or equipment damage. Make sure the functions of the equipment work properly after a firmware update before returning the device to an operational mode.

Steps for updating the firmware:

1. Establish communication between Cscape and the controller using a direct serial connection to MJ1.
2. Make sure your application is available on your PC or upload the application.
3. Make sure the machinery connected to the XLe/XLt is in a safe state for firmware update (see warning above).
4. Start the firmware update by selecting File | Firmware Update Wizard.
5. The correct product type should be selected, if it is not select the type of controller from the drop down list.
6. Press the start button.
7. Wait for the firmware update to complete.
8. If there is a communication failure check the cable, connections and comm. port setting and try again.
9. Firmware updates typically delete the user applications to ensure compatibility. You will need to reload your application.
10. Test the operation of the equipment with the new firmware before returning the XLe/XLt system to an operation mode.

17.2 Backup Battery

The XLe/XLt contains a run-time battery monitor that checks the voltage of the internal lithium battery. This battery is used to run the real-time clock and maintains retentive registers when power is disconnected.

Under normal conditions the battery in the XLe/XLt should last 7 to 10 years. Higher operating temperatures or variations in batteries may reduce this time.

17.2.1 *Indications the battery needs replacing*

The XLe/XLt indicates the battery is low, failed or missing in a variety of ways. At power-up, an error message is displayed indicating the low or missing battery. The user program can monitor the battery using %SR55.13. This bit will turn on if the battery is low or missing. The system menu also contains a battery status message under the diagnostics sub-menu (see the chapter on System Settings and Adjustments).

17.2.2 Battery Replacement

Warning: Lithium Batteries may explode or catch fire if mistreated
Do not recharge, disassemble, heat above 100 deg.C (212 deg.F) incinerate, or puncture.

Warning: Disposal of lithium batteries must be done in accordance with federal, state, and local regulations. Be sure to consult with the appropriate regulatory agencies *before* disposing batteries. In addition, do not re-charge, disassemble, heat or incinerate lithium batteries.

Warning: Do not make substitutions for the battery. Be sure to only use the authorized part number to replace the battery.

The XLe/XLt uses a CR2477 (Part No. HE-BAT14) coin lithium battery produced by a variety of manufacturers.

Below are the steps to replace the battery.

1. Make sure the user program and any data stored in retentive memory is backed up.
2. Disconnect all power from the XLe/XLt unit including I/O power.
3. Remove the four screws on the back of the XLe/XLt unit and remove the back cover.
4. Remove the I/O board (if present) by lifting it straight up.
5. Remove the old battery. It may require a small flat blade screwdriver to lift it from the holder.
6. Dispose of the battery properly; see the above warning on disposal regulations.
7. Slide the new battery into the holder. Make sure the battery is inserted with the proper polarity. The top tab of the battery holder should contact the positive (+) terminal of the battery.
8. Place the I/O board back into the case by aligning the connecting and pressing straight down.
9. Place the back cover back on the unit.
10. Place the screw back into the hole and turn the screw slowly counter clockwise until "clicks" into the threads. This will prevent the screw from being cross threaded. Now turn the screw clockwise until the cover is firmly secured. Repeat this process for all four (4) screws.
11. Apply power to the unit. Check that the battery error is no longer reported. If the unit still reports the error, remove the battery immediately and contact Technical Support (page 96).

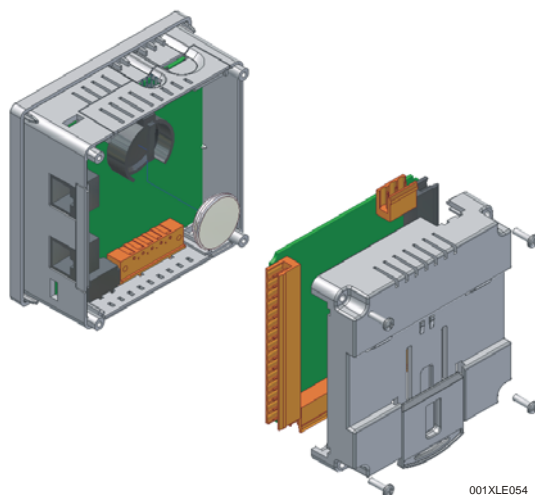

Figure 17-1 – Replacing the back-up battery

CHAPTER 18: TROUBLESHOOTING / TECHNICAL SUPPORT

CHAPTER 18 provides commonly requested **troubleshooting information and checklists** for the following topics.

- Connecting to the XLe/XLt controller
- Local controller and local I/O
- CsCAN Network
- Removable media

In the event that this information is not what you need, please contact Technical Support at the locations indicated at the end of this chapter.

18.1 Connecting to the XLe/XLt

Cscape connects to the local controller automatically when the serial connection is made. The status bar below shows an example of a successful connection. This status bar is located in the bottom right hand corner of the Cscape window.

Local:253 Target:253(R) [no forces]

In general the **Target** number should match the **Local** number. The exception to this is when the controller is being used as a "pass through" unit where other controllers on a CsCAN network could be accessed through the local controller.

Determine connection status by examining feedback next to **Local & Target** in the status bar of Cscape.

Local: ###	If a number shows next to Local then communication is established to the local controller.
Local: No Port	Cscape is unable to access the COM port of the PC. This could mean that Cscape is configured for a COM port that is not present or that another program has control of the COM port. Only one Cscape window can access a port at a time. Subsequent instances of Cscape opened will indicate No Port.
Local: No Com	Cscape has accessed a PC COM port, but is not communicating with the controller. This typically occurs when the controller is not physically connected.
Local: ???	Unknown communication error. Close Cscape, power cycle the controller and reopen Cscape with a blank project. Check Local.
Target: #(I,R,D)	If I (idle), R (run), or D (do I/O) shows next to Target number then communication is established to the target controller.
Target: #(?)	Communication is not established to the target controller. Check node ID of controller and set Target to match. Make sure local connection is established.

18.1.1 Connecting Troubleshooting Checklist

1. Programming and debugging must use MJ1.
2. Controller must be powered up.
3. Assure that the correct COM port is selected in Cscape. Tools/Options/Communications Port.
4. Assure that a straight through (non null modem) serial cable is being used between PC and controller.
5. Check that a Loaded Protocol or ladder is not actively using MJ1. Taking the controller out of run mode from the System Menu on the controller will make MJ1 available to Cscape.
6. Make sure the COM port of the PC is functioning. An RS-232 serial loopback and Microsoft HyperTerminal can determine positively if the COM port is working. Or connect to an alternate device to determine if the port is working.
7. Successful communications with USB-to-serial adapters vary. If in doubt, Horner APG offers a USB to serial adapter. Part number HE500USB600.
8. XLe/XLt units without Ethernet must use MJ1 for programming and debugging. If Ethernet is installed it can be selected as the programming port. The selection is made in the controller's System Menu. If there are difficulties connecting, make sure that the default programming port is set correctly with the connection method being attempted.

18.2 Local Controller and Local I/O

The system menu provides the following status indications that are useful for troubleshooting and system maintenance.

- Self-test results, diagnostics.
- RUN and OK status
- Network status and usage
- Average logic scan rate
- Application memory usage
- Loaded firmware versions
- Loaded protocols
- Removable media access

To view the system menu, press the UP and DOWN arrow keys simultaneously. See CHAPTER 11 for full details on the system menu diagnostic capabilities.

18.2.1 Local I/O Troubleshooting Checklist

1. Verify the controller is in RUN mode.
2. Check diagnostics to insure controller passed self-tests.
View diags in System Menu or in Cscape, click; Controller/Diagnostics
3. Check data sheets to insure proper wiring.
4. Insure that hardware jumpers and software configuration for I/O match.
5. Check data sheets for voltage and current limits.
6. Take ladder out of the picture. From Cscape set controller to "Do I/O" mode. In this mode inputs can be monitored and outputs set from a data watch window in Cscape without interference from the ladder program. Some I/O problems are only a result of a mistake in the ladder program.

WARNING: Setting outputs ON in Do I/O mode can result in injury or cause machinery to engage in an unsafe manner depending on the application and the environment.

18.3 CsCAN Network

For complete information on setting up a CsCAN network, refer to CAN Networks manual (MAN0799) by visiting our website (page 96) for the address to obtain documentation and updates.

Network status, node ID, errors, and baud rate in the controller system menu are all in reference to the CsCAN network. These indications can provide performance feedback on the CsCAN network and can also be used to aid in troubleshooting. Refer to CHAPTER 11 for full details on the system menu.

18.3.1 CsCAN Network Troubleshooting Checklist

1. Use the proper Belden wire type or equivalent for the network as specified in MAN0799.
2. The XLe/XLt does not provide 24VDC to the network. An external voltage source must be used for other devices such as SmartStix I/O.
3. Check voltage at both ends of the network to insure that voltage meets specifications of attached devices.
4. Proper termination is required. Use 121-ohm (or 120-ohm) resistors at each end of the network. The resistors should be placed across the CAN_HI and CAN_LO terminals.
5. Measure the resistance between CAN_HI and CAN_LO. If the network is properly wired and terminated there should be around 60 ohms.
6. Check for duplicate node ID's.
7. Keep proper wires together. One twisted pair is for V+ and V- and the other twisted pair is used for CAN_HI and CAN_LO.
8. Make sure the baud rate is the same for all controllers on the network.
9. Assure shields are connected at one end of each segment -- they are not continuous through the network.
10. Do not exceed the maximum length determined by the baud rate and cable type.
11. Total drop length for each drop should not exceed 6m (20 feet). A drop may include more than one node. The drop length adds to the overall network length.
12. Network should be wired in "straight line" fashion, not in a "star" pattern.
13. In applications requiring multiple power supplies, make sure the V- of all supplies is connected together and to earth ground at one place only.
14. In some electrically noisy environments it may be necessary to add repeaters to the network. Repeaters can be used to add additional nodes and/or distance to the network and protect the signal against noisy environments. The Horner APG repeater is part # HE200CGM100.

18.4 Removable Media

18.4.1 Basic Troubleshooting

Description	Action
XLe/XLt does not read media card.	The media card should be formatted with the XLe/XLt.
XLe/XLt will not download project file.	Make sure the project file is saved as a .pgm file and not a .csp file.

18.5 Technical Support Contacts

For manual updates and assistance, contact Technical Support at the following locations:

North America:

Tel: (317) 916-4274

Fax: (317) 639-4279

Web: www.heapg.com

Email: techspt@heapg.com

Europe:

Tel: (+) 353-21-4321-266

Fax: (+353)-21-4321826

Web: www.horner-apg.com

Email: tech.support@hornerapg.com

INDEX

- Accessories, 13
- Analog Inputs, 37
- Analog Outputs, 38
- AutoLoad, 84
- AutoRun, 86
- Back Cover Removal, 33
- Backup / Restore, 80
- Battery
 - Replacement, 92
 - Warnings, 92
 - When to Replace, 91
- Battery backed RAM, 62, 65, 87
- CAN Comm
 - Cscape Programming, 26
 - I/O Expansion (Network I/O), 26
 - Ladder-Controlled, 26
 - Overview, 25
 - Ports, 25
 - Wiring, 25
- CE, 10
- Clone Unit, 62, 65, 87
- CLONE.DAT**, 88
- Com Port Rediretor, 27
- Communication Options
 - Ethernet COM Module (XEC), 27
 - Modem COM Module (XMC), 28
 - Overview, 27
- Compliance
 - CE, 10
- Csape Program
 - Via Serial Port, 24
- Cscape
 - Analog In Configuration, 76
 - Analog Out Configuration, 77
 - Configuration Procedures, 72
 - Count per Rev, 74
 - Digital In / HSC Configuration, 73
 - Digital Out / PWM Configuration, 75
 - Establishing Communications, 72
 - Models Supported, 72
 - Overview, 71
 - Status Bar, 71
- Devices to Connect to XLe, 12
- Digital Inputs, 37
- Dimensions, 17
- Duty Cycle Examples, 48, 49
- Ethernet COM Module
 - XEC, 27
- Fail Safe System Overview, 79
- Fail Safe System Settings, 79
- Features, 12
- General I/O
 - Overview, 33
- Ground
 - Testing for Good, 21
- Ground Specification, 21
- Grounding
 - Locations of Information, 10
- Grounding Definition, 21
- High Speed
 - Configure Inputs, 39
 - Frequency, 39
- High Speed / PWM
 - Overview, 39
- Jumpers Example**, 34
- Load Clone, 89
- Make Clone, 87
- Map
 - Major Tasks, Key Chapters, 7
- Micro SD Cards, 29
 - Installing / Removing, 29
- Micro SD System, 29
- Model / I/O Overview, 34
- Modem COM Module Option, 28
- Mounting Orientation, 16
- Mounting Requirements, 15
 - DIN Rail Mounting, 16
 - Panel Door Mounting, 15
- Panel Box
 - Clearances, 18
 - Grounding, 18
 - Noise, 19
 - Orientation, 19
 - Temperature, 18
- Panel Box Shock and Vibration, 19
- Panel Cut-out, 17
- Panel Design Checklist, 19
- Panel Layout / Clearances, 18
- Primary Power Port, 22
- Pulse, 40
- PWM
 - Examples, 48, 49
 - Frequency Formula, 45, 47
 - Highest Usable Frequency 65kHz, 50
 - Maximum Usable Frequency 65kHz, 50
 - Registers, 48
- Quadrature, 41
- References / Useful documents, 14
- Registers
 - %S / %SR, 68
 - Definitions, 67
 - I/O, 69
 - Resource Limits, 70
- Relay Outputs, 35
- Removable Media
 - Load / Save Applications, 30
 - Log Data, 30
 - Overview, 29

- Save Applications XLe, 30
- Save Applications XLt, 30
- View / Capture, 31
- Removable Media Manager, 30
- Removable Media XLe, 60
- Removable Media XLt, 61
- RS-485 Biasing, 24
- RS-485 Termination, 24
- Safety Warnings, Guidelines, 9
- Serial Comm
 - Cscape Programming, 24
 - Downloadable Protocols, 24
 - Ladder-Controlled, 24
 - Overview, 23
 - Ports, 23
 - Wiring, 23
- Set Beeper - XLt, 60
- Solid-State Digital Outputs, 35
- Sub-Menus, 51
- System Menu
 - Details, 53
 - Navigate / Edit, 52
- System Menu
 - Overview, 51
- Technical Support
 - Contacts, 98
- Totalize, 39
- Toubleshooting
 - Connecting Checklist, 96
- Troubleshooting
 - CsCAN Checklist, 97
 - CsCAN Network, 97
 - Local I/O Checklist, 96
 - Removable Media, 98
- Universal Analog Inputs, 38
- User Interface
 - Editable Screen Objects, 64
 - Ladder Based Navigation, 64
 - Screen Navigation, 63
- Visual Overview of XLe and Topics, 11
- Where to Find Information, 11
- XEC, 27
- XMC, 28

TABLE OF FIGURES

Figure 2-1 – Visual Overview of XLE/XLT and Topics of Interest Covered in the User Manual	11
Figure 2-2 – Visual Overview of Types of Devices that can be connected to XLe/XLt	12
Figure 3-1 – Panel Mounting of the XLe/XLt and Close-up View of Back	15
Figure 3-2 – DIN Rail Mounting of the XLe/XLt.....	16
Figure 3-3 – Orientation of XLe/XLt OCS	16
Figure 3-4 – XLe/XLt Panel Cut-out.....	17
Figure 3-5 – XLe/XLt Dimensions	17
Figure 4-1 – Two-Point Ground Connection Test	21
Figure 4-2 – Power Connector (Primary Power Port)	22
Figure 4-3 – As Viewed Looking at the XLe/XLt	22
Figure 5-1 – MJ Serial Port Connector	23
Figure 6-1 – NET1 Port Connector	25
Figure 8-1 – Installing Removable Memory Card	29
Figure 9-1 – Removing the Back Cover	33
Figure 9-2 – Example Jumper Diagram	34
Figure 9-3 – Typical Output Wiring	35
Figure 11-1 – System Menu (XLe).....	51
Figure 11-2 – System Menu (XLt).....	52
Figure 12-1 – Typical Screen Jump Object (XLe).....	63
Figure 12-2 – Typical Screen Jump Object (XLt).....	63
Figure 12-3 – Force and Switch Coils in Ladder Programming	64
Figure 14-1 – Digital Input / HSC Configuration Dialog	73
Figure 14-2 – Digital Output / PWM Configuration Dialog	75
Figure 14-3 – Analog Input Configuration Dialog.....	76
Figure 14-4 – Analog Output Configuration Dialog.....	77
Figure 15-1– Fail Safe System Menu	79
Figure 15-2 – Backup / Restore Data	80
Figure 15-3 – Backup Registers	81
Figure 15-4 – Restore OCS Data.....	81
Figure 15-5 – Clear Backup Data	82
Figure 15-6 – Flow Chart for Automatic Restore	83
Figure 15-7 – AutoLoad Menu	84
Figure 15-8 – Flow Chart for AutoLoad.....	85
Figure 15-9 – AutoRun Menu.....	86
Figure 16-1 – System Menu.....	87
Figure 16-2 – Clone Unit Menu before Cloning	87
Figure 16-3 – Clone Unit Confirm Screen.....	88
Figure 16-4 – Clone Unit Files	88
Figure 16-5 – Cloning Status	89
Figure 16-6 – System Menu.....	89
Figure 16-7 – Clone Unit Menu after Cloning	89
Figure 16-8 – Load Clone Confirm Screen	90
Figure 17-1 – Replacing the back-up battery.....	92

Information in this document is subject to change without notice. This document is the property of Horner APG and shall not be modified as to content unless specifically authorized.

