

XLE/XLEe & XLT/XLTe - Model 3

12 DC In, 12 DC Out, 2 – 12-bit Analog In

MAN1114-22-EN_XLET_Mod3



Find the manuals via the [Documentation Search](#) page on the Horner website.

Part Numbers

Global Part Numbers	
XLE - Model 3	HE-XE103
XLEe - Model 3 with Ethernet	HE-XE1E3
XLT - Model 3	HE-XT103
XLTe - Model 3 with Ethernet	HE-XT1E3
European Part Numbers	
XLE - Model 3	HEXE220C113
XLEe - Model 3 with Ethernet	HEXE221C113
XLT - Model 3	HEXT240C113
XLTe - Model 3 with Ethernet	HEXT241C113

Accessories and Add-Ons

Part #	Description
HE-BAT009	CR2450 Lithium Coin Battery
HE-XCK	Programming Cables
HE-XDAC	2 channel Analog Output I/O option kit, selectable 0-10V, +/-10V, 4-20mA.
HE-XDAC107	4 channel Analog Output I/O option kit, selectable 0-10V, +/-10V, 4-20mA.
HE-XKIT	Blank I/O Board
HE200MJ2TRM	Adapter, RJ45 (8P8C) male to 8-position terminal strip.
HE-FBD001	Ferrite core for filtering out electrical noise.

XLE/XLT User Manual - MAN0878

Find the user manual via the [Documentation Search](#) page on the Horner website.

Table of Contents

TECHNICAL SPECIFICATIONS	2
General Specifications	2
Control and Logic	2
User Interface	2
Connectivity	2
CONTROLLER OVERVIEW	3
Overview of XLE and XLT	3
Power Wiring	3
Model 3 Specifications	4
Digital DC Input	4
Digital DC Outputs	4
Analog Inputs	4
WIRING: INPUTS AND OUTPUTS	5
Analog Inputs Information	5
Digital Inputs	5
Jumper Settings for Model 3	5
JP1 Digital DC Inputs	5
JP3 Analog In	5
Back Panel Torque Ratings	5
J1 Wiring - Digital In / Analog In	6
Built-In I/O	6
J2 Wiring - Digital Out	6
Wiring Details	6
Analog Input Tranzorb Failure	6
COMMUNICATIONS	7
Serial Communication	7
Ethernet	7
CAN Communications	7
Dip Switches	7
DIMENSIONS & INSTALLATION	8
Dimensions & Panel Cutout	8
Installation Information	8
Installation Procedure	8
Battery Maintenance	8
SAFETY & MAINTENANCE	9
Warnings	9
FCC Compliance	9
Technical Support	9
Precautions	9

TECHNICAL SPECIFICATIONS

General Specifications

Primary Power Range	10-30VDC
Max. Current	500mA, Class 2 750mA, Class 2 with heater*
Required Power (Steady State)	130mA @ 24VDC
Inrush Current	30A for < 1ms
Typical power back-light 100%	136mA @ 10V (1.36 W) 64mA @ 24V (1.53 W)
Power Backlight Off	15mA @ 24V (0.36 W)
Power Ethernet Models	35mA @ 10V (0.35 W) 20mA @ 24V (0.48 W)
Heater Option*	250mA @ 24VDC with heater*
Real Time Clock	Battery backed; lithium coin cell CR2450
Clock Accuracy	+/- 90 Secs/Month
Relative Humidity	5 to 95% Non-condensing
Operating Temp.	-10°C to +60°C
Storage Temp.	-20°C to +70°C
Weight	0.75 lbs/ 340 g (without I/O)
Altitude	Up to 2000m
Rated Pollution Degree	Evaluated for Pollution Degree 2 Rating
Certifications (UL/CE)	North America or Europe
Enclosure Type	1, 3R, 4, 4X, 12, 12K & 13

*Heater Option (Model # plus "-22")

Control and Logic

Control Lang. Support	Register-Based Advanced Ladder; Variable-Based Advanced Ladder; IEC 61131-3 Languages
Logic Program Size	256kB
Scan Rate	0.7ms/kB logic (XLE) 0.8ms/kB logic (XLT)
Digital Inputs	2048
Digital Outputs	2048
Analog Inputs	512
Analog Outputs	512
Gen. Purpose Registers	9,999 (words) Retentive 2,048 (bits) Retentive 2,048 (bits) Non-retentive

User Interface

Display Type	Transflective LCD Sun- light Readable
Resolution	128 x 64 pixels (XLEe) 160 x 128 pixels (XLTe)
Color	Monochrome
Built-In Storage	16 MB
User-Program. Screens	1023 max pages; 50 objects per page
Backlight	LED
Backlight Lifetime	30,000+ hrs
Brightness Control	0-100% (XLT) On/Off (XLE) via System Register %SR57
Number of Keys	20 (XLE) 5 (XLT)
Touchscreen (XLTe)	Resistive 1,000,000+ touch life

Connectivity

Serial Ports	RS-232 full handshaking or RS-485 half duplex on first Modular Jack (MJ1) RS-232 or RS-485 on second Modular Jack (MJ2)
USB Mini-B	Programming only
CAN	1 x CAN Port, Isolated 1 kV
CAN Protocols	CsCAN, CANopen, DeviceNet, J1939
Ethernet	Ethernet versions only (XLEe & XLTe)
Ethernet Protocols	TCP/IP, Modbus TCP, FTP, SRTP, EGD, ICMP, ASCII
Remote I/O	SmartRail, SmartStix, SmartBlock, SmartMod
Removable Memory	MicroSD, SDHC, SDXC, IN FAT32 format, support for 32 GB max. Application Updates, Datalogging
Audio (XLTe only)	Beeper, System or Software Controlled

CONTROLLER OVERVIEW

Overview of XLE and XLT



1. Function Keys
2. Touchscreen
3. Navigation Keys
4. USB Mini-B Port
5. High Capacity microSD Slot
6. RS232/RS485 Serial Ports (2)
7. Wide-Range DC Power
8. CAN Port
9. Ethernet LAN Port (XLEe and XLTe only)
10. Optional Built-In I/O (Models 2-6 only)
11. Configuration Switches
12. Mounting Clip Locations
13. DIN Rail Clip
14. Softkeys



NOTE: See Precaution #12 on about USB and grounding.

Power Wiring

NOTE: The Primary Power Range is 10VDC to 30VDC.

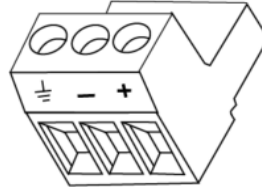

Primary Power Port Pins		
PIN	Signal	Description
1	Ground	Frame Ground
2	DC-	Input Power Supply Ground
3	DC+	Input Power Supply Voltage

DC Input / Frame

- Solid/Stranded Wire: 12-24 awg (2.5-0.2mm)
- Strip length: 0.28" (7mm)
- Torque, Terminal Hold-Down Screws: 4.5 – 7 in-lbs (0.50 – 0.78 N-m)
- DC- is internally connected to I/O V-, but is isolated from CAN V-. A Class 2 power supply must be used.

Power Up

1. **OPTION:** Attach ferrite core with a minimum of two turns of the DC+ and DC- signals from the DC supply that is powering the controllers.



2. Connect to earth ground.
3. Apply recommended power.

Model 3 Specifications

Digital DC Input

Inputs per Module	12 Including 4 Configurable HSC Inputs	
Commons per Module	1	
Input Voltage Range	12VDC / 24VDC	
Absolute Max. Voltage	30VDC Max.	
Input Impedance	10k Ω	
Input Current	Positive Logic	Negative Logic
Upper Threshold	0.8mA	-1.6mA
Lower Threshold	0.3mA	-2.1mA
Max. Upper Threshold	8VDC	
Min. Lower Threshold	3VDC	
OFF to ON Response	1ms	
ON to OFF Response	1ms	
High Speed Counter Max Freq	500kHz	

Digital DC Outputs

Outputs per Module	12 Including 2 Configurable PWM Outputs
Commons per Module	1
Output Type	Sourcing / 10k Ω Pull-Down
Output Frequency	500kHz
Absolute Max. Voltage	28VDC Max.
Output Protection	Short Circuit
Max. Output Current/Point	0.5A
Max. Total Current	4A Continuous
Max. Output Supply Voltage	30VDC
Min. Output Supply Voltage	10VDC
Max. Voltage Drop at Rated Current	0.25VDC
Max. Inrush Current	650mA per Channel
Min. Load	None
OFF to ON Response	1ms
ON to OFF Response	1ms
Output Characteristics	Current Sourcing (Pos. Logic)
PWM Out	\approx 5kHz
Rise Time	50 - 115 μ s
Fall Time	8-20 μ s

Analog Inputs

Number of Channels	2
Input Ranges	0 – 10VDC 0 – 20mA 4 – 20mA
Safe Input Range	-0.5V to +12V
Input Impedance (Clamped @ -0.5 VDC to 12 VDC)	Current Mode: 100 Ω Voltage Mode: 500k Ω
Nominal Resolution	12 Bits
%AI full scale	0V, 20mA, 100mV: 32,000 counts full scale
Max. Over-Current	35mA
Conversion Speed	All channels converted once per ladder scan
Max. Error @25°C (excluding zero)	4-20mA 1.00% 0-20mA 1.00% 0-10VDC 0.50%
Filtering	160Hz hash (noise) filter 1-128 scan digital running average filter

WIRING: INPUTS AND OUTPUTS

Analog Inputs Information

Raw input values for channels 1-4 are found in the registers as Integer-type data with a range from 0 – 32000.

Analog inputs may be filtered digitally with the Filter Constant found in the Cscape Hardware Configuration for Analog Inputs. Valid filter values are 0-7 and act according to the following chart:

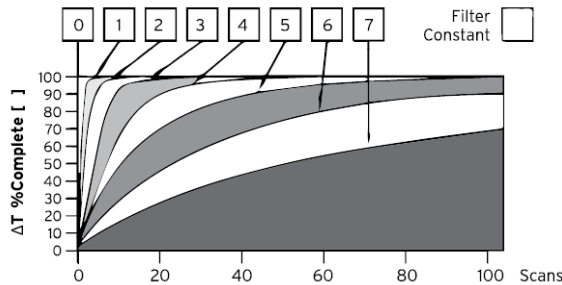

Data Values	
Input Mode:	Data Format, 12-bit INT:
0-20mA, 4-20mA	0-32000
0-10V	0-32000

Digital Inputs

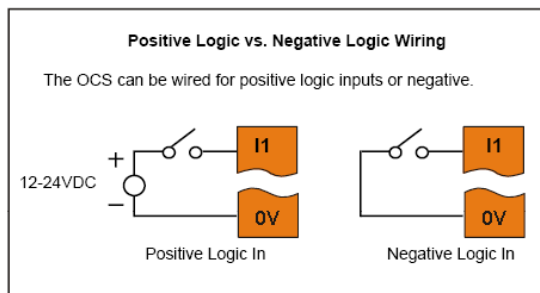

Digital inputs may be wired in either a Positive Logic or Negative Logic fashion as shown. The setting in the Cscape Hardware Configuration for the Digital Inputs must match the wiring used in order for the correct input states to be registered. When used as a normal input and not for high speed functions, the state of the input is reflected in registers %I1 – %I12.

Jumper Settings for Model 3

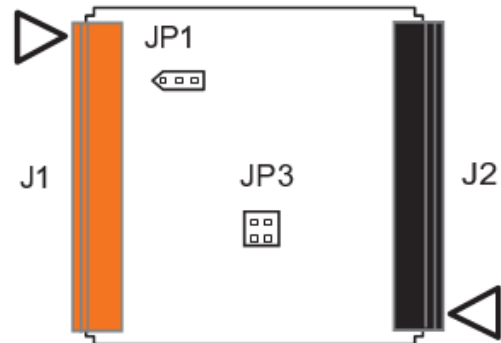

Location of I/O jumpers (JP1 & JP3) and wiring connectors (J1, J2, J3 & J4) with back cover removed.

JP1 Digital DC Inputs

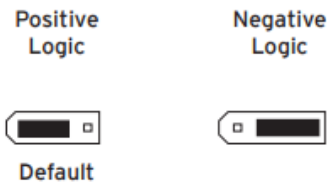

JP3 Analog In

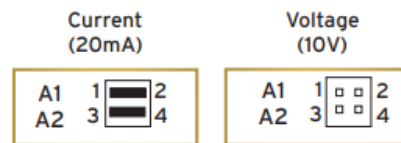

NOTE: The Cscape Module Configuration must match the selected I/O (JP) jumper settings.
NOTE: When using JP3 (A1-A2), each channel can be independently configured.

Back Panel Torque Ratings

- XLE/XLT:** 3.0 - 4.0 in-lbs (0.34 - 0.45 N-m)
- XL4/XL4 Prime:** 3.0 - 4.0 in-lbs (0.34 - 0.45 N-m).
- EXL6/XL6 Prime:** 3.0 - 4.0 in-lbs (0.34 - 0.45 N-m)
- EXLW/ XLW Prime:** 3.0 - 3.5 in-lbs (0.34 - 0.40 N-m)
- XL7/XL7 Prime:** 3.0 - 3.5 in-lbs (0.34 - 0.40 N-m)
- EXL10/XL10 Prime:** 3.0 - 3.5 in-lbs (0.34 - 0.40 N-m)

J1 Wiring - Digital In / Analog In

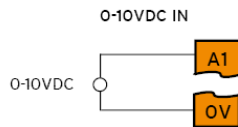
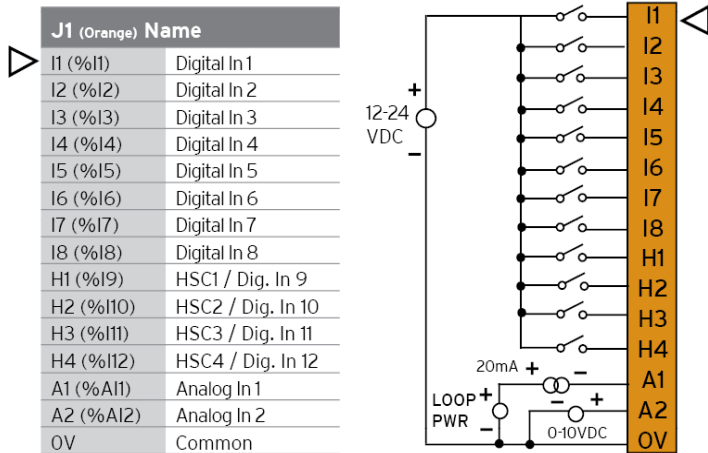

20mA Analog In - Self Powered

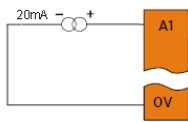

20mA Analog In - Not Self Powered

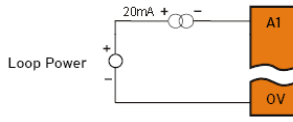

J2 Wiring - Digital Out

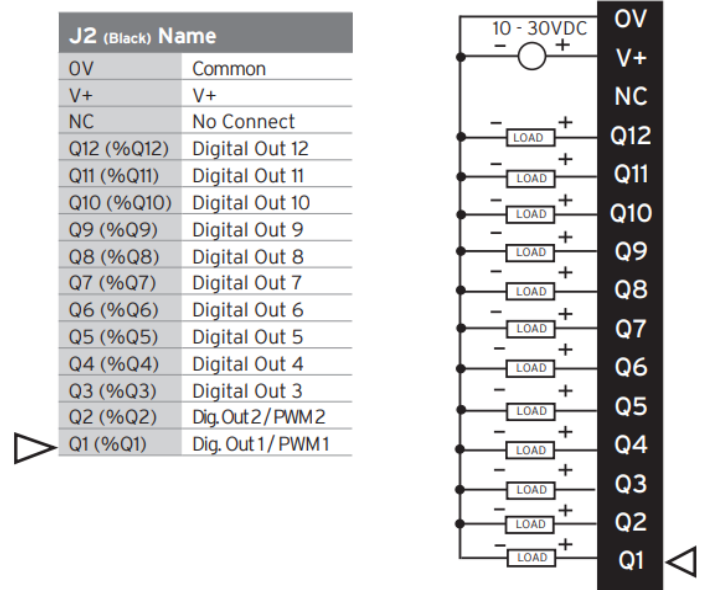

Wiring Details

Solid/Stranded Wire: 12-24 awg (2.5-0.2mm²).

Strip Length: 0.28" (7mm).

Torque, Terminal Hold-Down Screws: 4.5 – 7 in-lbs (0.50 – 0.78 N-m).

Built-In I/O

The I/O is mapped into OCS Register space, in three separate areas: Digital/Analog I/O, High-Speed Counter I/O, and High-speed Output I/O. Digital/Analog I/O location is fixed starting at 1, but the high-speed counter and high-speed output references may be mapped to any open register location.

Digital and Analog I/O Function Registers	
Digital Inputs	%I1-12
Reserved	%I13-31
ESCP Alarm	%I32
Digital Outputs	%Q1-12
Reserved	%Q13-24
Analog Inputs	%AI1-2
Reserved	%AI3-12
Analog Outputs	n/a
Reserved	%AQ1-8

Analog Input Tranzorb Failure

A common cause of Analog Input Tranzorb Failure on Analog Inputs Model 2, 3, 4 & 5: If a 4- 20mA circuit is initially wired with loop power, but without a load, the analog input could see 24VDC. This is higher than the rating of the tranzorb. This can be solved by NOT connecting loop power prior to load connection, or by installing a low-cost PTC in series between the load and analog input.

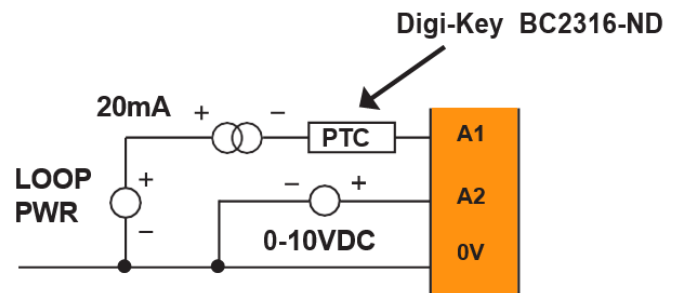

COMMUNICATIONS

Serial Communication

MJ1 Wiring

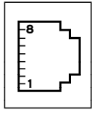

RS-232 with full handshaking or RS-485 half-duplex
RS-485 termination via switches; biasing via software

MJ1 Pins		
PIN	SIGNAL	DIRECTION
8	TXD	OUT
7	RXD	IN
6	0V	GROUND
5	+5V @ 60mA	OUT
4	RTS	OUT
3	CTS	IN
2	RX-/TX-	IN/OUT
1	RX+/TX+	IN/OUT

MJ2 Wiring

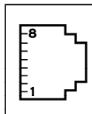

RS-232 or **RS-485** half or full-duplex, software selectable
RS-485 termination via switches; biasing via software

MJ2 Pins		
PIN	SIGNAL	DIRECTION
8	232 TXD	OUT
7	232 RXD	IN
6	0V	GROUND
5	+5V @ 60mA	OUT
4	485 TX-	OUT
3	485 TX+	IN
2	485 RX- or RX/TX-	IN or IN/OUT
1	485 RX+ or RX/TX+	IN or IN/OUT

NOTE: Attach optional [ferrite core](#) with a minimum of two turns of serial cable.

Ethernet

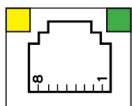

Green LED indicates link - when illuminated, data communication is available.
Yellow LED indicates activity - when flashing, data is in transmission.

CAN Communications

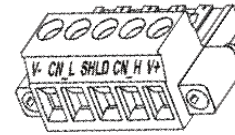

CAN Pin Assignments		
PIN	SIGNAL	DESCRIPTION
1	V-	CAN Ground – Black
2	CN_L	CAN Data Low – Blue
3	SHLD	Shield Ground – None
4	CN_H	CAN Data High – White
5	V+ (NC)	No Connect – Red

- **Solid/Stranded Wire:** 12-24 awg (2.5-0.2mm).
- **Strip Length:** 0.28" (7mm).
- Locking spring-clamp, two-terminators per conductor.
- **Torque, Terminal Hold-Down Screws:** 4.5 – 7 in-lbs (0.50 – 0.78 N-m).
- V+ pin is not internally connected, the SHLD pin is connected to Earth ground via a 1MΩ resistor and 10 nF capacitor.

Dip Switches

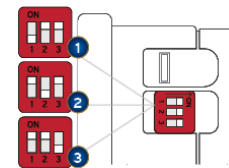

DIP Switches			
PIN	NAME	FUNCTION	DEFAULT
1	MJ1 RS-485 Termination	ON = Terminated	OFF
2	MJ2 RS-485 Termination	ON = Terminated	OFF
3	Bootload	Always Off	OFF

The DIP switches are used to provide a built-in termination to both the MJ1 port and MJ2 port if needed. The termination for these ports should only be used if this device is located at either end of the multidrop/daisy-chained RS-485 network.

DIMENSIONS & INSTALLATION

Dimensions & Panel Cutout

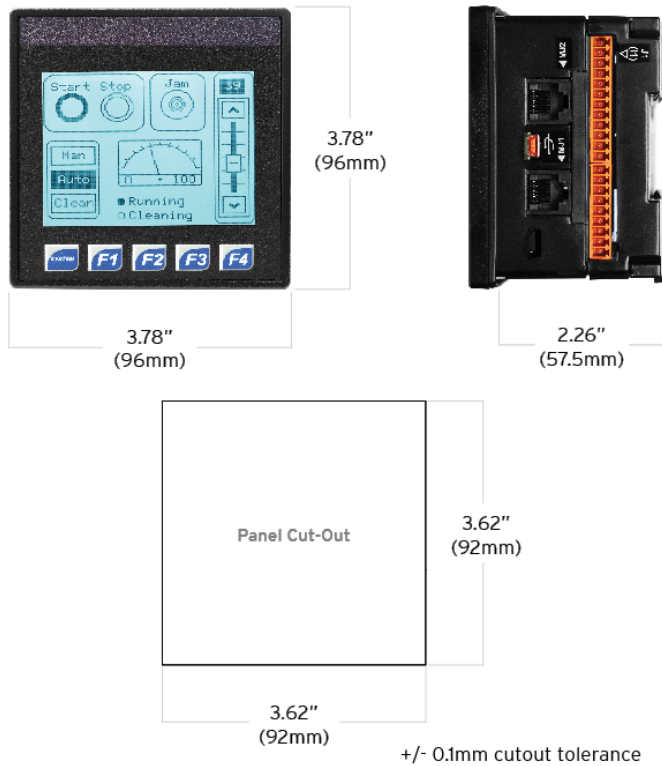

Installation Procedure

1. Carefully locate an appropriate place to mount the XLE/XLT. Be sure to leave enough room at the top of the unit for insertion and removal of the microSD™ card.
2. Carefully cut the host panel per the diagram, creating a 92mm x 92mm +/-0.1 mm opening into which the XLE/XLT may be installed. If the opening is too large, water may leak into the enclosure, potentially damaging the unit. If the opening is too small, the OCS may not fit through the hole without damage.
3. Remove any burrs and or sharp edges and ensure the panel is not warped in the cutting process.
4. Remove all Removable Terminals from the XLE/XLT. Insert the XLE/XLT through the panel cutout (from the front). The gasket must be between the host panel and the XLE/XLT.
5. Install and tighten the four mounting clips (provided in the box) until the gasket forms a tight seal (NOTE: Max torque 0.8 to 3 Nm, or 7-10 in-lbs).
6. Reinstall the XLE/XLT I/O Removable Terminal Blocks. Connect communications cables to the serial port, USB ports, Ethernet port, and CAN port as required.

Installation Information

- The XLE/XLT utilizes a clip installation method to ensure a robust and watertight seal to the enclosure. Please follow the steps below for the proper installation and operation of the unit.
- This equipment is suitable for Class I, Division 2, Groups A, B, C and D or non-hazardous locations only.
- Digital outputs shall be supplied from the same source as the operator control station.
- Jumpers on connector JP1 shall not be removed or replaced while the circuit is live unless the area is known to be free of ignitable concentrations of flammable gases or vapors.
- **WARNING-** The USB ports are for operational maintenance only. Do not leave permanently connected unless area is known to be non-hazardous.

Battery Maintenance

The XLE/XLT uses a replaceable non-rechargeable 3V Lithium coin cell battery (CR2450) to run the Real-Time Clock and to keep the retained register values. This battery is designed to maintain the clock and memory for 7 to 10 years. Please reference MAN0878 providing instructions on how to replace the battery.

SAFETY & MAINTENANCE

Warnings

1. To avoid the risk of electric shock or burns, always connect the safety (or earth) ground before making any other connections.
2. To reduce the risk of fire, electrical shock, or physical injury, it is strongly recommended to fuse the voltage measurement inputs. Be sure to locate fuses as close to the source as possible.
3. Replace fuse with the same type and rating to provide protection against risk of fire and shock hazards.
4. In the event of repeated failure, do NOT replace the fuse again as repeated failure indicates a defective condition that will NOT clear by replacing the fuse.
5. Only qualified electrical personnel familiar with the construction and operation of this equipment and the hazards involved should install, adjust, operate, or service this equipment.
6. Read and understand this manual and other applicable manuals in their entirety before proceeding. Failure to observe this precaution could result in severe bodily injury or loss of life.
7. **WARNING** - Battery may explode if mistreated. Do not recharge, disassemble, or dispose of in fire.
8. **WARNING - EXPLOSION HAZARD** - Batteries must only be changed in an area known to be non-hazardous.
9. **WARNING** - Do not disconnect while circuit is live unless are is know to be non-hazardous.

FCC Compliance

This device complies with Part 15 of the FCC Rules. Operation is subject to the following

two conditions:

1. This device may not cause harmful interference.
2. This device must accept any interference received, including interference that may cause undesired operation.

Technical Support

North America

1 (317) 916-4274

(877) 665-5666

www.hornerautomation.com

techsppt@heapg.com

Europe

+353 (21) 4321-266

www.hornerautomation.eu

technical.support@horner-apg.com

Precautions

All applicable codes and standards need to be followed in the installation of this product. Adhere to the following safety precautions whenever any type of connection is made to the module:

1. Connect the safety (earth) ground on the power connector first before making any
2. other connections.
3. When connecting to the electric circuits or pulse-initiating equipment, open their
4. related breakers.
5. Do NOT make connection to live power lines.
6. Make connections to the module first; then connect to the circuit to be monitored.
7. Route power wires in a safe manner in accordance with good practice and local codes.
8. Wear proper personal protective equipment including safety glasses and insulated gloves when making connections to power circuits.
9. Ensure hands, shoes, and floor are dry before making any connection to a power line.
10. Make sure the unit is turned OFF before making connection to terminals.
11. Make sure all circuits are de-energized before making connections.
12. Before each use, inspect all cables for breaks or cracks in the insulation. Replace
13. immediately if defective.
14. Use copper conductors in Field Wiring only, 60/75°C.
15. Use caution when connecting controllers to PCs via serial or USB. PCs, especially laptops, may use "floating power supplies" that are ungrounded. This could cause a damaging voltage potential between the laptop and controller. Ensure the controller and laptop are grounded for maximum protection. Consider using a USB isolator due to voltage potential differences as a preventative measure.