

# EXLW Datasheet - Model 5

12 DC In, 12 DC Out, 2 - 14/16-bit, Analog In (mA/V/Tc/mV/RTD), 2 - 12-bit Analog Out

MAN1261-22-EN\_EXLW\_Mod5



## Part Numbers

Global Part Number	HE-EXLWE5
European Part Number	HEXT381C115

## User Manual and Add-Ons

Find the documents via the [Documentation Search](#).

Part #	Description
MAN1256	EXLW & XLW Prime User Manual
MAN1142	Rechargeable Battery Manual
HE-BAT019	Rechargeable 3.6V Lithium Battery
HE-XCK	Programming Cables
HE-XDAC	2 channel Analog Output I/O option kit, selectable 0-10V, +/-10V, 4-20mA.
HE-XDAC107	4 channel Analog Output I/O option kit, selectable 0-10V, +/-10V, 4-20mA.
HE-XKIT	Blank I/O Board
HE200MJ2TRM	Adapter, RJ45 (8P8C) male to 8-position terminal strip.
HE-FBD001	Ferrite core for filtering out electrical noise.

## Battery Maintenance

The EXLW has an advanced battery system that uses a rechargeable lithium battery. The battery powers the real time clock when power is removed, and it is needed for register data retention. Manual **MAN1256** via the [Documentation Search](#) for more details on battery replacement.

## Table of Contents

User Manual and Add-Ons .....	1
Battery Maintenance .....	1
<b>TECHNICAL SPECIFICATIONS .....</b>	<b>2</b>
General Specifications .....	2
Control and Logic .....	2
User Interface .....	2
Connectivity .....	2
<b>CONTROLLER OVERVIEW .....</b>	<b>3</b>
Overview of OCS .....	3
Power Wiring .....	3
<b>MODEL 5 SPECIFICATIONS .....</b>	<b>4</b>
Digital DC Input .....	4
Digital DC Outputs .....	4
Analog Inputs, High Resolution .....	5
Analog Outputs .....	5
<b>WIRING: INPUTS AND OUTPUTS .....</b>	<b>6</b>
Analog Inputs Information .....	6
Digital Inputs .....	6
Jumper Settings for Model 5 .....	6
Back Panel Torque Ratings .....	6
J1 Wiring - Digital Inputs .....	7
J2 Wiring - Digital Outputs .....	7
J3 Wiring - TC & RTD .....	7
Built-In I/O .....	8
Analog Input Tranzorb Failure .....	8
<b>COMMUNICATIONS .....</b>	<b>9</b>
Serial Communication .....	9
MJ1/2 Serial Ports .....	9
MJ3 Serial Port .....	9
Ethernet .....	9
Dip Switches .....	9
CAN Communications .....	9
<b>DIMENSIONS &amp; INSTALLATION .....</b>	<b>10</b>
Dimensions & Panel Cutout .....	10
Installation Information .....	10
Installation Procedure .....	10
<b>SAFETY &amp; MAINTENANCE .....</b>	<b>11</b>
Warnings .....	11
FCC Compliance .....	11
Technical Support .....	11
Precautions .....	11

## TECHNICAL SPECIFICATIONS

### General Specifications

Required Power (Steady State)	420mA @ 12VDC 230mA @ 24VDC
Required Power (Inrush)	25A for < 1ms @ 24VDC, DC switched
Primary Power Range	10 - 30VDC
Max. Current	1100mA, Class 2
Relative Humidity	5 to 95% non-condensing
Typical Power Backlight 100%	6.816W @ 24VDC
Power Backlight 50%	6.169W @ 24VDC
Power Backlight OFF	5.472W @ 24VDC
Clock Accuracy	+ / - 20 ppm maximum at 25°C (+/- 1 min/month)
Real Time Clock	Battery Backed, Rechargeable Lithium
Operating Air Temp	-10°C to +60°C
Storage Temp	-20°C to +60°C
Weight	1.59 lbs (721.2g)
Altitude	Up to 2000m
Rated Pollution Degree	Evaluated for Pollution Degree 2 Rating
Certifications (UL/CE)	<a href="#">North America</a> or <a href="#">Europe</a>
Enclosure Type	1, 3R, 4, 4X, 12, 12K & 13

### Control and Logic

Control Lang. Support	Register-Based Advanced Ladder Logic; Variable-Based Advanced Ladder IEC 61131-3 Languages
Logic Program Size	2MB, maximum
Scan Rate	.04ms/kB
Digital Inputs	2048
Digital Outputs	2048
Analog Inputs	512
Analog Outputs	512
Gen. Purpose Registers	50,000 (words) Retentive 16,384 (bits) Retentive 16,384 (bits) Non-retentive

### User Interface

Display Type	7" VGA Color
Resolution	800 x 480
Color	16-bit (65,536)
Screen Brightness	420 nits
Screen Memory	17MB
User-Program. Screens	1023 max pages; 1023 objects per page
Backlight	LED - 50,000 hour life

### Connectivity

Serial Ports	1 RS-232 & 1 RS-485 on first Modular Jack (MJ1/2); 1 RS-232 or 1 RS-485 on second Modular Jack
USB mini-B	USB 2.0 (480MHz) Programming & Data Access
USB A (500mA max)	USB 2.0 (480MHz) for USB flash drives (2TB)
CAN Port Isolated 1kV	Remote I/O, Peer-to-peer Comms, Cscape
CAN Protocols	CsCAN, CANopen, DeviceNet, J1939
Ethernet	10/100 Mb (Auto-MDX)
Ethernet Protocols	TCP/IP, Modbus TCP, FTP, SMTP, EGD, ICMP, ASCII
Remote I/O	SmartRail, SmartStix, SmartBlock, SmartMod
Removable Memory	microSD, SDHC, SDXC IN FAT32 format, support for 32GB max. Application Updates, Datalogging

## CONTROLLER OVERVIEW

### Overview of OCS



1. Touchscreen
2. USB 2.0 "A": Flash Drive
3. LAN Port
4. PWR: 10-30VDC In
5. CAN Port
6. MJ3: RS-232/485
7. Dip Switches
8. MJ1/MJ2: RJ45 Serial Port
9. microSD: Data Storage
10. USB mini "B": Programming

**NOTE:** Use caution when connecting controllers to PCs via serial or USB. PCs, especially laptops may use "floating power supplies" that are ungrounded. This could cause a damaging voltage potential between the laptop and controller. Ensure the controller and laptop are grounded for maximum protection. Consider using a USB isolator due to voltage potential differences as a preventative measure.

### Power Wiring

**NOTE:** The Primary Power Range is 10VDC to 30VDC.

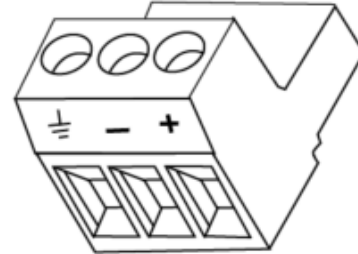

Primary Power Port Pins		
PIN	Signal	Description
1	Ground	Frame Ground
2	DC-	Input Power Supply Ground
3	DC+	Input Power Supply Voltage

### DC Input / Frame

- Solid/Stranded Wire: 12-24 awg (2.5-0.2mm)
- Strip length: 0.28" (7mm)
- Torque, Terminal Hold-Down Screws: 4.5 – 7 in-lbs (0.50 – 0.78 N-m)
- DC- is internally connected to I/O V-, but is isolated from CAN V-. A Class 2 power supply must be used.

### Power Up

1. **OPTION:** Attach ferrite core with a minimum of two turns of the DC+ and DC- signals from the DC supply that is powering the controllers.



2. Connect to earth ground.
3. Apply recommended power.

## MODEL 5 SPECIFICATIONS

### Digital DC Input

Inputs per Module	12 Including 4 Configurable HSC Inputs	
Commons per Module	1	
Input Voltage Range	12VDC / 24VDC	
Absolute Max. Voltage	30VDC Max.	
Input Impedance	10kΩ	
Input Current	Positive Logic	Negative Logic
Upper Threshold	0.8mA	-1.6mA
Lower Threshold	0.3mA	-2.1mA
Max. Upper Threshold	8VDC	
Min. Lower Threshold	3VDC	
OFF to ON Response	1ms	
ON to OFF Response	1ms	
High Speed Counter Max Freq*	1MHz	

### Digital DC Outputs

Outputs per Module	16 Including 2 Configurable PWM Outputs
Commons per Module	1
Output Type	Sourcing / 10kΩ Pull-Down
Output Frequency	500kHz
Absolute Max. Voltage	28VDC Max.
Output Protection	Short Circuit
Max. Output Current / Point	0.5A
Max. Total Current	4A Continuous
Max. Output Supply Voltage	30VDC
Min. Output Supply Voltage	10VDC
Max. Voltage Drop at Rated Current	0.25VDC
Max. Inrush Current	650mA per Channel
Min. Load	None
OFF to ON Response	1ms
ON to OFF Response	1ms
Output Characteristics	Current Sourcing (Pos. Logic)
PWM Out	≈ 5kHz
Rise Time	50 - 115μs
Fall Time	8-20μs

## Analog Inputs, High Resolution

Number of Channels	2
Input Ranges (Selectable)	0-10VDC; 0-20mA; 4-20mA; 100mV PT100 (-200 to 850 °C); J, K, N, T, E, R, S, B Thermocouples
Safe Input Voltage Range	10VDC: -0.5V to +15V; 20mA: -0.5V to +6V RTD / T/C: +/- 24VDC
Nominal Resolution	10V, 20mA, 100mV: 14 Bits; RTD, Thermocouple: 16 Bits
Input Impedance (Clamped @ -0.5VDC to 12VDC)	<b>Current Mode:</b> 100Ω , 35mA Max. Continuous <b>Voltage Mode:</b> 500k, 25mA Max. Continuous
%AI Full Scale	<b>10V, 20mA, 100mV:</b> 32,000 counts full scale <b>RTD / TC:</b> 20 Counts / °C
Max. Over-Current	35mA
Open Thermocouple Detec Current	50nA
<b>Thermocouple:</b> B / R / S E T J K / N	<b>Temperature Range:</b> 32°F to 2,912°F (0°C to 1,600°C) -328°F to 1,652°F (-200°C to 900°C) -400°F to 752°F (-240°C to 400°C) -346°F to 1,382°F (-210°C to 750°C) -400°F to 2,498°F (-240°C to 1,370°C)
Thermocouple Common Mode Range	+/- 10V
Converter Type	Delta Sigma
Max. Error at 25°C (*excluding zero)	*4-20mA +/- 0.10% of full scale *0-20mA +/- 0.10% of full scale *0-10VDC +/- 0.10% of full scale RTD (PT100) +/- 1.0 C° of full scale 0-100mV +/- 0.05% of full scale
Max. Thermocouple Error (After Warm up of 1 Hour)	+/-0.2% (+/-0.3% below -100°C) of full scale
Conversion Speed, Both Channels Converted	<b>10V, 20mA, 100mV:</b> 30 Times/Second <b>RTD Thermocouple:</b> 7.5 Times/Second
Conversion Time per Channel	<b>10V, 20mA, 100mV:</b> 16.7 ms; <b>RTD, Thermocouple:</b> 66.7 ms
RTD Excitation Current	250μA
Conversion Speed	Once per ladder scan

## Analog Outputs

Number of Channels	2
Output Ranges	0-10VDC , 0-20mA
Nominal Resolution	12 Bits
Update Rate	Once per PLC scan
Max. Error at 25°C (Excluding Zero)	20mA 0.1% of full scale; 0 - 10V 0.1% of full scale
Minimum 10V Load	1kΩ
Minimum Resistance Load	500Ω
Analog Outputs; Output Point required	2
Add'l Error for Temp. Other Than 25°C	20mA..... 0.000143%/ °C; 0 - 10V.... 0.000151%/ °C

# WIRING: INPUTS AND OUTPUTS

## Analog Inputs Information

Raw input values for channels 1-4 are found in the registers as Integer-type data with a range from 0 – 32000. Analog inputs may be filtered digitally with the Filter Constant found in the Cscape Hardware Configuration for Analog Inputs. Valid filter values are 0-7 and act according to the following chart:

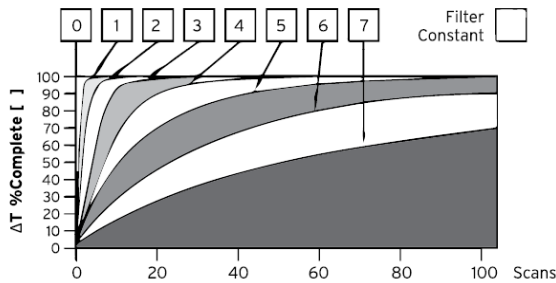

Data Values	
INPUT MODE:	DATA FORMAT, 12-bit INT:
0-20mA, 4-20mA	0-32000
0-10V	0-32000
T/C & RTD	Temperature in °C to 1 decimal place (xxx.y) NOTE: The value in the %AI is an integer. The value should be divided by 20 to get temperature in °C.

## Digital Inputs

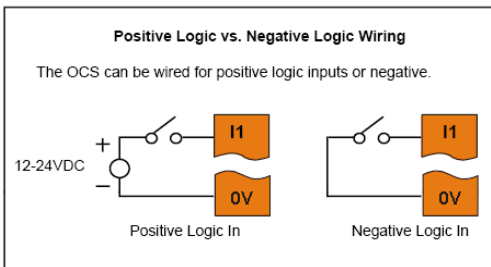

Digital inputs may be wired in either a Positive Logic or Negative Logic fashion as shown. The setting in the Cscape Hardware Configuration for the Digital Inputs must match the wiring used in order for the correct input states to be registered. When used as a normal input and not for high speed functions, the state of the input is reflected in registers %I1 – %I12. Digital inputs may alternately be specified for use with High Speed Counter functions, also found in the Hardware Configuration for Digital Inputs.

## Jumper Settings for Model 5

Location of I/O jumpers (JP1 - JP4) and wiring connectors (J1 -J3) with back cover removed:

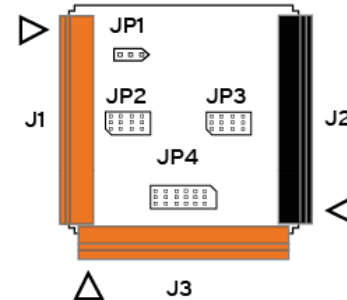

### JP1 - Digital DC Inputs



### JP2 & JP3 - Analog Input Settings

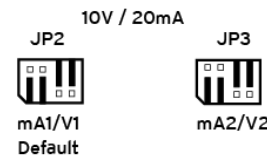
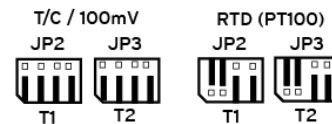

### JP4 - Analog Output Setting

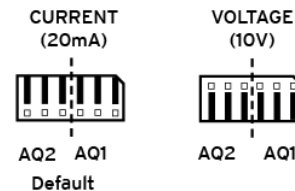

## Back Panel Torque Ratings

- XLE/XLT:** 3.0 - 4.0 in-lbs (0.34 - 0.45 N-m)
- XL4/XL4 Prime:** 3.0 - 4.0 in-lbs (0.34 - 0.45 N-m).
- EXL6/XL6 Prime:** 3.0 - 4.0 in-lbs (0.34 - 0.45 N-m)
- EXLW/ XLW Prime:** 3.0 - 3.5 in-lbs (0.34 - 0.40 N-m)
- XL7/XL7 Prime:** 3.0 - 3.5 in-lbs (0.34 - 0.40 N-m)
- EXL10/XL10 Prime:** 3.0 - 3.5 in-lbs (0.34 - 0.40 N-m)

## J1 Wiring - Digital Inputs

### Positive Logic

J1 (Orange) Name	
I1 (%I1)	Digital In 1
I2 (%I2)	Digital In 2
I3 (%I3)	Digital In 3
I4 (%I4)	Digital In 4
I5 (%I5)	Digital In 5
I6 (%I6)	Digital In 6
I7 (%I7)	Digital In 7
I8 (%I8)	Digital In 8
H1 (%I9)	HSC1 / Dig. In 9
H2 (%I10)	HSC2 / Dig. In 10
H3 (%I11)	HSC3 / Dig. In 11
H4 (%I12)	HSC4 / Dig. In 12
NC	No Connect
NC	No Connect
OV	Common

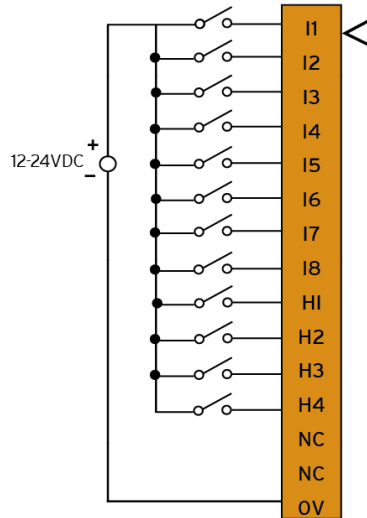

## J3 Wiring - TC & RTD

J3 (Orange) Name	
T1+ (%A1)	TC (1+) or RTD (1+) or 100mV (1+)
T1- (%A1)	TC (1-) or RTD (1-) or 100mV (1-)
T2+ (%A2)	TC (2+) or RTD (2+) or 100mV (2+)
T2- (%A2)	TC (2-) or RTD (2-) or 100mV (2-)
AQ1 (%AQ10)	10 V or 20mA OUT (1)
AQ2 (%AQ10)	10 V or 20mA OUT (2)
OV	Common
MA1 (%A1)	0-20mA IN (1)
V1 (%A1)	0-10V IN (1)
OV	Common
MA2 (%A2)	0-20mA IN (2)
V2 (%A2)	0-10V IN (2)
OV	Common

## J2 Wiring - Digital Outputs

### Positive Logic

J2 (Black) Name	
OV	Common
V+	V+
NC	No Connect
Q12 (%Q12)	Digital Out 12
Q11 (%Q11)	Digital Out 11
Q10 (%Q10)	Digital Out 10
Q9 (%Q9)	Digital Out 9
Q8 (%Q8)	Digital Out 8
Q7 (%Q7)	Digital Out 7
Q6 (%Q6)	Digital Out 6
Q5 (%Q5)	Digital Out 5
Q4 (%Q4)	Digital Out 4
Q3 (%Q3)	Digital Out 3
Q2 (%Q2)	Dig. Out 2 / PWM 2
Q1 (%Q1)	Dig. Out 1 / PWM 1

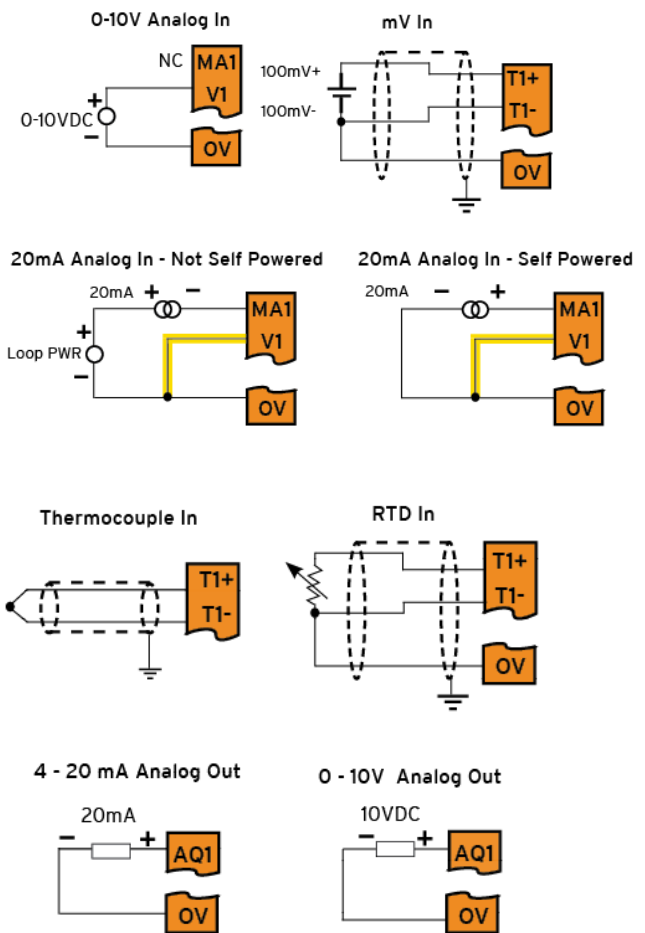
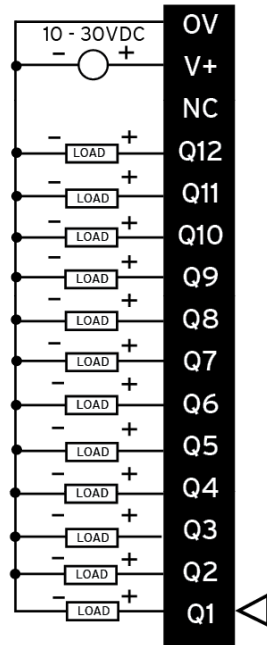

## Wiring Details

**Solid/Stranded Wire:** 12-24 awg (2.5-0.2mm<sup>2</sup>).

**Strip Length:** 0.28" (7mm).

**Torque, Terminal Hold-Down Screws:** 4.5 – 7 in-lbs (0.50 – 0.78 N-m).

## Built-In I/O

The I/O is mapped into OCS Register space, in three separate areas: Digital/Analog I/O, High-Speed Counter I/O, and High-speed Output I/O. Digital/Analog I/O location is fixed starting at 1, but the high-speed counter and high-speed output references may be mapped to any open register location .

Digital and Analog I/O Function Registers	
Digital Inputs	%I1-12
Reserved	%I13-31
ESCP Alarm	%I32
Digital Outputs	%Q1-12
Reserved	%Q13-24
Analog Inputs	%AI1-2
Reserved	%AI3-12
Analog Outputs	%AQ9-10
Reserved	%AQ1-8

## Analog Input Tranzorb Failure

A common cause of Analog Input Tranzorb Failure on Analog Inputs Model 2, 3, 4 & 5: If a 4- 20mA circuit is initially wired with loop power, but without a load, the analog input could see 24VDC. This is higher than the rating of the tranzorb. This can be solved by NOT connecting loop power prior to load connection, or by installing a low-cost PTC in series between the load and analog input.

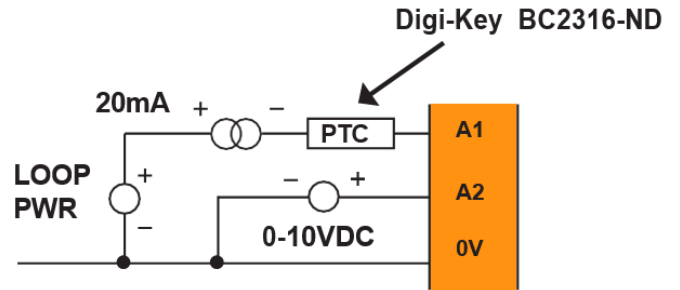



# COMMUNICATIONS

## Serial Communication

### MJ1/2 Serial Ports

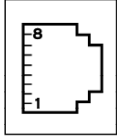

MJ1/2 Independent Serial Ports

**MJ1:** RS-232 w/Full Handshaking

**MJ2:** RS-485 Half-Duplex

		MJ1 PINS		MJ2 PINS	
PIN	SIGNAL	DIRECTION	SIGNAL	DIRECTION	
8	TXD	OUT	--	--	
7	RXD	IN	--	--	
6	0V	GROUND	0V	GROUND	
5	+5V @ 60mA	OUT	+5V @ 60mA	OUT	
4	RTS	OUT	--	--	
3	CTS	IN	--	--	
2	--	--	RX- / TX-	IN / OUT	
1	--	--	RX+ / TX+	IN / OUT	

### MJ3 Serial Port

2 Multiplexed Serial Ports on One Modular Jack (8 posn)

		MJ3 PINS	
PIN	SIGNAL	DIRECTION	
8	TXD RS232	OUT	
7	RXD RS232	IN	
6	0V	GROUND	
5	+5V @ 60mA	OUT	
4	TX- RS485	OUT	
3	TX+ RS485	OUT	
2	RX- RS485	IN	
1	RX+ RS485-	IN	

**NOTE:** Attach optional [ferrite core](#) with a minimum of two turns of serial cable.

## Ethernet

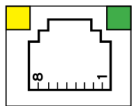

**Green LED indicates link** - when illuminated, data communication is available.

**Yellow LED indicates activity** - when flashing, data is in transmission.

## Dip Switches

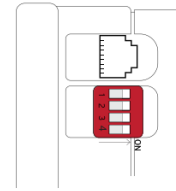

DIP Switches			
PIN	NAME	FUNCTION	DEFAULT
1	MJ3 RS-485 Termination	ON = Terminated	OFF
2	MJ3 Duplex	ON = Half	OFF
3		OFF = Full	OFF
4	MJ2 RS485 Termination	ON = Terminated	OFF

The DIP switches are used to provide a built-in termination to both the MJ1, MJ2 & MJ3 ports if needed. The termination for these ports should only be used if this device is located at either end of the multidrop/ daisy-chained RS-485 network.

## CAN Communications

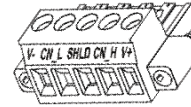

CAN Pin Assignments		
PIN	SIGNAL	DESCRIPTION
1	V-	CAN Ground – Black
2	CN_L	CAN Data Low – Blue
3	SHLD	Shield Ground – None
4	CN_H	CAN Data High – White
5	V+ (NC)	No Connect – Red

- **Solid/Stranded Wire:** 12-24 awg (2.5-0.2mm).
- **Strip Length:** 0.28" (7mm).
- Locking spring-clamp, two-terminators per conductor.
- **Torque, Terminal Hold-Down Screws:** 4.5 – 7 in-lbs (0.50 – 0.78 N-m).
- V+ pin is not internally connected, the SHLD pin is connected to Earth ground via a 1MΩ resistor and 10 nF capacitor.

## DIMENSIONS & INSTALLATION

### Dimensions & Panel Cutout

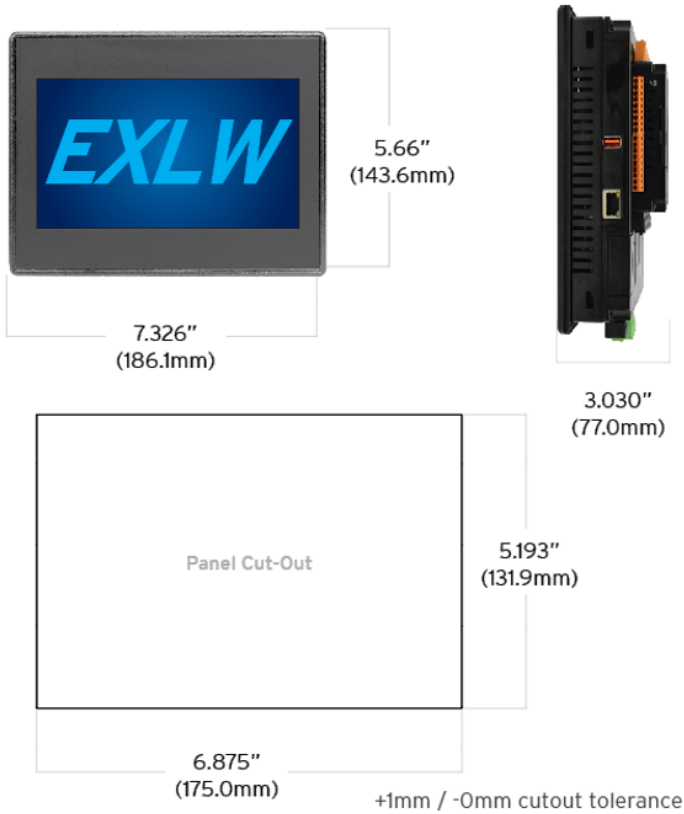

### Installation Procedure

1. Carefully locate an appropriate place to mount the EXLW. Be sure to leave enough room at the top of the unit for insertion and removal of the microSD™ card.
2. Carefully cut the host panel per the diagram, creating a 131.9mm x 175.0mm, with a +1mm/-0mm panel cutout tolerance, opening into which the EXLW may be installed. If the opening is too large, water may leak into the enclosure, potentially damaging the unit. If the opening is too small, the OCS may not fit through the hole without damage.
3. Remove any burrs and or sharp edges and ensure the panel is not warped in the cutting process.
4. Remove all Removable Terminals from the EXLW. Insert the EXLW through the panel cutout (from the front). The gasket must be between the host panel and the EXLW.
5. Install and tighten the four mounting clips (provided in the box) until the gasket forms a tight seal. **NOTE:** Max torque is 0.8 to 1.13Nm, or 7 to 10 in-lbs.
6. Reinstall the EXLW I/O Removable Terminal Blocks. Connect communications cables to the serial port, USB ports, Ethernet port, and CAN port as required.

### Installation Information

- The EXLW utilizes a clip installation method to ensure a robust and watertight seal to the enclosure. Please follow the steps below for the proper installation and operation of the unit.
- This equipment is suitable for Class I, Division 2, Groups A, B, C and D or non-hazardous locations only.
- Digital outputs shall be supplied from the same source as the operator control station.
- Jumpers on connector JP1 shall not be removed or replaced while the circuit is live unless the area is known to be free of ignitable concentrations of flammable gases or vapors.
- **WARNING-** The USB ports are for operational maintenance only. Do not leave permanently connected unless area is known to be non-hazardous.

## SAFETY & MAINTENANCE

### Warnings

1. To avoid the risk of electric shock or burns, always connect the safety (or earth) ground before making any other connections.
2. To reduce the risk of fire, electrical shock, or physical injury, it is strongly recommended to fuse the voltage measurement inputs. Be sure to locate fuses as close to the source as possible.
3. Replace fuse with the same type and rating to provide protection against risk of fire and shock hazards.
4. In the event of repeated failure, do NOT replace the fuse again as repeated failure indicates a defective condition that will NOT clear by replacing the fuse.
5. Only qualified electrical personnel familiar with the construction and operation of this equipment and the hazards involved should install, adjust, operate, or service this equipment.
6. Read and understand this manual and other applicable manuals in their entirety before proceeding. Failure to observe this precaution could result in severe bodily injury or loss of life.
7. **WARNING** - Battery may explode if mistreated. Do not recharge, disassemble, or dispose of in fire.
8. **WARNING - EXPLOSION HAZARD** - Batteries must only be changed in an area known to be non-hazardous.
9. **WARNING** - Do not disconnect while circuit is live unless are is know to be non-hazardous.

### FCC Compliance

This device complies with Part 15 of the FCC Rules. Operation is subject to the following two conditions:

1. This device may not cause harmful interference.
2. This device must accept any interference received, including interference that may cause undesired operation.

### Technical Support

#### North America

1 (317) 916-4274

(877) 665-5666

[www.hornerautomation.com](http://www.hornerautomation.com)

[techspt@heapg.com](mailto:techspt@heapg.com)

#### Europe

+353 (21) 4321-266

[www.hornerautomation.eu](http://www.hornerautomation.eu)

[technical.support@horner-apg.com](mailto:technical.support@horner-apg.com)

### Precautions

All applicable codes and standards need to be followed in the installation of this product. Adhere to the following safety precautions whenever any type of connection is made to the module:

1. Connect the safety (earth) ground on the power connector first before making any
2. other connections.
3. When connecting to the electric circuits or pulse-initiating equipment, open their
4. related breakers.
5. Do NOT make connection to live power lines.
6. Make connections to the module first; then connect to the circuit to be monitored.
7. Route power wires in a safe manner in accordance with good practice and local codes.
8. Wear proper personal protective equipment including safety glasses and insulated gloves when making connections to power circuits.
9. Ensure hands, shoes, and floor are dry before making any connection to a power line.
10. Make sure the unit is turned OFF before making connection to terminals.
11. Make sure all circuits are de-energized before making connections.
12. Before each use, inspect all cables for breaks or cracks in the insulation. Replace
13. immediately if defective.
14. Use copper conductors in Field Wiring only, 60/75°C.
15. Use caution when connecting controllers to PCs via serial or USB. PCs, especially laptops, may use "floating power supplies" that are ungrounded. This could cause a damaging voltage potential between the laptop and controller. Ensure the controller and laptop are grounded for maximum protection. Consider using a USB isolator due to voltage potential differences as a preventative measure.