



XL6/XL6M/XL6e OCS Models

HE-XL102 / HE-XL1M2 / HEXT350C112 / HEXT280C112

HE-XL1E2 / HEXT351C112

12 Digital DC Inputs
4 Analog Inputs (Medium Resolution)
6 Digital Relay Outputs

1 Specifications

General Specifications	
Required Power (Steady State)	500 mA @ 24 VDC
Required Power (Inrush)	30 A for 1 ms @ 24 VDC – DC Switched 2.5 A for 4 ms @ 24 VDC - AC Switched
Primary Power Range	10 – 30 VDC
Relative Humidity	5 to 95% Non-condensing
Clock Accuracy	+/- 35 ppm maximum at 25° C (+/- 1.53 Minutes per Month)
Operating Temperature	-10°C to +60°C
Terminal Type	Screw Type, 5 mm Removable
Weight	26.5 oz. (.751 kg)
CE	USA: http://www.heapg.com/Pages/TechSupport/ProductCert.html
UL	Europe: http://www.horner-apg.com/en/support/certification.aspx
Display Type	5.7" QVGA TFT
Display Size	5.7"
Display Screen Dimension	320 x 240
Display Memory	2.75 MB
Display Life	Minimum 40000 hours (50% brightness, 25 deg C)
User Keys	5 user-defined Function keys and a System Key
Screens supported	1023
Colors	32768/ 16 shade Grey scale (XL6M models only)
Connectivity	
Serial Ports	2 Serial Ports – RS232 & RS485
Ethernet	10/100-Mbps (XL6e models only)
USB	USB Networking Port for communication with PCs, flash device connectivity and programming Port
Removable Media	Removable Media for upto 2 GB of storage for programs, data logging or screen capture
Smartstix	Remote IO modules communicating on CAN

Specifications		
Digital DC Inputs		
Inputs per Module	12 including 4 configurable HSC inputs	
Commons per Module	1	
Input Voltage Range	12 VDC / 24 VDC	
Absolute Max. Voltage	35 VDC Max.	
Input Impedance	10 kΩ	
Input Current	Positive Logic	Negative Logic
Upper Threshold	0.8 mA	-1.6 mA
Lower Threshold	0.3 mA	-2.1 mA
Max Upper Threshold	8 VDC	
Min Lower Threshold	3 VDC	
OFF to ON Response	1 ms	
ON to OFF Response	1 ms	
HSC Max. Switching Rate	10 kHz Totalizer/Pulse, Edges 5 kHz Frequency/Pulse, Width 2.5 kHz Quadrature	
Digital Relay Outputs		
Outputs per Module	6 relay	
Commons per Module	6	
Max. Output Current per Relay	3 A at 250 VAC, resistive	
Max. Total Output Current	5 A continuous	
Max. Output Voltage	275 VAC, 30 VDC	
Max. Switched Power	1250 VA, 150 W	
Contact Isolation to XL6 ground	1000 VAC	
Max. Voltage Drop at Rated Current	0.5 V	
Expected Life (See Derating section for chart.)	No load: 5,000,000 Rated load: 100,000	
Max. Switching Rate	300 CPM at no load 20 CPM at rated load	
Type	Mechanical Contact	
Response Time	One update per ladder scan plus 10 ms	
Analog Inputs, Medium Resolution		
Number of Channels	4	
Input Ranges	0 - 10 VDC 0 - 20 mA 4 - 20 mA	
Safe input voltage range	-0.5 V to +12V	
Input Impedance (Clamped @ -0.5 VDC to 12 VDC)	Current Mode: 100 Ω	Voltage Mode: 500 k Ω
Nominal Resolution	10 Bits	
%AI full scale	32,000 counts	
Max. Over-Current	35 mA	
Conversion Speed	All channels converted once per ladder scan	
Max. Error at 25°C (excluding zero) *can be made tighter (-0.25%) by adjusting the digital filter setting to 3.	4-20 mA 0-20 mA 0-10 VDC	1.00% 1.00% 1.50%*
Additional error for temperatures other than 25°C	TBD	
Filtering	160 Hz hash (noise) filter 1-128 scan digital running average filter	



HE-XL102 / HE-XL1E2 / HE-XL1M2

Note: Highest usable frequency for PWM output is 65 KHz

2 Installation

1. Prior to mounting, observe requirements for the panel layout design and spacing/clearances in the OCS XL6 Series Manual (MAN0883).
2. Cut the host panel.
3. Insert the OCS through the panel cutout (from the front). The gasket material needs to be between the host panel and the OCS.

Caution: Do not force the OCS into the panel cutout. An incorrectly sized panel cutout can damage the touch screen.

4. Install and tighten the mounting clips (provided with the OCS) until the gasket material forms a tight seal.
5. Connect cables as needed such as communications, programming, power and CsCAN cables to the ports using the provided connectors.
6. Begin configuration procedures.

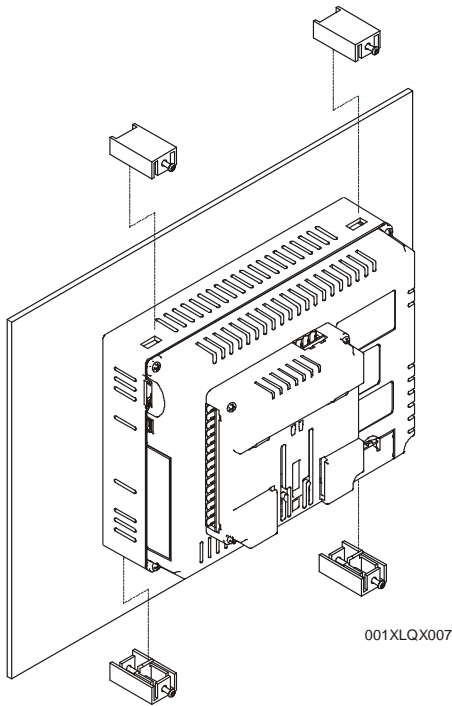

3 Panel Cut-Out and Dimensions

Refer to the XL6 User Manual (MAN0883) for panel box information and a handy checklist of requirements.

Note: The tolerance to meet NEMA standards is $\pm 0.005"$ (0.1 mm).

Note: Max. panel thickness: 5 mm

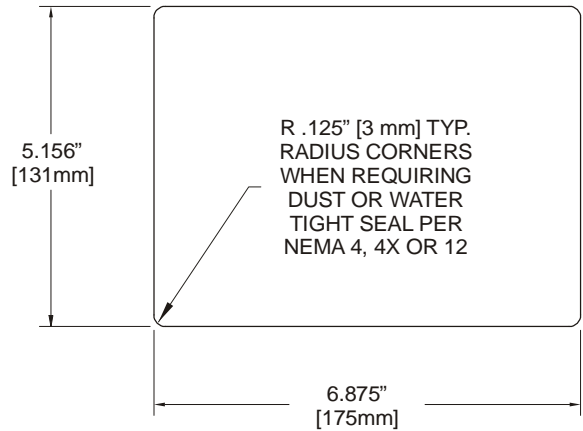
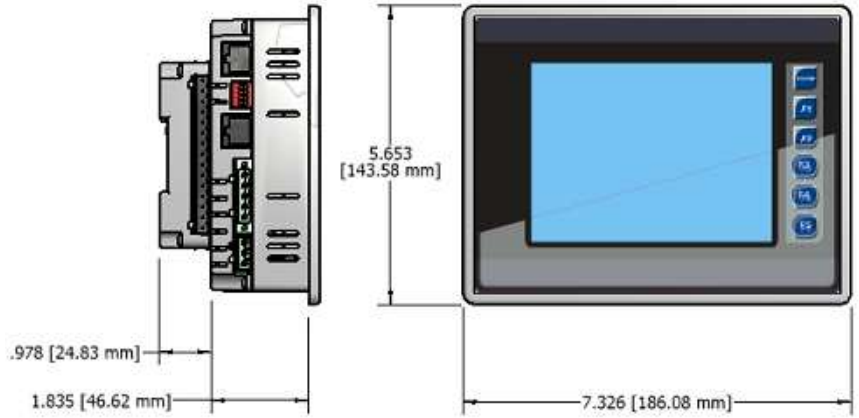

001OCS003-R1

4 Ports and Connectors

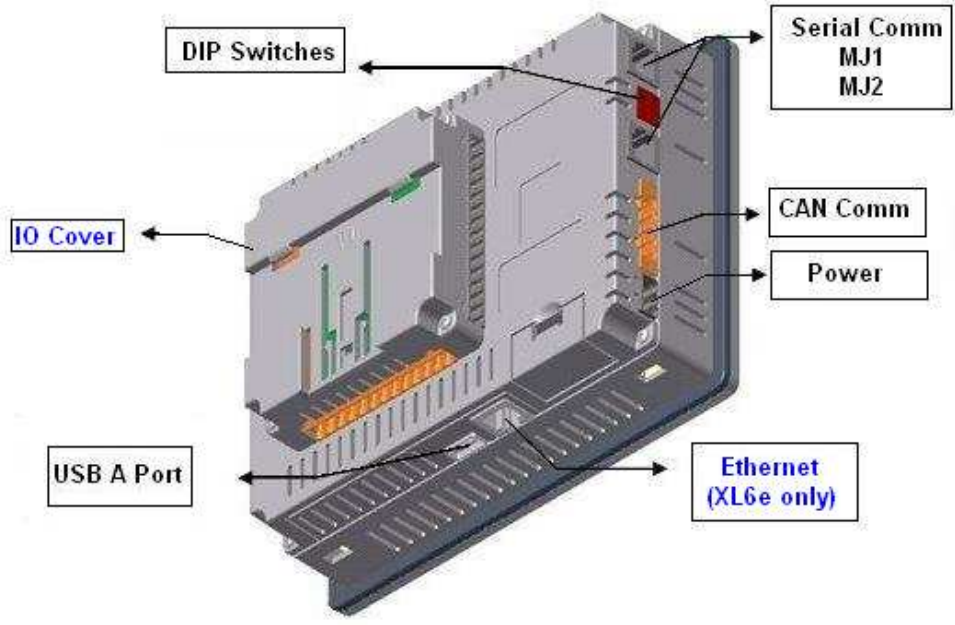
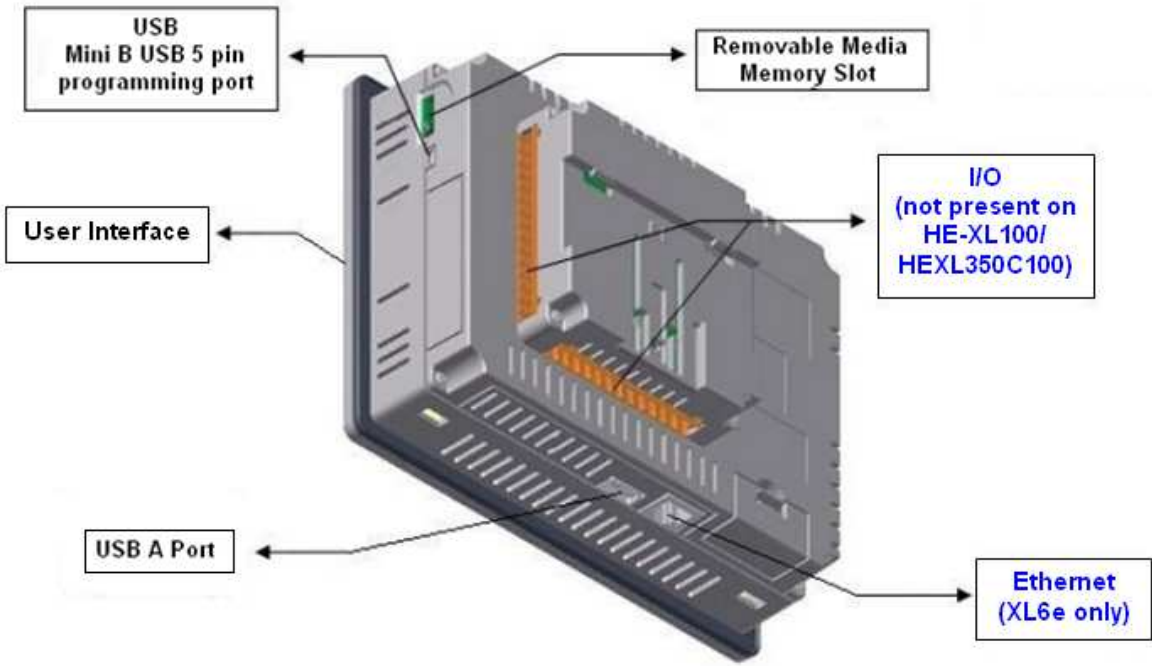

To Remove I/O Cover:
 Unscrew 4 screws located on the cover.
 Remove cover.

CAUTION: Do not over tighten screws when replacing the back cover.

I/O Jumpers:
 I/O Jumpers (JP) are located internally. To access, remove I/O cover of unit.

Wiring Connectors (J1 / J2) and I/O Jumpers (JP1 and JP2) are described in the *Wiring and Jumpers* section of this document.

USBA: For flash drive connectivity

USBB: For network communication and programming of OCS

Removable Memory: Uses **Removable Memory** for data logging, screen captures, program loading and recipes. **Horner Part No.: HE-MC1**

Serial Communications: MJ1/MJ2: (RS-232 / RS-485) Use for Cscape programming and Application-Defined Communications.

Ethernet: Used for Cscape programming and Application-Defined Communications.

4.1 Serial Communications:

MJ1: (RS-232 / RS-485) Use for Cscape programming and Application-Defined Communications.

MJ2: (RS-232 / RS-485) Use for Application-Defined Communications.

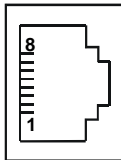

Pin	MJ1 Pins		MJ2 Pins	
	Signal	Direction	Signal	Direction
8	TXD	OUT	TXD	OUT
7	RXD	IN	RXD	IN
6	0 V	Ground	0 V	Ground
5*	+5 60mA	OUT	+5 60mA	OUT
4	RTS	OUT	TX-	OUT
3	CTS	IN	TX+	OUT
2	RX- / TX-	IN / OUT	RX-	IN
1	RX+ / TX+	IN / OUT	RX+	IN

MJ2 Pinouts in Half and Full Duplex Modes

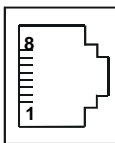

Pin	MJ2 Pins	
	Signal	Direction
8	TXD	OUT
7	RXD	IN
6	0 V	Ground
5*	+5 60mA	OUT
4	TX-	OUT
3	TX+	OUT
2	TX-/RX-	IN/OUT
1	TX+/RX+	IN/OUT

* +5V 60mA Max

MJ2 Half Duplex Mode

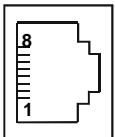

Pin	MJ2 Pins	
	Signal	Direction
8	TXD	OUT
7	RXD	IN
6	0 V	Ground
5*	+5 60mA	OUT
4	TX-	OUT
3	TX+	OUT
2	RX-	IN
1	RX+	IN

* +5V 60mA Max

MJ2 Full Duplex Mode

Functions	Port 1 (MJ1)	Port 2 (MJ2)
RS-232	✓	✓
Hardware Handshaking	✓	X
Programming	✓	X
Ladder function controlled	✓	✓
Serial Downloadable Protocols	✓	✓
RS 485 Full duplex	X	✓
RS485 Half duplex	✓	✓

4.2 External DIP Switch Settings

As seen when looking at the side of the XL6 unit :

The DIP Switches are used for termination of the RS-485 ports. The XL6 is shipped un-terminated.

To terminate, select one of the DIP Switches and configure it based upon the option that is desired.

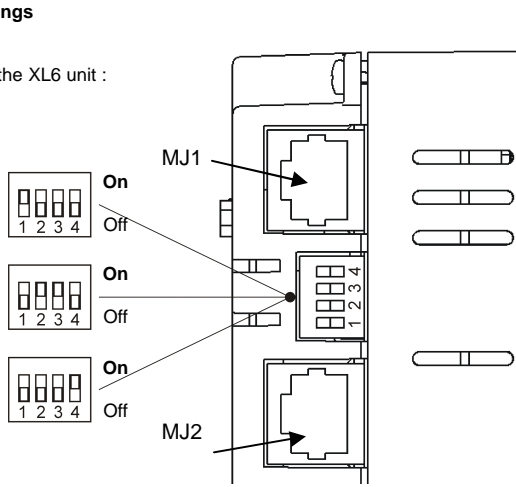

- SW1 - ON enables **MJ2** RS485 port termination (121 Ohms). OFF disables **MJ2** RS485 port termination.
- SW2 & SW3 - ON places **MJ2** RS485 port in half-duplex mode. OFF places **MJ2** RS485 port in full-duplex mode.
- SW4 - ON enables **MJ1** RS485 port termination (121 Ohms). OFF disables **MJ1** RS485 port termination.

4.3 CAN Network Port and Wiring

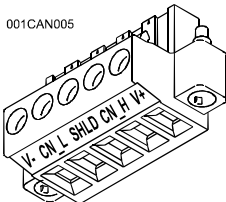

CAN Connector

Use the CAN Connector when using Cscape network.

Torque rating 4.5 – 7 Lb-In (0.50 – 0.78 N-m)

Pin	Signal	Signal Description	Direction
1	V-	CAN Ground	-
2	CN_L	CAN Data Low	In/Out
3	SHLD	Shield Ground	-
4	CN_H	CAN Data High	In/Out
5	NC	No Connect	-

4.4 Ethernet Port

Speeds	10 BaseT Ethernet (10-Mbps) 100 BaseTx Fast Ethernet (100-Mbps)
Modes	Half or Full Duplex
Auto-Negotiation	Both 10/100-Mbps and Half/Full Duplex
Connector Type	Shielded RJ-45
Cable Type (Recommended)	CAT5 (or better) UTP
Port	Auto MDI/MDI-X

4.5 Power Port and Wiring

Power Connector

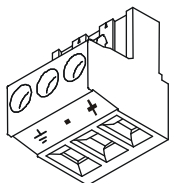

Power Up:

Connect to Earth Ground.
Apply 10 - 30 VDC.
Screen lights up.

Torque rating 4.5 – 7 Lb-In
(0.50 – 0.78 N-m)

Primary Power Port Pins		
Pin	Signal	Description
1	Ground	Frame Ground
2	V-	Input Power Supply Ground
3	V+	Input Power Supply Voltage

5 Wiring and Jumpers

Wire according to the type of inputs / outputs used, and select the appropriate jumper option.

Wiring Specifications

- For I/O wiring (discrete), use the following wire type or equivalent: Belden 9918, 18 AWG (0.8 mm²) or larger.
- For shielded Analog I/O wiring, use the following wire type or equivalent: Belden 8441, 18 AWG (0.8 mm²) or larger.
- For CAN wiring, use the following wire type or equivalent: Belden 3084, 24 AWG (0.2 mm²) or larger.

Use copper conductors in field wiring only, 60/75° C

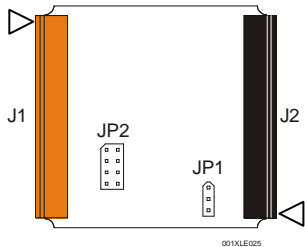
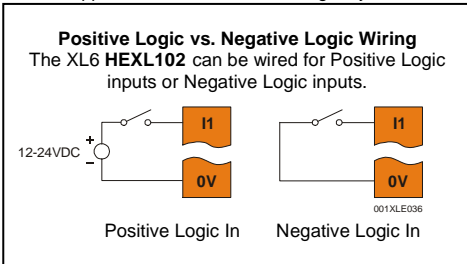

Location of I/O jumpers (JP2 and JP1) and wiring connectors (J1 and J2).

5.1 I/O Jumpers Settings (JP1 - JP2)

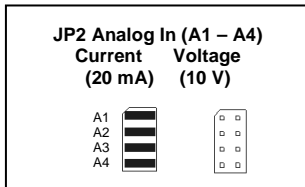
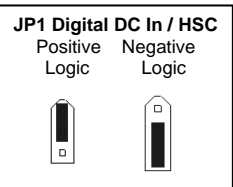

Note:
The Cscape Module Setup configuration must match the selected I/O (JP) jumper settings.

Note:
When using JP2 (A1-A4), each channel can be independently configured.

5.2 Wiring Examples

J1 Orange Terminal Connector

J1 Orange Terminal Connector	Name
I1	IN1
I2	IN2
I3	IN3
I4	IN4
I5	IN5
I6	IN6
I7	IN7
I8	IN8
H1	HSC1 / IN9
0V	Ground
A1	Analog IN1
A2	Analog IN2
A3	Analog IN3
A4	Analog IN4
0V	Ground

J1 Orange Positive Logic In Digital In / Analog In

Note:
Loop Power requirements are determined by the transmitter specification.

J2 Black Terminal Connector

J2 Black Terminal Connector	Name
C6	Relay 6 COM
R6	Relay 6 NO
C5	Relay 5 COM
R5	Relay 5 NO
C4	Relay 4 COM
R4	Relay 4 NO
C3	Relay 3 COM
R3	Relay 3 NO
C2	Relay 2 COM
R2	Relay 2 NO
C1	Relay 1 COM
R1	Relay 1 NO
H4	HSC4 / IN12
H3	HSC3 / IN11
H2	HSC2 / IN10

J2 Black Positive Logic Digital In / Relay Out

6 Filter

Filter Constant sets the level of digital filtering according to the following chart.

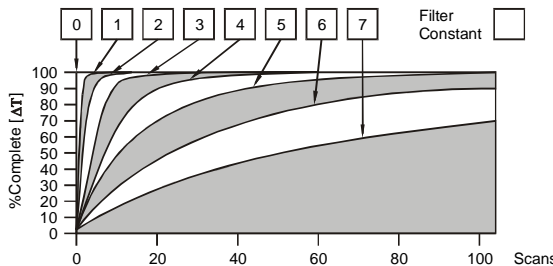

Digital Filtering. The illustration above demonstrates the effect of digital filtering (set with Filter Constant) on module response to a temperature change.

7 Derating

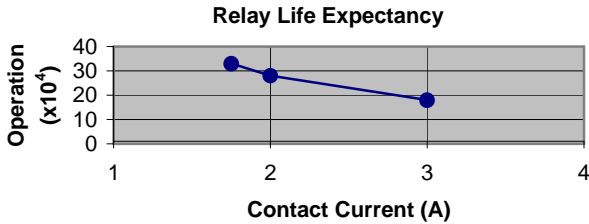

8 I/O Register Map

Registers	Description
%I1 to %I24	Digital Inputs
%I32	Output Fault
%I25 to %I31	Reserved
%Q1 to %Q16	Digital outputs
%Q17	Clear HSC1 accumulator to 0
%Q18	Totalizer: Clear HSC2 Quadrature 1-2: Accumulator 1 Reset to max – 1
%Q19	Clear HSC3 Accumulator to 0
%Q20	Totalizer: Clear HSC4 Quadrature 3-4: Accumulator 3 Reset to max – 1
%Q21 to %Q32	Reserved
%AI1 to %AI4	Analog inputs
%AI5, %AI6	HSC1 Accumulator
%AI7, %AI8	HSC2 Accumulator
%AI9, %AI10	HSC3 Accumulator
%AI11, %AI12	HSC4 Accumulator
%AQ1, %AQ2	PWM1 Duty Cycle
%AQ3, %AQ4	PWM2 Duty Cycle
%AQ5, %AQ6	PWM Prescale
%AQ7, %AQ8	PWM Period
%AQ9 to %AQ14	Analog outputs

Note: Not all XL6 units contain the I/O listed in this table.

10 Technical Support

For assistance and manual updates, contact Technical Support at the following locations:

North America: Tel: 317 916-4274 Fax: 317 639-4279 Web: http://www.heapg.com Email: techspt@heapg.com	Europe: Tel: +353-21-4321266 Fax: +353-21-4321826 Web: http://www.horner-apg.com Email: tech.support@horner-apg.com
--	---

"WARNING: EXPOSURE TO SOME CHEMICALS MAY DEGRADE THE SEALING PROPERTIES OF MATERIALS USED IN THE Tyco relay PCJ

Cover / case & base: Mitsubishi engineering Plastics Corp.
5010GN6-30 or 5010GN6-30 M8 (PBT)
Sealing Material: Kishimoto 4616-50K (1 part epoxy resin)

It is recommended to periodically inspect the relay for any degradation of properties and replace if degradation is found

9 Safety

When found on the product, the following symbols specify:



This equipment is suitable for use in Class I, Division 2, Groups A, B, C and D or Non-hazardous locations only

WARNING – EXPLOSION HAZARD – Do not disconnect equipment unless power has been switched off or the area is known to be non-hazardous.
AVERTISSEMENT - RISQUE D'EXPLOSION - AVANT DE DECONNECTER L'EQUIPMENT, COUPER LE COURANT OU S'ASSURER QUE L'EMPLACEMENT EST DESIGNE NON DANGEREUX.

WARNING: To avoid the risk of electric shock or burns, always connect the safety (or earth) ground before making any other connections.

WARNING: To reduce the risk of fire, electrical shock, or physical injury it is strongly recommended to fuse the voltage measurement inputs. Be sure to locate fuses as close to the source as possible.

WARNING: Replace fuse with the same type and rating to provide protection against risk of fire and shock hazards.

WARNING: In the event of repeated failure, do not replace the fuse again as a repeated failure indicates a defective condition that will not clear by replacing the fuse.

WARNING – EXPLOSION HAZARD – Substitution of components may impair suitability for Class I, Division 2.

AVERTISSEMENT - RISQUE D'EXPLOSION - LA SUBSTITUTION DE COMPOSANTS PEUT RENDRE CE MATERIAL INACCEPTABLE POUR LES EMBLEMENTS DE CLASSE 1, DIVISION 2.

WARNING - The USB parts are for operational maintenance only. Do not leave permanently connected unless area is known to be non-hazardous.

WARNING – EXPLOSION HAZARD - BATTERIES MUST ONLY BE CHANGED IN AN AREA KNOWN TO BE NON-HAZARDOUS

AVERTISSEMENT - RISQUE D'EXPLOSION - AFIN D'EVITER TOUT RISQUE D'EXPLOSION, S'ASSURER QUE L'EMPLACEMENT EST DESIGNE NON DANGEREUX AVANT DE CHANGER LA BATTERIE.

WARNING - Battery May Explode If Mistreated. Do Not Recharge, Disassemble or Dispose Of In Fire.

WARNING: Only qualified electrical personnel familiar with the construction and operation of this equipment and the hazards involved should install, adjust, operate, or service this equipment. Read and understand this manual and other applicable manuals in their entirety before proceeding. Failure to observe this precaution could result in severe bodily injury or loss of life.

This device complies with part 15 of the FCC Rules. Operation is subject to the following two conditions:

1. This device may not cause harmful interference.
2. This device must accept any interference received, including interference that may cause undesired operation.

Radiated Emission Compliance: For compliance requirement, a ferrite (Horner P/N FBD006 supplied with the unit) needs to be placed on the AC/DC line with one loop.

- All applicable codes and standards need to be followed in the installation of this product.
- Adhere to the following safety precautions whenever any type of connection is made to the module:
 - Connect the safety (earth) ground on the power connector first before making any other connections.
 - When connecting to electric circuits or pulse-initiating equipment, open their related breakers.
 - Do not make connections to live power lines.
 - Make connections to the module first; then connect to the circuit to be monitored.
 - Route power wires in a safe manner in accordance with good practice and local codes.
 - Wear proper personal protective equipment including safety glasses and insulated gloves when making connections to power circuits.
 - Ensure hands, shoes, and floors are dry before making any connection to a power line.
 - Make sure the unit is turned OFF before making connection to terminals.
 - Make sure all circuits are de-energized before making connections.
 - Before each use, inspect all cables for breaks or cracks in the insulation. Replace immediately if defective.
- Use Copper Conductors in Field Wiring Only, 60/75° C

No part of this publication may be reproduced without the prior agreement and written permission of Horner APG, Inc. Information in this document is subject to change without notice.