

RCC8842 DATASHEET

**8 Digital Inputs, 8 Digital Outputs
4 Analog Inputs, 2 Analog Outputs**

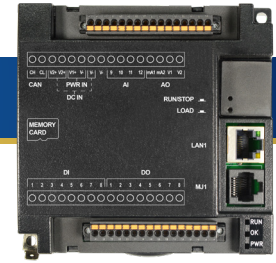

1 TECHNICAL SPECIFICATIONS

1.1 General

Required Pwr. (steady state)	120mA at 24VDC
Required Pwr. (inrush)	25A for 1 ms at 24VDC switched
Primary Pwr. Range	10-32VDC
Real-Time Clock	Yes
Clock Accuracy	+/- 8 seconds/month at 25°C
Relative Humidity	5-95% non-condensing
Operating Temp.	-10°C to +60°C
Storage Temp.	-10°C to +60°C
Battery	Li-Ion Polymer Battery Charging Range 0-50°C
Weight	10 oz / 283.5 g
Mounting	35 mm DIN Rail or Panel Surface
Housing Type	Plastic (UL 50 rated, flame retardant, UV resistant)
Certifications (CE)	USA: https://hornerautomation.com/certifications/ Europe: https://www.horner-automation.eu/support/certifications-2/

1.2 Control & Logic

Control Lang. Support	Advanced Ladder Logic or Full IEC 61131-3 Languages
Logic Size & Scan Rate	2 MB, 0.013 ms/kB
Online Programming Changes	Supported in Advanced Ladder
PID Support	Up to 6
Digital Inputs (%I)	2048
Digital Outputs (%Q)	2048
Analog Inputs (%AI)	512
Analog Outputs (%AQ)	512
Gen. Purpose 16-bit Registers (%R)	4096 Retentive
Gen. Purpose 1-bit Registers (%T)	2048 Non-Retentive
Gen. Purpose 1-bit Registers (%M)	2048 Retentive

1.3 Connectivity

Serial	2 (1xRS232, 1x2-wire RS485)
CAN	1 x 125kbps - 1 Mbps
Ethernet	1 x 10Mbps/100 Mbps
microSD	1 x SD, SDHC, SDXC in FAT32 format
USB	No
Communication Support	WebMI, Web Portal, Email, TCP/IP, Modbus, FTP, Datalogging and more

1.4 Digital DC Inputs

Inputs per Module	8	
Commons per Module	1	
Addressing	%I1 - %I8	
Input Voltage Range	0VDC or 10-30VDC	
Absolute Max. Voltage	35VDC Max.	
Input Impedance	10kΩ	
Input Current	Pos. Logic	Neg. Logic
Min. "On" Current	0.8mA	-1.6mA
Max. "Off" Current	0.3mA	-2.1mA
Min. "On" Input	8VDC	
Max. "Off" Input	3VDC	
OFF to ON Response	100μs min*	
ON to OFF Response	100μs min*	
Galvanic Isolation	None	
Logic Polarity	Pos. or Neg. Based on configuration	
I/O Indication	LED	
High Speed Counter (HSC)	None	
Connector Type	3.5mm Pluggable Cage Clamp	

RCC Series User Manual [MAN1078]

The User Manual includes extensive information on installation, communications, etc.

1.5 Digital DC Outputs

Outputs per Module	8
Commons per Module	1
Addressing	%Q1 - %Q8
Output Type	Sourcing
Absolute Max. Voltage	30VDC Max.
Output Protection	Short Circuit & Overvoltage
Max. Output Current/Point	0.5A
Max. Total Current	2A Total Current
Max. Output Supply	30VDC
Min. Output Supply	10VDC
Max. Voltage Drop at Rated Current	0.25VDC
Min. Load	None
I/O Indication	LED
Galvanic Isolation	None
OFF to ON Response	500ns min*
ON to OFF Response	500ns min*
PWM Out	None
Output Characteristics	Current Sourcing (Pos. Logic)

1.6 Analog Inputs

Number of Channels	4
Input Ranges	0 - 10VDC, 0 - 20mA DC
Addressing	%AI1 - %AI4
%AI Full Scale Value	32,000
Max Input Voltage	-0.5 - 12VDC (+/- 30VDC)
Galvanic Isolation	None
Input Impedance (clamped @ -0.5 to 10.23VDC)	mA: 15Ω +/- 1.5V V: 1.1MΩ
Nominal Resolution	12 bits
Conversion Rate	All channels once per OCS scan
Max Error at 25°C (excludes 0°C)	1.5% of full scale 0-10V - 1.5% of full scale
Filters	160 Hz hash (noise), 1-128 scan digital running average

* all values updated 1x per scan

page 1 of 5

technical specifications continued on next page...

technical specifications continued...

1.7 Analog Outputs

Number of Channels	2
Output Ranges	0 - 10VDC, 0 - 20mA
Addressing	%AQ1 - %AQ2
%AQ Full Scale Value	32,000
Galvanic Isolation	None
Nominal Resolution	12 Bits
Maximum Current Load	500Ω
Conversion Rate	One update/ladder scan
Response Time	One update/ladder scan
Max Error at 25° C (excludes 0° C)	0 - 20mA 0.25% of full scale 0 - 10VDC

2 CONTROLLER OVERVIEW

2.1 - Port Connectors

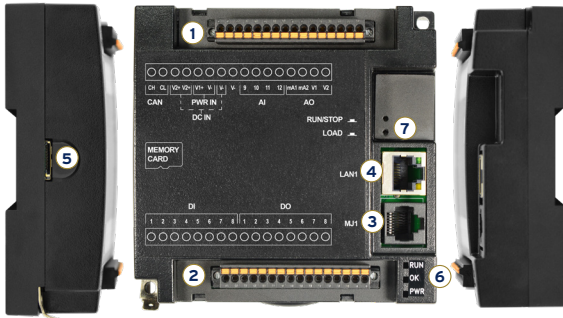

- | | | |
|---------------------------------------|------------------|----------------|
| 1. Power, CAN, & Analog I/O Connector | 3. Serial Port | 6. Status LEDs |
| 2. Digital Connector | 4. Ethernet Port | 7. Buttons |
| | 5. microSD Slot | |

2.2 - Power Wiring

To power up the RCC8842, supply 10-32VDC to the V+ and V- connections on the Power, CAN, and Analog Connector.

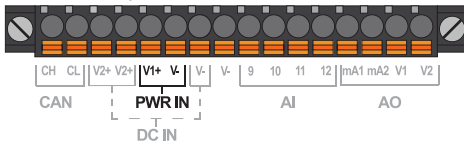

3 WIRING: INPUTS & OUTPUTS

3.1 - Digital Input Wiring

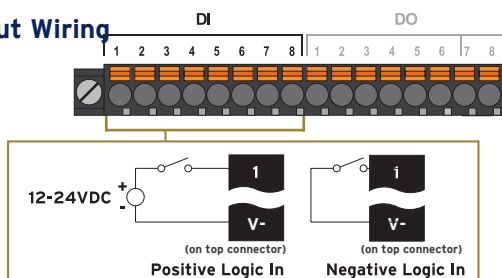

Digital inputs may be wired in either a Positive Logic or Negative Logic fashion as shown. The setting in the Cscape Hardware Configuration for the Digital Inputs must match the wiring used in order for the correct input states to be registered. The state of the inputs are reflected in registers %I1 - %I8. The Common connections are found on the top connector.

wiring: I/O continued...

3.2 - Digital Output Wiring

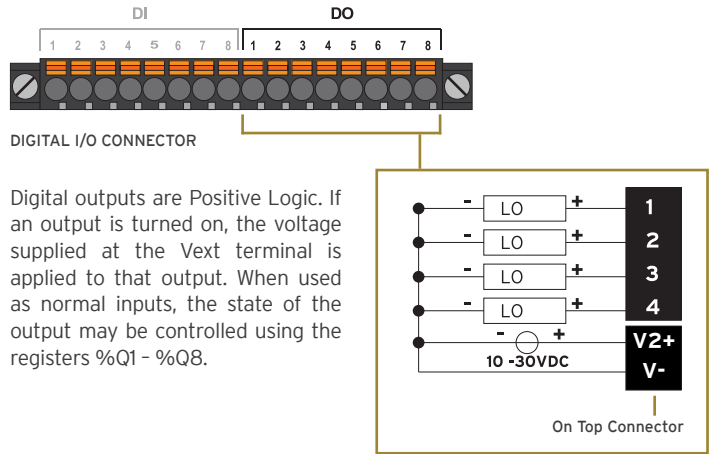

Digital outputs are Positive Logic. If an output is turned on, the voltage supplied at the Vext terminal is applied to that output. When used as normal inputs, the state of the output may be controlled using the registers %Q1 - %Q8.

3.3 - Analog Input Wiring

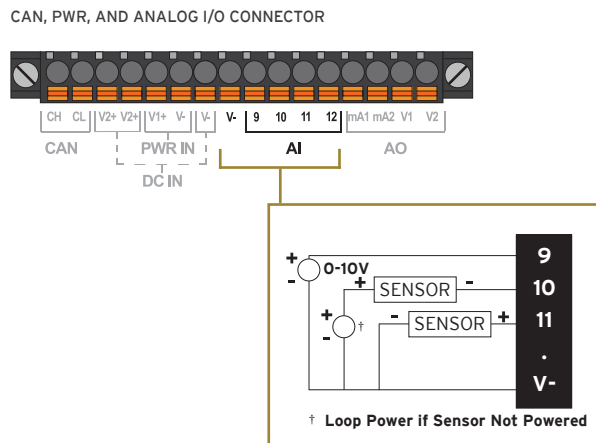

Raw input values for channels 1-4 are found in the registers as Integer-type data with a range from 0 - 32000.

Analog inputs may be filtered digitally with the Filter Constant found in the Cscape Hardware Configuration for Analog Inputs. Valid filter values are 0 - 7 and act according to the following chart.

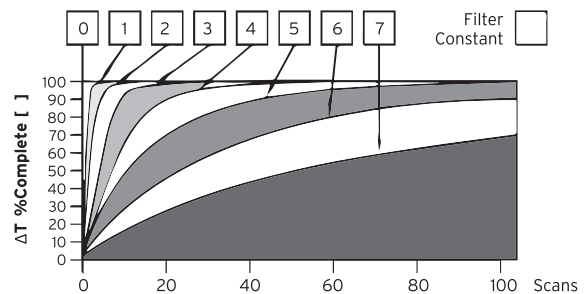

Data Values

INPUT MODE:	DATA FORMAT, 12-bit INT:
0-20mA, 4-20mA	0-32000
0-10V	0-32000

wiring: I/O continued...

3.4 - Analog Output Wiring

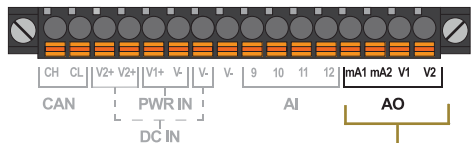

Each Analog Output may be specified for a range of 0-10VDC, 0-20mA DC or 4-20mA DC. For whichever range is configured, the Analog Output registers %AQ1 - %AQ4 may be used to control the output by placing a value between 0 - 32000 into the register. This may be directly from a PID loop output or a conversion from a desired output from the touchscreen, for example.

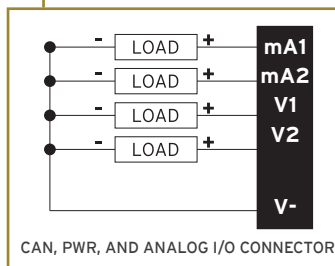

4 COMMUNICATIONS

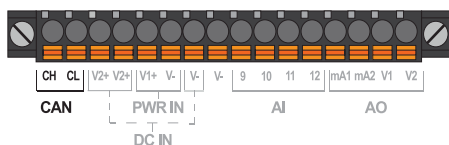

4.1 - CAN Communications

The CAN port is provided via three connections on the CAN, Power, and Analog connector: CAN_LOW (CL), CAN_HIGH (CH), and V- (C). It may be used to communicate with other OCS products using Horner's CsCAN protocol. Additionally, remote expansion I/O such as SmartRail, SmartBlock, and SmartStix may be implemented using the CsCAN protocol. If CsCAN expansion I/O is to be used, a 24VDC power source will be required on the CsCAN bus in order to power the expansion I/O modules.

4.2 - Ethernet Communications

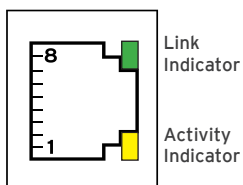

A 10/100 Ethernet port with automatic MDI-X (crossover detection) is provided via the single 8-position modular jack labeled "LAN". Several features are available for use over Ethernet, such as WebMI, Modbus TCP/IP, Ethernet/IP, SMTP (E-mail), expansion I/O to SmartRail, and more. Ethernet configuration is done via the Cscape Hardware Configuration. For more information on Ethernet, available features and protocols, refer to the Ethernet Supplement document (SUPO740).

4.3 - microSD Slot

A microSD card may be used for data and alarm logging, historic trending, program loading, firmware updates, and many other features. Supported types of microSD cards are SD, SDHC, and SDXC as long as the format of the card file system is FAT32.

communications continued...

4.4 - Serial Communications

Two serial ports are provided via the single 8-position modular jack labeled "MJ1/2". MJ1 defaults to one of several methods available to program the controller. It may instead be specified for RS-232 communications, such as for Modbus Master/Slave, or to communicate to devices such as bar code scanners.

MJ2 may only be used as half-duplex (2-wire) RS-485. The most common use is for Modbus communications, either as a Modbus Master or Modbus Slave, though other options are also available.

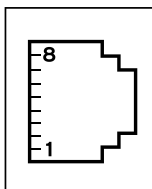

MJ1/2 SERIAL PORTS

MJ1: RS-232 w/full handshaking

MJ2: RS-485 half-duplex

MJ1 PINS			MJ2 PINS	
PIN	SIGNAL	DIRECTION	SIGNAL	DIRECTION
8	TXD	OUT	-	-
7	RXD	IN	-	-
6	0V	GROUND	0V	GROUND
5	+5V @ 60mA	OUT	+5V @ 60mA	OUT
4	RTS	OUT	-	-
3	CTS	IN	-	-
2	-	-	RX-/TX-	IN/OUT
1	-	-	RX+/TX+	IN/OUT

NOTE: Refer to connector pinout on product.

Both serial ports are in one modular jack. To break pins out to terminals, use HE200MJ2TRM accessory.

4.5 - Status LEDs



Three LEDs provide general status of the RCC:

LED - Normal Functionality

LED TYPE	WHEN OFF	WHEN ON	WHEN FLASHING (1 Hz)
PWR	No power applied	10-30VDC applied	N/A
OK	Self-test fail	Self-test pass	I/O forcing enabled
RUN	Stop mode	Run mode	Do I/O Mode

LED - DIAGNOSTIC FUNCTIONALITY

When the OK and RUN are flashing alternately, a download is in progress. When the flashing stops, the download is complete and the unit reboots (allow 30 seconds). When flashing together, the download has failed, and the number of flashes indicates the error. There will be a two second gap and the pattern will be repeated. The number of flashes and the associated error are as follows:

- **2 Flashes** - The MAC ID is empty.
- **3 Flashes** - The internal MAC file is corrupt.
- **4 Flashes** - The MAC ID TXT file is invalid.
- **5 Flashes** - The MAC ID file is not found or the microSD card is empty or missing system files.

communications continued...

6 INSTALLATION DIMENSIONS

4.6 - Buttons



Two recessed buttons provide control of several R C C modes. A paperclip may be used as the buttons are far enough recessed that a pen or pencil is not able to activate them.

LOAD SWITCH

- Pressing the LOAD switch during power-up boots from the microSD card. This starts a Firmware Load if the microSD is bootable and valid firmware files are found on it.
- After boot-up, pressing the LOAD switch for three (3) seconds will load an Application file stored on the microSD. The application file name must be DEFAULT.PGM. When loading an application file from microSD, there should not be firmware files present on the microSD card.

RUN/STOP SWITCH

- After boot-up, pressing the RUN/STOP switch for 3 seconds toggles the RCC between RUN and STOP modes.

ERASE PROGRAM FUNCTION

- After boot-up, pressing both Load and RUN/Stop switches for 3 seconds performs an "Erase All" function, which deletes all application programs.

5 BUILT-IN I/O

Digital and Analog I/O Functions

Registers	Description
%I1 to %I8	Digital Inputs
%I9 to %I15	Reserved
%I16	%Q Fault Status
%Q1 to %Q8	Digital Outputs
%AI1 to %AI8	Analog Inputs
%AQ1 to %AQ4	Analog Outputs

6.1 Dimensions

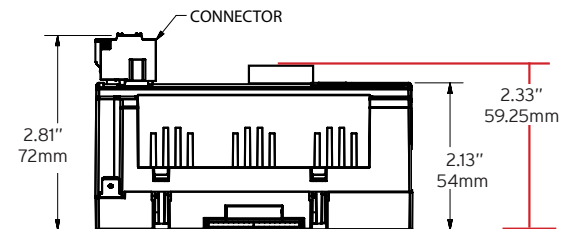
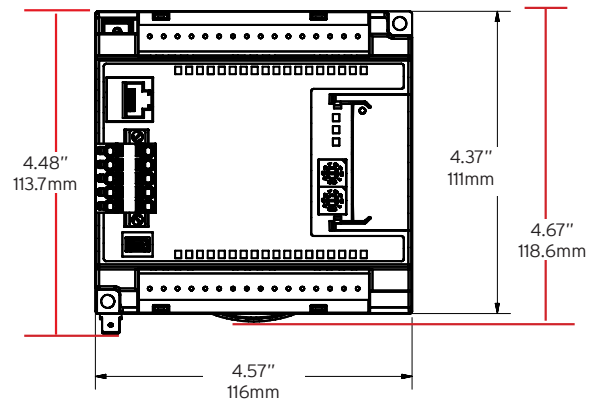

Clearance Requirements

Top and Bottom: 1" or 25.4mm
Sides: 0.5" or 12.7mm

6.2 Installation Instructions

These RCC modules are suitable for use in the Class I, Division 2, Groups A, B, C and D Hazardous Locations only. The operating temperature range is -10°C to +60°C

WARNING - EXPLOSION HAZARD - DO NOT DISCONNECT EQUIPMENT UNLESS POWER HAS BEEN SWITCHED OFF OR THE AREA IS KNOWN TO BE NON-HAZRDOUS.

ATTENTION - RISQUE D'EXPLOSION - NE DÉBRANCHEZ PAS L'ÉQUIPEMENT SAUF SI L'ALIMENTATION A ÉTÉ COUPÉE OU SI LA ZONE N'EST PAS DANGEREUSE.

Devices shall be installed into an enclosure suitable for the environment that is only accessible with the use of a tool.

- The RCC modules conveniently mount on a DIN rail.
- Be sure the DIN rail is in a horizontal position before installing the unit.
- The orientation shown to the right is necessary to prevent the unit from slipping off the DIN rail.
- Align the unit on the DIN rail then push the DIN rail clip until it clicks into place. Check to ensure that the unit is secure on the DIN rail.
- Do NOT mount the unit on its side as this may cause the unit from slipping off the DIN rail.

NOTE: The spade connector for grounding and the DIN rail clip add to the overall measurements. The CAN/PWR and LAN connectors also add to the measurements.

NOTE: Screw holes and a spade connector are available for a mounting option.

8 BATTERY

The RCC2414 has an advanced battery system that uses a rechargeable lithium battery. The battery powers the real time clock when power is removed, and it is needed for register data retention. Please reference the RCC Series User Manual [MAN1078] which provides instructions on how to replace the battery.

NOTE: For detailed rechargeable battery information, refer to the Battery Manual [MAN1142].

7 SAFETY

7.1 - WARNINGS

1. To avoid the risk of electric shock or burns, always connect the safety (or earth) ground before making any other connections.
2. To reduce the risk of fire, electrical shock, or physical injury, it is strongly recommended to fuse the voltage measurement inputs. Be sure to locate fuses as close to the source as possible.
3. Replace fuse with the same type and rating to provide protection against risk of fire and shock hazards.
4. In the event of repeated failure, do NOT replace the fuse again as repeated failure indicates a defective condition that will NOT clear by replacing the fuse.
5. Only qualified electrical personnel familiar with the construction and operation of this equipment and the hazards involved should install, adjust, operate, or service this equipment. Read and understand this manual and other applicable manuals in their entirety before proceeding. Failure to observe this precaution could result in severe bodily injury or loss of life.

7.2 - FCC COMPLIANCE

This device complies with part 15 of the FCC Rules. Operation is subject to the following two conditions:

1. This device may not cause harmful interference
2. This device must accept any interference received, including interference that may cause undesired operation

7.3 - PRECAUTIONS

All applicable codes and standards need to be followed in the installation of this product. Adhere to the following safety precautions whenever any type of connection is made to the module:

1. Connect the safety (earth) ground on the power connector first before making any other connections.
2. When connecting to the electric circuits or pulse-initiating equipment, open their related breakers.
3. Do NOT make connection to live power lines.
4. Make connections to the module first; then connect to the circuit to be monitored.
5. Route power wires in a safe manner in accordance with good practice and local codes.
6. Wear proper personal protective equipment including safety glasses and insulated gloves when making connections to power circuits.
7. Ensure hands, shoes, and floor are dry before making any connection to a power line.
8. Make sure the unit is turned OFF before making connection to terminals.
9. Make sure all circuits are de-energized before making connections.
10. Before each use, inspect all cables for breaks or cracks in the insulation. Replace immediately if defective.
11. Use copper conductors in Field Wiring only, 60/75°C.

9 TECHNICAL SUPPORT

For assistance and manual updates, contact Technical Support at the following locations:

North America

+1 (877) 665-5666
+1 (317) 916-4274
www.hornerautomation.com
techsppt@heapg.com

Europe

+353 (21) 4321-266
www.hornerautomation.eu
technical.support@horner-apg.com