



User Manual for Horner Wi-Fi HE-WIFIUSB

MAN1234-04-EN_HE-WIFIUSB_UM

PREFACE

This manual explains how to use the Horner Wi-Fi, HE-WIFIUSB.

Copyright© 2020 Horner APG, LLC, 59 South State Avenue, Indianapolis, Indiana 46201. All rights reserved. No part of this publication may be reproduced, transmitted, transcribed, stored in a retrieval system, or translated into any language or computer language, in any form by any means, electronic, mechanical, magnetic, optical, chemical, manual or otherwise, without the prior agreement and written permission of Horner APG, Inc.

All software described in this document or media is also copyrighted material subject to the terms and conditions of the Horner Software License Agreement.

Information in this document is subject to change without notice and does not represent a commitment on the part of Horner APG.

Ethernet™ is a trademark of Xerox Corporation.
microSD™ and CompactFlash are registered trademarks of SanDisk Corporation.

For user manual updates, contact Technical Support:

North America:

Tel: (+) (317) 916-4274

Fax: (+) (317) 639-4279

Website: <https://hornerautomation.com>

Email: techsppt@heapg.com

Europe:

Tel: (+) 353-21-4321-266

Fax: (+) 353-21-4321-826

Website: <http://www.hornerautomation.eu>

Email: technical.support@horner-apg.com

LIMITED WARRANTY AND LIMITATION OF LIABILITY

Horner APG, LLC, ("HE-APG") warrants to the original purchaser that the HE-WIFIUSB module manufactured by HE-APG is free from defects in material and workmanship under normal use and service. The obligation of HE-APG under this warranty shall be limited to the repair or exchange of any part or parts which may prove defective under normal use and service within two (2) years from the date of manufacture or eighteen (18) months from the date of installation by the original purchaser whichever occurs first, such defect to be disclosed to the satisfaction of HE-APG after examination by HE-APG of the allegedly defective part or parts. THIS WARRANTY IS EXPRESSLY IN LIEU OF ALL OTHER WARRANTIES EXPRESSED OR IMPLIED INCLUDING THE WARRANTIES OF MERCHANTABILITY AND FITNESS FOR USE AND OF ALL OTHER OBLIGATIONS OR LIABILITIES AND HE-APG NEITHER ASSUMES, NOR AUTHORIZES ANY OTHER PERSON TO ASSUME FOR HE-APG, ANY OTHER LIABILITY IN CONNECTION WITH THE SALE OF THIS HE-WIFIUSB MODULE. THIS WARRANTY SHALL NOT APPLY TO THIS HE-WIFIUSB MODULE OR ANY PART THEREOF WHICH HAS BEEN SUBJECT TO ACCIDENT, NEGLIGENCE, ALTERATION, ABUSE, OR MISUSE. HE-APG MAKES NO WARRANTY WHATSOEVER IN RESPECT TO ACCESSORIES OR PARTS NOT SUPPLIED BY HE-APG. THE TERM "ORIGINAL PURCHASER", AS USED IN THIS WARRANTY, SHALL BE DEEMED TO MEAN THAT PERSON FOR WHOM THE HE-WIFIUSB MODULE IS ORIGINALLY INSTALLED. THIS WARRANTY SHALL APPLY ONLY WITHIN THE BOUNDARIES OF THE CONTINENTAL UNITED STATES.

In no event, whether as a result of breach of contract, warranty, tort (including negligence) or otherwise, shall HE-APG or its suppliers be liable of any special, consequential, incidental or penal damages including, but not limited to, loss of profit or revenues, loss of use of the products or any associated equipment, damage to associated equipment, cost of capital, cost of substitute products, facilities, services or replacement power, down time costs, or claims of original purchaser's customers for such damages.

To obtain warranty service, return the product to your distributor with a description of the problem, proof of purchase, postpaid, insured and in a suitable package.

ABOUT PROGRAMMING EXAMPLES

Any example programs and program segments in this manual or provided on accompanying diskettes are included solely for illustrative purposes. Due to the many variables and requirements associated with any installation, Horner APG cannot assume responsibility or liability for actual use based on the examples and diagrams. It is the sole responsibility of the system designer utilizing the HE-WIFIUSB module to appropriately design the end system, to appropriately integrate the HE-WIFIUSB module and to make safety provisions for the end equipment as is usual and customary in industrial applications as defined in any codes or standards which apply.

NOTE: The programming examples shown in this manual are for illustrative purposes only. Proper machine operation is the sole responsibility of the system integrator.

Table of Contents

CHAPTER 1: SAFETY / COMPLIANCE	6
1.1 Safety Warnings and Guidelines.....	6
1.2 Compliance	7
CHAPTER 2: INTRODUCTION.....	8
2.1 Overview of the Horner Wi-Fi, HE-WIFIUSB.....	8
CHAPTER 3: HE-WIFIUSB DIMENSIONS & INSTALLATION.....	10
3.1 Mounting.....	10
3.2 Dimensions.....	11
3.3 Installation Instructions.....	12
CHAPTER 4: SYSTEM MENU.....	13
4.1 System Menu Overview	13
4.2 Setting up Wi-Fi.....	13
4.3 Access Point Mode.....	14
4.4 Setting up Access Point Mode.....	15
4.5 Client Mode	19
4.6 Setting up Client Mode.....	20
CHAPTER 5: GENERAL CONFIGURATIOIN	24
5.1 Wi-Fi Configuration via Cscape	24
5.2 Modes - Get Mode From	26
5.3 Modes - Access Point or Client.....	27
5.4 - Wi-Fi Update.....	27
5.5 Access Point Mode.....	28
5.6 Client Mode	29
5.7 Status	29
5.8 Advanced Settings	30
5.9 Wi-Fi General LAN Config.....	31
5.10 Wi-Fi Configuration through System Menu.....	32
CHAPTER 6: RESIDENT PROTOCOLS (ETHERNET)	33
CHAPTER 7: ICMP CONFIGURATION	34
7.1 ICMP Overview	34
7.2 ICMP Configuration.....	35
7.3 ICMP Operation.....	36
CHAPTER 8: EGD (ETHERNET GLOBAL DATA)	37
8.1 EGD Overview.....	37
8.2 EGD Terminology.....	38
8.3 EGD Configuration	39
8.4 EGD Produced Exchange Configuration	40
8.5 EGD Produced Exchanges: Unicast and Multicast.....	42
8.6 Defining EGD Produced Exchange I/O Blocks	45
8.7 EGD Consumed Exchange Configuration	47
8.8 Creating EGD Consumed Exchanges	49
8.9 Defining EGD Consumed Exchange I/O Blocks	51
8.10 Adding an OCS Timestamp Block Configuration	53
8.11 Filler Block Configuration.....	56
8.12 EGD Unicast and Multicast	58

8.13	EGD Status Words	59
8.14	EGD Produced Exchange Status Words	59
8.15	EGD Consumed Exchange Status Words	60
8.16	EGD Example 1: UNICAST EXCHANGE	61
8.17	EGD Example 2 - MULTICAST EXCHANGE.....	72
CHAPTER 9: SERVICE REQUEST TRANSFER PROTOCOL (STRP)		81
9.1	STRP Overview	81
9.2	STRP Configuration	82
9.3	STRP Operation	83
CHAPTER 10: FTP SERVER PROTOCOL		84
10.1	FTP Server Protocol Overview.....	84
10.2	FTP Configuration	85
10.3	FTP Operation	87
10.4	FTP File Accessing.....	87
CHAPTER 11: HTTP SERVER PROTOCOL.....		88
11.1	HTTP Overview	88
11.2	HTTP Configuration	88
11.3	HTTP Operation	90
11.4	Web Content - Storing.....	91
11.5	Web Content - Dynamic Data	91
11.6	Web Content - Authoring.....	97
CHAPTER 12: ASCII over TCP/IP		99
12.1	Overview.....	99
12.2	ASCII Configuration	99
12.3	Sending ASCII characters to the client	100
12.4	Receiving ASCII Characters from the Client.....	101
12.5	Status Information	101
CHAPTER 13: DOWNLOADABLE PROTOCOLS (ETHERNET)		102
13.1	Modbus Overview	102
13.2	Modbus Client.....	107
13.3	Network Config	107
13.4	Device Config.....	108
13.5	Scan List	114
CHAPTER 14: SAFETY & WARNINGS.....		117
14.1	Warnings.....	117
14.2	FCC Compliance	117
14.3	Precautions	117
CHAPTER 15: TECHNICAL SUPPORT		118
15.1	Technical Support Contacts	118
CHANGE LOG		119
INDEX.....		120

CHAPTER 1: SAFETY / COMPLIANCE

1.1 Safety Warnings and Guidelines

When found on the product, the following symbols specify:



Warning: Consult user documentation.



Warning: Electrical Shock Hazard.

WARNING - EXPLOSION HAZARD - Do not disconnect equipment unless power has been switched off or the area is known to be non-hazardous

WARNING: To avoid the risk of electric shock or burns, always connect the safety (or earth) ground before making any other connections.

WARNING: To reduce the risk of fire, electrical shock, or physical injury it is strongly recommended to fuse the voltage measurement inputs. Be sure to locate fuses as close to the source as possible.

WARNING: Replace fuse with the same type and rating to provide protection against risk of fire and shock hazards.

WARNING: In the event of repeated failure, do not replace the fuse again as a repeated failure indicates a defective condition that will not clear by replacing the fuse.

WARNING - EXPLOSION HAZARD: Substitution of components may impair suitability for Class I, Division 2

- a. All applicable codes and standards need to be followed in the installation of this product.
- b. For I/O wiring (discrete), use the following wire type or equivalent: Belden 9918, 18 AWG or larger.

Adhere to the following safety precautions whenever any type of connection is made to the module.

- a. Connect the green safety (earth) ground first before making any other connections.
- b. When connecting to electric circuits or pulse-initiating equipment, open their related breakers. Do not make connections to live power lines.
- c. Make connections to the module first; then connect to the circuit to be monitored.
- d. Route power wires in a safe manner in accordance with good practice and local codes.
- e. Wear proper personal protective equipment including safety glasses and insulated gloves when making connections to power circuits.
- f. Ensure hands, shoes, and floors are dry before making any connection to a power line.
- g. Make sure the unit is turned OFF before making connection to terminals. Make sure all circuits are de-energized before making connections.
- h. Before each use, inspect all cables for breaks or cracks in the insulation. Replace immediately if defective.

1.2 Compliance

To check for compliance and updates, visit the Horner website.

North America: <https://hornerautomation.com> or Europe: <http://www.hornerautomation.eu>

CHAPTER 2: INTRODUCTION

2.1 Overview of the Horner Wi-Fi, HE-WIFIUSB

The Horner Wi-Fi module provides both client and access point support to OCS units that support USB Host connections. USB Wi-Fi is supported in XL4e, XL7e, EXL10e, EXL6e, EXLW, RCC2414, X5 and XL+ models. As an access point, OCS allows other Wi-Fi devices to connect to a wired network. Using client mode, the OCS can connect to an established Wi-Fi network. As an Access point or client mode user can connect laptops for programming or phones and tablets for WebMI and Ethernet protocols supported by the OCS, excluding NTP and Ethernet IP Protocols can be accessed via Wi-Fi connectivity.

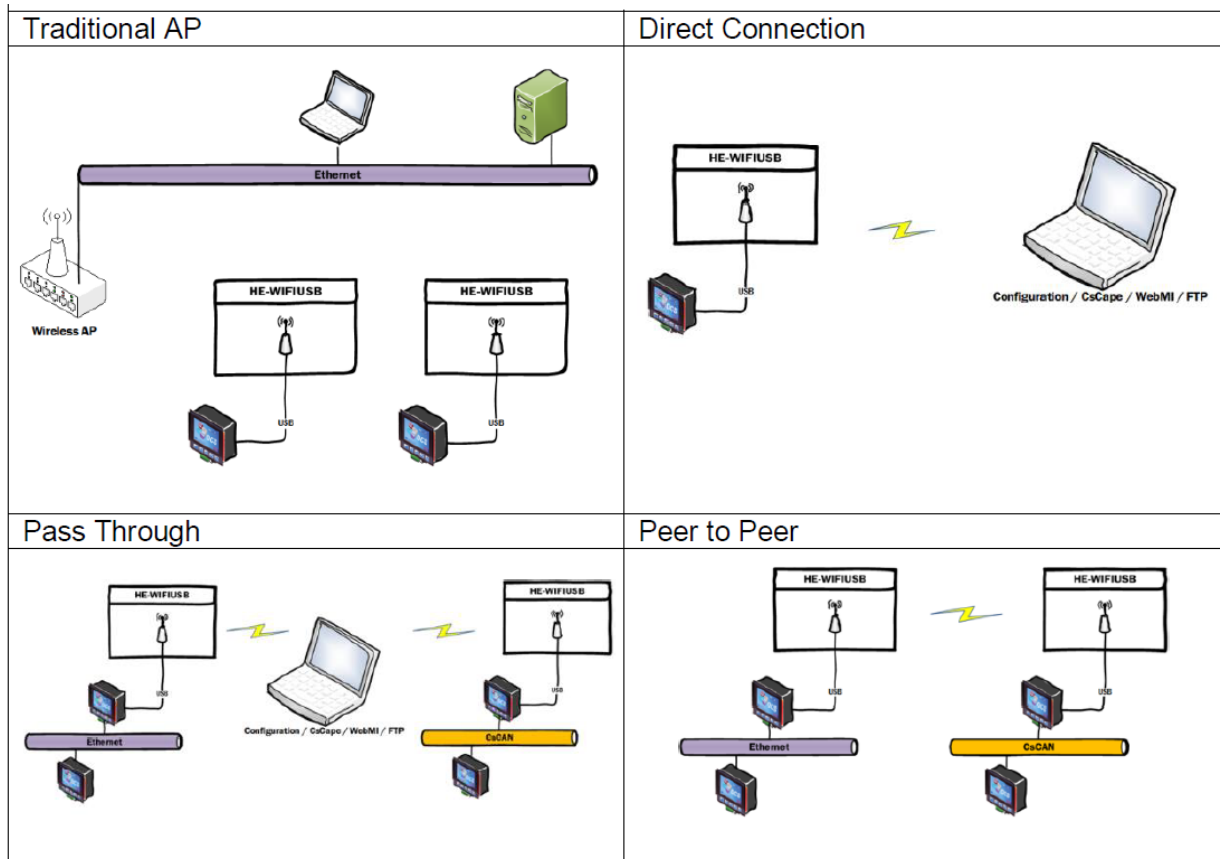

2.1.1 Where to Find Information about the HE-WIFIUSB

1. **Datasheet** - The datasheet is the first document to refer to for key information:
 - a. The sensor datasheet, MAN1233, on the Horner websites.
 - b. Datasheet contains more specific information.
2. **User Manual** -This manual provides general information that is common to HE-WIFIUSB and can be downloaded from our websites. Visit the Horner website to obtain user documentation and updates. North America: <https://hornerautomation.com> or Europe: <http://www.hornerautomation.eu>

2.1.2 Three main types of information are covered in this manual

- a) Safety and Installation guidelines / instructions (Mechanical)
- b) Description of hardware features
- c) Types of Configuration
- d) Support

CHAPTER 3: HE-WIFIUSB DIMENSIONS & INSTALLATION

3.1 Mounting

The Horner HE-WIFIUSB unit requires a Horner Automation OCS with USB 2.0 HOST Support. Plug in Horner HE-WIFIUSB and then set up communications using [Communications Chapter](#).

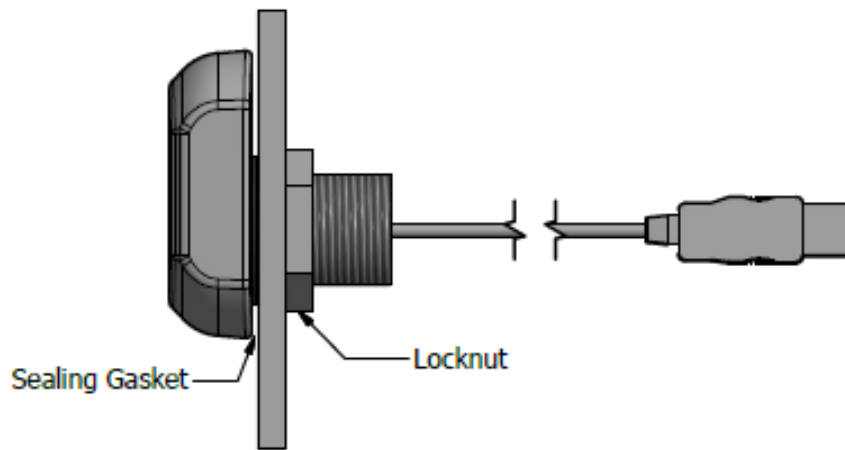

Thread: 3/4 NPT Pipe Size, 14 threads per inch, .055" Threads Engagement

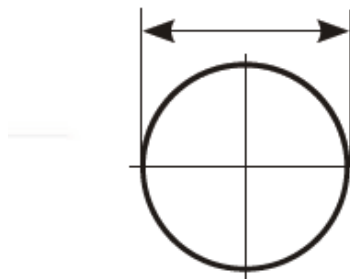

Panel Cutout Dimensions: 27.67mm (1.05")
Tolerance: +/- 1 mm

3.2 Dimensions

Thread: 3/4 NPT Pipe Size, 14 threads per inch, .055" Threads Engagement

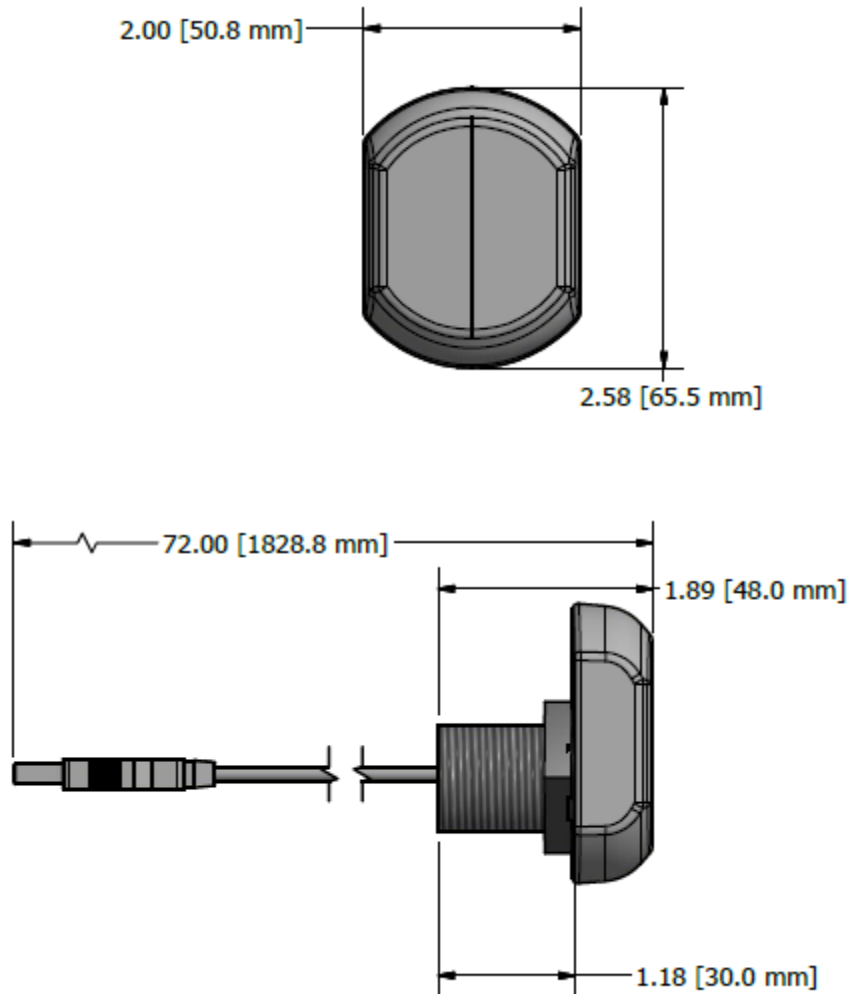

NOTE: The Wi-Fi unit is designed to be mounted outside the panel for best range. Mounting inside metal cabinets will significantly reduce the range of this product.

Remove power from the OCS, plug the Wi-Fi unit into the OCS USB port and reapply power.

3.3 Installation Instructions

NOTE: HE-WIFIUSB unit is designed to be mounted outside the panel box. Mounting inside metal cabinets will significantly reduce the range of this product.

- 1) Ensure your controller is updated to the most recent version of firmware dependent on its version.
- 2) Turn off the controller.
- 3) Drill a hole in the panel box housing according to diagram below.
- 4) Place the sealing gasket then place the HE-WIFIUSB unit in the panel cutout. Place the locknut on the threads and tighten to hand tight.

NOTE: Using a tool on the plastic threads could damage the unit.

- 5) Plug the HE-WIFIUSB into the USB port on controller.
- 6) Turn on the controller. The HE-WIFIUSB unit will now be active.

CHAPTER 4: SYSTEM MENU

4.1 System Menu Overview

Each Horner OCS controller has a built-in System Menu, which allows the user to view the System Settings and make adjustments. Press the SYSTEM Key or press in the upper right of the screen if no buttons are visible to open the System Menu. Then use the up or down arrows to select and display the Wi-Fi Setting sub menu.

NOTE: XL4e screenshots were used for this manual.

The HE-WIFIUSB can be set up in either Access Point Mode or Client Mode.

- **Access Point Mode** - In Access Point mode a connection from up to 8 wireless devices can be made to the OCS. This would allow WebMI or any other Ethernet based protocol as well.
- **Client Mode** - - This mode allows connecting an OCS to another router or access point including another OCS in access point mode.

4.2 Setting up Wi-Fi

Step 1: In the System Menu, select "Set Networks".

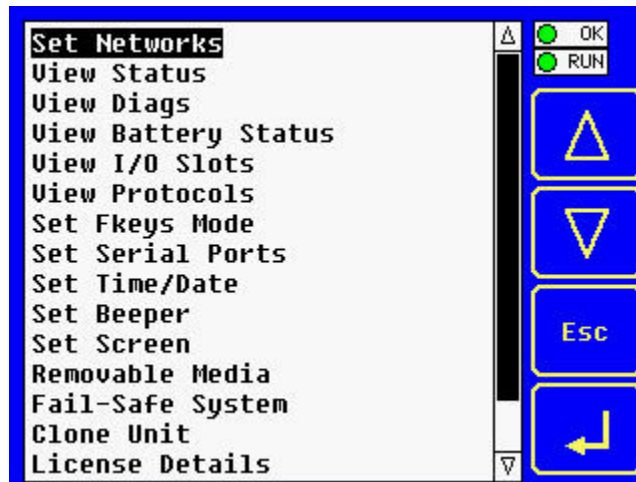

Step 2: In the Set Networks screen, select “WiFi Settings”

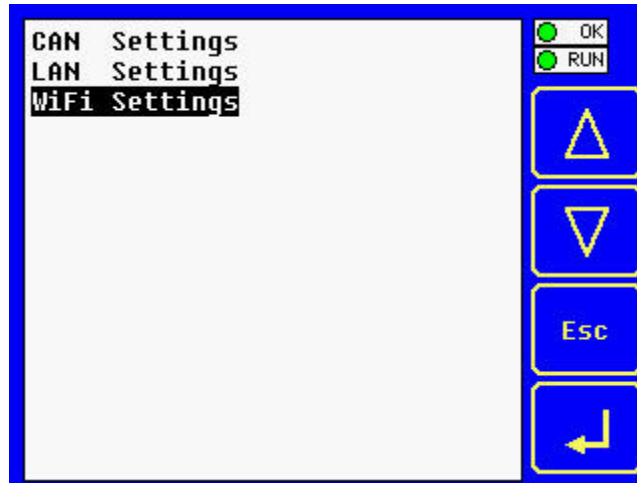

4.3 Access Point Mode

NOTE: If a HE-WIFIUSB is plugged into the OCS, the **Wi-Fi HW?** will indicate **Yes**.

Using the arrow buttons, select **Wi-Fi Mode**, then press the Enter arrow at the bottom right of the screen. The text to the right of **Wi-Fi Mode** will then be highlighted with options for **Access Point**, **Client**, or **Disable**. For Access Point Mode, select **Access Point**.

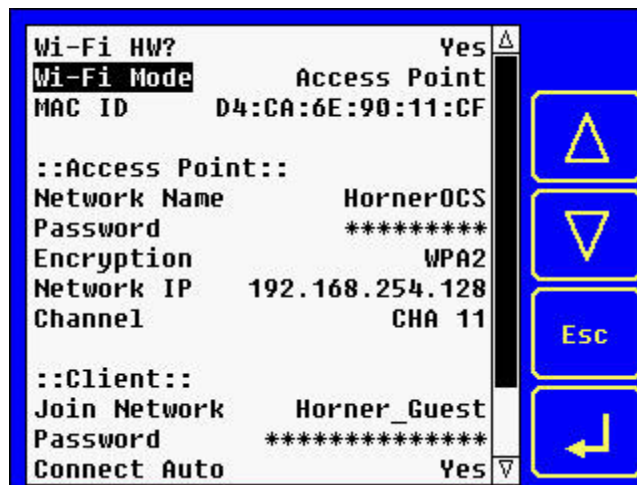

4.4 Setting up Access Point Mode

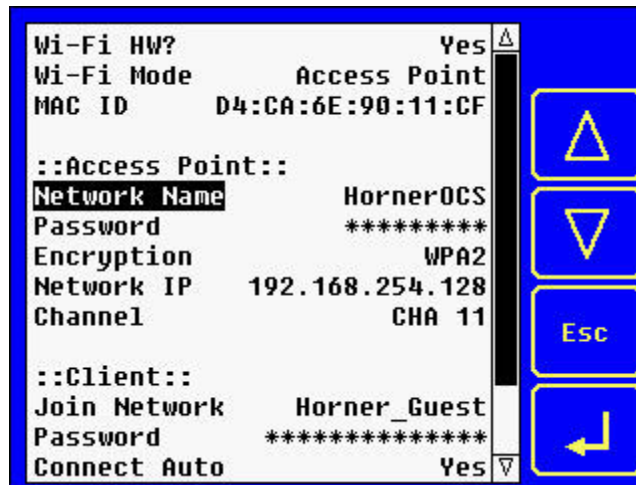

Step 1: Ensure that **Wi-Fi Mode** is set to **Access Point**.

Step 2: Using arrow keys, scroll down to **Network Name** and press the Enter arrow. This will open a numeric keypad with options for an alphabet keypad and a symbols keypad. See below. Using keypads, type in the network name and press **Enter**.

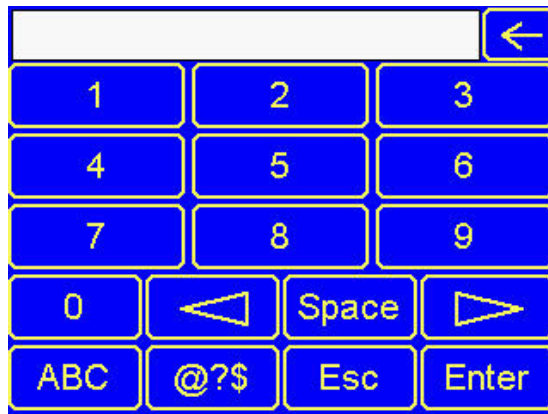

Alphabet Keypad

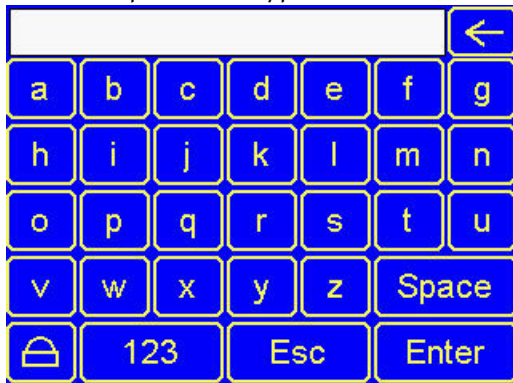

Symbols Keypad

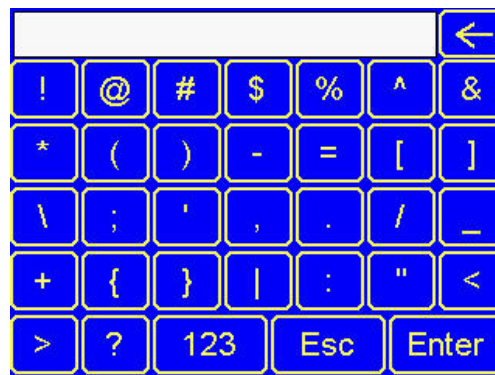

Step 3: Once **Network Name** is entered, use the arrows to scroll to **Password** and press the Enter arrow. Once again, the Numeric keypad will appear with options to use the alphabet and symbols keypad. Type in password and press **Enter**.

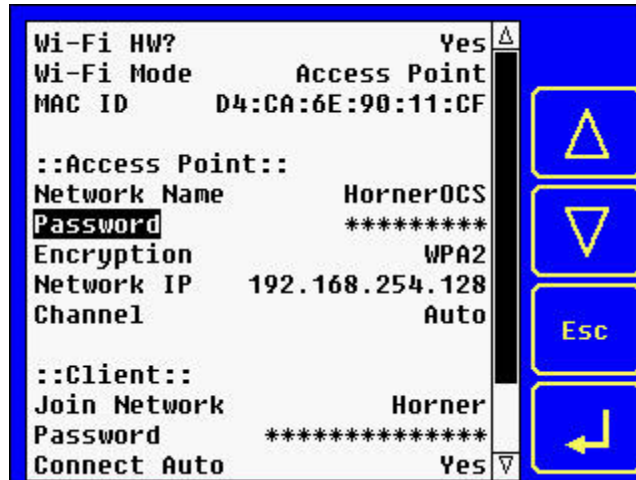

NOTE: The Encryption information will autopopulate. See below:

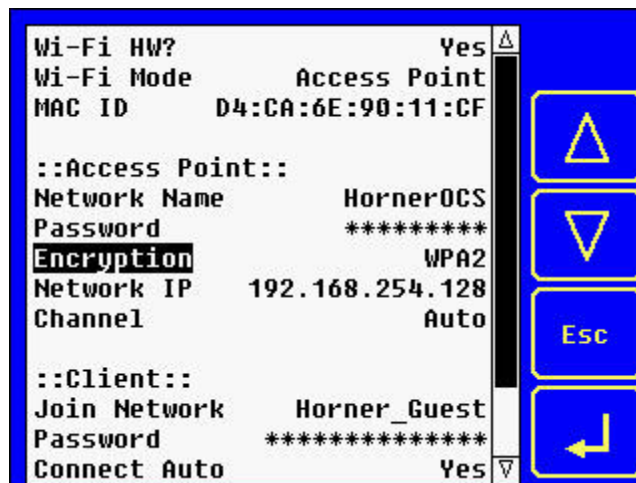

Step 4: Using the Arrow button, scroll down to **Network IP** and press the Enter arrow.

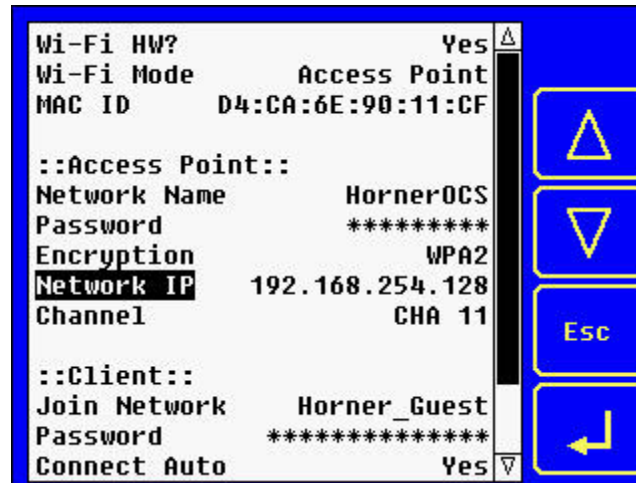

Step 5: A numeric keypad will open to add the IP Address. Add address and select **Enter**.

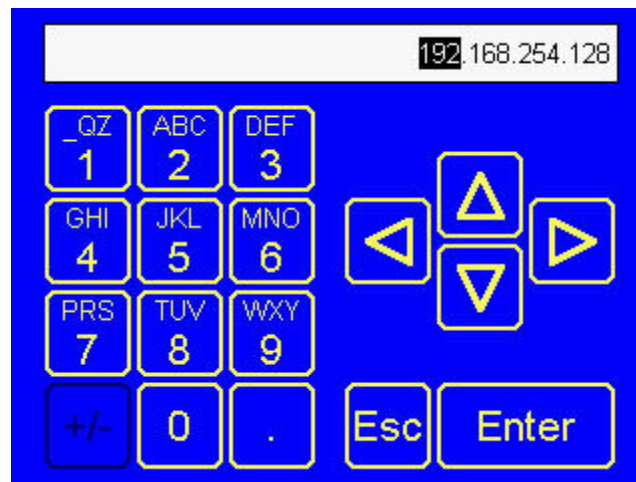

Step 6: Use the arrow button to scroll down to **Channel**. Then press the Enter arrow. Once the text to the right of Channel is highlighted, use an up or down arrow button to select one of the channel options that are supported: **Auto**, **Channel 1**, **Channel 6**, or **Channel 11**.

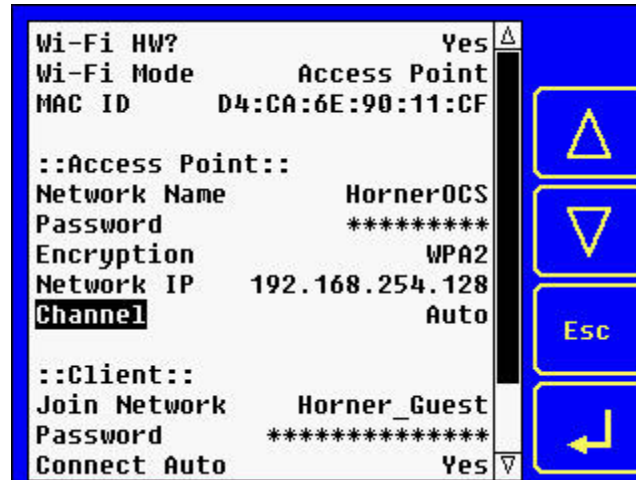

4.5 Client Mode

NOTE: If a HE-WIFIUSB is plugged into the OCS, the **Wi-Fi HW?** will indicate **Yes**.

Using the arrow buttons, select **Wi-Fi Mode**, then press the Enter arrow at the bottom right of the screen. The text to the right of **Wi-Fi Mode** will then be highlighted with options for **Access Point**, **Client**, or **Disable**. For Client Mode, select **Client**.

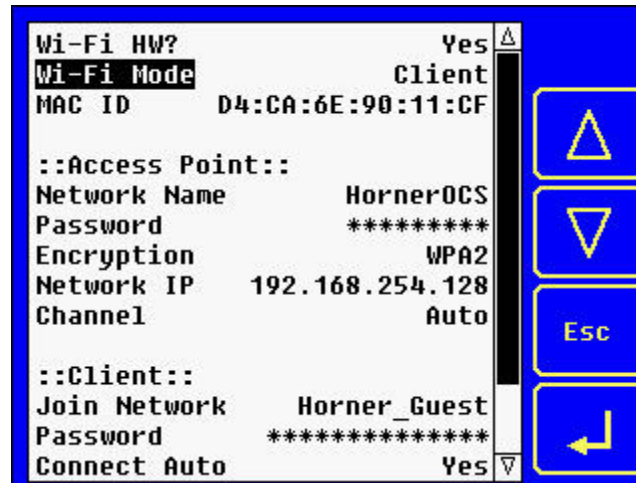

4.6 Setting up Client Mode

Step 1: Ensure that Wi-Fi Mode is set to **Client**.

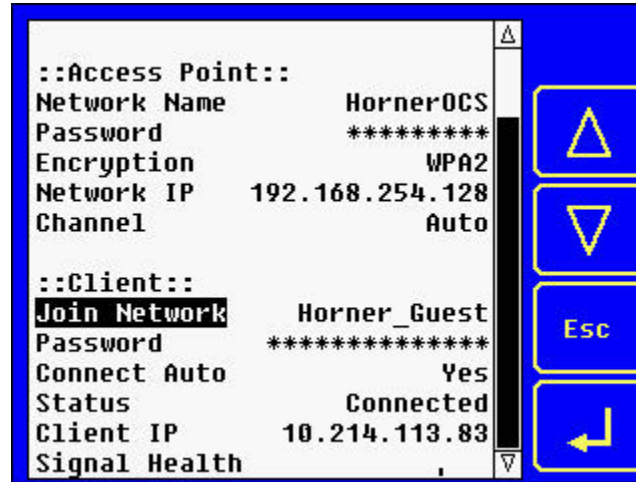

Step 2: Using arrow keys, scroll down to **Join Network** and press the Enter arrow.

Step 3: Select **Join Network** and the following screen will appear:

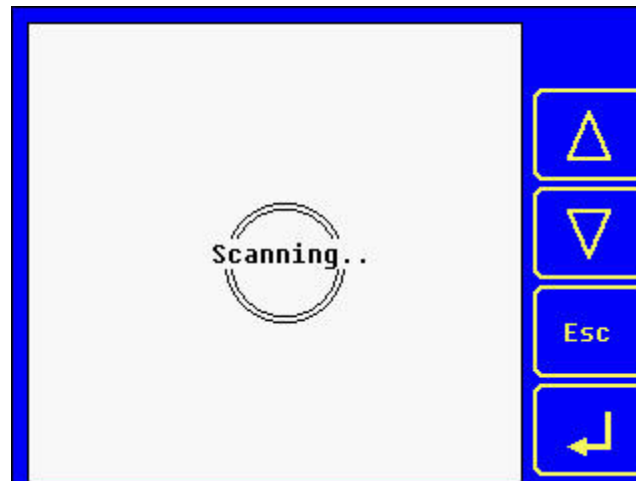

Once the HE-WIFIUSB has detected Access Points, the following screen will appear. Using the up or down arrows, select an Access Point. The small vertical lines to the right of the Access Point names indicate the Wi-Fi signal strength.

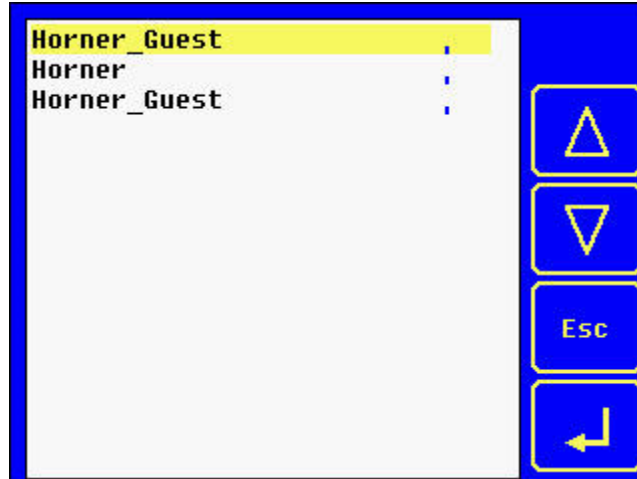

NOTE: This screen shows example names of Wi-Fi Access Points.

Step 4: Once **Join Network** information is entered, use the arrows to scroll to **Password** and press the Enter arrow. Once again, the Numeric keypad will appear with options to use the alphabet and symbols keypad. Type in password and press **Enter**.

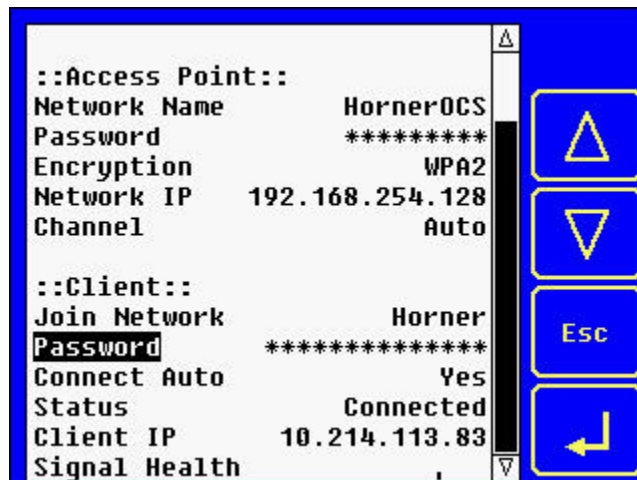

This will open a numeric keypad with options for an alphabet keypad and a symbols keypad. See below. Using keypads, type in the password and press **Enter**.

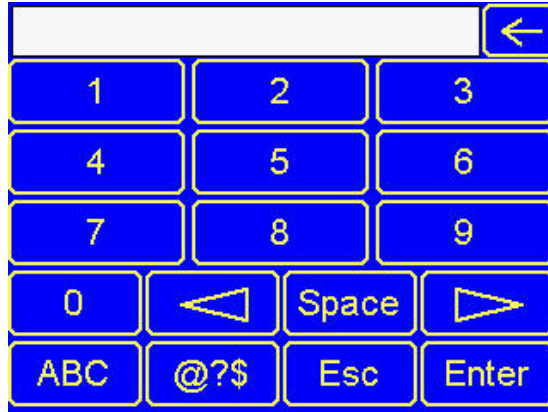

Alphabet Keypad



Symbols Keypad

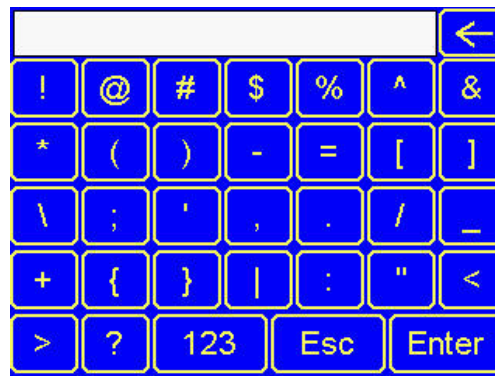

Step 5: Using the down arrow, scroll down to **Connect Auto** and press the Enter arrow. Select either **Yes** or **No** by using the up or down arrows. .

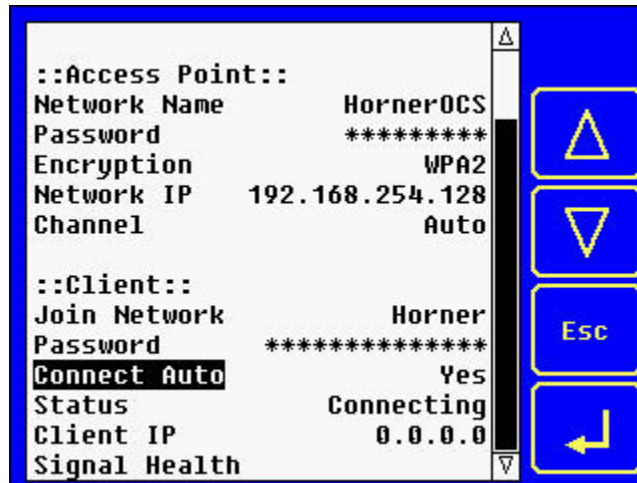

The **Status** and **Client IP** fields will autopopulate and the **Signal Health** information will update automatically.

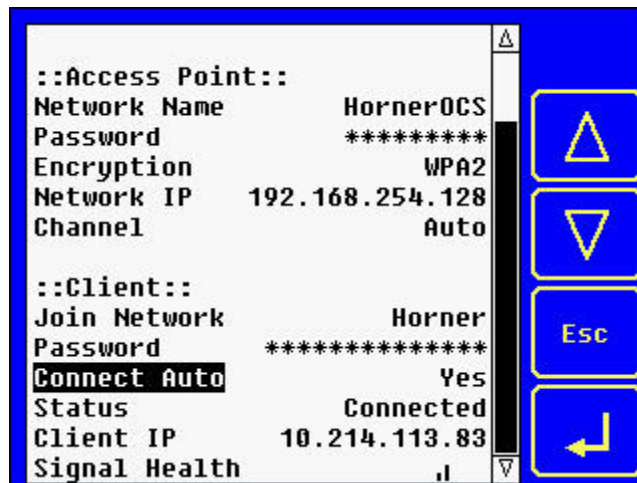

CHAPTER 5: GENERAL CONFIGURATION

5.1 Wi-Fi Configuration via Cscape

With device connected (where Wi-Fi is supported), open the **Hardware Configuration** dialog select and the following window will be displayed:

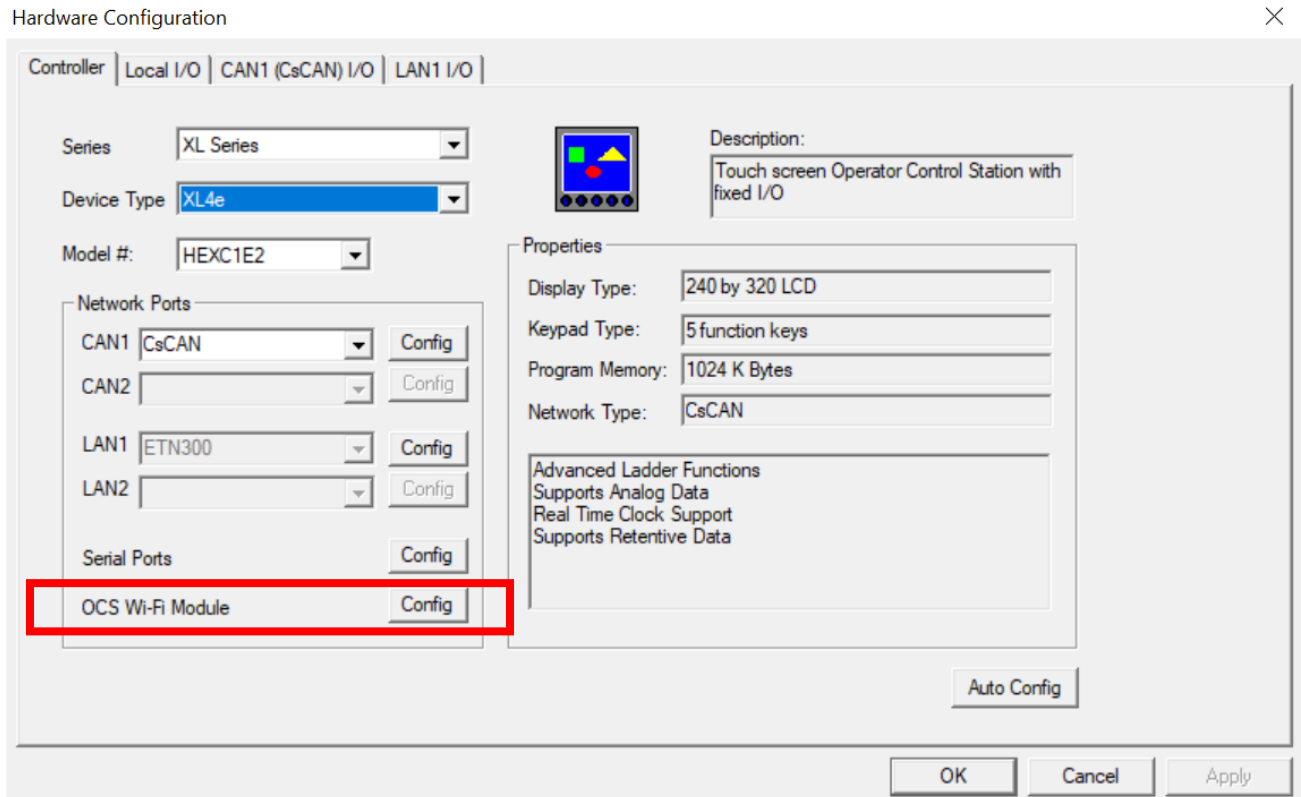

Select the OCS Wi-Fi Module **Config** to open OCS Wi-Fi Module Configuration, and the window below will be displayed:

The screenshot shows a configuration window titled "OCS Wi-Fi Module Configuration". It is divided into several sections:

- Modes:** "Get mode from" is set to "Configuration". "Mode" is set to "Access Point". A "Name:" field is present with a "16-BIT" label.
- Wifi Update:** "Register" and "Name:" fields are present with a "16-BIT" label.
- Access Point:** "SSID" is "HornerOCS" (8-BIT x 32). "Password" is "HornerOCS" (8-BIT x 32). "Security" is "WPA2". "Channel" is "Auto". A "Name:" field is present with a "16-BIT" label.
- Client Mode:** "SSID" and "Name:" fields are present with a "8-BIT x 32" label. "Password" and "Name:" fields are present with a "8-BIT x 32" label. There is an "Auto Connect" checkbox.
- Status:** "Register" and "Name:" fields are present with a "16-BIT" label.
- Advanced Settings:** "SSID broadcast" checkbox is unchecked. "Country Code" field is empty.

Buttons at the bottom include "General LAN Config >>", "OK", and "Cancel".

The rest of Chapter 5 discusses configuring the Horner Wi-Fi module. Chapters 6 through 13 discuss configuring Ethernet resident and downloadable protocols.

5.2 Modes - Get Mode From

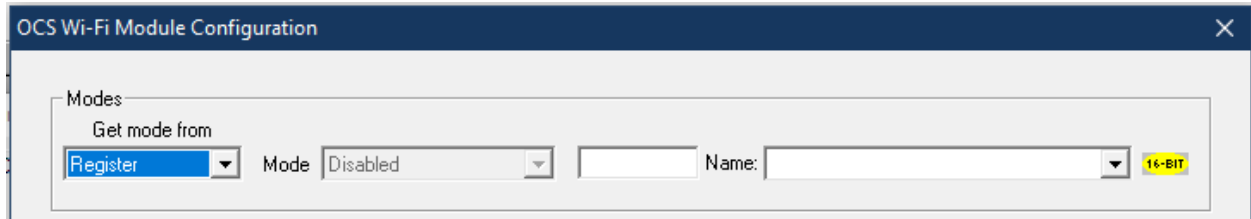

Get mode from has the following options:

- **Configuration** - If this option is used, the mode selected from the drop down will be considered.
- **Register** - User can change the Wi-Fi mode dynamically by moving corresponding value to the Register/variable.

Configuration through Register for Wi-Fi mode	
Register / Variable value	Mode
0	Disabled
1	Access point mode
2	Client Mode

- **Disabled** - Wi-Fi Configurations will be disabled.

5.3 Modes - Access Point or Client

The following modes are supported:



- **Disabled** - Wi-Fi mode will be disabled.
- **Access Point** - In Access Point mode a connection from up to 8 wireless devices can be made to the OCS. This would allow WebMI or any other Ethernet based protocol as well.
- **Client** - This mode allows an OCS to connect to an existing router or access point including another OCS in access point mode.

5.4 - Wi-Fi Update

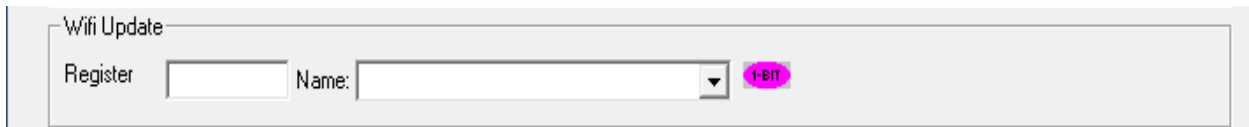

This option is used only when Wi-Fi configuration needs to be updated dynamically. When the register / Variable is set to "1" or "high", Wi-Fi configuration will be updated.

If access point SSID/Password or Client Mode SSID/password is configured through registers/Variables, then the dynamic change in SSID/Password will take effect only after triggering the Wi-Fi update register/Variable.

5.5 Access Point Mode

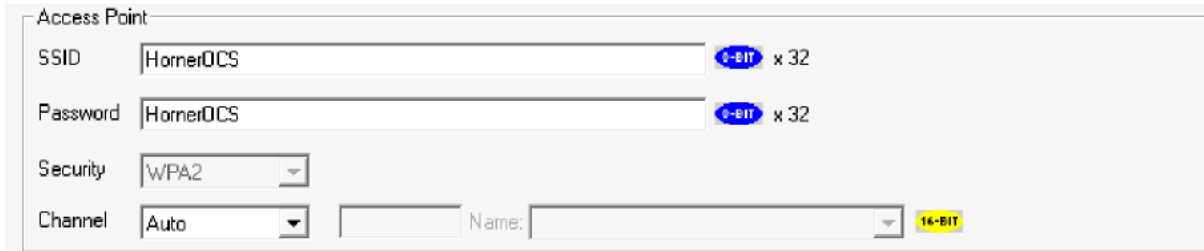

- **SSID** - This is a unique ID that consists of 16 characters and it is used for naming wireless networks. This field can be configured either with constants or via register/variable.
- **Password** - This is the password that is set for the SSID. This field can be configured either with constants or via register/variable.
- **Security** - This option is set to WPA2.
- **Channel** - The following channels are supported - Auto, Channel 1, Channel 6 and Channel 11. The channel can be selected from the drop-down box or it can be configured using registers/variable to change it dynamically by moving corresponding value to the register/variable.

Configuration through Register for Wi-Fi channel	
Register / Variable value	Channel
1	Channel 1
2	Channel 6
3	Channel 11
Else	Auto

NOTE:

1. Allowed special character in SSID or Password is ~!@#\$\$%^&*()_+-.<>
2. Access Point SSID Minimum allowed length is 4
3. Access Point SSID Maximum allowed length is 32
4. Access Point password Minimum allowed length is 8
5. Access Point password Maximum allowed length is 32

5.6 Client Mode

Client Mode

SSID Name: 8-BIT x 32

Password Name: 8-BIT x 32

Auto Connect

- **SSID** - This is a unique ID that consists of 32 characters and is used for naming wireless networks. This field can be configured either with constants or via registers.
- **Password** - This is the password that is set for the SSID. This field can be configured either with constants or via registers.
- **Auto Connect** - Selecting this option connects to the previously established connection (SSID) automatically.

NOTE: Allowed special character SSID or password ~!@#\$\$%^&*()_+++.<>

5.7 Status

The Status Register provides real-time diagnostics at run-time. The status register can be configured as a word-type register (ie %R), or 16 consecutive bit-type references (ie %T or %M) aligned to a word boundary (ie %T1, %T17, %T33, etc.).

Status Name: 16-BIT

Bits for Status Register (Status of the Wi-Fi Connectivity)	
Bit 1	High if Wi-Fi Module is connected / Low if Wi-Fi Module is disconnected
Bit 2	High when Access Point is established successfully
Bit 3	High when Client mode is connected successfully
Bit 4	High when Scanning in Client mode (Scan mode is to scan for available networks. This mode is available only in the System Menu of device.)
Bit 5	It will be set if configured Access Point SSID is invalid
Bit 6	It will be set if configured Access Point password is invalid
Bit 7 - 8	Reserved
Bits 9 - 12	Signal strength when devices in ST mode 0 = None 1 = Weak 2 = Fair 3 = Good 4 = Excellent

5.8 Advanced Settings

Advanced Settings

SSID broadcast Country Code

- **SSID Broadcast** - It is the continuous transmission of packets from a Wi-Fi access point that announced its availability. Selecting this option makes the SSID to be visible to other devices.
- **Country Code** - This is the country code where the Wi-Fi router is currently being operated. See Table 5.1 below.

Table 5.1 - Example List of Supported Country Codes	
US	United States
CA	Canada
DE	Germany
NL	Netherlands
IT	Italy
PT	Portugal
LU	Luxembourg
NO	Norway
FI	Finland
DK	Denmark
CH	Switzerland
CZ	Czech Republic
ES	Spain
GB	United Kingdom
FR	France
AU	Australia
AT	Austria
GR	Greece
IS	Iceland
IN	India
IE	Ireland
LI	Liechtenstein
PL	Poland
PR	Puerto Rico

5.9 Wi-Fi General LAN Config

In OCS Wi-Fi Module configuration dialog, clicking on General LAN Config button will display the following window, where the user can configure the Ethernet protocols to be accessed via Wi-Fi connectivity.

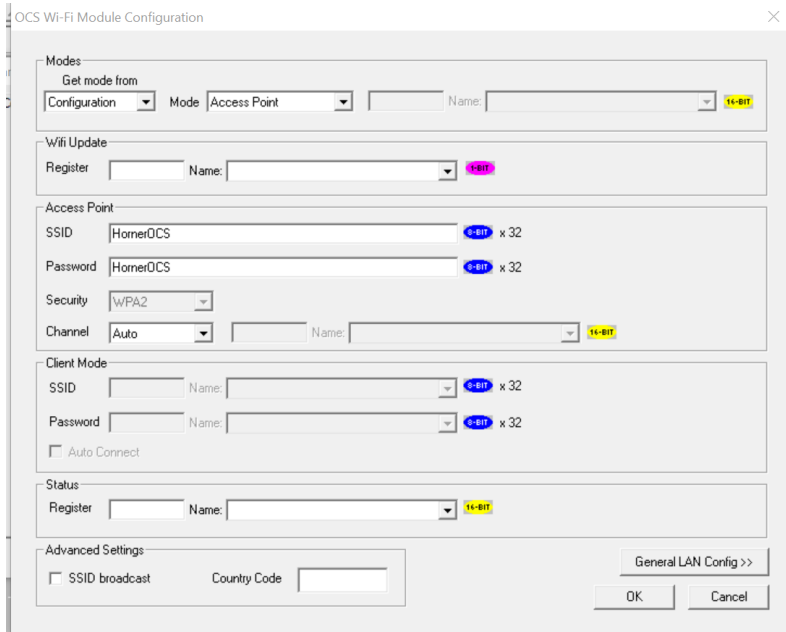

Select General LAN Config>> to open the General LAN Configuration dialog below:

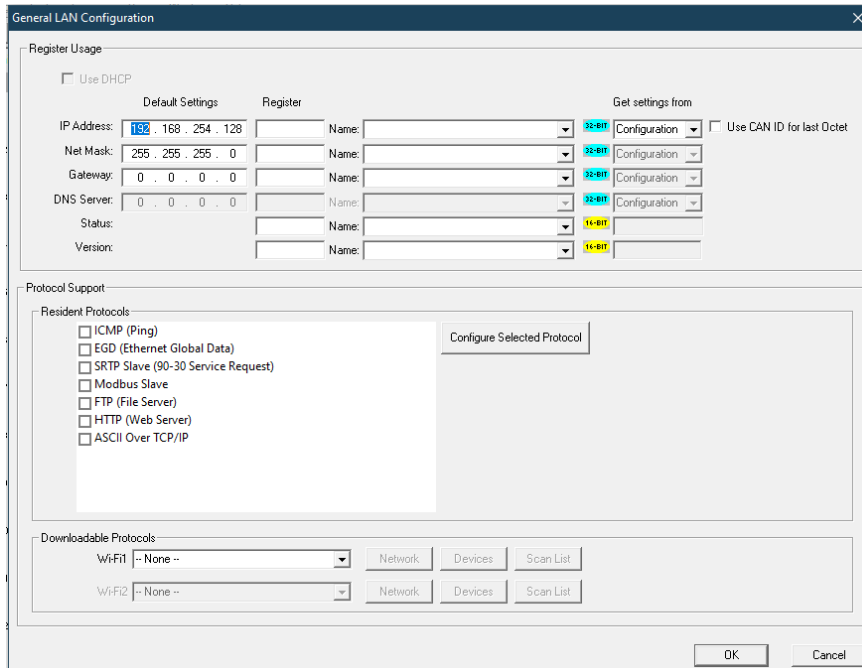

See Also: [ICMP], [EGD], [SRTP], [Modbus Slave], [FTP], [HTTP], [ASCII Over TCP/IP]

5.10 Wi-Fi Configuration through System Menu

Each OCS controller has a built-in System Menu, which allows the user to view the System Settings and make adjustments. Press the SYSTEM Key or press in the upper right corner of the screen if no buttons are visible to open the System Menu. Then use the up or down arrows to select and display the Wi-Fi Setting sub menu.

See [System Menu] for more details.

CHAPTER 6: RESIDENT PROTOCOLS (ETHERNET)

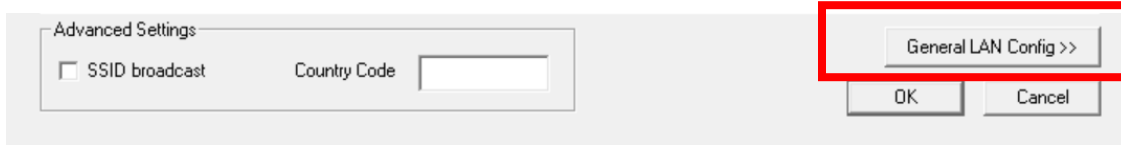

NOTE: The following configuration is required for all applications regardless of the protocols used. Additional configuration procedures must be performed for each protocol used as described in the configuration sections of the next several chapters.

Clicking on General LAN Config>> option will display the following window where the user can configure the Ethernet protocols to be accessible via Wi-Fi connectivity.

NOTE: Any 16-bit register can be used.

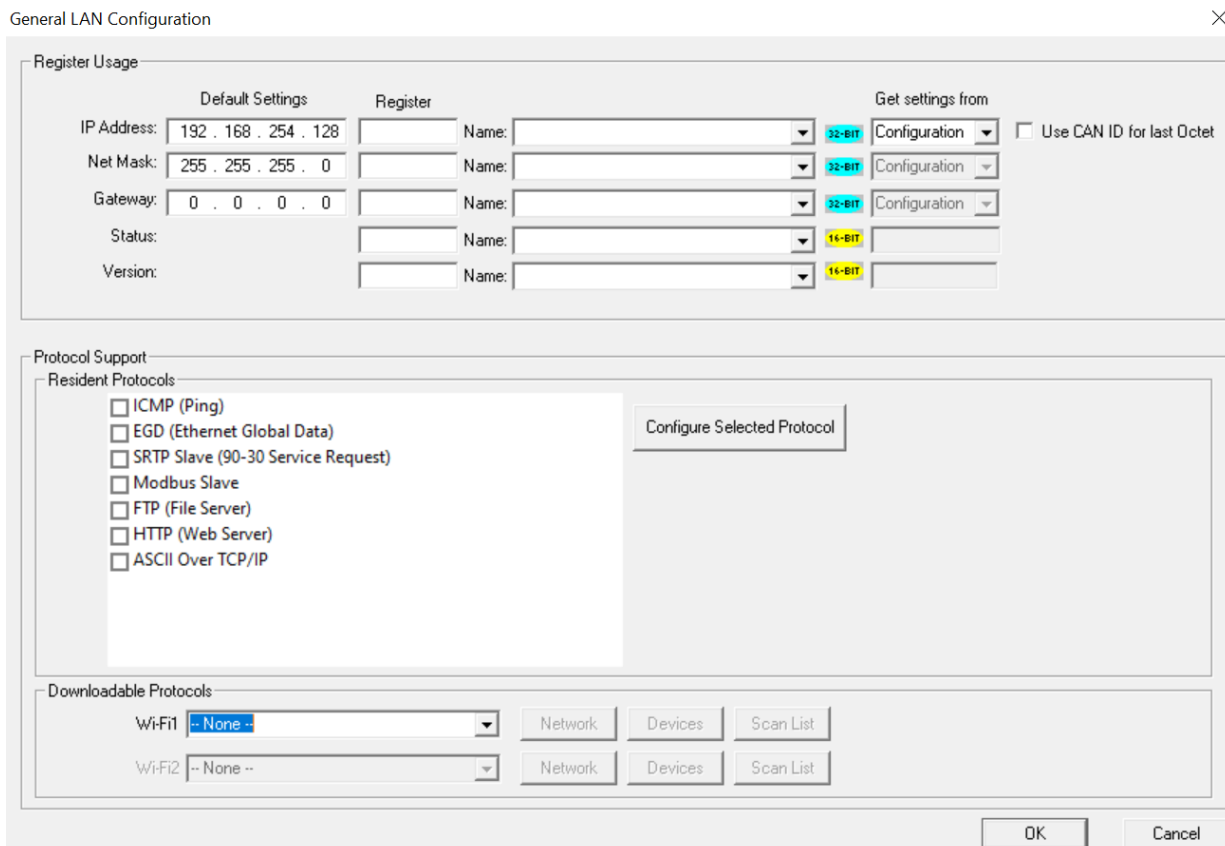

CHAPTER 7: ICMP CONFIGURATION

7.1 ICMP Overview

ICMP is used for diagnostic purposes only, to determine if another device exists on the Ethernet network.

Using ICMP, the OCS sends Ping Echo Requests to another device and expects the other device to answer with Ping Echo Responses. The OCS measures the round-trip time of each Ping Echo Request / Response exchange and puts the result (in milliseconds) into an OCS register.

In addition, when the OCS receives a Ping Echo Request from another device, it answers with a Ping Echo Response.

NOTE: Although ICMP supports other network diagnostics, the OCS only supports *Ping*.

7.2 ICMP Configuration

If ICMP protocol will be used in the application, ICMP Configuration must be performed, in addition to the general OCS Wi-Fi Configuration previously described in Chapter 5. To configure ICMP protocol, use Cscape Programming Software to perform the following five steps:

1. Open OCS Wi-Fi LAN configuration dialog by selecting **Controller → Hardware Configuration** (select a series and device type) → (OCS Wi-Fi Module) **Config → General LAN config**. Then select **ICMP (Ping) → Configure Selected Protocol**.

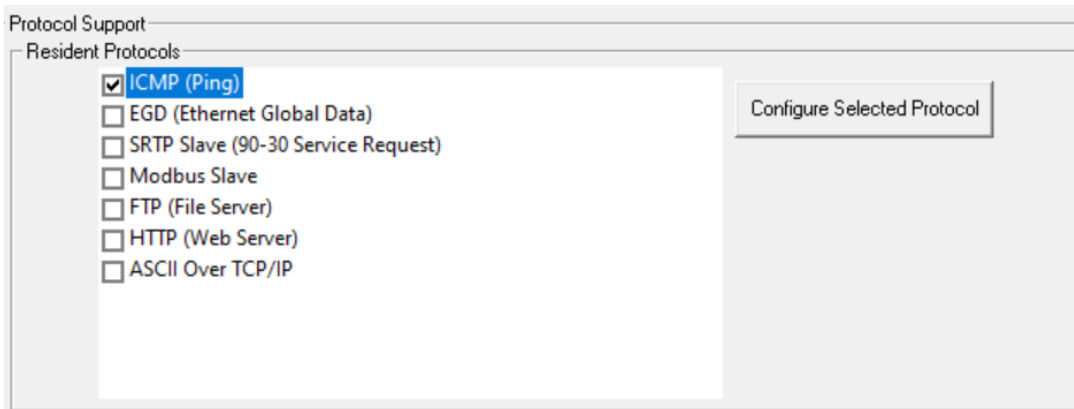

2. Enable ICMP by checking the **ICMP (Ping)** checkbox in the LAN1 Configuration dialog.
3. Click on the **Configure Selected Protocol** button next to the **ICMP (Ping)** checkbox to open the ICMP Configuration dialog. Refer to figure below.

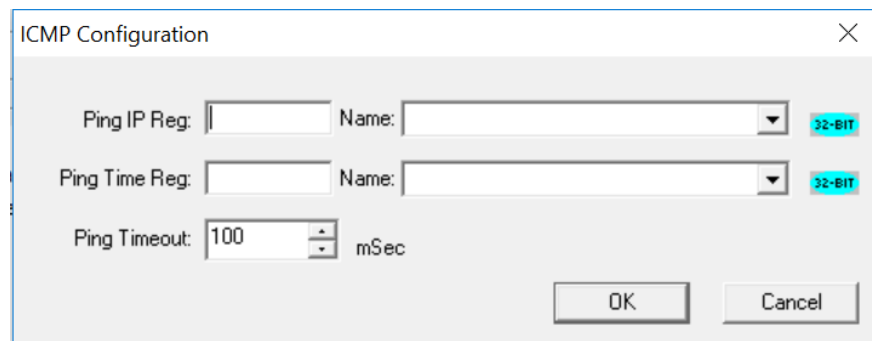

4. Set up the ICMP Configuration parameters as follows:

Table 7.1 - ICMP Configuration Parameters	
Ping IP Reg	Enter an OCS Register reference (such as %R200) to indicate which 32-bit OCS register will be read to obtain the IP Address of the network device to send Ping Echo Requests to.
Ping Time Reg	Enter an OCS Register reference (such as %R202) to indicate which 32-bit DINT OCS register will be written with the Ping Echo Request / Response round-trip time (in milliseconds). If no response is received within the Ping Timeout interval, a Ping Time of -1 is reported, indicated a timeout.
Ping Timeout	Enter a number between 100 and 100,000 for how often (in milliseconds) the OCS should send Ping Echo Requests. If the response takes longer than this amount of time, it is considered a timeout.

5. Click **OK** to accept the new ICMP Configuration.

7.3 ICMP Operation

To start Ping Echo Requests, use Ladder Code, User Screens, or Cscape Data Watch to write an IP Address to the OCS register indicated by **Ping IP Reg**. To check the resulting Ping Echo Response times, read the OCS register indicated by **Ping Time Reg**. If the round-trip time exceeds the configured **Ping Timeout** (or if there is no response at all), the reported response time will be -1.

To stop Ping Echo Requests, write 0.0.0.0 to the OCS register indicated by **Ping IP Reg**.

NOTE: ICMP protocol is active even when the OCS is not in RUN mode. Therefore, when the OCS is not in RUN mode, User Screens and Cscape Data Watch can still be used to control and monitor ICMP Pinging.

CHAPTER 8: EGD (ETHERNET GLOBAL DATA)

8.1 EGD Overview

Ethernet Global Data (EGD) protocol is a GE Fanuc Automation protocol, which is designed for simple, efficient data exchanges between peer devices on a network.

EGD protocol communicates using the UDP transport layer. Although this method of data transfer is very efficient, it has no specific way to detect and recover lost data packets. However, since all EGD data transfers are periodic, lost data packets will be repeated when their user-configured time periods expire.

CAUTION: EGD protocol is **not** intended for one-time event notification or for applications with critical data, which cannot withstand being delayed as described above.

Each device on an EGD network can be configured as a Producer, as a Consumer, or both.

A Producer is a device that transmits Exchanges (blocks of data) to one or more Consumers. A Producer can transmit Exchanges directly to a specific Consumer, by sending them to the Consumer's IP Address. (This is **Unicast** IP Addressing.) A Producer can also transmit Exchanges to a Group of Consumers, by sending them to a Group ID. (This is **Multicast** IP Addressing.) See [Section 8.12](#) for more details regarding Unicast and Multicast IP Addressing.

A Consumer is a device that receives Exchanges from one or more Producers.

An OCS supports up to 127 concurrent Exchanges, each of which can be either a Producer or a Consumer of data.

8.2 EGD Terminology

Before configuring an OCS for EGD protocol, it is essential that the application programmer understand the key EGD terms, which are shown in Table 8.1.

Table 8.1 - EGD Terminology	
Term	Definition
Exchange	A block of data sent by a Producer and received by one or more Consumers
Exchange Number	A number (1 to 16,383), which along with the IP Address of the Producer, is used to uniquely identify an Exchange on an EGD network
Producer	An EGD network device configured to transmit one or more Exchanges
Consumer	An EGD network device configured to receive one or more Exchanges
Produced Exchange	A block of data that a Producer sends to a Consumer or to a Group of Consumers
Consumed Exchange	A block of data that a Consumer or Group of Consumers receives from a Producer
Group	One or more Consumers that are configured to receive Exchanges, which have been sent by a Producer to a specific Group ID
Group ID	A number (1 to 32), which is used to identify a Group of Consumers
Production Period	A value (in milliseconds) that specifies how often a Produced Exchange is transmitted to the network
Update Timeout	A value (in milliseconds) that specifies how long a Consumer will wait to receive an Exchange, before considering it late. NOTE: In general, a Consumed Exchange's Update Timeout is normally set to at least twice the corresponding Produced Exchange's Production Period, plus 10ms.
Unicast	Peer-to-peer communication in which data is sent to a SINGLE device at a specific IP Address.
Multicast	Peer-to-peer communication in which data is sent to a GROUP IP Address, and all devices in that group will receive the data.

8.3 EGD Configuration

1. Open OCS Wi-Fi LAN configuration dialog by selecting **Controller → Hardware Configuration** (select a series and device type) → (OCS Wi-Fi Module) **Config → General LAN config**. Then select **EGD (Ethernet Global Data) → Configure Selected Protocol**.

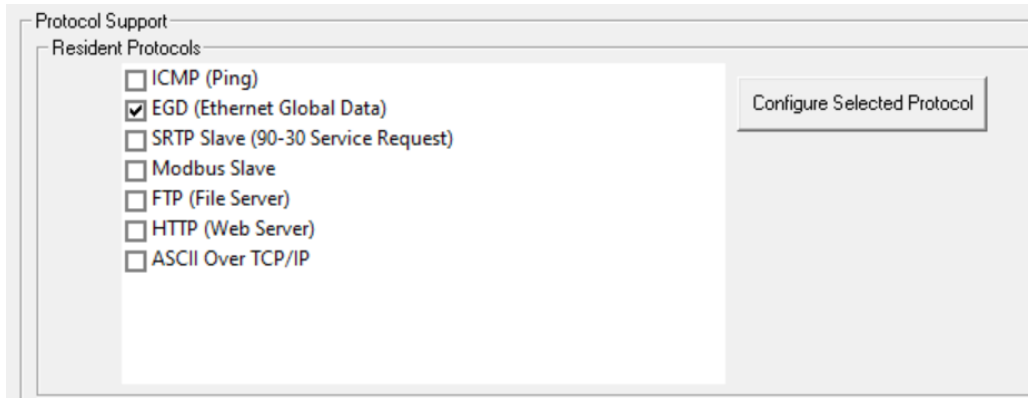

2. Click on the **Configure Selected Protocol** button after selecting **EGD (Ethernet Global Data)** to open the Ethernet Global Data dialog.

NOTE: The Ethernet Global Data dialog allows EGD Produced and Consumed Exchanges to be configured. To configure Produced Exchanges, select the Produced Exchanges tab; to configure Consumed Exchanges, select the Consumed Exchanges tab. Refer to figure below.

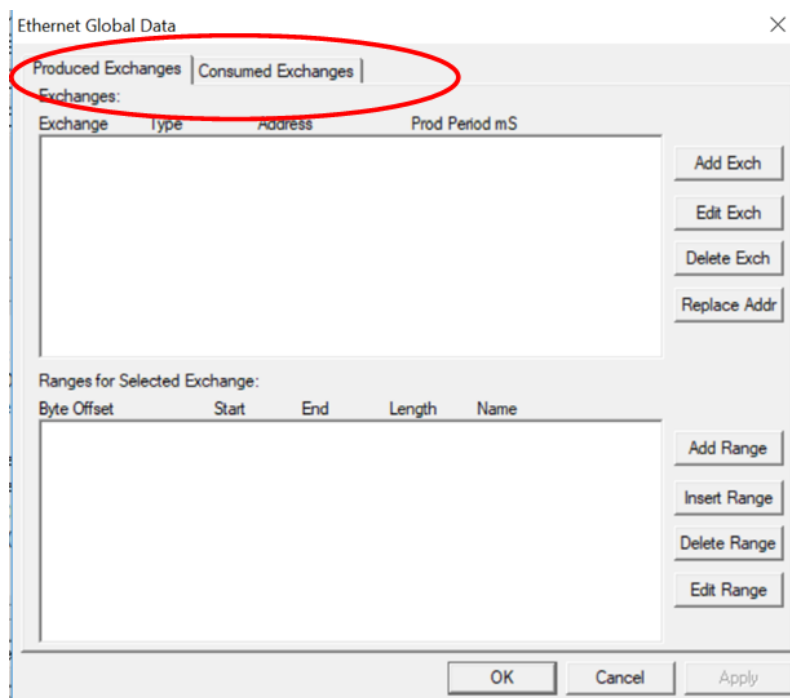

8.4 EGD Produced Exchange Configuration

Table 8.2 - Produced Exchange Unicast & Multicast	
Unicast	To configure a unicast communication, use the IP address of the other device.
Multicast	To configure a multicast communication, use a Group Number .

1. In the upper window, one or more Produced Exchanges can be created.
2. In the lower window, I/O Blocks can be defined for each Produced Exchange.

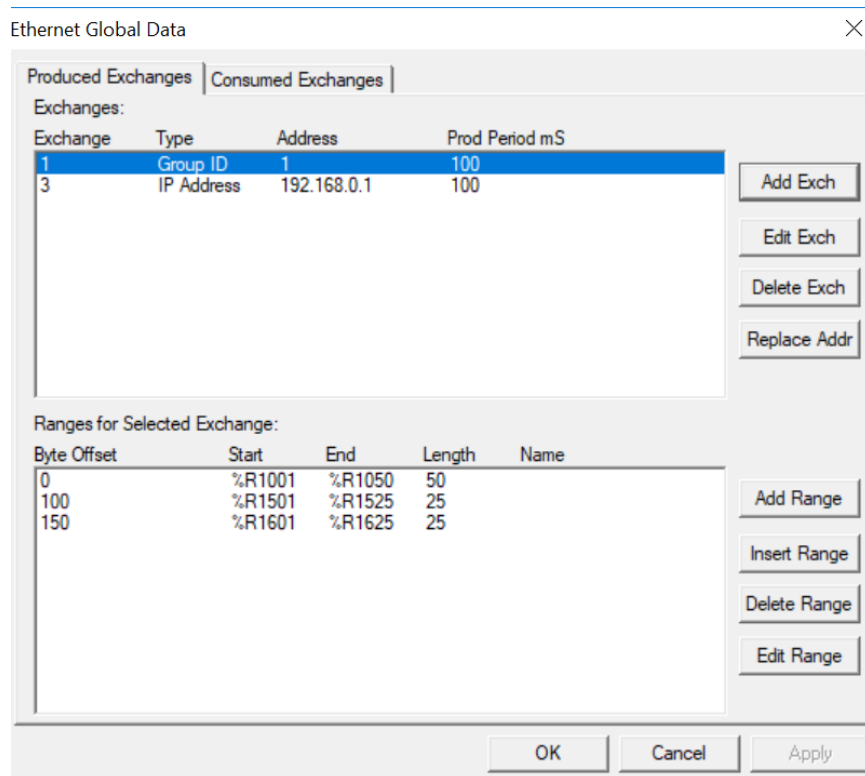

When creating a Produced Exchange, the application programmer selects an Exchange Number for it, determines whether the Exchange will be sent to a specific Consumer or to a Group of Consumers, chooses which Consumer or Group of Consumers will receive the Exchange, and sets how often the Exchange will be sent to the EGD network.

When defining I/O Blocks for a Produced Exchange, the application programmer selects what type and how much *information* will be associated with the Exchange. For Produced Exchanges, there are two types of I/O Blocks to choose from: **Data** and **Status**.

Table 8.3 - Produced Exchange I/O Block Type Definitions	
Type	Definition
Data Block	Block of consecutive OCS registers to be sent periodically to the EGD network
Status Block	16-bit OCS register to be written with the Produced Exchange's Status Word

When defining **Data Blocks** for a Produced Exchange, the maximum total OCS register data the Exchange can send to the EGD network is 1400 bytes. This means that up to a total of 700 16-bit registers (%R, %AI, AQ, etc.), or 11,200 1-bit registers (%M, %T, %I, %Q, etc.), or a combination thereof can be defined for a Produced Exchange.

NOTE: The OCS allows a total of up to 256 Data Blocks to be defined for all Produced Exchanges combined. This means that if 127 Produced Exchanges are configured, each can have an average of about 2 Data Blocks defined.

When a **Status Block** is defined for a Produced Exchange, exactly 2 bytes of register data are written with the Produced Exchange's Status Word.

NOTE: The OCS maintains just one 16-bit status word for each Produced Exchange. For this reason, there is never any need to define more than one Status Block for a given Produced Exchange.

8.5 EGD Produced Exchanges: Unicast and Multicast

To create **unicast** or **multicast** EGD Produced Exchanges, perform the following six steps:

- 1a. **To configure a UNICAST communication:** After opening the Ethernet Global Data Configuration dialog, click on the **Add Exch** button to open the Add / Edit Produced Exchange dialog (Figure 5.5). Select the destination Address and enter information.

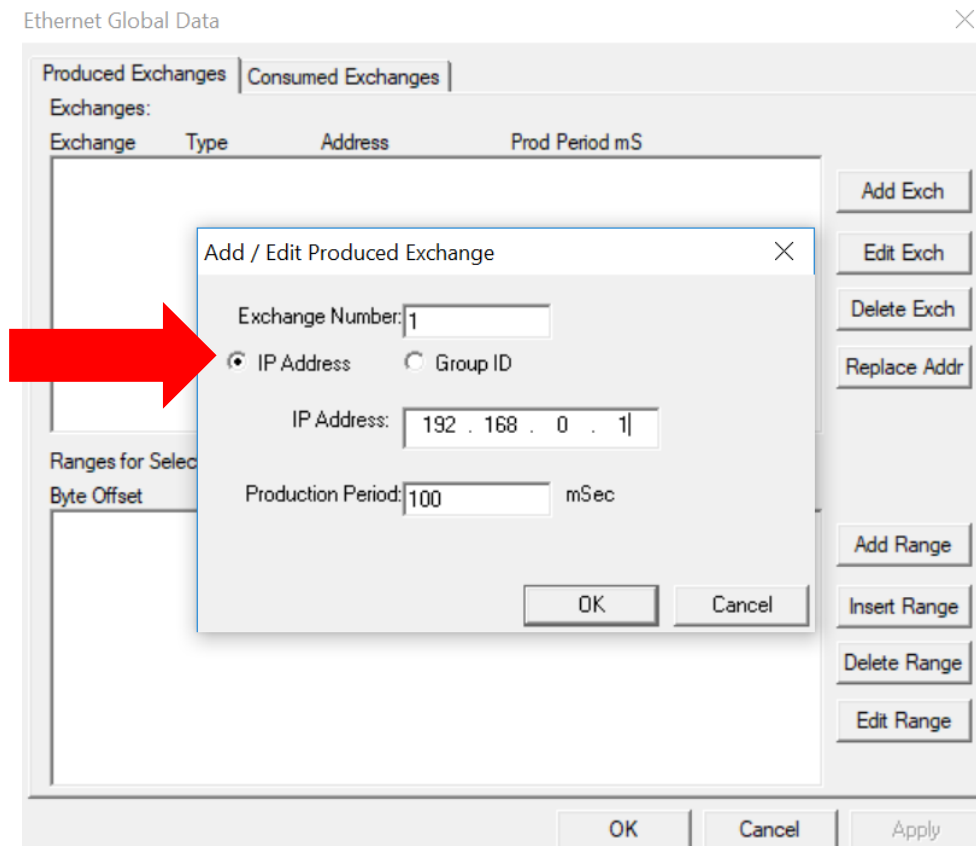

1b. To configure a **MULTICAST** communication: After opening the Ethernet Global Data Configuration dialog, click on the **Add Exch** button to open the Add / Edit Produced Exchange dialog. Select and assign Group ID.

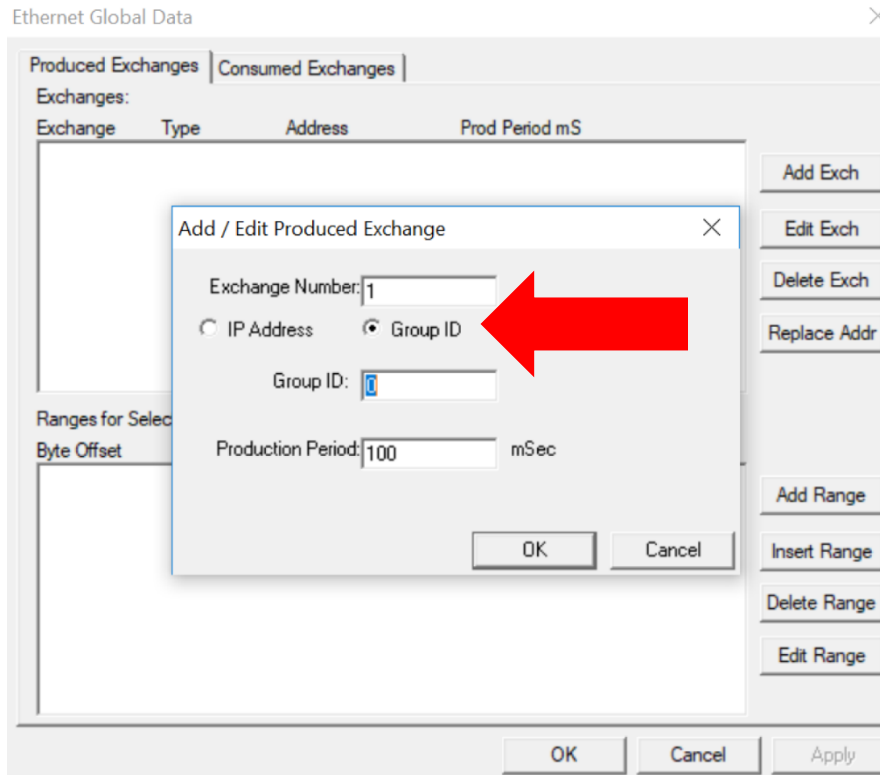

2. Configure the Produced Exchange parameters as follows:

Table 8.4 - Produced Exchange Parameters	
Exchange Number	Enter a number between 1 and 16,383, which will be used to identify the Exchange to be sent.
IP Address Radio Button	Select this option if the Exchange will be sent to a specific Consumer. This is a Unicast exchange. (This will cause the next edit box to be for entering IP Address, instead of Group ID.)
Group ID Radio Button	Select this option if the Exchange will be sent to a Group of Consumers. This is a Multicast exchange. (This will cause the next edit box to be for entering Group ID, instead of IP Address.)
IP Address Edit Box	If the IP Address radio button was selected, enter the IP Address of the specific Consumer that will receive the Produced Exchange.
Group ID Edit Box	If the Group ID radio button was selected, enter the Group ID number (1 to 32) of the Group of Consumers that will receive the Produced Exchange.
Production Period	Enter a number (in milliseconds) for how often the Produced Exchange will be sent to the EGD network.

3. Click **OK** to accept the new Produced Exchange configuration, which will be now be displayed in the upper window of the Ethernet Global Data dialog (Figure 5.2).
4. To add another Produced Exchange to the list, click on the **Add Exch** button again.
5. To edit or delete a Produced Exchange, highlight it in the upper window of the Ethernet Global Data Configuration dialog, and then click on the **Edit Exch** button or the **Delete Exch** button.
6. To quickly change the **IP Address** in multiple Produced Exchanges, click on the **Replace Addr** button. This will open a dialog to allow the user to search and replace the **IP Address** parameter, in all Produced Exchanges simultaneously.

8.6 Defining EGD Produced Exchange I/O Blocks

After creating a Produced Exchange, one or more I/O Blocks should be defined for it. An I/O Block specifies what type and how much information will be associated with the Produced Exchange.

To define I/O Blocks for a Produced Exchange, perform the following six steps:

1. In the upper window of the Ethernet Global Data dialog, highlight one of the Produced Exchanges, and then click the **Add Range** button to open the Add I/O Range to Exchange dialog.

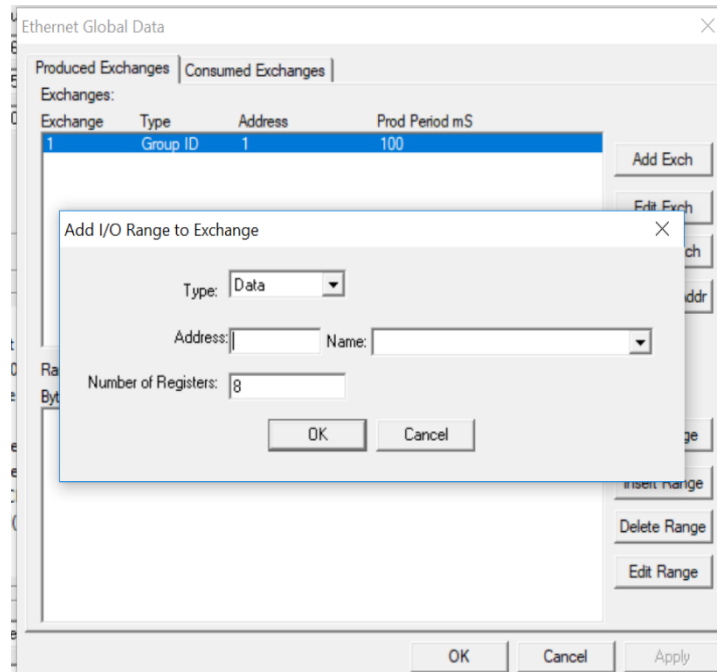

2. Configure the I/O Block parameters as follows:

Table 8.5 - I/O Block Parameters	
Type	Select Data Type to define a block of OCS registers, which the Produced Exchange will periodically read and send to the EGD network. Select Status Type to define a 16-bit OCS register, which will be written with the Produced Exchange's Status Word.
Address	Enter an OCS Register reference (such as %R1000), for the first OCS register, in a block of OCS registers, that will be periodically read and sent (Data Type), or for a 16-bit OCS register that will be written with status information (Status Type).
Number of Registers	If Data Type was selected, enter the number of registers to be periodically read and sent. If Status Type was selected, this edit box changes to Number of Bytes , and always has a fixed value of 2.

3. Click **OK** to accept the Produced Exchange's new I/O Block, which will now be displayed in the lower window of the Ethernet Global Data Configuration dialog (Figure 6.1).

NOTE: The OCS registers, specified in Data Block definitions, are sent to the EGD network in top-to-bottom order, as they appear in the lower window of the Ethernet Global Data Configuration dialog.

4. To add another I/O Block, click the **Add Range** button again and repeat steps 2 and 3. The new I/O Block will appear at the end of the list.
5. To insert an I/O Block into the middle of the list, highlight one of the I/O Block items in the list and then click on the **Insert Range** button. In this case, the new I/O Block will be inserted just before the highlighted I/O Block.
6. To edit or delete an I/O Block in the list, highlight it and then click on the **Edit Range** or **Delete Range** button.

8.7 EGD Consumed Exchange Configuration

To configure EGD Consumed Exchanges, open the Ethernet Global Data Configuration dialog, and select the **Consumed Exchanges** tab, where:

1. In the upper window, one or more Consumed Exchanges can be created.
2. In the lower window, I/O Blocks can be defined for each Consumed Exchange.

When creating a Consumed Exchange, the application programmer selects an Exchange Number for it, determines whether to receive the Exchange as a single Consumer or as a member of a Group of Consumers, chooses which Producer to receive the Exchange from, and sets how often to expect the Exchange to be received.

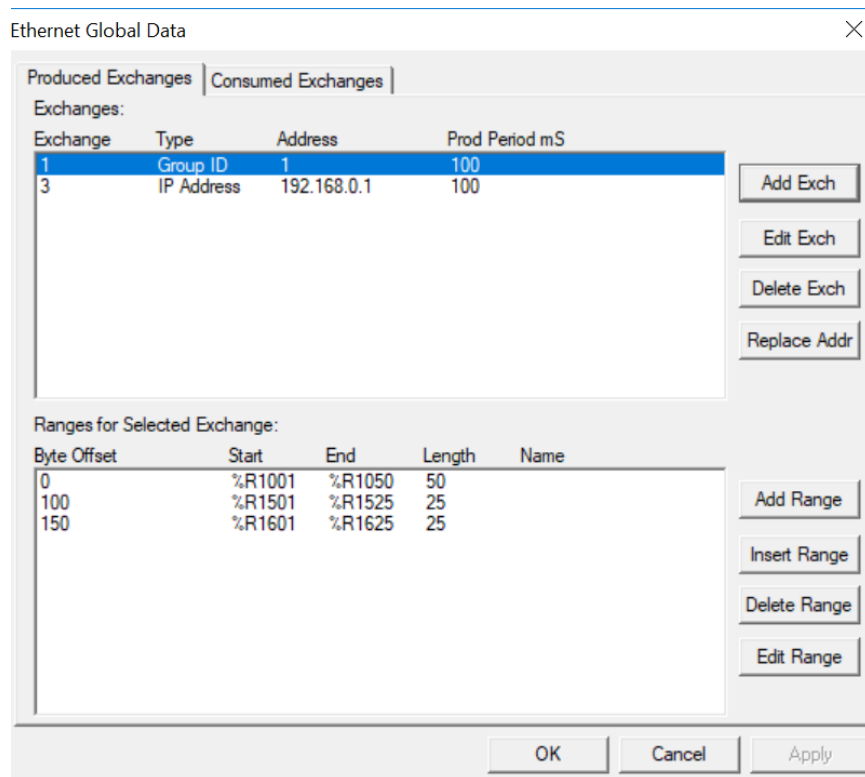

When defining I/O Blocks for a Consumed Exchange, the application programmer selects what type and how much *information* will be associated with the Exchange. For Consumed Exchanges, there are five types of I/O Blocks to choose from: Data, Status, Timestamp, OCS Timestamp, and Filler. Table 8.6 shows these I/O Block Types along with their definitions:

Table 8.6 - Consumed Exchange I/O Block Type Definitions	
Type	Definition
Data Block	<p>Block of consecutive OCS registers to be written with received data. When defining Data Blocks for a Consumed Exchange, the maximum total OCS register data the Exchange can receive from the EGD network is 1400 bytes. This means that up to a total of 700 16-bit registers (%R, %AI, AQ, etc.), or 11,200 1-bit registers (%M, %T, %I, %Q, etc.), or a combination thereof can be defined for a Consumed Exchange.</p> <p>NOTE: The OCS allows a total of up to 256 Data Blocks to be defined for all Consumed Exchanges combined. This means that if 127 Consumed Exchanges are configured, each can have an average of about 2 Data Blocks defined.</p>
Status Block	<p>16-bit OCS register to be written with the Consumed Exchange's status word. When a Status Block is defined for a Consumed Exchange, exactly 2 bytes of register data are written with the Consumed Exchange's Status Word.</p>
Timestamp Block	<p>Exactly 8 bytes of register data will be written with two 32-bit binary timestamp values, containing the numbers of seconds and nanoseconds since January 1, 1970.</p> <p>NOTE: The binary Timestamp Block is rarely used, and there is <u>never</u> any need to define more than one Status Block or OCS Timestamp Block for a given Consumed Exchange.</p>
OCS Timestamp Block	<p>Exactly 14 bytes of register data will be written with a 7-word OCS-format timestamp, consisting of second, minute, hour, day, month, year, and millisecond words. This OCS Timestamp can be displayed on the OCS screen, can be loaded into the OCS time-of-day clock, and can be more easily processed by ladder logic.</p>
Filler Block	<p>Specifies a block of received data to ignore (skips unwanted data).</p>

8.8 Creating EGD Consumed Exchanges

To create EGD Consumed Exchanges, perform the following six steps:

1. In the Ethernet Global Data Configuration dialog, click on the **Add Exch** button to open the Add / Edit Consumed Exchange dialog. Refer to image below.

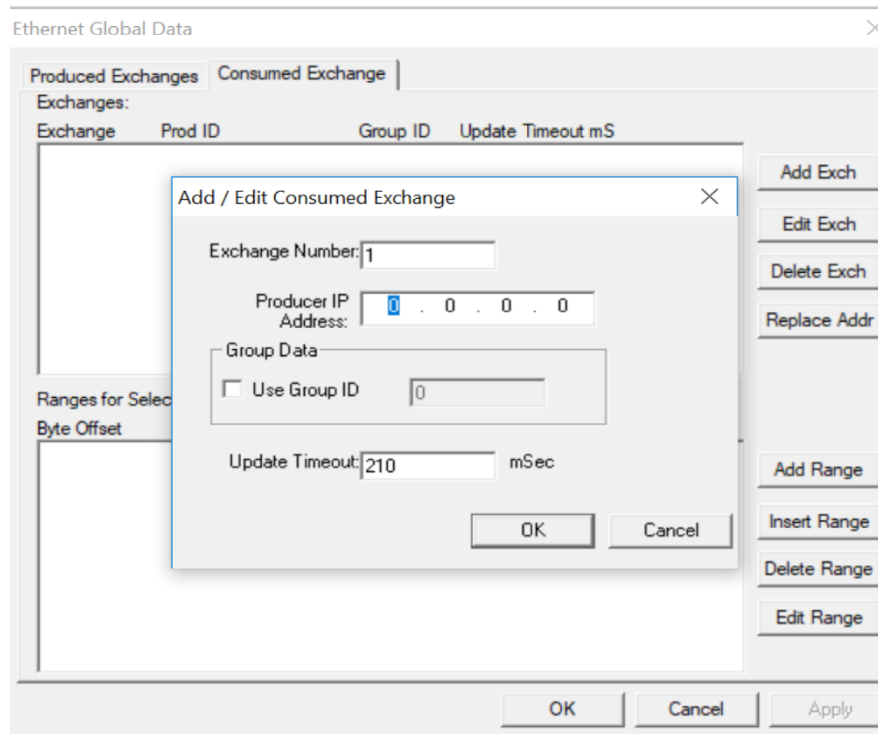

2. Configure the Consumed Exchange parameters as follows:

Table 8.7 - Consumed Exchange Parameters	
Exchange Number	Enter a number between 1 and 16,383, which will be used to identify the Exchange to be received.
Producer IP Address:	Enter the IP Address of the Producer to receive the Exchange from.
Use Group ID	Check this box to receive an Exchange sent by a Producer to a Group ID.
Group ID	If the Use Group ID box is checked, enter a number from 1 to 32 in the edit box, to identify which of the 32 possible Groups of Consumers to become a member of.
Update Timeout	Enter a number (in milliseconds) for how long to wait to receive the Exchange, before considering it to be late. Typically, this should be set to twice the corresponding Production Timeout, plus 10 milliseconds.

3. Click **OK** to accept the new Consumed Exchange configuration, which will be now be displayed in the upper window of the Ethernet Global Data Configuration dialog.
4. To add another Consumed Exchange to the list, click on the **Add Exch** button again.
5. To edit or delete a Consumed Exchange, highlight it in the upper window of the Ethernet Global Data Configuration dialog, and then click on the **Edit Exch** or **Delete Exch** button.
6. To quickly change the **Producer IP Address** in multiple Consumed Exchanges, click on the **Replace Addr** button. This will open a dialog to allow the user to search and replace the **Producer IP Address** parameter, in all Consumed Exchanges simultaneously.

8.9 Defining EGD Consumed Exchange I/O Blocks

After creating a Consumed Exchange, one or more I/O Blocks should be defined for it. An I/O Block specifies what type and how much information will be associated with the Consumed Exchange.

To define I/O Blocks for a Consumed Exchange, perform the following six steps:

1. In the upper window of the Ethernet Global Data Configuration dialog, highlight one of the Consumed Exchanges, and then click the **Add Range** button to open the **Add I/O Range to Exchange** dialog.

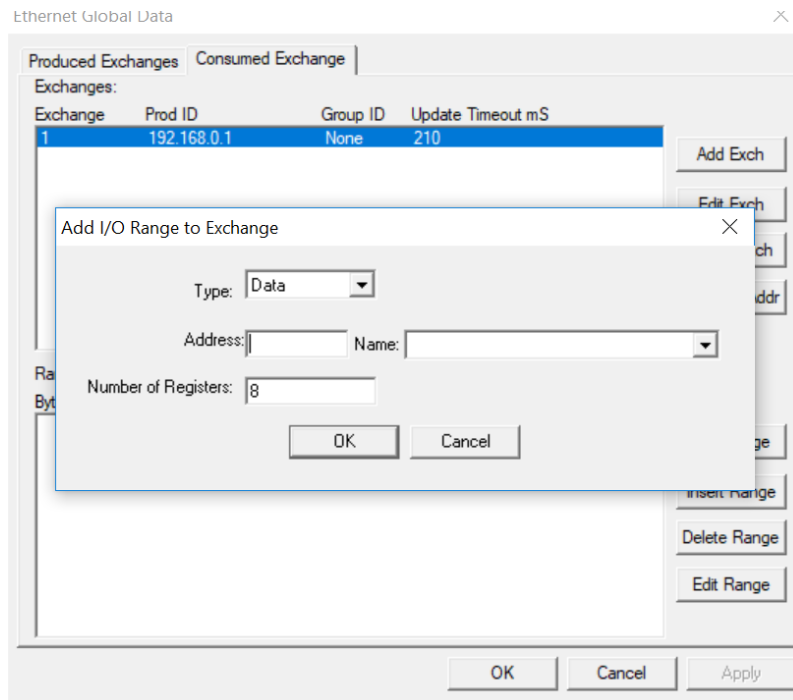

- Configure the I/O Block parameters as follows:

Table 8.8- I/O Block Parameters	
Type	Select Data Type to define a block of OCS registers, which the Consumed Exchange will write with received data. Select Status Type to define a 16-bit OCS register, which will be written with the Consumed Exchange's Status Word. Select OCS Timestamp Type to define a 14-byte OCS register block to write with the received data's OCS-format timestamp. Select Filler Type, to skip unwanted received data.
Address	Enter an OCS Register reference (such as %R2000), for the first OCS register, in a block of OCS registers, that will be written with received data (Data Type), or for a 16-bit OCS register that will be written with status information (Status Type), or for the first OCS register in a block of OCS registers that will be written with the 14-byte timestamp (OCS Timestamp Type). For Filler Type, the Address edit box is not used.
Number of Registers	If Data Type was selected, enter the number of registers to be written with received data. Otherwise, this edit box changes to Number of Bytes , and has a fixed value of 2 for Status Type or 14 for OCS Timestamp Type. For Filler Type, enter the number of unwanted received data bytes to skip.

- Click **OK** to accept the Consumed Exchange's new I/O Block, which will now be displayed in the lower window of the Ethernet Global Data dialog.

NOTE: The OCS registers, specified in Data Block definitions, are filled with received data in top-to-bottom order, as they appear in the lower window of the Ethernet Global Data dialog. In this respect, Filler Blocks are placeholders for Data Blocks and can be thought of as Data Blocks whose received data bytes are discarded.

- To add another I/O Block, click on the **Add Range** button again and repeat steps 2 and 3. The new I/O Block will appear at the end of the list.
- To insert an I/O Block into the middle of the list, highlight one of the I/O Block items in the list and then click on the **Insert Range** button. In this case, the new I/O Block will be inserted just before the highlighted I/O Block.
- To edit or delete an I/O Block in the list, highlight it and then click on the **Edit Range** or **Delete Range** button.

8.10 Adding an OCS Timestamp Block Configuration

In EGD protocol, a timestamp is sent with every Produced Exchange, indicating when the Producer sampled the data being sent. For a Consumer of the Exchange to get this information into an OCS register, define an OCS Timestamp Block for the Consumed Exchange. Perform the following 2 steps:

1. In the EGD Configuration dialog, select the **Consumed Exchanges** tab.

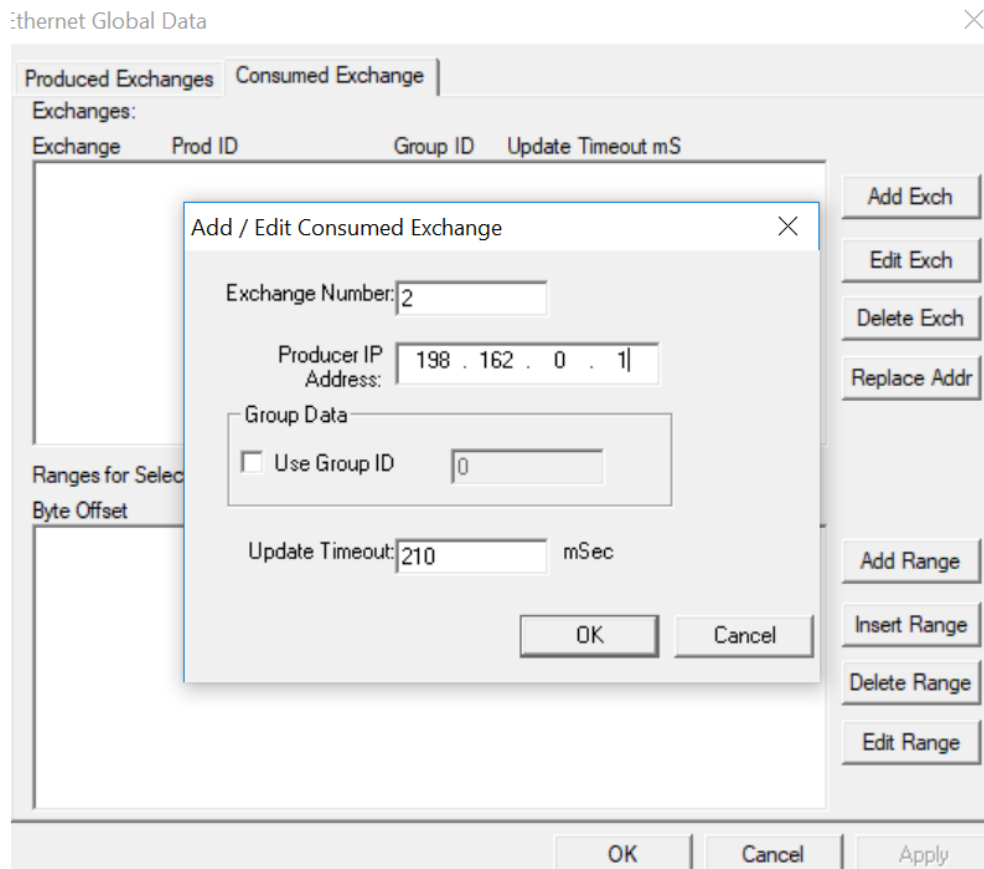

2. Make sure an exchange is highlighted in the upper and click on the **Add Range** button, to define an OCS Timestamp Block for Consumed Exchange. Then fill in the parameters, as shown in below, and click **OK**.

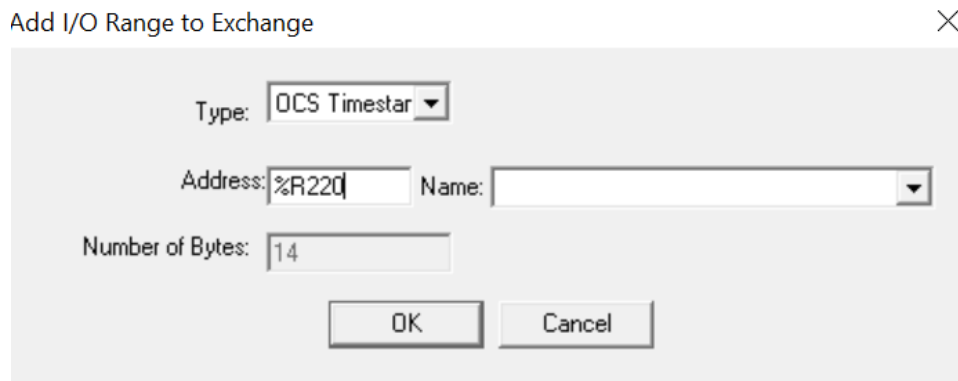
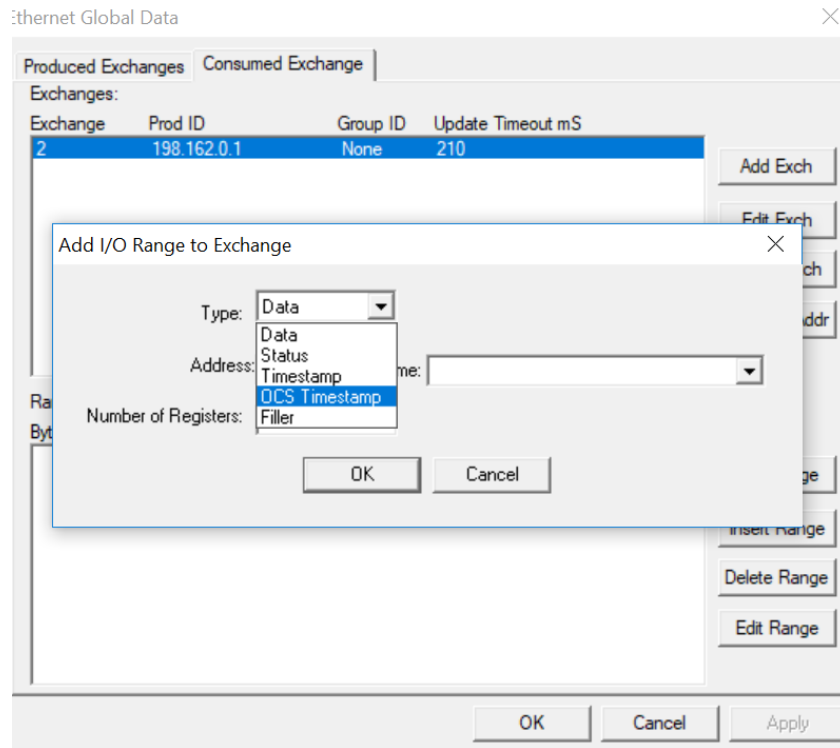

Ethernet Global Data ×

Produced Exchanges | Consumed Exchange

Exchanges:

Exchange	Prod ID	Group ID	Update Timeout mS
2	198.162.0.1	None	210

Ranges for Selected Exchange:

Byte Offset	Start	End	Length	Name
O Time	%R220	%R226	7	

8.11 Filler Block Configuration

Sometimes a Consumer does not need all of the data sent by a Producer in an Exchange. In this case, the Consumed Exchange's Data Block should be defined to receive fewer registers than will be sent by the Producer of the Exchange.

However, if the partial data needed by the Consumer is not at the **beginning** of the data received in an Exchange, there must be some way to skip (ignore) the extra data. For this reason, the Ethernet Module supports Filler Blocks for Consumed Exchanges.

A **Filler Block** is used to skip unwanted data sent by the Producer. For example, if the Producer sends 40 data bytes in an Exchange, and the Consumer only needs the first and last 10 bytes, a Filler Block would be defined, in the appropriate slot in the list, to skip the middle 20 bytes of data.

Filler Produced Exchange Example: Controller A (IP 192.168.0.1)

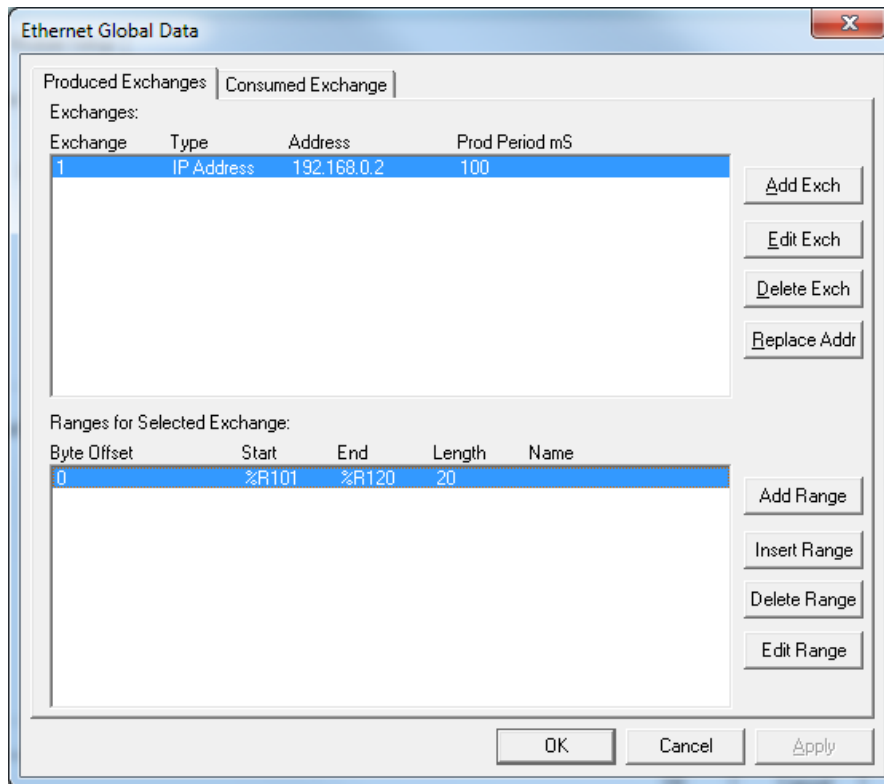

Filler Consumed Exchange Example: Controller B (IP 192.168.0.2)

NOTE: The filler is used to skip the middle 20 bytes of Exchange 1.

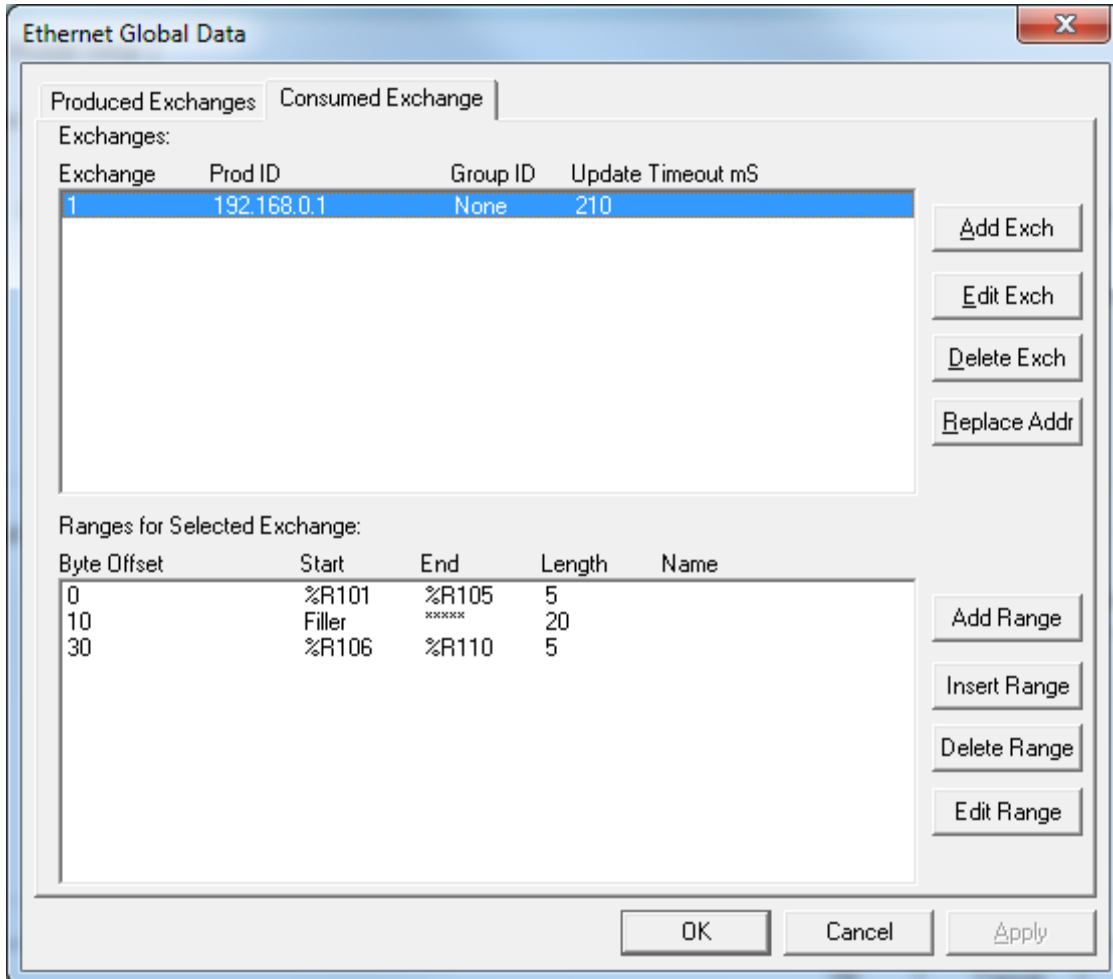

8.12 EGD Unicast and Multicast

When using Ethernet Global Data (EGD) protocol for peer-to-peer communication, there are two methods for sending data: (1) send to a single device or (2) send to a group of devices.

Unicast

When sending to a single device (method 1), EGD protocol uses **Unicast IP Addressing**. This means that the IP header's 32-bit Destination IP Address will contain the intended recipient's unique IP Address.

Multicast

When sending to a group of devices (method 2), EGD protocol uses **Multicast IP Addressing**.

This means that the IP header's 32-bit Destination IP Address will contain one of the 32 Multicast IP Addresses shown in Table 8.9.

Group ID	Multicast IP Address
1	224.0.7.1
2	224.0.7.2
⋮	⋮
32	224.0.7.32

Ethernet Switches normally do not support Multicast IP Addressing, while Ethernet Hubs do support Multicast IP Addressing. Some Ethernet Routers, known as Multicast Routers, do support Multicast IP Addressing, by using Internet Group Management Protocol (IGMP).

NOTE: For those customers wanting to use Multicast Routers to connect EGD devices, the OCS automatically handles IGMP communication with Multicast Routers.

8.13 EGD Status Words

EGD Status Words allow an Ethernet Global Data user to obtain the operating status of each EGD Exchange. The set of EGD Status Word values, implemented in the OCS, is a subset of the ones used in GE Fanuc EGD devices. This is because the OCS does not support dynamically defined (at run time) EGD Exchanges.

NOTE: Both Produced and Consumed Exchange Status Words are written to local OCS registers. This is the only case where a Produced Exchange can be configured to write to a local register.

The Status Word for a Produced Exchange is updated each time the Exchange’s Production Period expires. The Status Word for a Consumed Exchange is updated when new data arrives for consumption or when the Exchange’s Update Timeout expires.

In normal operation, each EGD Exchange’s Status Word will always be 1 (OK), implying that new data was successfully Produced or Consumed. If the application needs to be notified when a data transfer has occurred on a given Exchange, the ladder program should clear the Exchange’s Status Word register to 0 (IDLE) each time a non-zero event is detected.

8.14 EGD Produced Exchange Status Words

The Status Word for an EGD Produced Exchange can take on the following values:

Table 8.10 - Status Word for EGD Produced Exchange		
0	IDLE	No new status event has occurred. The OCS initializes all Status Words to 0, <u>only</u> at power-up and each time the OCS enters RUN mode. Subsequently, the OCS application ladder program can write the value 0 to the Status Word, as an aid in knowing when Ethernet Global Data production occurs (see Status Word 1).
1	OK	Data Produced. New EGD network data has been transmitted. A transition to 1 indicates <u>production of data occurred since the last OCS ladder scan.</u>
2	NO LINK	The Ethernet link was down when EGD data production was attempted. This will occur, for example, if the Ethernet cable is unplugged from the OCS.

8.15 EGD Consumed Exchange Status Words

The Status Word for an EGD Consumed Exchange can take on the following values:

Table 8.11 - Status Word for EGD Consumed Exchange		
0	IDLE	No new status event has occurred. The OCS initializes all Status Words to 0, <u>only</u> at power-up and each time the OCS enters RUN mode. Subsequently, the OCS application ladder program can write the value 0 to the Status Word, as an aid in knowing when Ethernet Global Data consumption occurs (see Status Words 1 and 7).
1	OK	Data Consumed. New EGD network data has been received as expected (before the configured Update Timeout expired). A transition to 1 (or to 7) indicates consumption of data occurred since the last OCS ladder scan.
2	NO LINK	The Ethernet link was down when EGD data consumption was expected. This will occur, for example, if the Ethernet cable is unplugged from the OCS.
3	No SYNC	SNTP Error - <i>The Ethernet Interface in the device producing the exchange is configured for network time synchronization (Network Time Sync parameter is set to SNTP) but is not synchronized to an SNTP server. Therefore, the timestamp associated with this data is not synchronized to the network.</i> NOTE: <i>This error condition is considered the least important of all the error codes in this section. If another error condition exists, its status code will appear in the Status Word.</i>
6	OVERDUE	Data Refresh Error - The Update Timeout has expired without receiving the expected data. Some possible causes for this error are: (1) the Producer has stopped producing the data, (2) the Consumed Exchange's configured Producer IP Address and/or Group ID do not exactly match those of the corresponding Produced Exchange, (3) or the Consumed Exchange's configured Update Timeout is too short (it should normally be twice the producer's Production Period, plus 10ms).
7	TARDY	Data Consumed Late - New EGD network data has been received, but it is later than expected (after the configured Update Timeout expired). A transition to 7 (or to 1) indicates consumption of data occurred since the last OCS ladder scan. The most probable cause for this error is that the Consumed Exchange's configured Update Timeout is too short (it should normally be twice the producer's Production Period, plus 10ms).

8.16 EGD Example 1: UNICAST EXCHANGE

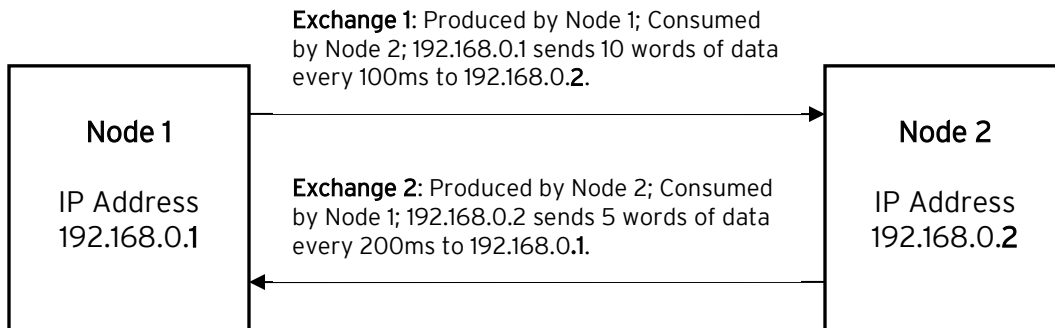

EGD Example 1: Configuration of Node 1

To configure Node 1 for EGD Example 1, as shown above, perform the following six steps:

1. To configure EGD Exchanges, open the Ethernet Global Data Configuration dialog.

In this example Node 1 will have a Static IP address, and the %R1, %R2, and %R3 registers will be used to report the Ethernet Module's status, firmware version, and IP address.

NOTE: Since an IP Address is 32-bits long, Node 1's IP Address (192.168.0.1) will actually be written into %R3 and %R4.

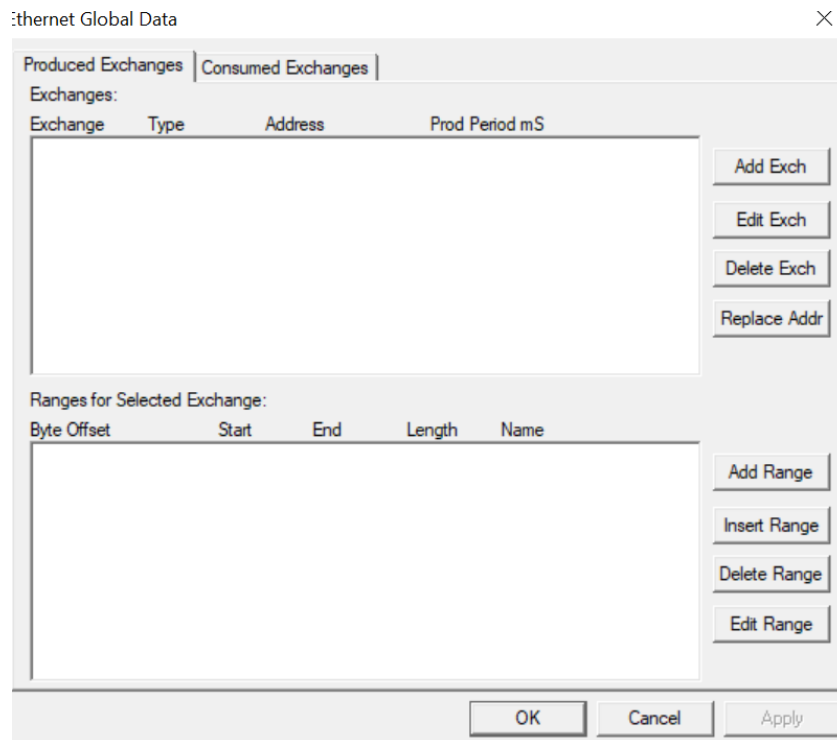

2. Click on **LAN1** next to the EGD (Ethernet Global Data) checkbox to open the Ethernet Global Data dialog. Click on **Add Exch** in the Produced Exchanges dialog.

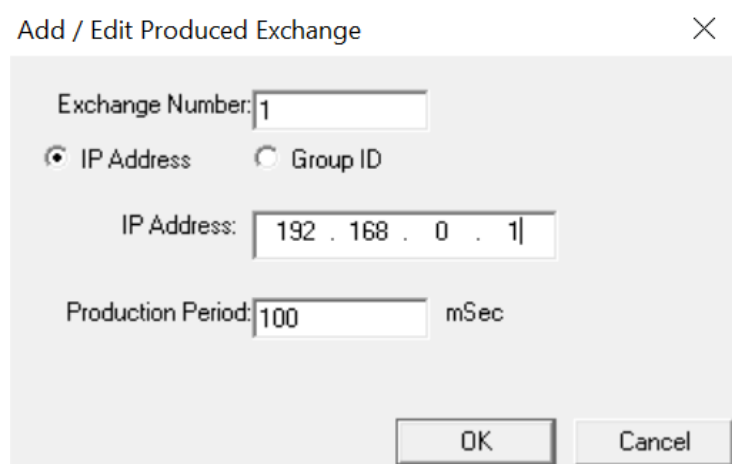

The dialog box 'Add / Edit Produced Exchange' contains the following fields and controls:

- Exchange Number:
- Radio buttons: IP Address, Group ID
- IP Address:
- Production Period: mSec
- Buttons: OK, Cancel

3. Click on Add Range button, in the EGD Configuration dialog, to define a Data Block for Produced Exchange 1. Then fill in the parameters as shown below. Then click **OK**.

In this example, Node 1 will use Exchange 1 to transmit 10 words of data taken from %R100 through %R109.

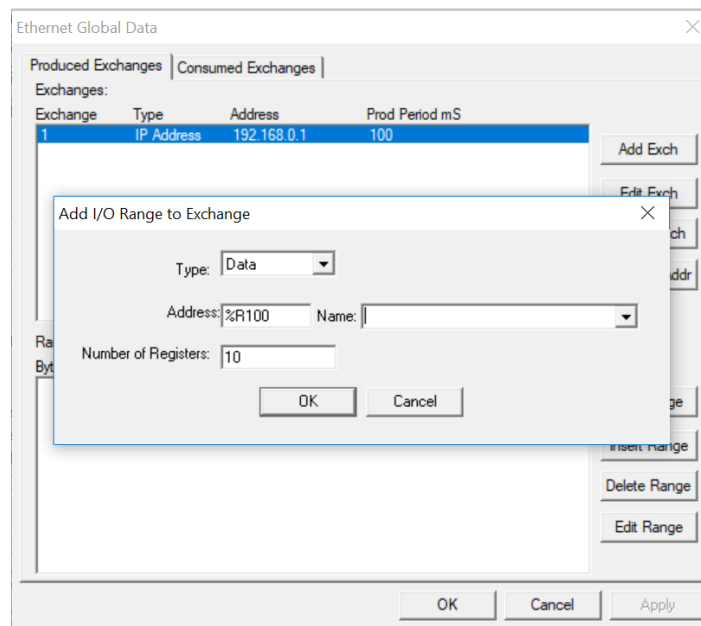

The 'Ethernet Global Data' dialog box shows a table of 'Produced Exchanges' with one entry selected:

Exchange	Type	Address	Prod Period mS
1	IP Address	192.168.0.1	100

Overlaid on this is the 'Add I/O Range to Exchange' sub-dialog with the following fields:

- Type:
- Address: Name:
- Number of Registers:
- Buttons: OK, Cancel

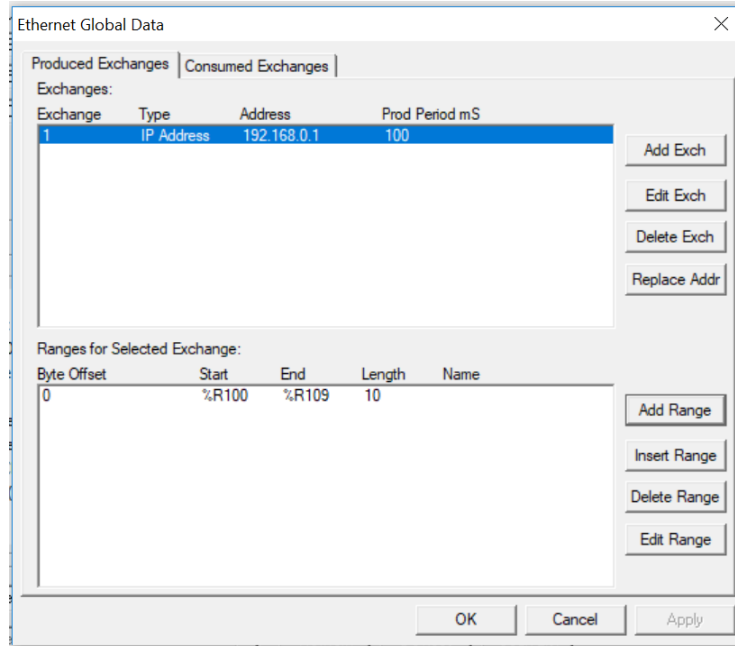

4. To configure Exchange 2 as Consumed Exchange for Node 1, select the Consumed Exchanges tab in the Ethernet Global Data dialog. Click on the **Add Exch** button to create a Consumed Exchange. Then fill in the parameters as shown.

NOTE: This is a **unicast**. Node 1 will be the only Consumer to receive Exchange 2 from Node 2 and will NOT be a member of a Group of Consumers. Also, the Update Timeout is set to 410ms, which means Node 1 will expect to receive Exchange 2 from Node 2 at least every 410ms. [This is twice the time, plus 10ms.]

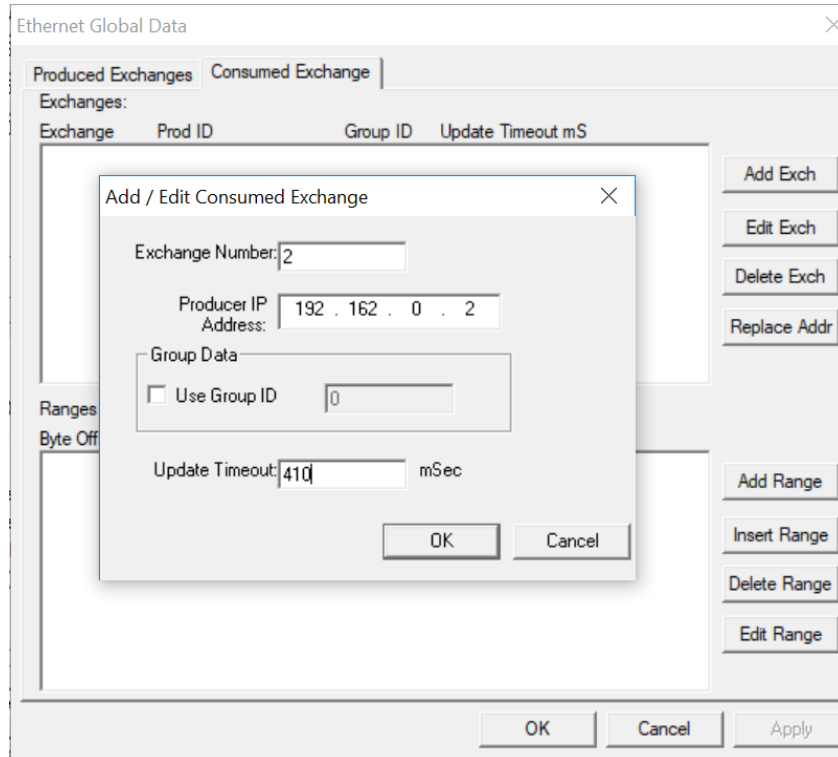

- Click on the **Add Range** button in the EGD Configuration dialog to define a Data Block for Consumed Exchange 2. Then fill in the parameters as shown below and click **OK**.

In this example, Node 1 will use Exchange 2 to receive 5 data words in %R200 through %R204.

At this point, the Consumed Exchanges tab in the EGD Configuration dialog should be as shown

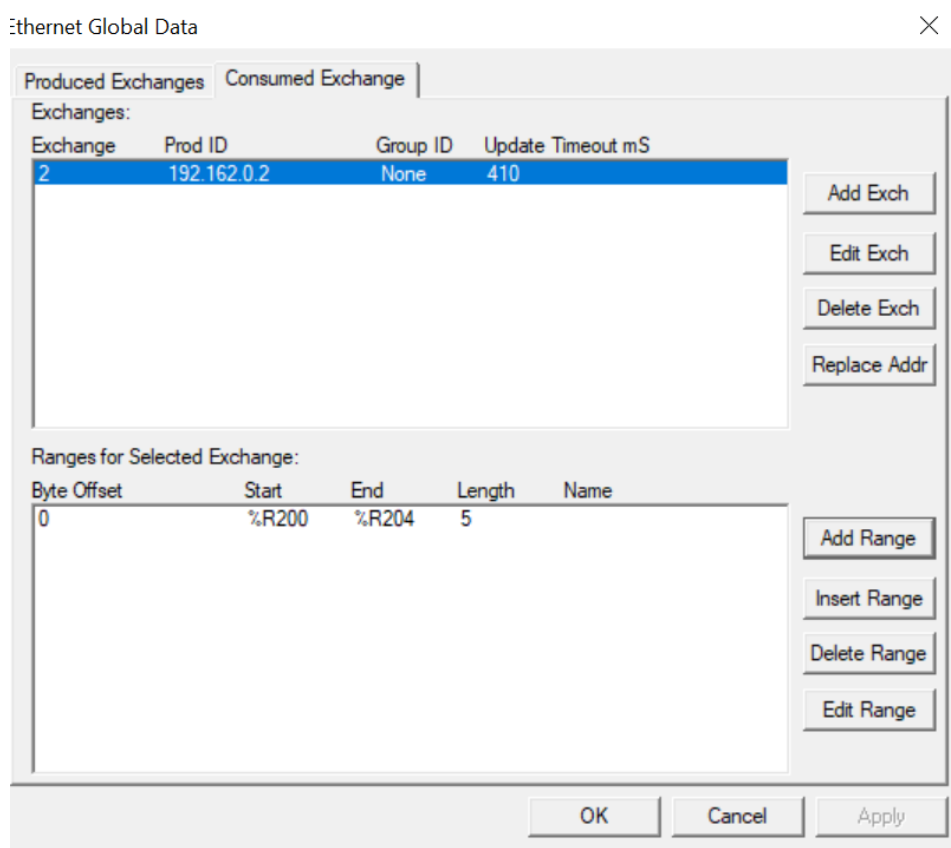

- Node 1 configuration is now complete. Click **OK**, save the program using an appropriate filename, such as **EGD Node 1.csp**, and then continue with, Node 2 Configuration.

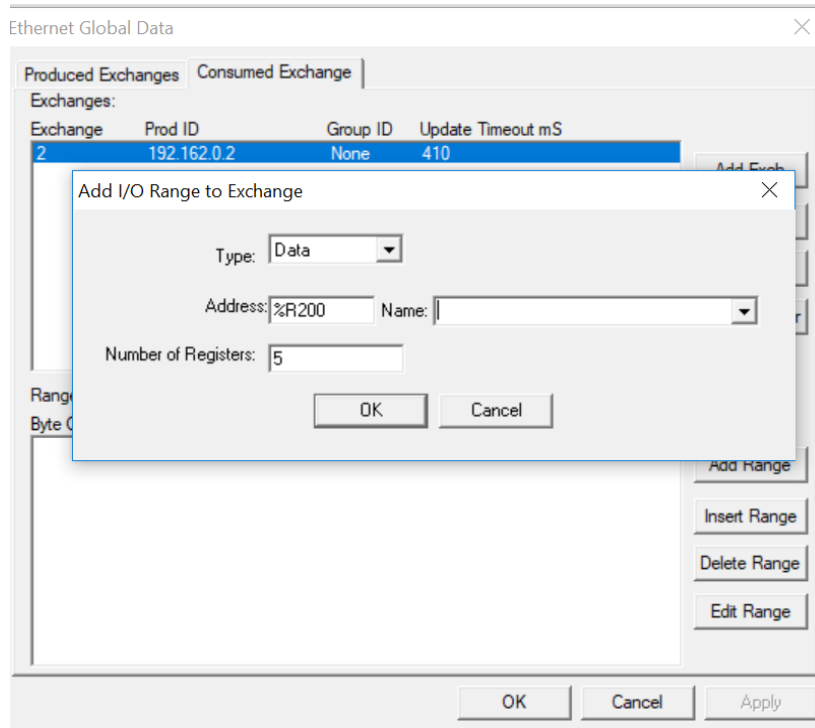

EGD Example 1 - Configuration of Node 2

To configure Node 2 for EGD Example 1, perform the following steps:

1. On the main Cscape screen, select **New** on the **File** menu to start a new user program. To configure EGD Exchanges, open the Ethernet Global Data Configuration dialog.

In this example, Node 2 will have a Static IP Address, and the %R1, %R2, and %R3 registers will be used to report the Ethernet Module's status, firmware version, and IP Address.

NOTE: Since an IP address is 32-bits long, Node 2's IP Address (192.168.0.2) will actually be written into %R3 and %R4.

Node 2 will transmit Exchange 2 to a specific Consumer (Node 1) because this is a unicast communication, instead of to a group of Consumer (multicast).

The Production Period is set to 200, which will cause Node 2 to transmit Exchange 2 every 200ms.

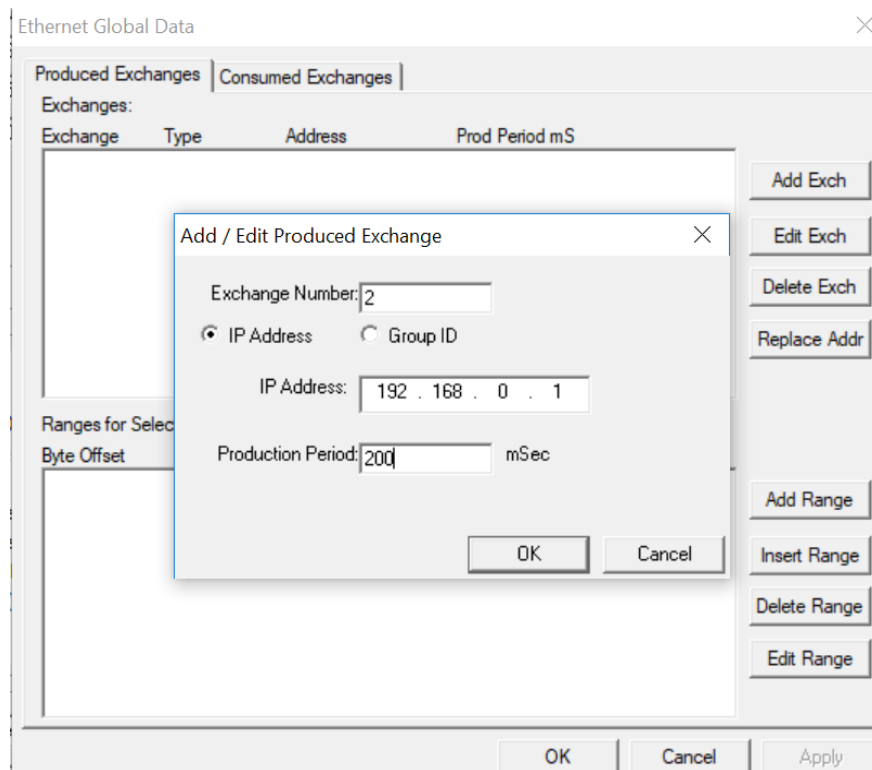

3. Click on the **Add Range** button in the EGD Configuration dialog to define a Data Block for Produced Exchange 2. Then fill in the parameters as shown below and click **OK**.

In this example, Node 2 will use Exchange 2 to transmit 5 words of data taken from %R100 through %R104.

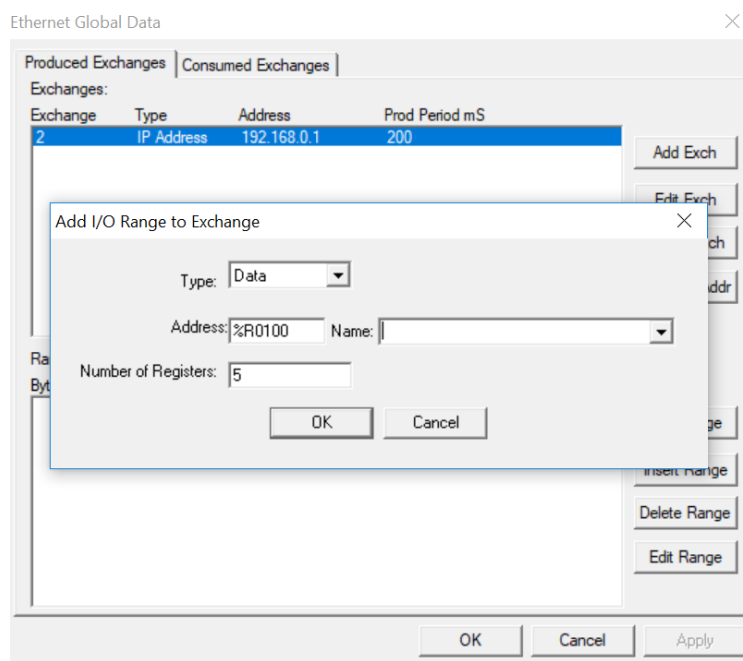

At this point, the Produced Exchanges tab in the EGD Configuration dialog should be as shown in the figure below.

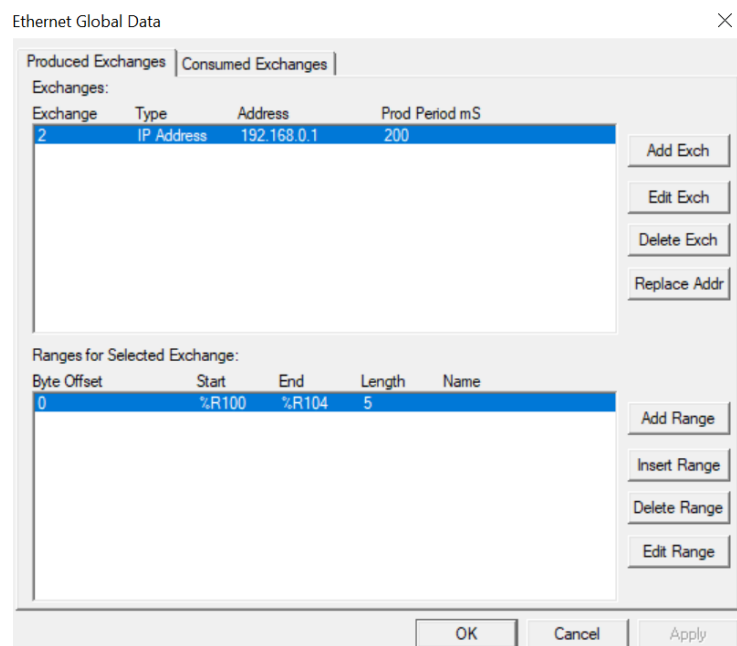

4. Now that Exchange 2 has been configured as a Produced Exchange for Node 2, it is time to configure Exchange 1 as a **Consumed Exchange** for Node 2. To do this, first select the Consumed Exchanges tab and click on the **Add Exch** button to create a Consumed Exchange.

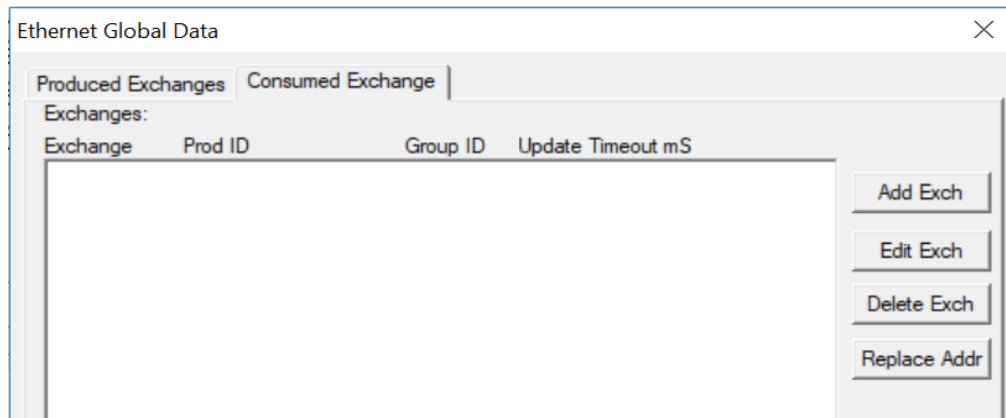

Then fill in the parameters, as shown below and click OK.

In this example, Node 2 will be the ONLY consumer to receive Exchange 1 from Node 1 and will NOT be a member of a Group of Consumers. Also, the Update Timeout is set to 210, which means that Node 2 will expect to receive Exchange 1 from Node 1 at least every 210ms.

NOTE: This is twice the time, plus 10ms that Node 1 was configured to transmit Exchange 1.

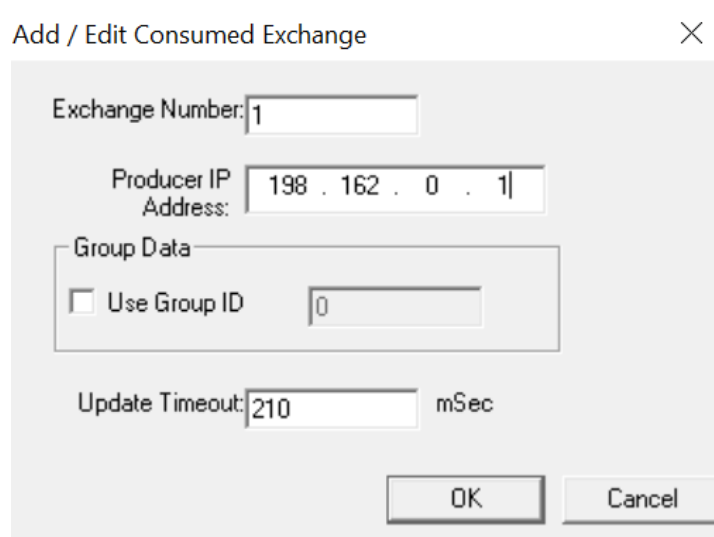

5. Click on the **Add Range** button, in the EGD Configuration dialog to define a Data Block for Consumed Exchange 1. Then fill in the parameters as shown below and click **OK**.

In this example, Node 2 will use Exchange 1 to receive 10 data words from %R200 through %R209.

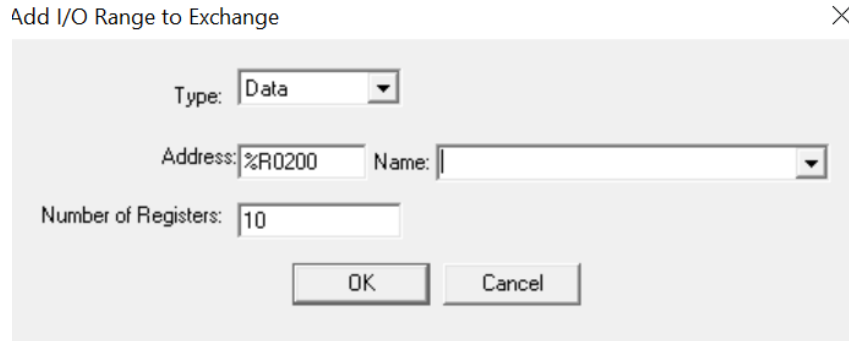

Add I/O Range to Exchange

Type: Data

Address: %R200 Name:

Number of Registers: 10

OK Cancel

Click **OK** so that dialog matches the one below.

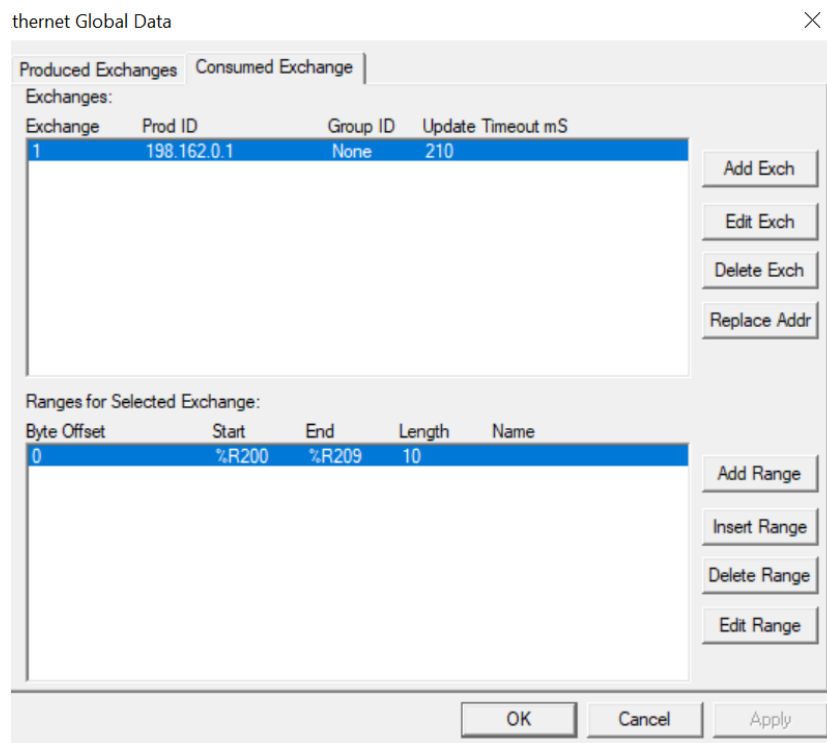

thernet Global Data

Produced Exchanges Consumed Exchange

Exchanges:

Exchange	Prod ID	Group ID	Update Timeout mS
1	198.162.0.1	None	210

Buttons: Add Exch, Edit Exch, Delete Exch, Replace Addr

Ranges for Selected Exchange:

Byte Offset	Start	End	Length	Name
0	%R200	%R209	10	

Buttons: Add Range, Insert Range, Delete Range, Edit Range

OK Cancel Apply

6. Node 2 configuration is now complete. Click **OK** and save the user program using an appropriate filename, such as **EGD Node 2.csp**, and then start EGD communication between Node 1 and Node 2.

EGD Example 1 - Starting EGD Communication between Node 1 & Node 2

Now that both Node 1 and Node 2 have been configured for Example 1, start them communicating following these steps:

1. Open the saved Node 1 user program (**EGD Node 1.csp**), and download it to Node 1.
2. Open the saved Node 2 user program (**EGD Node 2.csp**) and download it to Node 2.
3. Connect both Node 1 and Node 2 to an Ethernet network and put them both in RUN mode.

At this point, Node 1 and Node 2 should be exchanging EGD data as follows:

1. Every 100ms, Node 1 will read its %R100 through %R109 registers and send them via Exchange 1 to be received by Node 2's %R200 through %R209 registers.
2. Every 100ms, Node 2 will read its %R100 through %R104 registers and send them via Exchange 2 to be received by Node 1 into Node 1's %R200 through %R204 registers.

8.17 EGD Example 2 - MULTICAST EXCHANGE

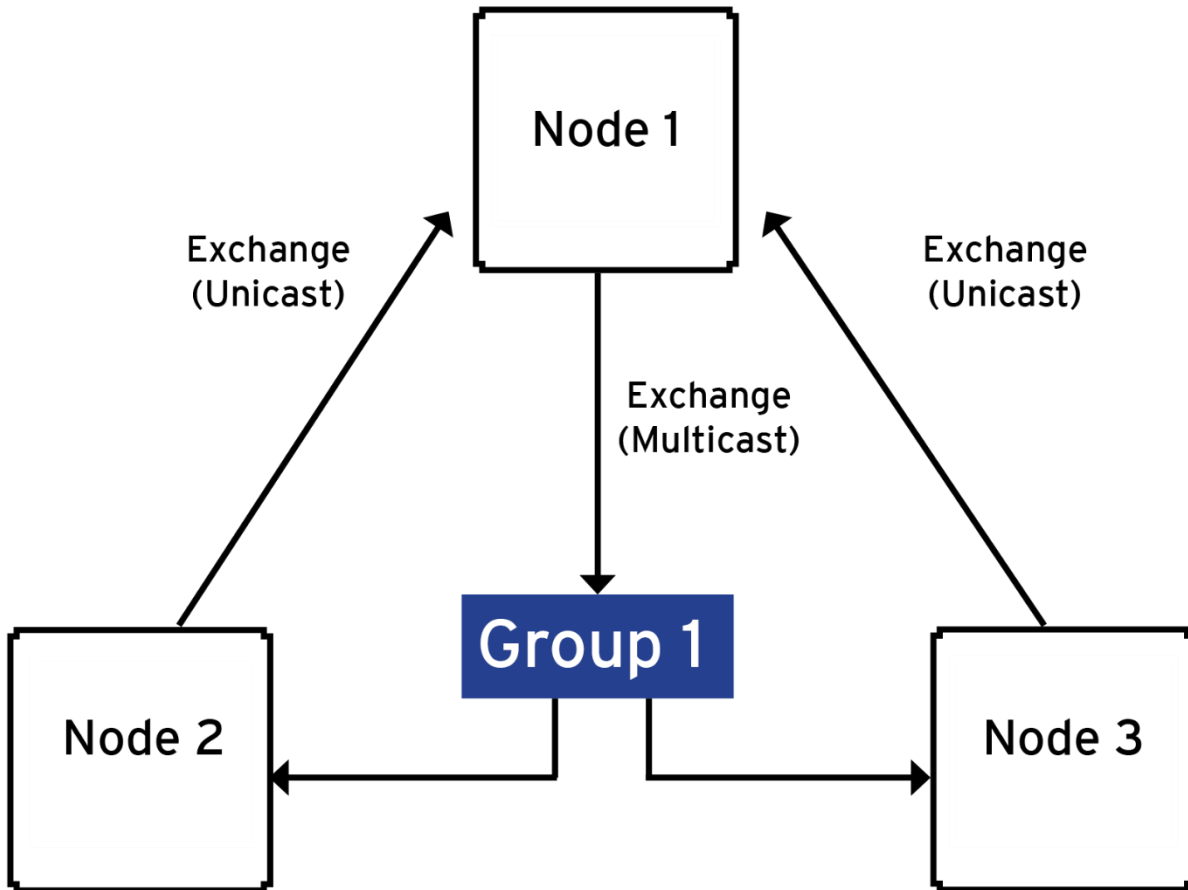

EGD Example - CONFIGURING NODE 1

The following are the production and consumption range details:

Table 8.12 - EGD Example Specifications					
Node 1 - Production Node					
Exchange #1: Production Details		Exchange #1: Produced Range Details			
Exchange Number	#1	Byte Offset	Start	Length	
Produced to	Group 1	0	%R1001	50	
Production Period	100mS	100	%R1501	25	
		150	%R1601	25	
Node 2 - Consumption Node					
Exchange Number	#1	Type	Byte Offset	Start	Length
Producer IP	192.168.0.1	Data	0	%R1	50
Group Data ID	1	Data	100	%R101	25
Update Timeout	210mS	Status	n/a	%R1001	n/a
Node 3 - Consumption Node					
Exchange Number	#1	Type	Byte Offset	Start	Length
Producer IP	192.168.0.1	Data	0	%R1	50
Group Data ID	1	Data	100	%R101	25
Update Timeout	210mS	Status	n/a	%R1001	n/a

MULTICAST CONFIGURATION NODE 1

To configure Node 1 for the EGD Example, perform the following steps:

1. On the main Cscape screen, select **New** on the **File** menu to start a new user program. Then open the OCS configuration dialog by selecting the following in Cscape: **Controller** → **Hardware Configuration** (or select "I-O" button from the Menu bar), then select Device and Model number. Select **EGD** checkbox → **Configure Selected Protocol**.
2. Once the **Configure Selected Protocol** button is selected, the **Ethernet Global Data** dialog is displayed. Two options are available: Produced Exchanges and Consumed Exchanges.

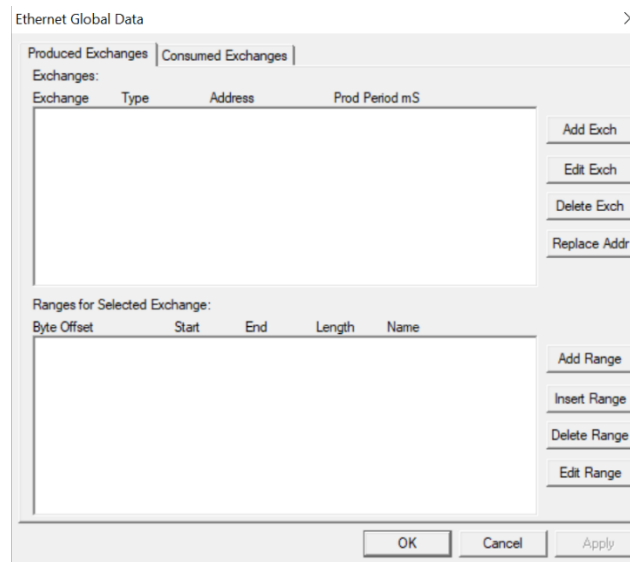

3. Select **Add Exch** to create a produced exchange, and then select **Group ID** and add appropriate group number. Click **OK**.

NOTE: To create Multicast communication, use Group ID and not IP Address.

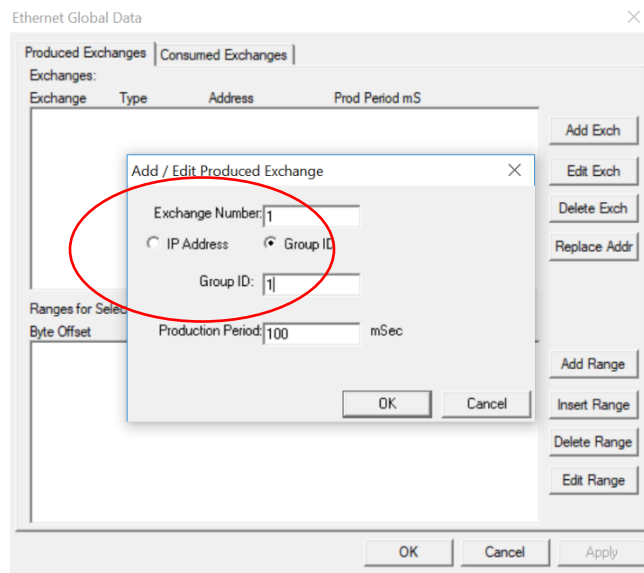

4. The Produced Exchange has been created. Select **Exchange 1**, then click on the **Add Range** button to define a Data Block for Produced Exchange 1. Then fill in the parameters and click **OK**.

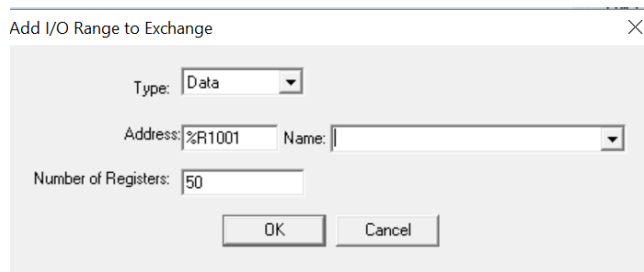

Continue adding the rest of the produced range details.

Exchange #: Produced Range Details		
Byte Offset	Start	Length
0	%R1001	50
100	%R1501	25
150	%R1601	25

At this point, the Produced Exchanges tab in the EGD Configuration dialog should be as shown in the figure below.

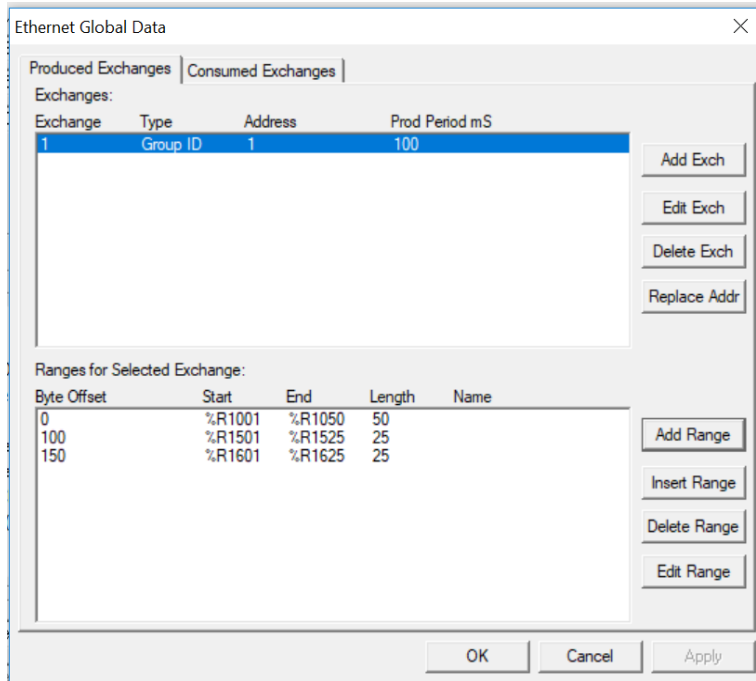

6. Node 1 configuration is now complete. Click OK, save the program using an appropriate filename such as **EX_2 Node 1.csp**, and then continue with Node 2 configuration.

NOTE: This is a **multicast**. Node 1 will produce exchanges to **GROUP 1** which in turn will send exchanges to all nodes that are assigned to Group 1.

MULTICAST EGD EXAMPLE - CONFIGURING NODE 2

1. On the main Cscape screen, select **New** on the **File** menu to start a new user program. Then open the OCS configuration dialog by selecting the following in Cscape: **Controller** → **Hardware Configuration** (or select "I-O" button from the Menu bar), then select Device and Model number. Select **EGD** checkbox → **Configure Selected Protocol**.
2. Once Exchange 1 has been configured as a Produced Exchange for Node 1, configure Exchange 1 as a Consumed Exchange for Node 2. To do this, first select the **Consumed Exchanges** tab and click on the **Add Exch** button to create a Consumed Exchange.

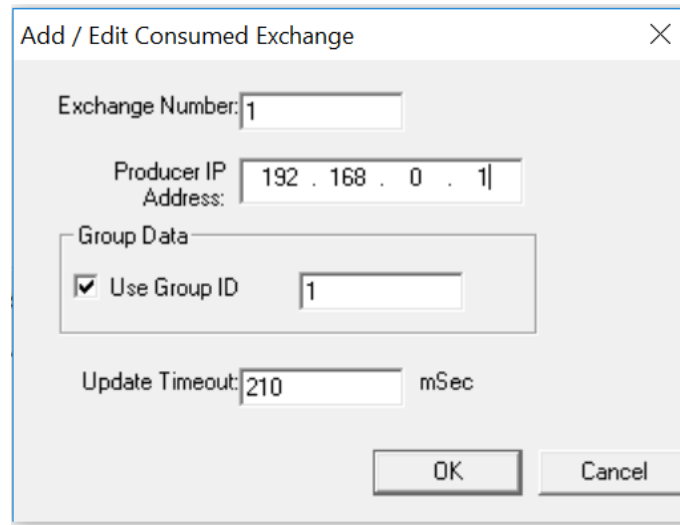

Exchange Number: 1

Producer IP Address: 192 . 168 . 0 . 1

Group Data

Use Group ID 1

Update Timeout: 210 mSec

OK Cancel

Then fill in the parameters, as shown below, and click **OK**.

- Once a Consumed Exchange has been made and highlighted, click on the **Add Range** button, in the EGD Configuration dialog, to define a Data Block for Consumed Exchange 1. Then fill in the parameters, as shown in below, and click **OK**.

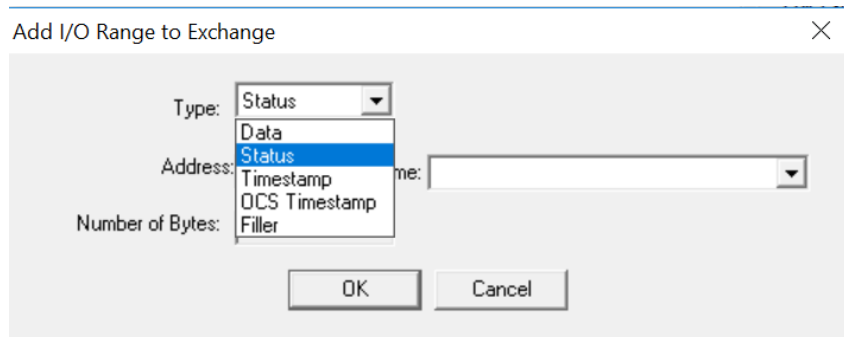

Continue adding the rest of the produced range details for Node 2.

Exchange #1: Consumed Range Details			
Type	Byte Offset	Start	Length
Data	0	%R1	50
Data	100	%R101	25
Status	n/a	%R1001	n/a

At this point, the Consumed Exchanges tab in the EGD Configuration dialog should be as shown in the figure below.

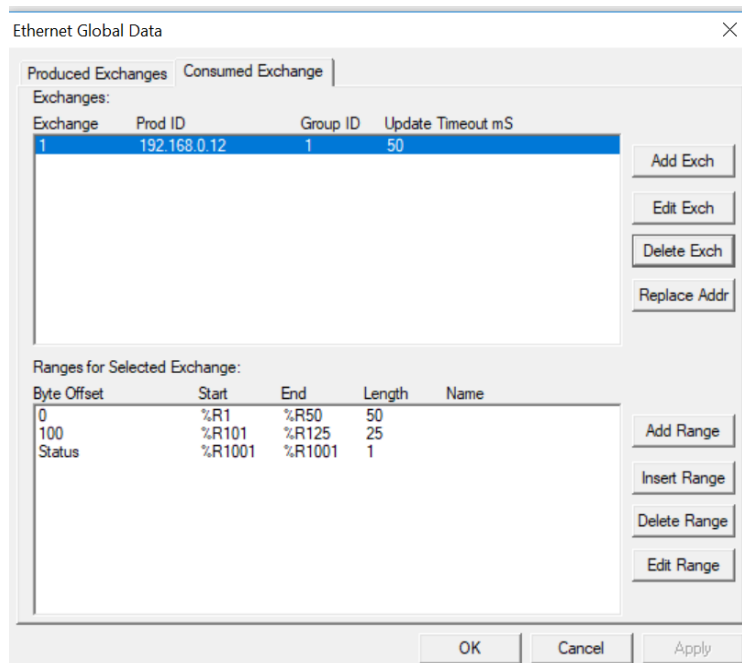

- Node 2 configuration is now complete. Click **OK**, save the program using an appropriate filename such as **EX_2 Node 2.csp**, and then continue with Node 3 configuration.

MULTICAST EGD EXAMPLE - CONFIGURING NODE 3

1. On the main Cscape screen, select **New** on the **File** menu to start a new user program. Then open the OCS configuration dialog by selecting the following in Cscape: **Controller → Hardware Configuration** (or select "I-O" button from the Menu bar), then select Device and Model number. Select **EGD** checkbox → **Configure Selected Protocol**.

Exchange #1: Consumed Range Details			
Type	Byte Offset	Start	Length
Data	0	%R1	50
Data	150	%R101	25
Status	n/a	%R1001	n/a

At this point, the Consumed Exchanges tab in the EGD Configuration dialog should be as shown in the figure below.

2. Repeat steps from Node 2. Open Then fill in the parameters, as shown below, and click **OK**.

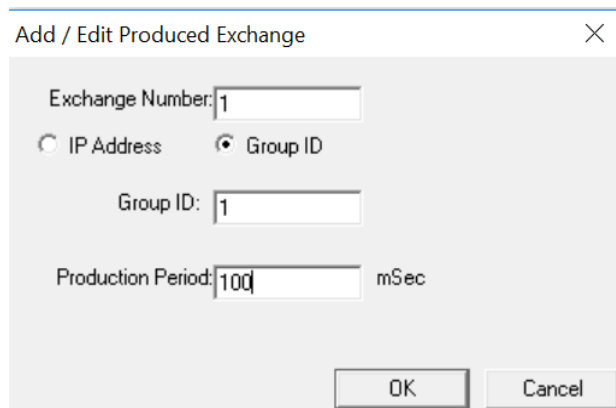

Then fill in the parameters, as shown below, and click **OK**.

3. Once a Consumed Exchange has been made and highlighted, click on the **Add Range** button, in the EGD Configuration dialog, to define a Data Block for Consumed Exchange 1. Then fill in the parameters, as shown in below, and click **OK**.

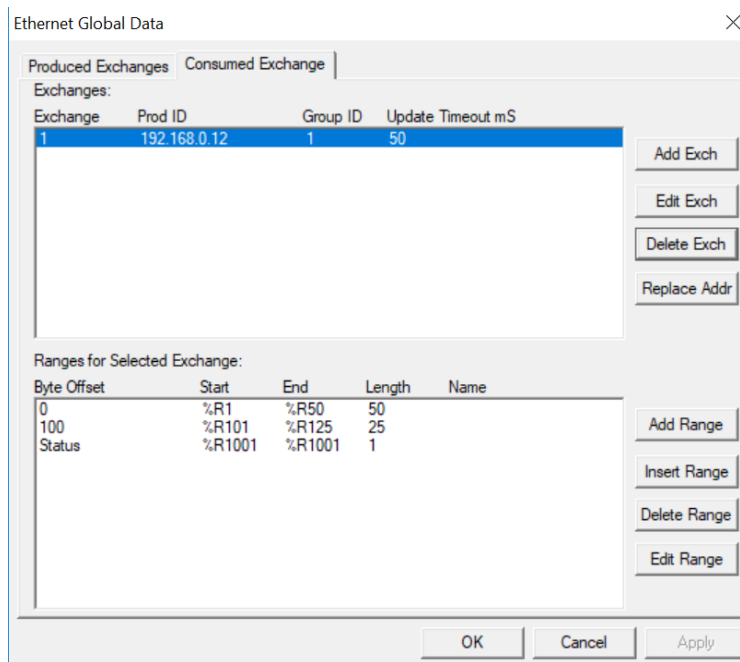
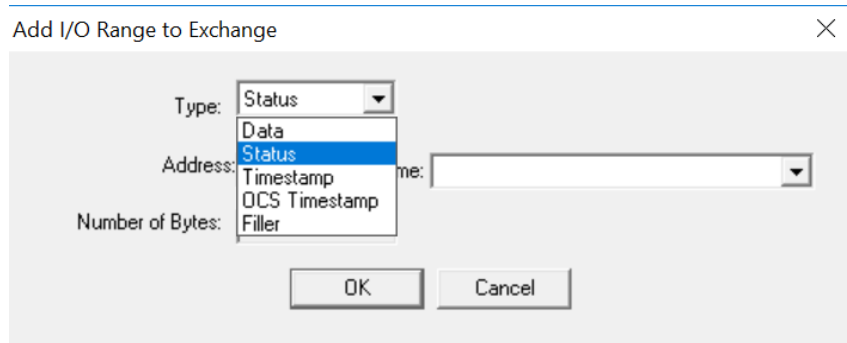

4. Node 1 configuration is now complete. Click OK, save the program using an appropriate filename such as **EX_2 Node 2.csp**, and then continue with Node 3 configuration.

EGD EXAMPLE 2 - STARTING MULTICAST EGD COMMUNICATION

1. Open the saved Node 1 user program (Node 1.csp) and download it to Node 1.
2. Open the saved Node 2 user program (Node 2.csp) and download it to Node 2.
3. Open the saved Node 3 user program (Node 3.csp) and download it to Node 3.

Connect both Node 1, Node 2, and Node 3 to an Ethernet network and put them both in RUN mode.

CHAPTER 9: SERVICE REQUEST TRANSFER PROTOCOL (STRP)

9.1 STRP Overview

Service Request Transfer Protocol (SRTP) is a GE Fanuc Automation protocol, which allows a remote SRTP Client to request services from an SRTP Server. In this context, the OCS acts as an SRTP Server, which responds to requests from one or more SRTP Clients.

Since SRTP was originally designed to support services provided by GE Fanuc Series 90 PLC products, the OCS's SRTP protocol, for OCS and RCS products, does not support all possible SRTP services. The OCS's implementation of SRTP is mainly limited to those services required for the exchange of PLC register data.

The following SRTP service requests are supported by the OCS:

Table 9.1 - SRTP Service Requests	
Request Code	Service Name
0	PLC_SSTAT
1	PLC_LSTAT
4	READ_SMEM
7	WRITE_SMEM
33	CHG_PRIV_LEVEL
67	RET_CONFIG_INFO
79	SESSION_CONTROL
97	PLC_FEATURES_SUPP

The READ_SMEM and WRITE_SMEM requests are supported for the following register types:

Table 9.2 - SRTP Register Types		
Selector	Register	Type
8	%R	16 bit
10	%AI	16 bit
12	%AQ	16 bit
16	%I	8 bit
18	%Q	8 bit
20	%T	8 bit
22	%M	8 bit
30	%S	8 bit
70	%I	1 bit
72	%Q	1 bit
74	%T	1 bit
76	%M	1 bit
84	%S	1 bit

9.2 STRP Configuration

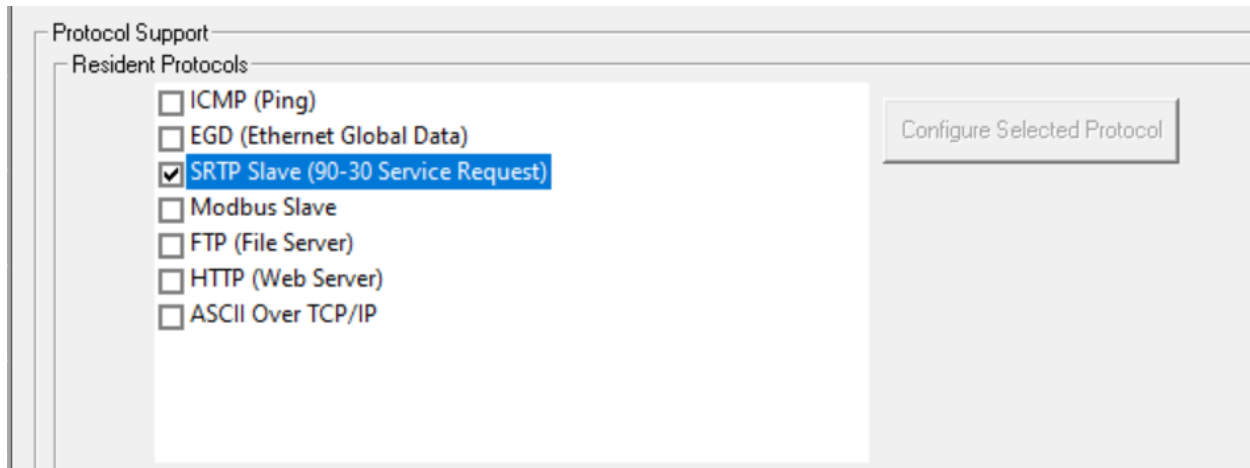

If SRTP protocol will be used in the application, the general OCS Configuration, previously described in [Chapter 5](#), must be performed, and SRTP must be enabled. To enable SRTP protocol, use Cscope Programming Software, to perform the following two steps:

1. Open OCS Wi-Fi LAN configuration dialog by selecting **Controller → Hardware Configuration** (select a series and device type)→ (OCS Wi-Fi Module) **Config → General LAN config**. Then select **SRTP Slave (90-30 Service Request) → Configure Selected Protocol**.
2. Enable SRTP by checking the **SRTP Slave (90-30 Service Request)** checkbox in the Module Configuration dialog, see below.

9.3 SRTP Operation

With respect to SRTP protocol, the OCS's behavior depends on whether the OCS is in RUN mode or not.

- When the OCS is in RUN mode, the OCS responds normally to SRTP Client requests.
- When the OCS is not in RUN mode, it still responds to SRTP Client requests, with the following differences:
 1. When a WRITE_SMEM request is received from an SRTP Client, to write a block of OCS registers, a reply is sent to the client, but the data is not written to OCS registers.
 2. When a READ_SMEM request is received from an SRTP Client, to read a block of OCS registers, a reply is sent to the client, but the data returned to the client is the last known values of the requested OCS registers, and is not actually read from the OCS registers.
 3. For all requests received from an SRTP Client, the reply will indicate to the client that the OCS is not in RUN mode, by returning the RUN DISABLED code in the Piggyback Status word.

CHAPTER 10: FTP SERVER PROTOCOL

10.1 FTP Server Protocol Overview

File Transfer Protocol (FTP) is a standard Client/Server Internet protocol, based on RFC959, which supports efficient and reliable file transfers over a TCP/IP network. In this context, the OCS acts as an FTP Server, which responds to file transfer requests from one or more FTP Clients.

NOTE: FTP protocol is supported only by OCS Models, which have built-in Ethernet *and* an OCS file system with removable media (such as Compact Flash / microSD). For OCS Models that do not have an OCS file system, the **FTP (File Transfer)** checkbox will be grayed out in Cscape's Ethernet LAN1 Configuration dialog.

The OCS's FTP Server supports both anonymous and authenticated file transfers between an FTP Client and the OCS file system. Authenticated file transfers require that the FTP Client provide one of two possible Username and Password pairs, before the OCS file system can be accessed.

Properly authenticated, an FTP Client can access OCS file system functions, which include file read, file create, file delete, file rename, file write, directory read, directory create, and directory delete.

10.2 FTP Configuration

If FTP File Transfer will be used in the application, FTP Configuration must be performed, in addition to the general Ethernet LAN1 Configuration. To configure FTP protocol, use Cscape Programming Software to perform the following five steps:

1. Open OCS Wi-Fi LAN configuration dialog by selecting **Controller → Hardware Configuration** (select a series and device type)→ (OCS Wi-Fi Module) **Config → General LAN config**. Then select **FTP (File Server) → Configure Selected Protocol**.

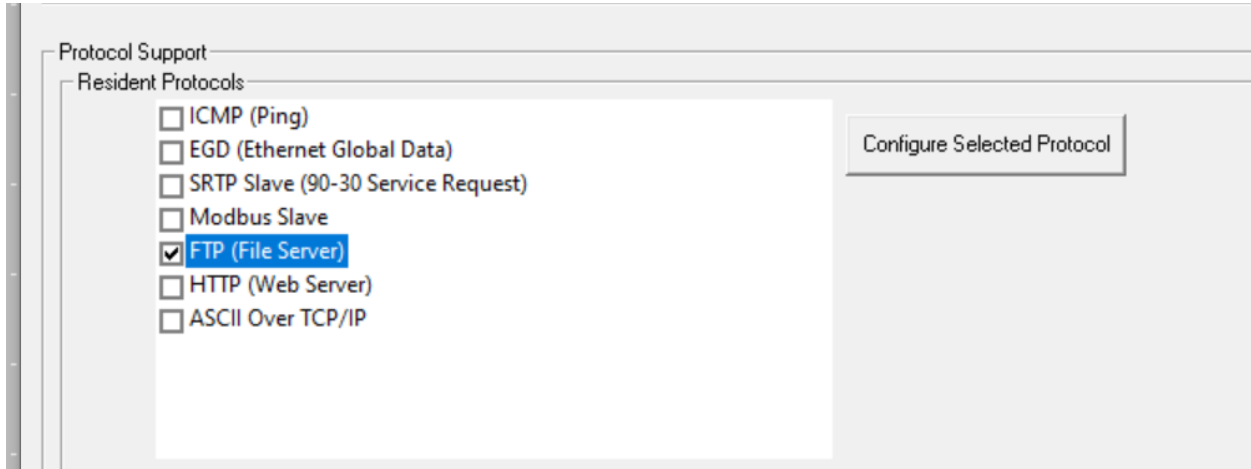

2. Enable FTP by checking the **FTP (File Server)** checkbox in the LAN1 Configuration dialog. Until this is done, the OCS will not respond to any FTP Client requests.
3. Click on the **Configure Selected Protocol** button next to the **FTP (File Server)** checkbox to open the FTP Configuration dialog. Refer to figure below.

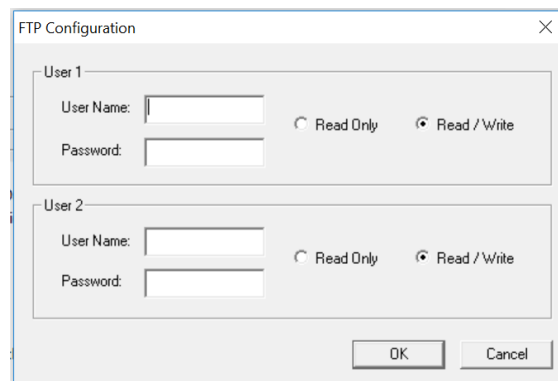

4. Optionally, set up the FTP Configuration parameters for **User 1** and/or **User 2** as follows:

Table 10.1 - FTP Configuration Parameters	
User Name	Enter an alphanumeric string (up to 40 characters) for the FTP Client's User Name
Password	Enter an alphanumeric string (up to 40 characters) for the FTP Client's Password.
Read Only	Select this option to give the FTP Client read-only access to the OCS file system.
Read / Write	Select this option to give the FTP Client read-write access to the OCS file system.

NOTE: User Names and Passwords are case-sensitive and, by default, User Name and Passwords for both User 1 and User 2 are empty. In this case, *anonymous* FTP Clients can access OCS files, but file access will be read-only. In a typical application, both User 1 and User 2 should be configured - one with read-only access and the other with read-write access.

5. Click **OK** to accept the new FTP protocol configuration.

10.3 FTP Operation

After performing OCS FTP Configuration, a 3rd party FTP Client (such as a PC running SmartFTP) can be used to access the OCS file system.

The target OCS's configured IP Address, FTP User Name (if any), and FTP Password (if any), must be entered into the FTP Client, to establish an FTP connection before any file accesses can be initiated. Please refer to documentation provided with the 3rd party FTP Client, regarding how to install, configure and operate the FTP Client.

When configuring an FTP Client, the user should be aware that the FTP protocol standard defines many optional features. Like many UNIX implementations, the OCS FTP Server imposes constraints on some of these options, as shown in Table 10.2 below.

FTP Option	Supported	Not Supported
File Transfer Type	Binary Type	ASCII Type & EBCDIC Type
File Format	Non-Print Format	Telnet Format & Carriage Control Format
File Structure	File Structure	Record Structure & Page Structure
Transmission Mode	Stream Mode	Block Mode & Compressed Mode
Data Connection Mode	Active (PORT) Mode	Passive (PASV) Mode

In addition, since the FTP Server will automatically disconnect an FTP Client after about 3 minutes of inactivity, the user might need to configure the FTP Client to periodically send NOOP (No Operation) commands to the FTP Server, to keep the connection alive.

10.4 FTP File Accessing

When using FTP to exchange files with an OCS, the user should know that the OCS file system implements an "8.3" filename format, which means all file and directory names should consist of up to 8 characters, followed by an optional dot, and an optional extension with up to 3 characters.

Also, the OCS file system allows multiple concurrent file accessing. For example, an FTP Client can read a file at the same time the OCS ladder program is logging data to another file. It is also possible for both the FTP Client and OCS ladder functions to read the same file at the same time.

If there is a file access conflict, such as an FTP Client attempting to delete a file that is currently being read or written by ladder, the file delete request is denied and an error response is sent to the FTP Client.

CHAPTER 11: HTTP SERVER PROTOCOL

11.1 HTTP Overview

Hypertext Transfer Protocol (HTTP) is a standard Client/Server Internet protocol, based on RFC1945, which transfers web content over a TCP/IP network. In this context, the OCS acts as an HTTP Server (web content provider), which responds to requests from HTTP Clients (web browsers).

The OCS's HTTP Server supports optional HTTP Client authentication, requiring the web browser operator to enter a User Name and Password, before web content can be accessed.

Properly authenticated, an HTTP Client can access web content previously stored in the OCS file system. This web content can include standard static HTML files and other web resource files. In addition, the HTTP Server allows the HTTP Client to display and edit OCS register data, by embedding specially named dynamic HTML files (**readreg.htm** and **writereg.htm**) into a static HTML file.

11.2 HTTP Configuration

If the HTTP Web Server will be used in the application, HTTP Configuration must be performed, in addition to the general Ethernet LAN Configuration. To configure HTTP protocol, use Cscape Programming Software to perform the following five steps:

1. Open OCS Wi-Fi LAN configuration dialog by selecting **Controller → Hardware Configuration** (select a series and device type)→ (OCS Wi-Fi Module) **Config → General LAN config**. Then select **HTTP (Web Server) → Configure Selected Protocol**.

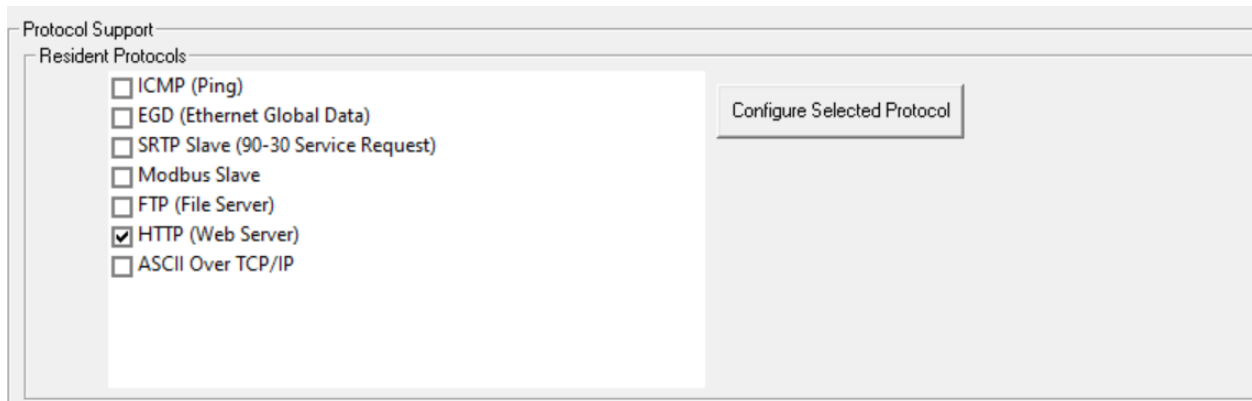

2. Enable HTTP by checking the **HTTP (Web Server)** checkbox in the LAN1 Configuration dialog. Until this is done, the OCS will not respond to any HTTP Client requests.
3. Click on the **Configure Selected Protocol** button next to the **HTTP (Web Server)** checkbox to open the HTTP Configuration dialog. Refer to figure below.

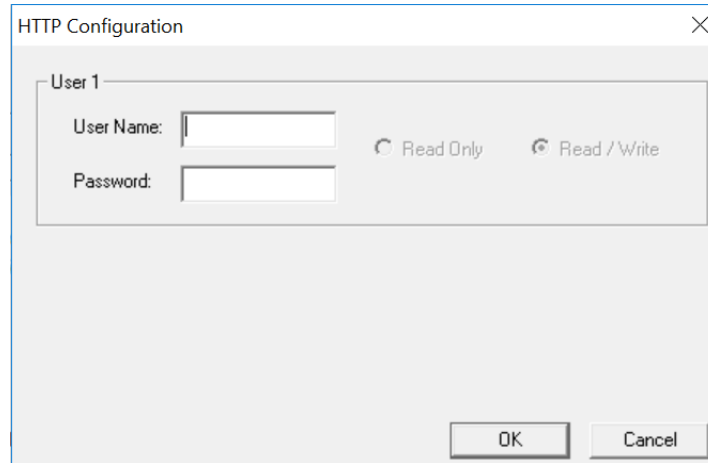

Optionally, set up the HTTP Configuration parameters for **User 1** as follows:

Table 11.1 HTTP Configuration Parameters	
User Name	Enter an alphanumeric string (up to 40 characters) for the HTTP Client's User Name
Password	Enter an alphanumeric string (up to 40 characters) for the HTTP Client's Password.
Read Only	This option is always deselected and grayed out.
Read / Write	This option is always selected and grayed out.

NOTE: User Names and Passwords are case sensitive, and, by default, the User Name and Password are empty. In this case, all HTTP Clients can access the OCS web content. In a typical application, the User Name and Password should be configured for security purposes.

5. Click **OK** to accept the new HTTP protocol configuration.

11.3 HTTP Operation

After performing HTTP Configuration, a 3rd party HTTP Client (such as a PC running Internet Explorer) can be used to browse OCS web content.

To start browsing web resources stored in the OCS file system, enter the appropriate URL (Uniform Resource Locator) into the HTTP Client (web browser). As a minimum, the URL should include the target OCS's IP Address and a filename. For example, if the OCS's IP address is 192.168.254.128, the following URL will access the **index.htm** file in the OCS file system root directory:

<http://192.168.254.128/index.htm>

NOTE: The HTTP Server does not automatically default to **index.htm**, if no file is specified in the URL.

If the OCS was configured with a User Name and Password, the browser will prompt for the User Name and Password to be entered, before opening the web page. Please refer to documentation provided with the 3rd party HTTP Client, regarding how to install, configure and operate the HTTP Client.

The OCS HTTP Server implements HTTP/1.0 and does not support persistent connections. Therefore, each time a web page (or other resource) is transferred, the following sequence takes place:

1. The HTTP Client (web browser) opens a connection with the HTTP Server and sends a request.
2. The HTTP Server sends a response to the HTTP Client and then closes the connection.

Since the connection only stays open long enough to complete one request, multiple HTTP Clients can concurrently access OCS web content, even though they are sharing a single connection.

11.4 Web Content - Storing

When storing web content files in the OCS file system, the user should know that the OCS file system implements an "8.3" filename format, which means all file and directory names must consist of up to 8 characters, followed by an optional dot, and an optional extension with up to 3 characters.

Web content files can be stored into the OCS file system media (such as Compact Flash / microSD), by temporarily plugging the media into a PC with an installed card reader, or via Ethernet using FTP (File Transfer Protocol). See Chapter 10 for information on using the OCS FTP Server.

To keep the web content files organized, multiple files, directories and subdirectories can be created on the OCS file system media as desired. Normally, it is a good practice to store an **index.htm** file in the root directory as a "home page", but this is not required.

11.5 Web Content - Dynamic Data

An OCS HTML file is either *static* or *dynamic*. The application engineer creates a static HTML file and stores it on the OCS file system media. Because of special markups in the static HTML file, the HTTP Server creates dynamic HTML files to access OCS Registers. This technique allows a static HTML file to read and write OCS registers dynamically.

STATIC HTML FILES

Custom HTML files are created to suit the application. These files can be created with a simple text editor or by using a 3rd party HTML Editor.

Within the static HTML file, `<iframe>` and `<form>` tags respectively read and write OCS Register data, by referencing two specially named dynamic HTML files (**readreg.htm** and **writereg.htm**).

DYNAMIC HTML FILES - READING OCS REGISTER DATA (READREG.HTM)

OCS Register data is read by placing an `<iframe>` tag, that references **readreg.htm**, within a static HTML file. The following example `<iframe>` tag reads and displays OCS Register %R11 as an Unsigned Integer every two seconds:

```
<iframe src="readreg.htm;reg-R11;fmt-UINT;rfs-2"></iframe>
```

The required **src** attribute is a quoted string containing the **readreg.htm** reference and two or three parameters, all separated by semicolons. The **reg**, **fmt** and **rfs** parameters specify the OCS Register to read, the display format to use and optionally how often to refresh the data. These parameters are described in more detail in the following 3 sections:

REG PARAMETER - OCS REGISTER READ REFERENCE

Examples: reg-R11
reg-R11.3

The required **reg** parameter is followed by a dash and an OCS Register reference. Register reference numbers start at 1 and the maximum depends on the register type and OCS type, as show in the following table:

Table 11.2 - OCS Register Read References		
OCS Register Type	Maximum Reference (ETN200)	Maximum Reference (ETN300)
%R	R2048	R9999
%AI, %AQ	A1512, AQ512	A1512, AQ512
%I, %Q, %M, %T	I2048, Q2048, M2048, T2048	I2048, Q2048, M2048, T2048
%S	S16	S16

- For BOOL formatting (see next section), a bit number can be appended to 16-bit register references (%R, %AI and %AQ). For example, **reg-R11.3** references bit 3 of register %R11. Valid bit numbers are 1 through 16.

fmt Parameter - OCS Register Read Format

Examples: fmt-BOOL
fmt-BOOL-ON-OFF
fmt-BOOL-YES-NO
fmt-BIN
fmt-HEX
fmt-INT
fmt-UINT
fmt-DINT
fmt-UDINT
fmt-REAL
fmt-REAL-E
fmt-ASCII-10
fmt-IPADR

The required **fmt** parameter is followed by a dash and a display format type. Valid format types are **BOOL**, **BIN**, **HEX**, **INT**, **UINT**, **DINT**, **UDINT**, **REAL**, **ASCII** and **IPADR**. Three of these format types (BOOL, REAL and ASCII) have optional or required modifiers as follows:

The **BOOL** format reads and displays a single bit, and two optional modifiers indicate the text to display for the bit's logical On and Off states. The text "TRUE" and "FALSE" will be displayed if the modifiers are omitted. In other words, **fmt-BOOL** is equivalent to **fmt-BOOL-TRUE-FALSE**.

The **REAL** format reads a 32-bit floating-point value, and the optional **-E** modifier can be used to display data in exponential (scientific) notation. The **fmt-REAL** format displays a variable number of digits to the left of the decimal point and 6 digits to the right of the decimal point (e.g. -12345.000000). On the other hand, the **fmt-REAL-E** format only shows 1 digit to the left of the decimal point and shows 6 digits to the right of the decimal point followed by a 4-character power of 10 (e.g. -1.234500E+04).

The **ASCII** format accesses a string of ASCII characters, and a string size modifier from **-1** to **-31** is required, indicating how many ASCII characters to read and display. For example, the **fmt-ASCII-10** format reads and displays a string of 10 ASCII characters.

rfs Parameter - OCS Register Read Auto-Refresh

Example: rfs-2

The optional **rfs** parameter specifies how often the <iframe> should automatically refresh the data on the browser screen. For example, **rfs-2** will cause the data to be refreshed every 2 seconds.

The number of seconds specified can range from 0 to the limits of the browser. A refresh time of 0 will refresh the data as often as possible, but this is not recommended because of the volume of Ethernet traffic it can create. If the optional **rfs** parameter is omitted, the data will only be refreshed when the user manually refreshes their web browser screen.

The **rfs** parameter uses a technique called "client-pull" to tell the web browser to do the periodic refresh. Not all web browsers support "client pull" and those that do support it can usually be configured to disable it for security purposes.

NOTE: When using an **Internet Explorer** browser to view OCS web pages that employ the **rfs** parameter, the browser plays the currently configured **Start Navigation** sound (a short "tick" by default) for each refresh. To disable the "ticking", (1) open the **Windows Control Panel**, (2) click the **Sounds** or **Sound and Audio Devices** icon or link and (3) turn off the **Start Navigation** sound by selecting **(None)** for it in the drop-down list.

fnt Parameter - OCS Register Read Font

Example: fnt-5-arial-blue

The optional **fnt** parameter specifies the font size, typeface and color to be used when OCS Register data is displayed on the browser screen.

All 3 font attributes (size, typeface and color) are optional, but must be specified in the order shown. For example, **fnt-5-arial** specifies a size 5, Arial font, but will use the browser's default text color.

If the size or typeface is omitted, its *dash* character should still be used as a *placeholder*. For example, **fnt---blue** specifies that the displayed text will be blue, but the browser's default font size and typeface will be used.

NOTE: In this last example, there are 3 dashes between **fnt** and **blue**.

For the 1st attribute (font size), a number from **1** to **7** can be used, with **1** as the smallest and **7** as the largest. This is a browser limitation, as browsers typically support only 7 font sizes. Optionally, a point size can be specified, such as **12pt**, but the browser will translate this into one of its supported font sizes.

For the 2nd attribute (font typeface), any typeface name supported by the browser can be used, such as **Arial**, **Times New Roman** or **Courier New**.

For the 3rd attribute (font color), the 16 standard HTML color names should always work. These 16 standard colors are **aqua**, **black**, **blue**, **fuchsia**, **gray**, **green**, **lime**, **maroon**, **navy**, **olive**, **purple**, **red**, **silver**, **teal**, **white** and **yellow**.

Dynamic Html Files - Writing OCS Register Data (writereg.htm)

OCS Register data is written by placing a `<form>` tag, that references **writereg.htm**, within a static HTML file. The following example `<form>` tag sets up an Unsigned Integer write to OCS Register %R11:

```
<form action="writereg.htm;reg-R11;fmt-UINT" method="post">...</form>
```

Between the `<form>` and `</form>` tags, there should be one or more `<input>` tags that enable a browser operator to enter or select data and write it to the register.

For example, in the following complete `<form>` markup, the first `<input>` tag creates a text input box, containing a default value of 0, which allows the user to enter a new value for %R11. The second `<input>` tag creates a **Send** button, which can be clicked to submit the new value (write it to the register):

```
<form action="writereg.htm;reg-R11;fmt-UINT" method="post">
  <input type="text" name="reg" value="0">
  <input type="submit" value="Send">
</form>
```

In the following example, the first `<input>` tag creates an **ON** button that can be clicked to turn %T22 On, while the second `<input>` tag creates an **OFF** button that can be clicked to turn %T22 Off.

```
<form action="writereg.htm;reg-T22;fmt-BOOL-ON-OFF" method="post">
  <input type="submit" name="reg" value="ON">
  <input type="submit" name="reg" value="OFF">
</form>
```

Important: In the above two examples, the OCS HTTP Server expects the **name="reg"** attributes to appear exactly as shown.

The `<form>` tag's required **action** attribute is a quoted string containing the **writereg.htm** reference and two parameters, all separated by semicolons. The **reg** and **fmt** parameters specify the OCS Register to write and the data entry/select format to use. These parameters are described in more detail in the following 2 sections:

reg Parameter - OCS Register Write Reference

Examples: reg-R11
 reg-R11.3

The required **reg** parameter is followed by a dash and an OCS Register reference. Register references start at 1 and the maximum reference depends on the register type and OCS type, as show in the following table:

Table 11.3 - OCS Register Write References		
OCS Register Type	Maximum Reference (ETN200)	Maximum Reference (ETN300)
%R	R2048	R9999
%AI, %AQ	A1512, AQ512	A1512, AQ512
%I, %Q, %M, %T	I2048, Q2048, M2048, T2048	I2048, Q2048, M2048, T2048

- For BOOL formatting (see next section), a bit number can be appended to 16-bit register references (%R, %AI and %AQ). For example, **reg-R11.3** references bit 3 of register %R11. Valid bit numbers are 1 through 16.

fmt Parameter - OCS Register Write Format

Examples: fmt-BOOL
 fmt-BOOL-ON-OFF
 fmt-BOOL-YES-NO
 fmt-BIN
 fmt-HEX
 fmt-INT
 fmt-UINT
 fmt-DINT
 fmt-UDINT
 fmt-REAL
 fmt-ASCII-10

The required **fmt** parameter is followed by a dash and a data entry format type. Valid format types are **BOOL**, **BIN**, **HEX**, **INT**, **UINT**, **DINT**, **UDINT**, **REAL** and **ASCII**. Three of these format types (BOOL, REAL and ASCII) have optional or required modifiers as follows:

The **BOOL** format writes a single bit, and two optional modifiers indicate the text that must be submitted to set the bit to its logical On and Off states. If these modifiers are omitted, they default to "TRUE" and "FALSE", so that **fmt-BOOL** is equivalent to **fmt-BOOL-TRUE-FALSE**.

The **REAL** format writes a 32-bit floating-point value, and data can be entered in either standard decimal notation or in scientific notation as desired, with or without the **-E** modifier. The **-E** modifier is not necessary and is ignored if present.

The **ASCII** format accesses a string of ASCII characters, and a string size modifier from **-1** to **-31** is required, indicating how many ASCII characters will be written when the form is submitted. For example, the **fmt-ASCII-10** format writes a string of 10 ASCII characters. If the user enters an ASCII string that is smaller than the specified string size, the submitted string will be padded with spaces.

11.6 Web Content - Authoring

Web content can range from very simple to extremely complex depending on application needs. As such, it is well beyond the scope of this supplement to attempt to provide a tutorial on the subject.

Web Server Example Applications

One of the best ways to learn how to use the HTTP Web Server is to study working examples. OCS HTTP Web Server Examples are available for download on the Horner Automation website (**Support** → **HE-XEC Ethernet Utility** → **OCS Web Demo**.)

<https://hornerautomation.com/support-files/>

Web Authoring Tools

There are several 3rd party tools available to assist in the development of web content. These tools come in four basic types: Text Editors, HTML Editors, WYSIWYG Programs, and Word Processors.

Text Editors require a thorough knowledge of HTML (HyperText Markup Language). However, many experienced web developers prefer to work using a plain text editor.

HTML Editors are specially enhanced text editors designed specifically to make web page creation easier, but they still require a great deal of HTML knowledge.

WYSIWYG (What You See Is What You Get) Programs allow HTML code creation using drag and drop techniques, and thus promise to minimize the author's need to understand HTML. However, when problems arise, there is no substitute for getting into the generated HTML code to see what is going on.

Word Processors should be avoided for web content design because they are not designed for this purpose.

Tool Name	Tool Type	Platform(s)	Web Site
Homesite	HTML Editor	Windows	http://www.adobe.com/
Dreamweaver	WYSIWYG Program	Windows MAC	http://www.adobe.com/

CHAPTER 12: ASCII over TCP/IP

12.1 Overview

This protocol is designed to send and receive ASCII data over Ethernet port of the controllers. Controller acts as a server while using this protocol.

Minimum version requirements for ASCII over TCP/IP feature:

- Firmware 12.6 or later
- Cscape 9 or later

12.2 ASCII Configuration

1. Open OCS Wi-Fi LAN configuration dialog by selecting **Controller** → **Hardware Configuration** (select a series and device type) → (OCS Wi-Fi Module) **Config** → **General LAN config**. Then select **ASCII Over TCP/IP** → **Configure Selected Protocol**.

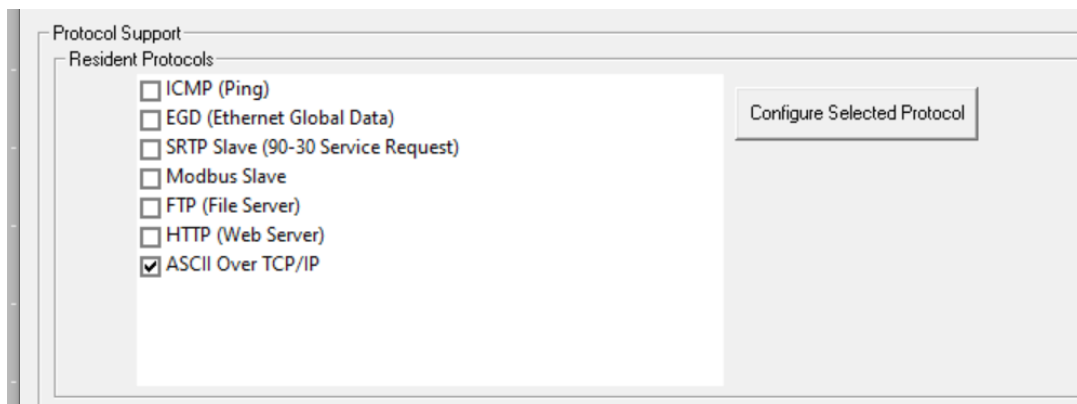

2. In **ASCII over TCP/IP Configuration** window configure Port Number, register for start address of Transmit data, register for start address for Receive data, Transmission Trigger Register and Status Address.

Port Number can be provided directly or by using register address. For port number entry using register user has to select **Get from Register** option.

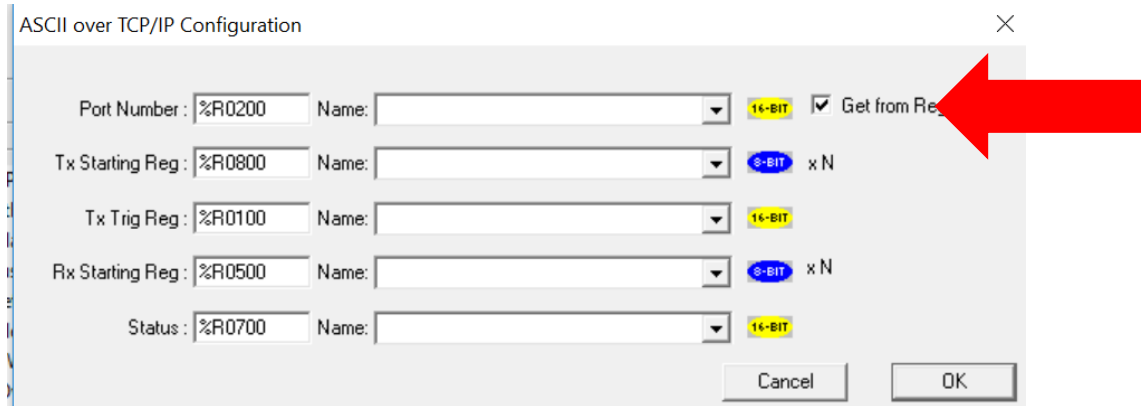

12.3 Sending ASCII characters to the client

In above configuration dialog %R800 and %R100 registers are configured for sending data.

%R800 is start of transmit data and should contain data in following format.

Table 12.1 - %R800 Register and Data		
Sl.No	Register Address	Data Content
1	%R800	First Register should contain 'Transmit Count' i.e. number of bytes (characters) to be transmitted.
2	%R801	Reserved.
3	%R802	Data to be transmitted. Each Register can hold 2 bytes of data.
4	%R803	Data to be transmitted.
	..	Data to be transmitted.
	..	Data to be transmitted.
n	%R(800+n-1)	Data to be transmitted.

NOTE: Maximum 2K ASCII characters can be sent in a single request.

%R100 is Transmit Trigger register used to start the transmission process. Setting R100 data to '1' will initiate transmission process and on successful transmission firmware will reset the R100 data to '0'.

12.4 Receiving ASCII Characters from the Client

In above configuration dialog %R500 register is used for receiving data. The receive data register format will be as below.

Table 12.2 - %R500 Register and Data		
Sl.No	Register Address	Data Content
1	%R500	First Register contains number of bytes (characters) received.
2	%R501	User can provide valid termination character here (if any). If there is no termination character set this register value to zero.
3	%R502	Received data. Each Register can hold 2 bytes of data.
4	%R503	Received data.
	..	Received data.
	..	Received data.
n	%R(500+n-1)	Received data.

NOTE: Maximum 2K ASCII characters can be received in a single request.

12.5 Status Information

%R700 register is used for to display status information. Details of Status Register as below.

Table 12.3 - %R700 Register and Data	
Bit No.	Description
1	Receive Data Overflow: Set when number received characters are more than 255.
2	Transmit Data Overflow: Set when transmit character count is more than 255.
3	Socket Creation Error: Set if there is any error in Socket creation.
4	Socket Allocate Error: Set if there is any internal memory allocation error for transmitting data.
5	Socket Send Error: If error in transmitting TCP packet.
6	Reserved
7	Reserved
8	Reserved
9	Reserved
10	Reserved
11	Reserved
12	Reserved
13	Reserved
14	Reserved
15	Reserved
16	Receive Data indication Bit: Set when new packet is received. User can reset this bit to '0'.

CHAPTER 13: DOWNLOADABLE PROTOCOLS (ETHERNET)

13.1 Modbus Overview

MODBUS TCP/IP is a variant of the MODBUS family of simple, vendor-neutral communication protocols. It is intended for supervision and control of automation equipment. Specifically, it covers the use of MODBUS messaging in an 'Intranet' or 'Internet' environment using the TCP/IP protocols. The most common use of this protocol is for Ethernet attachment of PLC's, I/O modules, and 'gateways' to other simple field buses or I/O networks.

Modbus TCP is a Client / Server protocol, which allows a remote Modbus TCP Client to request services from a Modbus TCP Server. In this context, the OCS acts as a Modbus TCP Server, which responds to requests from one or more Modbus Clients.

All Modbus requests that contain the OCS's IP Address are serviced. The client needs to be configured with the OCS's IP Address, and most clients also require the server unit number. Since each Ethernet module must have its own unique IP Address, the server unit number is not relevant and is discarded by the Ethernet module.

To access OCS registers, a Modbus TCP Client must be configured with the appropriate register type and offset. This is usually accomplished with one of two methods:

The first method uses either **Traditional Modbus References** or **Expanded Modbus References**, in which the high digit represents the register type and the lower digits represent the register offset (starting with register 1 for each type). Since only four Modbus register types (0, 1, 3, and 4) can be represented in this manner, the OCS's Modbus implementation packs several OCS register types into each Modbus register type. Starting addresses of each OCS register type are shown in the **Traditional Modbus Reference** and **Expanded Modbus Reference** columns.

The second method requires the Modbus TCP Client to be configured with a specific **Modbus Command and Offset**. The supported Modbus commands and the associated offsets are also illustrated in the tables below.

NOTE: Each controller family has its own Modbus Mapping table.

XLE/XLEe Series - Modbus Mapping					
OCS Ref.	Max. Range	Trad. Modbus Ref. (5 digits)	Expanded Modbus Ref. (6 digits)	Modbus Command(s)	Modbus Offset
%I1	2048	10001	010001	Read Input Status (2)	0
%IG1	64	13001	013001		3000
%S1	13	14001	014001		4000
%K1	10	15001	015001		5000
%Q1	2048	00001	000001	Read Coil Status (1)	0
%M1	2048	03001	003001	Force Coil (5)	3000
%T1	2048	06001	006001	Force Multiple Coils (15)	6000
%QG1	64	09001	009001		9000
%A1	512	30001	030001	Read Input Register (4)	0
%AIG1	32	33001	033001		3000
%SR1	192	34001	034001		4000
%AQ1	512	40001	040001	Read Holding Registers (3)	0
%R1	2488	40513	040513	Load Register (6)	0
%R1	2048	43001	043001	Load Multiple Registers (16)	3000
%AQG1	32	46001	046001		6000
%R1	9999	--	410001		10000

XLT/XLTe Series - Modbus Mapping					
OCS Ref.	Max. Range	Trad. Modbus Ref. (5 digits)	Expanded Modbus Ref. (6 digit)	Modbus Command(s)	Modbus Offset
%I1	2048	10001	010001	Read Input Status (2)	0
%IG1	64	13001	013001		3000
%S1	13	14001	014001		4000
%K1	4	15001	015001		5000
%Q1	2048	00001	000001	Read Coil Status (1)	0
%M1	2048	03001	003001	Force Coil (5)	3000
%T1	2048	06001	006001	Force Multiple Coils (15)	6000
%QG1	64	09001	009001		9000
%A1	512	30001	030001	Read Input Register (4)	0
%AIG1	32	33001	033001		3000
%SR1	192	34001	034001		4000
%AQ1	512	40001	040001	Read Holding Registers (3)	0
%R1	2488	40513	040513	Load Register (6)	0
%R1	2048	43001	043001	Load Multiple Registers (16)	3000
%AQG1	32	46001	046001		6000
%R1	9999	--	410001		10000

XL4e Series - Modbus Mapping					
OCS Ref.	Max. Range	Trad. Modbus Ref. (5 digits)	Expanded Modbus Ref. (6 digits)	Modbus Command(s)	Modbus Offset
%I1	2048	10001	010001	Read Input Status (2)	0
%IG1	256	13001	013001		3000
%S1	256	14001	014001		4000
%K1	4	15001	015001		5000
<hr/>					
%Q1	2048	00001	000001	Read Coil Status (1)	0
%M1	2048	03001	003001	Force Coil (5)	3000
%T1	2048	06001	006001	Force Multiple Coils (15)	6000
%QG1	256	09001	009001		9000
<hr/>					
%A1	512	30001	030001	Read Input Register (4)	0
%AIG1	32	33001	033001		3000
%SR1	256	34001	034001		4000
<hr/>					
%AQ1	512	40001	040001	Read Holding Registers (3)	0
%R1	2488	40513	040513	Load Register (6)	0
%R1	2048	43001	043001	Load Multiple Registers	3000
%AQG1	32	46001	046001	(16)	6000
%R1	9999	--	410001		10000

XL+, XL7e & EXL6e - Modbus Mapping					
OCS Ref.	Max. Range	Trad. Modbus Ref. (5 digits)	Expanded Modbus Ref. (6 digits)	Modbus Command(s)	Modbus Offset
%I1	2048	10001	010001	Read Input Status (2)	0
%IG1	256	13001	013001		3000
%S1	256	14001	014001		4000
%K1	5	15001	015001		5000
<hr/>					
%Q1	2048	00001	000001	Read Coil Status (1)	0
%M1	2048	03001	003001	Force Coil (5)	3000
%T1	2048	06001	006001	Force Multiple Coils (15)	6000
%QG1	256	09001	009001		9000
<hr/>					
%A1	512	30001	030001	Read Input Register (4)	0
%AIG1	32	33001	033001		3000
%SR1	256	34001	034001		4000
<hr/>					
%AQ1	512	40001	040001	Read Holding Registers (3)	0
%R1	2488	40513	040513	Load Register (6)	0
%R1	2048	43001	043001	Load Multiple Registers	3000
%AQG1	32	46001	046001	(16)	6000
%R1	9999	--	410001		10000

EXL10e - Modbus Mapping					
OCS Ref.	Max. Range	Trad. Modbus Ref. (5 digits)	Expanded Modbus Ref. (6 digits)	Modbus Command(s)	Modbus Offset
%I1	2048	10001	010001	Read Input Status (2)	0
%IG1	256	13001	013001		3000
%S1	256	14001	014001		4000
%K1	7	15001	015001		5000
%Q1	2048	00001	000001	Read Coil Status (1)	0
%M1	2048	03001	003001	Force Coil (5)	3000
%T1	2048	06001	006001	Force Multiple Coils (15)	6000
%QG1	256	09001	009001		9000
%A1	512	30001	030001	Read Input Register (4)	0
%AIG1	32	33001	033001		3000
%SR1	256	34001	034001		4000
%AQ1	512	40001	040001	Read Holding Registers (3)	0
%R1	2488	40513	040513	Load Register (6)	0
%R1	2048	43001	043001	Load Multiple Registers (16)	3000
%AQG1	32	46001	046001		6000
%R1	9999	--	410001		10000

X5 Series - Modbus Mapping					
OCS Ref.	Max. Range	Trad. Modbus Ref. (5 digits)	Expanded Modbus Ref. (6 digits)	Modbus Command(s)	Modbus Offset
%I1	2048	10001	010001	Read Input Status (2)	0
%IG1	256	13001	013001		3000
%S1	256	14001	014001		4000
%K1	4	15001	015001		5000
%Q1	2048	00001	000001	Read Coil Status (1)	0
%M1	2048	03001	003001	Force Coil (5)	3000
%T1	2048	06001	006001	Force Multiple Coils (15)	6000
%QG1	256	09001	009001		9000
%A1	512	30001	030001	Read Input Register (4)	0
%AIG1	32	33001	033001		3000
%SR1	256	34001	034001		4000
%AQ1	512	40001	040001	Read Holding Registers (3)	0
%R1	2488	40513	040513	Load Register (6)	0
%R1	2048	43001	043001	Load Multiple Registers (16)	3000
%AQG1	32	46001	046001		6000
%R1	8192	--	410001		10000

X4 & X7 - Modbus Mapping					
OCS Ref.	Max. Range	Trad. Modbus Ref. (5 digits)	Expanded Modbus Ref. (6 digits)	Modbus Command(s)	Modbus Offset
%I1	1024	10001	010001	Read Input Status (2)	0
%IG1	256	13001	013001		3000
%S1	256	14001	014001		4000
%K1	10	15001	015001		5000
%Q1	1024	00001	000001	Read Coil Status (1)	0
%M1	1024	03001	003001	Force Coil (5)	3000
%T1	1024	06001	006001	Force Multiple Coils (15)	6000
%QG1	256	09001	009001		9000
%A1	256	30001	030001	Read Input Register (4)	0
%AIG1	32	33001	033001		3000
%SR1	200	34001	034001		4000
%AQ1	256	40001	040001	Read Holding Registers (3)	0
%R1	2488	40513	040513	Load Register (6)	0
%R1	2048	43001	043001	Load Multiple Registers	3000
%AQG1	32	46001	046001	(16)	6000
%R1	5000	--	410001		10000

RCC Series - Modbus Mapping					
OCS Ref.	Max. Range	Trad. Modbus Ref. (5 digits)	Expanded Modbus Ref. (6 digits)	Modbus Command(s)	Modbus Offset
%I1	2048	10001	010001	Read Input Status (2)	0
%IG1	64	13001	013001		3000
%S1	13	14001	014001		4000
%K1	0	15001	015001		5000
%Q1	2048	00001	000001	Read Coil Status (1)	0
%M1	2048	03001	003001	Force Coil (5)	3000
%T1	2048	06001	006001	Force Multiple Coils (15)	6000
%QG1	64	09001	009001		9000
%A1	512	30001	030001	Read Input Register (4)	0
%AIG1	32	33001	033001		3000
%SR1	200	34001	034001		4000
%AQ1	512	40001	040001	Read Holding Registers (3)	0
%R1	2488	40513	040513	Load Register (6)	0
%R1	2048	43001	043001	Load Multiple Registers	3000
%AQG1	32	46001	046001	(16)	6000
%R1	4096	--	410001		10000

13.2 Modbus Client

Select Modbus Client from the Ethernet drop-down list. Then click on the Network button. This will open the Network Config (Modbus Client) dialog.

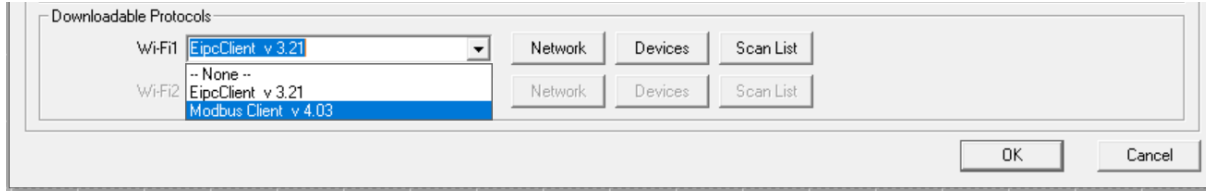

13.3 Network Config

Network parameters and status registers can be configured in the Network Config dialog.

- Configure minimum and maximum value for port ID's as 1024 and 4096 respectively.
- Configure the update Scan type as automatic or manual according to process requirements.
- Configure the (optional) network status register.

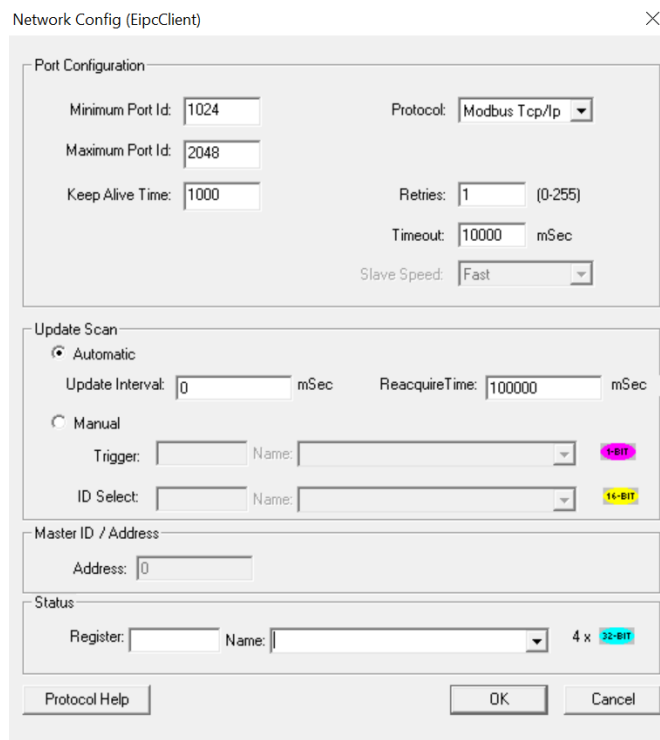

13.4 Device Config

Click on **Devices** button to configure Server device (max 64) as follows:

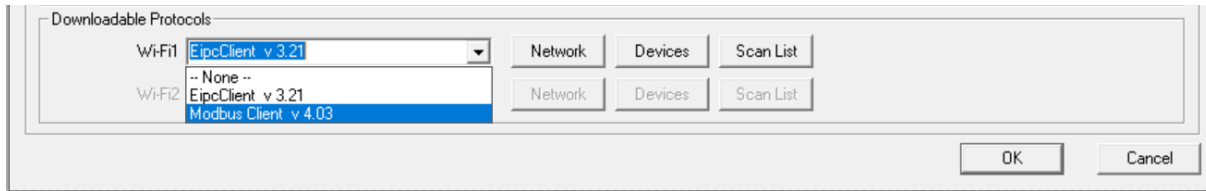

Add a device:

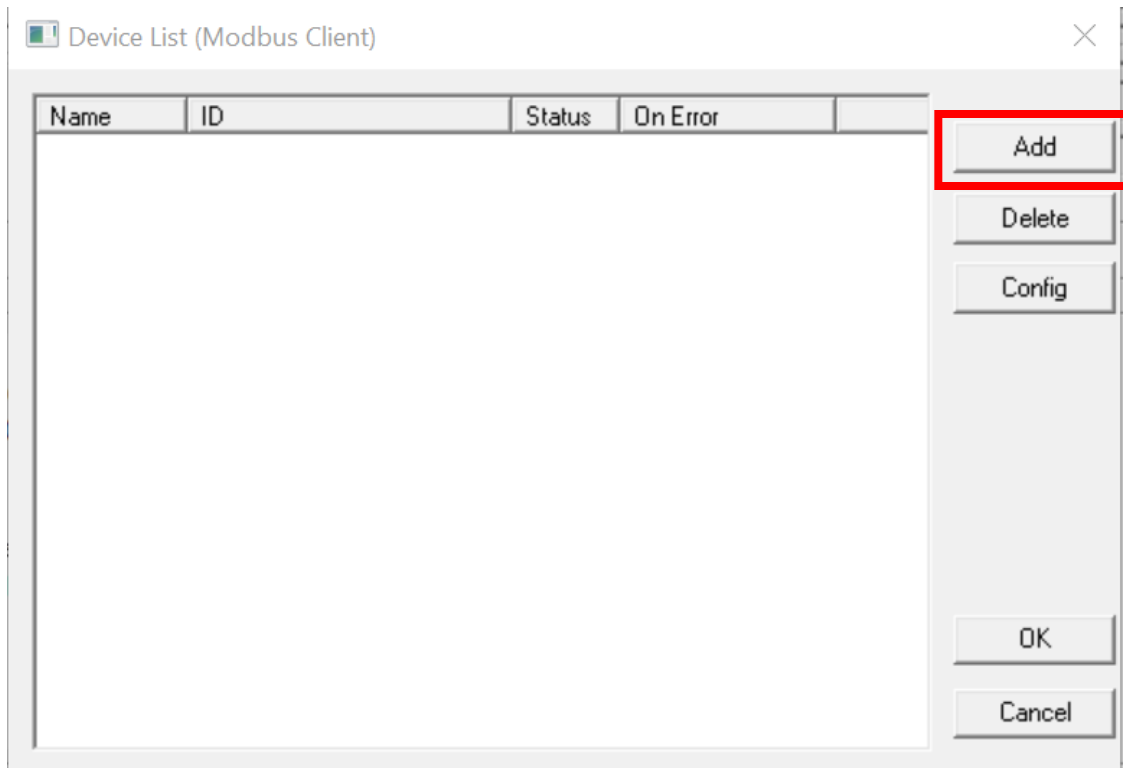

Enter Information to add a device then select OK. Please note the checked boxes below:

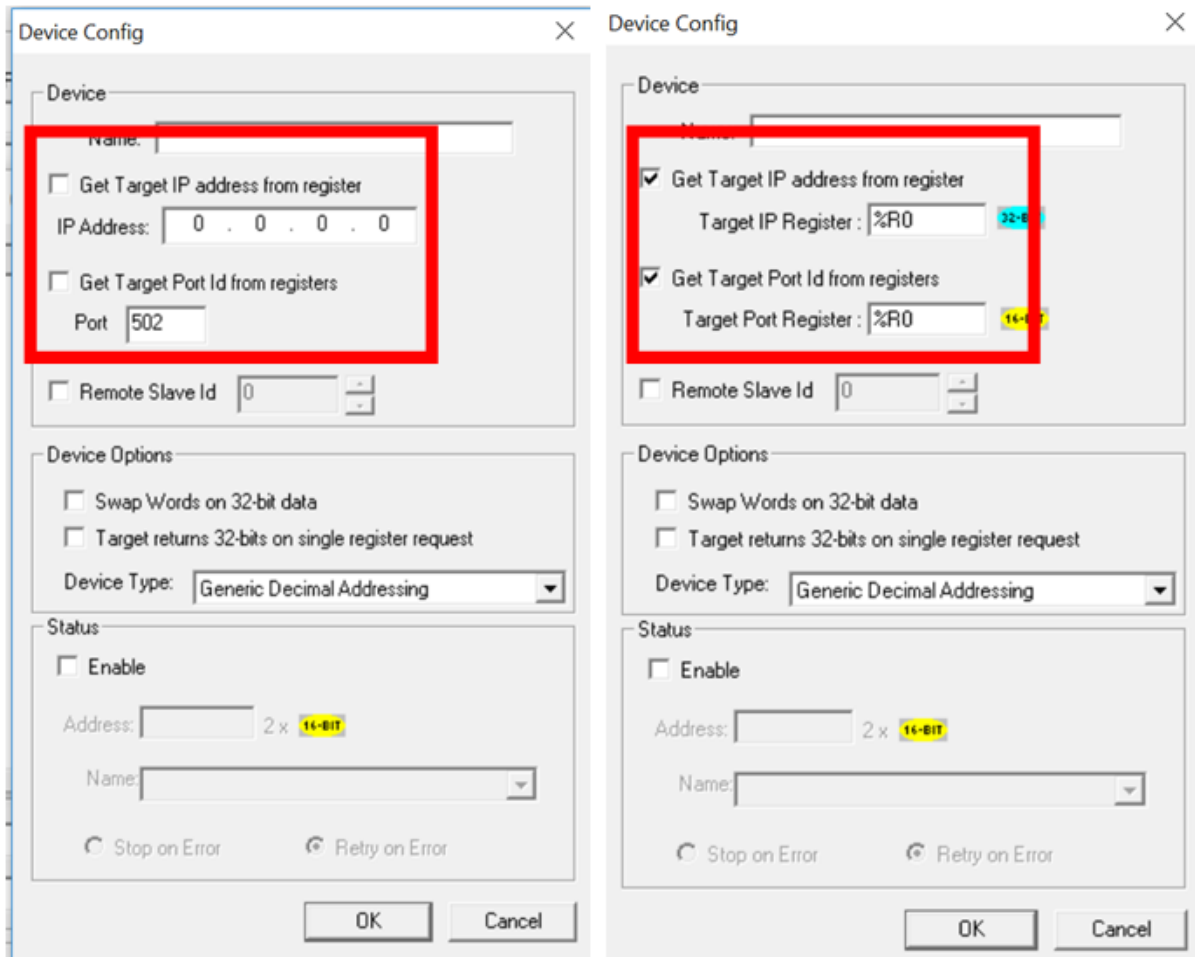

- Configure server device name, IP address (either direct or through registers) and port ID (either direct or through registers). Configuring IP address or port ID through registers allows user to modify IP address or port ID during runtime.

NOTE: User should change the controller mode to Idle and then to Run after modifying port ID during runtime.

- Select the address mode required when talking to this device.
- If option for Swap Words on 32-bit Data is checked, the high and low 16-bit values of 32-bit Data are swapped when transferred between the target and OCS.
- Device status registers can be optionally enabled and used to determine the current state of communications.
- Select Stop on Error as per process requirement (located in the Status box at the bottom).

Device Type: Modbus TcplpClient.Dll supports the following addressing modes:

- Generic Decimal Addressing
- Generic Hexadecimal Addressing
- Native Addressing
- Modicon PLC 5-Digit Addressing
- Modicon PLC 6-Digit Addressing

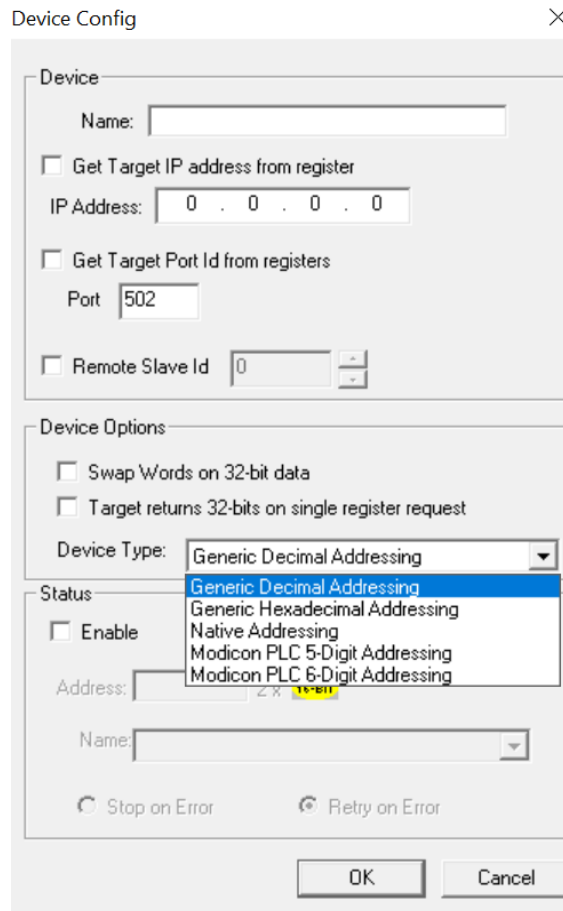

The screenshot shows a 'Device Config' dialog box with the following sections and controls:

- Device:**
 - Name: [Text Field]
 - Get Target IP address from register
 - IP Address: [0 . 0 . 0 . 0]
 - Get Target Port Id from registers
 - Port: [502]
 - Remote Slave Id [0]
- Device Options:**
 - Swap Words on 32-bit data
 - Target returns 32-bits on single register request
 - Device Type: [Generic Decimal Addressing]
- Status:**
 - Enable
 - Address: [Text Field]
 - Name: [Text Field]
 - Stop on Error
 - Retry on Error

The 'Device Type' dropdown menu is open, showing the following options:

- Generic Decimal Addressing (highlighted)
- Generic Hexadecimal Addressing
- Native Addressing
- Modicon PLC 5-Digit Addressing
- Modicon PLC 6-Digit Addressing

Buttons: OK, Cancel

Generic Decimal Addressing

The first option is **Generic Decimal Addressing**. Use this when the connected device uses an addressing mode which does not correspond to a Modicon PLC, and offsets in the documentation for the target device are given in decimal.

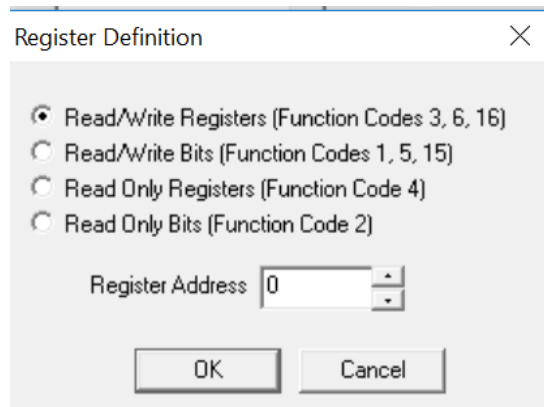

Addresses are entered in the following form:

<Data Type> <Decimal number>

Data type takes one of the following values:

RWR : (Read/Write Registers) Uses Modbus function codes 3, 6, 16

RWB : (Read/Write Bits) Uses Modbus function codes 1, 5, 15

ROR : (Read Only Registers) Uses Modbus function code 4

ROB : (Read Only Bits) Uses Modbus function code 2

The decimal number gives the offset of the target data in the selected data type.

Generic Hexadecimal Addressing

Use this when the connected device uses an addressing mode which does not correspond to a modicon PLC, and offsets in the documentation for the target device are given in hexadecimal

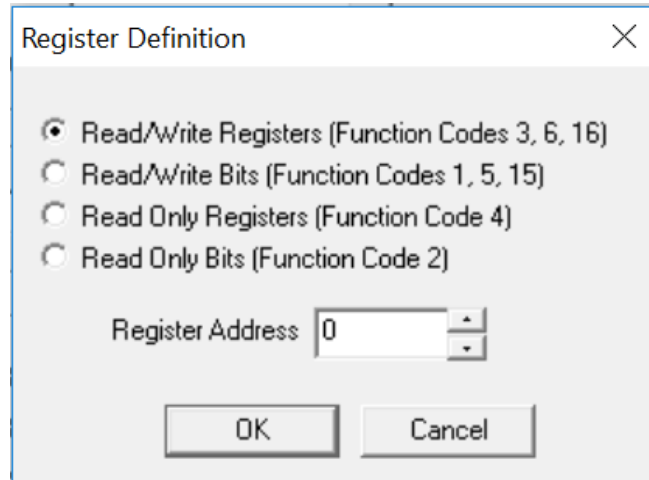

Addresses are entering the in the following form:

<Data Type> <Decimal number>

Data type takes one of the following values

RWR : (Read/Write Registers) Uses Modbus function codes 3, 6, 16

RWB : (Read/Write Bits) Uses Modbus function codes 1, 5, 15

ROR : (Read Only Registers) Uses Modbus function code 4

ROB : (Read Only Bits) Uses Modbus function code 2

The hexadecimal number gives the offset of the target data in the selected data type.

Native Addressing

Use this when the connected device is an OCS unit running Modbus TCP / IP host.

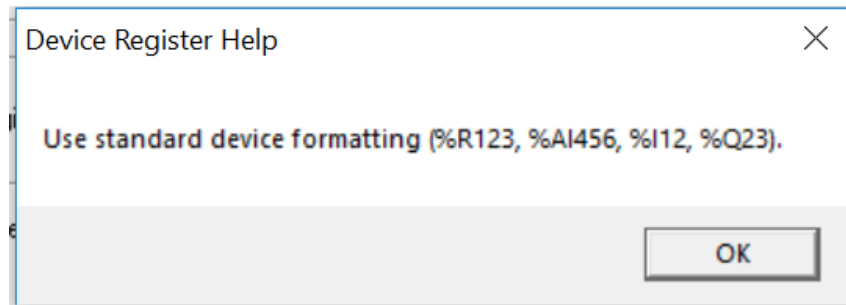

Addresses are entered as standard OCS addresses.

Modicon PLC 5-Digit Addressing

Use this when the connected device uses an addressing mode which corresponds to a reduced memory map modicon PLC.

Modicon PLC 6-Digit Addressing

Use this when the connected device uses an addressing mod which corresponds to an extended memory map modicon PLC.

13.5 Scan List

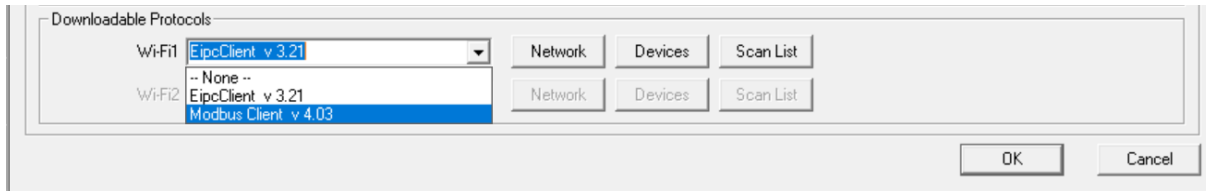

Click on Scan List button to open the Scan List (Modbus Client) dialog.

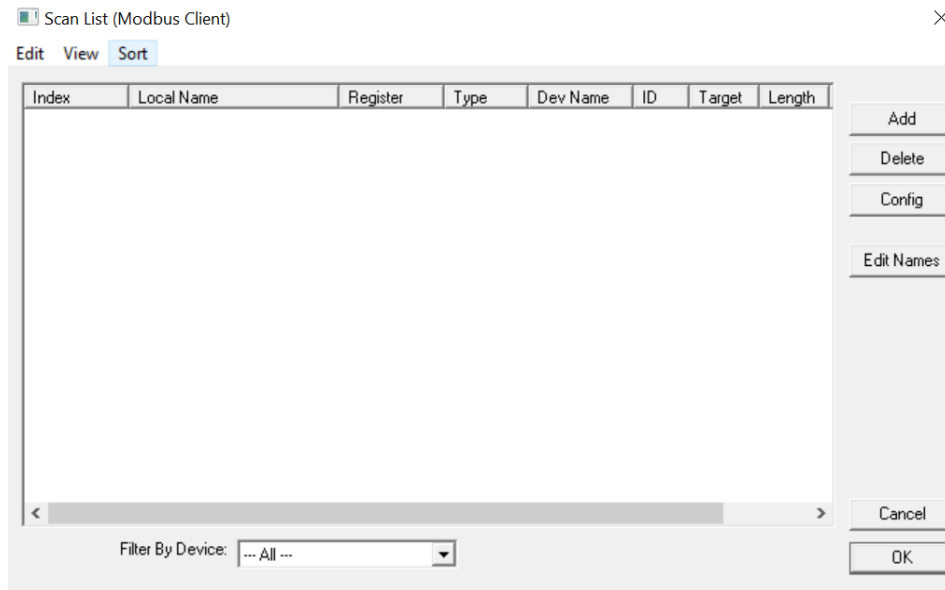

Data Mapping ×

Target

Device Name: DEV1 (0.0.0.1)

Device Register: > 32-bit access

Length: 1

Local

Register: Name:

Update Type

Polled Read Triggered Read

Polled Read/Write Triggered Write

Polled Read/Write Init

Trigger Register: Name:

OK Cancel

- To transfer data between the OCS and remote target, a Scan List must be created that defines each transaction. Each mapping entry (transaction) contains the source and destination registers, the number of consecutive registers transferred, the direction of the transfer and trigger for transfer (optional). Maximum number of entries is 512.

NOTE: Order of the Scan List is the order in which the transaction occurs.

- Scan list for a client device is developed in the following steps:

Click **ADD** button to open the Data Mapping dialog for adding new entry to the Scan List.

Configure the following:

Table 13.1 - Data Mapping Fields	
Device Name	Select the target device from the drop-down list. Only those device entries previously created from the Device Config menu are available.
Device Register	Specify the target device's register to be mapped according to the selected addressing mode.
32-Bit Access	Allows two local (OCS) 16-bit registers to be treated as a single 32-bit value. For example, if the value in either 16-bit register is modified, both registers are written to the device.
Length	Specify the number of consecutive device registers to Read/Write. Maximum length is 32.
Local Register	Specify the local (OCS) register that is the source or destination for transfer of the data.
Local Name	(Optional) Enter/Select name for the Local Register .
Update Type	This field specifies the direction and triggers the transfer of data between the OCS and target device. Select Update Type as per the system requirements.

CHAPTER 14: SAFETY & WARNINGS

14.1 Warnings

1. Only qualified electrical personnel familiar with the construction and operation of this equipment and the hazards involved should install, adjust, operate, or service this equipment.
2. Read and understand this manual and other applicable manuals in their entirety before proceeding.
3. Failure to observe this precaution could result in severe bodily injury or loss of life.
4. This module uses industry standard security and data integrity systems; however, care must be taken with any wireless system. Reviews on security and data integrity must be performed and appropriate mitigations must be put in place. Use of this or any wireless module for critical data or operation is not recommended.

14.2 FCC Compliance

This device complies with Part 15 of the FCC Rules. Operation is subject to the following two conditions:

1. This device may not cause harmful interference
2. This device must accept any interference received, including interference that may cause undesired operation.

14.3 Precautions

All applicable codes and standards need to be followed in the installation of this product. Adhere to the following safety precautions whenever any type of connection is made to the module:

1. Connect the safety (earth) ground on the power connector first before making any other connections.
2. When connecting to the electric circuits or pulse-initiating equipment, open their related breakers.
3. Do NOT make connection to live power lines.
4. Make connections to the module first; then connect to the circuit to be monitored.
5. Route power wires in a safe manner in accordance with good practice and local codes.
6. Wear proper personal protective equipment including safety glasses and insulated gloves when making connections to power circuits.
7. Ensure hands, shoes, and floor are dry before making any connection to a power line.
8. Make sure the unit is turned OFF before making connection to terminals.
9. Make sure all circuits are de-energized before making connections.
10. Before each use, inspect all cables for breaks or cracks in the insulation. Replace immediately if defective.
11. Use copper conductors in Field Wiring only, 60/75°C.
12. This adapter has been primarily tested without USB extensions. USB extensions that follow the USB 2.0 or later standard will function properly. If extending the USB connection is required, a quality cable is required along with a performance test in the application.

CHAPTER 15: TECHNICAL SUPPORT

15.1 Technical Support Contacts

For manual updates and assistance, contact Technical Support at the following locations:

North America:

Tel: (317) 916-4274

Fax: (317) 639-4279

Website: <https://hornerautomation.com>

Email: techsppt@heapg.com

Europe:

Tel: (+) 353-21-4321-266

Fax: (+353)-21-4321826

Website: www.hornerautomation.eu

Email: technical.support@horner-apg.com

CHANGE LOG

Change Log			
Date	Rev #	Description of Revision	Location in Doc
4/13/2020	2	Added USB precaution about USB extensions (Mantis #3078).	Precautions
12/1/2020	3	Update Drawings and dimensions (Mantis #4554)	Dimensions

INDEX

- %R500 Register and Data**, 101
- %R700 Register and Data**, 101
- %R800 Register and Data**, 100
- Access Point, 28
 - Channel, 18
 - Encryption, 16
 - Network IP, 17
- Access Point Mode, 14
- Add I/O Block, 52
- Add Range, 45
- Advanced Settings, 30
- ASCII, 101
- CE, 7
- Channel, 18
- Client
 - Client IP, 23
 - Connect Auto, 23
 - Password, 21, 22
 - Signal Health, 23
 - Status, 23
- Client Mode, 19, 29
- Compliance**
 - CE, 7
- Configuration
 - HTTP Protocol, 88
- Configure the I/O Block, 52
- Consumed Exchange I/O Block Type Definitions**, 48
- Consumed Exchange Parameters**, 50
- Country Codes, 30
- Data Blocks, 41
- Data Mapping Fields, 116
- Device Config, 108
- Device Type, 110
- Downloadable Protocols, 102
- Dynamic HTML Files, 91
- Dynmic HTML Files
 - HTTP, 95
- EGD Example Specifications**, 73
- EGD Multicast IP Addressing**, 58
- EGD Produced Exchange Status Words, 59
- EGD Protocol
 - Configuring Produced Exchanges, 40
- EGD Terminology**, 38
- EXL10e Modbus**, 105
- EXL6e Modbus, 104
- Expanded Modbus Reference, 102
- Filler Block, 56
- fmt Parameter
 - HTTP, 92, 97
- fnt Parameter
 - HTTP, 94
- FTP Configuration Parameters**, 86
- FTP Protocol
 - File Accessing, 87
 - Operation, 87
- FTP Server Option Constraints**, 87
- General Configuration, 24
- General LAN Configuration, 33
- Generic Decimal Addressing, 111
- Generic Hexadecimal Addressing**, 112
- HTTP Configuration Parameters**, 89
- HTTP Protocol
 - Configuration, 88
 - Operation, 90
 - Overview, 88
 - Web Content - Authoring, 97
 - Web Content - Dynamic Data, 91
 - Web Content - Storing, 91
- I/O Block Parameters**, 46, 52
- ICMP Configuration Parameters**, 36
- ICMP Protocol
 - Overview, 34
- Insert I/O Block, 52
- Introduction, 8
- IP Address, 17
- LIMITED WARRANTY, 3
- Manual PREFACE, 2
- Modbus Client, 107
- Modbus Command and Offset, 102
- Modbus Master Mapping, 102
- Modes, 26
- Mounting, 10
- Multicast IP Addressing, 58
- Native Addressing**, 113
- Network Config, 107
- Network IP, 17
- OCS Register Read References**, 92
- OCS Register Write References**, 96
- Operation

FTP Protocol, 87	Static HTML Files, 91
HTTP Protocol, 90	Status , 29
SRTP Protocol, 83	Status Block, 48
Overview	Status Blocks, 41
HTTP Protocol, 88	Status Information, 101
ICMP Protocol, 34	Status Word for EGD Consumed Exchange , 60
Modbus TCP/IP Client, 102	Status Word for EGD Produced Exchange , 59
Overview of HE-WIFIUSB and Topics, 8	System Menu, 13
Password, 22	System Menu Overview, 13
Ping Echo, 34	Table of Contents , 4
Produced Exchange I/O Block Type Definitions , 41	TCP/IP Configuration, 100
Produced Exchange Parameters , 43	TcplpClient.Dll, 110
Produced Exchange Unicast & Multicast , 40	Technical Resources
PROGRAMMING EXAMPLES , 3	Web Content Authoring, 97
RCC, 106	Technical Support , 2, 118
Receiving ASCII, 101	Contacts, 118
Reg Paramater	Traditional Modbus Reference, 102
HTTP, 92	troubleshooting / technical support, 118
reg Parameters	Unicast IP Addressing, 58
HTTP, 96	Web Authoring Tools, 98
rfs Parameter	Web Content Authoring Tools , 98
HTTP, 93	Web Server Example Applications, 97
safety / compliance , 6	Where to Find Information, 9
Safety Warnings, Guidelines , 6	Wi-Fi Configuration via Cscape, 24
Scan List, 114	Wi-Fi Dimensions, 10, 11
Sending ASCII, 100	Wi-Fi Installation, 10
Setting up Access Point Mode, 15	X4 & X7 Modbus, 106
Setting up Client Mode, 20	X5 Modbus, 105
Setting up Wi-Fi, 13	XL+ Modbus , 104
SRTP Protocol	XL4e Modbus, 104
Operation, 83	XL7e Modbus, 104
SRTP Register Types , 81	XLE/XLEe Modbus, 103
SRTP Service Requests , 81	XLT/XLTe Modbus, 103