

# HMI5000B Series

## Installation Guide

### Introduction

Thank you for purchasing a Maple Systems HMI5000B Series graphic industrial operator interface terminal. This booklet describes the steps necessary for installing the following models:

- HMI5040B
- HMI5070B
- HMI5100BN
- HMI5040BN
- HMI5070BN

The HMI5000B Series touchscreens are configured using the EZwarePlus software (purchased separately).

For information on programming and configuring the HMI, please refer to the **EZwarePlus Programming Manual** (P/N 1010-1015) available on the EZware software DVD and the Maple Systems website.

For additional information, please refer to the Support Center section of the Maple Systems website, [www.maplesystems.com](http://www.maplesystems.com).

The Support Center provides links to information such as Manuals, FAQs, Technical Notes, Training Videos, Sample Projects, Controller Information Sheets, and Controller Cables.

## Static Awareness

Do NOT remove the rear cover of the HMI5000B Series product – doing so will void the warranty. When the rear cover is removed the circuitry inside is exposed to possible damage by electrostatic discharge during handling.

Minimize the possibility of any electrostatic discharge by:

- Handling the HMI at a static-free, grounded workstation.
- Discharging personal static by grounding yourself prior to handling the HMI.
- Connecting the chassis ground (FG or  $\equiv$ ) connector of the HMI to a clean earth ground.
- Placing the HMI in an antistatic bag during transport.

## Unpacking the Unit

Carefully unpack the HMI. Check all material in the container against the packing list. Maple Systems will not accept responsibility for shortages against the packing list unless notified within 30 days. The equipment and accessories were inspected and tested by Maple Systems before shipment. Examine the equipment carefully; if any shipping damage is evident, notify the carrier immediately. Maple Systems is not responsible for claim negotiations with the carrier. Save the shipping container and packing material in case the equipment needs to be stored, returned to Maple Systems, or transported for any reason.

<b>Packing List</b>
<b>HMI5000B Series Touchscreen</b>
<b>Power Connector</b>
<b>Mounting Clamp Kit</b>
<b>HMI5000B Series Installation Guide</b>

## Warranty

A copy of the Warranty and Limitation of Liability is contained in the product box. It can also be found on the Maple Systems website.

## Technical Support

This manual is designed to provide the necessary information for trouble-free installation and operation of the HMI. For assistance, please contact Maple Systems as follows:

- Phone: 425-745-3229
- Email: [support@maplesystems.com](mailto:support@maplesystems.com)
- Web: [www.maplesystems.com](http://www.maplesystems.com)

## Installation of HMIs

Information furnished by Maple Systems is believed to be accurate and reliable. However, no responsibility is assumed by Maple Systems for the use of this information, or for any infringements of patents or other rights of third parties which may result from its use. No license is granted by implication, or otherwise, under any patent or patent rights of Maple Systems. Maple Systems retains the right to revise or change its products and documentation at any time without notice.

## CE Compliance

The HMIs have been tested to conform to European CE requirements, which meet or exceed the noise emissions and immunity requirements as set forth in the EN55022 (Emissions) and EN55024 (Immunity) standards. The products are designed to withstand electrical noise in harsh industrial environments. They also conform to requirements that limit electrical emissions. However, this does not guarantee that the products will be totally immune from possible malfunction in cases where severe electrical noise occurs. Therefore, follow these guidelines for proper wire routing and grounding to ensure the proper operation of the HMI.

## NEMA Rating

The HMI is rated for NEMA 4 (indoor) or IP65/IP66 installations. This means that when the HMI is properly mounted to a NEMA 4 panel or other NEMA 4 rated enclosure, the front enclosure of the HMI will provide protection to the inside of the panel from splashing water, wind-blown dust, rain, or hose-directed water. The HMI must be installed according to the instructions in this manual to be properly sealed.

## Environmental Considerations

The HMI is designed to operate in temperatures from 0° to 50°C (32° to 122°F). It is intended for indoor installations and may not be suitable for use in certain outdoor applications. Avoid installing the HMI in environments with severe mechanical vibration or shocks. Do not install the HMI in enclosures with rapid temperature variations or high humidity. Either case will cause condensation of water inside the device and eventual damage to the HMI.

- ⚠ **Warning:** *Do not operate the HMI in areas subject to explosion due to flammable gases, vapors, or dusts.*
- ⚠ **Warning:** *If wiring can potentially be exposed to lightning or power surges, use appropriate surge suppression devices.*

## Safety Precautions

Please observe the following precautions and ensure compliance with all local and national electrical standards when installing the HMI. Failure to comply with these restrictions could result in loss of life, serious personal injury, or equipment damage.

- ⚠ **Warning:** *Do not connect the HMI to an AC power source. This will cause permanent damage to the HMI.*
- ⚠ **Warning:** *A Hard-wired EMERGENCY STOP should be fitted in any system using an HMI to comply with ICS Safety Recommendations.*
- ⚠ **Warning:** *Do not attempt to use a DC power supply that does not meet the HMI's power requirements. This may cause malfunction or permanent damage to the HMI.*
- ⚠ **Warning:** *Do not power the HMI with a DC power supply used for inductive loads or for input circuitry to the programmable logic controller. Severe voltage spikes caused by these devices may damage the HMI.*

## Control Panel Design Guidelines

Pay careful attention to the placement of system components and associated cable routing. This can significantly enhance the performance and integrity of the control application.

### Cable Routing and Noise Immunity

Follow these guidelines when routing cables to the HMI:

- Always route the HMI communication cable and the power cable away from any AC voltage or rapidly switching DC control lines.
- Never bundle the HMI cables together with 120VAC power wires or with relay wiring.
- Try to keep at least 8 inches (20 cm) of separation between the HMI cables and other power wiring. If voltages greater than 120VAC are used in the system, greater separation is required.
- If the HMI cables must come near AC wiring, make sure they cross at 90 degrees.
- Run AC power wires in a separate grounded conduit to reduce electrical noise interference.
- Keep the cable lengths for the HMI as short as possible. Do not coil excess cable and place it next to AC powered equipment.
- Cover any equipment used in the enclosure that operates at high frequency or high current levels with a grounded metal shield.

### Power Supply Selection

The power supply used to power the HMI should provide an output of +24 VDC  $\pm 20\%$  measured at the HMI power connector. A 24VDC regulated power supply *dedicated to the HMI* is recommended. Use a power supply with adequate current rating. A power line filter installed at the AC input to the HMI power supply is highly recommended as a safeguard against conducted RF noise, which is often present on factory power lines. The wires connecting the output of the power line filter to the power supply should be kept as short as possible to minimize any additional noise pickup. The case of the power line filter should be connected to a quiet earth ground. The power line filter should have a current rating of at least 3 Amps with common mode and differential mode attenuation. In applications that may have high frequency noise present, a resistor ( $\sim 1 \text{ M}\Omega$ ) and capacitor ( $\sim 4700 \text{ pF}$ ) should be used in parallel to clean earth ground on the DC output of the power supply.

Do not use the power supply used to provide power to the HMI to power switching relays, solenoids, or other active devices.

Figure 1: Typical Panel Layout

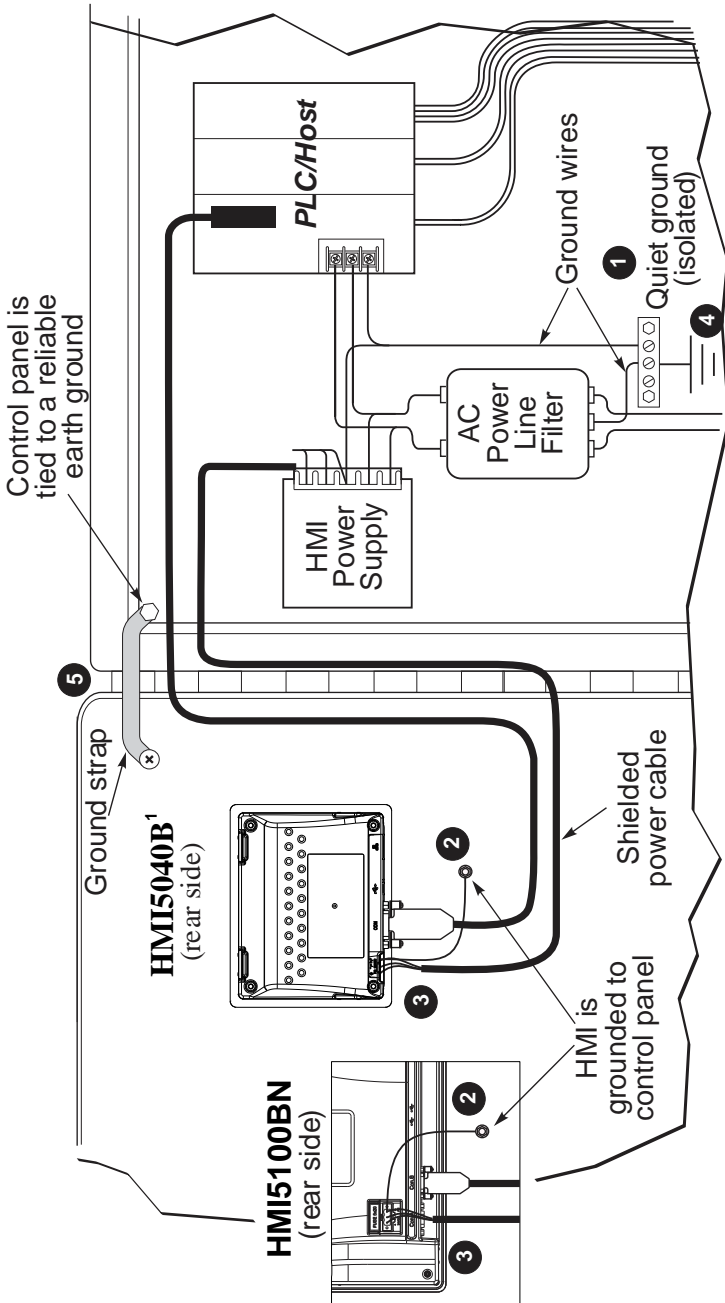

1. Also HMI5040BN, HMI5070B, and HMI5070BN

## Control Panel Grounding

The control panel must be connected to a good, high-integrity earth ground both for safety considerations and shielding purposes. Maple Systems cannot overemphasize the importance of good grounding. Failure to use good grounding procedures during installation may cause sporadic malfunction of the HMI.

Connect the HMI chassis ground terminal to a reliable earth ground with a low-resistance path. Refer to Figure 1:

- ❶ Route all earth ground wires that lead from the HMI, the PLC, the power supply, and the line filter to a central earth ground point such as a barrier strip. This will ensure that no ground current from one device influences the operation of the other devices.
- ❷ Connect the HMI chassis ground terminal to the control panel using a heavy-gauge short braided cable (#14 AWG) or ground wire to minimize resistance. Then, make sure the panel is properly grounded to a clean earth ground.

**Note:** *If the control panel is made of a non-conductive material, it is essential that the chassis ground terminal of the HMI is connected to a clean earth ground point located close to the panel.*

- ❸ Connect the power cable's shield wire to the HMI's chassis ground terminal.
- ❹ Connect the control panel to earth ground using a copper grounding rod close to the HMI and control panel.
- ❺ Hinged doors on control panels do not provide a long-term electrical connection to the rest of the enclosure. Corrosion develops over time and prevents good electrical contact. For this reason, a separate wire braid should be installed from the hinged control panel to the rest of the enclosure.

For a more in-depth overview of ground wiring techniques, refer to Technical Note #1027, "Ground Wiring and Electrical Noise Reduction" in the Technical Notes section of the Maple Systems website.

## Installation

It is necessary to follow all installation procedures described in this chapter for electrical noise immunity and CE compliance. The Maple Systems HMI is designed to connect easily to a PLC. External rear connectors provide quick connections for power, communications and programming wiring.

## Connect the HMI to Power

Use the 3-position connector supplied with the HMI to provide power to the HMI. The power cable for the HMI should be 18AWG, 2-conductor wire with a shield drain wire and protective shield (foil/braid). Cable (P/N 6030-0009) may be purchased by the foot from Maple Systems for constructing power cables.

Always run the DC ground wire directly back to the signal return of the power supply. *Do not use the chassis ground wire as the signal return.*

**⚠ Caution:** *To prevent possible damage to the HMI, wait ten seconds after removing power from the HMI before applying power again.*

### To connect the HMI to power:

1. Route the power cable from the HMI to the power supply. The power cable should not be any longer than necessary.
2. Install the cable wires, referencing the chart below (with colors shown for Maple Systems Cable 6030-0009):
  - a. Strip the power cable shield to expose 2" of the black and red wires.
  - b. Strip about ¼" of insulation from the black and red wires.
  - c. Connect the red wire to the positive (+) input of the HMI power connector and the 24V DC positive (+) output of the power supply.
  - d. Connect the black wire to the negative (–) input of the HMI power connector and the 24V DC negative (–) output of the power supply.
  - e. Connect the power cable shield wire to the HMI power connector FG or ≡ input. Connect the other side to chassis ground.

Wire Color	Power Supply Output	HMI Input
Red	+	+
Black	–	–
Shield	Chassis ground	FG or ≡

**Note:** *The power connector on the HMI uses a 3-position terminal block with screw-down clamps. Lugs are not required.*



## Panel Preparation

To provide a NEMA 4 seal, a metal panel or mounting surface that does not flex more than 0.010" is required. Thin panels or surfaces may bow between the mounting clamps and not form a seal with the gasket.

Allow sufficient clearance around the unit for the mounting hardware and cable connections. Cutout dimensions for each particular HMI model are available for print and download from the Support Center-Dimensional Drawings section of the Maple Systems website.

The area of the panel or mounting surface where the gasket comes into contact must be flat and free of scratches, pits, and other features that prevent the gasket from sealing properly. If the panel or mounting surface is not uniform, thick, flat, stiff, or smooth enough, then a sealant such as silicone may be required.

**Note:** Clean and deburr the panel cutout before the HMI is installed.

## Mount the HMI to the Panel

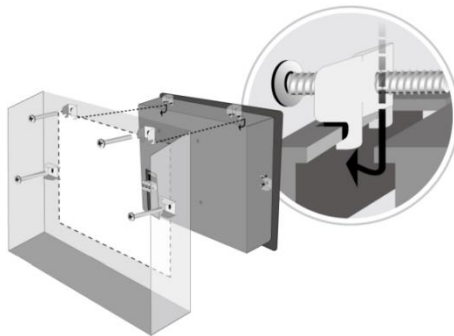

**Note:** The clamps for some models may be slightly different than shown here, but operate essentially the same way.

### Steps:

1. Prepare the clamps for the HMI by inserting the screws into the clamp as shown above. Position the screws so that the ends don't protrude past the clamp edge.
2. Set the HMI in the panel cutout and hold it in place until all clamps are in position.
3. Tighten the screw clamps in an even pattern until the unit is secure. Recommended torque: **3.5 in/lbs.**

**⚠ Caution:** Do not over-tighten the screws; the overlay may warp or the housing may get damaged.

## Configuration Wiring

To configure the HMI using the EZwarePlus software, use the Ethernet Configuration Cable (P/N 7431-0104) or USB Configuration Cable (P/N 7431-0119).

HMI Model	Configuration Cable	
	P/N 7431-0104 Ethernet (Crossover)	P/N 7431-0119 Micro USB
HMI5040B, HMI5070B	X	
HMI5040BN, HMI5070BN, HMI5100BN		X

### Ethernet

If using a switch or router between the PC and the HMI, use a straight-through or crossover cable as required by the switch or router.

In order to download a project to the HMI over Ethernet, the HMI must be assigned a unique IP address that is on the same subnet as the development PC.

Follow these steps to enter the System Settings menu and assign the HMI an IP address:

1. Apply power to the HMI.
2. Click the arrow icon located in the lower-right corner of the screen.
3. Click the gear icon to enter the system settings menu
4. When prompted, enter the system password (default: 111111).
5. Navigate to the Network tab.
6. Enter the desired IP address, or select *Obtain an IP Address Automatically* to enable DHCP.
7. Click *Apply* to save the changes, and *OK* to exit the system settings menu.
8. The updated IP address will appear in the system information window, also accessed via the arrow icon. For more information on Ethernet configuration options, please refer to the **EZwarePlus Programming Manual**.

## USB

A USB driver (included with the EZwarePlus software) must be installed when downloading from the PC to the HMI via USB connection.

**⚠ Caution:** *When connecting two powered devices via USB, a difference in potential can exist between the ground reference on each device. If there is a difference in ground potential (voltage), making a connection via a USB cable can complete a ground loop that may damage the HMI and PC. The Maple Systems Micro USB Configuration Cable (P/N 7431-0119) is recommended for connecting the HMI to the PC. The shield is not connected between the two ends of the cable, which will prevent a potentially damaging ground loop from occurring between the devices. Please refer to Page 6 for proper wiring instructions.*

**Note:** *The USB Host port is designed for data storage only. If connecting a USB hard drive, power the drive with its own power supply. **Do not charge any device from the USB port.***

## Maintenance

### Fusing Requirements

If the display does not come on within two seconds of power up, remove power. An internal fuse will prevent damage if the polarity of the DC power is incorrect. Check wiring to ensure proper connections and try to power up again

### Serial Port Connections

The following diagrams indicate the proper pin connections for the serial ports of the HMI.

**Serial Port Pinouts**

DE9P

Pin#	COM1 [RS-485 2 wire]	COM1 [RS-485 4 wire]	COM1 [RS-232]	COM3 [RS-485 2 wire]
1	Data-	RX-		
2	Data+	RX+		
3		TX-		
4		TX+		
5	GND			
6			TXD	
7				Data-
8				Data+
9			RXD	

HMI5040B

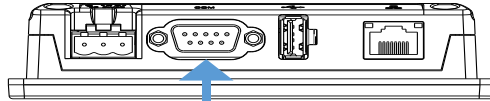

HMI5040BN

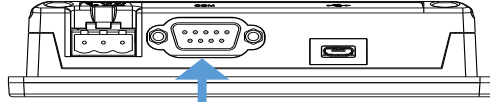

**Serial Port Pinouts (cont.)**

DE9P

Pin#	COM1 [RS-232]	COM2 [RS-485 4 wire]	COM2 [RS-485 2 wire]
1		RX-	Data-
2		RX+	Data+
3		TX-	
4		TX+	
5		GND	
6	TXD		
7	RTS		
8	CTS		
9	RXD		

HMI5070B

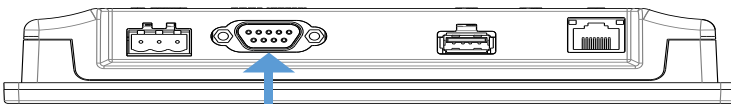

HMI5070BN

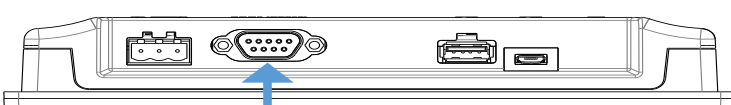

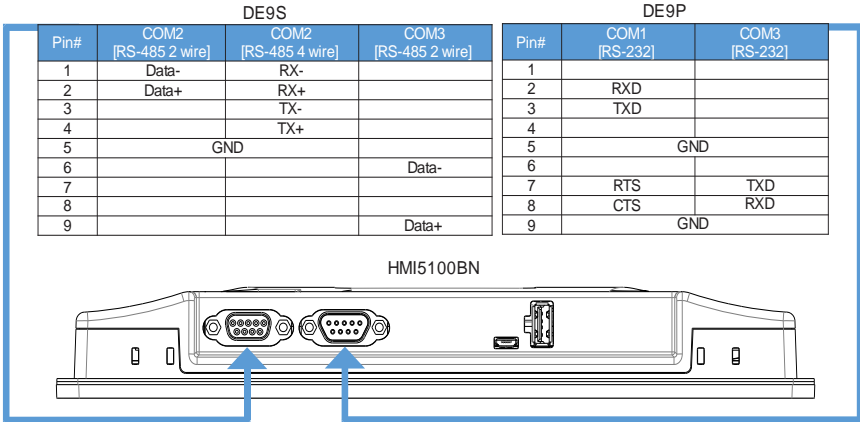

**Note:** COM2 [RS-485 2W] and COM3 [RS-485 2W] support the Siemens MPI 187.5K multi-point interface. However, only one COM port can be used with the Siemens MPI interface at a time.

**Note:** COM1 RS232 RTS/CTS and COM3 RS232 cannot be used simultaneously.







**Maple Systems Inc.**  
808 134<sup>th</sup> Street SW, Suite 120  
Everett, WA 98204-7333  
Phone: (425) 745-3229  
Email: [maple@maplesystems.com](mailto:maple@maplesystems.com)  
Web: [www.maplesystems.com](http://www.maplesystems.com)

© 2017 Maple Systems Inc. All rights reserved.