

GlobalTRAN™



GlobalTRAN® products carry the CE mark, certifying 100% compliance with IEC requirements for Non-Short Circuit Proof Isolating Transformers. GlobalTRAN control transformers feature touch-proof terminals, utilizing either Micron's SafeTouch terminal covers or a touch-proof terminal block, and meet true IP-20 or IP-00 terminal protection ratings as defined by IEC-529.

GlobalTRAN is the most reliable and versatile control transformer in the industry today.

- Carries the CE mark
- Epoxy encapsulated coils
- 20-year warranty, double the industry standard
- SafeTouch terminals for additional safety
- Optional integral primary and/or secondary fusing
- 10-32 screw terminals, molded terminal barriers
- Molded-in terminals and phil-slot screws



If you have any questions or we can be of any assistance in helping you determine your transformer requirements, please call our Technical Support Group at:

1-800-664-4660

www.microntransformers.com

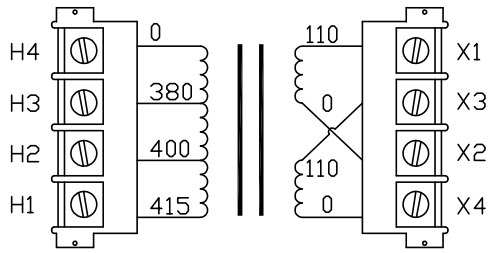

CONNECTION DIAGRAM

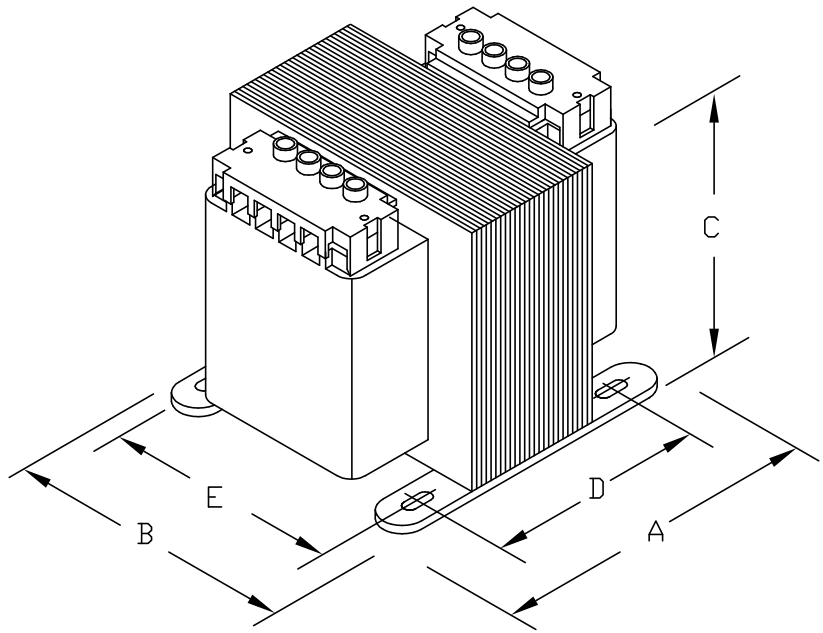

PROVIDED WITH SAFE TOUCH TERMINAL COVERS.
NO INTEGRAL FUSING CAPABILITY.

DIMENSIONS							APPROX.WT. LBS (KG)
	A	B	C	D	E	MTG. SLOTS	
INCHES (MM)	5.25 (133)	4.50 (114)	4.00 (102)	3.75 (95)	3.75 (95)	0.203X0.460 (5.1X11.7)	13.0 (6.0)



MICRON INDUSTRIES CORPORATION
777 CHURCH ROAD - ELMHURST, IL 60126
Tel. (800) 664-4660, (630) 516-1222 Fax (630) 516-1820
www.MicronTransformers.com

CAT.NO. B300-0067-GA			CONST. ENCAPSULATED			UL LISTED	
CATALOG GROUP GE			MODEL GLOBALTRAN				
RATING							SP CERTIFIED CE
OUTPUT AMPS	2.72/1.36	PRIMARY V	380/400/415		TEMP. CLASS	HZ 50/60	
VA	300	SECONDARY V	110X220		105°C	REVISION G	