

GlobalTRAN™



GlobalTRAN® products carry the CE mark, certifying 100% compliance with IEC requirements for Non-Short Circuit Proof Isolating Transformers. GlobalTRAN control transformers feature touch-proof terminals, utilizing either Micron's SafeTouch terminal covers or a touch-proof terminal block, and meet true IP-20 or IP-00 terminal protection ratings as defined by IEC-529.

GlobalTRAN is the most reliable and versatile control transformer in the industry today.

- Carries the CE mark
- Epoxy encapsulated coils
- 20-year warranty, double the industry standard
- SafeTouch terminals for additional safety
- Optional integral primary and/or secondary fusing
- 10-32 screw terminals, molded terminal barriers
- Molded-in terminals and phil-slot screws



If you have any questions or we can be of any assistance in helping you determine your transformer requirements, please call our Technical Support Group at:

1-800-664-4660

www.microntransformers.com

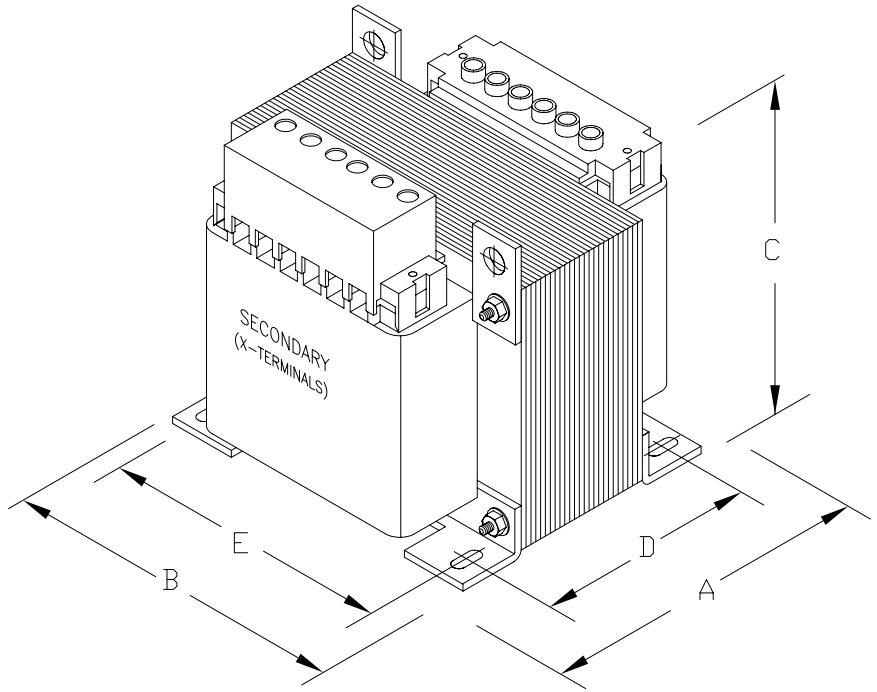
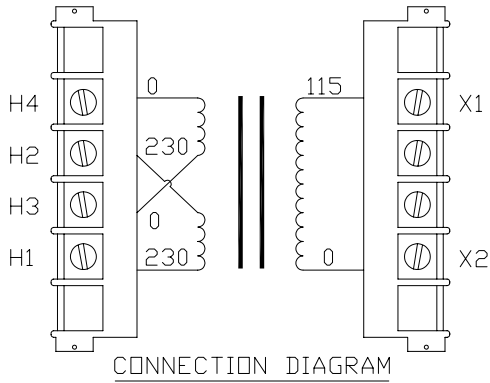

PROVIDED WITH TOUCH-PROOF TERMINALS
NO INTEGRAL FUSING CAPABILITY.

DIMENSIONS

APPROX. WT.
LBS
(KG)

	A	B	C	D	E	MTG. SLOTS	
INCHES (MM)	10.0 (254)	9.00 (229)	8.00 (203)	7.20 (183)	7.50 (191)	0.440X0.910 (11.0X23.0)	



MICRON INDUSTRIES CORPORATION
777 CHURCH ROAD - ELMHURST, IL 60126
Tel. (800) 664-4660, (630) 516-1222 Fax (630) 516-1820
www.MicronTransformers.com

CAT.NO. **B5K0-2012-GAH**

CONST. **ENCAPSULATED**

LISTED

MODEL **GLOBALTRAN**

CERTIFIED

RATING

OUTPUT AMPS	43.48	PRIMARY V	240X480, 230X460, 220X440	TEMP. CLASS	HZ 50/60	
VA	5000	SECONDARY V	120, 115, 110	180°C	REVISION G	