

# GlobalTRAN™



**GlobalTRAN®** products carry the CE mark, certifying 100% compliance with IEC requirements for Non-Short Circuit Proof Isolating Transformers. GlobalTRAN control transformers feature touch-proof terminals, utilizing either Micron's SafeTouch terminal covers or a touch-proof terminal block, and meet true IP-20 or IP-00 terminal protection ratings as defined by IEC-529.

GlobalTRAN is the most reliable and versatile control transformer in the industry today.

- Carries the CE mark
- Epoxy encapsulated coils
- 20-year warranty, double the industry standard
- SafeTouch terminals for additional safety
- Optional integral primary and/or secondary fusing
- 10-32 screw terminals, molded terminal barriers
- Molded-in terminals and phil-slot screws



If you have any questions or we can be of any assistance in helping you determine your transformer requirements, please call our Technical Support Group at:

**1-800-664-4660**

[www.microntransformers.com](http://www.microntransformers.com)

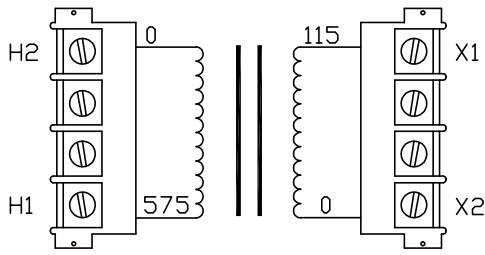

CONNECTION DIAGRAM

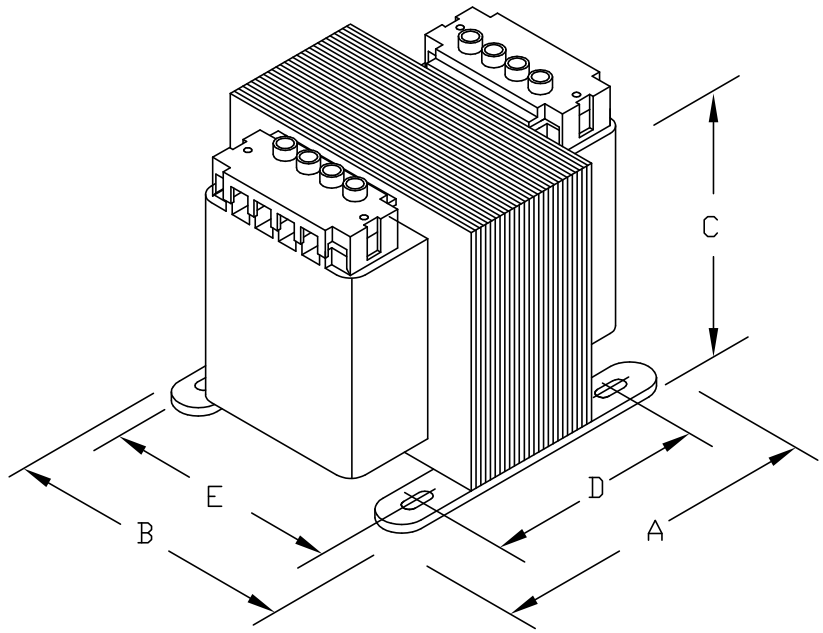

PROVIDED WITH SAFE TOUCH TERMINAL COVERS.  
NO INTEGRAL FUSING CAPABILITY.

DIMENSIONS							APPROX. WT. LBS (KG)
	A	B	C	D	E	MTG. SLOTS	
INCHES (MM)	7.38 (187)	5.25 (133)	4.50 (114)	6.38 (162)	4.38 (111)	0.312X0.687 (8.0X17.5)	28.0 (12.7)



**MICRON INDUSTRIES CORPORATION**  
777 CHURCH ROAD - ELMHURST, IL 60126  
Tel. (800) 664-4660, (630) 516-1222 Fax (630) 516-1820  
www.MicronTransformers.com

CAT. NO. <b>B750-0050-GA</b>			CONST. <b>ENCAPSULATED</b>			UL LISTED	
CATALOG GROUP <b>GD</b>			MODEL <b>GLOBALTRAN</b>				
<b>RATING</b>							SP CERTIFIED  CE
OUTPUT AMPS	6.52	PRIMARY V	550/575/600		TEMP. CLASS	HZ 50/60	
VA	750	SECONDARY V	110/115/120		105°C	REVISION <b>G</b>	