

ImperviTRAN®



ImperviTRAN® is the ultra-reliable industrial control circuit transformer and the most accepted transformer in the industry. Behind its clean design is a toughness that makes it measure up to any requirement placed upon it. ImperviTRAN transformers carry Micron's 20-year warranty.

- Epoxy encapsulated coils
- 20-year warranty, double the industry standard
- Secondary fuse clips where applicable
- Optional primary fusing
- Molded terminal barriers
- 10-32 screw terminals
- Molded-in terminals
- Phil-slot screws



If you have any questions or we can be of any assistance in helping you determine your transformer requirements, please call our Technical Support Group at:

1-800-664-4660



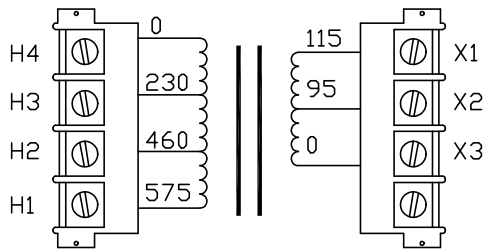

CONNECTION DIAGRAM

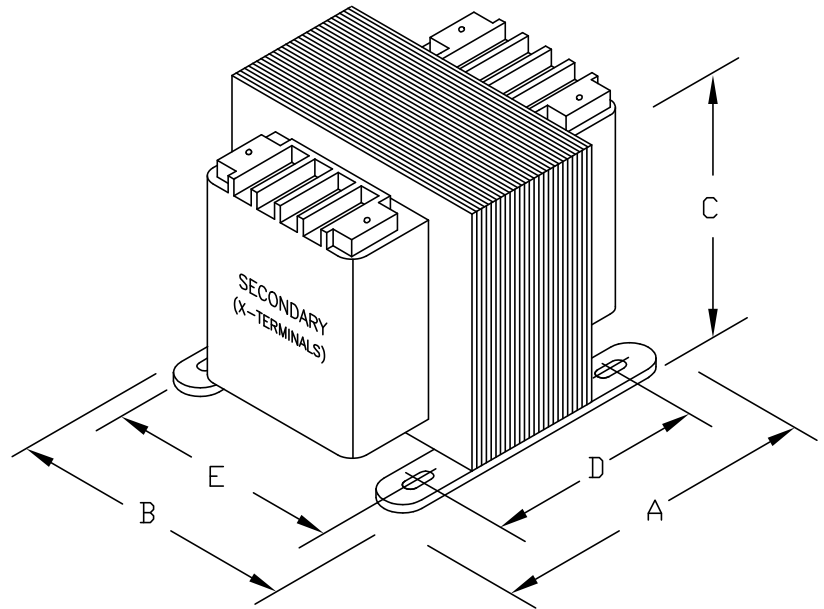

SECONDARY FUSE CLIPS AND PRIMARY JUMPERS NOT APPLICABLE.

DIMENSIONS							APPROX.WT. LBS (KG)
	A	B	C	D	E	MTG. SLOTS	
INCHES (MM)	5.88 (149)	5.25 (133)	4.48 (114)	4.38 (111)	4.38 (111)	0.313X1.063 (8.0X27.0)	21.5 (9.8)



MICRON INDUSTRIES CORPORATION
 777 CHURCH ROAD - ELMHURST, IL 60126
 Tel. (800) 664-4660, (630) 516-1222 Fax (630) 516-1820
 www.MicronTransformers.com

CAT.NO. B500BTW37XX			CONST. ENCAPSULATED			UL LISTED
CATALOG GROUP H			MODEL IMPERVITRAN			
RATING						
OUTPUT AMPS	5.26/4.35	PRIMARY V	230/460/575		TEMP. CLASS	HZ 50/60
VA	500	SECONDARY V	95/115		105°C	REVISION G