

MC-4510-C23

Hardware User's Manual

www.moxa.com/product

Third Edition, October 2010

MOXA[®]

© 2010 Moxa Inc. All rights reserved.
Reproduction without permission is prohibited.

MC-4510-C23

Hardware User's Manual

The software described in this manual is furnished under a license agreement and may be used only in accordance with the terms of that agreement.

Copyright Notice

Copyright © 2010 Moxa Inc.
All rights reserved.
Reproduction without permission is prohibited.

Trademarks

MOXA is a registered trademark of Moxa Inc.
All other trademarks or registered marks in this manual belong to their respective manufacturers.

Disclaimer

Information in this document is subject to change without notice and does not represent a commitment on the part of Moxa.

Moxa provides this document “as is,” without warranty of any kind, either expressed or implied, including, but not limited to, its particular purpose. Moxa reserves the right to make improvements and/or changes to this manual, or to the products and/or the programs described in this manual, at any time.

Information provided in this manual is intended to be accurate and reliable. However, Moxa assumes no responsibility for its use, or for any infringements on the rights of third parties that may result from its use.

This product might include unintentional technical or typographical errors. Changes are periodically made to the information herein to correct such errors, and these changes are incorporated into new editions of the publication.

Technical Support Contact Information

www.moxa.com/support

Moxa Americas:

Toll-free: 1-888-669-2872
Tel: +1-714-528-6777
Fax: +1-714-528-6778

Moxa China (Shanghai office):

Toll-free: 800-820-5036
Tel: +86-21-5258-9955
Fax: +86-21-5258-5505

Moxa Europe:

Tel: +49-89-3 70 03 99-0
Fax: +49-89-3 70 03 99-99

Moxa Asia-Pacific:

Tel: +886-2-8919-1230
Fax: +886-2-8919-1231

Table of Contents

Chapter 1	Introduction	1-1
	Overview.....	1-2
	Package Checklist.....	1-2
	Product Features.....	1-2
	MC-4510-C23 Hardware Specifications.....	1-3
	Hardware Block Diagram	1-5
Chapter 2	Hardware Introduction.....	2-1
	Appearance	2-2
	Dimensions	2-2
	LED Indicators.....	2-3
	Real Time Clock	2-3
Chapter 3	Hardware Connection Description	3-1
	Installing the MC4510-C23	3-2
	Wiring Requirements	3-2
	Connecting the Power	3-3
	Grounding the MC-4510-C23.....	3-3
	Connecting Data Transmission Cables.....	3-4
	Connecting to the Network.....	3-4
	Connecting to a Serial Device	3-5
	Installing a CompactFlash Card.....	3-5
	Connecting a PS/2 Keyboard and Mouse.....	3-7
	Connecting to the USB Device	3-8
	Connecting to a VGA Monitor.....	3-8
	Connecting to a DVI-D Monitor.....	3-9
	Connecting to a Speaker or a Headphone	3-10
	Upgrading the Memory Module	3-10
	Installing a SATA Hard Disk.....	3-12
Chapter 4	BIOS Setup	4-1
	Entering the BIOS Setup Utility	4-2
	Modifying the BIOS Main Settings	4-3
	Basic Configuration.....	4-3
	System Security	4-3
	Advanced Settings	4-4
	Hard Disk Boot Priority.....	4-4
	Advanced BIOS Features	4-5
	CPU Features.....	4-5
	Advanced Chipset Settings.....	4-6
	Peripherals	4-7
	OnChip IDE Device.....	4-8
	Onboard Device.....	4-8
	Super I/O Device	4-9
	Power	4-10
	Wake Up Control	4-10
	Hardware Monitor.....	4-11
	Load Defaults.....	4-11
	Exiting the BIOS Setup.....	4-12
	Upgrading the BIOS	4-13
Appendix A	Regulatory Approval Statement.....	1

1

Introduction

The MC-4510-C23 computer is based on the Intel Core 2 Duo mobile processor and comes with 2 optically isolated RS-232/422/485 serial ports, 2 Gigabit Ethernet ports, 6 USB 2.0 hosts, and a CompactFlash socket, offering high performance and versatile peripherals for marine, railway, power, and other industrial applications.

The MC-4510-C23's rugged and fanless design and 1G anti-vibration and 5G anti-shock make it particularly well-suited for bridge systems in marine applications. In addition, the compact size and low power consumption features ensure an easy installation and reliable system operations, and the modular design allows easy integration with the panel.

Users can easily install Windows 7, Windows XP SP3, Windows XP Embedded, or Windows CE 6.0 to provide a flexible and friendly environment for system development and application implementation.

In this chapter, we cover the following topics:

- Overview
- Package Checklist
- Product Features
- MC-4510-C23 Hardware Specifications
- Hardware Block Diagram

Overview

The MC-4510-C23 computer is based on the Intel Core 2 Duo mobile processor and comes with 2 optically isolated RS-232/422/485 serial ports, 2 Gigabit Ethernet ports, 6 USB 2.0 hosts, and a CompactFlash socket, offering high performance and versatile peripherals for marine, railway, power, and other industrial applications.

Users can easily install Windows 7, Windows XP SP3, Windows XP Embedded, or Windows CE 6.0 to provide a flexible and friendly environment for system development and application implementation.

Package Checklist

The MC-4510-C23 Series includes the following model:

MC-4510-C23:

Industrial computer with Intel Core 2 Duo 2.26 GHz, 2 optically-isolated serial ports, 2 Gigabit LANs, dual displays, CompactFlash, USB, audio

Each model is shipped with the following items:

- 1 MC-4510 embedded computer
- PS/2 to KB/MS Y-type cable
- 2 sets of hard drive cables
- Hard drive ground sticker
- Documentation & Driver CD
- Quick Installation Guide (printed)
- Product Warranty Statement (printed)

NOTE: Please notify your sales representative if any of the above items are missing or damaged.

Product Features

The MC-4510-C23 embedded computer has the following features:

- High performance Intel Core 2 Duo 2.26 GHz processor, 6 MB L2 cache
- Built-in 2 GB DDR3 memory, supporting up to 4 GB
- Dual independent displays (DVI-D + VGA)
- 2 Gigabit Ethernet ports for network redundancy
- 2 optically isolated RS-232/422/485 serial ports
- Onboard mini-PCIe slot reserved for future expansions and upgrades
- 6 USB 2.0 hosts for connecting peripheral devices
- CompactFlash card socket and optional hard disk drive support for storage expansion
- 1G anti-vibration and 5G anti-shock design for system reliability
- Fanless design with compact size
- Low power consumption
- Modular design for integration with Moxa panels
- Supports Windows 7, Windows XP SP3, Windows XP Embedded, and Windows CE 6.0

MC-4510-C23 Hardware Specifications

Computer	
CPU	Intel Core 2 Duo SP9300 2.26 GHz, 6 MB for L2 cache
OS	Windows 7, Windows XP SP3, Windows XP Embedded (Must be installed by the user)
System Chipset	Intel GS45 + ICH9M
DRAM	2 GB DDR3 SDRAM onboard (supports DDR3 up to 4 GB)
USB	USB 2.0 host x 6
Expansion Bus	Mini-PCIe onboard
Storage	
Storage Expansion	CompactFlash socket
HDD Support	2 SATA connectors for HDD expansion
Other Peripherals	
Audio	Line-in/out interface
Display	
Graphics Controller	Intel GS45
VGA Interface	15-pin D-Sub connector x 1(female)
DVI-D Interface	25-pin DVI-D connector x 1 (female)
Ethernet Interface	
LAN	2 auto-sensing 10/100/1000 Mbps ports (RJ45)
Magnetic Isolation Protection	1.5 KV built-in
Serial Interface	
Serial Standards	2 RS-232/422/485 ports, software-selectable (DB9 Male)
Optical Protection	2 KV
Serial Communication Parameters	
Data Bits	5, 6, 7, 8
Stop Bits	1, 1.5, 2
Parity	None, Even, Odd, Space, Mark
Flow Control	RTS/CTS, XON/XOFF, ADDC® (automatic data direction control) for RS-485
Baudrate	50 bps to 921.6 Kbps (supports non-standard baudrates; see user's manual for details)
Serial Signals	
RS-232	TxD, RxD, DTR, DSR, RTS, CTS, DCD, GND
RS-422	TxD+, TxD-, RxD+, RxD-, GND
RS-485-4w	TxD+, TxD-, RxD+, RxD-, GND
RS-485-2w	Data+, Data-, GND
LEDs	
System	System: Storage, Power
LAN	LAN: 10M/Link x 2, 100M/Link x 2 (on connector)
Physical Characteristics	
Housing	Aluminum, sheet metal
Weight	3.75 kg
Dimensions	302 x 70 x 279 mm (11.98 x 2.76 x 10.98 in)
Mounting	wall
Environmental Limits	
Operating Temperature	-10 to 55°C (14 to 131°F)

Operating Humidity	5 to 95% RH
Storage Temperature	-20 to 60°C (-4 to 140°F)
Anti-vibration	<ul style="list-style-type: none"> •0.7 @ DNV 2.4 (Class A), sine wave, 2-100 Hz, 1 Oct./min., 1.5 hr per axis •1 grms @ DNV 2.4, random wave, 3-100 Hz, 2.5 hr per axis •2.1 g @ DNV 2.4 (Class C), sine wave, 2-50 Hz, 1 Oct./min., 1.5 hr per axis
Anti-shock	50 g @ IEC 60068-2-27, half sine wave, 11 ms
Power Requirements	
Input Voltage	18 to 36 VDC (3-pin terminal block)
Power Consumption	48.6 W <ul style="list-style-type: none"> •1.35 A @ 36 VDC •1.96 A @ 24 VDC •2.61 A @ 18 VDC
Regulatory Approvals	
EMC	CE (EN55022 Class B, EN55024-4-2, EN55024-4-3, EN55024-4-4), FCC (Part 15 Subpart B, Class B)
Safety	UL/cUL (UL60950-1, DVN, IEC 60954 (4th), IACS0-E10)
Reliability	
Alert Tools	Built-in buzzer and RTC (real-time clock)
Automatic Reboot Trigger	Built-in WDT (watchdog timer)
Warranty	
Warranty	3 years
Details	See www.moxa.com/warranty

Hardware Block Diagram

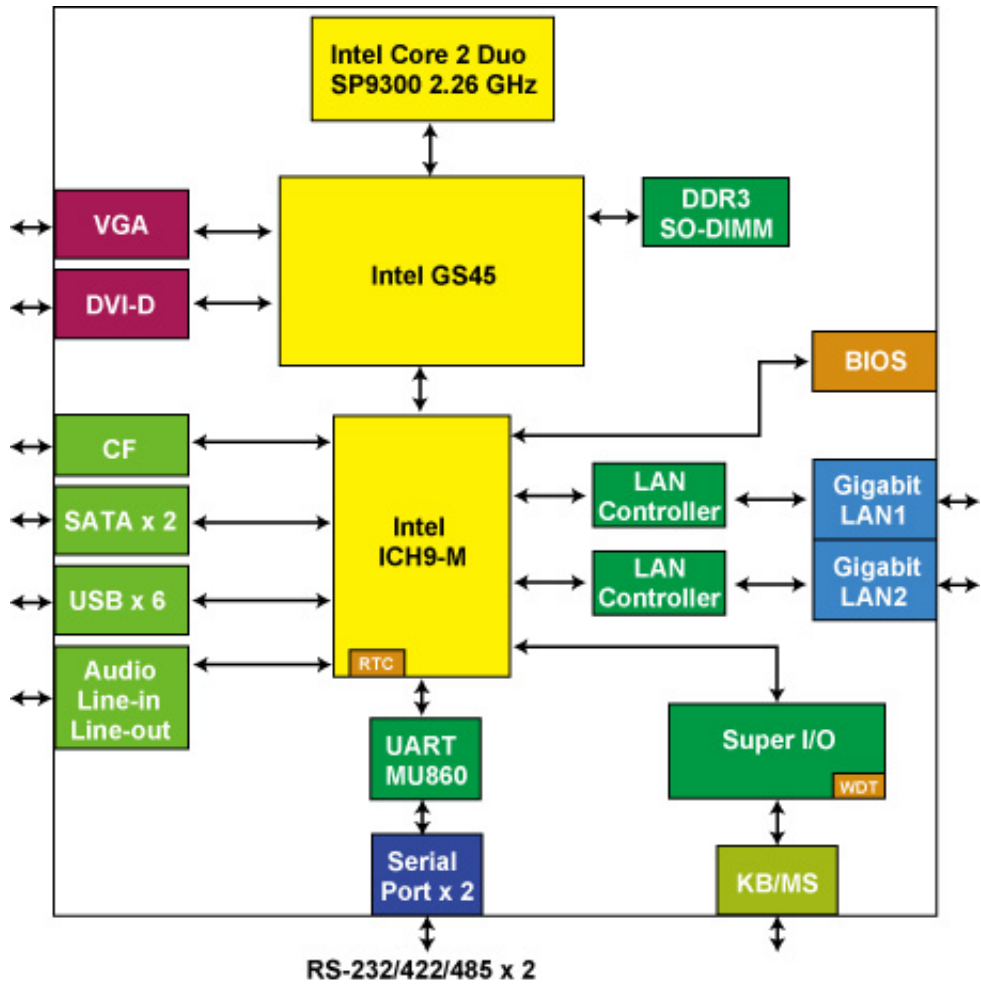

2

Hardware Introduction

The MC-4510-C23 computer is compact, well-designed, and built rugged enough for industrial applications. LED indicators help you monitor performance and identify trouble spots, multiple serial ports allow you to connect different devices for wireless operation, and the reliable and stable hardware platform lets you devote your attention to developing your applications.

In this chapter, we cover the following topics:

- ❑ Appearance
 - MC-4510-C23
- ❑ Dimensions
- ❑ LED Indicators
- ❑ Real Time Clock

Appearance

MC-4510-C23

Front View

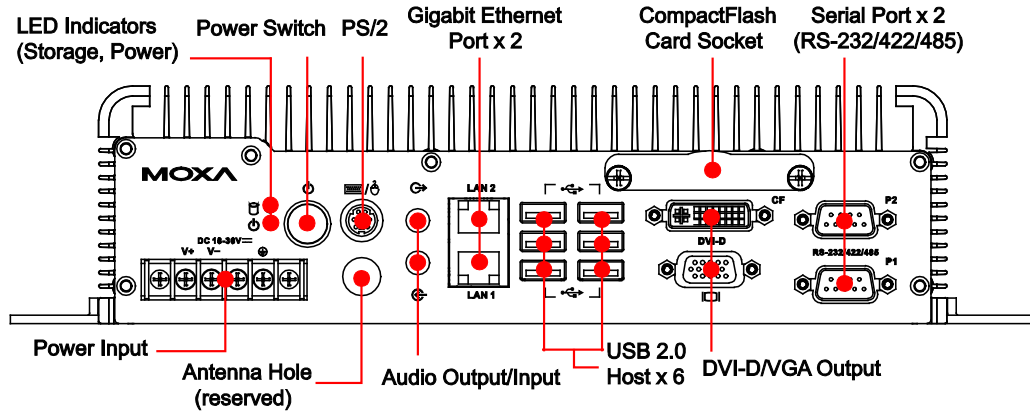

Dimensions

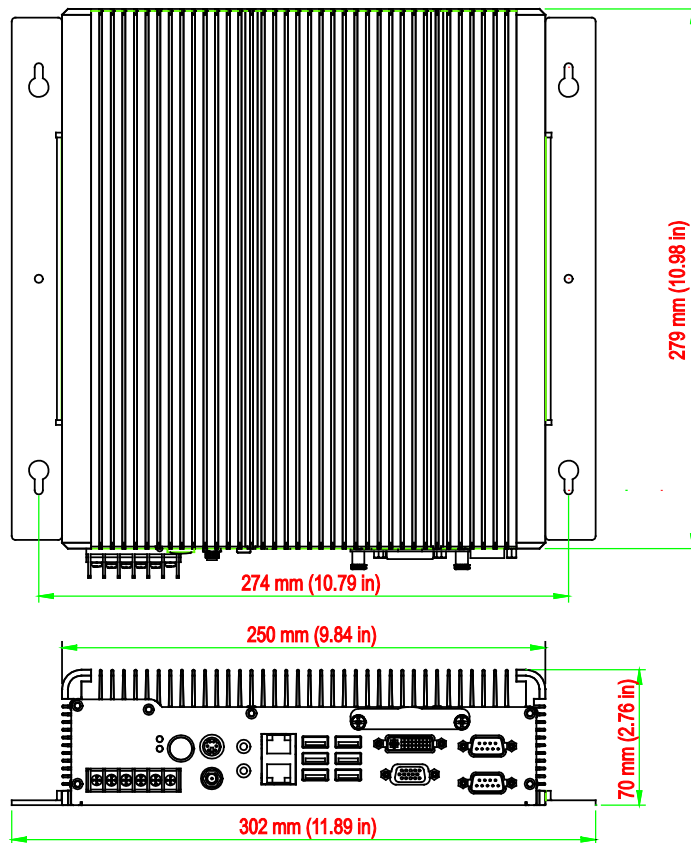

LED Indicators

LED Name	LED Color	LED Function
Power	Green	Power is on and functioning normally
	Off	Power is off or a power error exists
Storage	Yellow (on)	CF card is inserted and detected
	Yellow (blinking)	CF card or HDD is reading/writing
	Off	No activity
LAN	Green	100 Mbps Ethernet mode
	Yellow	1000 Mbps (Gigabit) Ethernet mode
	Off	No activity or 10 Mbps Ethernet mode

Real Time Clock

The embedded computer's real-time clock is powered by a lithium battery. We strongly recommend that you **NOT** replace the lithium battery on your own. If the battery needs to be changed, please contact the Moxa RMA service team.



ATTENTION

There is a risk of explosion if the wrong type of battery is used. To avoid this potential danger, always be sure to use the correct type of battery. Contact the Moxa RMA service team if you need to replace your battery.

Caution

There is a risk of explosion if the battery is replaced by an incorrect type. Dispose of used batteries according to the instructions on the battery.

Hardware Connection Description

In this chapter, we show how to connect the embedded computers to the network and to various devices.

In this chapter, we cover the following topics:

- Installing the MC4510-C23
- Wiring Requirements
- Connecting the Power
- Grounding the MC-4510-C23
- Connecting Data Transmission Cables
 - Connecting to the Network
 - Connecting to a Serial Device
- Installing a CompactFlash Card
- Connecting a PS/2 Keyboard and Mouse
- Connecting to the USB Device
- Connecting to a VGA Monitor
- Connecting to a DVI-I Monitor
- Connecting to a Speaker or a Headphone
- Upgrading the Memory Module
- Installing a SATA Hard Disk

Installing the MC4510-C23

Wall or Cabinet Mounting

The MC-4510-C23 has been pre-installed with two brackets on both ends of the computer. Use two screws per side to attach the MC-4510-C23 to a wall or cabinet.

Step 1: Use two screws for each bracket and attach the bracket to the rear of the MC-4510-C23.

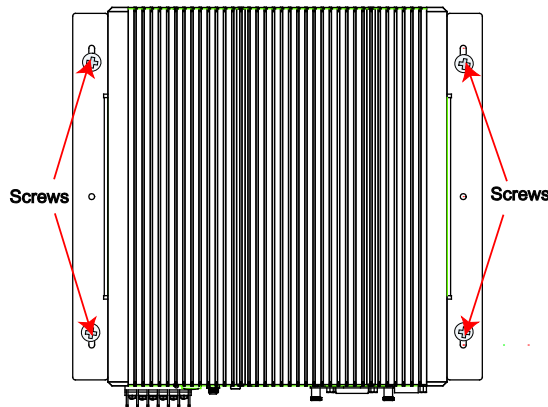

Wiring Requirements

This section describes how to connect serial devices to the embedded computer.

You should read and follow these common safety precautions before proceeding with the installation of any electronic device:

- Use separate paths to route wiring for power and devices. If power wiring and device wiring paths must cross, make sure the wires are perpendicular at the intersection point.

NOTE: Do not run signal or communication wiring together with power wiring in the same wire conduit. To avoid interference, wires with different signal characteristics should be routed separately.

- Use the type of signal transmitted through a wire to determine which wires should be kept separate. The rule of thumb is that wiring that shares similar electrical characteristics can be bundled together.
- Keep input wiring and output wiring separate.
- It is advisable to label the wiring to all devices in the system.



ATTENTION

Safety First!

Be sure to disconnect the power cord before installing and/or wiring your MC-4510-C23.

Wiring Caution!

Calculate the maximum possible current in each power wire and common wire. Observe all electrical codes dictating the maximum current allowable for each wire size.

If the current goes above the maximum ratings, the wiring could overheat, causing serious damage to your equipment.

Temperature Caution!

Be careful when handling the unit. When the unit is plugged in, the internal components generate heat, and consequently the outer casing may feel hot to the touch.

Connecting the Power

The MC-4510-C23 offers 18 to 36 VDC power input with the terminal block. If the power is supplied properly, the Power LED will light up. The OS is ready when the Ready LED glows a solid green.

For safety reasons, please use cables with the following specifications:

Wire range 14-22 AWG, torque 7 lb

Grounding the MC-4510-C23

Grounding and wire routing help limit the effects of noise due to electromagnetic interference (EMI). Run the ground connection from the ground screw to the grounding surface prior to connecting the power.



ATTENTION

This product is intended to be mounted to a well-grounded mounting surface, such as a metal panel.

EG: See the figure shown below for the location of the Earth Ground on the terminal block power connector. Connect the EG wire to an appropriate grounded metal surface.

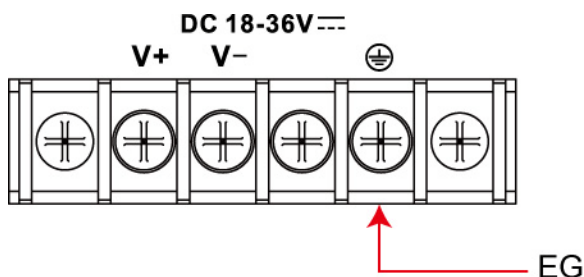

Connecting Data Transmission Cables

This section describes how to connect the MC-4510-C23 computer to the network and serial devices.

Connecting to the Network

Plug your network cable into the embedded computer’s Ethernet port. The other end of the cable should be plugged into your Ethernet network. When the cable is properly connected, the LEDs on the embedded computer’s Ethernet port will glow to indicate a valid connection.

The 10/100/1000 Mbps Ethernet LAN port uses 8-pin RJ45 connectors. The following diagram shows the pinouts for these ports.

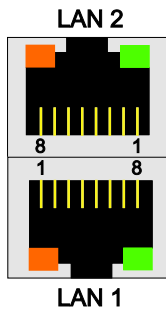

The LED indicators on the right top and right bottom corners glow a solid green color when the cable is properly connected to a 100 Mbps Ethernet network. The LED will flash on and off when Ethernet packets are being transmitted or received.

The LED indicators on the left top and left bottom corners glow a solid yellow color when the cable is properly connected to a 1000 Mbps Ethernet network. The LED will flash on and off when Ethernet packets are being transmitted or received.

Pin	10/100 Mbps	1000 Mbps
1	ETx+	TRD(0)+
2	ETx-	TRD(0)-
3	ERx+	TRD(1)+
4	---	TRD(2)+
5	---	TRD(2)-
6	ERx-	TRD(1)-
7	---	TRD(3)+
8	---	TRD(3)-

Connecting to a Serial Device

Use a serial cable to plug your serial device into the embedded computer's serial port. Serial ports 1 and 2 have male DB9 connectors and can be configured for RS-232, RS-422, or RS-485 communication by software. The pin assignments are shown in the following table:

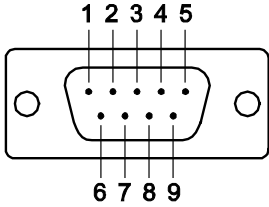
DB9 Male Port		RS-232/422/485 Pinouts				
		Pin	RS-232	RS-422	RS-485 (4-wire)	RS-485 (2-wire)
1	2	DCD	TxDA(-)	TxDA(-)	---	
3	4	RxD	TxDB(+)	TxDB(+)	---	
5	6	TxD	RxDB(+)	RxDB(+)	DataB(+)	
7	8	DTR	RxDA(-)	RxDA(-)	DataA(-)	
9		GND	GND	GND	GND	
		DSR	---	---	---	
		RTS	---	---	---	
		CTS	---	---	---	

Installing a CompactFlash Card

The MC-4510-C23 computer comes with a CompactFlash socket. To insert a CompactFlash card, follow these instructions:

1. Disconnect the MC-4510-C23 from its power source.
2. The CompactFlash socket is located on the right side of the front panel. Unscrew the CompactFlash socket cover.

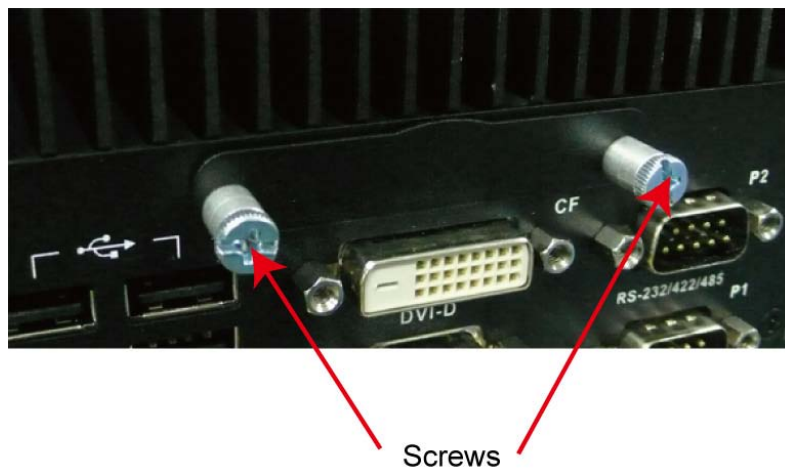

3. There is a tenon/hook on the cover of the CF socket. Turn the CompactFlash card over and then insert the CompactFlash card into the tenon/hook of the CF socket cover.

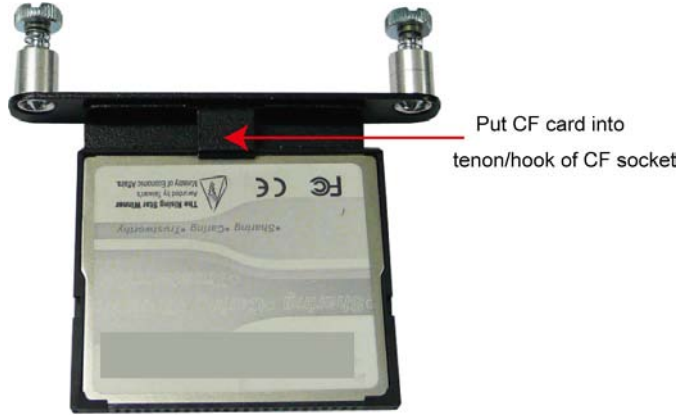

ATTENTION

Be careful of how you orient the CompactFlash card. You should turn the CF card bottom side up, in order to hook CF card into the CF socket cover.

4. Gently insert the CompactFlash card into the CF socket, making sure that the card is oriented correctly.



ATTENTION

The MC-4510-C23 embedded computer does not support the CompactFlash hot swap and PnP (Plug and Play) functions. It is necessary to remove power source first before inserting or removing the CompactFlash card.

Connecting a PS/2 Keyboard and Mouse

Your MC-4510-C23 computer comes with a PS/2 mini-DIN connector to connect to a PS/2 keyboard and PS/2 mouse. This 6-pin mini-DIN connector has the pin assignments shown below.

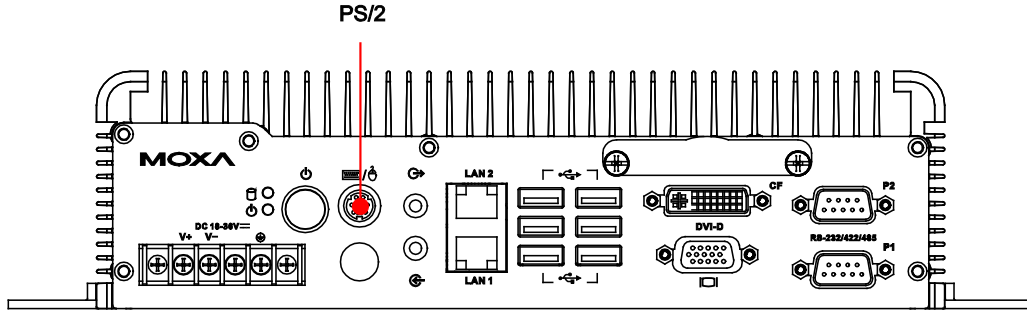

PS/2 Connector	Pin No.	Signal Definition
	1	PS/2 Keyboard Data
	2	PS/2 Mouse Data
	3	GND
	4	VCC
	5	PS/2 Keyboard Clock
	6	PS/2 Mouse Clock

Use the Y-type cable to convert the mini-DIN connector into two 6-pin mini-DIN connectors to connect both a PS/2 keyboard and PS/2 mouse at the same time. You may also use the USB ports to connect your USB-based keyboard and mouse.

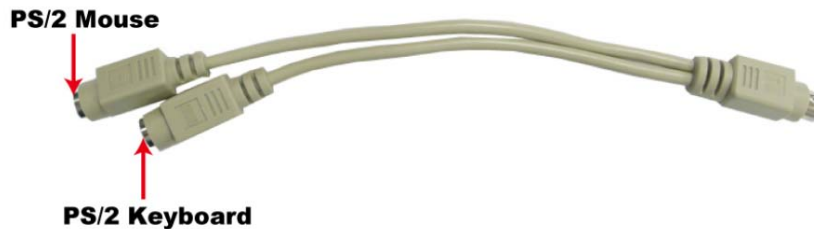

ATTENTION

Please note that without a Y-type cable, the PS/2 connector on the MC-4510-C23 can only work with a PS/2 keyboard. A PS/2 mouse will not function when directly connected to the PS/2 connector on the MC-4510-C23 computer.

Connecting to the USB Device

The MC-4510-C23 comes with 6 USB 2.0 hosts on the front panel.. The hosts can be used for an external flash disk or hard drive for storing large amounts of data. You can also use these USB hosts to connect to a keyboard or a mouse.

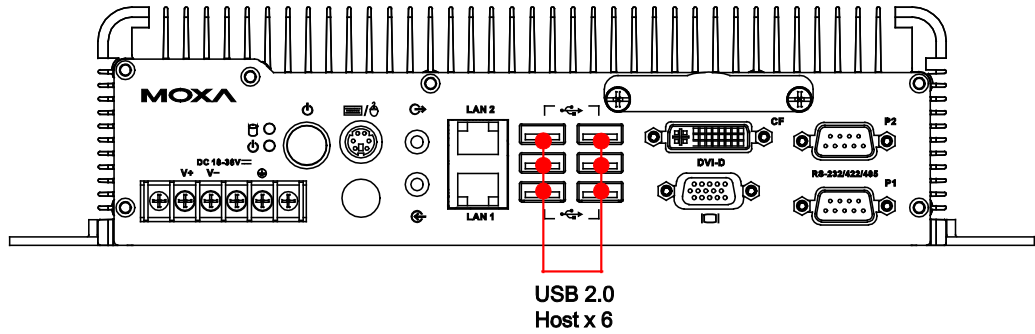

Connecting to a VGA Monitor

The MC-4510-C23 comes with a D-Sub 15-pin female connector on the front panel to connect a VGA CRT monitor. To ensure that the monitor image remains clear, be sure to tighten the monitor cable after connecting it to the MC-4510-C23. The pin assignments of the VGA connector are shown below.

DB15 Female Connector

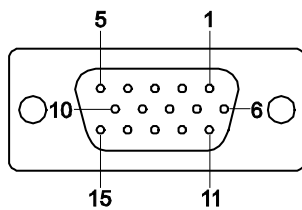

Pin No.	Signal Definition
1	Red
2	Green
3	Blue
4	NC
5	GND
6	GND
7	GND
8	GND
9	VCC
10	GND
11	NC
12	DDC2B Data
13	HSYNC
14	VSYNC
15	DDC2B Clock

Connecting to a DVI-D Monitor

The MC-4510-C23 computers come with a DVI-D connector that can connect to a DVI monitor. Use the cable to connect one end to the DVI-D connector and the other end to the monitor. See the following table for DVI-D connector pin assignments.

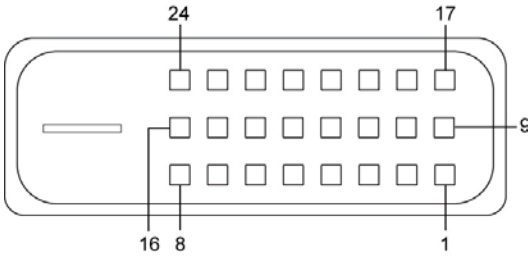
DVI-D Connector	Pin No.	Signal Definition
	1	T.M.D.S. Data2-
	2	T.M.D.S. Data2+
	3	T.M.D.S. Data2 Shield
	4	N/C
	5	N/C
	6	DDC Clock
	7	DDC Data
	8	N/C
	9	T.M.D.S. Data1-
	10	T.M.D.S. Data1+
	11	T.M.D.S. Data1 Shield
	12	N/C
	13	N/C
	14	+5V Power
	15	Ground (return for +5V, HSync, and VSync)
	16	Hot Plug Detect
	17	T.M.D.S. Data0-
	18	T.M.D.S. Data0+
	19	T.M.D.S. Data0 Shield
	20	N/C
	21	N/C
	22	T.M.D.S. Clock Shield
	23	T.M.D.S. Clock+
	24	T.M.D.S. Clock-

Connecting to a Speaker or a Headphone

The MC-4510-C23 comes with audio input and output interfaces for connecting a microphone and speaker or headphones. See the following figure for details.

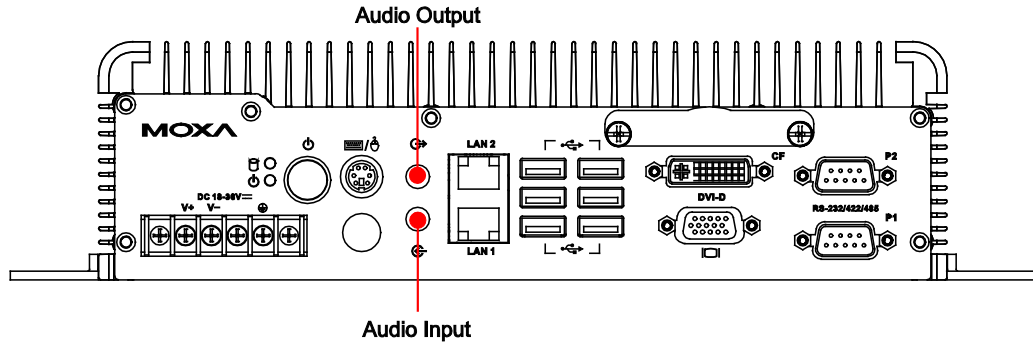

Upgrading the Memory Module

The MC-4510-C23 computer supports two memory sockets that have been installed with 2 GB DDR2 SDRAM modules (1 GB for each socket). To upgrade the DDR3 SDRAM memory module, follow these instructions:

1. Disconnect the MC-4510-C23 from the power source.
2. Remove the nine screws on the back cover. See the following figure for detailed location.

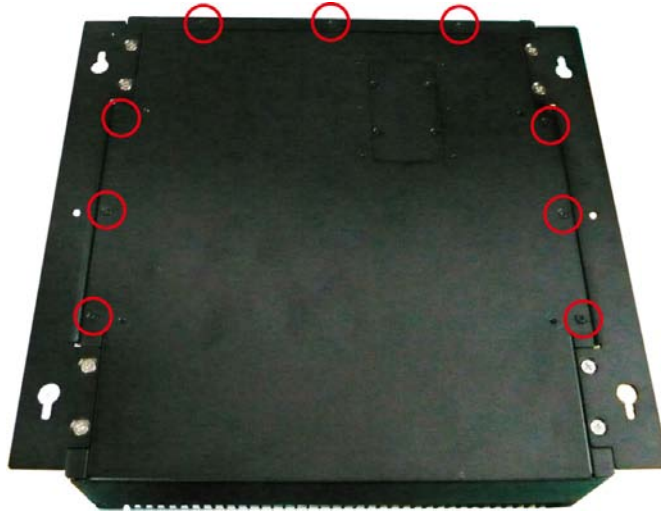

3. Then remove seven screws on the rear cover.

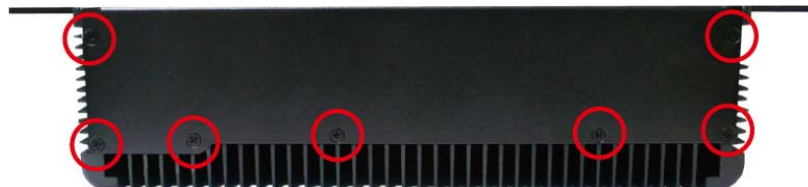

- 4. Remove the back cover of the computer. You will see two HDD brackets inside. The memory module is located below the first HDD bracket.

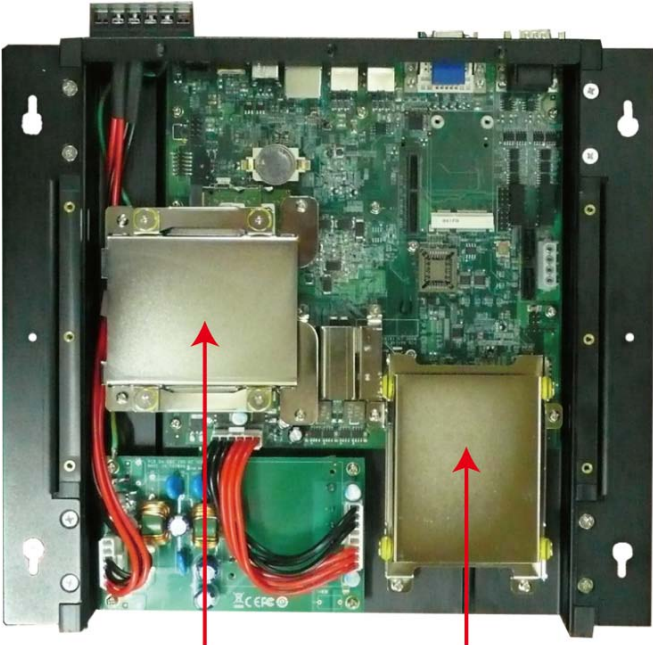

First HDD Bracket Second HDD Bracket

- 5. Remove the four screws of the first HDD bracket. See the following figure for the specific location of the screws.



- After the first HDD bracket has been removed, you can find two memory modules. Carefully remove the module by clicking the clutches at both sides of the module, and then replace the new module. Be sure to orient the module correctly.

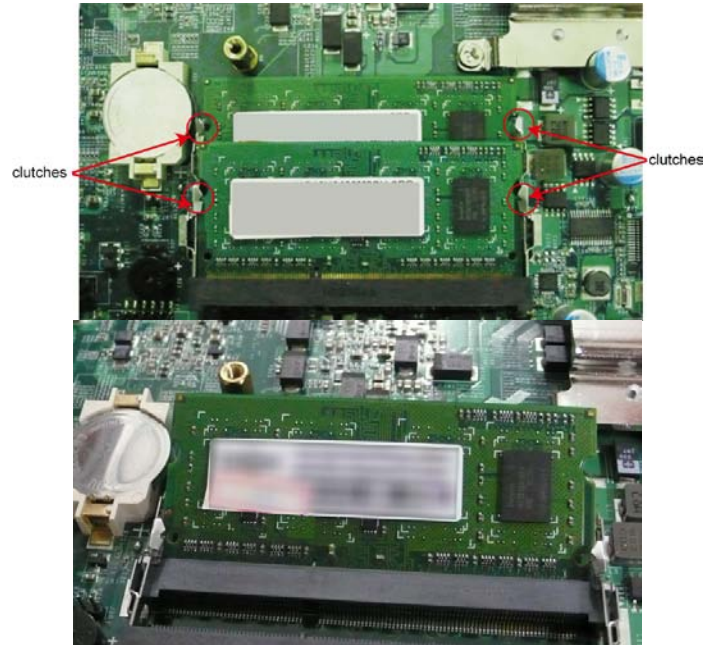

- When finished, replace the first HDD bracket and the back cover of the computer.

Installing a SATA Hard Disk

The MC-4510-C23 has two SATA connectors for installing two SATA hard disks. To install the 2.5-inch SATA hard disks, follow these instructions.

After removing the back cover of the computer, find the HDD brackets in the following figure. Please note that you can install your hard disk onto either HDD bracket. However, if you would like to install an SSD type disk, we suggest you have it installed on the second HDD bracket.

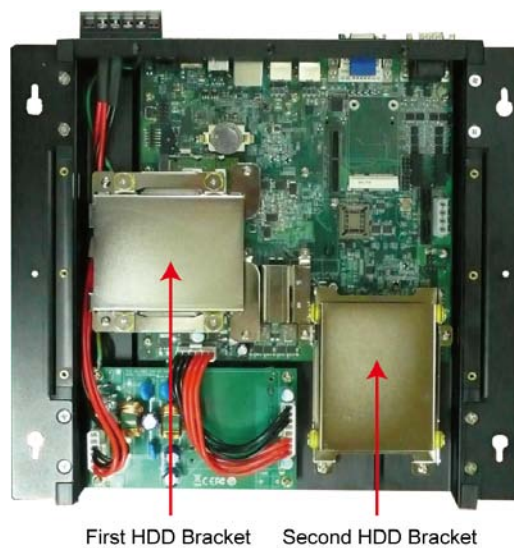

Installing the Hard Disk on the First HDD Bracket

1. Remove the four screws on the first HDD bracket.



2. Remove two black screws on each side of the bracket, and then take off the cover.



3. Place the hard disk on the bracket. Use the four screws to fasten the hard disk at both sides of the bracket.



- When finished, place the bracket on the computer, and use four screws to fasten the bracket. Next, find the location of the power connect and the SATA connectors. There is one power connector which can be used by two SATA hard disks, and there are two SATA connectors for connecting two SATA disks.



- Connect the power cable to the power connector and the SATA cable to the SATA connector.



- When finished, use the ground sticker to attach the hard drive disk and the bracket. Make sure that the metal parts of the hard drive disk and the bracket have been attached. If you are using a solid state drive (SSD), you don't need to attach this sticker.

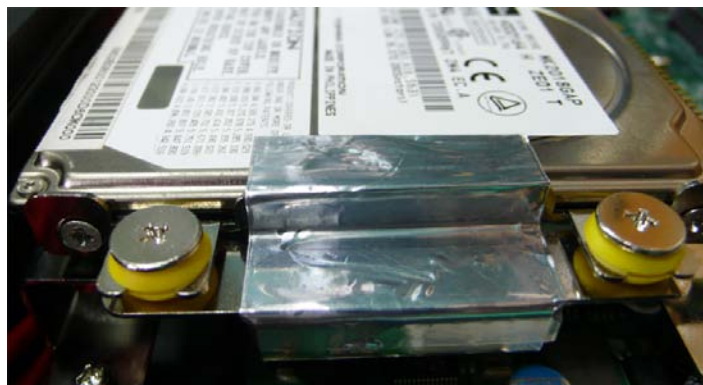

Installing the Hard Disk on the Second HDD Bracket

1. Remove the four screws on the second HDD bracket.



2. Remove two black screws on each side of the bracket, and then take off the cover.



3. Place the hard disk on the bracket. Use the four screws to fasten the hard disk at both sides of the bracket.

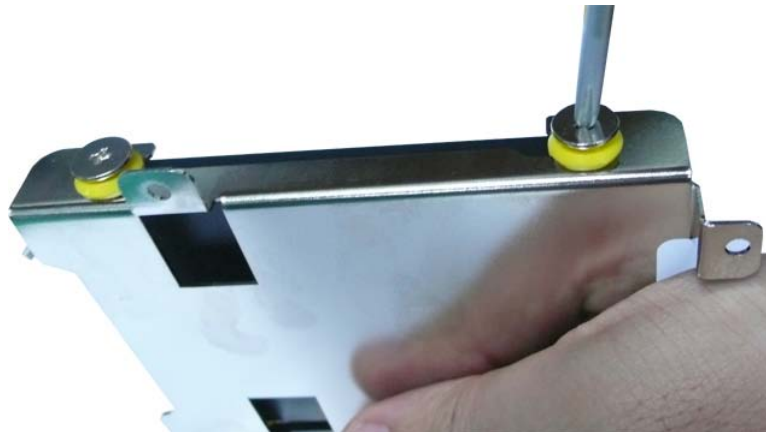

- When finished, place the bracket on the computer, and use four screws to fasten the bracket. Next, connect the SATA cable to the SATA connector, and the power cable to the power connector.



- When you finish installing two hard disks on the computer, replace the back cover of the computer, and fasten the screws.
- When finished, use the ground sticker to attach the hard drive disk and the bracket. Make sure that the metal parts of the hard drive disk and the bracket have been attached. If you are using a solid state drive (SSD), you don't need to attach this sticker.



4

BIOS Setup

This chapter describes the BIOS settings of the MC-4510-C23 computer. The BIOS is a set of input/output control routines for peripherals. The BIOS is used to initialize basic peripherals and helps boot the operating system before the operating system is loaded. The BIOS setup allows the user to modify the system configurations of these basic input/output peripherals. All of the configurations will be stored in the battery backed up CMOS RAM, which retains the system information after system reboots or the power is removed.

This chapter covers the following topics:

- Entering the BIOS Setup Utility
- Modifying the BIOS Main Settings
 - Basic Configuration
 - System Security
- Advanced Settings
 - Hard Disk Boot Priority
 - Advanced BIOS Features
 - CPU Features
 - Advanced Chipset Settings
- Peripherals
 - OnChip IDE Device
 - Onboard Device
 - Super I/O Device
- Power
- Wake Up Control
- Hardware Monitor
- Load Defaults
- Exiting the BIOS Setup
- Upgrading the BIOS

Entering the BIOS Setup Utility

To enter the BIOS setup utility, press the “Del” key while the system is booting up. The main BIOS Setup screen will appear.

A basic description of each function key is listed at the bottom of the screen. Refer to these descriptions to learn how to scroll about the screen, how to select by pressing “Enter,” and how to use the other hot keys listed below.

F1: General Help

F5: Previous Value

F6: Default Settings

F7: Turbo Settings

F10: Save

ESC: Exit

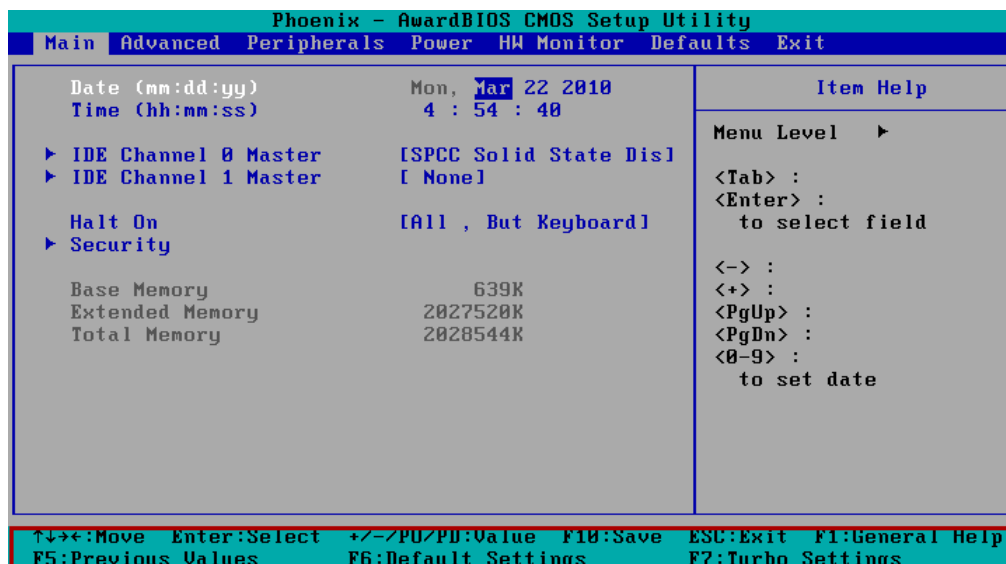

Modifying the BIOS Main Settings

Basic Configuration

After entering the BIOS Setup, or choosing the “Main” option, the BIOS main menu will be displayed. Use this menu to check the basic system information such as memory and IDE hard drive. You can also use the menu for configuring basic system parameters, such as date, time, hard drive, display, and system security.

System Security

To set up system security, select the “Security” option under “Main” to bring up the following screen.

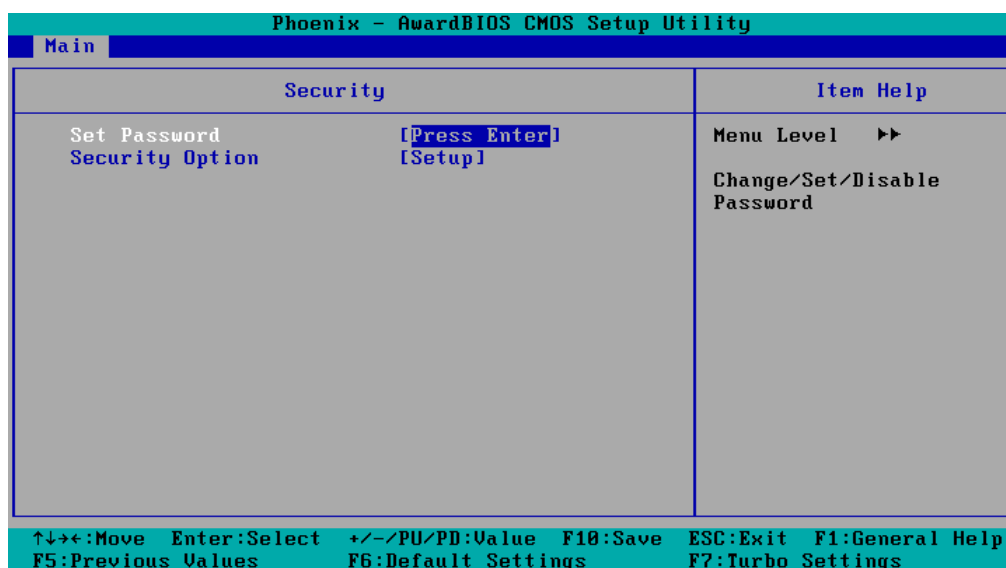

This menu includes two options: “Set Password” and “Security Option.”

When you select the Set Password option, a pop-up “Enter Password:” window will appear on the screen. The password that you type will replace the password stored in the CMOS memory. You will be required to confirm the new password. Just re-type the password and then press <Enter>. You may also press <Enter> to abort the selection and not enter a password.

To clear an existing password, just press <Enter> when you are prompted to enter the password. A message will show up confirming that the password will be disabled. Once the password is disabled, the system will boot and you can enter the “BIOS Setup Menu” without entering a password.

Once a password has been set, you will be prompted to enter the password each time you enter Setup. This prevents unauthorized persons from changing any part of your system configuration. In addition, when a password setting is enabled, you can set up the BIOS to request a password each time the system is booted up. The “Security Option” setting determines when a password prompt is required. If the “Security Option” is set to “System,” the password must be entered both at boot up and when entering the BIOS Setup Menu. If the password is set for “Setup,” the password prompt only occurs when you enter the “BIOS Setup Menu.”

Advanced Settings

The “Advanced Features” screen will appear when choosing the “Advanced” item from the main menu.

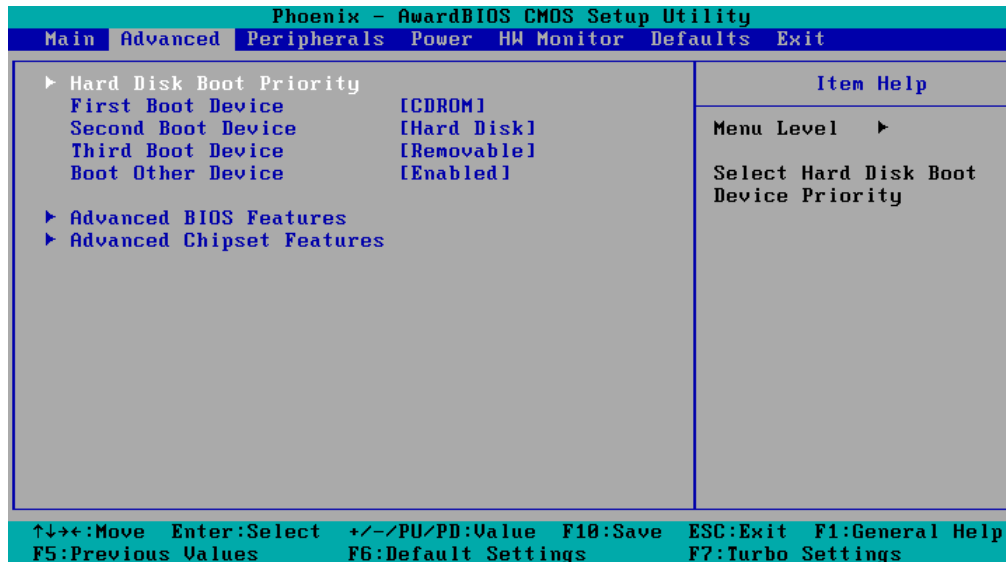

Hard Disk Boot Priority

First/Second/Third Boot Device

This option allows users to select or change the device boot priority. You may set 3 levels of priority to determine the boot up sequence for different bootable devices, such as a hard drive, CD-ROM, and removable devices. Select the order in which devices will be searched in order to find a boot device. The available options are “CDROM (default for first boot device),” “Removable” (default for third boot device), “Hard Disk” (default for second boot device) and “Disabled.”

Advanced BIOS Features

When you select the “Advanced BIOS Features” option under the “Advanced” menu, the following configuration menu will appear.

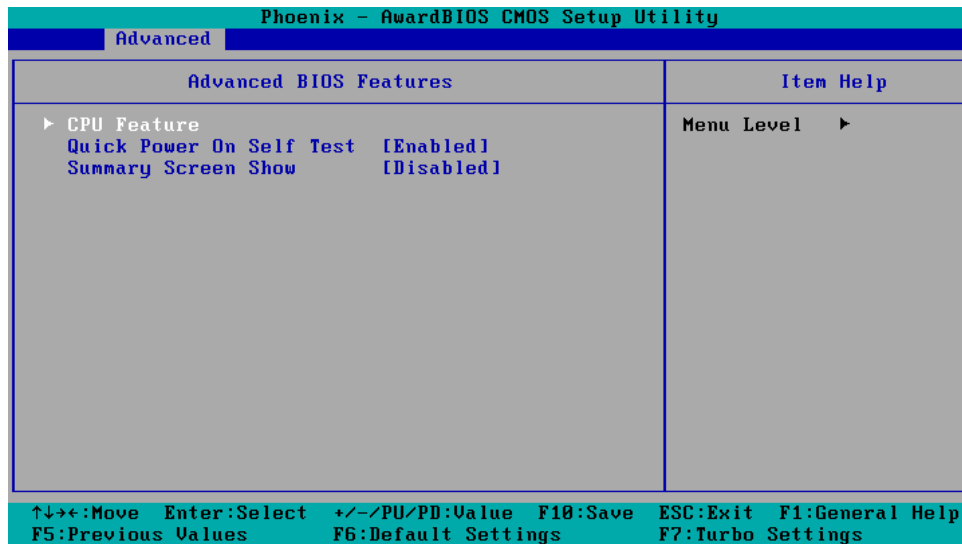

CPU Features

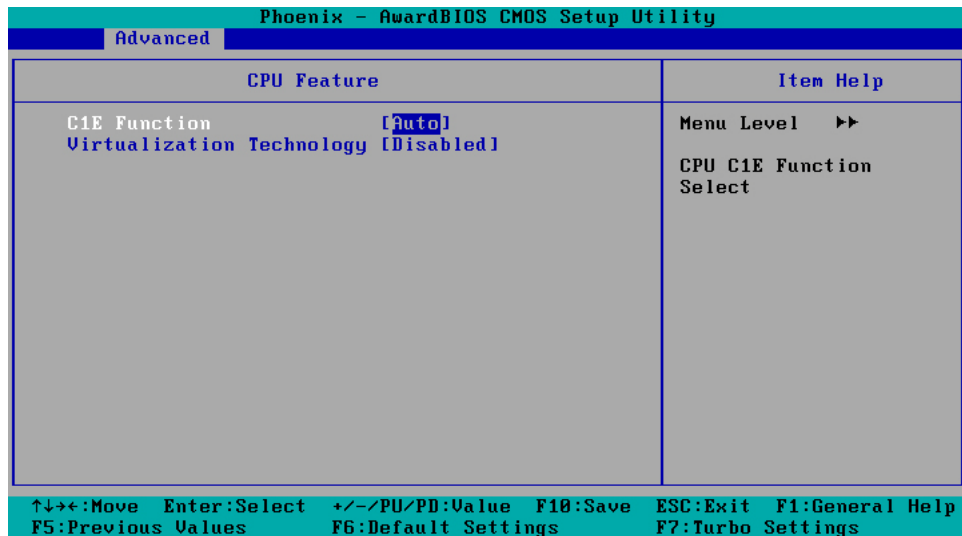

C1E Function

This item allows you to configure the power-saving mode when the CPU is in C1 status.

Options: Auto (default), Disabled

Virtualization Technology

This item allows you to enable or disable the Virtualization Technology

Options: Enabled, Disabled (default)

Quick Power On Self Test

This setting allows the system to skip certain tests while the system boots up. Enable this feature to speed up the boot up process.

Options: Enabled (default), Disabled

Summary Screen Show

The summary screen displays system information, including CPU, memory, disk drive, and PCI devices. The default value is disabled. You may choose "Enabled" to display this screen when the system is booting up.

Options: Disabled (default), Enabled

Advanced Chipset Settings

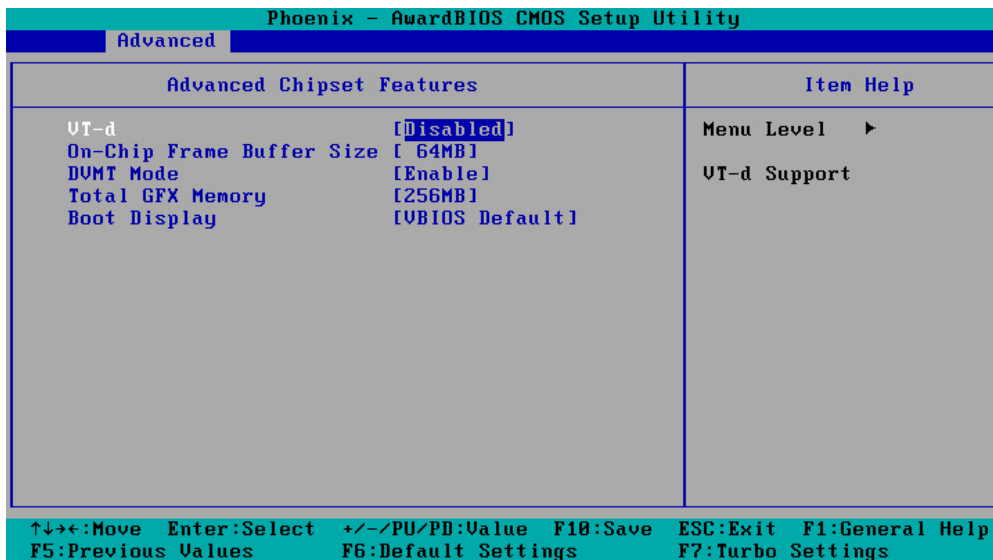

VT-d

This item allows you to enable or disable the VT-d function.

Options: Enabled, Disabled (default)

On-chip Frame Buffer Size

This item determines the frame buffer size for the VGA function, and will share the system memory.

Options: 32MB, 64MB (default), 128MB

DVMT Mode

Sets the Dynamic Video Memory Technology operating mode. When set to "Fixed," the graphics driver will reserve a fixed portion of the system memory as graphics memory. When set to "DVMT," the graphics driver will dynamically allocate system memory as graphics memory, according to system and graphics requirements. When set to "BOTH," the graphics driver will allocate a fixed amount of memory as dedicated graphics memory, as well as allow more system memory to be dynamically allocated between the graphics processor and the operating system.

Options: Enable (default), Disable

Total GFX Memory

Sets the maximum amount of system memory that can be allocated as graphics memory.

Options: 128 MB, 256 MB (default), MAX.

Boot Display

This item allows you to choose which display interface will be shown when system is booting up. Due to the display limitation, two displays at most can be shown when booting up. If you select the default option, "VBIOS Default", the displays that have been connected will be used as the default displays.

Options: VBIOS Default (default), CRT, EFP1, EFP2, CRT+EFP1, CRT+EFP2

Peripherals

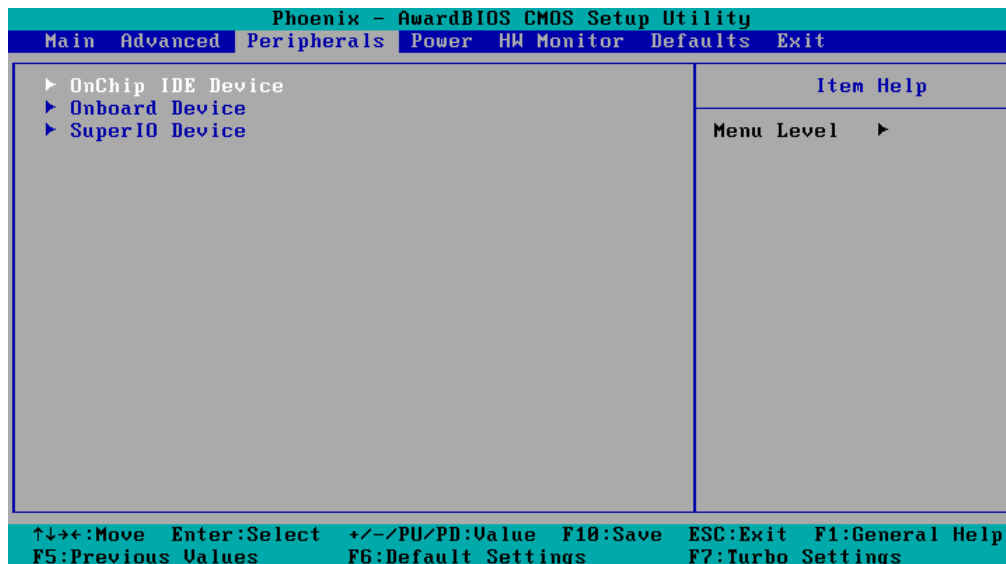

OnChip IDE Device

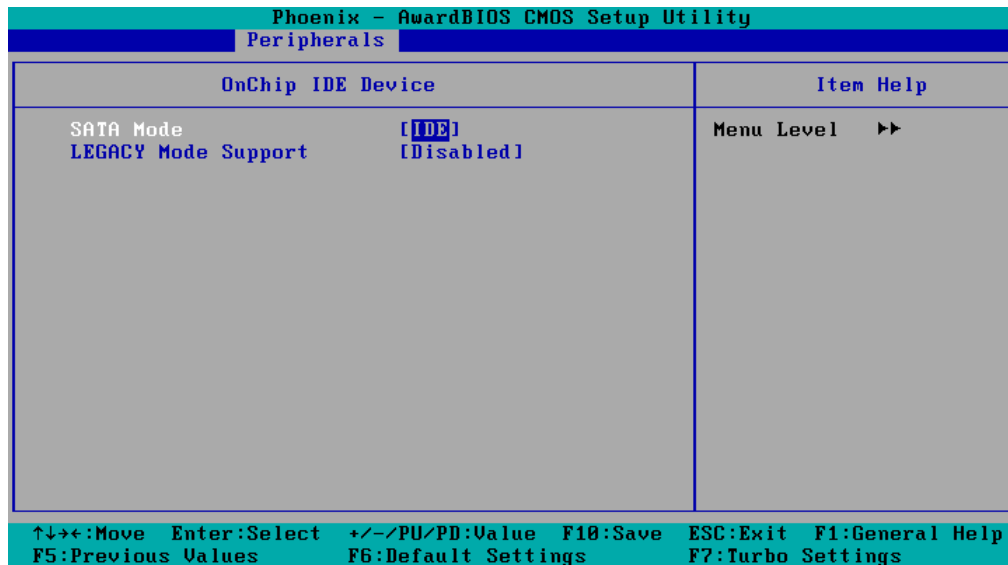

SATA Mode

This item allows you to select the IDE mode or AHCI mode for your SATA hard disk..

Options: IDE (default), AHCI

Legacy Mode Support

This item allows you to enable or disable the legacy USB device.

Options: Disabled (default), Enabled

Onboard Device

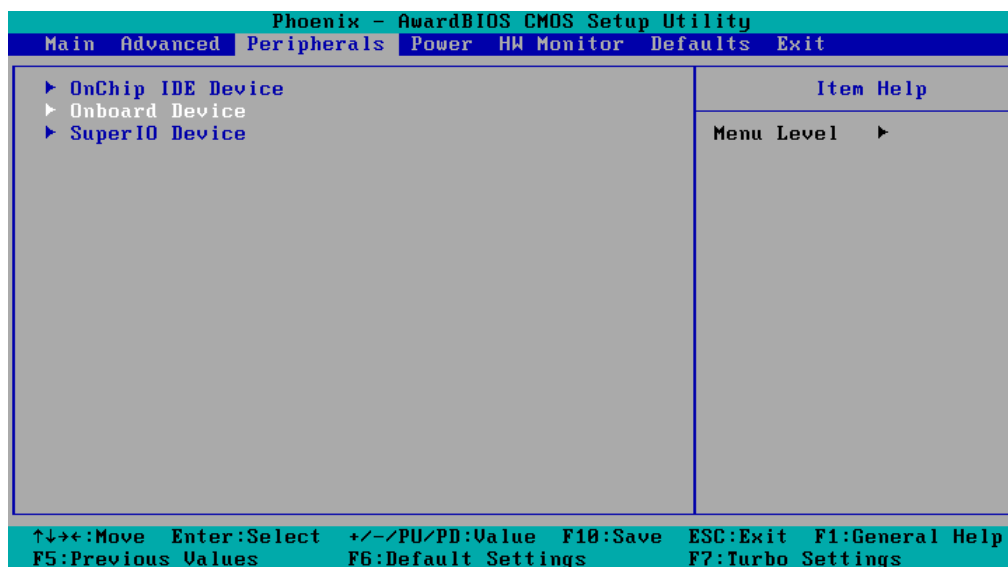

Onboard LAN Boot ROM

Decide whether to invoke the boot ROM of the onboard LAN chip.

Options: Enabled, Disabled (default)

Super I/O Device

Debug Port

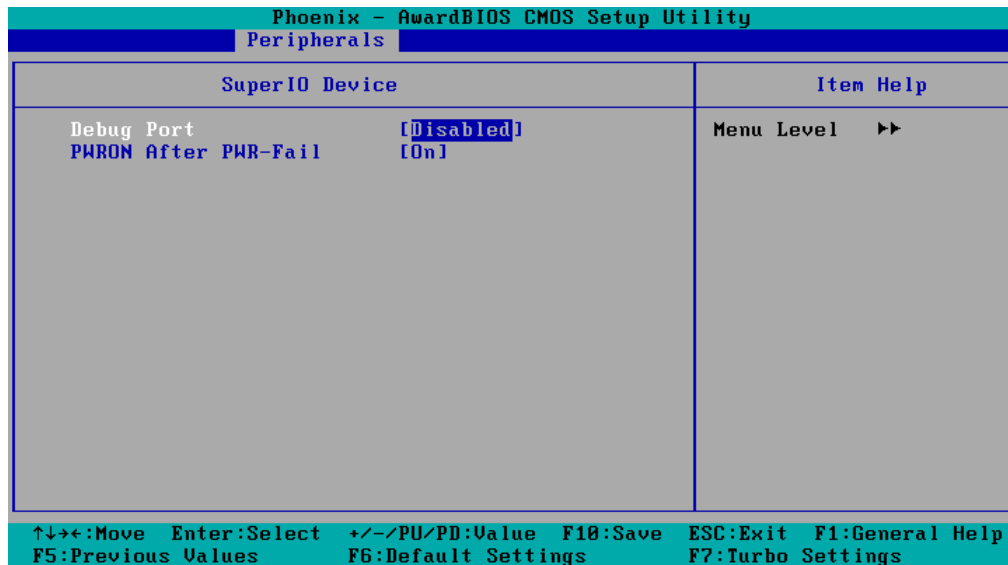

This function allows you to enable/disable the debug port communication. This port is only for engineers who are debugging program.

Options: Disabled (default), Enabled

Power on After Power Fail

This item allows you to configure the power on after power fail function.

Options: Off, On (default), Former-Sts

Power

The Power Setup Menu allows you to configure your system power-up/ power-down options.

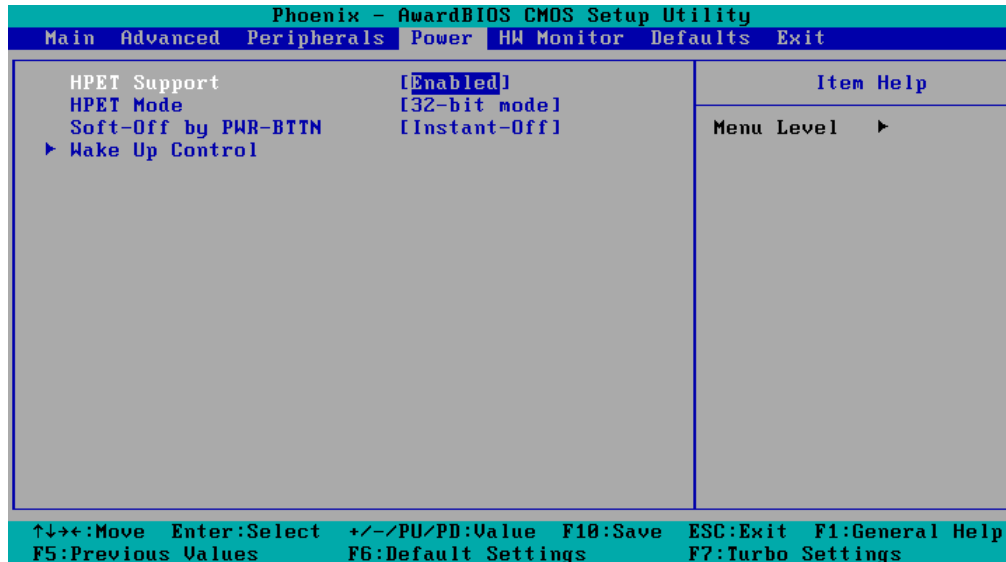

HPET Support

This item allows you to enable/disable the HPET (High Precision Event Timer) function.

Option: Enabled (default), Disabled

HPET Mode

This item allows you to select the HPET mode.

Option: 32-bit mode (default), 64-bit mode

Soft-Off by PWR-BTTN

This item determines the delay to stop the software when pushing the power button.

Options: Instant-Off (default), Delay 4 Sec.

Wake Up Control

RTC Wake Up

This item allows you to enable/disable the RTC wake up function.

Options: Disabled (default), Enabled

Hardware Monitor

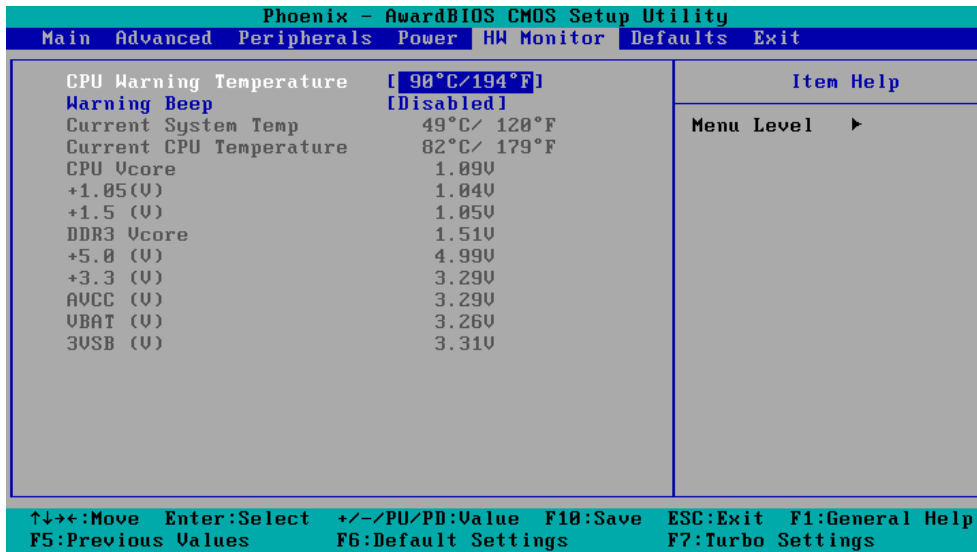

This item helps monitor the status of the system, including CPU temperature and the voltage of the CPU, SDRAM and battery.

CPU Warning Temperature

This item allows you to configure what temperature will trigger a high temperature warning.

Options: 80°C/176°F, 90°C/194°F (default), 100°C/212°F, Disabled

Warning Beep

This item allows you to enable/disable the warning beep.

Options: Disabled (default), Enabled

Load Defaults

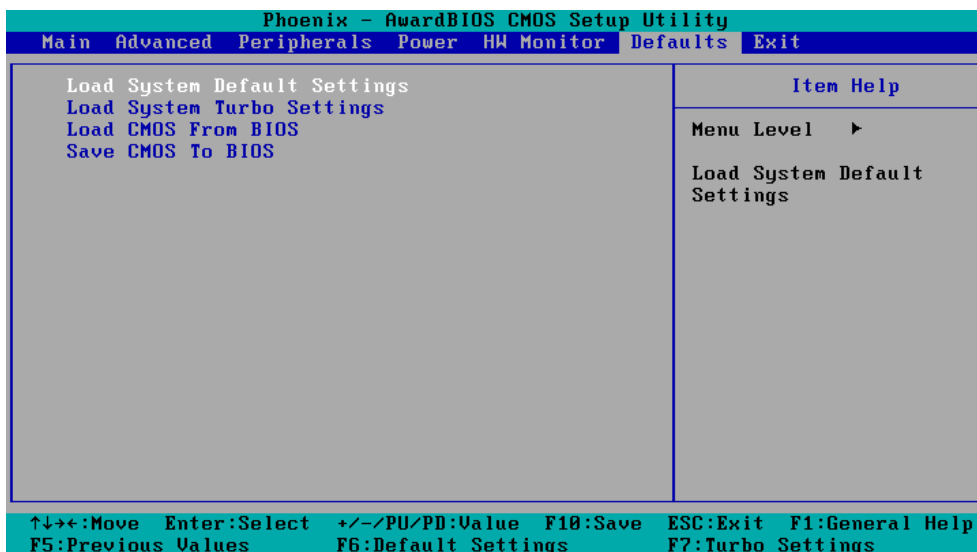

Load System Default Settings

Use this option to load system factory default settings instead of the current BIOS settings. This option is useful for when the system is unstable. Users do not need to remember what settings were active before the system fails.

Load System Turbo Settings

Use this option to load system optimized settings. If the system is not stable, please load the system default settings.

Load CMOS from BIOS

Use this option to load BIOS settings from flash ROM to CMOS.

Save CMOS to BIOS

Use this option to save the BIOS settings from the CMOS to flash ROM.

Exiting the BIOS Setup

To exit the BIOS setup utility, choose "Exit." Pressing <ESC> will achieve the same result.

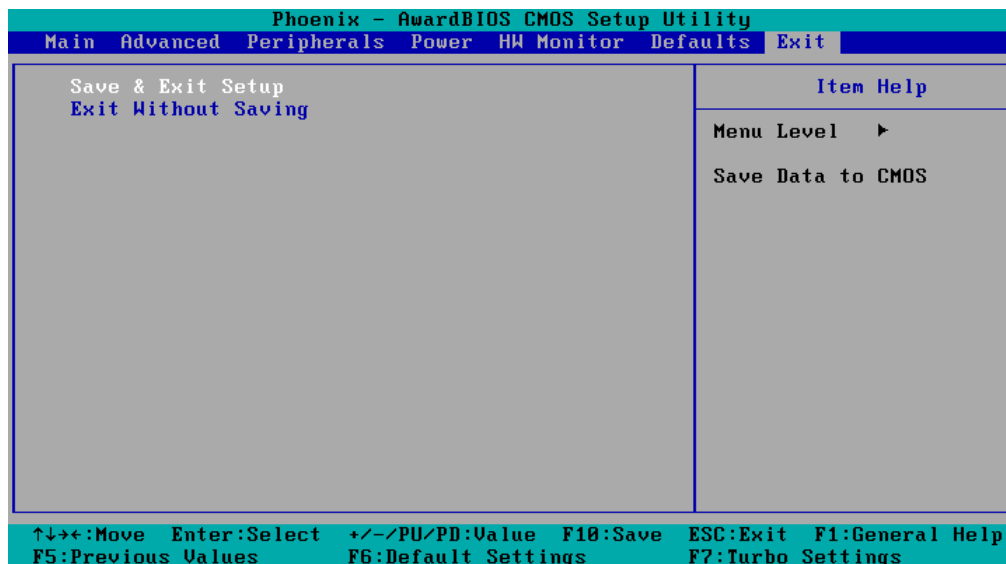

Save & Exit Setup

Save all configuration changes to CMOS (memory) and exit setup. A confirmation message will be displayed before proceeding.

Exit Without Saving

Abandon all changes made during the current session and exit setup. A confirmation message will be displayed before proceeding.

Upgrading the BIOS

This section describes how to upgrade the BIOS. However, please note that upgrading the BIOS involves high risk of damage to your computer. We strongly recommend that you contact Moxa's TS staff for assistance and obtain all necessary tools and files before attempting to upgrade.

Step 1: Create a Bootable USB Disk.

We suggest you use the HP USB Disk Format Tool to create a bootable USB disk. You may download this tool from the Internet. Search the Internet using the phrase "HP USB Disk Storage Format Tool", and then download the tool from one of the listed websites.

You will also need to download the FreeDos system files **kernel.sys** and **command.com** from <http://www.freedos.org/kernel/>.

1. Copy DOS system files **kernel.sys** and **command.com** to a specified directory (**C:\FreeDOS** in this example).
2. Start the HP USB Disk Storage Format Tool and select the USB device that you want to use as a bootable disk in the **Device** drop down box.
3. Select **FAT** in the **File system** drop down box.
4. Type the disk name in the **Volume label field**.
5. Check the option **Create a DOS startup disk** under format options.
6. Specify the directory of the system files (for example, **C:\FreeDOS**).
7. Click **Start** to format and create the USB disk.

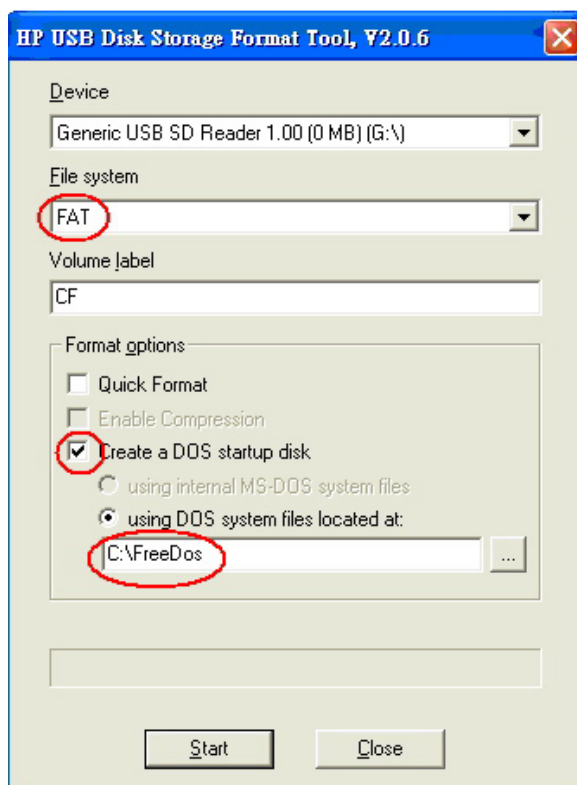

**ATTENTION**

We suggest you use a USB drive with under 2 GB in disk space, as larger USB drives may not support FAT file format and consequently fail to boot.

Step 2: Prepare the Upgrade Tool and BIOS Binary File.

You must use the BIOS upgrade installation file to upgrade the BIOS. You can download it from the Moxa Download Center at:

http://web4.moxa.com/support/download_center.asp

1. Get the BIOS upgrade installation file. The file name should have following format: **451010.s02**.
2. Copy the file to the Bootable USB Disk.
3. Double click to extract the BIOS update installation file. The file includes a binary file in the form **s451010.s02** and the upgrade utility named **awdflash.exe**.

Step 3: Set up the BIOS to Boot from the USB Disk.

1. Insert the USB disk.
2. Power on and press **DEL** to enter the BIOS Setup menu.
3. Select **Advanced** → **Hard Disk Boot Priority** and then press **Enter**.
4. From the Setup menu, use “↑” or “↓” to select the USB device.

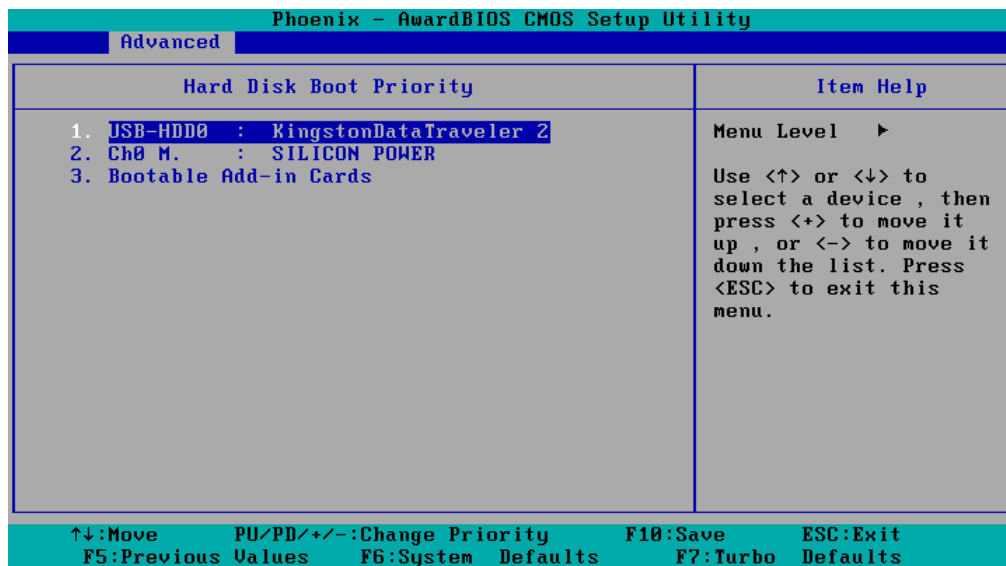

5. Press “+” to move it up to the first priority, and press “Esc” to exit the setup menu.

6. Make sure the first boot device is **Hard Disk**. If it isn't, press **Enter** to change it.

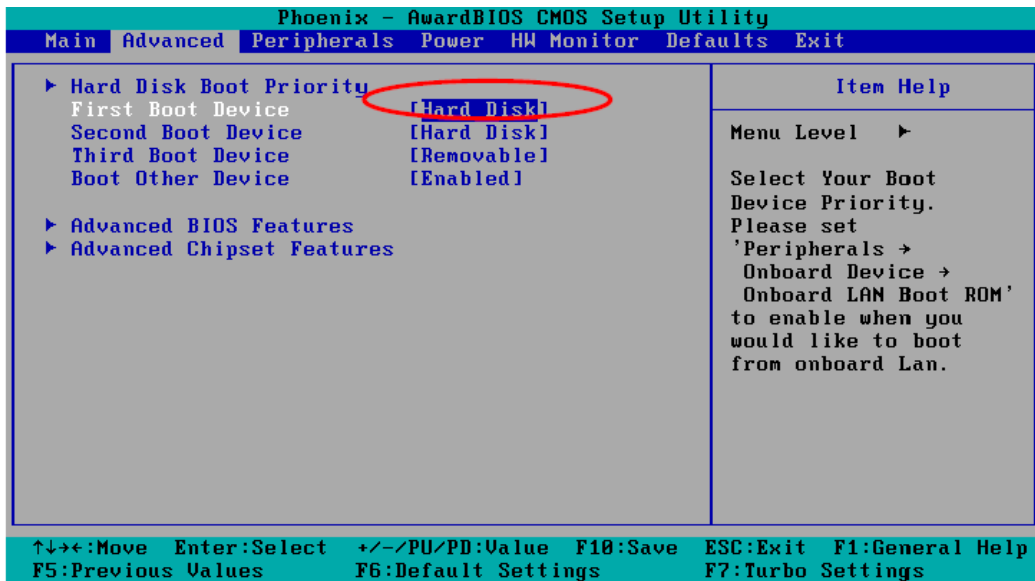

7. Select **Exit** → **Save & Exit Setup** and then press **Enter**.
8. Choose **Y** to save to the CMOS and then exit.

Step 4: Run awdf flash.exe to upgrade the BIOS.

1. While in the BIOS Setup menu and before upgrading the BIOS, you may choose to save the old BIOS files to a specific location. Type **Y** to do so, or **N** to begin the upgrade.
2. If the BIOS Setup is correct, it will restart and boot from the USB disk.
3. Run **awdf flash 451010.s02** from the command line to upgrade the BIOS. Replace xxxxxxx.Sxx with the BIOS binary file name discussed in Step 2.
4. Press **F1** to reset the system after the bios update is complete. The system should reboot at this time.

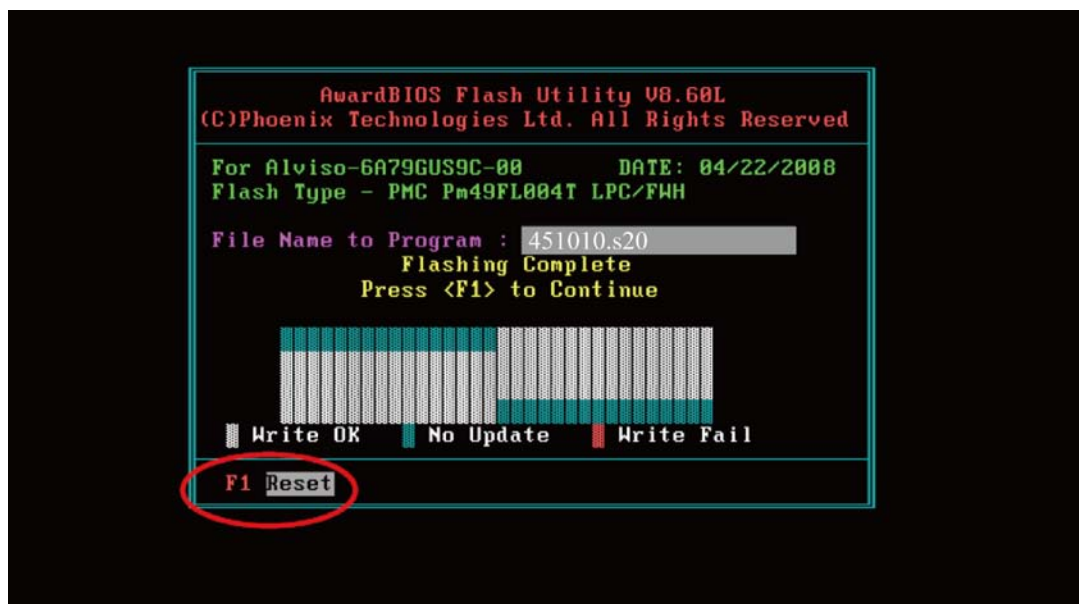

5. Please note that once the BIOS is successfully upgraded, the default BIOS values will be automatically loaded. However, if you wish to re-configure the BIOS settings, press **DEL** while booting.

**ATTENTION**

Do **NOT** switch off the power supply during the BIOS upgrade, since doing so may cause the system to crash.

A

Regulatory Approval Statement



This device complies with part 15 of the FCC Rules. Operation is subject to the following two conditions: (1) This device may not cause harmful interference, and (2) this device must accept any interference received, including interference that may cause undesired operation.

Class A : FCC Warning! This equipment has been tested and found to comply with the limits for a Class A digital device, pursuant to part 15 of the FCC Rules. These limits are designed to provide reasonable protection against harmful interference when the equipment is operated in a commercial environment. This equipment generates, uses, and can radiate radio frequency energy and, if not installed and used in accordance with the instruction manual, may cause harmful interference to radio communications. Operation of this equipment in a residential area is likely to cause harmful interference in which case the user will be required to correct the interference at his own expense.



European Community

Warning:

This is a class A product. In a domestic environment this product may cause radio interference in which case the user may be required to take adequate measures.