

# MC-5150-AC/DC User's Manual

---

Second Edition, July 2012

[www.moxa.com/product](http://www.moxa.com/product)



© 2012 Moxa Inc. All rights reserved.

# MC-5150-AC/DC User's Manual

The software described in this manual is furnished under a license agreement and may be used only in accordance with the terms of that agreement.

## Copyright Notice

© 2012 Moxa Inc., All rights reserved.

## Trademarks

The MOXA logo is a registered trademark of Moxa Inc.  
All other trademarks or registered marks in this manual belong to their respective manufacturers.

## Disclaimer

Information in this document is subject to change without notice and does not represent a commitment on the part of Moxa.

Moxa provides this document as is, without warranty of any kind, either expressed or implied, including, but not limited to, its particular purpose. Moxa reserves the right to make improvements and/or changes to this manual, or to the products and/or the programs described in this manual, at any time.

Information provided in this manual is intended to be accurate and reliable. However, Moxa assumes no responsibility for its use, or for any infringements on the rights of third parties that may result from its use.

This product might include unintentional technical or typographical errors. Changes are periodically made to the information herein to correct such errors, and these changes are incorporated into new editions of the publication.

## Technical Support Contact Information

[www.moxa.com/support](http://www.moxa.com/support)

### **Moxa Americas**

Toll-free: 1-888-669-2872  
Tel: +1-714-528-6777  
Fax: +1-714-528-6778

### **Moxa Europe**

Tel: +49-89-3 70 03 99-0  
Fax: +49-89-3 70 03 99-99

### **Moxa China (Shanghai office)**

Toll-free: 800-820-5036  
Tel: +86-21-5258-9955  
Fax: +86-21-5258-5505

### **Moxa Asia-Pacific**

Tel: +886-2-8919-1230  
Fax: +886-2-8919-1231

# Table of Contents

<b>1. Introduction</b>	<b>1-1</b>
Overview	1-2
Package Checklist	1-2
Product Features	1-2
Hardware Specifications	1-3
Hardware Block Diagram	1-4
<b>2. Hardware Introduction</b>	<b>2-1</b>
Appearance	2-2
AC/DC Model Front View	2-2
AC Model Rear View	2-2
DC Model Rear View	2-3
Dimensions	2-3
LED Indicators	2-4
Real Time Clock	2-4
<b>3. Hardware Connection Description</b>	<b>3-1</b>
Installing the MC-5150-AC/DC	3-2
Wiring Requirements	3-2
Connecting the Power	3-3
Grounding the MC-5150-AC/DC	3-3
Connecting Data Transmission Cables	3-3
Connecting to the Network	3-3
Connecting to a Serial Device	3-4
Connecting a PS/2 Keyboard and Mouse	3-4
Connecting to the USB Device	3-5
Connecting to a VGA Monitor	3-5
Connecting to a DVI-I Monitor	3-5
Connecting to a Speaker or a Headphone	3-6
Installing the Removable SATA Hard Disk	3-6
Installing the Internal SATA Hard Disk	3-7
Upgrading the Memory Module	3-9
<b>4. BIOS Setup</b>	<b>4-1</b>
Entering the BIOS Setup Utility	4-2
Main Information	4-2
Modifying the BIOS Main Settings	4-3
Advanced Settings	4-3
Boot Configuration	4-3
Peripheral Configuration	4-4
IDE Configuration	4-5
Thermal Configuration	4-7
Intelligent Power Sharing	4-8
Video Configuration	4-8
USB Configuration	4-9
Chipset Configuration	4-10
Hardware Monitor	4-10
Security Settings	4-11
Set Supervisor Password	4-11
Set User Password	4-11
Power Settings	4-12
Advanced CPU Control	4-12
Boot Settings	4-13
Quick Boot	4-13
PXE Boot to LAN	4-13
ACPI Selection	4-13
USB Boot	4-13
WDT Timeout	4-13
Boot Redirection	4-14
Legacy	4-14
Exit Settings	4-15
Exit Saving Changes	4-15
Save Change Without Exit	4-15
Exit Discarding Changes	4-15
Load Optimal Defaults	4-15
Load Custom Defaults	4-15
Save Custom Defaults	4-15
Discard Changes	4-16
Upgrading the BIOS	4-16
<b>A. Regulatory Approval Statement</b>	<b>A-1</b>

<b>B. Adjusting the Audio Mixer Function.....</b>	<b>B-1</b>
<b>C. Smart Recovery.....</b>	<b>C-3</b>
Changing OS Configurations and Enable Check Point Function .....	C-3
Recovery Procedure .....	C-5
Check the Following Items for Hard Disk Recovery .....	C-11
Check the Following Items for LAN Recovery .....	C-12

## Introduction

---

The MC-5150-AC/DC computer is based on the Intel Core™ i5 520E processor and comes with 4 serial ports, 2 Gigabit Ethernet ports, 6 USB hosts, 8 NMEA ports , and offers high performance and versatile peripherals for various industrial applications.

The MC-5150-AC/DC's rugged and fanless design and 1G anti-vibration make it particularly well-suited for bridge systems in marine applications. In addition, the compact size and low power consumption features ensure an easy installation and reliable system operations, and the modular design allows easy integration with the panel.

Users can easily install Windows 7, Windows XP SP3, Windows XP Embedded to provide a flexible and friendly environment for system development and application implementation.

The following topics are covered in this chapter:

- ❑ **Overview**
- ❑ **Package Checklist**
- ❑ **Product Features**
- ❑ **Hardware Specifications**
- ❑ **Hardware Block Diagram**

## Overview

The MC-5150-AC/DC series computer is based on the Intel Core™ i5 520E processor and comes with 4 serial ports, 2 Gigabit Ethernet ports, 6 USB hosts, 8 NMEA ports, and offers high performance and versatile peripherals for marine applications.

Users can easily install Windows 7, Windows XP SP3, and Windows XP Embedded to provide a flexible and friendly environment for system development and application implementation.

## Package Checklist

The MC-5150-AC/DC Series includes the following model:

### **MC-5150-AC/DC:**

x86 ready-to-run computers with Intel Core™ i5 520E, 4 serial ports, 2 Gigabit Ethernet ports, 6 USB hosts, 8 NMEA ports, storage, VGA/DVI

Each model is shipped with the following items:

- MC-5150-AC/DC embedded computer
- 2 removable storage protection keys
- 8 screws for internal and removable HDD
- Terminal block for power input (DC model only)
- 8 terminal blocks for NMEA ports
- Documentation and software CD
- Quick installation guide (printed)
- Warranty card

**NOTE** Please notify your sales representative if any of the above items are missing or damaged.

## Product Features

The MC-5150-AC/DC embedded computer has the following features:

- High performance Intel Core™ i5 520E processor, 3 MB L2 cache
- Built-in 2 GB DDR3 memory, supports up to 4 GB
- Dual independent displays (DVI-I + VGA)
- 2 Gigabit Ethernet ports for network redundancy
- 2 RS-232/422/485 serial ports
- 2 RS-232 ports
- 8 NMEA ports
- 6 USB 2.0 hosts
- 1 internal SATA storage slot for SSD
- 1 removable drive tray for SSDs or disk drives
- 1G anti-vibration design for system reliability
- Fanless design with compact size
- 24 VDC or 100 to 240 VAC power input models available
- Supports Windows XP Embedded, Windows XP SP3, Windows 7

# Hardware Specifications

## Computer

**CPU:** Intel® Core™ i5 520E (BGA CPU package), 2.4 GHz processor

**OS:** Windows 7, Windows XP SP3, Windows XP Embedded (must be installed by the user)

**System Chipset:** Intel® QM57 Express Chipset

**DRAM:** 2 GB DDR3 SDRAM onboard

**USB:** USB 2.0 hosts x 6, Type A connectors

## Storage

### Storage Support:

- 1 internal SATA storage device tray for solid state or hard disk drives (SSD recommended)
- 1 removable (front panel) SATA storage device tray for SSDs or HDDs (SSD recommended)

## Other Peripherals

**KB/MS:** 2 PS/2 interfaces supporting standard PS/2 keyboard and mouse

**Audio:** line-in/out interface

## Display

**Graphics Controller:** Onboard Intel® HD graphics

### Display Interface:

- VGA Interface: 15-pin D-Sub connector (female), with resolution up to 1920 x 1080
- DVI-I Interface: 29-pin DVI-I connector (female)

## Ethernet Interface

**LAN:** 2 auto-sensing 10/100/1000 Mbps ports (RJ45)

**Magnetic Isolation Protection:** 1.5 KV built in

## Serial Interface

### Serial Standards:

- 2 RS-232/422/485 ports, software-selectable (DB9 male)
- 2 RS-232 ports (DB9)
- 8 NMEA ports (Phoenix 3.81 mm compatible connector)

## Serial Communication Parameters

**Data Bits:** 5, 6, 7, 8

**Stop Bits:** 1, 1.5, 2

**Parity:** None, Even, Odd, Space, Mark

**Flow Control:** RTS/CTS, XON/XOFF, ADDC® (automatic data direction control) for RS-485

**Baudrate:** 50 bps to 230.4 Kbps

## Serial Signals

**RS-232:** TxD, RxD, DTR, DSR, RTS, CTS, DCD, GND

**RS-422:** TxD+, TxD-, RxD+, RxD-, GND

**RS-485-4w:** TxD+, TxD-, RxD+, RxD-, GND

**RS-485-2w:** Data+, Data-, GND

## LEDs

**System:** Storage, Power

**LAN:** 100M/Link x 2, 1000M/Link x 2 (on connector)

## Physical Characteristics

**Housing:** Aluminum, sheet metal

**Weight:** 6.85 kg

**Dimensions:** 287 x 250 x 140 mm (11.30 x 9.84 x 5.51 in)

**Mounting:** Wall

**Environmental Limits**

**Operating Temperature:** -15 to 55°C (5 to 131°F)

**Storage Temperature:** -20 to 60°C (-4 to 131°F)

**Ambient Relative Humidity:** 5 to 95% (non-condensing)

**Anti-vibration:**

- 0.7 g @ DNV 2.4 (Class A), sine wave, 2-100 Hz, 1 Oct./min., 1.5 hr per axis
- 1 grms @ DNV 2.4, random wave, 3-100 Hz, 2.5 hr per axis
- 2.1 g @ DNV 2.4 (Class C), sine wave, 2-50 Hz, 1 Oct./min., 1.5 hr per axis

**Power Requirements**

**Input Voltage:**

- DC Model: 24 VDC (with tolerance from 18 to 30 VDC, 2-pin terminal block)
- AC Model: 100 to 240 VAC

**Power Consumption:** Less than 100 W, 2.5 A @ 24 VDC

**Standards and Certifications**

**Safety:** UL 60950-1, DNV 2.4 (Pending), IEC 60945 (4th) (Pending), IACS-E10 (Pending), CCC (GB4943, GB9254, GB17625.1)

**EMC:** EN 55022 Class B, EN 55024-4-2, EN 55024-4-3, EN 55024-4-4, FCC Part 15 Subpart B Class B

**Marine:** IEC 60945 4th. (Pending), IACS-E10 (Pending)

**Green Product:** RoHS, cRoHS, WEEE

**Warranty**

**Warranty Period:** 3 years

**Details:** See [www.moxa.com/warranty](http://www.moxa.com/warranty)

# Hardware Block Diagram

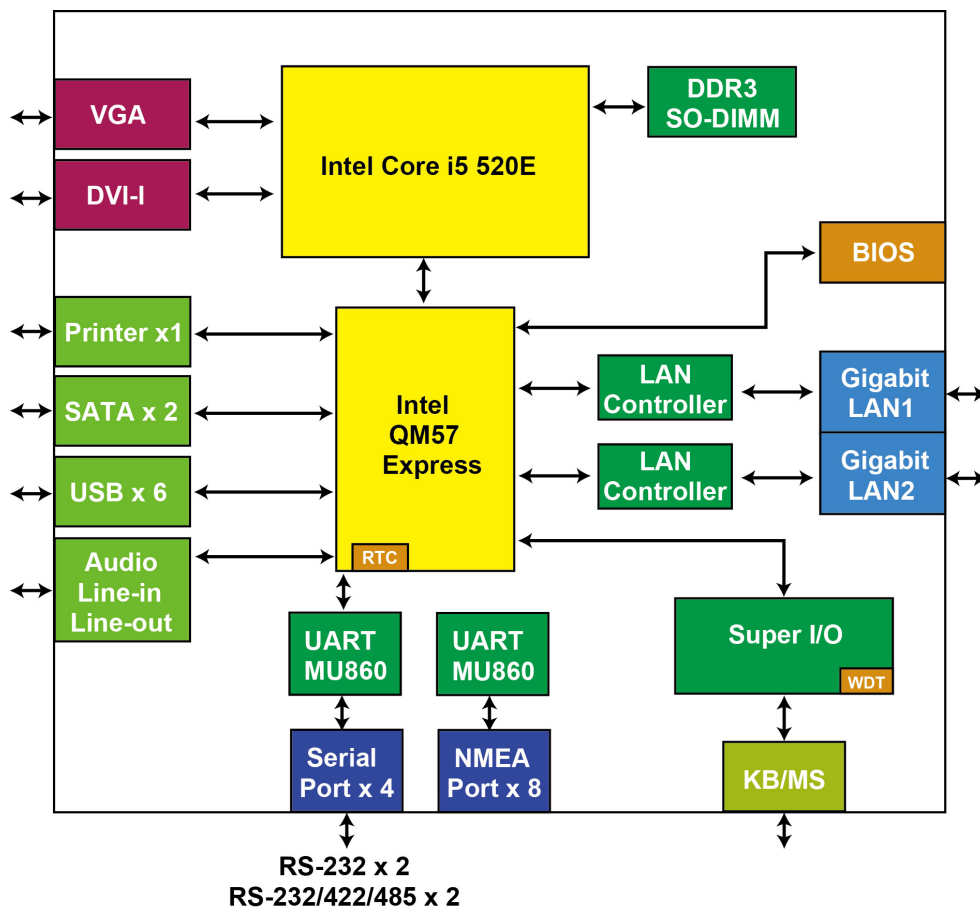



## Hardware Introduction

---

The MC-5150-AC/DC computer is compact, well-designed, and built rugged enough for industrial applications. LED indicators help you monitor performance and identify trouble spots, multiple serial ports allow you to connect different devices for wireless operation, and the reliable and stable hardware platform lets you devote your attention to developing your applications.

The following topics are covered in this chapter:

❑ **Appearance**

- AC/DC Model Front View
- AC Model Rear View
- DC Model Rear View

❑ **Dimensions**

❑ **LED Indicators**

❑ **Real Time Clock**

# Appearance

## AC/DC Model Front View

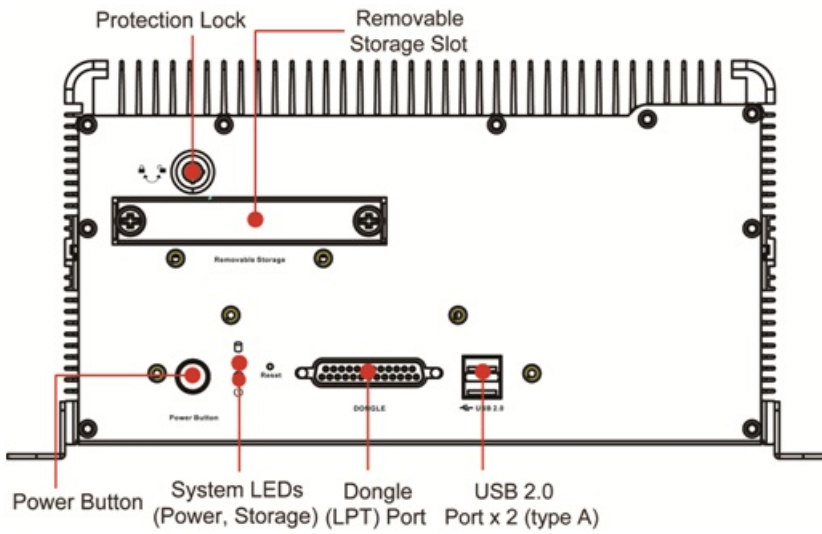

## AC Model Rear View

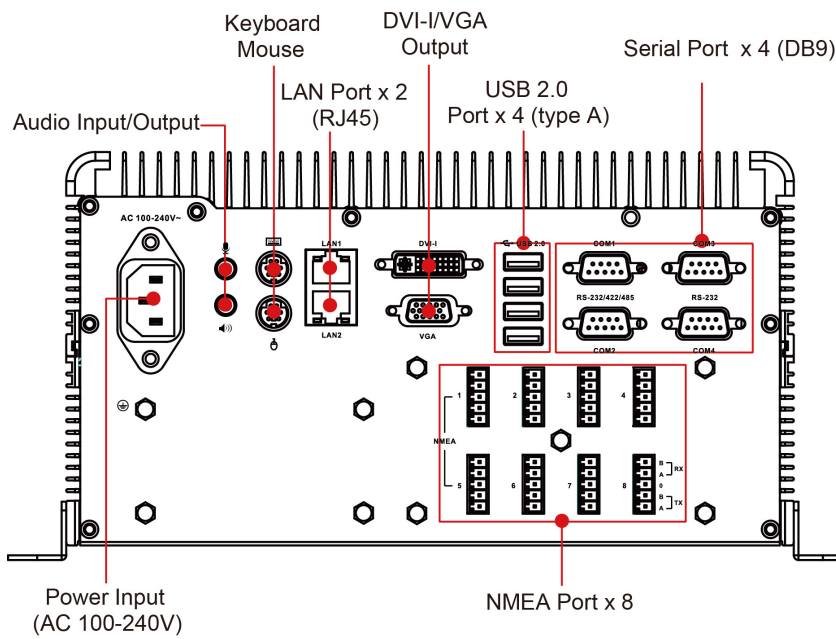

## DC Model Rear View

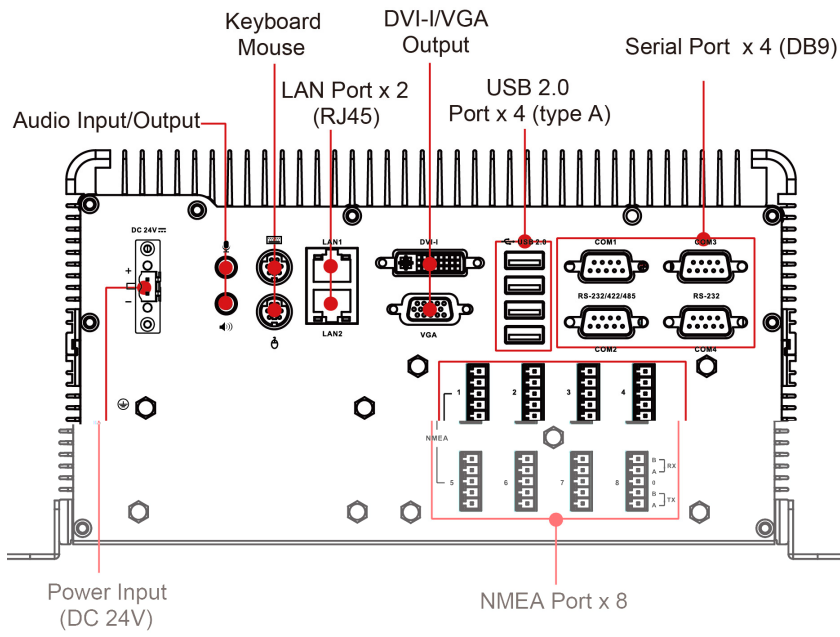

## Dimensions

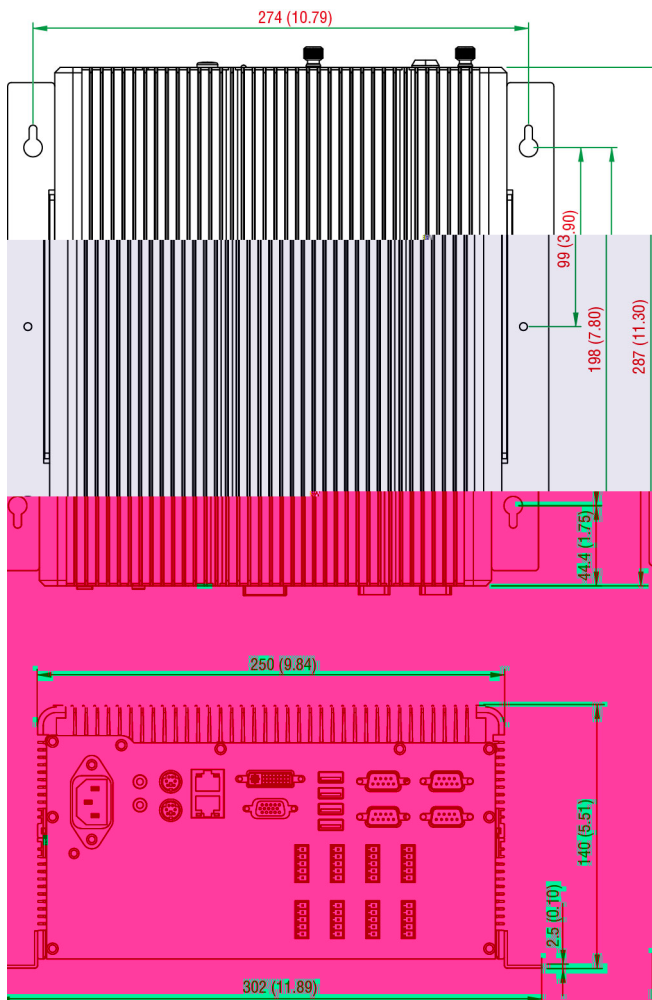

## LED Indicators

LED Name	LED Color	LED Function
Power	Green	Power is on and functioning normally
	Off	Power is off or a power error exists
Storage	Red (on)	SSD is inserted and detected
	Red (blinking)	SSD is reading/writing
	Off	No activity
LAN	Green	100 Mbps Ethernet mode
	Yellow	1000 Mbps (Gigabit) Ethernet mode
	Off	No activity or 10 Mbps Ethernet mode

## Real Time Clock

The embedded computer's real-time clock is powered by a lithium battery. We strongly recommend that you **NOT** replace the lithium battery on your own. If the battery needs to be changed, contact the Moxa RMA service team at [http://www.moxa.com/rma/about\\_rma.aspx](http://www.moxa.com/rma/about_rma.aspx).



### ATTENTION

There is a risk of explosion if the wrong type of battery is used. To avoid this potential danger, always be sure to use the correct type of battery. Contact the Moxa RMA service team if you need to replace your battery.

### Caution

There is a risk of explosion if the battery is replaced by an incorrect type. Dispose of used batteries according to the instructions on the battery.

# Hardware Connection Description

---

In this chapter, we show how to connect the embedded computers to the network and to various devices.

The following topics are covered in this chapter:

- ❑ **Installing the MC-5150-AC/DC**
- ❑ **Wiring Requirements**
- ❑ **Connecting the Power**
- ❑ **Grounding the MC-5150-AC/DC**
- ❑ **Connecting Data Transmission Cables**
  - Connecting to the Network
  - Connecting to a Serial Device
- ❑ **Connecting a PS/2 Keyboard and Mouse**
- ❑ **Connecting to the USB Device**
- ❑ **Connecting to a VGA Monitor**
- ❑ **Connecting to a DVI-I Monitor**
- ❑ **Connecting to a Speaker or a Headphone**
- ❑ **Installing the Removable SATA Hard Disk**
- ❑ **Installing the Internal SATA Hard Disk**
- ❑ **Upgrading the Memory Module**

# Installing the MC-5150-AC/DC

## Wall or Cabinet Mounting

The MC-5150-AC/DC has been pre-installed with two brackets on both ends of the computer. Use two screws per side to attach the MC-5150-AC/DC to a wall or cabinet.

Use two screws for each bracket and attach the bracket to the rear of the MC-5150-AC/DC.

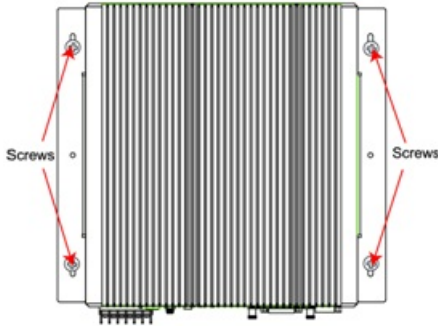

## Wiring Requirements

This section describes how to connect serial devices to the embedded computer.

You should read and follow these common safety precautions before proceeding with the installation of any electronic device:

- Use separate paths to route wiring for power and devices. If power wiring and device wiring paths must cross, make sure the wires are perpendicular at the intersection point.

**NOTE** Do not run signal or communication wiring together with power wiring in the same wire conduit. To avoid interference, wires with different signal characteristics should be routed separately.

- Use the type of signal transmitted through a wire to determine which wires should be kept separate. The rule of thumb is that wiring that shares similar electrical characteristics can be bundled together.
- Keep input wiring and output wiring separate.
- It is advisable to label the wiring to all devices in the system.



### **ATTENTION**

#### **Safety First!**

Be sure to disconnect the power cord before installing and/or wiring your MC-5150-AC/DC.

#### **Wiring Caution!**

Calculate the maximum possible current in each power wire and common wire. Observe all electrical codes dictating the maximum current allowable for each wire size.

If the current goes above the maximum ratings, the wiring could overheat, causing serious damage to your equipment.

#### **Temperature Caution!**

Be careful when handling the unit. When the unit is plugged in, the internal components generate heat, and consequently the outer casing may feel hot to the touch.

## Connecting the Power

The MC-5150-DC model offers 24 VDC power input (with tolerance from 18 to 30 VDC) with the terminal block, and the MC-5150-AC model offers 100 to 240 VAC. If the power is supplied properly, the Power LED will light up.

For safety reasons, please use cables with the following specifications:

**Wire range 14-22 AWG, torque 7 lb**

## Grounding the MC-5150-AC/DC

Grounding and wire routing help limit the effects of noise due to electromagnetic interference (EMI). Run the ground connection from the ground screw to the grounding surface prior to connecting the power.



### ATTENTION

This product is intended to be mounted to a well-grounded mounting surface, such as a metal panel.

EG: See the figure shown below for the location of the Earth Ground on the terminal block power connector. Connect the EG wire to an appropriate grounded metal surface.

#### DC Model:

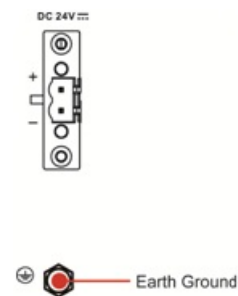

#### AC Model:



## Connecting Data Transmission Cables

This section describes how to connect the MC-5150-AC/DC computer to the network and serial devices.

### Connecting to the Network

Plug your network cable into the embedded computer's Ethernet port. The other end of the cable should be plugged into your Ethernet network. When the cable is properly connected, the LEDs on the embedded computer's Ethernet port will glow to indicate a valid connection.

The 10/100/1000 Mbps Ethernet LAN port uses 8-pin RJ45 connectors. The following diagram shows the pinouts for these ports.

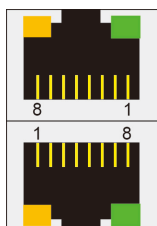

The LED indicators on the right top and right bottom corners glow a solid green color when the cable is properly connected to a 100 Mbps Ethernet network. The LED will flash on and off when Ethernet packets are being transmitted or received.

The LED indicators on the left top and left bottom corners glow a solid yellow color when the cable is properly connected to a 1000 Mbps Ethernet network. The LED will flash on and off when Ethernet packets are being transmitted or received.

Pin	10/100 Mbps	1000 Mbps
1	ETx+	TRD(0)+
2	ETx-	TRD(0)-
3	ERx+	TRD(1)+
4	---	TRD(2)+
5	---	TRD(2)-
6	ERx-	TRD(1)-
7	---	TRD(3)+
8	---	TRD(3)-

## Connecting to a Serial Device

The serial ports use DB9 connectors. COM1 and COM2 can run with RS-232, RS-422, or RS-485, and COM3 and COM4 run with RS-232. The pin assignments are shown in the following table:

DB9 Male Port

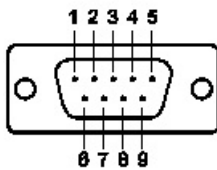

RS-232/422/485 Pinouts

Pin	RS-232	RS-422	RS-485 (4-wire)	RS-485 (2-wire)
1	DCD	TxDA(-)	TxDA(-)	-
2	RxD	TxDB(+)	TxDB(+)	-
3	TxD	RxDB(+)	RxDB(+)	DataB(+)
4	DTR	RxDA(-)	RxDA(-)	DataA(-)
5	GND	GND	GND	GND
6	DSR	-	-	-
7	RTS	-	-	-
8	CTS	-	-	-

Additionally, 8 NMEA serial ports with Phoenix 3.81 mm compatible connectors are also available on the rear panel of the computer. Refer to the following figures for the location of the NMEA ports and the pin assignments.

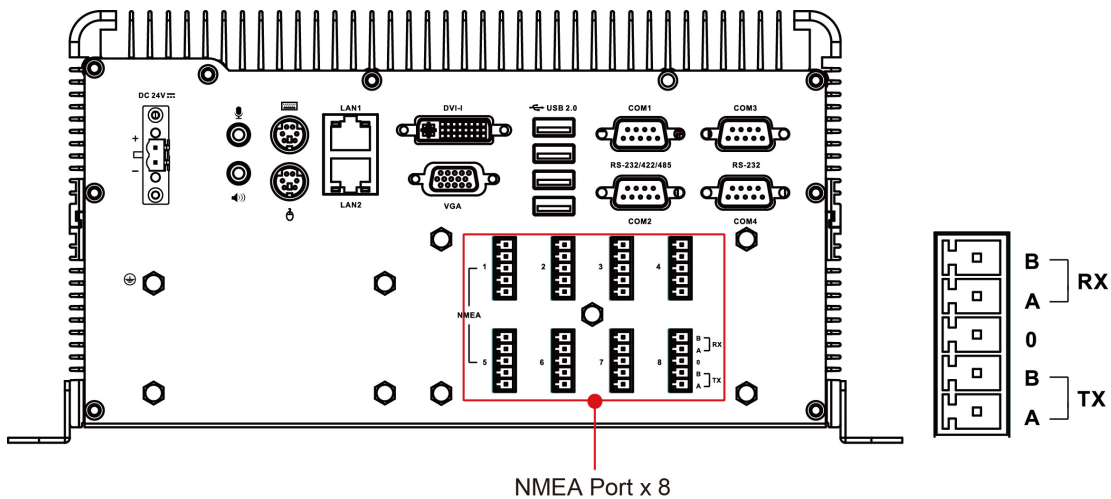

## Connecting a PS/2 Keyboard and Mouse

Your MC-5150-AC/DC computer comes with 2 PS/2 mini-DIN connectors on the rear panel to connect to a PS/2 keyboard and PS/2 mouse. This 6-pin mini-DIN connector has the pin assignments shown below.

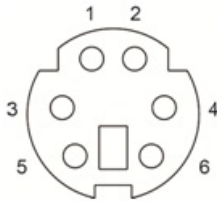

**PS/2 Connector**

Pin No.	Signal Definition
1	PS/2 Keyboard Data
2	PS/2 Mouse Data
3	GND
4	VCC
5	PS/2 Keyboard Clock
6	PS/2 Mouse Clock

## Connecting to the USB Device

The MC-5150-AC/DC comes with 2 USB 2.0 hosts on the front panel, and 4 USB 2.0 hosts on the rear panel. The hosts can be used for an external flash disk or hard drive for storing large amounts of data. You can also use these USB hosts to connect to a keyboard or a mouse.

## Connecting to a VGA Monitor

The MC-5150-AC/DC comes with a D-Sub 15-pin female connector on the front panel to connect a VGA CRT monitor. To ensure that the monitor image remains clear, be sure to tighten the monitor cable after connecting it to the MC-5150-AC/DC. The pin assignments of the VGA connector are shown below.

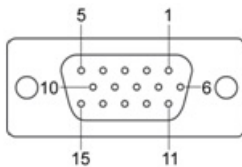
**DB15 Female Connector**

Pin No.	Signal Definition
1	Red
2	Green
3	Blue
4	NC
5	GND
6	GND
7	GND
8	GND
9	VCC
10	GND
11	NC
12	DDC Data
13	HSYNC
14	VSYNC
15	DDC Clock

## Connecting to a DVI-I Monitor

The MC-5150-AC/DC computers come with a DVI-I connector that can connect to a DVI monitor. Use the cable to connect one end to the DVI-I connector and the other end to the monitor. See the following table for DVI-I connector pin assignments.

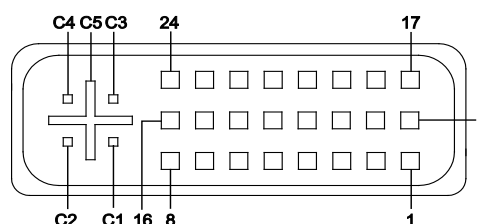
**DVI-I Connector**

Pin No.	Signal Definition
1	T.M.D.S. Data2-
2	T.M.D.S. Data2+
3	T.M.D.S. Data2/4 Shield
4	N/C
5	N/C
6	DDC Clock
7	DDC Data
8	Analog Vertical Sync
9	T.M.D.S. Data1-
10	T.M.D.S. Data1+
11	T.M.D.S. Data1/3 Shield
12	N/C
13	N/C
14	+5V Power
15	Ground (return for +5V, HSync, and VSync)

Pin No.	Signal Definition
16	Hot Plug Detect
17	T.M.D.S. Data0-
18	T.M.D.S. Data0+
19	T.M.D.S. Data0/5 Shield
20	N/C
21	N/C
22	T.M.D.S. Clock Shield
23	T.M.D.S. Clock+
24	T.M.D.S. Clock-
C1	Analog Red
C2	Analog Green
C3	Analog Blue
C4	Analog Horizontal Sync
C5	Analog Ground (analog R, G, B return)

## Connecting to a Speaker or a Headphone

The MC-5150-AC/DC comes with audio input and output interfaces on the rear panel for connecting a microphone and speaker or headphones.

## Installing the Removable SATA Storage Drive



### IMPORTANT!

Moxa is continually testing SSDs for compatibility with MC-51XX computers. As of June 2012, the Memorigt MRSAJ6C064GC125C00 and Memorigt MRSAD4B060GC225C00 models of SSD have been fully approved for use with MC-51XX devices. However, this is only a partial list and one that is continually growing; for a more up-to-date list of which SSDs are certified as compatible with MC-51XX computers, please contact Moxa's technical support team.

The MC-5150 AC/DC computer comes with a removable SATA storage device tray that is accessible through the front panel. Either a SATA hard disk or solid state drive may be installed, but only use of an SSD will ensure full anti-vibration compliance. To install a SATA storage device, please follow these instructions:

1. Disconnect the MC-5150-AC/DC from the power source.
2. To remove the storage device tray, insert the protection key and turn it to the right, then unfasten the two thumbscrews that secure the removable tray. The storage tray's location may be seen in the following figure:

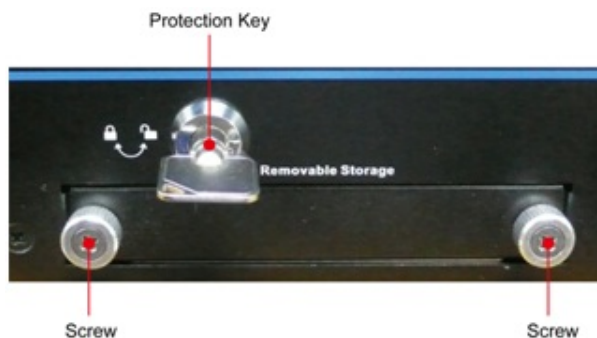

3. Remove the storage bracket from the slot and turn over to get access to the four screws which will secure the drive into place within the tray.



4. Place the drive into the tray and secure it in place using the four screws. When finished, insert the tray into the computer and fasten the tray in place using the two thumbscrews on the front panel. Finally, complete the installation by turning the key leftwards to lock the tray into place.

## Installing the Internal SATA Storage Drive

The MC-5150-AC/DC has an internal SATA slot for expanding the computer's storage capacity; this slot is accessible via a screw-fastened plate (philips head) on the bottom panel of the computer.

1. To access the storage expansion slot, turn over the MC-5150-AC/DC model and remove the four screws on the cover plate. The following figure shows the plate's location:

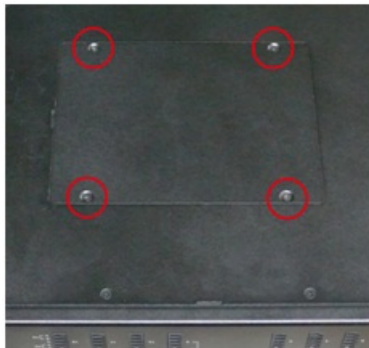

After removing the back plate cover of the computer, you need to install the hard disk installation kit. See the following description.

1. Remove the four screws from the storage slot's mounting tray (mount points indicated in the figure below) and, without detaching the SATA cable from the mounting tray, remove the tray from the storage slot.

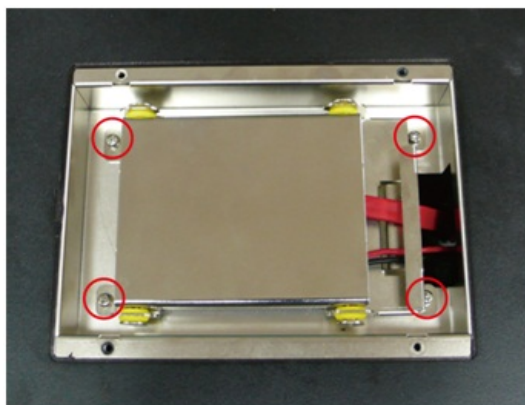

- Next, remove the four screws located on the sides of the mounting tray and then remove the top cover of the tray.

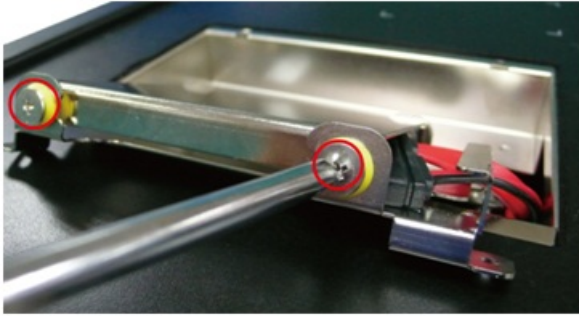

- Connect the SATA connector to the disk's SATA assembly and then place the hard disk into the mounting tray. Fasten the storage drive to the mounting tray using the side screws you have just removed.

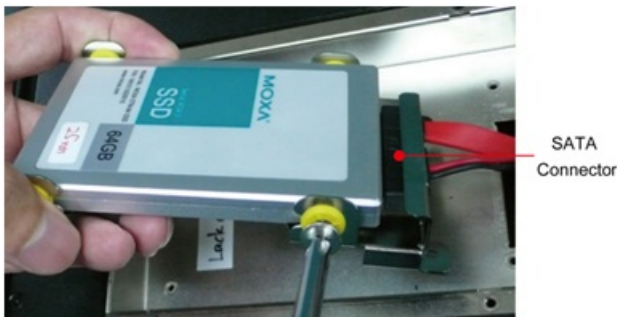

- Replace the storage drive into the computer and secure it using the four mounting screws you removed in step 1.



- Replace and secure the storage drive slot cover to complete the installation

## Upgrading the Memory Module

The MC-5150-AC/DC has pre-installed with 2 GB DDR3 SDRAM onboard, and supports up to 8 GB DDR3 SDRAM. If you would like to upgrade the memory module, please follow the steps below.

1. Remove all the screws on the back cover of the computer.

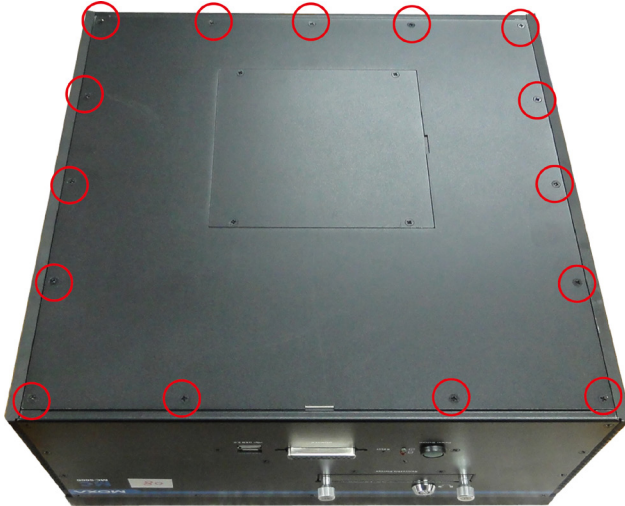

2. Remove the screws on the front panel of the computer, including the screws for the dongle, and remember to take out the removable storage tray on the front panel.

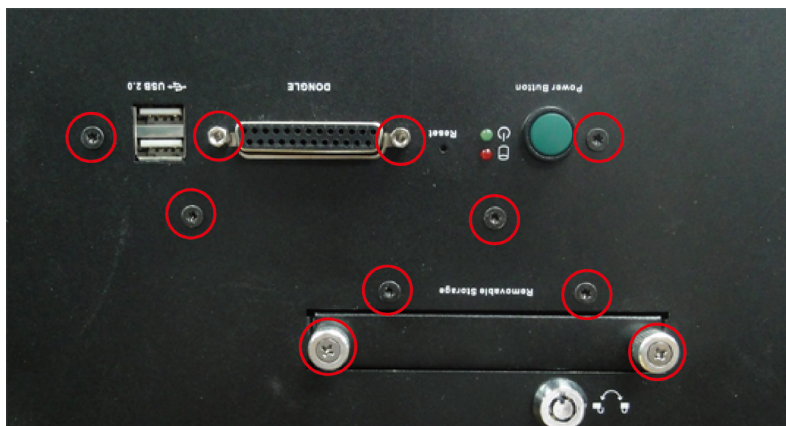

3. Remove the black tape on the storage tray, and remove the peripheral I/O board. See the following figure for detailed location.

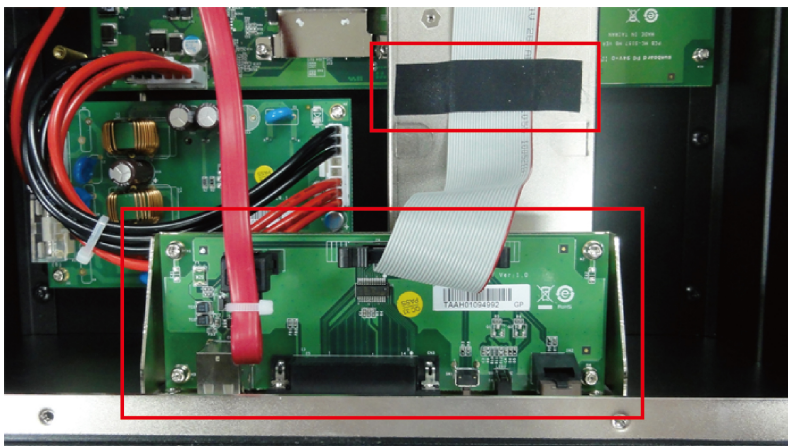

4. Remove the four screws on the removable storage tray.

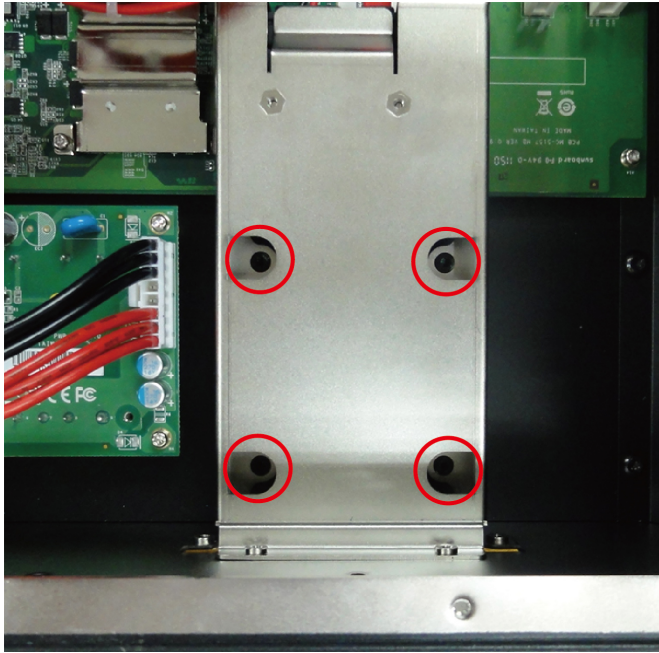

5. When finished, remove the storage tray, and you can see the location of the memory module.

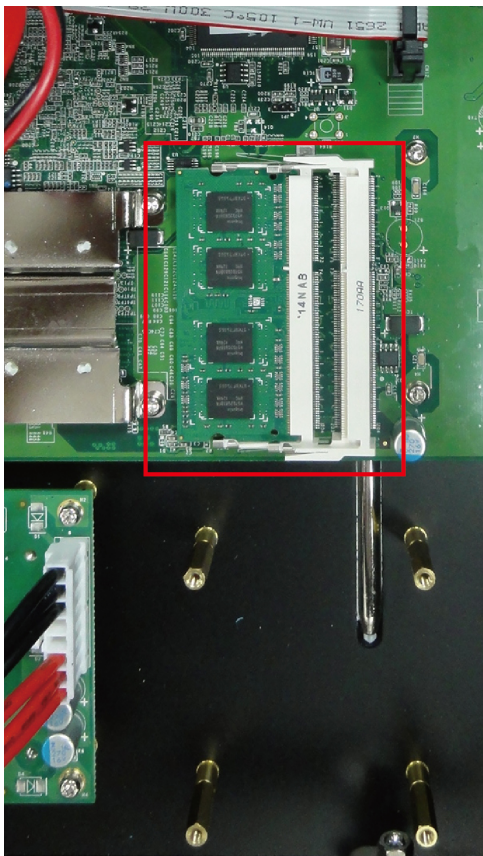

- There are two clutches on both sides of the module. Click the clutches, and the memory module will pop up. Gently remove the module.

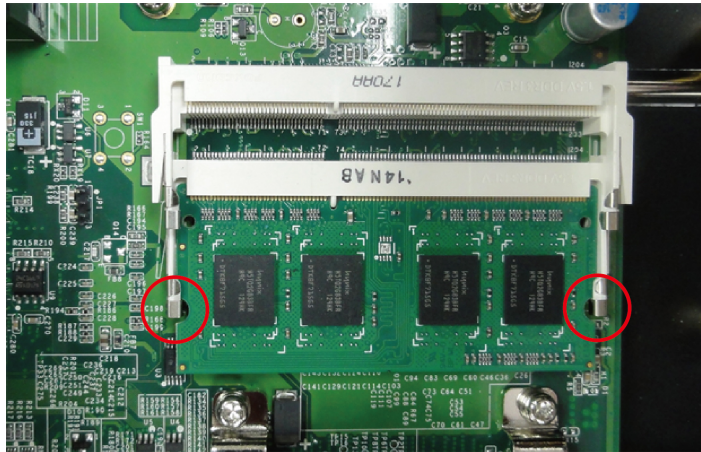

- Carefully slide the module into the clutch at an angle, and then push downward. Make sure the module has been firmly inserted and is oriented correctly.

## BIOS Setup

---

This chapter describes the BIOS settings of the MC-5150-AC/DC computer. The BIOS is a set of input/output control routines for peripherals. The BIOS is used to initialize basic peripherals and helps boot the operating system before the operating system is loaded. The BIOS setup allows the user to modify the system configurations of these basic input/output peripherals. All of the configurations will be stored in the battery backed up CMOS RAM, which retains the system information after system reboots or the power is removed.

The following topics are covered in this chapter:

### ❑ Entering the BIOS Setup Utility

- Main Information

### ❑ Modifying the BIOS Main Settings

- Advanced Settings
- Boot Configuration
- Peripheral Configuration
- IDE Configuration
- Thermal Configuration
- Intelligent Power Sharing
- Video Configuration
- USB Configuration
- Chipset Configuration
- Hardware Monitor

### ❑ Security Settings

- Set Supervisor Password
- Set User Password

### ❑ Power Settings

- Advanced CPU Control

### ❑ Boot Settings

- Quick Boot
- PXE Boot to LAN
- ACPI Selection
- USB Boot
- WDT Timeout
- Boot Redirection
- Legacy

### ❑ Exit Settings

- Exit Saving Changes
- Save Change Without Exit
- Exit Discarding Changes
- Load Optimal Defaults
- Load Custom Defaults
- Save Custom Defaults
- Discard Changes

### ❑ Upgrading the BIOS



# Entering the BIOS Setup Utility

To enter the BIOS setup utility, press the "F2" key while the system is booting up. The main BIOS Setup screen will appear.

A basic description of each function key is listed at the bottom of the screen. Refer to these descriptions to learn how to scroll about the screen, how to select by pressing "Enter," and how to use the other hot keys listed below.

**F1: General Help**

**F5/F6: Change Values**

**F9: Setup Defaults**

**F10: Save and Exit**

**ESC: Exit**

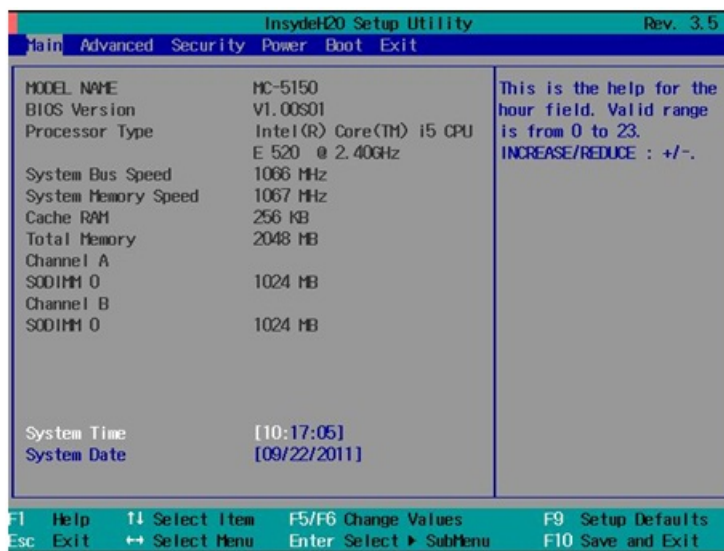

## Main Information

The main page indicates the system information, such as model name, BIOS version, and CPU type. User may view the basic system hardware information in the page.

# Modifying the BIOS Main Settings

## Advanced Settings

The "Advanced Features" screen will appear when choosing the "Advanced" item from the main menu.

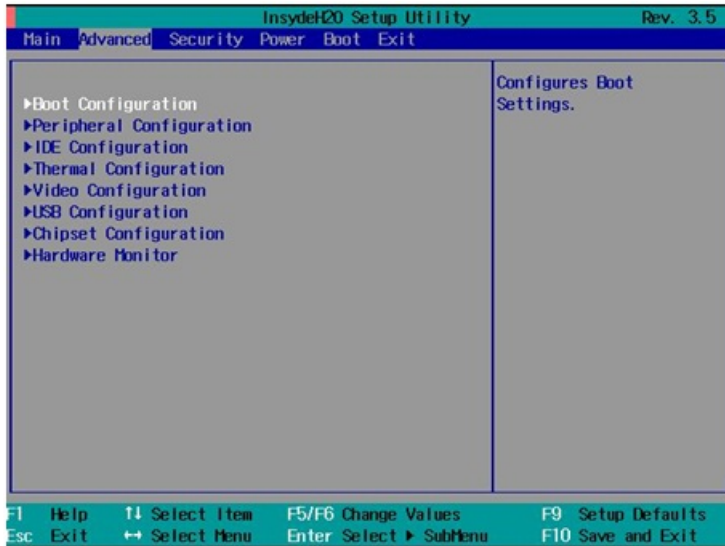

## Boot Configuration

This item allows users to enable the keypad at boot.

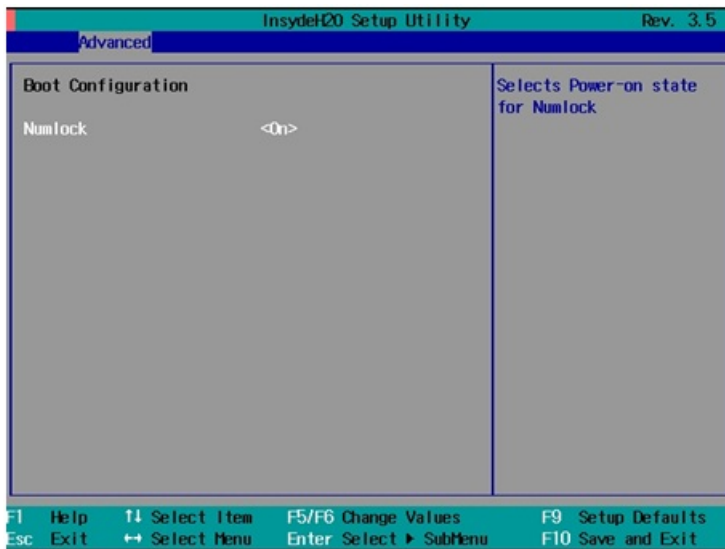

Option: On (default), Off.

## Peripheral Configuration

This item allows you to configure the parallel port and audio device.

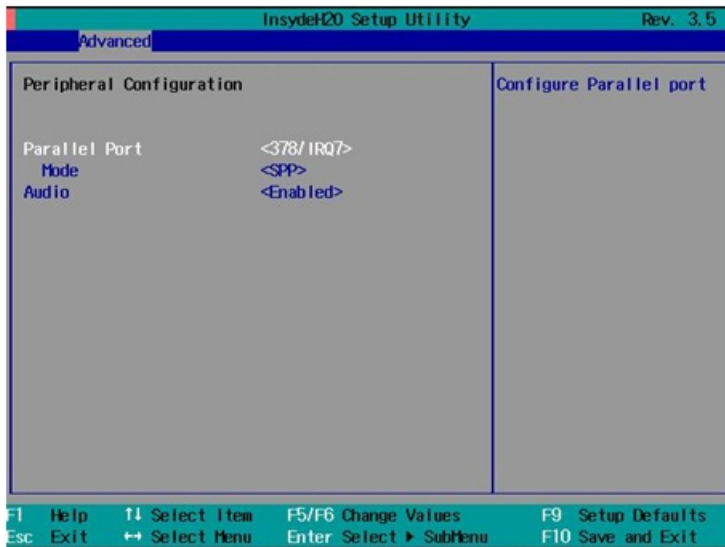

### Parallel Port

This item allows you to enable the parallel port.

Options: 378/IRQ7 (default), Disabled

### Mode

This setting allows you to select the parallel port mode.

Options: SPP (default), EPP, ECP, EPP+ECP

### Audio

The item allows you to configure the system to automatically detect the Audio codec.

Options: Enabled (default), Disable.

## IDE Configuration: Storage Device BIOS Settings

The IDE configuration section is where the BIOS settings for all storage devices are configured. There are three basic operation modes for storage drives: IDE (default), AHCI, and RAID. Most current systems will use AHCI or RAID mode.

IDE mode is configured as default; it is included for legacy operating systems which do not support SATA. AHCI is available for systems which want to use full SATA capabilities, but with only a single or dual independent drives. RAID mode is available for systems which wish to configure two or more SATA drives in a RAID array.

## HDC Configure As: Host Drive Controller Configuration

The host drive controller may be configured for IDE (legacy default), AHCI, or RAID RAID mode (Options: IDE (default), AHCI, RAID).

When the legacy IDE mode is selected, the following screen will appear.

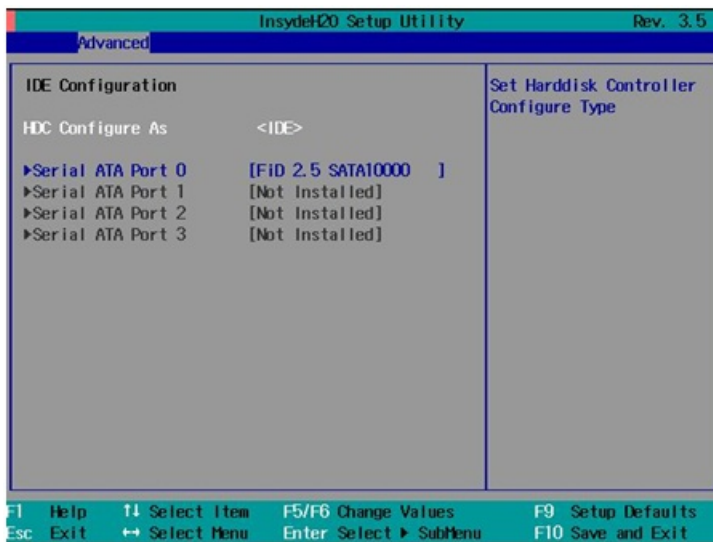

For normal SATA functionality, select AHCI. When this option is selected, AHCI SALP () may be enabled. Four SATA interfaces (0-3) will be highlighted; only the first two SATA ports are enabled by default, with port 0 enabling the removable drive tray on the front panel, and port 1 enabling the drive expansion slot accessed through the bottom panel. The figure below displays the AHCI configuration screen:

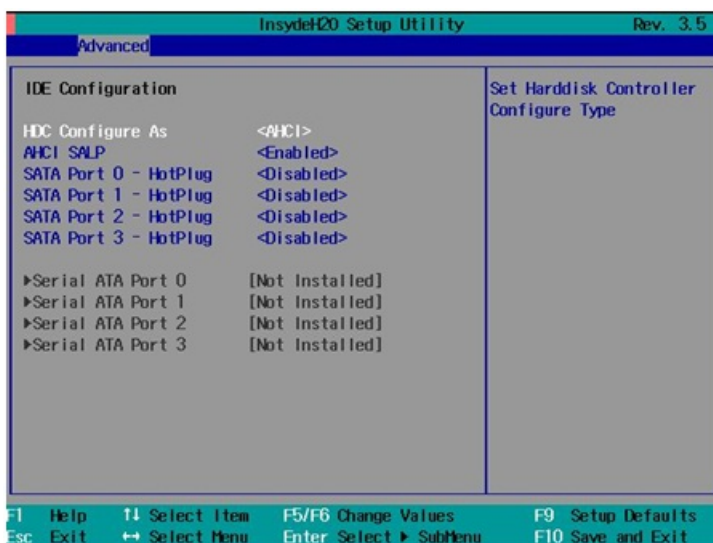

To enable a RAID array, two SATA storage drives must be installed on the first two ports. AHCI SALP may also be enabled from the RAID screen.

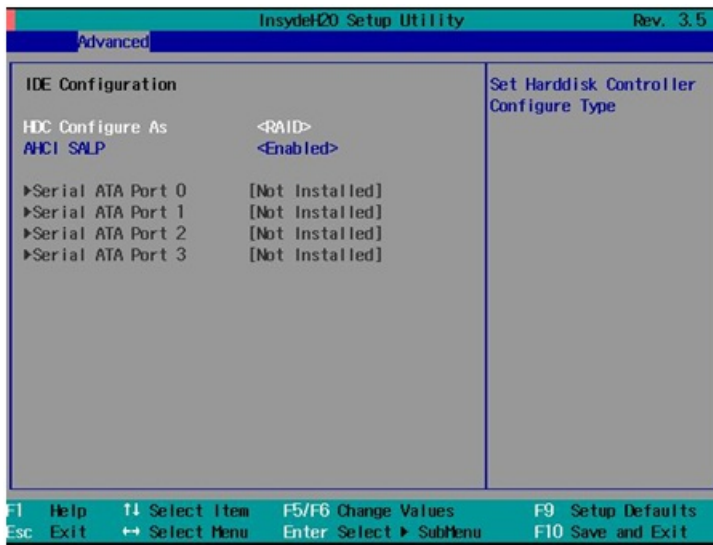

## Serial ATA Port 0 to 3

This setting allows you to configure the type of the storage drive installed in the computer. Navigate the list with the up and down arrows and press "Enter" to select parameters. Only the first two ports (ports 0 and 1) will be available for use: port 0 represents the removable drive tray on the front panel, while port 1 represents the drive expansion slot accessed from the bottom panel.

Options: Auto (default), User Defined

## AHCI SALP

This item allows you to enable aggressive "link power management" (SALP) in AHCI. SALP enables the host bus adapter to conserve power by directly detecting when a SATA drive is no longer processing information and then immediately shifting it into suspended or sleep modes without waiting for software processes to initiate power-down processes.

Host Capability Register bit 26.

Options: Enabled (default), Disabled

## SATA Port 0 to 3 - HotPlug

This item allows you to configure if you would like to enable/disable the hot & plug function of the storage installed on the SATA port 0 to port 3.

Options: Disable (default), Enabled

## Thermal Configuration

This item allows you to enable/disable hotplug functionality (the ability to remove the drive while the computer is running) of installed storage drives.

Options: Disable (default), Enabled

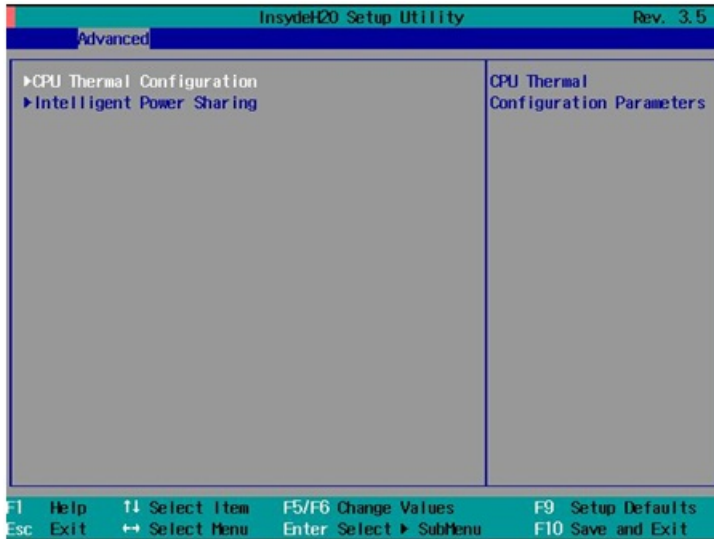

### DTS

This item allows you to configure the Digital Thermal Sensor (DTS) function.

Options: Critical Reporting (default), Disabled, Enabled

### Thermal Mode

This setting allows you to configure the thermal mode.

Options: TM1 and TM2 (default), Disabled, TM1, TM2

### ACPI 3.0 T-States

This item allows you to configure the ACPI 3.0 T-States.

Options: Disabled (default), Enabled

## Intelligent Power Sharing

This item allows you to enable Intelligent Power Sharing (IPS). IPS is an Intel technology that provides intelligent power sharing across cores. Performance for the processor and graphics processor can be scaled up or down, depending on system activity and thermal tolerances giving stellar performance and prudent power use.

Options: Disabled (default), Enabled

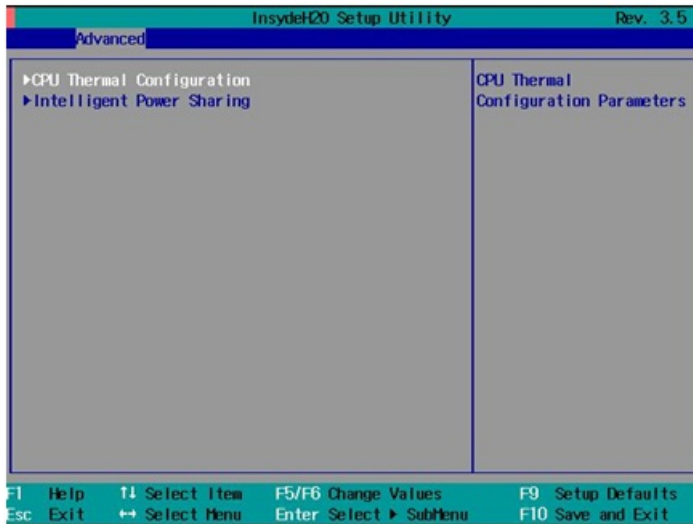

## Video Configuration

This item allows you to configure the integrated graphics device (IGD) for things like memory allocation (DVMT) and monitor types ("Boot Type").

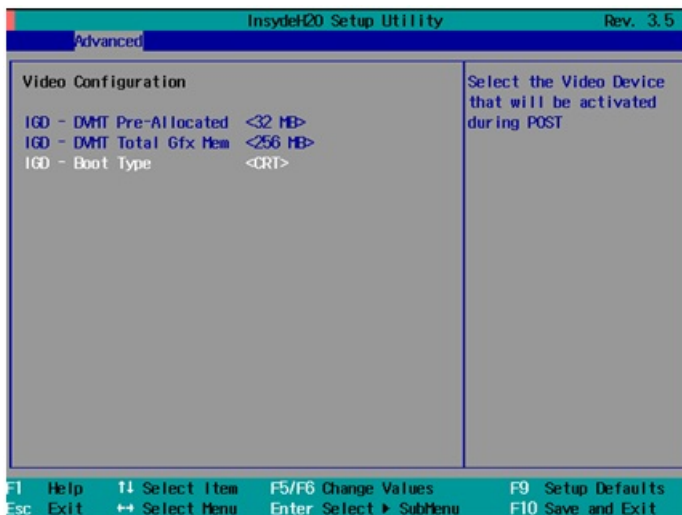

### IGD—DVMT Pre-Allocated

Options: 32 MB (default), 64 MB, 96 MB, 128 MB, 160 MB, 224 MB, 257 MB, 352 MB

From Intel: DVMT is a BIOS solution where "the optimum amount of memory is dynamically allocated and de-allocated as needed for balanced graphics and system performance, through Intel® Direct AGP and a highly efficient memory utilization scheme. DVMT ensures the most efficient use of available system memory resources for maximum 2D/3D graphics performance."

This item allows you to configure pre-allocated memory capacity for the IGD. Pre-allocated graphics memory is invisible to the operating system.

## IGD—DVMT Total Gfx Mem

This item allows you to configure the maximum amount of memory DVMT will use when allocating additional memory for the internal graphics device.

Options: 256 MB (default), 128 MB, 512 MB, 1024 MB

## IGD – Boot Type

This item allows you to select the video device which will be activated during POST.

Options: VBIOS Default (default), CRT, DVI-D, DVI-A

## USB Configuration

This item allows you to enable/disable USB legacy mode; sometimes this is a useful setting when using USB monitors and keyboards.

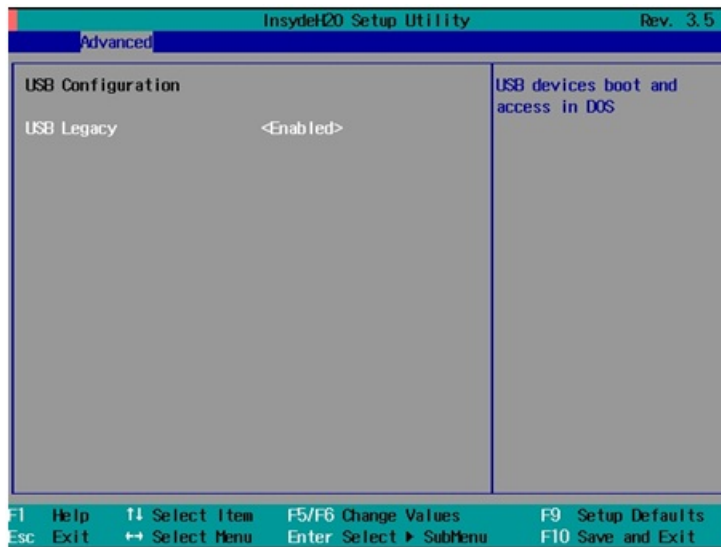



## Chipset Configuration

This item allows you to configure the chipset settings.

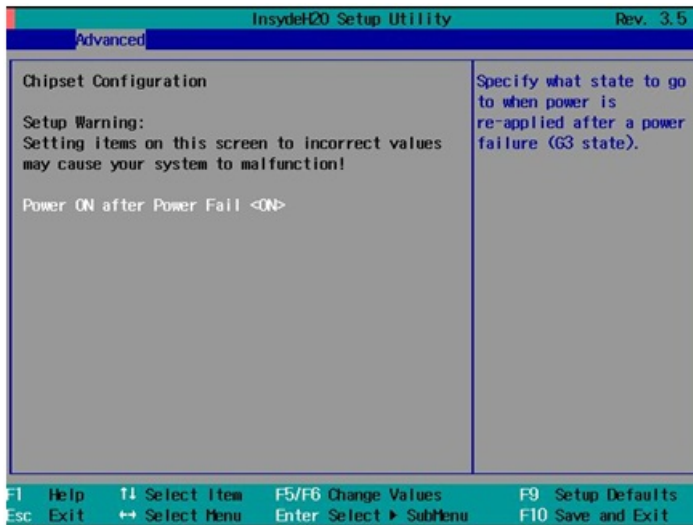

### Power ON after Power Fail

This item allows you to enable/disable power to automatically come on after a power failure.

Options: ON (default), OFF, Last State

## Hardware Monitor

This item allows you to view stats like CPU and system temperature, voltage levels, and other chipset information.

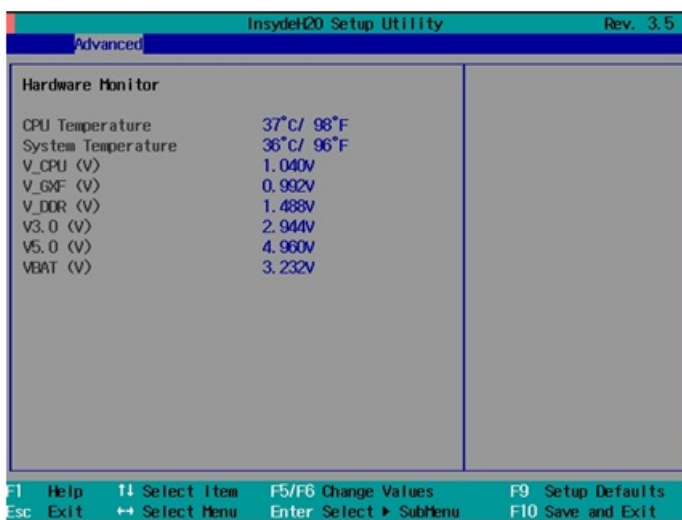

# Security Settings

The section allows users to configure security settings with supervisor password and user password.

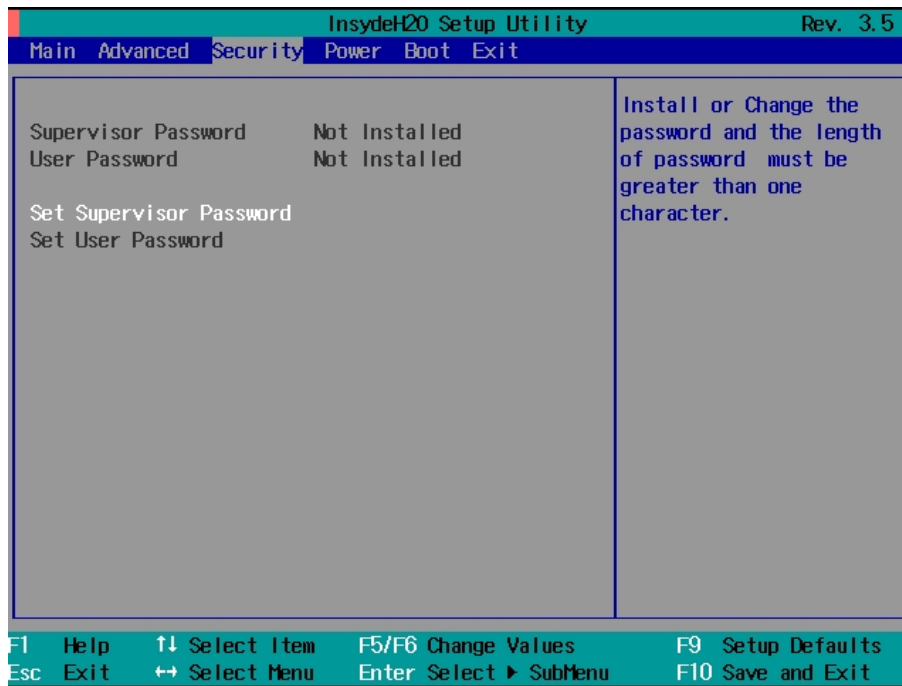

## Set Supervisor Password

This item allows you set the supervisor password. Select and then enter the password, and then confirm the password again.

To cancel the password, enter Set Supervisor Password item, and then enter the old password, then leave the new password fields blank, and then press enter.

## Set User Password

This item allows you set the supervisor password. Select and then enter the password, and then confirm the password again.

Please note that you must set the supervisor password first, so that you can set the user password.

# Power Settings

The section allows users to configure power settings.

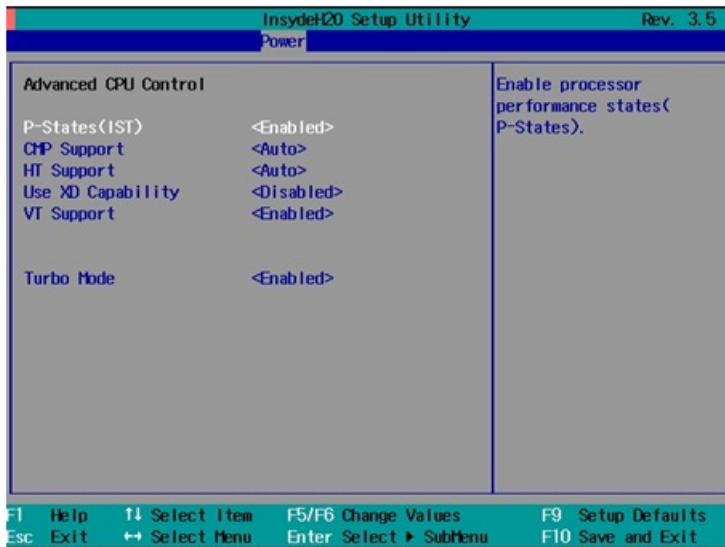

## Advanced CPU Control

### P-States (IST)

This item allows you to enable/disable Processor Performance States (P-States) function.

Options: Disabled (default), Enabled

### CMP Support

This item allows you to configure the Core™ Multi-Processing (CMP) function.

Options: Auto (default), Disabled

### HT Support

This item allows you to configure the Hyper-Threading (HT) function.

Options: Auto (default), Disabled

### Use XD Capability

This item allows you to disable/enable processor XD capability function.

Options: Disable (default), Enabled

### VT Support

This item allows you to enable/disable the Vanderpool Technology function.

Options: Enabled (default), Disabled

## Turbo Mode

This item allows you to configure the processor Turbo Mode function.

Options: Enable (default), Disabled

## Boot Settings

The section allows users to configure boot settings.

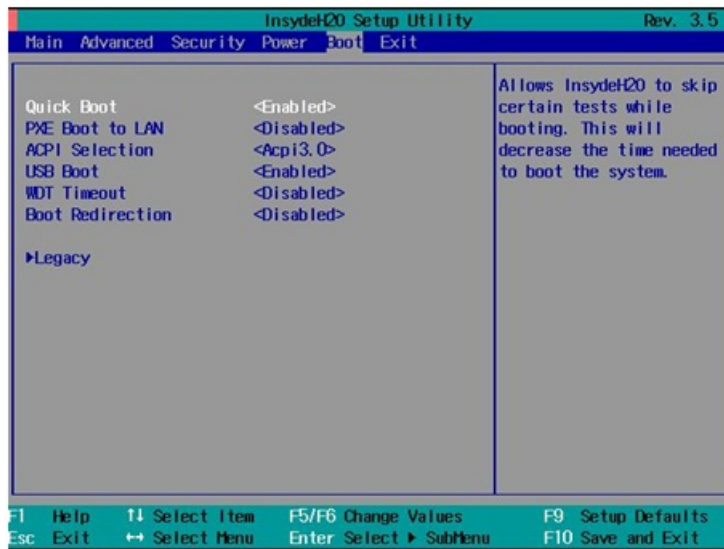

## Quick Boot

This item allows you to enable/disable quick boot function.

Options: Enabled (default), Disabled

## PXE Boot to LAN

This item allows you to enable/disable PXE boot to LAN function.

Options: Disabled (default), Enabled

## ACPI Selection

This item allows you to select the ACPI version..

Options: Acpi3.0 (default), Acpi1.0B, Acpi4.0

## USB Boot

This item allows you to enable/disable USB boot function..

Options: Enabled (default), Disabled

## WDT Timeout

This item allows you to set up WDT (Watchdog Timer) timeout after OS boots up.

Options: Disabled (default), 1 minute, 2 minutes, 3 minutes, 4 minutes, 5 minutes, 6 minutes, 7 minutes, 8 minutes, 9 minutes, 10 minutes

## Boot Redirection

This item allows you to set up boot to selected device when WDT timeout event trigger, it can co-work with recovery tools to build smart recovery function.

Options: Disabled (default), SATA Port0 HD, SATA Port1 HD, SATA Port2 HD, SATA Port3 HD, USB, LAN (when use LAN, PXE Boot to LAN must set to Enable).

## Legacy

### Normal Boot Menu

This item allows you to configure the boot menu.

Options: Normal (default), Advance

### Boot Type Order

This item allows you to select the boot order. Use F5/F6 to change values.

Options: Hard Disk Drive (default), CD/DVD-ROM Drive, USB, LAN

### Hard Disk Drive

This item allows you to view the hard disk drive installed in the computer.

# Exit Settings

This section allows users to exit the BIOS environment.

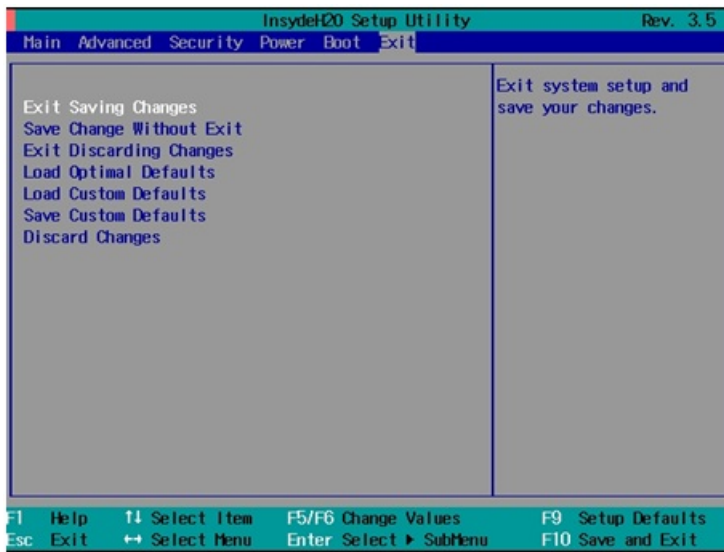

## Exit Saving Changes

This item allows you to exit the BIOS environment and save the values you have just configured.

Options: Yes (default), No

## Save Change Without Exit

This item allows you to save changes without exiting the BIOS environment.

Options: Yes (default), No

## Exit Discarding Changes

This item allows you to exit without saving any changes that might have been made to the BIOS.

Options: Yes (default), No

## Load Optimal Defaults

This item allows you to revert to the factory default BIOS values.

Options: Yes (default), No

## Load Custom Defaults

This item allows you to load custom default values for the BIOS settings.

Options: Yes (default), No

## Save Custom Defaults

This item allows you to save the current BIOS values as a "custom default" that may be reverted to at any time by the "load custom defaults" selection just above.

Options: Yes (default), No

## Discard Changes

This item allows you to discard all settings you have just configured.

Options: Yes (default), No

## Upgrading the BIOS

This section describes how to upgrade the BIOS. However, please note that upgrading the BIOS involves high risk of damage to your computer. We strongly recommend that you contact Moxa's TS staff for assistance and obtain all necessary tools and files before attempting to upgrade.

### Step 1: Create a Bootable USB Disk

We suggest you use the HP USB Disk Format Tool to create a bootable USB disk. You may download this tool from the Internet. Search the Internet using the phrase "HP USB Disk Storage Format Tool", and then download the tool from one of the listed websites.

You will also need to download the FreeDOS system files **kernel.sys** and **command.com** from <http://www.freedos.org/kernel/>.

1. Copy DOS system files **kernel.sys** and **command.com** to a specified directory (**C:\FreeDOS** in this example).
2. Start the HP USB Disk Storage Format Tool and select the USB device that you want to use as a bootable disk in the **Device** drop down box.
3. Select **FAT** in the **File system** drop down box.
4. Type the disk name in the **Volume label field**.
5. Check the option **Create a DOS startup disk** under format options.
6. Specify the directory of the system files (for example, **C:\FreeDOS**).
7. Click **Start** to format and create the USB disk.

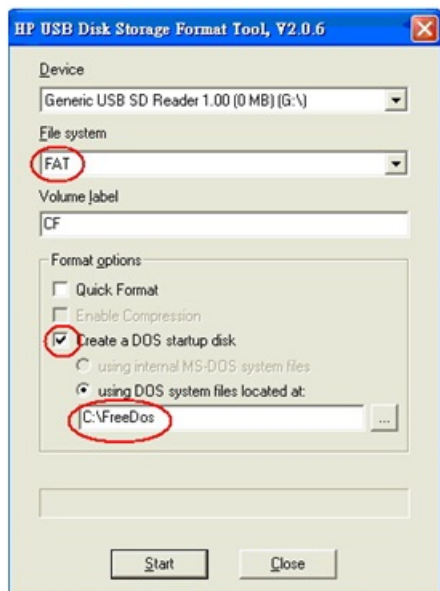

### ATTENTION

We suggest you use a USB drive with under 2 GB in disk space, as larger USB drives may not support FAT file format and consequently fail to boot.

## Step 2: Prepare the Upgrade File

You must use the BIOS upgrade installation file to upgrade the BIOS. Contact Moxa's technical department for assistance.

1. Get the BIOS upgrade installation file. The file name should have following format: **MC51xxSxx.exe** (xx refers to version numbers).
2. Copy the file to the Bootable USB Disk.

## Step 3: Run the upgrade program on the MC-5150-AC/DC Computer

1. Reboot the computer, press F12 while booting up to go to the Boot Manager
2. Select USB Disk as the first boot source. Press Enter to continue.



3. When boot up finishes, DOS screen will show up. Go to the directory where the upgrade file is located. For example, if the upgrade file is stored in the MC\_5150 folder, type `cd MC_5150`

```
C:\>cd MC_5150
```

4. Run the upgrade program by typing `MC5150S03.exe`. Please note that the upgrade filename may vary depending on the versions.

```
C:\ MC_5150>MC5150S03.exe
```

5. The upgrade program will be automatically performed. Please wait until the procedure to be finished.

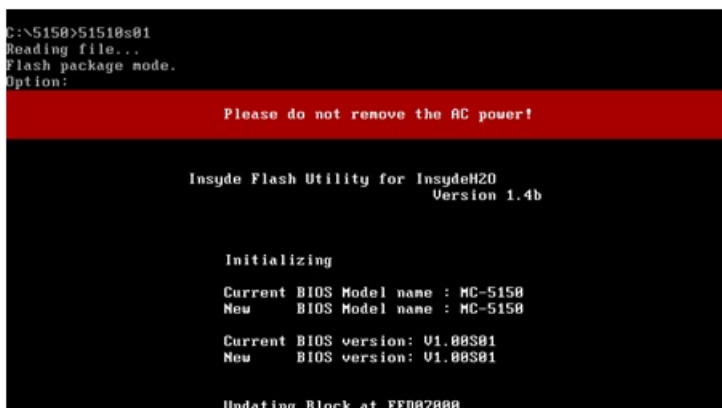

6. When the upgrade is finished, the computer will automatically reboot. You may check the BIOS version in Main page of the BIOS Setup

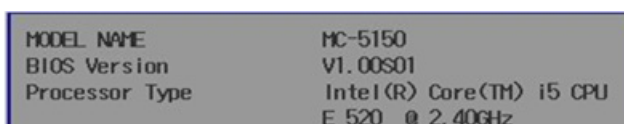





**ATTENTION**

Do NOT switch off the power supply during the BIOS upgrade, since doing so may cause the system to crash.

# A

## Regulatory Approval Statement

---



This device complies with part 15 of the FCC Rules. Operation is subject to the following two conditions: (1) This device may not cause harmful interference, and (2) this device must accept any interference received, including interference that may cause undesired operation.

**Class A:** FCC Warning! This equipment has been tested and found to comply with the limits for a Class A digital device, pursuant to part 15 of the FCC Rules. These limits are designed to provide reasonable protection against harmful interference when the equipment is operated in a commercial environment. This equipment generates, uses, and can radiate radio frequency energy and, if not installed and used in accordance with the instruction manual, may cause harmful interference to radio communications. Operation of this equipment in a residential area is likely to cause harmful interference in which case the user will be required to correct the interference at his own expense.



**European Community**

**Warning:**

This is a class A product. In a domestic environment this product may cause radio interference in which case the user may be required to take adequate measures.

# B

## Adjusting the Audio Mixer Function

---

This chapter describes how to adjust the audio settings for Mixer function of the MC-5150-AC/DC in the Windows XP and Windows XP Embedded operating systems.

Since the Mixer function is enabled by default, you need modify the default settings of the Realtek audio device so that sounds picked up from the microphone will not be recorded. Follow the steps below:

1. Right-click volume icon and select **Open Volume Control**.



2. Select **Properties**.

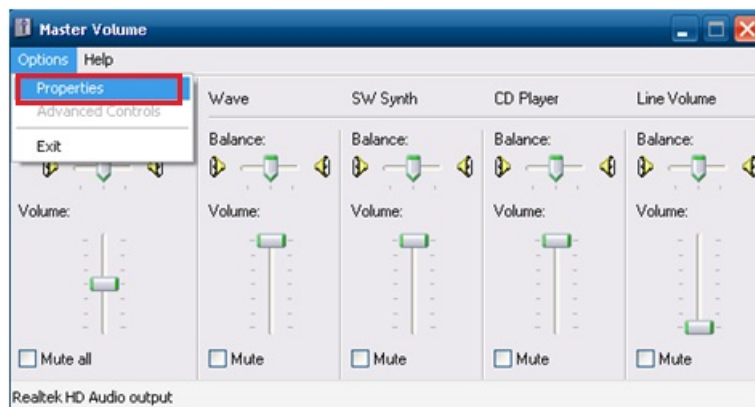

3. Select **Realtek HD Audio Input** from the Mixer device drop-down list, and check **Stereo Mix**. Click **OK** to continue.

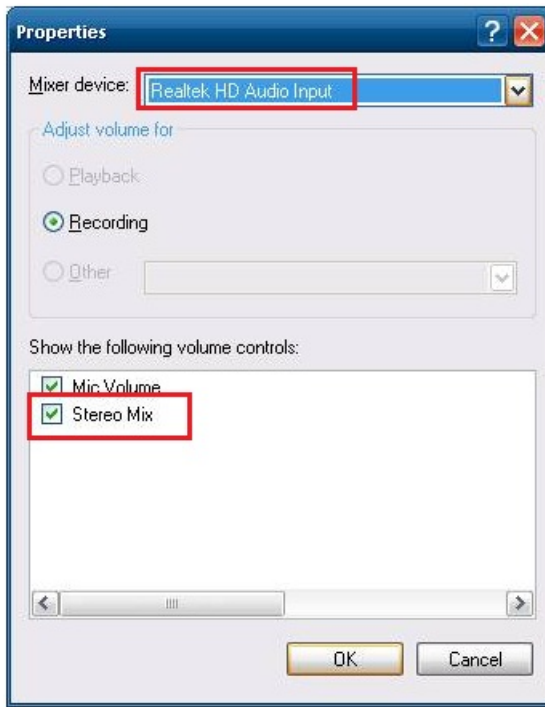

4. Uncheck the Select checkbox under Stereo Mix and check the Select checkbox under Mix Volume to complete the configuration.

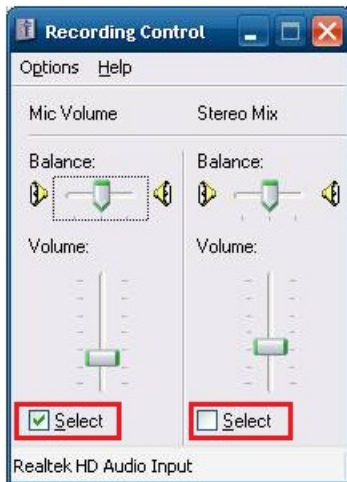

# C

## Smart Recovery

The MC-5150 provides the Smart Recovery tool that allows users to perform system recovery when the operating system crashes.

File loss and operating system corruption can be a nightmare for computer users. Usually, users find it difficult to fix the problem when the system crashes. Smart Recovery can create a back-up system to restore the operating system automatically. See the following figure for the main architecture of the recovery.

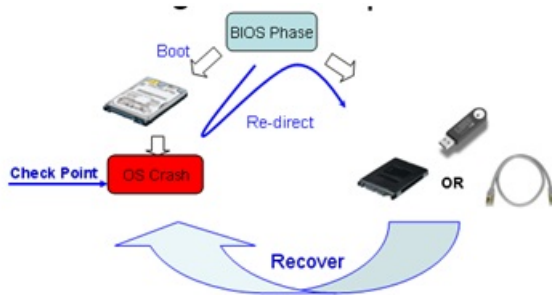

To run the Smart Recovery, do the following steps.

## Changing OS Configurations and Enable Check Point Function

To let the OS work properly with smart recovery, you need to modify some configurations.



1. Select **Startup and Recovery from My Computer=>System Properties=>Advanced.**



2. Uncheck **Automatically restart.**

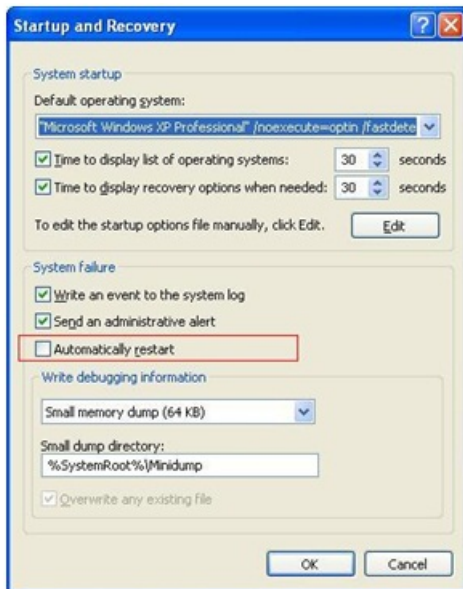

3. Copy checkpoint utility **W\_BRFLAG** from software CD path: **CD\utility\_tools\Smart Recovery** to system startup

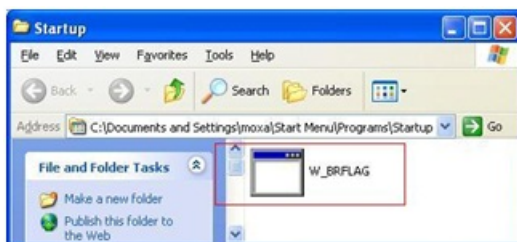

4. The check point function will be enabled each time the system boots up.

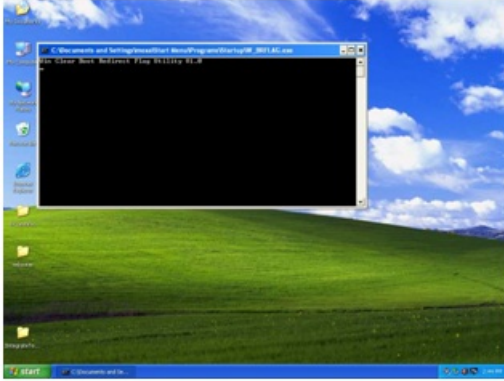

## Recovery Procedure

Refer to the following steps for system recovery.

1. Prepare your USB drive
  - a. start **tuxboot-windows-23.exe** and click **Pre Download**



- b. Select ISO file in the directory next to tuxboot-windows-23.exe.

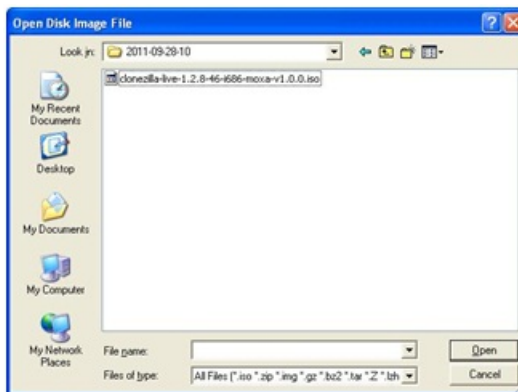

- c. Select **USB Drive** type and select **Drive** and then click **OK**.

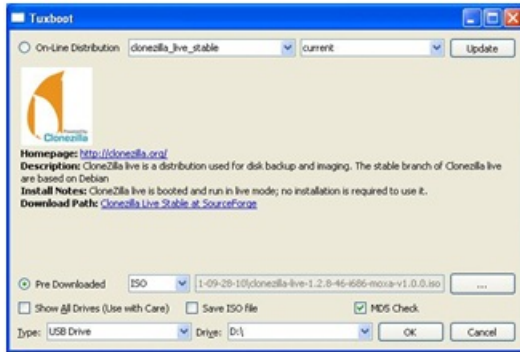

- d. The boot files will then copy to your USB drive

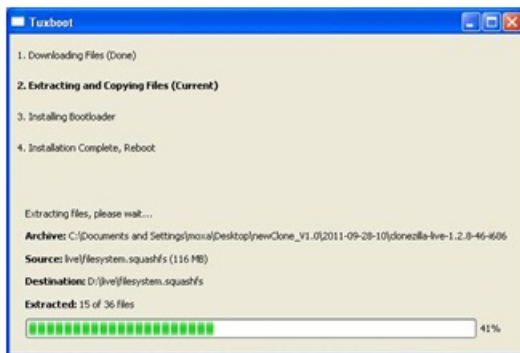

- e. Click **Exit** to close the program.

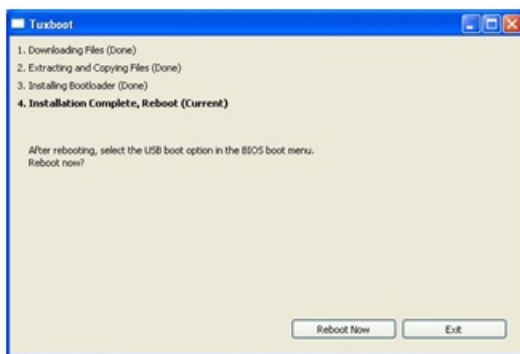

2. Change the BIOS setting to boot from USB disk

To let system boot from USB disk, we need to change the boot priority. Before the following steps, insert your USB disk into the embedded computer.

- a. Power on and press **F2** to enter bios setup menu.  
Select **Legacy** and press Enter.

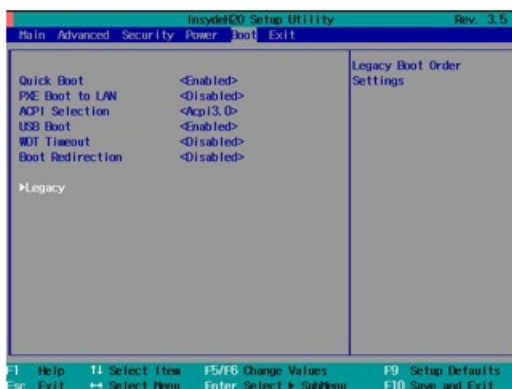



b. Select **Boot Type Order** and press **Enter**.

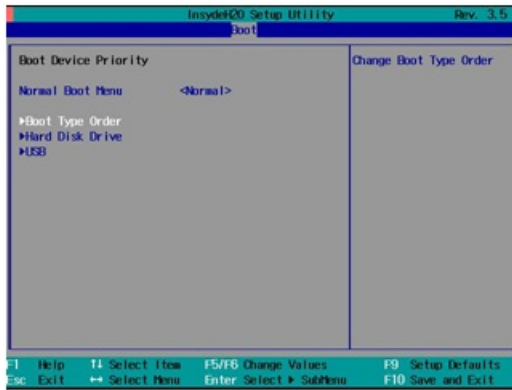

c. Press **+** to select USB as the first boot device type.  
Press **F10** and then press **Enter** to save and exit BIOS setup.

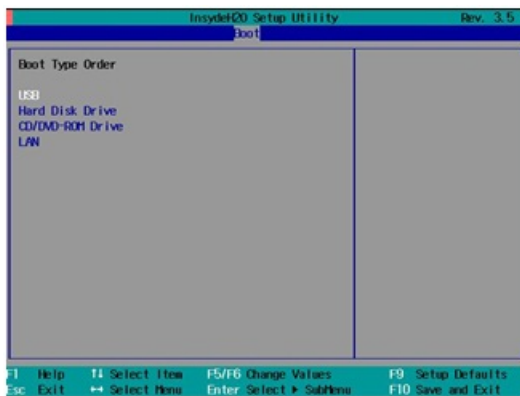

When the system boots up, it will read the recovery files from the USB disk. Follow the steps below:

1. Select **clonezilla live save disk**.

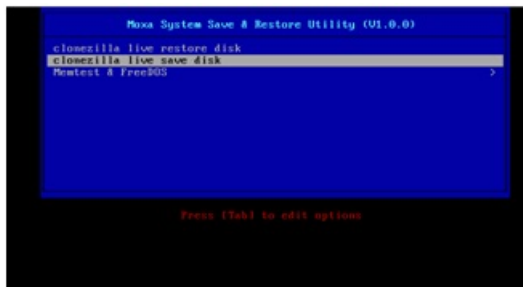

2. Wait for USB drive boot process.

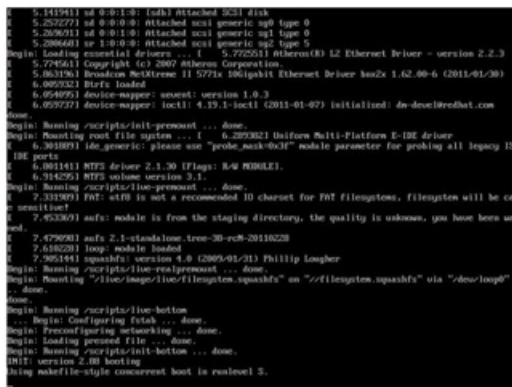

3. Enter **Y** to save the process.

```

123.257824] at4d.00: cmd 80:00:00:01:ff:ff:00:00:00:00:00:40 tag 0 ncp 40% in
123.257931]          res 4f:10:00:f8:ff:ff:00:00:00:00:00:40 Enask 0x481 [invalid argument] <F>
123.257980] at4d.00: status [ DRV_ERR ]
123.262095] at4d.00: error [ 10% ]
123.279246] at4d.00: configured for UDMA/133
123.279291] at4d: EH complete
123.279311] at4d.00: exception Enask cmd SACT 0x1 SErr 0x0 action 0x0
123.279252] at4d.00: irq_stat 0x40000008
123.279447] at4d.00: failed command: READ FROM QUEUED
123.300003] at4d.00: cmd 80:00:00:01:ff:ff:00:00:00:00:00:40 tag 0 ncp 40% in
123.300294]          res 4f:10:00:f8:ff:ff:00:00:00:00:00:40 Enask 0x481 [invalid argument] <F>
123.300395] at4d.00: status [ DRV_ERR ]
123.300403] at4d.00: error [ 10% ]
123.306801] at4d.00: configured for UDMA/133
123.307961] sd 3:0:0:0: [sd] Result: hostbyte=00,OK driverbyte=DRIVER_SENSE
123.309405] sd 3:0:0:0: [sd] Sense Key: Aborted Command [Current] [descriptor]
123.310574] Descriptor sense data with sense descriptors (in hex):
123.311791] 70 00 0a 0a 00 00 00 0c 0a 0a 0a 00 00 00 00
123.312691] 00 ff ff ff
123.313864] sd 3:0:0:0: [sd] Add. Sense: Recorded entity not found
123.314902] sd 3:0:0:0: [sd] CDB: Read(10) 28 00 00 ff ff 70 00 00 00
123.315091] end_request: I/O error, dev sdb, sector 150574
123.319901] Buffer I/O error on device sdb, logical block 190243
123.321229] at4d: EH complete
Done!
Selected device [sdal] found!
The selected device: sda1
Getting /dev/sda1 info...
=====
The following disk is to save the hard disk/partition(s) on this machine as an image:
=====
Machine: virtulabox
File: /12396_VBOX_HARDDISK__ata-VBOX_HARDDISK_Vbd29dc4ae-c1497276)
sda1 (206546_MiB)[In_VBOX_HARDDISK__ata-VBOX_HARDDISK_Vbd29dc4ae-c1497276)
=====
? /home/partimag/os_image?
Are you sure you want to continue? ? (y/n) _

```

4. Wait for the process to be complete.

```

No volume groups found.
Finished shutting down the Logical Volume Manager
Checking the integrity of partition table in the disk /dev/sda...
Reading the partition table for /dev/sda..._RETNW_L0
=====
Saving the MBR data for sda...
140 records in
140 records out
512 bytes (512 B) copied, 0.0075609 s, 67.7 kB/s
=====
Starting device /dev/sda1 as /home/partimag/os_image/sda1_00X...
/dev/sda1 filesystem: ntfs.
=====
Checking the disk space...
=====
Use partitions with #210 to save the image.
Image file will be sda11 with size limit 1000000 MB.
=====
If this action fails or hangs, check:
- Is the disk full?
=====
Partition v0.2.22 http://partclone.org
Starting to clone device /dev/sda1 to image (-)
Reading Super Block
Calculating BitMap...
Loaded: 0/10000, Remaining: 0/100000, Completed: 0.00%.
Total Time: 00:00:02, 100.00% completed!
File system: NTFS
Device size: 2.1 GB
Space in use: 1.7 GB
Free Space: 325.4 MB
Block size: 2048 byte
Used block: 849156
Elapsed: 00:00:00, Remaining: 00:00:28, Completed: 0.53%, Rate: 182.10MB/min.

```

5. Select **(0)** to power off the computer after restore process is complete.

```

Resizing the first 448 bytes of MBR data, i.e. bootable code area, for sda... done
=====
Now resize the partition for sda1
ntfsresize -f /dev/sda1
ntfsresize v0.0.9 (11bits sp000)
Device name: /dev/sda1
NTFS volume version: 3.1
Cluster size: 2048 bytes
Current volume size: 206451488 bytes (2065 MiB)
Current device size: 206451200 bytes (2065 MiB)
New volume size: 206451488 bytes (2065 MiB)
Nothing to do! NTFS volume size is already OK.
=====
The grub directory is NOT found. Maybe it does not exist (so other boot manager exists) or the file
system is not supported in the kernel. Skip running grub-install.
=====
Found NTFS boot partition among the restored partition(s): /dev/sda1
Read and sector no. of /dev/sda1 from 00: 64, 65.
The start sector of NTFS partition /dev/sda1: 63
Adjust filesystem geometry for the NTFS partition: /dev/sda1
Resizing: partclone.ntfs/ntfsboot -n 64 -l 63 -s 63 /dev/sda1
ntfs/ntfsboot version 0.9
Done!
=====
This program is not started by Clonezilla server, so skip notifying it the job is done.
Finished.
Now syncing - flush filesystem buffers...
"fsck-live-restore" is finished.
Now you can choose to:
(0) Poweroff
(1) Reboot
(2) Enter command line prompt
(3) Start over
(0)

```

6. The system will save into the **os\_image** folder of the USB disk **\home\partimag\**.

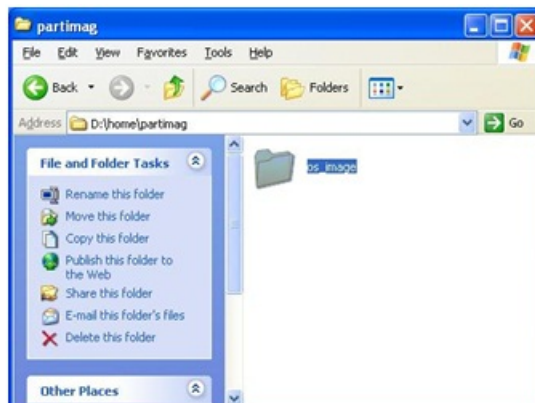

Follow the steps below to modify the USB disk to an auto-execute restore disk:

1. Copy **syslinux.cfg** from software CD path: **CD\utility\_tools\Smart Recovery** to **USB \syslinux** and overwrite it.

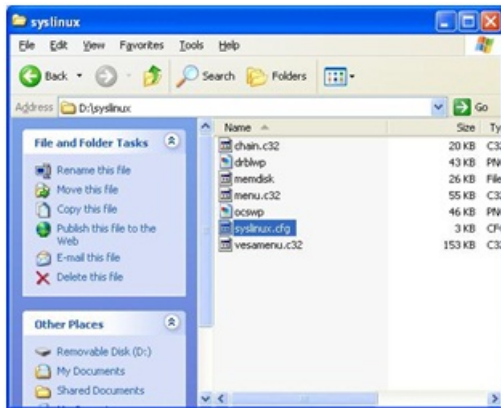

2. Copy **L\_BRFLAG** from the software CD path: **CD\utility\_tools \Smart Recovery** to **USB \live**

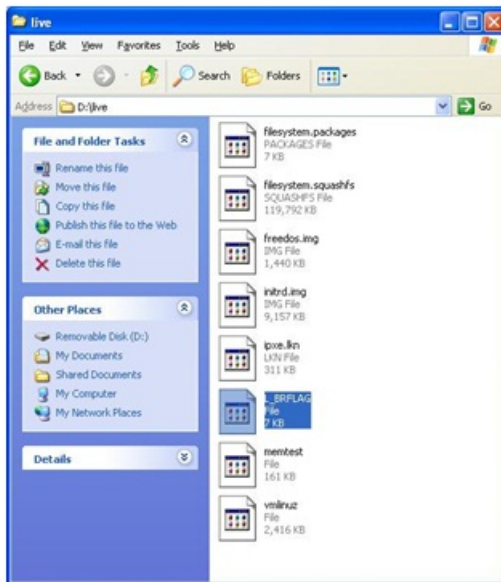

3. When the system has powered on, press **F2** to enter BIOS setup utility, and set WDT timeout to a suitable time length and set Boot Redirection to USB.

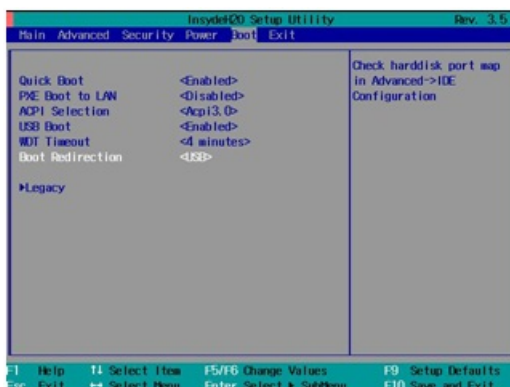

4. Users can normally use their OS and AP to meet the special function.



5. If the OS boot-up fails, system will display the blue screen. In this case, the watchdog timer will be counting down.



6. When the watchdog timer is up, the system will automatically restart and boot to the USB disk

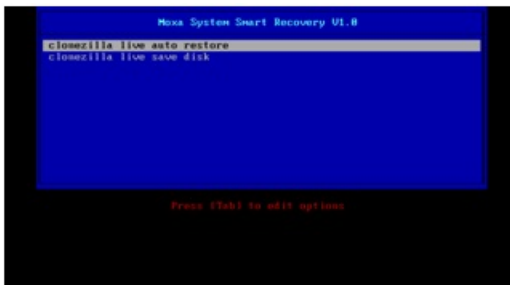

7. Full automatic setting will save **os\_image** folder to the damaged hard disk drive.

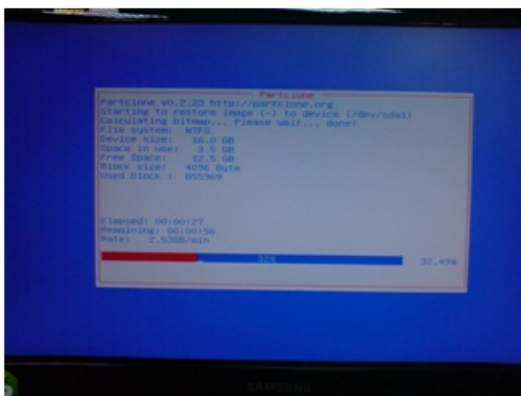

8. When the process is complete, the operating system will automatically restart and operate the normal boot to the hard disk.

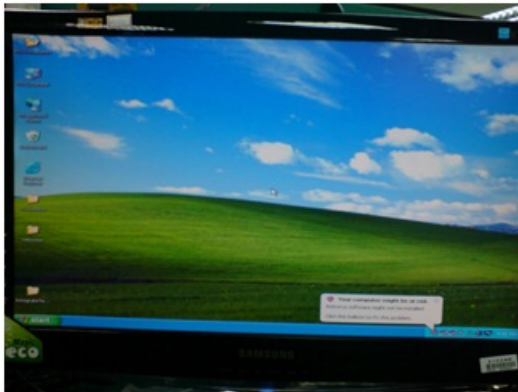
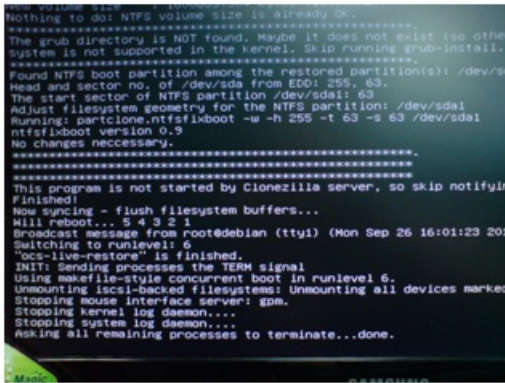

## Check the Following Items for Hard Disk Recovery

1. Format the hard disk to FAT32 as disk1.

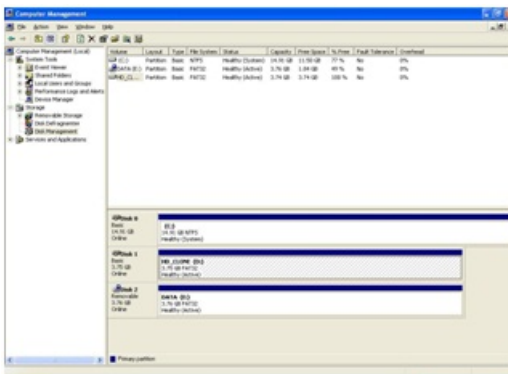

2. In Tuxboot, change the target drive to hard disk.

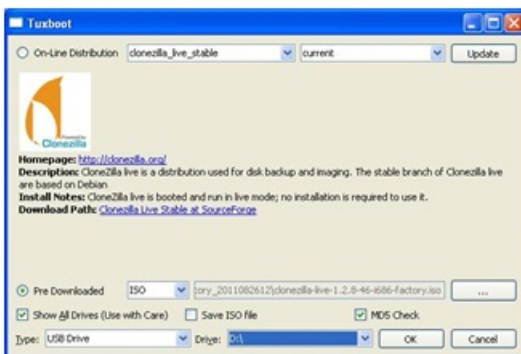

- Build the hard disk recovery image as USB. The boot redirection setting is different.
- When the system has powered on, press **F2** to enter BIOS setup utility, check the hard disk connection port, set WDT timeout to a suitable time length, and set Boot Redirection to the mapped port. (For example, set system OS disk as Port 0, spare rescue disk as port 2).

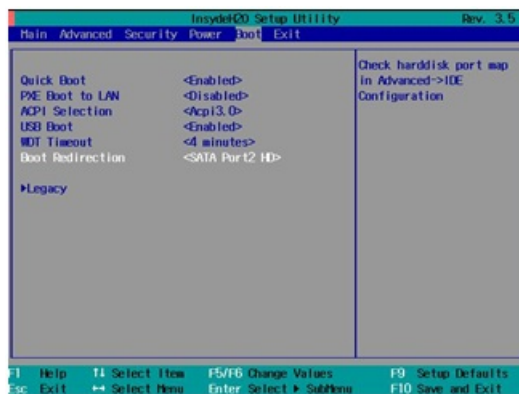
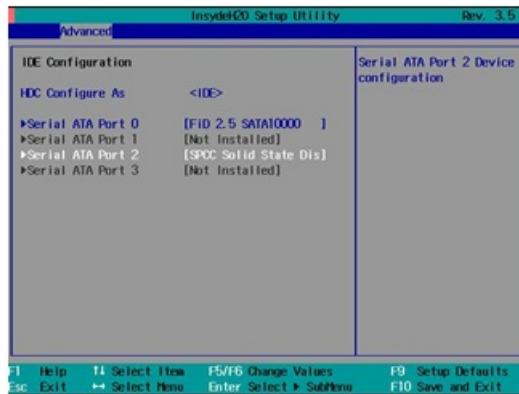

- When finished, the hard disk will perform in the role of the USB to recover the operating system.

## Check the Following Items for LAN Recovery

- Build the physical network link in remote server and the local device. See the following figure for details.

Connection in Local Network

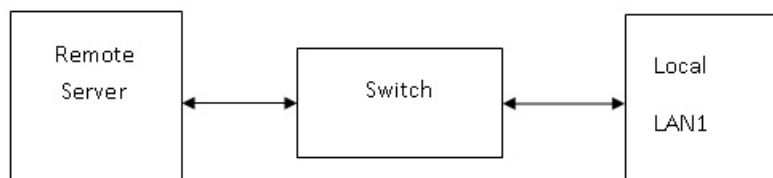

- Set PXE Boot to LAN Enabled, WDT Timeout as suitable time length and Boot Redirection to LAN.

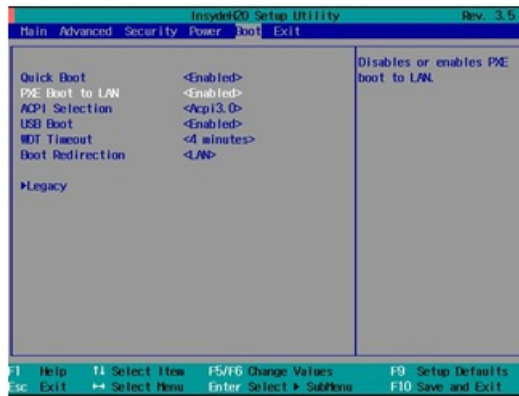

- Refer to the Clonezilla web site about remote server settings: <http://clonezilla.org/>
- When all settings have been done, it can work as an USB/SSD.