



## Intelligent Connectivity to Bring Sensor Data to the Cloud



**Serial Device  
Servers**



**Media  
Converters**



**Protocol  
Gateways**



**Remote I/Os**



**Industrial  
Computers**

# Things You Need to Know to Effectively Transfer Field Data to IT/OT Systems

The ultimate goal of most industrial automation applications is to obtain actionable insights from data sources for more precise decision making. To achieve this goal, businesses need to make their field data accessible to information technology (IT) or operational technology (OT) systems. Read on to learn how Moxa's easy, reliable, and secure connectivity solutions can facilitate your industrial applications.

Easy-to-use design

Easy

Industrial-grade reliability

Reliable

Built to secure field data

Secure

IT/OT Systems

Intelligent Connectivity Solutions



## What's Inside

### Technologies

- Ready-to-run OT-to-MQTT Gateways: Taking Your Data to the Cloud 3
- Want to Securely Collect Your Field Data? 5
- Expand Your IIoT Applications With Wireless Computers 7
- Configuration—Easy As 1-2-3 9

### Applications

- Four Key Factors When Choosing Devices for Your Cabinet 11
- Realize Your Full CNC Potential With Machine Data Collection 13
- Reliable and Scalable Ways to Read the Room 15

### Quick Product Selection

- Serial Device Servers 17
- Media Converters 19
- Protocol Gateways 20
- Remote I/Os 21
- Industrial Computers 22

# Ready-to-run OT-to-MQTT Gateways

## Taking Your Data to the Cloud

Did you know all your OT field data can be easily transmitted to the cloud? Find out how our ready-to-run connectivity solutions can help



**MQTT**

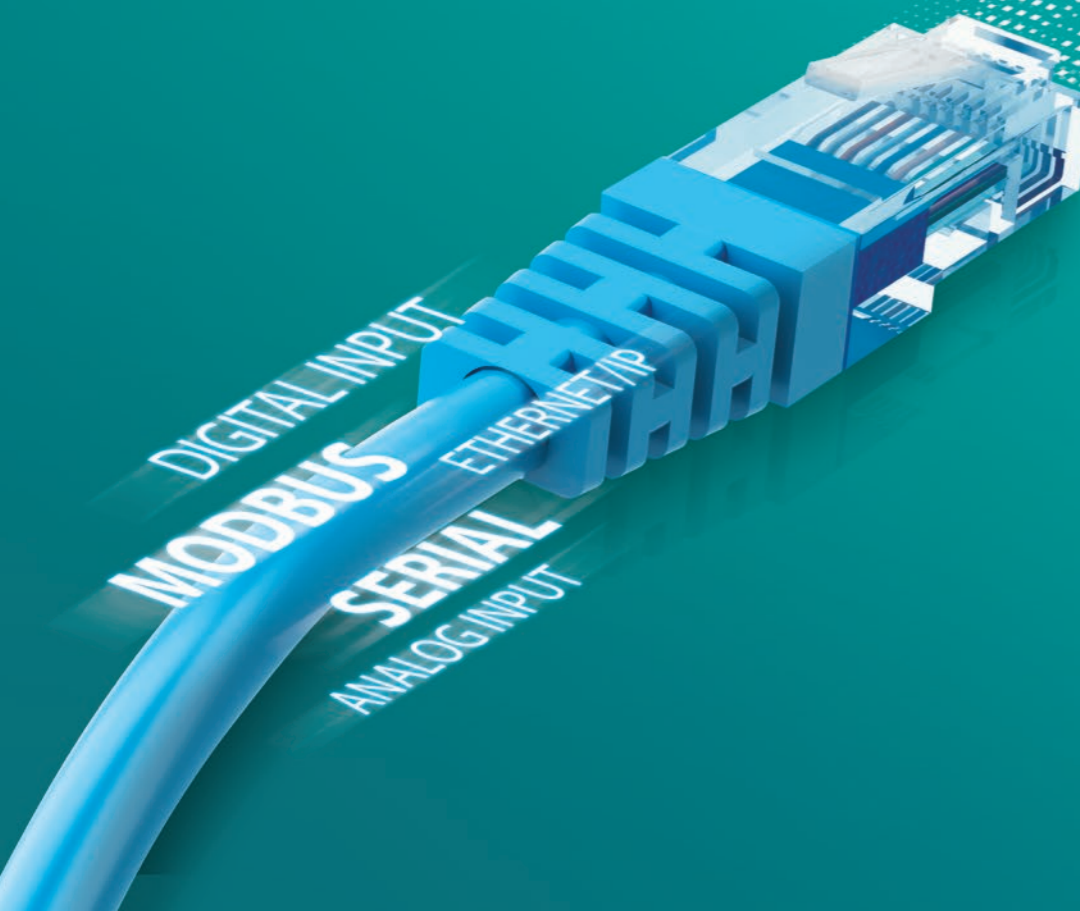

Having trouble making your operational technology (OT) field data accessible to information technology (IT) databases? Why spend extra time and resources on OT/IT integration when you could simply migrate all your field device data to the cloud? With Moxa's help, you can focus on developing your applications instead of the complex integration between OT and IT systems. Our ready-to-run edge connectivity solutions allow you to connect multiple **serial, Modbus, EtherNet/IP,** or **I/O** field devices to private clouds through **generic MQTT**, or to public clouds through **preintegrated Azure or Alibaba Cloud SDKs**. And with intuitive UIs, it only takes a few steps to complete the cloud selection, connection, and message tag settings between the field and cloud.

### Proprietary Serial Protocols

The NPort IA(W)5000A-I/O serial device server enables communication between MQTT and proprietary protocols to collect data from serial devices such as displays, barcode scanners, or printers.

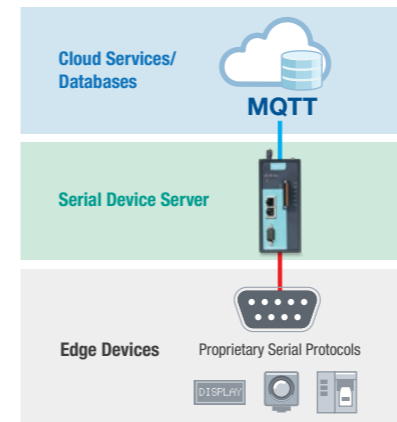

### Modbus or EtherNet/IP Protocols

The MGate 5105-MB-EIP gateway enables protocol conversion between Modbus or EtherNet/IP to MQTT for devices such as power meters, flow meters, RTUs, VFDs, and PLCs.

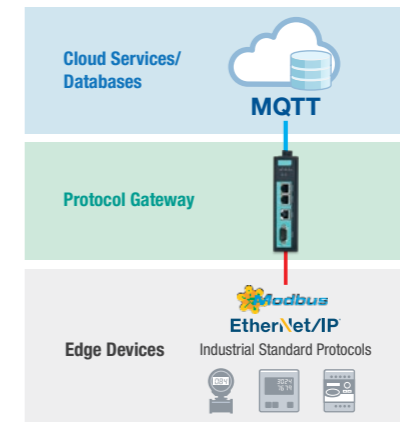

### Analog or Digital Interfaces

The ioThinX 4510 modular remote I/O lets you easily convert I/O signals to MQTT for devices such as sensors, signal lights, or tower lights.

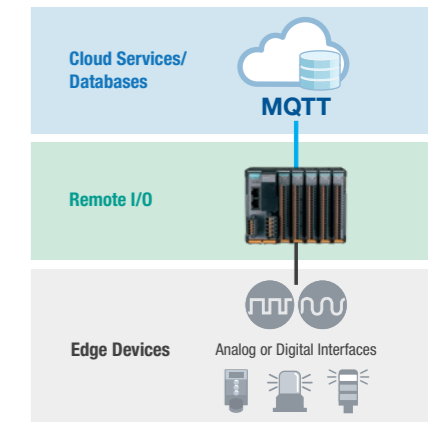

## We Recommend

To speed up your OT/IT integration project development, choose a Moxa edge connectivity product:



▶ **NPort IA(W)5000A-I/O**  
Ready-to-run serial-to-MQTT device server



▶ **MGate 5105-MB-EIP**  
Ready-to-run Modbus-to-MQTT protocol gateway



▶ **ioThinX 4510/4533**  
Ready-to-run I/O-to-MQTT modular remote I/O or controller

**Q:** *What if my application requires programmability or data preprocessing?*

**A:** For applications that require edge computing, Moxa's UC Series of edge computers is what you need. These Arm-based industrial computers support Wi-Fi/LTE connectivity and various communication interfaces. The optional ThingsPro® software enables easy Modbus data acquisition and supports cloud connectivity for Azure, AWS, and generic MQTT.



**UC-8100A-ME-T Series**  
Arm-based edge computer with optional ThingsPro® software for OT/IT connectivity

# Want to Securely Collect Your Field Data?

As cyberthreats pose an ever-present danger to industrial applications, Moxa's tips aim to help you mitigate vulnerabilities and risks

Is your industrial field data secure? This question arises because digitalization has accelerated the development of the industrial control system landscape over recent years. Originally, industrial control systems were physically isolated and almost immune to cyberattacks. However, a recent rise in the number and types of cyberattacks has spurred IT and OT teams into action to thwart these threats.

Commonly, **industrial control systems (ICS)** comprise three layers: **field, control, and management**. In recent years, collecting data from field layers has become more complex, as they perform more automation processes, meaning that the data at the edge is critical when it comes to control and monitoring. For this reason, it is very important to secure data at the edge of an ICS.



## The threats you need to look out for

Although your ICS may be physically isolated and not directly connected to the Internet, according to market research\*, ICS might encounter these common cyberthreats:

- 1 Sophisticated Cyberattacks**  
 Sophisticated cyberattacks, such as Stuxnet and Industroyer, targeting ICS networks since 2010.
- 2 Unintentional Cyberattacks**  
 You don't have to be a direct target to become a victim of a cyberattack. About 80% of industrial security incidents are unintentional.
- 3 Unsecure Connections**  
 Physically isolated ICS may still have unsecure connections, such as maintenance from third-party vendors.

\*Source: SANS Institute <https://www.sans.org/>

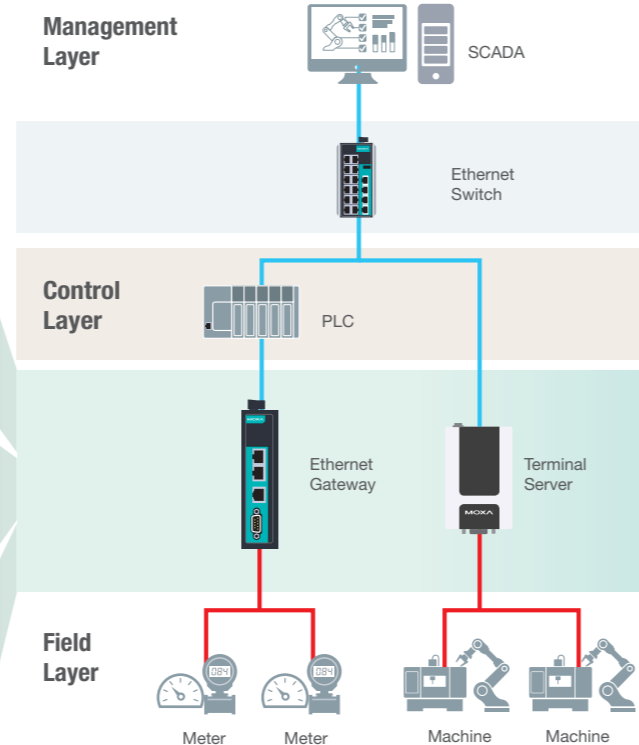

## Four tips to ensure your data is secure at the edge

Understanding industrial cybersecurity requirements will help companies mitigate risks to their systems. Following these four tips closely will help you to strengthen cybersecurity to lower the risks to your network:

- #1 User Authentication**  
 Verify user identification when logging in to a device
- #2 Network Access Control and Authentication**  
 Verify which devices are permitted to access the network and communicate with other devices
- #3 Data Integrity and Confidentiality**  
 Encrypt the connections to devices for configuration and management
- #4 Vulnerability Management**  
 A well-defined process for device suppliers to respond to reported vulnerabilities

## We Recommend

Moxa's expertise in industrial connectivity helps customers connect their devices securely via:

- Secured remote access with **HTTPS** and **SSH**
- Encrypted data transmission with **Secure Real COM** and **Secure TCP Server/Client** modes
- A proactive approach to **security vulnerabilities**



▶ **NPort 6100/6200 Series**  
 1/2-port RS-232/422/485 secure terminal servers

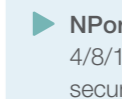

▶ **NPort 6400/6600 Series**  
 4/8/16/32-port RS-232/422/485 secure terminal servers



▶ **MGate 5000 Series**  
 Secure protocol gateways

To learn more about Moxa's complete industrial network security portfolio, visit: [www.moxa.com/security](http://www.moxa.com/security)



# Expand Your IIoT Applications With Wireless Computers

How to choose a reliable wireless computing solution to connect your devices and unleash new opportunities

Industrial computers with sufficient processing power and connectivity can be ideal IIoT gateways for data collection and transfers. However, in industries that rely on distributed data acquisition in remote areas, such as energy and utilities, wired infrastructure is often lacking or impractical. Although wireless computers provide an ideal solution for these applications, each scenario has different requirements for communication distance, transfer speed, bandwidth, power consumption, costs, and more. Choosing the best wireless computer for your application requires taking these factors and their inherent trade-offs into consideration.

## Five Considerations When Choosing a Wireless Computer

### 1 Data Volume

The data volume and content collected, processed, and transferred determine the bandwidth requirements and transmission frequency.

### 2 Network Infrastructure

Whether you choose to build your own network or use an existing one from a local carrier depends on the initial setup fees, data rates, and total cost of ownership.

### 3 Power Consumption

Choose a solution that best fits your power budget. For example, power-hungry Wi-Fi solutions are not well-suited for applications that rely on solar power or batteries.

### 4 Roaming

Carefully consider whether your field devices need mobile connectivity throughout the application site.

### 5 Redundancy and Reliability

To ensure reliability and availability, you may need dual SIM redundancy or more than one wireless technology on each device, such as Wi-Fi/LTE failover.

## Use Case #1 | Fleet Management



A logistics company required a solution to effectively manage an entire fleet of delivery trucks with video monitoring. The incredibly mobile nature of the application and the high bandwidth requirements for recording and transferring video data necessitated an **LTE Cat. 4** or **Wi-Fi** solution that could handle large data volumes and content.

Due to the high cost of real-time mobile data transmission over cellular networks, the logistics company chose to only upload recorded video files whenever a vehicle arrived at a dock. Moxa set up Wi-Fi access points at each dock and deployed the **Moxa V2201 edge computer**, equipped with **Wi-Fi** and **LTE** modules and **dynamic switch communication protocols**, to realize seamless data transmissions and effective cost savings.

## Use Case #2 | Smart Metering



An electric utility company requested a smart metering solution to accurately measure and bill electricity consumption for households in a medium-sized city. Due to the small data volume and low transmission frequency (about once per day), the company wanted a **low-power wide-area network (LPWAN)** solution instead of using a long-range (LoRa) or other unlicensed technology that would require the company to set up its own wireless infrastructure.

Since the local mobile carrier did not support an NB-IoT service yet, Moxa provided the company with the **UC-2116** industrial IoT gateway with **LTE Cat. M1** communication capability. Besides providing both **NB-IoT** and **LTE Cat. M1** for LPWAN capabilities, the UC-2116 also supports configuration modifications if the local carrier decides to support NB-IoT down the road, thereby reducing future cost.

## We Recommend

▶ **UC-2116**  
 Arm-based industrial computer with integrated **LTE Cat. M1/NB-IoT/GPS**, 2 serial ports, 2 LAN ports, 2 CAN ports, hazardous area certifications, and -40 to 75°C operating temperature

▶ **UC-3111**  
 Arm-based industrial computer with integrated **Wi-Fi** and **LTE Cat. 1**, 2 serial ports, 2 LAN ports, hazardous area certifications, and -30 to 70°C operating temperature

▶ **V2201**  
 Intel Atom®-based industrial computer with **Wi-Fi** and **LTE Cat. 4/6**, 2 serial ports, 4 LAN ports, 4 DIOs, and -40 to 70°C operating temperature



# Easy As 1-2-3

With hundreds of signals and protocols involved, connecting legacy devices can be complex and daunting. At Moxa, we make connectivity easy as 1-2-3

Do you need to connect equipment that communicates with serial (RS-232/422/485), Modbus, or I/O interfaces to an Ethernet network? Furthermore, have you ever timed how long it takes you to connect your devices to an Ethernet network? Imagine using easy-to-use serial device servers, Modbus gateways, and remote I/O products designed with utilities that enable you to:

- Activate a serial-to-Ethernet application **within a minute**
- Convert Modbus TCP and RTU/ASCII protocols **within a minute**
- Deploy tens or hundreds of devices with **one utility** for mass configuration

Read further to find out how Moxa's products and utilities make configuration easy for you.

## We Recommend

▶ The **NPort 5100A Series** consists of 1-port RS-232/422/485 serial device servers designed to make serial devices network-ready in an instant.



▶ The **MGate MB3180/MB3280/MB3480 Series** consists of standard serial-to-Ethernet Modbus gateways designed for easy integration of Modbus TCP and RTU/ASCII networks.



▶ The **ioLogik E1200 Series** Ethernet remote I/O is a data acquisition and control device that features MCC and MXconfig tools for easy mass deployment.



### 60-second Serial-to-Ethernet Activation

Moxa's NPort serial device server provides a simple installation wizard, which comes with an intuitive web interface.

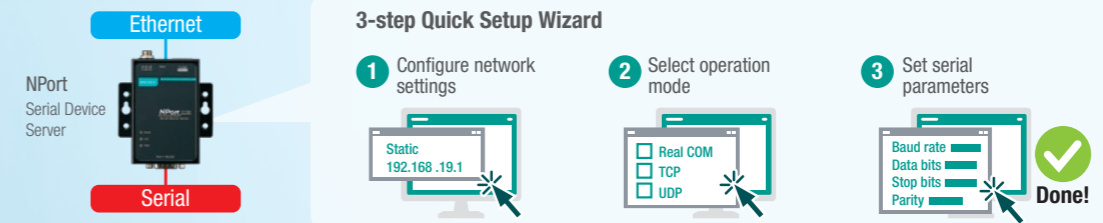

### 60-second Modbus TCP and RTU/ASCII Protocol Conversions

MGate Modbus gateways offer easier configuration with both Windows- and web-based utilities.

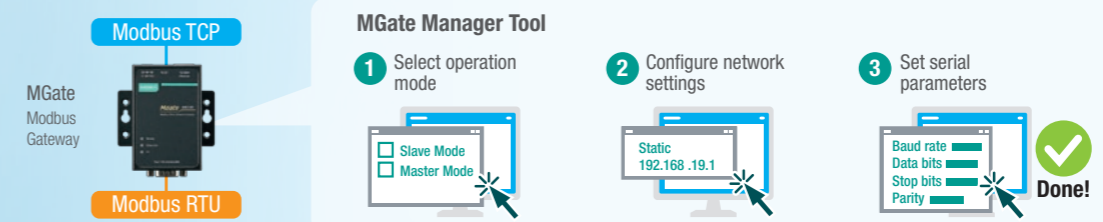

### One Utility for Mass Configuration

When you need to configure 10 or more devices, Moxa provides easy-to-use device management tools, such as Moxa CLI Configuration (MCC) and MXconfig, to help you efficiently perform mass configuration and maintenance tasks.

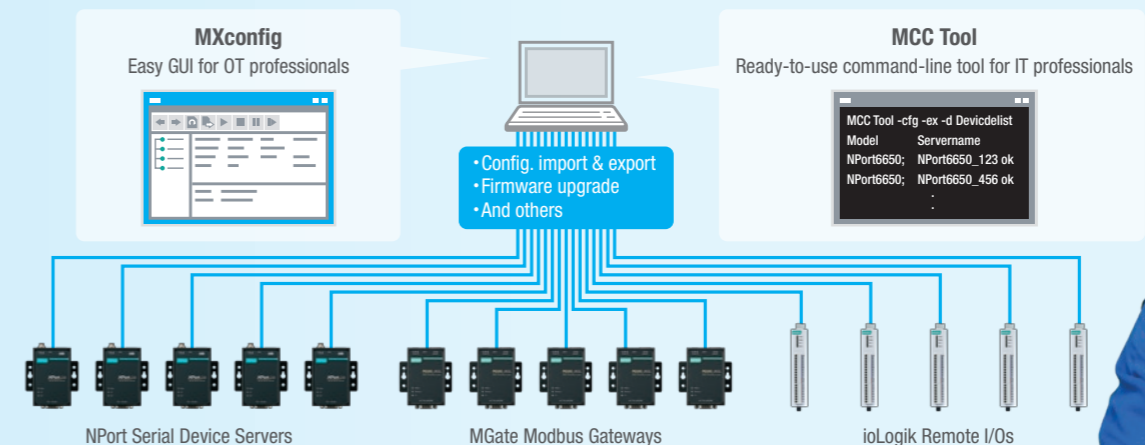

# Four Key Factors When Choosing Devices for Your Cabinet

When selecting a reliable device for an industrial application, several aspects need your consideration

Control cabinets play a vital role in monitoring and controlling industrial applications. To ensure system uptime, system integrators should consider several key factors when choosing devices for control cabinets that need to perform optimally and reliably for at least 10 to 15 years.

Drawing from over 30 years of experience in providing reliable products for industrial control cabinets, Moxa has identified the following four key considerations for choosing the best control cabinet devices for mission-critical applications.

## Withstand Harsh Environments

Control cabinets can be placed in a variety of environments, both indoors and outdoors. Depending on the specific project requirements, the devices used in the cabinet should feature a **wide operating temperature** range and specific certifications for use in hazardous locations, such as **C1D2 (US)** or **ATEX (EU)** certifications for oil and gas applications, or **DNV GL** certification for marine applications.

## Efficient Use of Space

Control cabinets are often added to an existing infrastructure or placed alongside machine tools used to enable remote monitoring and control. Consequently, the devices inside should be as compact as possible.

In addition, thermal management of electronic equipment also requires additional space and an adequate “keep-out-zone” to ensure safe and reliable operations. A good way to save space is to choose **integrated (all-in-one) devices**, such as a computer with a rich interface and wireless capabilities, or a device server with integrated I/Os or switches.

## Easy Hardware Installation and Maintenance

Control cabinets have a limited amount of physical space to accommodate a high volume of industrial control units, switching blocks, wiring, and other equipment.

Devices with **DIN-rail** mounting capabilities save installation time, reduce wiring connection costs and effort, provide easy component adjustments, arrangements, and maintenance, as well as support high-density deployment.

## Power Consumption and Redundancy

Due to different use cases, the control cabinet may be situated in places with limited power supply or even only rely on batteries. Consequently, it is important to choose devices with relatively **low power consumption**. At the same time, these devices must still have the operational reliability to ensure the efficiency of a functioning cabinet. Depending on the project specifications, the cabinet may even require a **redundant power supply** to guarantee power stability and uptime reliability.

## We Recommend



▶ **NPort IA5000A serial device servers**  
1/2 serial and 2 LAN ports, dual power inputs, -40 to 75°C operating temp., and C1D2/ATEX certifications

▶ **MGate MB3170/MB3270 Modbus TCP gateways**

1/2 serial and 2 LAN ports, dual power inputs, -40 to 75°C operating temp., and C1D2/ATEX certifications



▶ **ioLogik E1200 remote I/O**

Up to 4 AO, 8 AI, and 16 DIO, 2 LAN ports, -40 to 75°C operating temp., and C1D2/ATEX certifications



▶ **UC-8200 Arm-based industrial computers**

Dual 1 GHz CPU with 2 GB RAM, LTE and Wi-Fi support, -40 to 70°C operating temp., and C1D2/ATEX certifications



▶ **IMC-21A Ethernet-to-fiber media converters**

Multi-mode or single-mode, link fault pass-through (LFPT), and -40 to 75°C operating temp.



Case in Point

Realize Your Full CNC Potential

# With Machine Data Collection

Every second a machine in a factory is idling, offline, or shut down for maintenance, it translates into profit loss. Thus, the efficiency of machines matters to the bottom line of a CNC-automated factory. To improve productivity, factory managers need real-time information about the status of their CNC machines.

Usually, one of three operational goals will shape your **machine data collection (MDC)** strategy: enabling **DNC communication of CNCs** to achieve remote manageability of changes to recipes; **basic MDC** to measure overall equipment efficiency (OEE); and **advanced MDC** to perform predictive maintenance. Through numerous examples, Moxa has demonstrated its expertise in providing reliable, easy-to-deploy connectivity solutions to system integrators and machine builders to develop their machine data collection applications.

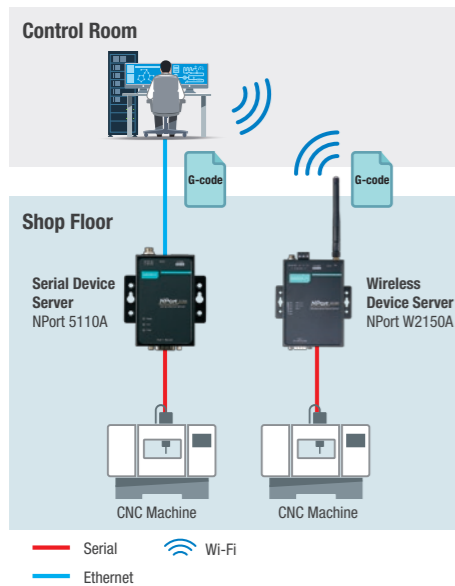

## Example 1 | DNC Communication

A metal parts manufacturer faced the challenge of getting its legacy CNC machines, **in the absence of Ethernet ports**, connected in order to upgrade its DNC communications in its production line. The solution required transferring files remotely and reliably.

### The Solution:

Moxa's NPort 5110A serial device servers and NPort W2150A wireless device servers were chosen for:

- **Wireless connections** that overcome the expense and difficulty of wiring on the shop floor
- **On-chip software flow control** for reliable data communications between memory-limited CNC machines and DNC
- Support of **Windows CE to Win 10** or **Linux 2.6 to 4.0** for integration with existing manufacturing systems

## Example 2 | Basic MDC for OEE

A software provider and system integrator developed MDC solutions for shop-floor managers to acquire their serial-based CNC machine status to **measure OEE**. To collect real-time machine status data through I/Os, the **MTConnect** protocol was used for integration with the MDC software.

### The Solution:

By choosing Moxa's NPort IA(W)5000A-I/O combo device servers, the system integrator was able to:

- Develop both MDC and DNC applications with **one single device**
- Minimize integration efforts with built-in **digital I/Os** for collecting stack light tower signals or cycle ON/OFF status, using **serial ports** for NC file transfers at the same time
- Reduce costs and save on space as the NPort IAW5000A-I/O wireless combo device servers provide seamless **wireless connections** on the shop floor

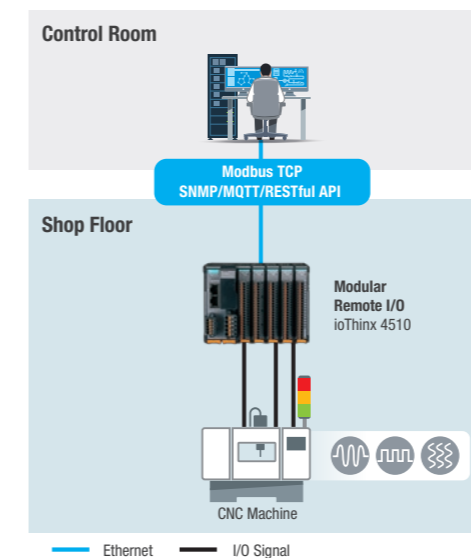
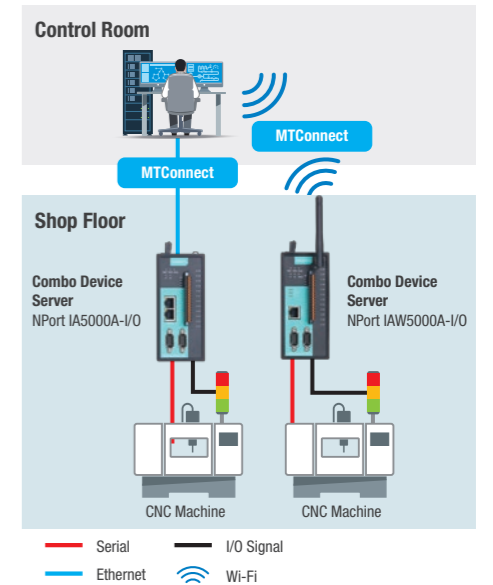

## Example 3 | Advance MDC for Predictive Maintenance

As machine health monitoring is vital for high-precision component manufacturers, a CNC machine maker provided a machine conditioning monitoring solution to its customers. The solution focuses on **advanced machine data collection for machinery health**, enabling predictive maintenance to prevent unexpected failures and increase yield rates.

### The Solution:

The machine maker partnered with Moxa and chose ioThinX 4510 advanced modular remote I/O to develop their machine condition monitoring solution. The ioThinX features:

- **AIO, DIO, RTD, and TC** interfaces for complex machine health data collection, such as spindle vibration, voltage, and current
- A **modular design** that enables flexible and easy installation for different machines
- Support for various IT/OT protocols, including **Modbus, SNMP, MQTT, and RESTful API**, making integration with different systems easy

## Tip: Choose an industrial-grade device for your MDC

To ensure your machine data collection is reliable, it is important to consider environmental noise and surge. Moxa's NPort serial device servers and I/Os are built with **power and signal surge protection up to 4 kV**. The NPort also provides **2 kV serial isolation** for protection on serial communications.





# Reliable and Scalable Ways to Read the Room

## Industrial-grade connectivity solutions for facility management

Facility management is crucial for ensuring environmental comfort and operational efficiency, such as power management and heating, ventilation, and air conditioning (HVAC) in data centers, hospitals, or factories. To ensure smooth facility management, reliable system connectivity is always essential. Another consideration is that when there is a need to add capacity, the facility management system should be able to scale up in the least amount of time. Choosing connectivity devices that support scalable deployment is key.

### Reliable Connectivity

To ensure high availability and data protection, Moxa's protocol gateways and remote I/Os feature:

- Industrial-grade design: high **EMC protection** up to level 3, **serial isolation** protection, and **-40 to 75°C** wide-temperature operability
- A **5-year warranty** for longer service support
- Enhanced cybersecurity functions, including **HTTPs** and **SNMPv3** for configuration and management

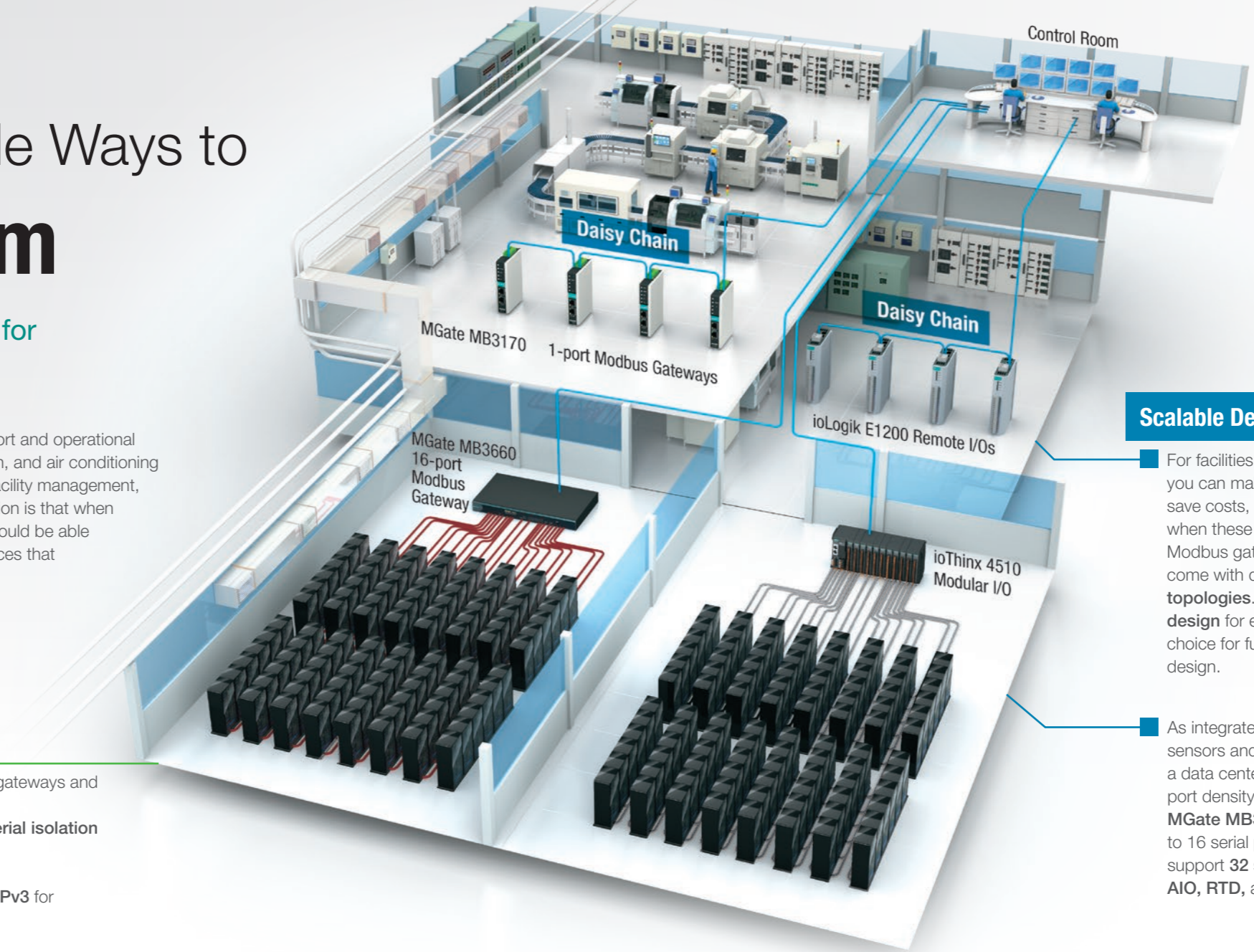

### Scalable Deployment

For facilities distributed over a large or different floor, you can make use of daisy-chain Ethernet topology to save costs, and it's easy to add additional connections when these facilities expand. Moxa's **MGate MB3170** Modbus gateways and **ioLogik E1200** remote I/Os come with dual Ethernet switches for **daisy-chain topologies**. They also feature a **compact-sized design** for easy installations, making them the ideal choice for future-proof facility management system design.

As integrated facilities contain a large number of sensors and meters in one single room, such as a data center, it's more efficient to choose high-port density connectivity solutions, such as Moxa's **MGate MB3660** Modbus gateways that support up to 16 serial ports or **ioThinx 4510** modular I/Os that support **32 slots** with different I/O types such as **DIO, AIO, RTD, and TC**.



### Example 1 | Environmental Monitoring for Data Centers

A facility management system integrator (SI) helped a data center owner build an IT-based environmental monitoring system. The system required **large-scale deployment** as it was looking towards expansion in the future.

#### The Solution:

The SI selected Moxa's **ioLogik E1200 remote I/O** to monitor light, humidity, and temperature sensors. The **SNMP** protocol support made it easy to integrate with the facility management software system. Featuring a built-in 2-port switch, it also supported **daisy-chain** network topology for flexible deployment.



### Example 2 | Power Monitoring for Data Centers

To develop its own billing system, a colocation service provider needed to connect thousands of serial-based Modbus RTU meters to its Modbus TCP network for power measurement, and the system had to support **redundancy** to ensure system reliability.

#### The Solution:

The service provider chose Moxa's **MGate MB3660 16-port Modbus gateways** for their **high-port density** and long MTBF. The gateways support dual Ethernet connections with dual IP address for **network redundancy** and dual AC power input for **power redundancy**.

# Choose a Serial Device Server

Bringing serial-based legacy devices into an Ethernet-based network can be easy. Moxa provides the best-in-class serial device servers for your industrial applications



### Your Trusted Serial Partner

We pledge to provide long-term availability of serial products and continuous driver support



### Intuitive User Interfaces

Intuitive user interfaces that simplify configuration and operation, making connectivity simple and easy



### Field-proven Quality

Field-proven quality that endures harsh environments for any industrial applications

## General and Industrial Device Servers



	Model	NPort 5100A/ 5200A/5400	NPort W2150A/ W2250A	NPort IA5100A/ IA5200A/IA5400A	NPort 5600	NPort 5600-DT/DTL
<b>Basic</b>	Serial Ports	1-4	1-2	1-4	8/16	8
	RS-232/422/485	•	•	•	•	•
	Ethernet	1	1	2	1	1
	Window/Linux Driver	•	•	•	•	•
<b>Security</b>	Login Authentication	Password Protection (length, character enforcement)	Password Protection (length, character enforcement)	Password Protection (length, character enforcement)	Password Protection (length, character enforcement)	Password Protection (length, character enforcement)
	Console Management	• HTTPS • Unused services can be disabled	• HTTPS • Unused services can be disabled	• HTTPS • Unused services can be disabled	• HTTPS • Unused services can be disabled	• HTTPS • Unused services can be disabled
	Network Access Control	Accessible IP List	Accessible IP List (For operation modes only)	Accessible IP List	Accessible IP List	Accessible IP List
<b>Reliability</b>	Industrial Certifications	-	-	C1D2, ATEX, IECEX	-	-
	Serial Isolation	•	-	•	•	•
	Wide Temperature	•	•	•	•	•

## Combo Device Servers



	Model	NPort IA5150A-6I/O	NPort IA5250A-6I/O	NPort IA5150A-12I/O	NPort IA5250A-12I/O	NPort IAW5150A-6I/O	NPort IAW5250A-6I/O	NPort IAW5150A-12I/O	NPort IAW5250A-12I/O	
<b>Ethernet</b>	10/100BaseTX (RJ45)	2	2	2	2	1	1	1	1	
	802.11 a/b/g/n Wireless Client	-	-	-	-	1	1	1	1	
	Cloud Capability	Azure IoT Hub Device, Alibaba IoT Platform Device, Publisher/Subscriber of MQTT								
<b>Serial</b>	RS-232/422/485	•	•	•	•	•	•	•	•	
	Surge Protection	4 kV								
	Serial Port	1	2	1	2	1	2	1	2	
<b>I/O</b>	Digital Input (DI or event counter)	4	4	8	8	4	4	8	8	
	Counter Frequency	20 Hz								
	Digital Output (DO or pulse output)	2	2	4	4	2	2	4	4	
	Protocol Supported	Modbus TCP, MTConnect (DI only), MQTT								
	Replay Output	Current carrying capacity of 2 A @ 30 VDC								

## Secure Serial Device Servers



	Model	NPort 6150	NPort 6250	NPort 6450	NPort 6610	NPort 6650
<b>Ethernet</b>	10/100BaseTX (RJ45)	1	1	1 (Up to 3 with Network Expansion Modules)	1 (Up to 3 with Network Expansion Modules)	1 (Up to 3 with Network Expansion Modules)
	100BaseFX (SC Connector)	-	1 Multi-mode or Single-mode (Model Specific)	(Up to 2 with Network Expansion Modules)	(Up to 2 with Network Expansion Modules)	(Up to 2 with Network Expansion Modules)
	IPv6 Support	•	•	•	•	•
<b>Serial</b>	Serial Standard	RS-232/422/485	RS-232/422/485	RS-232/422/485	RS-232	RS-232/422/485
	Serial Port	1	2	4	8/16/32	8/16/32
	Windows/Linux/Fixed TTY Drivers*	•	•	•	•	•
<b>Security</b>	Secure Operation Mode	Reverse SSH, Secure Pair Connection, Secure Real COM, Secure TCP Client, Secure TCP Server				
	Login Authentication	Default password, support of RADIUS, TACACS, TACACS+ authentication servers				
	Console Management	HTTPS (TLSv1.2 and above, with public certificate import), SSH, SNMPv3				
	Access Control	Account Management, Accessible IP List				
	Data Confidentiality	Serial Data Encryption, Encrypted Configuration File				

\* List of supported OS: Windows 10, Windows 8, Windows 7, Windows Vista, Windows XP, Windows 2000, Windows NT, Windows Server 2012, Windows Server 2008, Windows Server 2003, Windows CE 5/6, Windows XP Embedded, Linux 4.0 x86/x64, Linux 3.x x86/x64, Linux 2.6 x86/x64, Mac OSX, QNX 6, QNX 4



See the complete product line at [www.moxa.com/NPort](http://www.moxa.com/NPort)

# Choose a Media Converter

Whether it's media conversions between different serial interfaces or extension requirements for long-distance communication, you can find your multiple media converters here



### A Wide Selection

Multiple solutions to enable network extensions for both serial and Ethernet interfaces through fiber networks



### Industrial-grade Reliability

Designed to endure wide operating temperatures and high EMI immunity, backed by industrial certifications



### Flexible Deployment

The plug-and-play and modular design makes our media converters easy to deploy in any application



**Basic**  
Entry level, plastic housing



**Standard**  
General purpose, aluminum housing



**Gigabit**  
High-bandwidth data, video applications



**Advanced**  
Harsh environment, industrial certifications



**Gigabit**  
High-bandwidth data, video applications



**Basic**  
Entry level, plastic housing



**Standard**  
General purpose, aluminum housing



**Advanced**  
Harsh environments, industrial certifications

Model	Ethernet-to-fiber Converters					Serial-to-fiber Converters		
	IMC-21	IMC-21A	IMC-21GA	IMC-101	IMC-101G	TCF-90	TCF-142	ICF-1150
Interface A	10/100 BaseTX (RJ45)	10/100 BaseTX (RJ45)	10/100/1000 BaseTX (RJ45)	10/100 BaseTX (RJ45)	10/100/1000 BaseTX (RJ45)	RS-232	RS-232/422/485	RS-232/422/485
Interface B	100 BaseFX	100 BaseFX	100/1000 BaseSX/LX, 100/1000 BaseSFP slot	100 BaseFX	1000 BaseSFP slot	100 BaseFX	100 BaseFX	100 BaseFX
Fiber Ring	-	-	-	-	-	-	•	•
Port Power	-	-	-	-	-	•	-	-
Port Alarm	-	-	-	•	•	-	-	-
Power Alarm	-	-	-	•	•	-	-	-
Serial Isolation	-	-	-	-	-	-	-	2 kV (I model)
Serial Surge	-	-	-	-	-	-	-	1 kV
Industrial Certification	-	-	-	C1D2, ATEX, IECEx	C1D2, ATEX/ IECEx	-	-	C1D2, ATEX/ IECEx

# Choose a Protocol Gateway

The MGate fieldbus-to-Ethernet gateways connect your serial devices to an Ethernet network and convert between various industrial protocols, such as Modbus TCP and EtherNet/IP



### Faster Configuration

Provides a user-friendly web console and Windows utility with tutorial navigation for easy configuration



### Flexible Deployment

Comprehensive features allow legacy and new-build systems to coexist and scale up easily



### Easy Troubleshooting

Easy-to-use communication management and analysis for diagnostics and troubleshooting



Device A / Device B	Modbus RTU/ASCII Slave	Modbus RTU/ASCII Master	PROFIBUS Slave	PROFIBUS Master	Modbus TCP Server	Modbus TCP Client	Ethernet/IP Adapter	Ethernet/IP Scanner	PROFINET Controller	MQTT Broker
Modbus RTU/ASCII Slave	-	MB3000 <sup>1</sup>	-	4101/5111	5105	W5108/W5208 <sup>2</sup>	5105	5105	5103	5105
Modbus RTU/ASCII Master	MB3000 <sup>1</sup>	-	-	4101/5111	MB3000/W5108/W5208 <sup>2</sup>	5105	5105	5105	5103	-
PROFIBUS Slave	-	-	-	-	5101	5101	-	-	5102	-
PROFIBUS Master	4101/5111	4101/5111	-	-	5111	5111	-	5111	5111	-
Modbus TCP Server	5105	MB3000/W5108/W5208 <sup>2</sup>	5101	5111	-	-	5105	5105	5103	5105
Modbus TCP Client	MB3000/W5108/W5208 <sup>2</sup>	5105	5101	5111	-	-	5105	5105	5103	-
Ethernet/IP Adapter	5105	5105	-	-	5105	5105	-	-	-	5105
Ethernet/IP Scanner	5105	5105	-	5111	5105	5105	-	-	5103	-
PROFINET Controller	5103	5103	5102	5111	5103	5103	-	5103	-	-
MQTT Broker	5105	-	-	-	5105	-	5105	-	-	-

1. Applies only to the MGate MB3270/3660  
2. The MGate W5108/W5208 supports Wi-Fi 802.11a/b/g/n



Find out more at [www.moxa.com/MediaConverter](http://www.moxa.com/MediaConverter)



See the complete product line at [www.moxa.com/MGate](http://www.moxa.com/MGate)

# Choose a Remote I/O Product

Moxa provides a wide range of remote I/O products for industrial automation in factories, energy and transportation applications, and city infrastructure

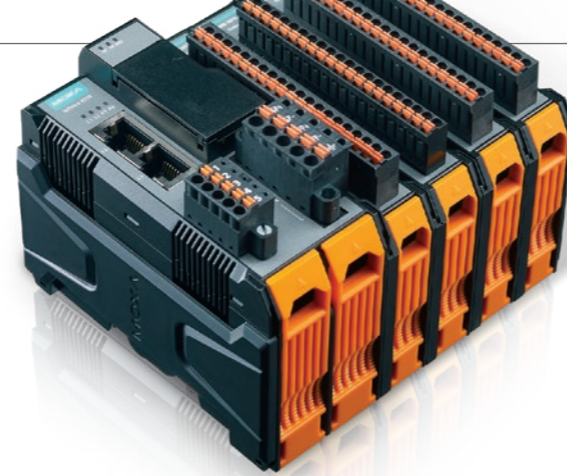

### Multiple Protocol Support

Supports various IT protocols and Modbus TCP protocol for easier deployment in different applications



### Easy Configuration and Deployment

Supports a built-in web interface for quick configuration and an utility for mass deployment



### Wide Selection

Compact standalone and modular I/O solutions for versatile data acquisition applications

## ioThinX 4510 Series and Modules



### Features

- Expansion Modules: 32
- IT Protocols: SNMPv1/v2c/v3, SNMPv1/v2c/v3 Trap, SNMPv2c/v3 Inform, RESTful API, MQTT
- OT Protocol: Modbus TCP Server (slave)
- Gateway Function: Modbus RTU Master to Modbus TCP, SNMP, RESTful API, MQTT
- Operating Temperature: Standard Models: -20 to 60°C; Wide Temp. Models: -40 to 75°C

Module	45MR-1600	45MR-1601	45MR-2600	45MR-2601	45MR-2606	45MR-2404	45MR-3800	45MR-3810	45MR-4420	45MR-6600	45MR-6810
Digital Inputs	16 (PNP)	16 (NPN)	-	-	8 (PNP)	-	-	-	-	-	-
Digital Outputs	-	-	16 (sink)	16 (source)	8 (source)	-	-	-	-	-	-
Relays	-	-	-	-	-	4 (N.O.)	-	-	-	-	-
Analog Inputs	-	-	-	-	-	-	8 (0/4-20 mA)	8 (-10/0-10 V)	-	-	-
Analog Outputs	-	-	-	-	-	-	-	-	4 (0/4-20 mA, 0-10 V)	-	-
RTDs	-	-	-	-	-	-	-	-	-	6	-
Thermocouples	-	-	-	-	-	-	-	-	-	-	8

## ioLogik E1200 Series



### Features

- 2-port Ethernet switch for daisy-chain topologies
- Saves time and wiring costs with peer-to-peer communications
- Class I Division 2, ATEX Zone 2 certification

Model	E1210	E1211	E1212	E1213	E1214	E1240	E1241	E1242	E1260	E1262
Inputs/Outputs	16 DI	16 DO	8 DI, 8 DIO	8 DI, 4 DO, 4 DIO	6 DI, 6 Relay	8 AI	4 AO	4 AI, 4 DI, 4 DIO	6 RTD	8 TC
Operating Temperature	Standard models: -10 to 60°C; Wide temp. models: -40 to 75°C									
Communication Protocols	Modbus TCP, EtherNet/IP, SNMPv1/v2c, RESTful API									

# Choose an Industrial Computer

Looking for an edge computer for data processing at remote sites? Moxa offers an extensive product range for edge computing in extreme conditions, such as solar or wind energy, water and wastewater, transportation, or oil and gas applications



### Rugged Design

Built to withstand harsh environments and certified as per C1D2, ATEX/IECEX Zone 2, and DNV GL



### Robust Connectivity

Supports LTE communication in wide operating temperature environment and approved by carriers



### Long-term Support

Backed by an industry-leading 3- or 5-year hardware warranty and 10-year support for Moxa Industrial Linux



Model	UC-2114/2116	UC-3101/3111	UC-5102/5112	UC-8112A-ME-T	UC-8220	MC-1121	V2201
CPU	Arm Cortex-A8 1 GHz	Arm Cortex-A8 1 GHz	Arm Cortex-A8 1 GHz	Arm Cortex-A8 1 GHz	Arm Cortex-A7 dual core, 1 GHz	Intel Atom® E3845 Quad-core 1.91 GHz	Intel Atom® E3845 Quad-core 1.91 GHz
Memory	512 MB	• 512 MB • 1 GB (US model)	512 MB	1 GB	2 GB	1 x DDR3 (up to 8 GB)	1 x DDR3 (up to 8 GB)
Storage Preinstalled	8 GB eMMC	• 4 GB eMMC • 8 GB (US model)	8 GB eMMC	8 GB eMMC	8 GB eMMC	1 x CFAST slot (up to 512 GB)	1 x mSATA slot (up to 512 GB)
Storage Slot	1 x Micro SD	0 or 1 x SD	1 x SD	1 x SD	1 x Micro SD	1 x SD	1 x SD
Interfaces	2 x Serial, 1 x GbE LAN, 1 x LAN, 2 x CAN	1 or 2 x Serial, 2 x LAN, 1 x USB 2.0	4 x Serial, 2 x LAN, 4 x DIs, 4 x DOs, 1 x USB 2.0 (2 x CAN on UC-5112)	2 x Serial, 2 x LAN, 1 x USB 2.0	4 x DIs, 4 x DOs, 1 x USB 2.0	2 x Serial, 4 x GbE LAN, 4 x DIs, 4 x DOs, 2 x USB 2.0, 1 x VGA, 1 x DisplayPort	2 x Serial, 2 x GbE LAN, 4 x DIs, 4 x DOs, 2 x USB 2.0, 1 x USB 3.0, 1 x HDMI
Wireless Connectivity	LTE Cat. M1/ NB-IoT with dual SIM slots	Wi-Fi & LTE Cat. 1 with dual SIM slots	Wi-Fi or LTE Cat. 1 <sup>1</sup> with dual SIM slots	Wi-Fi <sup>1</sup> or LTE Cat. 4	Wi-Fi <sup>1</sup> & LTE Cat. 4 with dual SIM slots	Wi-Fi or LTE Cat. 4 <sup>1</sup>	Wi-Fi & LTE Cat. 4 or 6 <sup>1</sup>
Carrier Approval	Verizon, AT&T	Verizon, AT&T	-	Verizon, AT&T	Verizon, AT&T	Verizon, AT&T	-
GPS Support	UC-2116 only	US models only	-	Yes <sup>2</sup>	Yes <sup>2</sup>	Yes <sup>2</sup>	Yes <sup>2</sup>
Industrial Certification	C1D2, ATEX / IECEX Zone 2	C1D2, ATEX / IECEX Zone 2	-	C1D2, ATEX / IECEX Zone 2	C1D2, ATEX / IECEX Zone 2	C1D2, ATEX / IECEX Zone 2, DNV GL	-
Operating Temperature	-40 to 75°C	• -40 to 70°C (US models) • -30 to 70°C (other models)	• -40 to 85°C • -40 to 70°C (with LTE)	• -40 to 85°C • -40 to 70°C (with LTE)	• -40 to 85°C • -40 to 70°C (with LTE)	-40 to 70°C	-40 to 70°C

1. Wireless modules must be purchased separately  
2. The GPS signal is integrated with LTE modules



See the complete product line at [www.moxa.com/RemotelO](http://www.moxa.com/RemotelO)



See the complete product line at [www.moxa.com/IPC](http://www.moxa.com/IPC)



## Expect More From Your **Remote I/O**

### ioThinX 4510 Series Modular Remote I/O

- Effortless installation and configuration
- Cost-effective system integration
- Connectivity security



[www.moxa.com/ioThinX](http://www.moxa.com/ioThinX)



## Your Trusted Partner in Automation

Moxa is a leading provider of edge connectivity, industrial computing, and network infrastructure solutions for enabling connectivity for the Industrial Internet of Things (IIoT). With over 30 years of industry experience, Moxa has connected more than 65 million devices worldwide and has a distribution and service network that reaches customers in more than 80 countries. Moxa delivers lasting business value by empowering industries with reliable networks and sincere service. Information about Moxa's solutions is available at [www.moxa.com](http://www.moxa.com).

### **Moxa Americas USA**

Toll Free: 1-888-MOXA-USA  
Tel: +1-714-528-6777  
Fax: +1-714-528-6778  
[usa@moxa.com](mailto:usa@moxa.com)

### **Brazil**

Tel: +55-11-95261-6545  
[brazil@moxa.com](mailto:brazil@moxa.com)

### **Moxa Europe Germany**

Tel: +49-89-37003-99-0  
Fax: +49-89-37003-99-99  
[europe@moxa.com](mailto:europe@moxa.com)

### **France**

Tel: +33-1-30-85-41-80  
Fax: +33-1-30-47-35-91  
[france@moxa.com](mailto:france@moxa.com)

### **UK**

Tel: +44-1844-355-601  
Fax: +44-1844-353-553  
[uk@moxa.com](mailto:uk@moxa.com)

### **Moxa Asia-Pacific and Taiwan Asia/Japan/Taiwan**

Tel: +886-2-8919-1230  
Fax: +886-2-8919-1231  
[asia@moxa.com](mailto:asia@moxa.com)  
[japan@moxa.com](mailto:japan@moxa.com)  
[taiwan@moxa.com](mailto:taiwan@moxa.com)

### **India**

Tel: +91-80-4172-9088  
Fax: +91-80-4132-1045  
[india@moxa.com](mailto:india@moxa.com)

### **Russia**

Tel: +7-495-287-0929  
Fax: +7-495-269-0929  
[russia@moxa.com](mailto:russia@moxa.com)

### **Korea**

Tel: +82-2-6268-4048  
Fax: +82-2-6268-4044  
[korea@moxa.com](mailto:korea@moxa.com)

### **Moxa China Shanghai**

Tel: +86-21-5258-9955  
Fax: +86-21-5258-5505  
[china@moxa.com](mailto:china@moxa.com)

### **Beijing**

Tel: +86-10-5976-6123/24/25/26  
Fax: +86-10-5976-6122  
[china@moxa.com](mailto:china@moxa.com)

### **Shenzhen**

Tel: +86-755-8368-4084/94  
Fax: +86-755-8368-4148  
[china@moxa.com](mailto:china@moxa.com)